



# ROLLER SPEED SKATING RULE BOOK

**2019**

(January, 2019)

*(All changes from the previous edition are marked in red and italics)*



An Official Publication of  
USA ROLLER SPORTS

Recognized by the United States Olympic Committee and the Federation International de Roller Sports (FIRS) as the National Governing Body for Competitive Roller Sports in the United States.

This book is fully protected by copyright and nothing that appears in it may be reprinted in any manner, either wholly or in part, for any use whatsoever, without special written permission of the copyright owner expressly permitting such reprint upon each and every occasion.

© 2019 USA Roller Sports  
4730 South Street, Lincoln, Nebraska 68506  
[www.usarollersports.org](http://www.usarollersports.org)

## SPEED RULES - COMPETITIONS

### **SR100 COMPETITIVE DIVISIONS**

SR100.1 Competition with the sport of roller skating as governed by USA Roller Sports (USARS) shall be divided into three federations requiring separate registration for each sport, which will also provide for divergent club representation for individual members enrolled in two or more Federations.

- A. Roller Figure Skating Federation
- B. Roller Speed Skating Federation
- C. Roller Hockey Federation
- D. Roller Derby Federation

SR100.2 A skater may apply for only one membership card per year. In each of the federations (figure, speed, hockey, or derby) under the control and direction of this Confederation. (Except as found in GR7.010.0 and SR 164.1)

SR100.3 The individual Federations shall have such authority over its own sport as shall be provided in the rules and regulations of the Board of Directors and may be organized as separate Technical Committees as provided by the Board of Directors.

SR100.4 Speed skating divisions are determined solely by the age of the skater as of January 1st of the competitive year. Regional and/or National Championship placements have no bearing on eligibility.

### **SR110 INDOOR INLINE SPEED SKATING COMPETITIVE DIVISIONS**

#### **SR111 Elite Indoor Inline Speed Skating Competitive Divisions**

SR111.1 Individual Elite Indoor Inline Divisions

There are separate events for boys and girls, men and women in Individual Divisions. At no time shall male and female compete against each other in an individual division race at a regional qualifying event or national championship.

Tiny Tot	5 & under	100m, 200m, 300m
Primary	6 & 7	200m, 300m, 400m
Juvenile	8 & 9	200m, 300m, 500m
Elementary	10 & 11	300m, 500m, 700m
Freshman	12 & 13	300m, 500m, 1000m
Sophomore	14 & 15	500m, 1000m, 1500m
Junior Women	16 & 17	500m, 1000m, 1500m
Junior Men	16 & 17	500m, 1000m, 2000m
Senior Women	18 & older	500m, 1000m, 2000m
Senior Men	18 & older	500m, 1500m, 3000m
Classic Women	25 & older	500m, 1000m, 1500m
Classic Men	25 & older	500m, 1000m, 2000m
Grand Classic Women	30 & older	500m, 1000m, 1500m
Grand Classic Men	30 & older	500m, 1000m, 2000m
Masters Women	35 & older	500m, 700m, 1000m
Masters Men	35 & older	500m, 1000m, 1500m
Grand Masters Women	40 & older	500m, 700m, 1000m

Grand Masters Men	40 & older	500m, 1000m, 1500m
Veterans	45 & older	500m, 700m, 1000m
Grand Veterans	50 & older	500m, 700m, 1000m
Esquire	55 & older	500m, 700m, 1000m
Grand Esquire	60 & older	500m, 700m, 1000m
Premier	65 & older	500m, 700m, 1000m

### **SR113 Elite Indoor Inline Two Person Relay Speed Skating Competitive Divisions**

#### **SR113.1 Two Person Inline Relays – Elite Program**

Two Person Relays shall not permit split club affiliation. Elite relays must consist of skaters who are all from the same club of registration, or all are in unattached status. Split club affiliation is not permitted.

Primary 2 Boy	7 & under	1200m
Primary 2 Girl	7 & under	1200m
Primary 2 Mix	7 & under	1200m
Elementary 2 Boy	8-11	2000m
Elementary 2 Girl	8-11	2000m
Elementary 2 Mix	8-11	2000m
Sophomore 2 Man	12-15	3000m
Sophomore 2 Woman	12-15	2000m
Sophomore 2 Mix	12-15	3000m
Senior 2 Man	16 & older	5000m
Senior 2 Woman	16 & older	3000m
Senior 2 Mix	16 & older	3000m
Classic 2 Man	25 & older	3000m
Classic 2 Woman	25 & older	2000m
Classic 2 Mix	25 & older	2000m
Master 2 Man	35 & older	2000m
Master 2 Woman	35 & older	2000m
Master 2 Mix	35 & older	2000m
Veteran 2 Man	45 & older	2000m
Veteran 2 Woman	45 & older	2000m
Veteran 2 Mix	45 & older	2000m
Esquire 2 Man	55 & older	2000m
Esquire 2 Woman	55 & older	2000m
Esquire 2 Mix	55 & older	2000m

### **SR114 Elite Indoor Four Person Relay Speed Skating Competitive Divisions**

#### **SR114.1 4-Person Relays – Elite Program**

Relays shall not permit split club affiliation. Elite relays must consist of skaters who are all from the same club of registration, or all who are in unattached status.

Juvenile 4 Boy	9 & under	1200m
Juvenile 4 Girl	9 & under	1200m
Juvenile 4 Mix	9 & under	1200m
Freshman 4 Boy	10-13	2000m
Freshman 4 Girl	10-13	2000m
Freshman 4 Mix	10-13	2000m

Senior 4 Man	14 & older	4000m
Senior 4 Woman	14 & older	4000m
Senior 4 Mix	14 & older	4000m
Master 4 Man	35 & older	2000m
Master 4 Woman	35 & older	2000m
Master 4 Mix	35 & older	2000m

**SR115 Elite Indoor Three Person Relay Speed Skating Competitive Divisions**

**SR115.1 3-Person Relays – Elite Program**

Relays shall not permit split club affiliation. Elite relays must consist of skaters who are all from the same club of registration, or all who are in unattached status.

Juvenile 3 Person	9 & under	1200m
Freshman 3 Boy	10-13	2100m
Freshman 3 Girl	10-13	2100m
Freshman 3 Mix	10-13	2100m
Senior 3 Man	14 & older	4500m
Senior 3 Woman	14 & older	3000m
Senior 3 Mix	14 & older	3000m
Master 3 Man	25 & older	3000m
Master 3 Woman	25 & older	3000m
Master 3 Mix	25 & older	3000m
<i>Veteran 3 Man</i>	<i>45 &amp; older</i>	<i>2100m</i>
<i>Veteran 3 Woman</i>	<i>45 &amp; older</i>	<i>2100m</i>
<i>Veteran 3 Mix</i>	<i>45 &amp; older</i>	<i>2100m</i>

**SR120 OUTDOOR NATIONAL CHAMPIONSHIPS**

SR120.1 Qualifications for National Banked Track Championships: For track safety, successful participation in approved USARS Banked Track Clinics is required to qualify for entry in the open USARS National Banked Track Championships, provided the candidate meets or exceeds the following qualifying times:

Juvenile Female	300m	00:41:00
	2,000m	04:50:00
Juvenile Male	300m	00:41:00
	2,000m	04:50:00
Freshman Female	300m	00:37:00
	5,000m	11:45:00
Freshman Male	300m	00:37:00
	5,000m	11:45:00
Junior World Class Female	300m	00:36:00
	10k	23:20:00
Junior World Class Male	300m	00:34:00
	10k	21:00:00
Senior World Class Female	300m	00:36:00
	10k	23:20:00
Senior World Class Male	300m	00:34:00
	10k	21:00:00

Masters (25-34 & 35-44) Female	300m	00:38:00
	2,000m	04:40:00
Masters (25-34 & 35-44) Male	300m	00:36:00
	5000m	11:10:00
Masters (45-54 & 55 & older) Female	300m	00:39:00
	2000m	04:40:00
Masters (45-54 & 55 & older) Male	300m	00:37:00
	5,000m	11:40:00

NOTE: USARS has adopted the CIC rules for the Outdoor National Championships. Rules and distances listed below may be different from those listed by the CIC. Consult the CIC Rule Book for the most recent changes which are updated each year. Outdoor races, other than Outdoor Nationals, are not bound with the distances and type of races shown here. The meet host has the option to create distances to their own liking.

### SR121 Track

Competitors may not skate more than one division at the same National Outdoor competition.

Juvenile Girls and Boys	age 9-10	300m time trial 500m sprint 2000m points
Freshman Girls and Boys	age 11-13	300m time trial 500m sprint 5000m points
Junior Women and Men	age 14-18	300m time trial 500m sprint 1000m 10,000m points elim.
Senior Women and Men	age 14 and older	300m time trial 500m sprint 1000m 10,000m points elim
Master Women and Men (25-34, 35-44, 45-54, 55 & older) (4 divisions, 4 distances each)		300m time trial 500m 1500m *2000m points (women) *5000m points (men)

\*Events will skate as two groups (25-34, 35-44 and 45-54, 55 & older) and be awarded by age. Points are awarded every lap with 2 points to first and 1 point to second. At the end of the race on the last lap, points are awarded with 3 points to first, 2 points to second, and 1 point to third for finishers in each age group. The Masters Points races will be placed by points earned during the race, contestants not earning points during the race will be placed by their order of finish. Skaters may be distanced at the discretion of the referee. Distanced skaters will be placed in reverse order of their elimination. Skaters quitting or unable to finish the event will not be placed. Any age group with 12 or more contestants will be run as a separate event.

### Team USA Qualifying Events

Junior World Class Women and Men	age 14-18	300m time trial 500m sprint 1000m
----------------------------------	-----------	---

Senior World Class Women and Men	age 14 and older	10,000m points elimination 15,000m elimination 300m time trial 500m sprint 1000m 10,000m points elimination 15,000m elimination
----------------------------------	------------------	---

**SR122 Road – Open Event**

Competitors may not skate more than one division at the same National Outdoor competition. Participants in National Road Championships are not required to undergo qualifying clinics or meet speed time minimum standards as a precondition for entry.

Juvenile Girls and Boys	10 and under	200m time trial 500m sprint 2000m points
Freshman Girls and Boys	age 11-13	200m time trial 500m sprint 5000m points
Junior Women and Men	age 14-18	200m time trial 500m sprint 15,000m elimination
Senior Women and Men	14 and older	200m time trial 500m sprint 15,000m elimination
Master Women and Men (25-34, 35-44, 45-54, 55 & older) (4 divisions, 4 distances each)		200m time trial 500m 1500m *2000m points (women) *5000m points (men)

\*Events will skate as two groups (25-34, 35-44 and 45-54, 55 & older) and be awarded by age. Points are awarded every lap with 2 points to first and 1 point to second. At the end of the race on the last lap, points are awarded with 3 points to first, 2 points to second, and 1 point to third for finishers in each age group. The Masters Points races will be placed by points earned during the race, contestants not earning points during the race will be placed by their order of finish. Skaters may be distanced at the discretion of the referee. Distanced skaters will be placed in reverse order of their elimination. Skaters quitting or unable to finish the event will not be placed. Any age group with 12 or more contestants will be run as a separate event.

Team USA Qualifying Event

Junior Women and Men	age 14-18	200m time trial 500m sprint 10,000m points (sprints every lap) 20,000m elimination
World Class Women and Men	age 14 and older	200m time trial 500m sprint 10,000m points (sprints every lap) 20,000m elimination

**SR130 INDOOR QUAD SPEED SKATING COMPETITIVE DIVISIONS**

**SR131 Elite Indoor Quad Speed Skating Competitive Divisions**

### SR131.1 Quad Individual Divisions - Elite Program

At no time shall male and female compete against each other in an individual division race at a regional qualifying event or national championship.

Primary	7 & under	200m, 300m, 400m
Elementary	8-10	300m, 500m, 700m
Freshman	11-13	300m, 500m, 1000m
Junior	14-16	500m, 1000m, 1500m
Senior Men	17 & older	1000m, 1500m, 3000m
Senior Women	17 & older	500m, 1000m, 2000m
Classic Men	25 & older	500m, 1000m, 2000m
Classic Women	25 & older	500m, 1000m, 2000m
Masters	35 & older	300m, 700m, 1000m
Veterans	45 & older	300m, 500m, 700m
Esquire	55 & older	300m, 500m, 700m
Premier	65 & older	300m, 500m, 1000m

### SR132 Elite Indoor Quad Two Person Relay Speed Skating Competitive Divisions

#### SR132.1 Quad 2-Person Relays – Elite Program

Juvenile 2 Boy	10 & under	1200m
Juvenile 2 Girl	10 & under	1200m
Juvenile 2 Mix	10 & under	1200m
Freshman 2 Boy	11-13	2000m
Freshman 2 Girl	11-13	2000m
Freshman 2 Mix	11-13	2000m
Senior 2 Man	14 & older	5000m
Senior 2 Woman	14 & older	3000m
Senior 2 Mix	14 & older	3000m
Classic 2 Man	25 & older	2000m
Classic 2 Women	25 & older	2000m
Classic 2 Mix	25 & older	2000m
Master 2 Man	35 & older	2000m
Master 2 Woman	35 & older	2000m
Master 2 Mix	35 & older	2000m
Veteran 2 Man	45 & older	2000m
Veteran 2 Woman	45 & older	2000m
Veteran 2 Mix	45 & older	2000m
<i>Esquire 2 Man</i>	<i>55 &amp; older</i>	<i>2000m</i>
<i>Esquire 2 Woman</i>	<i>55 &amp; older</i>	<i>2000m</i>
<i>Esquire 2 Mix</i>	<i>55 &amp; older</i>	<i>2000m</i>

#### *SR133 Quad 3-Person Relays – Elite Program*

<i>Freshman 3 Man</i>	<i>13 &amp; under</i>	<i>1200m</i>
<i>Freshman 3 Woman</i>	<i>13 &amp; under</i>	<i>1200m</i>
<i>Senior 3 Man</i>	<i>14 &amp; older</i>	<i>3000m</i>
<i>Senior 3 Woman</i>	<i>14 &amp; older</i>	<i>3000m</i>

*Master 3 Man*                      *35 & older*                      *1500m*  
*Master 3 Woman*                      *35 & older*                      *1500m*

**SR134**                      **Qualifying Age Groups**

Speed skaters who qualify through age may skate the Senior, Classic or Masters division as they choose, but not more than one division in the same season of qualifying championships. Those skating Classic two-person relays may also choose to enter any Senior four-person relays or a Senior two-person relay of a different type. EXAMPLE: Skaters may not enter Classic two-mixed and Senior two-mixed, but may enter Senior two-man or two-woman and Classic two-mixed.

**SR140 RELAY SEQUENCES FOR SKATING PARTICIPATION**

**SR141 Four Person Relays**

There are seven divisions of four person relays. Either quads or inline skates may be used within the same race (not separate divisions). Divisions/distances are as follows:

- A.                      Juvenile Relays
  1.                      Four Boy-four boys skating a total distance of 1200m. Each boy skates a continuous 300m before relaying with another.
  2.                      Four Girl-four girls skating a total distance of 1200m. Each girl skates a continuous 300m before relaying with another.
  3.                      Four Mixed-two boys and two girls skating a total distance of 1200m. Each member skates a continuous 300m before relaying with another; girls start. Both girls skate their 300m before the boys skate their 300m.
  
- B.                      Freshman Relays
  1.                      Four Boy-four boys skating a total distance of 2000m. Each boy skates a continuous 500m before relaying with another.
  2.                      Four Girl-four girls skating a total distance of 2000m. Each girl skates a continuous 500m before relaying with another.
  3.                      Four Mixed-two boys and two girls skating a total distance of 2000m. Each member skates a continuous 500m before relaying with another; girls start. Both girls skate their 500m before the boys skate their 500m.
  
- C.                      Senior Relays
  1.                      Four Man-four men skating a total distance of 4000m. Each man skates a continuous 500m before relaying with another. Each person must skate their first 500m before anyone skates their second 500m.
  2.                      Four Woman-four women skating a total distance of 4000m. Each woman skates a continuous 500m before relaying with another. Each person must skate their first 500m before anyone skates their second 500m.
  3.                      Four Mixed-two men and two women skating a total distance of 4000m. Each member skates a continuous 500m before relaying with another; women start. Both women skate their first 500m before the men skate their first 500m, and both women skate their second 500m before the men skate their second 500m.
  
- D.                      Master Relays
  1.                      Four Man-four men skating a total distance of 2000m. Each man skates a continuous 500m before relaying with another.
  2.                      Four Woman-four women skating a total distance of 2000m. Each woman skates a continuous 500m before relaying with another.
  3.                      Four Mixed-two men and two women skating a total distance of 2000m. Each member skates a continuous 500m before relaying with another; women start. Both women skate their 500m before the men skate their 500m



## **SR142 Inline Two Person Relays**

Separate elite divisions are established for two-person relays for both quad and inline skates. These are as follows:

- A. Primary Relays
  - 1. Two Boy-two boys skating a total distance of 1200m. Relays must be made every two laps.
  - 2. Two Girl-two girls skating a total distance of 1200m. Relays must be made every two laps.
  - 3. Two Mixed-one boy and one girl skating a total distance of 1200m. Relays must be made every two laps; girl starts.
- B. Elementary Relays
  - 1. Two Boy-two boys skating a total distance of 2000m. Relays must be made every two laps.
  - 2. Two Girl-two girls skating a total distance of 2000m. Relays must be made every two laps.
  - 3. Two Mixed-one boy and one girl skating a total distance of 2000m. Relays must be made every two laps; girl starts
- C. Sophomore Relays
  - 1. Two Man-two men skating a total distance of 3000m. Each man must skate not less than one lap nor more than five laps before each relay, with the last man to skate a minimum of one lap.
  - 2. Two Woman-two women skating a total distance of 2000m. Each woman must skate not less than one lap nor more than five laps before each relay, with the last woman to skate a minimum of one lap.
  - 3. Two Mixed-one man and one woman skating a total distance of 3000m. Man must finish, relays must be made every two laps.
- D. Senior Relays
  - 1. Two Man-two men skating a total distance of 5000m. Each man must skate not less than one lap nor more than five laps before each relay, with the last man to skate a minimum of one lap.
  - 2. Two Woman-two women skating a total distance of 3000m. Each woman must skate not less than one lap nor more than five laps before each relay, with the last woman to skate a minimum of one lap.
  - 3. Two Mixed-one man and one woman skating a total distance of 3000m. Man must finish, relays must be made every two laps.
- E. Classic Relays
  - 1. Two Man-two men skating a total distance of 3000m. Each man must skate not less than one lap nor more than five laps before each relay, with the last man to skate a minimum of one lap.
  - 2. Two Woman-two women skating a total distance of 2000m. Each woman must skate not less than one lap nor more than five laps before each relay, with the last woman to skate a minimum of one lap.
  - 3. Two Mixed-one man and one woman skating a total distance of 2000m. Woman must start and relays must be made every two laps.
- F. Masters Relays
  - 1. Two Man-two men skating a total distance of 2000m. Relays must be made every two laps.
  - 2. Two Man-two men skating a total distance of 2000m. Relays must be made every two laps.
  - 3. Two Mixed-one man and one woman skating a total distance of 2000m. Women must start and relays must be made every two laps.
- G. Veterans Relays
  - 1. Two Man-two men skating a total distance of 2000m. Relays must be made every two laps.
  - 2. Two Woman-two women skating a total distance of 2000m. Relays must be made every two laps.
  - 3. Two Mixed-one man and one woman skating a total distance of 2000m. Woman must start and relays must be made every two laps
- H. Esquire Relays
  - 1. Two Man-two men skating a total distance of 2000m. Relays must be made every two laps.

2. Two Woman-two women skating a total distance of 2000m. Relays must be made every two laps.
3. Two Mixed-one man and one woman skating a total distance of 2000m. Woman must start and relays must be made every two laps

SR142.1 Those skating Classic, Masters and Veterans two-person relays may also choose to enter any Senior four-person relays or a Senior two-person relay of a different type. EXAMPLE: Skaters may not enter Classic two-mixed and Senior two-mixed, but may enter Senior two-man or two-woman and Classic two-mixed.

### **SR143 Quad Two Person Relays**

- A. Juvenile Relays
  1. Two Boy-two boys skating a total distance of 1200m. Relays must be made every two laps.
  2. Two Girl-two girls skating a total distance of 1200m. Relays must be made every two laps.
  3. Two Mixed-one boy and one girl skating a total distance of 1200m. Relays must be made every two laps; girl starts.
- B. Juvenile Relays
  1. Two Boy-two boys skating a total distance of 1200m. Relays must be made every two laps.
  2. Two Girl-two girls skating a total distance of 1200m. Relays must be made every two laps.
  3. Two Mixed-one boy and one girl skating a total distance of 1200m. Relays must be made every two laps; girl starts.
- C. Freshman Relays
  1. Two Boy-two boys skating a total distance of 2000m. Each boy must skate not less than one lap nor more than five laps before each relay, with the last boy to skate a minimum of one lap.
  2. Two Girl-two girls skating a total distance of 2000m. Each girl must skate not less than one lap nor more than five laps before each relay, with the last girl to skate a minimum of one lap.
  3. Two Mixed-one boy and one girl skating a total distance of 2000m. Girl must start, relays must be made every two laps.
- D. Senior Relays
  1. Two Man-two men skating a total distance of 5000m. Each man must skate not less than one lap nor more than five laps before each relay, with the last man to skate a minimum of one lap.
  2. Two Woman-two women skating a total distance of 3000m. Each woman must skate not less than one lap nor more than five laps before each relay, with the last woman to skate a minimum of one lap.
  3. Two Mixed-one man and one woman skating a total distance of 3000m. Man must finish, relays must be made every two laps.
- E. Classic Relays
  1. Two Man-two men skating a total distance of 2000m. Relays must be made every two laps.
  2. Two Woman-two women skating a total distance of 2000m. Relays must be made every two laps.
  3. Two Mixed-one man and one woman skating a total distance of 2000m. Woman must start and relays must be made every two laps.
- F. Masters Relays
  1. Two Man-two men skating a total distance of 2000m. Relays must be made every two laps.
  2. Two Woman-two women skating a total distance of 2000m. Relays must be made every two laps.
  3. Two Mixed-one man and one woman skating a total distance of 2000m. Woman must start and relays must be made every two laps.
- G. Veteran Relays
  1. Two Man-two men skating a total distance of 2000m. Relays must be made every two laps.

2. Two Woman-two women skating a total distance of 2000m. Relays must be made every two laps.
3. Two Mixed-one man and one woman skating a total distance of 2000m. Woman must start and relays must be made every two laps.

H. *Esquire Relays*

1. *Two Man - two men skating a total distance of 2000m. Relays must be made every two laps.*
2. *Two Woman - two women skating a total distance of 2000m. Relays must be made every two laps.*
3. *Two Mixed - one man and one woman skating a total distance of 2000m. Woman must start and relays must be made every two laps.*

SR143.1 Those skating Classic and Masters two-person relays may also choose to a Senior two-person relay of a different type. EXAMPLE: Skaters may not enter Classic two-mixed and Senior two-mixed, but may enter Senior two-man or two-woman and Classic two-mixed.

### SR 144 Inline Three Person Relays

There are only elite divisions established for Inline Three-Person Relays for inline skates. These are as follows:

#### 1. Juvenile Relays

**a. Three PERSON.** 3 Girls or 3 Boys or any combination of either boy or girl. Both skating a total distance of 1200m. Each skater to skate a total of 100m before relaying with another. All skaters shall relay every lap.

#### 2. Freshman Relays

**a. Three Man** - (Elementary & Freshman) Three Men skating a total distance of *2100m*. Each man skates a continuous 100m before relaying with another. All skaters shall relay every lap.

**b. Three Lady** - (Elementary & Freshman) Three Ladies skating a total distance of *2100m*. Each lady skates a continuous 100m before relaying with another. All skaters shall relay every lap.

**c. Three Mixed** - (Elementary & Freshman) Any combination of male and female, but no teams of the same gender. Skating a total distance of *2100m*. Each member skates a continuous 100m before relaying with another; ladies start. Ladies skate their 100m before the men skate their 100m. All skaters shall relay every lap.

#### 3. Senior Relays

**a. Three Man** - (Soph, Jr, Sr, ~~Classic~~) Three Men skating a total distance of *4500m*. Each man skates a continuous 100m before relaying with another. All skaters shall relay every lap.

**b. Three Lady** - (Soph, Jr, Sr, ~~Classic~~) Three Ladies skating a total distance of *3000m*. Each lady skates a continuous 100m before relaying with another. All skaters shall relay every lap.

**c. Three Mixed** - (Soph, Jr, Sr, ~~Classic~~) Any combination of male and female, but no teams of the same gender. Skating a total distance of *3000m*. Each member skates a continuous 100m before relaying with another; ladies start. Ladies skate their 100m before the men skate their 100m. All skaters shall relay every lap.

#### 4. Master Relays

**a. Three Man** - (~~Classic~~ & Master ~~& Above~~) Three Men skating a total distance of *3000m*. Each man skates a continuous 100m before relaying with another. All skaters shall relay every lap.

**b. Three Lady** - (~~Classic~~ & Master ~~& Above~~) Three Ladies skating a total distance of *3000m*. Each lady skates a continuous 100m before relaying with another. All skaters shall relay every lap.

**c. Three Mixed** - (*Classic & Master & Above*) Any combination of male and female, but no teams of the same gender. Skating a total distance of *3000m*. Each member skates a continuous 100m before relaying with another; ladies start. Ladies skate their 100m before the men skate their 100m. All skaters shall relay every lap.

### **5. Veteran Relays**

*a. Three Man – (Veteran & Above) Three Men skating a total distance of 2100m. Each man skates a continuous 100m before relaying with another. All skaters shall relay every lap.*

*b. Three Lady - (Veteran & Above) Three Ladies skating a total distance of 2100m. Each lady skates a continuous 100m before relaying with another. All skaters shall relay every lap.*

*c. Three Mixed - (Veteran & Above) Any combination of male and female, but no teams of the same gender. Skating a total distance of 2100m. Each member skates a continuous 100m before relaying with another; ladies start. Ladies skate their 100m before the men skate their 100m. All skaters shall relay every lap.*

### **SR 145 Quad Three Person Relays**

#### **1. Freshman Relays**

*a. Three Man - (13 and under) Three men skating a total distance of 1200m. Each man skates a continuous 100m before relaying with another. All skaters shall relay every lap.*

*b. Three Woman - (13 and under) Three women skating a total distance of 1200m. Each woman skates a continuous 100m before relaying with another. All skaters shall relay every lap.*

#### **2. Senior Relays**

*a. Three Man - (14 & older) Three men skating a total distance of 3000m. Each man skates a continuous 100m before relaying with another. All skaters shall relay every lap.*

*b. Three woman - (14 & older) Three women skating a total distance of 3000m. Each woman skates a continuous 100m before relaying with another. All skaters shall relay every lap.*

#### **3. Masters Relays**

*a. Three Men - (35 & older) Three men skating a total distance of 1500m. Each man skates a continuous 100m before relaying with another. All skaters shall relay every lap.*

*b. Three woman - (35 & older) Three women skating a total distance of 1500m. Each woman skates a continuous 100m before relaying with another. All skaters shall relay every lap.*

### **SR150 QUALIFICATION FOR SPECIFIC SPEED DIVISION**

SR150.1 All ages shall be reckoned as of January 1st of the current competitive year and are binding for the entire competitive year.

SR150.2 Speed skaters shall compete in their proper division according to age. Should any skater compete in the wrong division, he or she shall be subject to disciplinary action for violating the rules of eligibility. Advancement to the next division shall occur when the skater reaches the age for such advancement.

SR150.3 Challenge Up: If a non-championship contest permits challenge up, the skater will be allowed to challenge up one division above that which he/she would normally skate in speed. For safety considerations, a speed skater is allowed to challenge up only one age classification in individual divisions for interclub or invitational contests. Because of broader age categories in relays, challenge up for speed relays is not permitted. In speed skating, at no time can a freshman division skater skate with a junior or senior division skater. Challenge up is not permitted for Regional and National Championships.

SR150.4 Unofficial Events: Contest hosts wishing to offer unofficial individual, relay or open events in non-qualifying speed meets, must structure these events for purposes of safety as follows:

- A. Events for skaters 14 years of age and older
- B. Events for skaters age 8 through 13
- C. Events for skaters age 4 through 7
- D. Events for any combination of two adjacent individual divisions, age 8 and above.

NOTE: At no time can a Freshman division skater skate with a Junior or Senior division skater, nor can a Primary division skater skate with an Elementary division skater.

SR155 Any skater on the track or in the center of the track during a warm-up or practice, who is not part of the group called by the announcer for warm-up or practice is subject to disqualification from their next event, at the discretion of the meet director.

## **SR160 ENTRY AND ELIGIBILITY REQUIREMENTS**

SR160.1 Each contestant and member of a relay team filing an entry form for a sanctioned meet must possess a current USARS speed membership.

SR160.2 Each contestant and member of a relay team must file proper entry forms in order to participate in any interclub or invitational contest, the designated regional championships or the national championships.

### **SR161 Filing of Entry Applications**

Prior to the deadline for entry into the regional or qualifying championship, clubs shall submit the number and type of relays that will represent that club on the forms provided, and pay the additional entry fees for each member of the designated relays. In addition to the Master Entry Sheet each club MUST submit one copy of the relay roster sheet DESIGNATING THE NAMES OF THE SKATERS IN EACH RELAY. (The other copy of the relay roster sheet is to be used in the event that changes are made in any of the relays. If changes are made, a second set of relay rosters must be turned in at the start of the speed meet, or at the time designated by the meet director. IF CHANGES ARE NOT MADE, YOU MUST SKATE YOUR RELAY TEAMS AS ORIGINALLY SUBMITTED WITH THE MASTER SHEET.) All relay skaters must be registered for the championships under the individual registration and pay the appropriate entry fee. Each contestant who is skating relay only and not one of the individual events, shall have one (1) secondary event registration fee credited on the relay registration form so as to avoid an overcharge for an extra event.

### **SR162 Championships Rules of Entry (Qualifying & National)**

SR162.1 The following contestant fees are the maximum that may be charged for one or more events within each federation and shall include the contestant's registration, entry, general admission (with in-and-out privileges) and assessment fees:

- A. For a qualifying speed championships (Regional Meets).

First event - \$45.00; Additional events - \$25.00

- B. The contestant's combined ENTRY and REGISTRATION fees include a ~~\$5.00 special \$3 per skater per event~~ assessment payable to USARS. ~~for each federation in which the skater participates in the championship. (i.e., \$5.00 for figure events and additional \$5.00 for speed events and \$5.00 for hockey events).~~

C. The ~~\$5.00~~ \$3 per skater per event USARS assessment fee collected for each federation entry must be forwarded to the USARS National Headquarters within five (5) days from the close of the championships.

D. No other assessments may be collected from the competitors. Warm-ups held prior to the skating of an event are considered part of that contest and no additional fee may be assessed to the skater for participation in the event warm-up.

E. Open Nationals – Late Fees: For Quad and Outdoor National Speed Championships, the normal registration deadline shall be 30 days prior to the start of the meet. A late fee double the normal registration fee shall be in effect from 30 days to seven working days prior to the beginning of the Championships. After the seven working days, no further registrations will be accepted under any circumstances.

F. At the Outdoor National Speed Skating Championships, the Road and Track Championships will be considered separate primary events and a separate registration fee will be collected for each Championships when entered by the same individual. There are no secondary event fees.

SR162.2 On the first scheduled day of the speed skating events, or at the time designated by the meet director, and prior to the start of the relays, the officially designated team coach or the designated club representative shall turn in relay rosters to the meet director on the forms provided for this purpose. Any changes must designate the exact composition of each relay. Any additional changes after the initial event heats must meet the injury provisions for substitutions.

### **SR163 Relay Team Membership**

SR163.1 Club Affiliation-Members of a relay team for the quad or inline events may represent only one club in relay speed skating competition. If the members are affiliated with a different quad club than an inline club, they may only represent the same quad club and the same inline club for competition. If the members are from various teams the team must skate unattached at the Regional Championship and members must skate unattached in all speed races in which they compete. No substitution will be allowed for unattached skaters at the National Championships as outlined in SR 163.2 & SR 163.3. (See USARS General Rules 5.02.03).

SR163.2 A relay team must skate and qualify for the National Championships at a Regional Qualifying Championship.

A. At the National Championship, team members may be selected for the qualifying team relay from any club members that have qualified for the National Inline Championship in any Elite Division, Relay provided that skater meets the qualification to be entered in that relay event.

B. Substitutions other than a National Qualifying skater will be allowed provided the substituting team members entered the Regional Qualifying Championships and are listed on the master entry submitted for the National Championship before the deadline.

C. Substitutions may be made in accordance with the rules of substitution after the initial heat as stated in SR 163.3.

D. A defending team must be intact at the time their qualifying relay event is skated at their respective Regional Qualifying Championships. Substitutions on defending relay teams will only be allowed for injuries encountered at the National Championship after

the team has skated a heat or semi-final or an original member is injured at the National Championship during a preliminary race prior to the National Championship. Defending teams must skate intact if the event is a final event, no injury substitution will be allowed except as stated above during the preliminary events.

**SR163.3** Once the initial heat race has been run, no substitutions will be allowed, except as follows: If an injury occurs to any team member after heats have started, and that skater or skaters cannot compete for the remainder of the competition, a substitution may be made from the original list of skaters. The injury must be verified by a medical officer appointed by USARS. No team member can be removed and substituted from another relay team once the heat races have started. The number of additional skaters allowed for substitutions is as follows:

A. Four Person Relays: No more than two additional team members may be substituted for injury.

B. Four Mixed Relays: No more than two additional team members, one man and/or one woman may be substituted for injury.

C. Two Person Relays: Only one team member may be substituted for injury.

D. Two Mixed Relays: One additional team members, one man or one woman may be substituted for injury

E. Three Person Relays: Only one team member may be substituted for injury.

F. Three Mixed Relays: One additional team members, one man or one woman may be substituted for Injury.

**SR163.4** Any substitute must fulfill all eligibility and entry requirements for the qualifying meet including payment of the appropriate entry fees.

**SR163.5** All relay team members registered for the National Championships must pay the appropriate entry fee for that event. The relay substitution changes are to be submitted to the Meet Director prior to the end of the appropriate relay practice. All changes shall be made by a registered coach.

**SR170 USARS Learn to Speed Skate Program:**

**SR170.1 Divisions and move-up rules for Learn to Speed Skate Program.**

The Learn to Speed Skate Program is a “grassroots” program designed to build the competitive sport of speed skating. The express purpose and intent of Learn to Speed Skate Program is to provide new skaters with competitive events designed to introduce them to the sport of Inline Speed Skating such as; local League Events, regional Invitational Events and the Learn to Speed Skate Program Regional Championships (athletes must upgrade membership to participate at the invitational and regional level).

**SR170.2** The Learn to Speed Skate Program divisions can be based on the age of the skater, and mirror the current elite divisions, or individual leagues will have the ability to utilize systems that are most efficient for their demographics.

**SR170.3** Eligibility for Learn to Speed Skate Program is established at the beginning of each skating season with the purchase of a competitive card. The grassroots membership is reserved for new speed skaters and is available for a maximum of 3 competitive seasons. The grassroots membership is only valid for participation in USARS team practices and local USARS league competition. If a grassroots skater enters an invitational, a qualifying clinic or a qualifying competition they will be required to upgrade their USARS membership to the Limited or elite category before they will be allowed to participate, and they will not be allowed to purchase the

grassroots membership in subsequent years even if they are within the first three years of membership.

SR170.4 Skaters are eligible to compete in the Learn to Speed Skate Program, unless they have met any of the following conditions the previous or prior years.

A. Skaters placing 1<sup>st</sup>, 2<sup>nd</sup> or 3<sup>rd</sup> in any individual or relay event at the National Championships (including Standard/Inline, Junior Olympic, Novice, Quad, Banked Track or Road) are not eligible to compete in the Learn to Speed Skate Program in league, Invitational or the Learn to Speed Skate Program Regional Championships the next season. Participation or placement in the Tiny Tot division will have no effect on the Learn to Speed Skate Program eligibility.

B. Skaters will not be eligible to compete in the Learn to Speed Skate Program for more than three seasons beginning with the first the season's membership. Participation or placement in the Tiny Tot division will have no effect on the Learn to Speed Skate Program eligibility.

SR170.5 Learn to Speed Skate Program skaters are eligible to skate Learn to Speed Skate Program at USARS invitational and qualifying events in their first three seasons regardless of the level of their membership status as long as they do not lose eligibility under another eligibility rule listed under

## SR200 OFFICIAL LAYOUT FOR SPEED RACE COURSES

### SR210 OFFICIAL INDOOR CHAMPIONSHIP 100M TRACK

#### SR211 Laying out the Track

SR211.1 All skating centers should be prepared at all times to conduct speed skating contests and competitions. These can only be held on tracks of the correct size. The USARS National Headquarters will provide, upon request, information and dimensions to assist in layout of a speed track. A minimum unobstructed skating surface of 70' wide x 170' long must be used at qualifying meets, to conform to the standard 100 meter track. The skating surface must be plastic coated, in excellent condition, and must be clean. All speed track markings are to be accurate and clearly visible. Wheel coatings or traction substances may not be painted on or otherwise applied to the wheels used at official qualifying championships.

SR211.2 It is essential that only a steel metric measuring tape be used.

SR211.3 Begin by finding the exact center of the skating surface. When all four corner pylon positions are located, mark the location of these positions in permanent black ink. Only a small "X" is necessary at each corner. Then mark the start and finish lines, and gate areas.

SR211.4 The official track for all meets qualifying skaters to the national championships is 100m per lap.

A. The starting line shall be four (4) feet-1.2 meters-behind pylon 4. Only one (1) starting line is permitted. Contests are required to provide a minimum of 32 inches per skater at the pylon #4 starting line without moving the pylon in. *The 32 inch lanes will be marked. In the event there are not enough contestants to fill the lanes, the undrawn lanes will remain open.*



Typical floor size for the number on the line:

Floor Width	Number on the line
75'	6
78'	7
85' or more	8

B. The timing of races will start at the timing line located in the center of the track between pylons 1 and 4. This timing line is also the finish line.

SR211.5 The pylons are numbered as follows: The number 1 pylon is the first beyond the timing line in a counterclockwise direction; numbers 2, 3 and 4 pylons follow in order in the counterclockwise direction. Pylons 1 and 3 are placed at the start of the corners; pylons 2 and 4 are placed at the start of the straight-aways. (See track diagram.)

SR211.6 The official pylon or corner marker approved for use in USARS sanctioned speed competitions should be made of rubber or plastic material with no protrusions or edges exposed to the skating surface. The style of the pylon is similar to that of a traffic or safety cone. The height of the corner marker must be 4" and the base of the pylon no less than 9" across. As noted in the diagram below, one corner lip of the pylon must be cut away for proper placement of the pylon, *and an angle must be cut in the top of the pylon.*

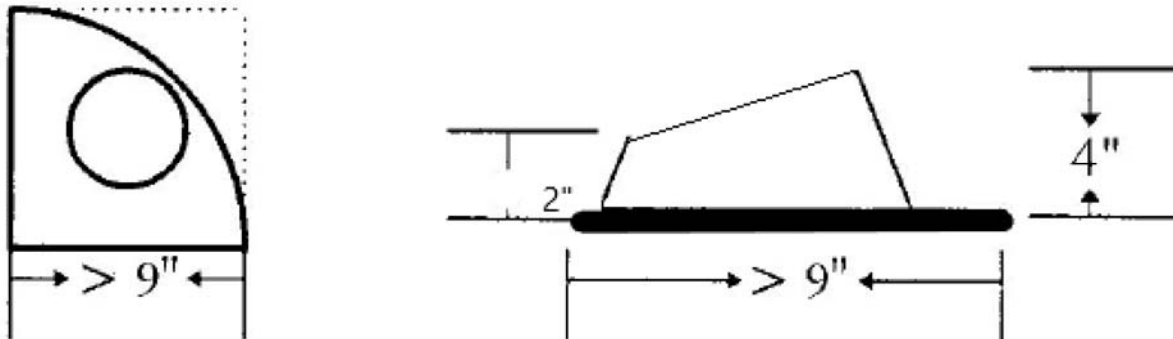

SR211.7 The floor that determines the outer boundaries of the speed track should lie directly beneath the pylon edge so that the outer edge of the pylon covers the mark on the floor. The floor should be marked with black tape to indicate the outside boundaries of the pylon box. These markings should lie underneath the pylon edges facing the inside of the track (see diagram).

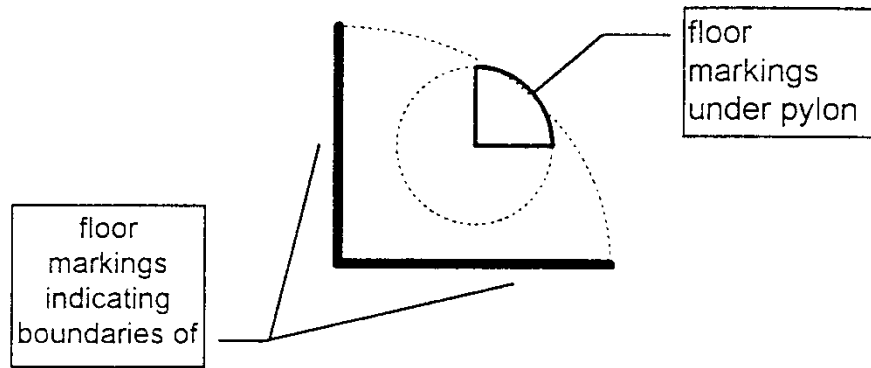

SR211.8 The only acceptable wheel cleaning agent at the national championships is a vinegar and water solution to be made available by USARS.

SR211.9 The national championships floor will not be cleaned with any product that is not approved by the manufacturer of the plastic used on the floor.

**SR212 The Passing Area**

The entire track area outside of the pylons is considered legal passing area.

**SR220 THE RELAY TRACK**

SR220.1 Relay events may be skated on any officially measured track as long as the timing and finish lines for the distances are one and the same.

SR220.2 The relay shall be made only in the legal relay zone. The legal relay zone begins at pylon 4 and ends at pylon 1, regardless of the track size.

SR220.3 The pylons are placed on the four corners as for regular speed skating events.

SR220.4 The gate area is a series of lanes marked out and located in the center of the skating surface. There are as many lanes as there are teams in the event. Each lane is a maximum of **2-1/2 feet 32 inches** wide and a maximum of 22 feet long. (See track diagram.) Lanes are used for four person relays only. The size of the gate area shall not exceed 22-1/2 feet wide by 22 feet long.

SR220.5 Placement of the gate area at all qualifying meets is to be approximately 56 feet from the front of the gate area to pylon 3, **and placed in line with pylon 3 (see diagram below)**. The size of the gate area is left to the discretion of the chief referee. The gate area will change if the track is moved more than four feet.

SR220.6 The relay return to the gate area is defined by as the area between pylon 1 and pylon 2.

## Official Championship 100m Track

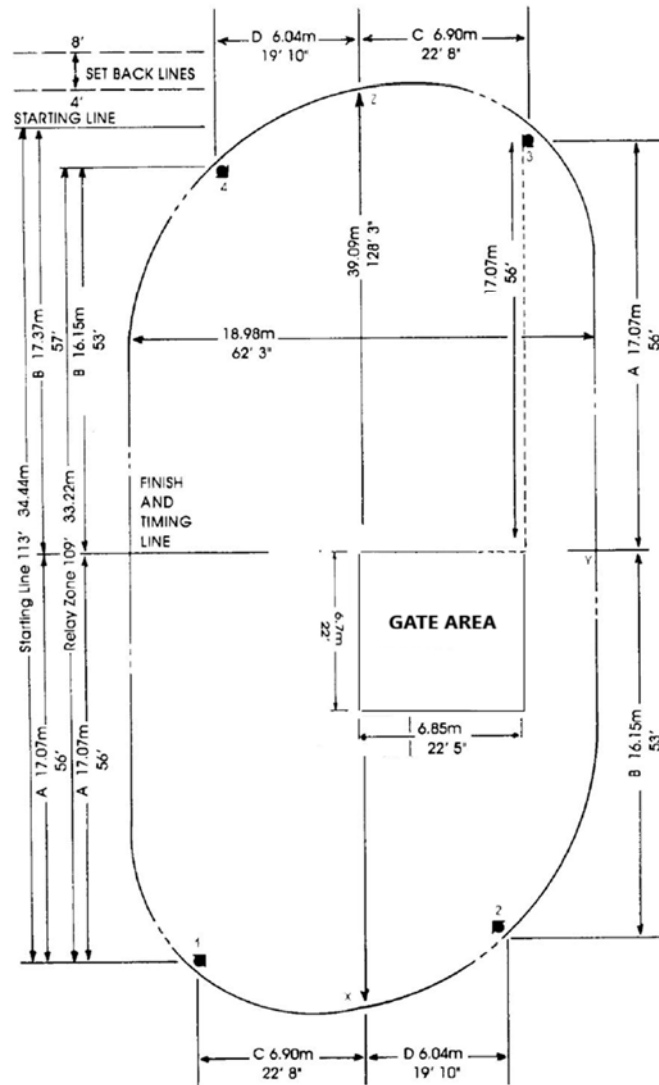

**SR230**      **OUTDOOR RACE COURSES (As defined by the International Federation CIC)**

**SR231**      **Outdoor Race Course**

SR231.1      A race may be either a "track" or "road" course. A road course may be either an "open" or "closed" circuit.

SR231.2      Both on the track and on the road, the race course is measured 30 centimeters from the inner edge. This line is called "ROPE".

SR231.3 In all the courses, curves are to be bordered either by a natural edge or markers that are highly visible. Such signals are never to be placed on the rope of the track because they may represent a danger for competitors.

SR231.4 On road courses with both left and right curves, measuring is to be taken along an imaginary line at 30 centimeters from the extreme ends of the curves themselves.

## **SR232 Tracks - Outdoor**

SR232.1 A "track" is defined as a race course within an outdoor facility provided with two straightaways of the same length and with two symmetrical curves having the same diameter.

SR232.2 The total length of a track cannot be less than 125 meters or longer than 400 meters. The minimum width must be at least 5 meters.

SR232.3 The track surface may be made of any material, provided it is perfectly smooth and not slippery, so that it does not compromise adhesion.

SR232.4 Tracks may be perfectly level or with banking at the curves.

SR232.5 Tracks with banking at the curves are to be not less than 125 meters long and not more than 250 meters. Banking is to be gradually and uniformly rising from the inside to the outside of the course. Straightaways may have banking in order to allow the introduction of curve banking. However, straightaways are to be perfectly level longitudinally, to a minimum of 33% of their total length.

SR232.6 The finish line must be marked with a white line, 5 centimeters wide.

SR232.7 The starting line must not be on a curve, except for the cases when it is impossible to do otherwise.

SR232.8 External fencing bordering the tracks must be protected through suitable materials in order to avoid dangers to the competitors due to its presence. A smooth barrier is to be provided on the track side.

## **SR233 Road Course**

SR233.1 In "open road" competitions, starting and finishing lines do not coincide.

SR233.2 A "closed circuit road" race course is a road course consisting of an asymmetrical closed circuit which competitors are to cover one or more times according to the distance of the event.

SR233.3 A "closed circuit road" race course must not be shorter than 250 meters and longer than 1.000 meters.

SR233.4 The road course cannot be less than 5 meters wide in any point of the course.

SR233.5 The road surface must be uniformly and sufficiently smooth without hollows and fissures. The cross-fall of the course shall never exceed 3% of its width.

SR233.6 In "open courses" gradients shall never exceed 5%. Exceptions to this rule shall never exceed 25% of the whole course.

SR233.7 Starting and finishing lines must be marked with a line 5 centimeters wide. The starting line must not be placed on a curve except when it is impossible to do otherwise. The finishing line shall be placed at not less than 50 meters after the curve leading to the finish line.

#### **SR234 Suitability of a Race Course for Competitions**

SR234.1 Any decision regarding the suitability of a race course for a given event is up to the chief referee after the start of the competition itself.

SR234.2 When the ground or weather conditions hinder the normal performance of a competition or the continuation of the same, the chief referee can interrupt the competition for a given period of time or he can cancel it. In the case of preliminary heats, the competition shall start or continue once the ground condition is suitable for safe skating, provided that it ends within 24 hours of its interruption.

SR234.3 When a race is continued, all laps completed, all points accumulated, or any eliminated skaters will stand as is.

SR234.4 When the competition which was interrupted starts again, only the athletes who were competing at the moment of the interruption shall participate again. Competitors who withdrew or were disqualified continue to be excluded.

#### **SR235 Direction of the race**

For track or road closed circuit competitions, competitors are placed so that their left hands are located facing the inside edge of the track or road. The direction of the race shall be counter clockwise.

#### **SR300 USARS SANCTIONS AND PERMITS**

(See Article XVI of USARS Bylaws and GR600 of the General Rules)

##### **SR300.1 Outdoor Roller Skating Competitions**

A. A sanction for an outdoor speed skating or other competition will not be issued unless the applicant submits to USARS Headquarters a complete diagram of the race course indicating where barricades will be erected to close off the area from vehicular traffic. A description of irregularities in the skating surface must be indicated on the diagram, with footnotes stating the location of manhole covers, potholes and other track impediments and how these hazards will be dealt with for the safety of the participants. Inspection must be personally made by a qualified official and this diagram prepared with his or her signature. In the case of a member sanction, the inspection shall be made and the diagram signed by the USARS certified meet director.

B. Copies of city permits allowing the use of public streets, or in the case of the use of private property, the owner's written permission must accompany sanction applications.

C. The sanction application must include a description of safety precautions that will be in place to protect the contestants from moving traffic or other sources of danger not encountered within indoor speed skating or other competitions. Police protection and supervision must be provided in all venue using public streets.

- SR300.2 Participation Permit
- When USARS members wish to compete in any unsanctioned competition, the meet host or a USARS club, must apply for a Participation Permit for that competition. A Participation Permit is issued by USARS solely for the purpose of coordinating competitions. USARS exercises no control or supervision over such meet and is not responsible for the way in which it is conducted. A Participation Permit will be issued under the following conditions:
- A. Will be issued for outdoor competitions only.
  - B. There is nothing in the name of the meet or the promotional materials which suggests or implies any involvement of USARS in the conduct of the meet, including the use of names substantially similar to competitive skating activities which are sanctioned by USARS.
  - C. The Participation Permit application does not conflict with, or otherwise interfere with the conduct of an indoor or outdoor speed skating competition for which a USARS' sanction has been granted or a proper USARS' sanction application has been filed.
  - D. USARS participants are notified that their USARS accident insurance does not cover participation in non-USARS-sanctioned events.
  - E. The fee which must accompany the application for the Participation Permit is \$50.00 and covers all USARS participants in the meet regardless of club affiliation.

- SR300.3 Speed skating leagues and meet hosts are free to add cash or premium awards as a means of drawing greater participation in their indoor or outdoor events.

## **SR320 APPLICATIONS FOR INDOOR COMPETITION SANCTIONS**

- SR320.1 Sanction applicants for speed meets shall meet the following safety requirements:
- A. The track shall be laid out according to minimum safety specifications provided by USARS.
  - B. All rail barriers and all rail openings between corner pylons 2 and 3, 4 and 1 shall be closed in such a manner as to present a continuous solid, smooth surface from the floor to the top of the horizontal railings.
  - C. For skating floors with no rail or wall barrier surrounding the skating surface, a minimum of five (5) feet from the edge of the skating surface shall be kept clear of seating, bleachers, spectators, and contestants and will be clearly identified by use of chalk, tape, rope, etc.
  - D. Smooth, continuous barriers shall not be padded. All rough surfaces, protrusions and obstacles adjoining the track or within five (5) feet of the skating surface without a barrier protection, shall be padded. The padding shall be at least 2" thick raised from the skating surface 10".
  - E. No structures, speakers, lights, or the like shall project into the track area within seven and a half (7) feet overhead of the skating surface. If the actual track path on the floor is more than 30 feet from the edge of the skating surface, the safety requirements for padding are waived.
- SR320.2 An application in writing for a competitive sanction must be filed with the USA Roller Sports National Headquarters at least thirty (30) days prior to the opening date of the contest. Any sanction applications received within the thirty (30) day deadline will pay a penalty of an additional \$150 per day. Any announcement of contest must bear the USARS sanction number

provided by the National Office. In the case of regional championships, application must be filed so that the USARS Board of Directors may act upon the sanction at its regular meetings. Sanction applications are available upon request from USARS or on the USARS web site ([www.usarollersports.org](http://www.usarollersports.org)).

SR320.3 The following information is required on the application: date and site of competition, sponsoring club and club identification number, entry fees, size of skating surface, geographical area covered by sanctioned meet, kinds and value of awards, if any, estimate of potential entry, type of meet, signatures of host club officers, signature of site owner/operator and signature of the chairman of the USARS regional association.

SR320.4 Sanction applicants must agree to follow USARS medical supervision guidelines as stated in USARS General Rules.

SR320.5 The meet host in charge of each indoor competition shall be responsible for seeing that the above safety requirements are met.

**SR330 REQUIRED EQUIPMENT**

The meet host in charge of each competition shall be responsible for provision of the following equipment:

SR330.1 Pylons – four regulation corner pylons with no protruding edges facing the track.

SR330.2 Starting guns – a minimum of two blank starting guns of .22 or .32 caliber with sufficient blank cartridges or electronic starting device with a strobe light producing a tone or simulated gun shot. At all National Championship contests the tone is preferred. “Single shot” guns and starting devices which automatically eject the shells are prohibited.

SR330.3 Stopwatches – Stopwatches or electronic timers checked for accuracy and graduated to time within 1/100 of a second.

SR330.4 Lap markers – a series of cards or an electronic device to announce the number of laps to be skated. The numbers shall be of sufficient size to be readable to the contestants during the race. The number of cards needed will depend on the size of the track being used. (A 100m track requires at least 50 cards numbered 1 through 50 on both sides.)

SR330.5 Scoring sheets and pads – The necessary scoring sheets, place sheets and disqualification sheets shall be obtained from the USARS National Headquarters at the time when the meet sanction is granted.

SR330.6 Microphone.

SR330.7 Checkered flag.

SR330.8 Relay numbers – clearly readable numerals on cloth, which can be worn pinned to the hip of the contestant’s uniform. Four person relays require a total of eight matching relay numbers for each team. Cloth helmet covers may be used in all competitions.

**SR340 REQUIRED FACILITIES**

The meet host in charge of each competition shall be responsible for providing the following facilities.

SR340.1 Contestants' facilities-facilities for changing clothes and obtaining first aid equipment shall be available for all contestants.

SR340.2 Tabulator's table-A table and chairs in a suitable location for use by the tabulator and scorers shall be provided. If the table is not located in the center of the floor, it shall be located at a place adequately protected from interference by all unauthorized persons.

**SR350 ADDITIONAL PREPARATION**

The meet host in charge of each competition shall be responsible for providing:

SR350.1 Officials with current USARS commissions appropriate to their duties at the competition.

SR350.2 Track markings to include not only the pylon marks, but also the starting line, finish/timing line, 4' and 8' set-back lines and relay gate area. (Additional pylons may be used to indicate the relay gate area.)

SR350.3 Schedule of races, posted in advance of each day's competition.

SR350.4 Adequate supply of small (1") safety pins for fastening relay numbers to uniforms.

SR350.5 Bulletin board or other suitable area for posting results.

SR350.6 If necessary, the meet officials may use black electrical tape to mark off an area at the end of the skating surface to be designated as the Competitive Steward's area. Depending on the starting line position, it may be advisable to mark off both ends of the floor if relay teams have no place to exit. While this area is not designated as skating surface, once a contestant leaves this area they must abide by all existing helmet regulations. The marked off area will be designated by the Meet Director.

**SR360 CONTESTANTS' EQUIPMENT**

**SR361 Speed Skating Uniform Regulations**

SR361.1 Men and Women – The speed uniform shall be of non-transparent material, consisting of a long or short-sleeved shirt. One or two-piece uniforms are permitted. Each registered speed club shall have a competitive uniform, which shall be distinguishable as a club uniform by color and pattern. Contestants in individual events must wear their club uniform in all Regional and National INDOOR Qualifying Speed Championships (with the exception of the World Class indoor division). At league, interclub and invitational contests, which are not qualifying meets, and the Outdoor Nationals, individuals are not restricted to club colors and may wear uniforms representing their sponsors provided those sponsors have registered with USARS for the current competitive season. Individuals are permitted to wear their USARS approved sponsor's uniforms and/or hats for awards presentations at Regional and National Indoor Championships.

Sponsorship logos shall be permitted on an individual contestant's uniform only if they do not impair the ready identification of the club uniform by color and pattern. The relay uniforms shall be identical. This means that if any relay member wears one or more sponsorship logos on his or her relay uniform, all team members must wear the same sponsorship logo or logos, and they shall be placed identically on their uniforms.



- SR361.2 Shirts must be tucked inside of trunks at all times while contestants are on the skating surface.
- SR361.3 Sweatshirts and sleeveless shirts are not acceptable shirts. Short cut shirts or bare midriffs are not permitted. T-shirts will not be allowed at qualifying meets.
- SR361.4 Trunks must be of the basketball, boxer or bicycle type. Bikini type or French cut trunks are not acceptable as part of either a one- or two-piece uniform.
- SR361.5 If full length tights are worn and a stirrup is provided, it must be worn inside the skating boot.
- SR361.6 Contestants in individual events shall wear their club uniform in each such indoor speed event. Sponsorship logos shall be permitted on an individual contestant's uniform only if they do not impair the ready identification of the club uniform by color and pattern.
- SR361.7 All members of a relay team shall wear their club uniforms in each relay event. The relay uniforms shall be identical. This means that if any relay team member wears one or more sponsorship logos on his or her relay uniform, all team members must wear the same sponsorship logo or logos and they shall be placed identically on their uniforms. One-, two- or three-piece uniforms are permitted as long as the colors and the patterns are the same. Difference in color of fabric due to fading or difference in dye lot may be permitted. Note: Speed skating helmets for relay skaters do not have to match. The helmets are considered as equipment, and not part of the uniform. Socks are not part of the uniform.
- SR361.8 Regulation uniforms must be worn at all USARS sanctioned speed competitions, including official warm-ups. All speed practices at regional and national championships shall be labeled "official" practice, and will thus require proper uniforms, the same or equivalent to their competitive uniforms. Uniforms must at all times be clean and in good repair. Failure to appear on the starting line in correct, clean and presentable uniform shall be cause for disqualification from the race. All contestants must remain in complete uniform and be properly dressed while on the skating surface. At all outdoor competitions, warm-up suits may be worn during practice or official warm-ups if the weather temperature is cool.
- SR361.9 Jackets are not permitted to be worn either in competition or in the official division or race warm-up periods. This applies to indoor competitions only.
- SR361.10 Lettering on uniforms
- A. Only members of registered USARS roller speed skating clubs, and then only with the permission of the presiding officers of such clubs, may wear the name of the club or the club insignia on their uniforms while competing. A skater may wear his or her own name on the uniform, but under no circumstances may the name of any other person, unregistered club or the name of any skating center be worn. However, the name of the skating center may be incorporated into the name of the skating club. Under no circumstances shall any skater be permitted to wear a commercial advertisement, a trademark or the name of a sponsor on his/her uniform during performance in competition with the exception of USARS approved sponsors. The name of a skating center, commercial firm, business, place or any other commodity or service shall be considered commercial advertisement. Other than that specified for competitive uniforms, wearing apparel which bears sport identification or other insignias, words, slogans or pictures shall be in good taste in the opinion of the meet officials.

B. Garment and Equipment Manufacturer's Logos

Speed competitors may wear sports clothing and equipment in competitions bearing names and logos of a manufacturer without these being registered as USARS sponsors only under the following conditions: The name or trademark on the clothing can appear a maximum of four (4) times on the uniform and be no larger than 50mm high and 75mm wide (2" x 3"). Manufacturers' logos and names can appear on equipment such as skates and helmets without restriction to size. Clothing markings that do not meet this regulation must be removed or the garment manufacturer must register as a National sponsor.

SR361.11 Helmets with the ANSI Z90.4 SNELL Bicycle standard, American Society for Testing and Materials (ASTM) standard F-1447 and/or CPSC Standard (Consumer Product Safety Commission bike helmet standard) are required to be worn by all speed skaters at all speed skating competitions. All normal markings on helmets must be left intact and not tampered with in order that they be readily identified as having complied with the ANSI Z90.4, SNELL Bicycle standard, American Society for Testing and Materials (ASTM) standard F-1447 and/or CPSC Standard (Consumer Product Safety Commission bike helmet standard). The use of cloth helmet covers for hard helmets is allowed for all USARS sanctioned meets. No decorations will be allowed on cloth helmet covers. Individuals may put their club names and/or personal names on their helmets, provided the letters do not cover up the manufacturers normal markings. Slogans, abbreviated names or nicknames will not be used.



The left photo illustrates correct position of the helmet, while the right photo illustrates incorrect position of the helmet.

- A. All speed skating contestants must have their helmets on and securely fastened at all times while on the skating surface.
- B. The headgear must not restrict the vision of the skater in any way.
- C. The headgear must have chin straps and be securely fastened beneath his or her chin at all times during a race.
- D. Any contestant willfully removing his or her headgear during a race shall be disqualified.
- E. At no time during a skating contest, whether before, during or after a race, will a contestant be permitted to remove his or her headgear and throw it, swing it, toss it, drop it or otherwise use it in a manner that interferes with the safe and sportsmanlike conduct of the contest.
- F. Should a skater's helmet come off for any reason during a race, the skater will be automatically disqualified.
- G. Proper, safe positioning of helmets on the head will be strictly enforced. Helmets must not be worn on the back of the head, but rather positioned forward, with the front of the helmet slightly above the eyebrows. No hair should be visible below the helmet line in front, as it acts as a lubricant and decreases

the efficiency and protection of the helmet. Any infractions may result in disqualification of individuals.

- H. When an official's warning of improper helmet positioning prior to the start of a speed skating race is not immediately corrected, that skater must be disqualified.
- I. The use of a chin cup for speed skaters is highly recommended.
- J. All speed skating contestants must have their approved helmets on and securely fastened at all times while on the skating surface. After the contestant finishes their race and crosses the finish line, then inadvertently unbuckles their helmet, the referee shall verbally warn the skater and require that the skater immediately refasten the buckle. If the skater fails to refasten the buckle or unbuckles the helmet a second time, the skater will be disqualified. The warning would only apply to that race and would not carry over to the next race.

SR361.12 The use of gloves is permitted in sanctioned speed skating contests. If a contestant chooses to wear gloves, the gloves must be of a bicycle or racket sports type, preferably with fasteners at the wrist which are fastened.

SR361.13 The use of eyeglass safety straps is mandatory in sanctioned speed competition. Elastic sport eyeglass safety straps must be fastened tightly around the head without excess strap length. Eyeglass wearers must have plastic lenses, not glass, in their eyewear.

SR361.14 No hair accessories of any type other than protective headgear may be worn by a contestant during a competition, except that contestants may tie back their hair with a ribbon or elastic hair bands. No hairpins of any type may be used. Headbands and bandanas are optional, and if worn, must be completely under the helmet.

SR361.15 All members of a relay team must have uniforms of identical color and design for championship events. Failure to comply will be cause for refusing to allow the affected team to compete. The relay numbers are to be supplied by the host operator.  
**NOTE:** Speed skating helmets for relay skaters do not have to match. Helmets will be considered as equipment and not part of the uniform and, thus, are not subject to conforming to the rule which states that uniforms for relays must be identical. However, relay team members must have identical placement of sponsorship logos on the uniform, as there is no limit on the physical size or number of such sponsorship identifications.

## **SR370 SKATES**

### **SR371 The following are requirements for all USARS sanctioned competitions:**

SR371.1 Skate plates must be bolted securely to the skating shoe or boot.

SR371.2 Use of metal or wood wheels is expressly forbidden. Only wheels composed of a plastic or fiber are permitted.

SR371.3 Toe stops must be in good repair and have no bolts or other metal objects protruding from them that will touch the floor in any manner.

SR371.4 Wheel coatings or traction substances may not be painted on or otherwise applied to the wheels used at USARS sanctioned contests. Roller skating wheels of solid or laminated wooden construction are prohibited in all events. Wooden construction is not permitted in either hub or tread design.

SR371.5 The use of speed wheels, 110mm or smaller, is also required at any outdoor speed skating event designated as the USARS sanctioned National Trials for the FIRS World Championships and/or the Pan American Games. At the present time, this includes both the National Banked Track Championships and the National Road Championships.

SR371.6 If a contestant reports to the starting line wearing improper skates or wheels, he or she is subject to disqualification from the race.

**SR380 CONTESTANT NUMBERS - INDOOR AND OUTDOOR COMPETITIONS**

SR380.1 Regional associations, speed leagues, and/or event hosts shall be responsible for providing competitor numbers for all speed events. One number shall be displayed on the uniform trunks over the left hip, the other number on the trunks over the right hip, so as to be plainly visible to the officials during races. The numbers may be pinned on competitor uniforms.

SR380.2 For the Outdoor National Championships, the speed skating competitors will be assigned numbers, compatible with the photo timing device, in order to provide identification. The number placement shall be designated by the Chief Referee.

SR380.3 When relay numbers are supplied to contestants at the meet site, they shall be pinned on the uniform trunks over the existing contestant numbers. The numbers must be pinned securely at all four corners.

SR380.4 Helmet covers are approved for relay events in the place of or in conjunction with relay numbers.

**SR390 PERSONAL SAFETY**

SR390.1 Contestants will not be permitted to wear jewelry of any kind during races. The only exceptions are as follows: a) Weddings bands-if the band has any sharp projections, such as diamonds or projections in the design of the band, the band shall be taped. b) Any religious medals around the neck must be taped to the chest or safety pinned to the uniform. c) Medical necklaces or bracelets are allowed.

SR390.2 Contestants will not be permitted to wear medals, awards, good luck charms, bells, pompoms or any other objects on their skates or uniforms. (Boot covers eliminated from restrictions.)

SR390.3 Contestants will not be permitted to carry any food or drinks onto the skating surface at any time during the conduct of the meet.

SR390.4 If the contestant's uniform has pockets, the pockets must be empty when the contestant presents himself or herself at the starting line for a race.

SR390.5 Contestants applying any type of analgesic balm, cream or ointment must tape or wrap the treated area of skin before coming to the starting line.

SR390.6 Contestants will not be allowed to carry, in their hand or inside their uniform, any electronic device onto the skating track or center of the track at any time during the conduct of the meet.

**SR395 Uniform Inspection**

Should a skater report to the starting line wearing an improper uniform or improper skate wheels, safety gear or helmet, the referee may disqualify the skater or may request that he or she change the offending item before the race begins. If the skater refuses to change, the referee will report the infraction to the meet director who may suspend the skater for the remainder of the meet.

**SR400 ELIGIBILITY**

**SR401 Regional Championship Eligibility**

Contestants and contestant teams entering a regional championship must conform to the residence regulations outlined in USARS General Rule 7.03.

**SR402 National Championship Eligibility**

A. Other than the Quad Nationals and the Outdoor Road & Track Nationals, contestants and contestant teams entering a national championships will have qualified in a regional championships by placing first, second, third or fourth, will have qualified by virtue of being current defending national champion in that division, or qualified through the Alternate Entry Qualification (see SR 404).

B. When only one skater or team is entered in an event at a Regional Championship, that skater or team automatically will qualify for the National Championships without being required to skate the Regional Championships. Regional entry fees for the event must be paid. The Meet Director must notify the skater within 5 days after the 30 day regional deadline. The skater will have the option to skate (either the entire distance or the one lap qualifier) or not to skate that event at the Regional Championships.

**SR403 Outdoor National Speed Championship**

For purposes of safe track conditions, competitors for the Banked Track Nationals must have successfully participated in an approved USARS Banked Track Clinic wherein they met or exceeded the minimum track qualifying times for their age division. The Road Championships does not require pre-qualifying through an approved clinic.

**SR404 Elite Inline Indoor Individual National Qualifications - Alternate Entries**

Time will be scheduled before the official practice to run qualifying races for the empty slots in the Elite Inline Indoor Individual divisions. World Class events are excluded from this procedure. The slots will be posted after each regional championship turns in their official results. The information will be available for viewing on the USARS official website ([www.usarsrollersports.org](http://www.usarsrollersports.org)).

**SR404.1 Qualifications**

In order to enter the qualifier the contestant must be a member in good standing of USARS and have entered their respective regional championship contest. The contestant must not have been the subject of a meet disqualification during their respective regional championship contest. The contestant will pay the standard entry fee for an individual event that they entered at the regional championships for the National Championships (The regional entry division and National entry division must be exactly the same). The interested skaters will be required to enter the qualifier on their team entry form and in accordance with the entry deadline.

Example of the procedure:

Senior Men National Championship Qualifiers

Northeast Region (A) 1 entry

Eastern Region (B) 3 entries

Southeast Region (C) 4 entries

Southern Region (D) 3 entries

Great Lakes Region (E) 3 entries

North Central Region (F) 1 entry

South Central Region (G) 2 entries

Northwest Region (H) 4 entries

Southwest Region (I) 2 entries

Total available slots are 13 (A2, A3, A4, B4, D4, E4, F2, F3, F4, G3, G4, I3, and I4)

A. If less skaters enter than there are slots available, no race will be run, the skaters will draw, in the order their entry was received, from the pool of available slots. The skaters will be seeded in to heats at the National Championships based on this draw. If more skaters enter than there are slots available they will race the middle distance of their division.

B. If the group is less than the maximum number allowed on the starting line by USA/RS speed rules, they will draw for starting position and race their middle distance. They will be electronically placed as they cross the finish line. Skaters placing first to (X) will qualify for the open slots (X plus first place shall always equal the number of available slots). Qualifiers shall draw from the pool of available slots based on placement from first to (X) in their order of finish. The skaters will be seeded into heats at the National Championships based on this draw.

C. If the group is more than the maximum allowed on the starting line by USA/RS speed rules, they will be divided as evenly as possible into race groups according to the USA/RS rules governing the number of skaters on the line by floor size. Once the number of groups is determined the skaters will draw their group assignments. Each group will race their middle distance . . . First place in each group and the next (X) fastest times will qualify for the open slots (X plus the first places in each race shall always equal the number of available slots). The qualifiers will draw from the pool of available slots based on their race times. All qualifiers will be placed in order fastest to slowest and they will draw for available slots in that order. If there is a tie in times between qualifying skaters, the tied individuals will toss a coin to determine who gets first pick between the tied skaters. The skaters will be seeded into heats at the National Championships based on this draw.

If there is a tie for a qualifying position, the tied skaters will be required to re-skate their middle distance, the first place skater in this event will become the qualifier.

**SR410**

**WAIVER TO NEXT HIGHER CHAMPIONSHIPS**

USARS Headquarters may grant permission for skaters to advance to the next higher championships when they were unable to skate a Regional Championship if the following conditions are met:

- A. They must be eligible to skate in that classification of competition.
- B. They must be entered into the preliminary championships through proper application and with all applicable fees paid.
- C. To draw a "bye" in the contest in question, there must be no more than the maximum number of participant/team entries in the contest advancing to the next higher championship round including the participant/team requesting the "bye". From regional to the nationals, only four qualify, so this number would be four.

D. In the case of a fours relay team, it is not possible for the other three team members to skate as a trio, however, they must be registered with appropriate fees paid and available to skate at the time their event is scheduled.

E. The basic criteria in this waiver is full intention of the contestant to skate. This is why the individual must be registered in the contest, paying all the fees as a show of good faith that they actually intended to be in the contest.

F. Obtaining a waiver or "bye" from an official regional championships does not constitute placement and no medals shall be awarded.

G. The highest open placement available must be awarded at any official contest leading to and including the national championships.

H. The granting of a waiver or "bye" to the next higher championship is at the sole discretion of the USA Roller Sports Executive Director. All completed requests must be submitted on the proper Waiver Request Form and received at the USARS National Headquarters within 24 hours of the conclusion of the appropriate regional championship competition.

#### **SR420 DEFENSE OF TITLE**

A. Skaters who have placed first in a National Championship event the preceding year are not required to enter any preliminary to the championship in which they won their title the following year, provided:

1. They are again eligible for that same event.
2. They remain bona fide USARS registered member roller skaters.

B. However, if said champions should elect to enter the preliminaries, they must from then on win their way into the higher brackets of championship competition.

C. Elimination in a lower level of championship competition would cancel all rights to automatic qualification for the higher level championships.

#### **SR430 Voluntary Withdrawals**

A. If a contestant or team finds it impossible to continue into the next level of competition within the competitive year, a place shall not be open to any fifth place winner, except in the case where a placing contestant or team is disqualified or where special allowances are authorized.

B. A contestant's placement into a final event must be earned. In cases when a position in finals is vacated for any reason after qualifying in an elimination, no subsequent finalists shall be inserted.

#### **SR440 USARS WORLD SPEED TEAM SELECTION**

FIRS speed competitions are held outdoors in both track and road; thus, the selection process for Team USA is based on the National Banked Track and Road Championships. The selection process will be governed by the selection procedures printed in the Speed Rule Book and conform to the distances used in the World Championships. ~~USARS will fund the participation of a coach, a manager, a trainer or doctor, pay the entry fee and provide uniforms and warm-ups for up to 24 team members, plus staff. All other~~ Expenses will be the responsibility of the individual athlete or their sponsors.

#### **SR441 Senior World Speed Championships Team Selection**

The Senior Men and Senior Women's World Speed Team may each consist of six men and six women. The following point value will be awarded for each distance: 15 points for first place, 12 points for second place, 10 points for third place, 8 points for fourth place, 6 points for fifth place, 4 points for sixth place, 3 points for seventh place, and 2 points for eighth place. Points awarded for 5<sup>th</sup> to 8<sup>th</sup> in 500m Track and Road by placement race. To be eligible, athletes must be at least fourteen (14) as of January 1, of the current competitive season.

- SR441.1 Senior World Team - The Senior World Team shall include the following athletes:
- "A" Position, highest total points in the 200m and 300m
  - "B" Position, highest total points in the 200m, 300m and 500m track and road
  - "C" Position, highest total points in the Points Elimination, Points, and Elimination races track and road, Track 10K Points Elimination, 15K Elimination, Road 10K Points, 20K Elimination
  - "D" Position, highest total points on the Track
  - "E" Position, highest total points on the Road
  - "F" Position, highest number of points in all races after the selection of the above five skaters
- See section SR921.9 and SR921.10 for tie breaking formulas.
- SR441.2 In the event that one or more of the above positions are declined by the athlete or an athlete is unable to attend, the USARS Speed Committee will determine the replacement, if any, of that skater with emphasis being placed on the position being vacated.
- SR441.3 Event participation at the World Championships is the responsibility of the team coach. The team coach is responsible for determining the final starting position. Written evaluation records shall be used in this determination and shall include their performance at the Outdoor National Championships, residency, and practice on-site just prior to the World championships.
- SR442 Junior World Speed Championships Team Selection**
- The Junior Men and Junior Women's World Speed Team may each consist of six men and six women. The following point value will be awarded for each distance: 15 points for first place, 12 points for second place, 10 points for third place, 8 points for fourth place, 6 points for fifth place, 4 points for sixth place, 3 points for seventh place, and 2 points for eighth place. Points awarded for 5<sup>th</sup> to 8<sup>th</sup> in 500m Track and Road by placement race. To be eligible athletes must be at least fourteen (14) but not yet nineteen (19) as of January 1, of the current competitive season.
- SR442.1 Junior World Team - The Junior World Team shall include the following athletes:
- "A" Position, highest total points in the 200m and 300m
  - "B" Position, highest total points in the 200m, 300m and 500m track and road
  - "C" Position, highest total points in the Points Elimination, Points, and Elimination races track and road, Track 10K Points Elimination, 15K Elimination, Road 10K Points, 20K Elimination
  - "D" Position, highest total points on the Track
  - "E" Position, highest total points on the Road
  - "F" Position, highest number of points in all races after the selection of the above five skaters
- See section SR921.9 and SR921.10 for tie breaking formulas.
- SR442.2 In the event that one or more of the above positions are declined by the athlete or an athlete is unable to attend, the USARS Speed Committee will determine the replacement, if any, of that skater with emphasis being placed on the position being vacated.
- SR442.3 Event participation at the World Championships is the responsibility of the team coach. The team coach is responsible for determining the final starting position. Written evaluation records shall be used in this determination and shall include their performance at the Outdoor National Championships, residency, and practice on-site just prior to the World championships.



- SR443 USA World Speed Team Injury Plan**
- A. Skater must be a USARS member in good standing.
  - B. Skater must have written proof of injury from physician to USARS Executive Director.
  - C. Skater must be a world medalist the previous year in a Junior or Senior individual division.
  - D. Two-thirds of the participants in the qualifying event at World Team Trials must approve by secret ballot the inclusion of the injured athlete in the residency program.
  - E. Skater must attend residency program at his or her own expense to try to qualify in the five races on the track and four races on the road against all same gender in nine races.
  - F. Athlete must have entered the Outdoor National Championships and paid the appropriate entry fee(s).

**SR 500 CONDUCTING CHAMPIONSHIPS**

- SR 501 Site Selection and Conduct of a Qualifying or Regional Championship**
- Public skating sessions, matinee or evening, shall not be conducted during the scheduled events of a qualifying championship without the consent of the majority of interested clubs in the affected state or regional USARS association. With such consent, a qualifying championship host may insert public skating sessions in the program which do not interfere with or unduly prolong the schedule of the championships.

- SR502 Indoor Speed Skating Surface** - A minimum unobstructed skating surface of 70' wide x 170' long must be used at qualifying speed championship meets to conform to the 100-meter track. The skating surface must be plastic coated, in excellent condition, and must be clean. All speed track markings are to be accurate and clearly visible. Wheel coatings or traction substances may not be painted on or otherwise applied to the wheels used at official qualifying or national championships.

**SR503 Conduct for Competitions**

- A. Tactics by contestants, officials or organizers which have a tendency to associate any competition with a commercial promotion not directly approved by USARS will not be tolerated.
- B. Contestants must bear in mind at all times that their conduct must be above reproach. At no time are they excused from the athlete code of conduct:

"I will learn the rules and regulations of the USA Roller Sports and observe them in spirit as well as in letter. I will always try to uphold the ideals of competitive roller skating by demonstrating high standards of sportsmanship and good behavior, and by being courteous in word and action to teammates, opponents, officials, coaches and spectators. When traveling to or from competitions and while participating in them, I will remember at all times that I am a representative of my sport."

- SR503.1 Contestants are bound to obey implicitly the instructions and decisions of the officials in charge of the competition.
- SR503.2 The decision of a speed skating official is final. Protests which challenge official decisions will not be accepted. (For definitions and procedures for protests, refer to USARS General Rules.
- SR503.3 Whether before, during or after a competition, contestants are subject to a conduct protest if they publicly express lack of respect for the organizers, officials or their decisions.

SR503.4 Severe Acts – Use of profanity or striking another skater, an official or a spectator; or other actions in direct violation of the Athlete Code of Conduct, will be dealt with most severely. The referee may recommend to the meet director the immediate suspension of the skater from the remainder of the competition, as well as removal of that skater from the facility. Using the proper USARS form for protest, the meet director must report the conduct of the skater to the Membership Eligibility Committee through the USARS National Headquarters.

**SR504 Procedure for Indoor Competitions (except Indoor Elite Inline Nationals, see SR837)**

In roller speed skating competition, contestants race in packs on an oval track marked by pylons. Races are run only in a counterclockwise direction. The distances which contestants race are determined by age division. Individual champions in a division are determined by the placements they earn in the final race of each distance skated. Races are officiated by referees who skate with the pack and by stationary corner referees who assist the referees.

**SR505 Eliminations, Semi-finals and Finals**

SR505.1 The number of contestants permitted on the starting line (and the number of contestant teams permitted in the gate area) for any given size track during championship competition is left to the discretion of the referee as is the number of contestants or contestant teams in each heat or semi-final that will qualify to skate the semifinals or final; provided, however, at regional championships, the heat's are to be arranged so as to divide the field as evenly as possible into the minimum number of heats that are consistent with no more than seven (7) skaters being permitted on the starting line. An equal number of finalists shall be taken from each of these heats in order to qualify the maximum allowable for the final event.

SR505.2 At the indoor national championships, speed events shall be conducted by eliminations, quarter finals, semi-finals, and finals as the size of the entry requires. The following criteria will be used:

SR505.3 Elimination heats shall be skated when there are 25 or more skaters entered in the race. There shall be four heats with three skaters qualifying for semi-finals from each heat. When there are 15 to 24 skaters entered in the race, there will be three heats with four skaters from each heat qualifying for semi-finals. When there are 7 to 14 skaters entered in the race, there will be two heats with three skaters from each heat qualifying for the finals and no semi-finals are required. In events of 33 or greater, quarterfinals will be used. Only one starting line will be permitted.

SR505.4 Semi-finals shall consist of 2 heats of 6 skaters with 3 skaters qualifying for finals from each heat. The following procedure was adopted for use at the national championships for seeding qualifiers from elimination heats into semi-finals: semi-finals 1 will consist of placements from heats 1 and 4; semi-finals 2 will consist of placements from heats 2 and 3. If only 3 qualifying heats are needed, semi-finals 1 will consist of placements 1, 2, 3 and 4 from heat 1, and placements 2 and 3 from heat 2. Semi-finals 2 will consist of placements 1 and 4 from heat 2, and placements 1, 2, 3 and 4 from heat 3.

SR505.5 At Regional and National Championships, finals will consist of six (6) skaters/teams unless the total entry in the division is seven (7) or less, in which case the events will be declared a final, without eliminations or semi-finals needed.

SR505.6 At all competitions including regional and national championships, only one starting line is permitted. The number of contestants permitted on that line-up to a maximum of seven skaters-is left to the discretion of the referee. The number of contestants or contestant teams in each

elimination heat or semi-final that will qualify to skate the semi-final or final is left to the discretion of the referee.

SR505.7 For all events other than a regional qualifying event, if there is only one skater or contestant team entered in a division, that contestant, at the discretion of the referee must skate at least one lap in one distance.

SR505.8 At the recommendation of the Speed Skating Committee, USARS will allow the open-type race with up to 18 skaters on the track at one time, restricted to league and invitational contests only, provided that a rolling start is used, with the referee leading a pace lap or laps, on the inside of the track, to the timing line. Skaters would draw for order of skating on the pace lap.

SR505.9 The 3 person relay will have a maximum of 2 rounds which are qualifiers to skate the 3 person final. An elimination heat and or semi final heat. Only the winners of each heat proceeds directly to the next round or the final. The other skaters are qualified by the times they received in each of those heats to proceed to the next round or the final.

3 person relays  
6 into final unless to start there are 7 teams then 7 will skate the final

# of Teams	Heats				Semi Final			Final
	Heats	Place	Time	Teams to Qualify	Heats	Place	Time	# in final
7								7
8 - 14					2 * 6-7	1	4	6
15 - 21					3 * 6-7	1	3	6
22 - 28	4 * 6-7	1	8	12	2 * 6	1	4	6
29 - 35	5 * 6-7	1	7	12	2 * 6	1	4	6
36 - 40	6 * 6-7	1	6	12	2 * 6	1	4	6
41 - 45	7 * 6-7	1	5	12	2 * 6	1	4	6

**SR510**

**SEEDING**

The entry for each division at the national championships will be divided so that, as nearly as possible, the same number of first place regional skaters, the same number of second place regional skaters, the same number of third place regional skaters and the same number of fourth place skaters are placed in each heat.

SR510.1

The regions will be listed in order as determined by the total number of placements received by the region at the previous year's national championships. Points are awarded by 30 for first, 20 for second, 10 for third and 5 for fourth. Each region will then be assigned an alphabetical letter. The region with the highest number of points is assigned the letter "A", the region receiving the second highest number of points is assigned the letter "B" and so on. The first, second, third and fourth place regional skaters will be indicated by a 1, 2, 3 or 4 next to the assigned alphabet letter.

SR510.2

Seeding Indoor Speed Events

Skaters will be seeded into two, three, four or five heats, depending on number of contestants entered.

A. For seeding into five heats, the following formula will be used:

<u>Heat 1</u>	<u>Heat 2</u>	<u>Heat 3</u>	<u>Heat 4</u>	<u>Heat 5</u>	
A1	B1	C1	D1	E1	
F1	G1	H1	I1	A2	
B2	C2	D2	E2	F2	
G2	H2	I2	A3	B3	
C3	D3	E3	F3	G3	
H3	I3	A4	B4	C4	
D4	E4	F4	G4	H4	
I4					

B. For seeding into four heats, the following formula will be used:

<u>Heat 1</u>	<u>Heat 2</u>	<u>Heat 3</u>	<u>Heat 4</u>
A1	B1	C1	D1
E1	F1	G1	H1
I1	A2	B2	C2
D2	E2	F2	G2
H2	I2	A3	B3
C3	D3	E3	F3
G3	H3	I3	A4
B4	C4	D4	E4
F4	G4	H4	I4

C. For seeding into three heats, the following formula will be used:

<u>Heat 1</u>	<u>Heat 2</u>	<u>Heat 3</u>
A1	B1	C1
C2	A2	B2
B3	C3	A3
A4	B4	C4
D1	E1	F1
F2	D2	E2
E3	F3	D3
D4	E4	F4
G1	H1	I1
I2	G2	H2
H3	I3	G3
G4	H4	I4

D. For seeding into two heats, the following formula will be used:

<u>Heat 1</u>	<u>Heat 2</u>
A1	B1
C1	D1
E1	F1
G1	H1
I1	A2
B2	C2
D2	E2

F2	G2
H2	I2
A3	B3
C3	D3
E3	F3
G3	H3
I3	A4
B4	C4
D4	E4
F4	G4
H4	I4

- SR510.3 Any changes required to equalize heats will be accomplished by shuffling the fourth place regional skaters, when possible, then move to the third place skaters, etc. Effort will be made to avoid placing skaters from the same team into the same heat, but it is not possible to avoid putting skaters from the same region together.
- SR510.4 In divisions in which a defending champion is skating, he or she will be seeded into the heat with the fourth place skater from his or her region.
- SR510.5 Seeding Qualifiers From Heats Through Finals

**5 Heats Advancing to Quarterfinals (4 Qualify to 3 Quarterfinals)**

From Heat 1 to QF	From Heat 2 to QF	From Heat 3 to QF	From Heat 4 to QF	From Heat 5 to QF
1 <sup>st</sup> – Q1	1 <sup>st</sup> – Q2	1 <sup>st</sup> – Q3	1 <sup>st</sup> – Q3	1 <sup>st</sup> – Q2
2 <sup>nd</sup> – Q1	2 <sup>nd</sup> – Q1	2 <sup>nd</sup> – Q2	2 <sup>nd</sup> – Q3	2 <sup>nd</sup> – Q3
3 <sup>rd</sup> – Q2	3 <sup>rd</sup> – Q1	3 <sup>rd</sup> – Q1	3 <sup>rd</sup> – Q2	3 <sup>rd</sup> – Q3
4 <sup>th</sup> – Q3	4 <sup>th</sup> – Q2	4 <sup>th</sup> – Q1	4 <sup>th</sup> – Q1	4 <sup>th</sup> – Q2

**5 Heats Advancing to Quarterfinals (Computer Entry)**

Heat 1: 1<sup>st</sup>, 2<sup>nd</sup> > Q1, 3<sup>rd</sup> > Q2, 4<sup>th</sup> > Q3  
 Heat 2: 1<sup>st</sup>, 4<sup>th</sup> > Q2, 2<sup>nd</sup>, 3<sup>rd</sup> > Q1  
 Heat 3: 1<sup>st</sup> > Q3, 2<sup>nd</sup> > Q2, 3<sup>rd</sup>, 4<sup>th</sup> > Q1  
 Heat 4: 1<sup>st</sup>, 2<sup>nd</sup> > Q3, 3<sup>rd</sup> > Q2, 4<sup>th</sup> > Q1  
 Heat 5: 1<sup>st</sup> > Q2, 2<sup>nd</sup>, 3<sup>rd</sup> > Q3, 4<sup>th</sup> > Q2

**4 Heats Advancing to Semifinals (3 Qualify to 2 Semifinals)**

From Heat 1 to Semi	From Heat 2 to Semi	From Heat 3 to Semi	From Heat 4 to Semi
1 <sup>st</sup> – S1	1 <sup>st</sup> – S2	1 <sup>st</sup> – S2	1 <sup>st</sup> – S1
2 <sup>nd</sup> – S1	2 <sup>nd</sup> – S2	2 <sup>nd</sup> – S2	2 <sup>nd</sup> – S1
3 <sup>rd</sup> – S1	3 <sup>rd</sup> – S2	3 <sup>rd</sup> – S2	3 <sup>rd</sup> – S1

**4 Heats Advancing to Semifinals (Computer Entry)**

Heat 1: 1<sup>st</sup>-3<sup>rd</sup> > S1  
 Heat 2: 1<sup>st</sup>-3<sup>rd</sup> > S2  
 Heat 3: 1<sup>st</sup>-3<sup>rd</sup> > S2  
 Heat 4: 1<sup>st</sup>-3<sup>rd</sup> > S1

**3 Heats or Quarterfinals Advancing to Semifinals (4 Qualify to 2 Semifinals)**

From Heat 1 to Semi	From Heat 2 to Semi	From Heat 3 to Semi
1 <sup>st</sup> – S1	1 <sup>st</sup> – S2	1 <sup>st</sup> – S2
2 <sup>nd</sup> – S1	2 <sup>nd</sup> – S1	2 <sup>nd</sup> – S2
3 <sup>rd</sup> – S1	3 <sup>rd</sup> – S1	3 <sup>rd</sup> – S2
4 <sup>th</sup> – S1	4 <sup>th</sup> – S2	4 <sup>th</sup> – S2

**3 Heats or Quarterfinals Advancing to Semifinals (Computer Entry)**

Heat 1: 1<sup>st</sup>-4<sup>th</sup> > S1

Heat 2: 2<sup>nd</sup>, 3<sup>rd</sup> >S1, 1<sup>st</sup>, 4<sup>th</sup> > S2

Heat 3: 1<sup>st</sup>-4<sup>th</sup> >S2

**SR520 SKATER CHECK-IN**

SR520.1 Contestants will inform themselves of the times at which they are to compete and will be solely responsible to report promptly before the start without being further notified.

A. With the exception of the first daytime or evening events, all skaters must be ready to compete at least one hour before the scheduled time of the event. **Events can run up to one hour ahead of time.**

SR520.2 Registration in a contest does not necessarily constitute check-in. Contestants must check in with the competitive steward at the designated check-in times scheduled, posted or announced.

SR520.3 Contestants in a division may choose not to compete in all divisional distances and still maintain the points earned in other distances.

A. Failure to report for a specific distance does not necessarily constitute withdrawal of the contestant

B. If any member of a relay team is unable or ineligible to skate, or is refusing to skate, the team's withdrawal is required unless a substitute is made in compliance with the substitution rule. Also see SR164.

**SR530 SKATER STAND-BY AREAS**

Chairs may be placed in the center of the skating surface for use of the next group of skaters to race. A second group may be placed at an end of the skating floor for the following group of skaters. The Meet Director shall coordinate the stand-by areas with the meet host.

**SR540 RESTRICTED ACCESS TO TRACK, OFFICIATING AND STAND-BY AREAS**

Only administrators, referees, starter, timers, place judges, corner referees, stewards and tabulators will have access to the ready area, competitive skating area, stand-by area, timing, scoring and place judges area for the discharge of their official responsibilities, which are subject to the directions of the meet director. No other persons shall have access to these areas, unless specifically authorized by the meet director.

**SR550 STARTING LINE POSITION**

SR550.1 Drawing - The drawing for starting line position for each indoor speed event (and lane number in the gate area, for relays) shall be done under the supervision of the competitive steward, or assigned by pill draw in the middle of the floor.

SR550.2 When a race is called, contestants will proceed immediately to the four feet (4') setback line in the order drawn. The lowest number in the draw is the starting position toward the inside of the track, progressing to the highest number toward the outside of the track.

Relay teams will proceed immediately to their assigned lanes in the gate area. The highest number in the draw is the lane nearest the starting line. Lead-off skaters in relays will take their starting line positions in the order drawn as described above. Remaining team members will stay in their assigned lane in the gate area until they relieve a skater on the track.

## **SR560 STARTING PROCEDURE**

SR560.1 At the command "TO YOUR MARK," skaters move forward to the starting line in a preliminary starting position. A preliminary starting position is:

- A. standing up; or,
- B. in a four-point position with two hands, one knee and one foot on the floor (a standard track start).
- C. in a 3 point position with one hand, one knee and one foot on the floor.

SR560.2 At the command "SET," skaters immediately assume their final starting position and **MUST REMAIN STATIONARY UNTIL THE GUN IS FIRED**. Any movement after the command will cause the offending skater to be penalized for a false start.

SR560.3 A final starting position is:  
A. a "crouch" if using the stand up preliminary position (the skater will not be permitted to drop to the floor); or,  
B. coming up off the knee while keeping one or both hands on the floor (if using the track start).  
No portion of the skater or equipment may touch the floor on or ahead of the starting line.

SR560.4 In the event of a false start, the offending skater or skaters will move to an eight foot (8') setback line in their proper lane position before the starting procedure resumes. At the command, "To your mark," this skater or these skaters move forward to the four foot (4') setback line only, not to the starting line.

SR560.5 When a skater starts before the gun has sounded, it will be considered a false start. Two false starts by the same skater will result in his or her disqualification from the race.

SR560.6 Any deviation from the starting procedure, excluding a false start, will result in a warning to the entire group in that particular race. After the warning in that particular race, any deviation from the starting procedure will be penalized the same as a false start.

## **SR570 RELAY PROCEDURES**

Relay racing includes events for two, three and four person teams. One skater begins on the track while the remaining member or members of the team wait at the center of the track in the designated gate area. When a relay is to be made, the next skater leaves the gate area and skates the inside of the track slightly ahead of his/her teammate, rolling into position for a push or tag from the teammate finishing the relay lap.

SR570.1 In relay races, a relay is accomplished by body contact between members of the team (touching of hands is considered body contact). A relay from one skater to another is usually accomplished by the push method. The push method employs a vigorous push with one or both hands placed

on the lower back of the skater receiving the relay. As each skater completes the required number of laps, he or she may touch, tag or push the next skater on the team who may come in to receive the relay from a flying start. The whip or pull-through relay is prohibited.

SR570.2 In four-person and three-person relays, the person about to receive a relay must leave the gate area from his or her team's lane and skate the inside of the track. Once a skater in either a four-person, three-person or two-person relay has left the gate area, **he or she must enter the race immediately within the relay zone**. In two-person and three-person relays, once the race has started, the skaters are not to be confined to a lane in the gate area, but are restricted to the boundary of the gate area until his/her partner begins the relay lap. A contestant must enter the gate area from the rear and leave from the front. The gate area must be clearly designated. It is each skater's responsibility to count his or her laps during relay races.

SR570.3 When a skater has been relieved, he or she must immediately move to the **outside barrier** of the track **without blocking** and continue on the skating surface to the end of the floor. The skater may exit the skating surface if an exit is located in that area. If no exit is available, the skater must remain at the end of the track until the race is completed.

SR570.4 In relays in which the relieved skater must skate again, he or she must leave the track in the same manner and return to the gate area in as direct a course as is possible, crossing the track between pylon 1 and pylon 2, in such a manner as not to obstruct or interfere with skater then on the track. A skater is considered to be returning to the gate area the moment when he or she has crossed the imaginary straight line between pylons 1 and 2. Upon completion of his or her final distance, a skater must leave the track. The final finishing skater may remain on the track provided that they do not interfere with any other skaters still competing on the track.

SR570.5 If a member of a relay team has committed a foul, he or she must also leave the track in the manner described above. The remaining members of the team are not eligible for further participation in the event.

SR570.6 Skaters in all relay races must realize that there are officials on the inside of the track. It is the skater's responsibility to avoid contact with these officials when entering or leaving the relay gate area.

SR570.7 Skaters are allowed to make skate or wheel repairs only at the pylon 1 and 2 end of the floor and only in the time available prior to their next required relay. Skaters may also wait or pause in this area prior to returning to the gate area.

## **SR580 INTERRUPTION OF SKATING (BROKEN SKATE RULE)**

SR580.1 When a contestant interrupts his or her skating for any reason including illness, uniform failure, or mechanical failure of the skates, etc., he or she shall be disqualified from the race being skated.

SR580.2 During the running of a race, mechanical failure may, at the discretion of the Chief Referee, eliminate the contestant from the race if this imposes a danger to others, but in no instance will the race be stopped or rerun to accommodate repair or replacement.

SR580.3 When a breakage occurs during a race warm-up, a false start, or during a race which is subsequently stopped for a restart, the Chief Referee shall have the authority under this rule to allow the damage to be corrected. The Chief Referee may accomplish this by rescheduling the race



to a later time in the program or delaying continuation of the events. In either instance, this will not exceed 15 minutes.

SR580.4 In the event of an illness during warm-ups, the Chief referee may, at his discretion, limit the skater to a 15-minute recuperation period. If the skater cannot continue after the 15-minute period, he or she shall be disqualified.

SR580.5 Any contestant who, in the opinion of the Chief Referee, endeavors to obtain unfair advantage over an opponent through manipulation of this rule, shall forfeit his or her right to continue to compete in the race in question.

#### **SR590 VIDEO REPLAY**

Video replay can be utilized at the indoor national championships for "team fouls" and "technical fouls"

for clarification. The only video permissible will be from the official video supplier of the indoor national championships. In order for a foul to be overturned, the video evidence must be conclusive.

SR590.1 No video review will be allowed at any national championship of a non-team foul (officials decisions SR503.2) for any reason.

#### **SR600 FOULS**

SR600.1 Fouling Disqualification-If a skater has committed a foul, the referee may call the skater out immediately or allow him or her to continue in the race and announce the disqualification after the race is finished. All disqualifications must be turned into the chief placement judge before the next race or the disqualification will be nullified. If a skater refuses to leave the track when ordered out by a referee, the referee may recommend to the meet director the immediate suspension of the skater from the remainder of the speed competition.

SR600.2 Fouls will be classified as follows:

#### **SR610 TECHNICAL FOULS**

Technical fouls are violations of track rules or procedures for divisions and relays such as:

SR610.1 Skating inside of, intentionally touching, knocking down or straddling a corner marker. Straddling the pylon is defined as occurring when a skater has one skate on the floor outside the pylon and one or more wheels of the other skate touching the floor inside the pylon.

SR610.2 If, in the opinion of the referee or corner referee, the pylon was hit accidentally and there is no repetition of the act, or if a skater is ridden inside the pylon by the disqualifying act of another skater, there may be no penalty.

SR611.3 A skater may not take unfair advantage of another because a pylon is off its respective mark by skating to the inside of the track.

SR611.4 If a contestant has knocked three pylons during a division race, the referee may disqualify the skater from the race. If a team has collectively knocked four pylons during a relay race, the referee may disqualify the team from the race. A skater or team is penalized for knocking a pylon if they can be clearly identified as striking the pylon and the pylon comes to rest completely outside the boundaries of the pylon box. The corner referee should replace the pylon and report the incident, noting the contestant or team number that struck the pylon and the corner where it was struck. If the skater or team cannot be definitely identified, the corner referee must replace the pylon and no contestant or team will be penalized. (See diagram below)

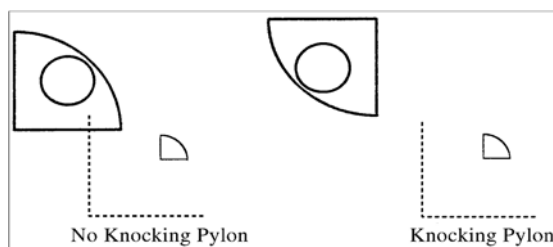

**SR612 “Distanced” Disqualifications**

SR612.1 A skater in any race must keep within one lap of the leader or leaders. When about to be lapped by said leader or leaders, the skater may be declared “distanced” and called out of the race by the referee, unless the skater is still in position to place.

SR612.2 A skater will be considered lapped when the leader or leaders are in a position to pass him or her. It is not necessary to actually be passed by the leader in order to be moved out by the referee. Before trying to improve their position, skater or skaters being lapped must remain in their position until the leading skater or skaters have passed.

SR612.3 Right of Way-When a leading skater is about to lap another, the lapped skater must move to the right (outside) of the track, giving inside right-of-way to the leading skater. When lapping a skater, the lead skater is not permitted to interfere in any way with the progress of the lapped skater.

SR612.4 It is the lead skater’s responsibility to pass a lapped skater safely without interfering with the skater being passed, whether or not a referee is present to move the lapped skater over.

**SR613 False Start** - Two false starts by the same skater in a race;

**SR614 Profanity**

**SR616 Delaying the start of a race** or the start of a contest by actions causing other skaters on the starting line to jump the gun;

**SR617 Loafing.** All athletes must take part in races fairly and enthusiastically. Skaters deliberately slowing the pace down, may be excluded from the race after receiving a warning by the referee.

**SR620 Personal fouls** - violations involving action of one skater against another such as:

SR620.1 Blocking - A skater must follow a reasonably straight course in skating the straightaway in a race. Blocking by shuttle skating (excessive weaving) or blocking by two contestants skating shoulder

to shoulder (or intentional impeding the progress of another skater) will subject the offender to disqualification.

- SR620.2 Hipping;
- SR620.3 Tripping;
- SR620.4 Holding;
- SR620.5 Riding In - contestant's body contact from the outside of the track forcing another skater from the line of travel;
- SR620.6 Riding Out - contestant's body contact from the inside of the track forcing another skater from the line of travel. Body contact must be made between two skaters before a foul is committed. If the lead skater gives way to the passing skater without being touched, then he gives up his right to the lead.
- SR620.7 Interference - Skating with hands on hips with elbows extended, or use of the hands, hips, shoulders or legs in any manner so as to interfere with another skater. Also a form of blocking;
- SR620.8 Pushing (except members of own team during relay);
- SR620.9 Charging;
- SR620.10 Striking another skater;
- SR620.11 Jamming - should a skater deliberately slow his or her pace suddenly, causing the field to jam, a foul will be called on the skater.
- SR620.12 Shoving.

**SR621** **Body contact** is not necessarily a foul unless it impedes the progress of other skater or skaters.

**SR630** **TEAM FOULS**

**Team fouls are violations of team rules in relays, such as:**

- SR630.1 A member being outside the team lane in the gate area during a four-person race when he or she is not about to relieve another team member;
- SR630.2 A member failing to leave the track after he or she has been relieved (continuing on the track beyond pylon 2 is considered as having two members on the track and is a foul);
- SR630.3 A member returning to the gate area after skating his or her required laps;
- SR630.4 Illegal relays, such as relays made outside of the relay zone, team members not making contact for relay, whip or pull-through relays or any relay other than touching, tagging or a push relay;
- SR630.5 A member who leaves the gate area for a relay but does not enter the event IMMEDIATELY in the relay zone; That member must continue to skate in a forward motion. No stopping is allowed after leaving the gate area and after entering the relay zone.

- SR630.6 A member who leaves the gate area before his or her team member begins the relay lap;
- SR630.7 A member who skates the incorrect number of laps;
- SR630.8 Team members who use teamwork or blocking in preparation for and during relay contact;
- SR630.9 A member who does not enter the gate area from the rear and leave from the front.
- SR630.10 A member or members of a relay team who accumulates four knocked pylons in a relay race.
- SR630.11 A contestant having all the wheels of both skates outside the designated gate area.

**SR640 FINAL LAP**

- SR640.1 When a leading skater or contestant team has completed all but one lap of a race, the starter will report with the electronic starting device or bell indicating that the leader has one lap remaining. The electronic starting device or bell is governed by the leader, regardless of the number of laps remaining for the other contestants or contestant teams.
- SR640.2 As skaters cross the finish line, placement is determined by the front point of the front wheel of the leading skate with at least one wheel being in contact with the floor. If the first skate is not in contact with the floor, then the placement is decided by the leading point of the competitor's second skate. In the event of a fall, the placement for any contestant whose skates do not have contact with the floor shall be determined by the leading point of the front wheel of the lead skate.

**SR650 AWARDS**

- SR650.1 Contestants and contestant teams in each division will receive appropriate awards. Official USARS awards will be presented to 1<sup>st</sup>, 2<sup>nd</sup> and 3<sup>rd</sup> at all qualifying championships.

**SR660 POLICIES REGARDING FINANCIAL SUPPORT OF ROLLER SKATING**

- SR660.1 A. Competitive Cash Prizes are permitted for indoor and outdoor speed skating competitions. Leagues, as well as speed meet hosts, are provided the option to add cash or premium awards as a means of drawing greater contestant participation.  
B. State and federal income taxes may be due from the member as a result of the receipt of any of the foregoing reimbursements.

**SR670 RECORDS**

- SR670.1 National records in all distances in every division can be established and will be recognized only when skated at the national championships, and verified by the computer timing system.
- SR670.2 Any speed records other than those established at National Championships are not to be considered official USARS records.
- SR670.3 As soon as a speed skating record time has been verified as being broken at a Speed Skating National Championship, that announcement will be made. At the awards ceremony, a "speed skating certificate of record time" shall also be presented to the skater. All accepted official records will be published by USARS.

- SR670.4 Process for verifying speed records at National Championships:
- A. National office will provide a current list of records to the National tabulator one month in advance of the championship.
  - B. The chief tabulator will identify records on a record log.
  - C. The announcer will have a record log and verify with the place slips. The Meet Director will review as needed with the tabulator and chief referee to verify the record before announcing.
  - D. The tabulator will enter the new time in the program and keep the official log of records.

SR670.5 A record established in any distance or division, verified by the computer timing system and completing the correct number of laps, shall be recognized as an official USARS National Record. The official rerun of any distance for any reason other than wrong number of laps will not impact the establishment of a national record.

**SR700 OFFICIALS AND THEIR DUTIES**

**SR710 OFFICIALS REQUIRED**

**SR711** At USARS sanctioned league, interclub and invitational meets, the meet director, the chief referee and assistants must be currently registered and hold speed judges commission consistent with the type of meet being held. It is the responsibility of every official in each USARS sport to strictly enforce the rules of USARS. No official has the authority or prerogative to waive the safety rules as published, particularly as this relates to equipment or conditions of competition.

**SR712 National Championships**

For the national championships, the following USARS commissioned officials are required:

- SR712.1 One Certified Meet Director with assistants as needed.
- SR712.2 One referee with assistants as needed.
- SR712.3 An out-of-region referee must officiate at all regional championships unless permission to use a local referee is obtained in writing from the USARS National Headquarters.
- SR712.4 Four or more corner referees.
- SR712.5 Four or more finish place judges, one of whom will be designated by the referee as the chief place judge.
- SR712.6 As many as three timers, one of whom will be designated by the referee as the chief timer. For the national championships, three timers are required, unless an electronic timing device is used.
- SR712.7 One starter, who may have an assistant.
- SR712.8 One tabulator, with assistants if necessary.
- SR712.9 One competitive steward.
- SR712.10 One announcer.

SR712.11 The Speed Committee shall serve as the “Rules Committee” at both Indoor and Outdoor Nationals as requested by the Certified Meet director, in a non-compensated capacity.

**SR713 Qualifying Championships**

At qualifying championships only, the chief referee may grant temporary officials' credentials to place judges and timers when a sufficient number of commissioned volunteers are unavailable. It will be the chief referee's responsibility to select and instruct these individuals. Such authority is for emergency purposes only, and a report by the chief referee of the performance of temporary officials will be required.

**SR714 Official's Registration Status**

The responsibility to check the USARS registration status of speed officials shall lie with the chief referee.

**SR715 Relationship to Contestants**

Any official related to, the partner of or former partner of, coach or former coach of a contestant in a race must report in advance to the referee. The referee may, at his or her discretion, cancel that official's assignment for the race.

**SR716 Officials Meeting**

The referee will hold a meeting of all speed officials at least one hour prior to the time of the first race. All speed officials are required to attend. Any persons failing to attend may be ineligible to act as officials for the contest.

At this meeting, the referee will assign posts to the officials, clear up any misunderstandings of rules interpretation and make sure that each official is prepared to conduct himself or herself in a businesslike manner while on the floor. The referee will check the officials' uniforms for neatness.

All officials will be instructed that they are not to go on the floor until the track has been prepared. The only exception to this will be the referee and the tabulator, provided that the tabulator's table is on the floor. (This rule is to help maintain the orderly appearance of the track.)

**SR717 Electronic Devices**

SR717.1 No competitor may wear an electronic communication device during the skating of an event.

SR717.2 The use of headsets by all officials is optional for interclub, league and invitational contests.

SR717.3 At Regional and National Championships, the use of headsets by all chief referees, referees, corner referees, and starters is required and headsets are considered optional for all remaining officials.

SR717.4 The two-way FM radio headsets must be furnished by the officials themselves and must be compatible with the specifications of the devices marketed by Radio Shack. As an alternate, multi-channel radios may be used as supplied by various manufacturers.

**SR718 Official's Uniforms**

SR718.1 The following officials will be required to be in uniform at all times while on the floor: referee, assistant referees, starter (black and white striped referee shirt, black slacks).

SR718.2 All other officials:  
men - white shirt or national official's shirt, black slacks;  
women - white shirt or national official's shirt, black slacks or black street-length skirts.

SR718.3 National Championship Dress Code for Stage Staff  
A. Morning and afternoon sessions (with no awards presented): Business casual; khaki type pants or slacks with a polo or dress shirt with no tie, appropriate shoes, no sandals, blue blazer optional.  
B. Evening sessions and awards presentations: Business semi formal; blue blazer, grey or khaki type pants or slacks, dress shirt, appropriate shoes and tie.

**SR719 Consolidation of Officials for Local Meets**

In local meets, it is permissible to consolidate the duties of certain officials. For example, the chief place judge may also be designated as a timer; or, the starter may also be a place judge. However, neither corner referees nor referees should be assigned additional duties while officiating races.

**SR720 DUTIES AND AUTHORITY OF THE CHIEF REFEREE**

SR720.1 The referee's duties are to ensure that each race is a fair contest and that all speed competitive rules are enforced. The standing referees must be standing on the inside of the track in order to watch the competitors as closely as possible at a safe distance. The rolling referees must be rolling on the inside of the track to ensure they do not interfere with the competitors on the track. If the referee observes a skater during a race committing a technical, personal or team foul, it is the duty of the referee to disqualify that skater from the standing or rolling position (inside the track). At regional, national or other qualifying events, there will be up to two officials on skates for disqualifying or moving lapped skaters over if necessary. The decision on the number of rolling officials (up to two) will be at the discretion of the chief referee and meet director. It is the chief referee's discretion to position the referees for optimal angles during the race. One wireless microphone may be provided to the chief referee (for communicating with the skaters that are disqualified or lapped). For non-qualifying meets, the standing/rolling official numbers are at the discretion of the chief referee.

The chief referee may disqualify any contestant from a race and recommend a meet disqualification against any contestant(s) for loafing or competing to deliberately lose or fall, for attempting unsportsmanlike team work, for coaching another skater or for impeding (in any way) the chance of another contestant(s) from winning the event.

SR720.2 It is the duty of the referee, in conjunction with the meet director, to ensure that the rules for division of skaters into heats, semi-finals, finals are observed.

SR720.3 It is the duty of the Chief referee to assist the meet director in assigning and supervising speed officials.

SR720.4 The responsibility to check the USARS registration status of speed officials shall lie with the Chief referee.

- SR720.5 The Chief referee will have complete and final authority over the running of a race and the handling of disputes and objections that may arise from that race.
- SR720.6 Only the referee can disqualify a skater from a race.
- SR720.7 The chief referee's decision is final.
- SR720.8 If the reason for a meet disqualification is a severe act or an act of unsportsmanlike conduct, the Chief referee must refer the matter to the meet director for further action.
- A. Only the meet director may disqualify skaters for the remainder of the meet or from races yet to be skated. Only the meet director may disqualify all the members of a team or club. The referee may make recommendations, but only the meet director has the authority to take further action.
- B. The meet director must recommend in writing to the USARS Membership Eligibility Committee the suspension of any skater guilty of unsportsmanlike conduct. The referee must assist the meet director in preparation of the report, and both the meet director and the referee must sign the report before it is submitted to the Membership Eligibility Committee. A similar report must be submitted to the USARS National Headquarters in the event of an official's misconduct.
- SR720.9 The Chief referee has the power to overrule BUT NOT TO CHANGE the decision of any other official.
- SR720.10 The Chief referee may declare a race "no contest" and cause the competitors to re-skate the distance, if:
- A. Contestants loaf, procrastinate or fail to take alternate pace. The re-skate is not to include any skaters previously disqualified from the race.
- B. A contestant falls and becomes a safety hazard to the other contestants still on the track. The re-skate is not to include the fallen skater who caused the "no contest" call or any skaters previously disqualified from the race. A disqualification slip must be turned in on a skater that falls blocking the track causing a re-skate. The disqualification will be for "causing a no contest call".
- C. A jam occurs on the first corner and a skater or skaters fall. The referee may re-start the race with any offending skaters being disqualified.
- D. For any other cause, such as official error, the re-skate is not to include any skater previously disqualified from the race.
- SR720.11 The Chief Referee may declare a relay race no contest and cause the competitors to re-skate the distance if a skater is knocked down to the track by a skater returning to the relay gate area. The distance will be re-skated without the offending team and without any other disqualified team.
- SR730 DUTIES AND AUTHORITY OF ASSISTANT REFEREES AND CORNER REFEREES**
- SR730.1 Assistant referees will have the same duties and authority as the chief referee during the skating of races, but the chief referee will remain the final authority and may overrule an assistant referee or corner referee.



SR730.2 Assistant referees will act as relay referees, upon observing a relay infraction, the referee will write down the team's relay number and the foul observed, then contact the running referee to make the disqualification.

SR730.3 The Corner Referee is a supporting official, white shirt/blouse black slacks/skirt, this position is NOT on skates and requires enough physical ability to chase and replace pylons quickly. The Corner referee must have a minimum of a C commission. Corner referees will be stationed on the outside of the track at each corner pylon for every race, either individual or relay. It is the primary duty of the corner referee to be responsible for maintaining correct placement of the pylon or marker at his/her corner of the track. It is also the duty of the corner referee to watch for fouls or any irregularities. Upon observing an apparent foul, the corner referee must note the offending contestant's number on paper, then signal the referee that a foul may have occurred. The corner referee signals by raising his or her right hand overhead (see Officials' Arm Signals) or communicates to the referee via radio headset, if used. The race referee and or the chief referee will take the corner referee's recommended foul call for review. The referee may accept or reject the corner referee's foul recommendation. Only the referee can disqualify a skater from a race.

SR730.4 Corner assignments (refer to track diagram in front of book)

A. Corner referee #1-Area of responsibility includes approximately 1/2 of the straightaway from pylon #1 toward the finish line to approximately 1/4 of the straightaway between pylon #2 and #3.

B. Corner referee #2-Area of responsibility includes approximately 1/4 of the straightaway from pylon #1 towards the finish line to approximately 1/2 of the straightaway between pylon #2 and #3.

C. Corner referee #3-Area of responsibility includes approximately 1/2 of the straightaway from pylon #3 towards pylon #2 to approximately 1/4 of the straightaway from pylon #4 towards to finish line.

D. Corner referee #4-Area of responsibility includes approximately 1/4 of the straightaway from pylon #3 towards pylon #2 to approximately 1/2 of the straightaway between pylon #4 and the finish line.

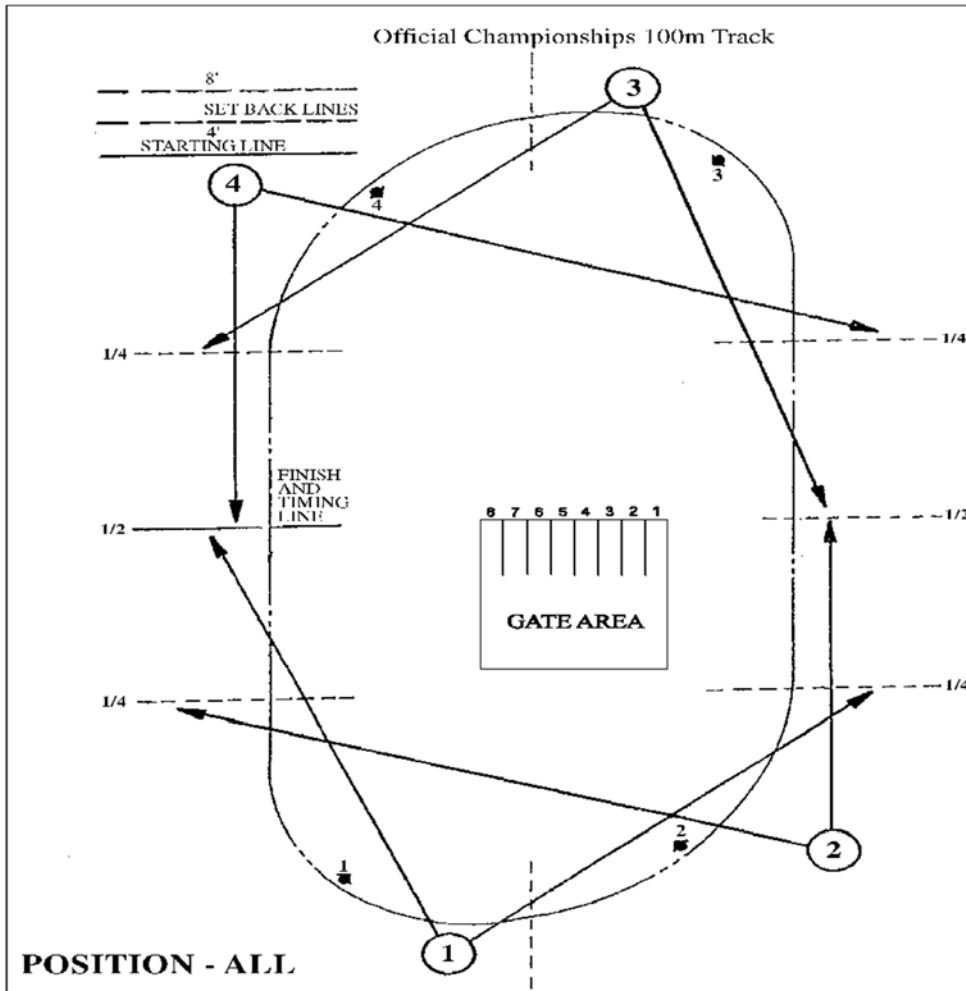

**SR740 DUTIES OF THE CHIEF PLACE JUDGE AND FINISH PLACE JUDGES**

- SR740.1 The chief place judge will work with the chief referee and the meet director in the selection of qualified place judges for the meet.
- SR740.2 The chief place judge, prior to the beginning of the day's events, should advise the placement panel to conduct themselves in a professional manner by avoidance of cheering for the participants and maintaining confidentiality.
- SR740.3 The chief place judge will instruct the place judges on the proper manner by which the placement sheets should be filled out.
- SR740.4 The chief place judge will remind the place judges what part of the skate across the line determines placements.
- SR740.5 The chief place judge will advise the panel to make their final decisions silently in order not to influence the other judges.

- SR740.6 The chief place judge will be responsible for keeping track of all placements and lapped skaters in each race. This will serve as a backup for each place judge.
- SR740.7 The chief place judge will collect all placement slips, in proper order of placement, timer and disqualification slips and submit these to the tabulator as quickly as possible after each race ends.
- SR740.8 The chief place judge should have an alternate judge available for those place judges who have a skater racing.
- SR740.9 Finish place judges will determine the order in which contestants finish each race. In cases in which there is no unanimous agreement as to the placement of a contestant or contestant team, the chief place judge will confer with the other place judges and the chief referee. The chief referee will make the decision determining the final placements.
- SR740.10 As skaters cross the finish line, placement is determined by the front point of the front wheel of the leading skate with at least one wheel being in contact with the floor. If the first skate is not in contact with the floor, then the placement is decided by the leading point of the competitor's second skate. In the event of a fall, the placement for any contestant whose skates do not have contact with the floor shall be determined by the leading point of the front wheel of the lead skate. Also see SR640.2
- SR740.11 Finish place judges will report the order of placement on the placement forms for each event.
- SR740.12 If it is necessary for the chief place judge to be a finish place judge, he or she should be the first place finish place judge.
- SR740.13 The #1 place judge at all meets other than the National Championships shall be responsible for timing the lead skater as he or she crosses the finish line at the invitational, league and Regional meets.
- SR740.14 "Photo finish" equipment is permissible in all USA Roller Sports sanctioned contests to place contestants.

## **SR750 DUTIES OF TIMERS**

- SR750.1 A separate timer is unnecessary at contests and at the Regional Championships since records can be established only at Nationals.
- SR750.2 The timers will record elapsed time for the leading skater in each race using stopwatches or electronic timers calibrated in hundredths of seconds. Each timer will record the elapsed time on a timing slip and submit the slip to the tabulator.
- SR750.3 The timers will stand as close as is practical to the finish/timing line. At the start of the race, each timer will start his/her watch when the lead skater crosses the timing line. The timers will stop their watches at the end of the race when the front point of the leading skater's front wheel of the leading skate with at least one wheel being in contact with the floor. If the first skate is not in contact with the floor, then the placement is decided by the leading point of the competitor's second skate. In the event of a fall, the placement for any contestant whose skates do not have

contact with the floor shall be determined by the leading point of the front wheel of the lead skate. Also see SR640.2

SR750.4 If no electronic timing device is used, three timers are used, as at a national championships, each timer will keep his or her own time and timing slips. The one designated as chief timer will collect the timing slips for each race, check them for completeness and submit them to the tabulator. Should two of the three watches show the same time and the third watch disagree, the time of the two watches will be official. If all three watches disagree, the intermediate time will be official.

SR750.5 The proper method for recording times is as follows:  
minutes : (colon) seconds . (period) hundredths of a seconds  
examples:  
–one minute = 1:00.0  
–six minutes, four and thirty-four hundredths seconds = 6:04.34  
–twelve seconds and twenty-five hundredths = 0:12.25

## **SR760 DUTIES OF THE STARTER**

SR760.1 It is the duty of the starter to begin races by report of a starting gun. A misfire will be considered no start.

SR760.2 Procedures for the Starter (Refer to section VII.-G., Starting Procedure.)

- A. When the race is called, skaters will proceed to the four foot setback line. The starter then moves to a position approximately six feet (6') forward of the starting line position.
- B. An assistant referee or assistant starter will give the command "To your mark." Skaters will move forward to the starting line in a preliminary starting position. The assistant referee or assistant starter will give the command "Set." Skaters will immediately assume their final starting position and remain stationary until the starter fires the gun.
- C. The starter fires the gun when all skaters are ready.
- D. Any movement after the "set" command will cause the offending skater to be penalized with a false start. Only the skater who initiates the false start will be set back, even if he or she did not leave the starting line.
- E. The referee or assistant referees may signal a false start by two blasts of a whistle calling all skaters back to the line. After each false start a new command "To your mark" will be issued before the race will be restarted.
- F. After the race is started, the starter will keep a record of the number of laps skated and will signify the number of laps remaining by the use of lap cards. The referee may, at his or her discretion, require that a race be re-skated should an official error occur in the counting of laps.
- G. As the leading skater enters the last lap of a race, the starter will fire the gun or ring the bell to denote that the race is going into the final lap. The starter will signal the finish of the race with a checkered flag as the placing skaters cross the finish line.

SR760.3 The starter will have control of the skaters at the starting line, will judge whether any skater has jumped the gun, and will call the field back for new starts in the event of false starts.

SR760.4 The starter's decision on who committed a false start may be overruled by the referee.

SR760.5 No race will be started with a "flying" or rolling start (except as described in SR530).

**SR770 DUTIES OF THE TABULATOR**

- SR770.1 The tabulator will record the names of all competitors entered in each division and relay division, seed skaters into their heats and prepare all tabulation forms and other necessary forms before the start of the contest. The tabulator may also assign relay numbers to be distributed by the competitive steward.
- SR770.2 From the placement forms submitted by the chief place judge and the timing slips submitted by the chief timer, the tabulator will record the order of finish and time of each race and enter that information on the official scoring forms. The tabulator will keep a file of all judges' slips showing the order of finish and the times so that the referee may check all tabulation in case of dispute on placement. The judges' slips and referee's disqualification slips are to be filed with the official scoring forms and other records at the conclusion of the contest.
- SR770.3. The tabulator will post a list of contestants who have qualified for semi-final and final races. After each final race, the placements will be posted for each distance. Posting must be done as soon as possible in an area accessible to all competitors.
- SR770.4 The tabulator will mail all scoring forms and reports to the USARS National Headquarters as soon as possible after the conclusion of the contest. This must be done in cooperation with the meet director, who is responsible for submission of any protest or accident reports that should accompany the scoring forms.

**SR780 DUTIES OF THE COMPETITIVE STEWARD**

- SR780.1 It is the duty of the competitive steward to prepare competitors to take the floor for each race as it appears on the schedule. These preparations will include:
- A. Check-in of each skater prior to the start of racing;
  - B. Distribution of relay numbers assigned to members of relay teams;
  - C. Supervision of the drawing that determines starting position for a race, whether heat, semi-final or final. At Outdoor National Speed Skating Championships, skaters may choose their position on the starting line for the 500m and the 1000m races according to their rankings in the 300m race and according to the number of positions assigned.
  - D. Inspection of uniforms and equipment to ensure that each skater is in compliance with competitive rules;
- SR780.2 The competitive steward will report to the tabulator the names of all contestants who have failed to check in.
- SR780.3 The competitive steward will report to the referee any contestant who refuses to comply with the rules concerning proper uniform, proper equipment or personal safety.

**SR790 DUTIES OF THE ANNOUNCER**

- SR790.1 It is the duty of the announcer to publicly voice the results of each race (heat, semi-final, final) and to promptly announce ALL disqualifications after receiving those results from the appropriate official.

SR790.2 The announcer, in cooperation with the tabulator, will report each set of race results using either the officials' placement and timing slips, or an announcement sheet prepared by the tabulator from these slips. Results are not final until tabulation has been completed.

## **SR800 SPEED COMPETITIVE JUDGES & COMMISSIONS**

### **SR810 Obtaining Official Credentials**

To obtain a USARS Competitive Speed Commission, the candidate must:

SR810.1 Be a minimum of 15 years of age.

SR810.2 Hold individual membership with USARS.

SR810.3 Be a member of a bona fide USARS club.

### **SR820 Classes of USARS speed competitive judges commissions**

#### **Supporting Officials:**

SR820.1 **Speed "C" Commission** - Used at league, interclub and invitational contests, applicable to any track position except referee. Candidate must be a minimum of 15 years of age. No experience as a speed official is required to take a written commission test that will be formulated with the approval of the USARS Speed Committee.

SR820.2 **Speed "B" Commission** - Needed to act as a Regional Championship Official. To be eligible for this commission an applicant must have at least one-year of experience as a "C" official and have worked at least six contests. No written test is required. ~~however, a candidate must have the endorsement of the league or Regional USARS President or Chairperson.~~

SR820.3 **Speed "A" Commission** – Awarded to National Championship supporting officials. A "B" commissioned official may apply to the Speed Committee for appointment to the National Championship Supporting Officials Panel. This does not include a referee position. If the applicant's performance at the National Championship meet is deemed satisfactory, they will be upgraded to an "A" commission.

#### **Referees:**

SR820.4 The Supporting Official that holds the "A" Commission and wants to become a rolling official will now start with the "CR2" Commission.

SR820.5 **Speed "CR1" Commission** – The applicant must be a minimum of 16 years old and there is no experience required. The applicant will be required to take and pass a written open book test. If the test is failed the applicant must wait 30 days from the date the test was taken to re-take the test. Once the test is passed the CR1 can officiate at league, interclub, or invitational meets as a supporting official and assistant track referee. The CR1 may also be a non-rolling supporting official at a regional meet.

SR820.6 **Speed "CR2" Commission** – The applicant must hold the CR1 commission for 1 year and is expected to work at least 3 league, interclub, or invitational meets as a supporting official and assistant track referee in the previous year. The CR2 applicant will be required to take and pass a written open book test for this upgrade. If the test is failed the applicant must wait 30 days from the date the test was taken to re-take the test. The CR2 can officiate as an assistant referee at a regional meet.

- SR820.7 **Speed “BR1” Commission** –The applicant must hold the CR2 commission for 1 year and is expected to work at least 3 league, interclub, invitational, or regional meets as a supporting official or an assistant referee in the previous year. The BR1 applicant will be required to take and pass a written open book test for this upgrade. If the test is failed the applicant must wait 30 days from the date the test was taken to re-take the test. The BR1 can officiate as a chief referee at league and interclub meets.
- SR820.8 **Speed “BR2” Commission** – Minimum age for this commission is 23 years old. The BR2 applicant must hold the BR1 commission for 1 year and is expected to work at least 3 league or interclub meets as chief referee and or invitational and regional meets as an assistant referee in the previous year. The BR2 applicant must apply as a volunteer at the indoor national championship, where he/she will be assigned to each supporting position and one rolling block by the officials committee. At the end of the indoor national championship the applicant will be verbally reviewed and evaluated by the officials committee and submitted to the speed committee for upgrade. Upon speed committee approval the applicant will be awarded a BR2 commission. The BR2 commission holder will be assigned a number. The BR2 can officiate as a chief referee at invitational meets.
- SR820.9 **Speed “AR1” Commission** - The applicant must hold the BR2 commission for 1 year and is expected to work at least 3 league, interclub or invitational meets as chief referee and or regional meets as an assistant referee in the previous year. The AR1 applicant must apply as a volunteer rolling referee at the indoor national championship, where he/she will be assigned to a referee’s panel by the officials committee. At the end of the indoor national championship the applicant will be verbally reviewed and evaluated by the officials committee and submitted to the speed committee for upgrade. Upon speed committee approval the applicant will be awarded an AR1 commission. The AR1 commission holder can officiate as chief referee at regional championships. The AR1 is considered an indoor national championship referee and is expected to apply for appointment to the indoor national championship panel as an assistant referee each year. Any “AR” commissioned official who has not participated at an Indoor National Championship for a period of 3 consecutive years shall revert back to a “BR2” commission level.
- SR820.10 **Speed “AR2” Commission** – The applicant must hold the AR1 commission for 3 years, have experience as chief referee at multiple region’s championships and is expected to have worked at least 3 consecutive national championship meets as referee or meet director. The AR2 applicant must apply as assistant chief referee at the national championship, where he/she will be assigned assistant chief referee’s duties by the officials committee. At the end of the national championship the applicant will be verbally reviewed and evaluated by the officials committee and submitted to the speed committee for upgrade. Upon speed committee approval the applicant will be awarded an AR2 commission. The AR2 commission holder can officiate as chief referee at national championships. The AR2 commission holder is expected to apply for appointment to the national championship panel as an assistant referee each year. The “AR2” commissioned official may also apply to be chief referee at the indoor national championship. Any “AR” commissioned official who has not participated at an Indoor National Championship for a period of 3 consecutive years shall revert back to a “BR2” commission.
- SR820.11 **Speed “Elite” Commission** – “Elite” commissions for speed officials are based on the following:
- A. Local or national service for 15 years.

- B. Hold a "B" or higher official's commission.
- C. Has trained and mentored other successful officials.
- D. Contributed to the sport through things like meet organization, meet operation, panel instruction and seminar leader.
- E. Role model for others to look up to and follow.
- F. Resource to the field.

SR820.12 As a rolling official goes through the ranks of the commission structure and chooses to officiate as a standing corner referee, the equivalent supporting official's commission will be awarded. A verbal test will be given by an AR commissioned referee assigned by the Speed Committee.

**SR821 General Rules Applying to Contest Officials**

- A. No USARS competitive judge or referee shall officiate at any event of any person who is related to him or her.
- B. No USARS judge or referee who is also a coach, may officiate at an event of any person who is or has been a pupil (private lesson or class) of his or hers without specific written approval from the USARS National Headquarters.
- C. Any USARS commissioned referees who officiate at roller skating contests other than sanctioned events are subject to the loss of their USARS commissions. Any USARS commissioned referee who officiates at a USARS sanctioned meet without current registration is subject to suspension of their USARS commission.
- D. USARS shall conduct periodic review of numbered referees for activity at the regional championship level. Referees found to be inactive may be subject to a commission downgrade and the loss of their number.

**SR830 COMPETITIVE SCORERS COMMISSIONS**

Speed Scorers Commission - An examination for a speed scorers commission is available by making application to USARS National Headquarters. Those successfully passing this exam shall be certified as a Speed Scorer and are qualified to officiate at all speed championships.

**SR831 Scoring Speed Contests**

SR831.1 All overall division placements in all speed skating contests and championships will be determined by the greatest number of points awarded in all final distances.

SR831.2 In any final distance, points will be awarded to the top four (4) skaters in each final to determine the overall placements.

SR831.3 To facilitate the selection of the overall champion, points will be awarded to the top four (4) placements in each distance final event as follows:

- First Place 30 points
- Second Place 20 points
- Third Place 10 points
- Fourth Place 5 points



SR831.4 The overall champion will be the defending champion in any division where the overall champion continues to have age eligibility.

SR831.5 In case of a tie (dead heat) in any final distance, the points will be awarded as follows:

A. In a dead heat for first place, the points for first and second places will be added together and divided equally between the skaters so placing.

B. In the event of a dead heat for second place, the points for second and third places will be added together and divided equally between the skaters so placing.

C. The dead heat formula above will be used for any other placements (except fourth (4<sup>th</sup>) place) where a dead heat occurs in a distance final.

D. In the event of a dead heat for fourth place, the points for fourth place will be equally divided between the skaters so placing.

SR831.6 The skater compiling the largest total score under the above standard point system will be declared champion of his or her division, the second largest score shall be declared second, etc.

SR831.7 In the event of a tie for the overall division champion, the tied skaters first (1<sup>st</sup>), second (2<sup>nd</sup>), third (3<sup>rd</sup>), and fourth (4<sup>th</sup>) place finishes in each distance skated will be used and applied per the SR832 tie breaking formula below.

#### **SR832 Tie Breaking Formula**

##### **Elite Inline Divisions:**

##### **Distances:**

Tiny Tot		100m, 200m, 300m
Primary		200m, 300m, 400m
Juvenile		200m, 300m, 500m
Elementary		300m, 500m, 700m
Freshman		300m, 500m, 1000m
Sophomore		500m, 1000m, 1500m
Junior Women		500m, 1000m, 1500m
Junior Men		500m, 1000m, 2000m
Senior Women		500m, 1000m, 2000m
Senior Men		500m, 1500m, 3000m
World Class Women	100m,	500m, 1000m, 3000m
World Class Men	100m,	500m, 1500m, 5000m
Classic Women		500m, 1000m, 1500m
Classic Men		500m, 1000m, 2000m
Grand Classic Women		500m, 1000m, 1500m
Grand Classic Men		500m, 1000m, 2000m
Masters Women		500m, 700m, 1000m
Masters Men		500m, 1000m, 1500m
Grand Masters Women		500m, 700m, 1000m
Grand Masters Men		500m, 1000m, 1500m
Veterans		500m, 700m, 1000m
Grand Veterans		500m, 700m, 1000m
Esquire		500m, 700m, 1000m
Grand Esquire		500m, 700m, 1000m
Premier		500m, 700m, 1000m

**Tie-breaker points for placements:**

	<u>WC/100m</u>	<u>Short</u>	<u>Middle</u>	<u>Long</u>
First	93	96	108	120-3/4
Second	62	64	72	80-1/2
Third	31	32	36	40-1/4
Fourth	15-1/2	16	18	20-1/8

**Tie-breaker points for placements:**

First	96	108	120-3/4
Second	64	72	80-1/2
Third	32	36	40-1/4
Fourth	16	18	20-1/8

Example - John Doe and William Roe are tied for first place in the Senior Men's division. Each has a total of 60 points under the standard point system. These points are set aside and the tie-breaker point system is used instead. John Doe won the 3000m (120 3/4 tie-breaker points), took second in the 1500m (72 points), and third in the 500m (32 points). His total is 224 3/4 points.

William Roe won the 1500m (108 points), took second in the 500m (64 points), and third in the 3000m (40 1/4 points). His total is 212 1/4 points. John Doe is therefore the champion. William Roe would be awarded second place and the skater holding the next highest number of points using the standard point system placed third.

**SR833** In the event of a meet disqualification prior to the conclusion of all distances within a division, all points previously earned by the disqualified skater shall be excluded from the tally of the overall placements.

**SR834** Under no circumstances will points be awarded to any skater for placing in heats or eliminations, or semi-final distances.

**SR835** Tie-breaking points NEVER supersede those earned by a skater placing higher in the division by the standard points system. Tabulators are cautioned not to be confused by the higher totals resulting from use of the tie- breaker formula.

**SR836 Unbreakable Ties**

When an unbreakable tie occurs in determining championship placements, the tied skaters will be required to compete in a tie-breaking run-off of the middle distance to determine the overall placement. The skater placing first in the run-off will be awarded the highest open place. The skater placing second in the tie run-off will be awarded the second highest open place, etc. In the case of a dead heat in any individual division distance where each distance is awarded (Elite division), both skaters would be awarded the same medal for that distance and no medal would be awarded for the next subsequent placement.

**SR837** At the National Championships, the club plaque "John Wintz" award will be presented only to the overall Elite division champion. Additional awards will be presented to the first, second, and third overall placements for all Elite divisions.

**SR840 OFFICIALS' ARM SIGNALS**

Officials will use three basic arm signals to facilitate the handling of speed skating contests and for the information of competitors and spectators.

Corner referee or Team Judge

Right arm overhead indicates that the judge has observed a foul being committed by a skater.



Referee or Assistant Referee

Right hand toward skater, palm out, fingers up.

This signal, accompanied by two short blasts of the referee's whistle, indicates to the skater that he or she should move to the outside, that he or she is about to be lapped by another skater.

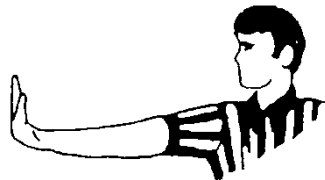

Referee or Assistant Referee

Index finger of right hand pointing at skater, thumb up (motioning out as in baseball signal). This signal, accompanied by one long blast of the referee's whistle, indicates to the skater that he or she is disqualified and must leave the floor.

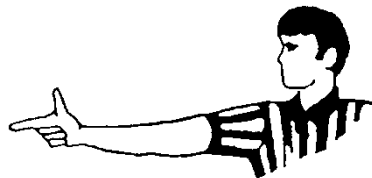

## **SR900 STANDARDS FOR ALL USARS OUTDOOR ROLLER SPEED SKATING COMPETITIONS**

**NOTE:** USARS has adopted the CIC rules for Outdoor National Championships *with modifications to fit Nationals and Trials requirements (reference SR950)*. Rules and distances listed below will be different from those listed by the CIC. Consult the CIC Rule Book for the most recent changes which are updated each year. Outdoor races, other than Outdoor Nationals, are not bound with the distances and type of races shown here. The meet host has the option to create distances to their own liking.

## **SR910 SANCTION APPLICATIONS FOR OUTDOOR SPEED EVENTS**

**SR910.1** Before the issuance of a sanction for any outdoor speed skating competition, the meet director must submit to USARS Headquarters a complete diagram of the race circuit. This diagram and

race course layout must be in conformity with all published USARS safety regulations. The diagram should include where barricades will be located, closing off the area from vehicular traffic. The diagram, with footnotes should state the location of manhole covers, potholes, and other track impediments. Also the diagram should include how these hazards will be dealt with for the safety of the participants. Inspection of the course must be personally made by the meet director or the chief referee and the documents prepared along with their signatures.

- SR910.2 Copies of city permits allowing the use of public streets, or in the case of private property, the owner's written permission must accompany sanction applications.
- SR910.3 Also included with the sanction application is a description of safety precautions that will be in place to protect the contestants from moving traffic or other sources of danger, "encountered due to the nature of the location of the contest."
- SR910.4 Police protection and supervision, if required, to protect venue safety must also be included.
- SR910.5 An operation plan shall be submitted containing the procedures for first aid, with ambulance availability. On-site qualified medical assistance is required due to the nature and possible severity of the accidents that may occur with this sport.
- SR910.6 The sanction holder must provide USARS with a hold-harmless agreement and a bond or insurance policy of sufficient value, in keeping with the nature of the venue, to protect USARS and to guarantee the safety of the participants. Any outdoor roller skating contest will be required to carry at least \$300,000 in general liability insurance for the protection and safety of the contestants and USARS. This amount must be secured from a reputable insurance company and may be increased accordingly, if in the judgment of the Sanction Committee, traffic or surface conditions appear to warrant additional insurance.
- SR910.7 Any roller skating competition host or organizer applying for a sanction with USARS must specify at the time of application if any other sport organization will participate during or immediately before or after the event for which a USARS sanction has been requested. A USARS sanction requires the presence of a USARS certified meet director or a USARS registered chief referee.
- SR910.8 The meet host in charge of each competition shall be responsible for seeing that the above safety requirements are met.
- SR910.9 Skaters qualify to compete at the national outdoor speed skating championships by successfully completing a banked track clinic or having been a member of a previous World Speed Team.

**SR920 SEEDING OUTDOOR RACES**

- SR920.1 Following the entry deadline for a national bank track and road championships, the skaters for which entries have been received are to be divided between male and female and arranged in alphabetical order within each division and assigned consecutive numbers for use throughout the championships.
- SR920.2 The results from the 300m track and the 200m road events shall be used for the seeding of all outdoor races in the national banked track and road championships with the exception of the marathon and the half-marathon which will be run as final events with all contestants entered.

SR920.3 If a skater does not take part in the 300m track and the 200m road time trials and wishes to skate other events, then the skater will occupy the place that corresponds at the end of the serpentine. If the heats need further equalizing as the competition continues, this will be accomplished by moving the last skaters from the 300m track and the 200m road distances to other heats until they are once again balanced. The system for placing skaters from heats into quarter finals, semi finals and finally into the final of each distance is prescribed according to the description of that distance outlined within this manual.

#### **SR921 Tabulating and Keeping Score**

At the conclusion of the national banked track and road championships, all skaters are awarded their overall position using a placement system as prescribed below.

SR921.1 Points are awarded in the finals of each distance as follows: 15 points for first place, 12 points for second place, 10 points for third place, 8 points for fourth place, 6 points for fifth place, 4 points for sixth place, 3 points for seventh place, and 2 points for eighth place. Points are awarded for 5<sup>th</sup> to 8<sup>th</sup> in 500m Track and Road races by times in Semi Final Heats.

SR921.2 Awards will be presented to the first, second and third place finishers for each distance on the road and the track. Overall division medals will not be awarded at the Outdoor National Championships.

SR921.3 From the overall placement score sheets, list all skaters that place ninth, tenth, eleventh, and twelfth. These placements are then awarded 30, 20, 10 and 5 points respectively. These points are then calculated to determine the ninth, tenth, eleventh, and twelfth place skaters overall.

SR921.4 Using the same procedure as above, calculate the top 20 skaters in each division by dividing them into skaters receiving the next four placements and applying the points system of 30, 20, 10, and 5 points.

SR921.5 In the event of a meet disqualification prior to the conclusion of the championships, all points previously earned by the skater disqualified shall be excluded from the tally of the banked track and road championship's overall placements.

SR921.6 If there is a discrepancy as to the placement of contestants and there is photo-finish equipment in use, the chief referee must review the photographs. The photo finish will be binding for deciding the final placements in question. Taped or film images are exclusively used for the purpose of determining the finish line placements at the national banked track and road championships, and cannot be used to resolve any other controversial issues.

SR921.7 If there is a disqualification or a DNF in the 1000m final event points will be awarded to placements completing the final event only.

SR921.8 If quarter-finals or semi-finals are necessary to conduct an event, the skaters will be placed into a serpentine system. This system is used by placing the skaters in the event across in columns to the right equal to the number of heats, quarter-finals, or semi-finals needed for the event. When the last column position is filled, the next skater is placed in the position directly underneath the last skater to signify the second skater in the last heat. Positions are continued to be filled in across the columns to the left until the left-most column is reached with the next skater being placed underneath the previous contestant. This procedure is followed until all contestants are placed into the event.

SR921.9 OUTDOOR NATIONALS TIEBREAKER FOR "A" AND "B" POSITIONS - In the event of a tie, the following formula will be applied.

A. The "A" Position is the skater with the highest point total in the 200m and 300m events. If a tie exists, the skater with the highest placement in the 300m will be named to the "A" Position.

B. The "B" Position is the skater with the highest point total in the 200m, 300m, and 500m on track and road, not including the "A" Position. If a tie exists, the skater with the highest placement in the 300m will be named to the "B" Position.

SR921.10 OUTDOOR NATIONALS TIE BREAKER FOR ALL SELECTIONS EXCEPT SR921.9 ABOVE – In the event of a tie, the following formula will be applied.

A. Overall points will be added for all races in which the skater placed first, second or third in a final. The skater with the most points will be awarded the higher placement based on quality medal points.

B. If a tie is not broken by rule (a), then the points awarded for the longest and shortest distance skated on the track and road will be added together and the higher placement will be awarded to the skater with the most points.

C. If a tie is not broken by rule (b), the following points will be awarded for each race in which points were earned and the higher placement will be awarded to the skater with the most points.

1.	300 meter	58.25
2.	200 meter	55.25
3.	Points Elimination	75.45
4.	Points	75.15
5.	Elimination	65.65
6.	1000 meter	50.35
7.	500 meter	25.25

D. If a tie is not broken by rule (a), (b), or (c), the skater with the highest point total on the track will be awarded the higher placement.

## **SR930 OUTDOOR NATIONAL RACES AND PROCEDURES**

### **SR931 Time Trials (300 meters Track & 200 meters Road)**

SR931.1 One contestant at a time races against the clock attempting to skate the fastest time for the 300 meters on the track or 200 meters on the road. Times are recorded to one- thousandth of a second if possible. Timing will start when a skater breaks the plane of an electronic beam at the starting line. The starting line beam should be 30 centimeters (approx. 12 inches) from the ground. A second beam registers the finish when the skater breaks the plane of the electronic beam with any part of the leading skate. The finish line beam should be no more than 10 centimeters (4 inches) from the ground. The top three skaters receive medals.

SR931.2 Prior to the national banked track and road championships, USARS Headquarters staff will conduct a blind draw to determine the order in which the contestants will participate which will result in the scrambling of the alphabetical and numerical order of the contestants.

SR931.3 Once the timer is ready, the starter will advise the contestant to start when ready. At this time, the contestant will have 15 seconds in which to start. Once the contestant breaks the electronic beam, he/she must enter the event immediately. No re-skate will be allowed for those skaters who remain on the starting line after the beam is broken.

SR931.4 The start will be as follows: Both skates must be on the ground and must not be moving. The oscillation of the athlete's body is allowed. A dashed line must be drawn 60 centimeters (approx. 20 inches) behind the starting line. The skater must have at least one skate within the two lines. If any part of the skate moves outside the back line, it will be considered as a false start. The first movement of the skate must be in the direction of the competition and must cross through the starting beam.

SR931.5 If during the start of the event, an athlete falls due to mechanical failure or other reasons for which they are not responsible, the officials controlling the event may repeat the start for that skater.

SR931.6 In order to determine the first place skater when two or more athletes obtain the same times, the event will be repeated in order to establish the ranking order. If either of the tied skaters refuse to repeat the event, they shall be ranked after the other skater. The time obtained by each competitor must be communicated immediately after the finish.

**SR932 Sprint Races (500 meters)**

SR932.1 Heats are set-up based on the placement of skaters in the 300m Time Trials for Track and 200m Time Trials on Road. The number of skaters qualifying from each 500m heat to a quarter-final or semi-final is determined by the number of skaters entered in that event and is displayed in the schedule listed below. In the men's and women's 500m events, at least two skaters will advance each round. There will be two semi-finals with 4 skaters in each. First and second in each semi-final will skate the Final determining 1<sup>st</sup>, 2<sup>nd</sup>, 3<sup>rd</sup>, and 4<sup>th</sup> placements. Third and fourth in each semi will skate a placement race to determine 5<sup>th</sup>, 6<sup>th</sup>, 7<sup>th</sup> and 8<sup>th</sup> place. If a skater doesn't take part in the 300m Time Trials for Track and 200m Time Trials on Road and wishes to skate the 500m, he will then occupy the place that corresponds at the end of the serpentine. Skaters may choose their positions on the starting line for all 500 meter races based on their placement in the 300m or 200m events. In quarterfinals, semifinals and finals the skater advancing with the highest placement from the preceding qualifier that has the fastest 300m or 200m time gets first lane choice. Example: Quarterfinal 1. 1, 2, 2, 4, 4, serpentine from 5 heats. The first place gets the first choice, the fastest time trial time of the two second places get the next lane choice, then the second second and so on.

**500 METER RACE**  
4 into final

# of skaters	# of heats	# to qualify	# of quarter finals	# to qualify	# of semi finals	# to qualify	# in fi-nals
67-72	12	1, 2	4	1, 2	2	1, 2	4
61-66	11	1, 2	4	1, 2	2	1, 2	4
55-60	10	1, 2	4	1, 2	2	1, 2	4
49-54	9	1, 2	4	1, 2	2	1, 2	4
43-48	8	1, 2, 3	4	1, 2	2	1, 2	4
37-42	7	1, 2, 3	4	1, 2	2	1, 2	4
31-36	6	1, 2, 3, 4	4	1, 2	2	1, 2	4
25-30	5	1, 2, 3, 4	4	1, 2	2	1, 2	4
19-24	4	1, 2, 3	2	1, 2, 3, 4	2	1, 2	4
13-18	3	1, 2, 3, 4	2	1, 2, 3, 4	2	1, 2	4
9-12	2	1, 2, 3, 4			2	1, 2	4

**SR933            Sprints (1000 meters)**

- SR933.1            Heats are set-up based on the placement of skaters in the 300m Time Trials for Track.
  
- SR933.2            The number of skaters in the elimination round can be approximately 1-1/2 skaters for each meter of the width of the track. For example, for a track of six meters and 40 skaters, you could have 4 heats of 10 skaters. You would have 4 winners and 8 losers times to advance to the semi-finals. In the semi-finals, you would have 2 heats of 6 skaters. Two winners and four loser times would advance to the finals.
  
- SR933.3            USARS adopted the CIC International outdoor speed skating regulation for 1000m sprints, which allows up to ten on the line according to the width of the track and the number of participants.
  
- SR933.4            Unlike other outdoor events, the 1000m eliminations allow skaters to qualify either by placement or fastest time. The winners of each of the heats and a designated number of fastest times, regardless of which heat they skated advance to the next round of competition. It is important to obtain times of all contestants in the elimination and semi-final heats so the designated number of contestants can be placed according to the heating schedule. When using the professional electronic timing device, one designated official will review the film and one designated timer will be responsible for listing the recorded time on the timer's slip for the tabulator. If manual timing is used, the current rules listed in the duties of the timers will prevail. Eight skaters will skate in the final event. The top three (3) skaters receive medals. If a skater doesn't take part in the 300m Time Trials and wishes to skate the 1000m, the skater will then occupy the place that corresponds at the end of the serpentine.
  
- SR933.5            For the starting line positions of the semi-finals and finals, the contestants will be arranged according to times so the fastest time will be in the first position on the inside of the track and the next fastest time will be to the right of the fastest skater and continue placing the skaters towards the outside of the track.
  
- SR933.6            The three semi-final heats are established according to the times registered in the heats. The winner from each of the heats will be placed according to the serpentine system, the first being the one who registered the best time and so on. Those who qualify by losers times are then arranged again, according to the times registered and the serpentine system.

**SR934            Mass Start Races**

SR934.1            Heats are set-up based on the placement of skaters in the 300m Time Trials for Track and 200m Time Trials on Road and are organized using the serpentine system and according to the heating schedule listed below. Placement of contestants on the starting line is determined by the order of the skaters for that heat after the serpentine system has been applied and starting with the position on the first line and closest to the inside of the track. The number of skaters to be placed on each line at the start is determined by the width of the track used, with a distance of two (2) feet for each skater to be used as a guideline. Contestants move to the next round of competition if they qualify by placement in the previous race. Points for placements in the final are given according to the system listed in the "tabulating" section previously listed in this manual.

# Skaters	# Heats	# to qualify	# Finals
81-100	5	5	25
61-80	4	5	20
41-60	3	6	18



21-40	2	9	18
1-20		Final	

**SR935 Points Races**

SR935.1 Heats are set-up based on the placement of skaters in the 300m Time Trials for Track and 200m Time Trials on Road and are organized using the serpentine system and according to the heating schedule listed below. Placement of contestants on the starting line is determined by the order of the skaters for that heat after the serpentine system has been applied and starting with the position on the first line and closest to the inside of the track. The number of skaters to be placed on each line at the start is determined by the width of the track used, with a distance of two (2) feet for each skater to be used as a guideline.

SR935.2 As the skaters pass the start-finish line on the lap before the points are to be awarded, the starter or lap counter will ring the bell to signify that on the next time across the finish line, points will be awarded to the skaters finishing in the proper placements. At the completion of the event, the points are accumulated for each skater and those placing in the qualifying positions will move forward to the next round of competition, or in the case of the final event, be awarded medals for first, second and third.

SR935.3 The Chief Referee shall advise all skaters as to how the points are awarded before the start of the race.

**SR936 Elimination Races**

SR936.1 Heats are set-up based on the placement of skaters in the 300m Time Trials for Track and 200m Time Trials on Road and are organized using the serpentine system and according to the heating schedule listed below. Placement of contestants on the starting line is determined by the order of the skaters for that heat after the serpentine system has been applied and starting with the position on the first line and closest to the inside of the track. The number of skaters to be placed on each line at the start is determined by the width of the track used, with a distance of two (2) feet for each skater to be used as a guideline.

SR936.2 Skaters are eliminated from this event if on a prescribed lap that contestant crosses the finish line in last place. The last place skater to be eliminated from the race is determined by the last point of the last skate to cross the finish line.

SR936.3 As the skaters pass the start-finish line on the lap before the elimination lap begins, the starter will ring the bell so as to signify that on the next time across the finish line, the contestant crossing the finish line last will be eliminated from the race at that point. The determination of who is the last athlete is based on the last point of the last skate to cross the finish line. The bell schedule will be predetermined by the race organizers so as to leave five (5) contestants remaining in the race to skate the final two (2) laps in the final event. Depending on the size of the track and the number of contestants, double eliminations may be required. The double elimination shall start at the beginning of the race.

SR936.4 Should a skater retire from the competition by being disqualified, lapped or voluntarily leaving the event, this retirement will count as the next corresponding elimination or eliminations.

Heats for 10,000M & 15,000M points and elimination race and 15,000M & 20,000M elimination races

# Skaters	# Heats	# to Qualify	# Finals
41-80	2	15	30
1-40	Final		

**SR937 Marathons**

Guidelines for conducting the marathon events will be determined and published at the time and place of the competition.

**SR938 Distance Rule Definitions for Outdoor Nationals**

**SR938.1 Distance Rule Definition for Elimination or Points Elimination Races for Junior World Class and World Class**

In this event skaters will be eliminated by the bell down to the 5 skaters remaining with 2 laps to go in the race. Skaters may be eliminated if distanced by the leaders only if they are not contending for a point's positions 2-8. Skaters distanced by the race leaders who have lost contact with the 8<sup>th</sup> place skater may be distanced at the discretion of the head referee. Distanced skaters will be placed in reverse order of their elimination for overall race placement. In elimination races other than Junior World Class and World Class skater will be placed by the order they are eliminated by the bell or distanced.

**SR938.2 Distance Rule Definition for Points Race**

In this event skaters will be eliminated or distanced down to 10 skaters remaining in the race. Distanced skaters will be placed in reverse order of their elimination for overall race placement. Skaters in a position to be distanced by the race leader, but with a group that is all on the same lap and includes skaters who are not in a position to be distanced, will not be distanced at that time. However if this group later in the race breaks up and individuals or groups of individuals are again in a position to be distanced by the race leader they will be eliminated.

**SR940 GENERAL SPORT REGULATIONS**

**SR940.1** Competitors are strictly forbidden to accept any sort of help during the competition events.

**SR940.2** At the finish of an event, all skaters entering the last straightaway of the course must not obstruct any other skaters and must continue in a straight way to the finish line.

**SR940.3** Under no circumstances, can athletes push other competitors or cut in front of them.

**SR940.4** It is forbidden to let oneself be taken in tow by another competitor or to push, obstruct or help any opponent.

**SR940.5** On the track or road closed circuit competitions, athletes who are passed shall not obstruct or favor other competitors.

**SR940.6** Athletes are not allowed to touch the ground inside or outside of the lines defining the boundaries of the course track, where by shortening the course.

**SR940.7** In the case of a fall, competitors who are still able to continue the race must stand up without any help from non-competitors.

**SR940.8** All athletes must take part in races fairly and enthusiastically. Skaters deliberately slowing the pace down, may be excluded from the race after receiving a warning by the referee.

- SR940.9 In mass start races on open circuit roads, athletes must comply also with the above mentioned rules, always keeping to their right and in no case shall they overcome the centerline of the road.
- SR940.10 As skaters cross the finish line, placement is determined by the front point of the front wheel of the leading skate with at least one wheel being in contact with the floor. If the first skate is not in contact with the floor, then the placement is decided by the leading point of the competitor's second skate. In the event of a fall, the placement for any contestant whose skates do not have contact with the floor shall be determined by the leading point of the front wheel of the lead skate.
- SR940.11 Any contestant not abiding by the above rules and regulations are subject to disqualification by the Chief Referee.

**SR950 GENERAL CONDUCT OF OUTDOOR CHAMPIONSHIPS**

The Outdoor National Championships will utilize the CIC rulebook, with modifications to fit Nationals *and Trials* requirements. This includes the declassification and warnings that are issued in International competitions. *Automatic Suspension (art 181) from the World Skate Speed Technical Commission General Regulations is not adhered to at Trials.*

**SR951 Meet Director**

The national outdoor speed skating championships shall be under the control of the certified meet director who shall apply all CIC and USARS rules and regulations, and shall have the responsibility and authority to make decisions governing the activity, participants and spectators both on and off the track. (USARS may circumvent CIC rules where outlined in the USARS General Rules and Speed Rules.)

Some of the traditional duties are:

- SR951.1 The Meet Director of outdoor competitions, both qualifying and non-qualifying, will have the authority to alter the schedule of events due to adverse weather conditions or other unforeseen circumstances, and it will be the responsibility of each contestant to remain informed of such program changes so as to be prepared to skate when required to do so.
- SR951.2 Receive a listing of applicants and set-up heat schedules.
- SR951.3 Set-up practice time schedules and schedule of skating events .
- SR951.4 Hold orientation meetings with the coaches, contestants, and meet officials.
- SR951.5 Prepare meet report for the USARS National Office.
- SR951.6 Assign officials to help monitor the dormitories at the Olympic Training Center if athletes are housed on the site.
- SR951.7 Act as liaison between the Olympic Training Center and Velodrome officials, if a USARS Board and/or staff member has not been assigned this responsibility.
- SR951.8 The Certified Meet Director of the Track and Road National Speed Skating Championships will be furnished a mobile phone for the purposes of safety and communication.
- SR951.9 The Speed Committee shall serve as the "Rules Committee" at both Indoor and Outdoor Nationals as requested by the Meet Director, in a non-compensated capacity.

**SR952****Meetings**

There should be an orientation meeting for all contestants, officials, and coaches prior to the start of any practice sessions or skating of any events. The Meet Director will cover the USARS Code of Conduct, and Olympic Training Center rules and regulations. The transportation schedule for both athletes and officials should also be covered. Contestants may also check in during this meeting and receive their numbers. The Chief Referee must attend this meeting and should cover the rules of competition, clear up any misinterpretation of rules and assign duties to the officials who have not been approved for a designated position.

**SR953****Contestant Numbers**

For outdoor contests, each contestant will be issued a number containing no more than three digits. One number will be approximately 4" high and should be pinned on the back at the shoulders. One number will be approximately 3" high and should be pinned on the hip that would be used for a photo finish device. An optional number approximately 2" high should be placed on the helmet. Number panels must not be altered in any way, such as cutting, folding, etc.

**SR960****OUTDOOR NATIONAL RACE OFFICIALS**

## SR960.1

During all races, competitors are closely watched by several judges positioned at various points around the track. Blocking, holding, pushing, and other personal and illegal tactics on the part of the skaters are penalized at the discretion of the judges.

## SR960.2

Each competition is directed by a group of officials. The minimum number of officials necessary for the competition should include:

- A. One Chief Referee
- B. Four or more track referees
- C. One tabulator
- D. One starting judge
- E. Three or more placement judges
- F. One competitive steward judge
- G. Three time-keepers

**SR961****The Chief Referee**

The Chief Referee presides over all of the officials and is charged with the responsibility of ensuring that each contest is a fair event and that all competitive rules are enforced. The Chief Referee must be a CIC certified official unless there are no CIC certified officials available. The Chief Referee vouches directly for his own actions to USARS and will have complete and final authority over the running of the events and the handling of disputes that may arise. When any condition, such as inclement weather or insufficient light hinders the safety of the competition or any of its competitors or the continuation of the same, the Chief Referee MUST stop the competition until conditions are corrected or cancel it. When the interrupted competition re-convenes, only those skaters who were competing at the moment of the interruption shall be allowed to participate. The Chief Referee is in charge of the technical and disciplinary control of the competition. Therefore, he or she shall:

## SR961.1

Guarantee that all competitors and officials comply with the rules and regulations. Decide on any technical matters that might arise during a competition, even when not covered in these regulations.

- SR961.2 Assign to each member of the officiating staff his or her particular responsibilities.
- SR961.3 Preside over all the officials, coordinate any decisions and handle any discrepancies. Shall also prepare a report on the performance of the panel and submit it to the Speed Officials Committee.
- SR961.4 Exert his/her disciplinary power towards competitors, trainers, and officials when their behavior on the course site requires the adoption of disciplinary actions as provided for in these regulations.
- SR961.5 Decide over the re-running of any event, when the event has not been carried out correctly. This also applies to time trial events and when skate failure occurs during the event and in the other causes included in these regulations.
- SR961.6 Approve documents of the competition to be forwarded to USARS together with the reports of other possible events that might have occurred during the competition.
- SR961.7 Direct the drawing for the order of starting and the drawing of sprints.
- SR961.8 Check that the judges are in the right place and that time-keepers are ready before ordering the starter to give the starting signal.
- SR961.9 In case of immediate disqualification, insure that it is announced and that the disqualified athlete immediately leaves the track.
- SR961.10 Remove or replace those judges who, in his/her opinion, do not completely carry out their duties.
- SR955.11 Shall decide on any protests submitted by the coaches of the athletes participating in the competitions.
- SR961.11 In mass start events, the Chief Referee, at his or her discretion, may call for a restart of an event, if a competitor falls down on the track and causes several other competitors to fall, and more precisely within the first 1/2 lap from the starting line.

**SR962 The Track Referees**

The track referees have the following responsibilities and duties:

- SR962.1 Will be stationed on the straight-aways and curves of the track; will supervise the progress of the event for the portion of which they are responsible.
- SR962.2 Using disqualification slips and current rules for calling fouls, track referees will immediately report to the Chief Referee via radio headsets any irregularities which take place during the event.
- SR962.3 If necessary, the track referees will assist the Chief Referee by getting the contestant's attention so that they leave the track.
- SR962.4 To take note of lapped competitors, and of those athletes who withdrew and inform the Chief Referee.

**SR963 The Tabulator**

The tabulator has tasks as follows:

- SR963.1 To cooperate with the Chief Referee, particularly in regard to the settlement of the preliminary heats.
- SR963.2 In the preparation of individual placements and ranking.
- SR963.3 The completion of tabulating sheets and any supporting documents that will later be submitted to the Chief Referee for signing.

**SR964 The Starting Judge**

The starting judge has tasks as follows:

- SR964.1 Only standing starts are permitted for all races.
- SR964.2 Before the beginning of each event, the starter should gather all of the competitors and give them any last-minute instructions.
- SR964.3 Should inform the Chief Referee when an athlete does not report to the starting line at the moment of the starting signal is given, the athlete will be excluded from the event.
- SR964.4 The starter should check to see that all the competitors skates are behind the starting line.
- SR964.5 The starter will give the starting signal only after the Chief Referees' consent.
- SR964.6 Once the skaters are in their final starting position, the starter shall fire the starting pistol. No command is required.
- SR964.7 In case of a false start, the starter will fire the starting pistol again, in order to call back the competitors to the starting line. Then the skater or skaters who, in the opinion of the officials controlling the start will warn those who have caused the false start. Three false starts shall be cause for the competitors elimination.
- SR964.8 Shall keep track of the number of laps that have been completed and that are remaining in the event by way of a set of lap cards. These lap cards will be placed in a position directly after the start/finish line such that the competitors may see them when passing that point.
- SR964.9 Shall also signify to the contestants the last lap of a race by ringing a bell positioned at the start/finish line.

**SR965 The Placement Judge**

The placement judges have tasks as follows:

- SR965.1 The placement judges will exactly determine the finishing order of all competitors necessary for the competition.
- SR965.2 In mass start distance races, the number of judges shall be established according to the requirements of the event. The Chief Referee shall establish the tasks for each judge.
- SR965.3 The minimum judges shall be three (3), according to the requirements of the event being skated. Such a number can be increased but shall always be an odd number. In case of any

discrepancies, the decision will be made by the Chief Referee. In any case, when the photo finish of an event is used, it will be binding.

SR965.4 As skaters cross the finish line, placement is determined by the front point of the front wheel of the leading skate with at least one wheel being in contact with the floor. If the first skate is not in contact with the floor, then the placement is decided by the leading point of the competitor's second skate. In the event of a fall, the placement for any contestant whose skates do not have contact with the floor shall be determined by the leading point of the front wheel of the lead skate.

#### **SR966 The Competitive Steward Judge**

The competitive steward judge has tasks as follows:

SR966.1 Before each event, the judge should check every competitor to insure that they have their competitive number and that the numbers are applied according to regulations.

SR966.2 To inform all competitors of when they must be at the starting line before the event for which they have been entered.

SR966.3 To insure that no one has access to the track before the Chief Referee has given his/her authorization.

SR966.4 To prevent competitors who have already finished the event from going back onto the track.

#### **SR965 The Time Keeping Judge**

The time keeping judges have tasks as follows:

SR965.1 If no photo-finish and photo-electric cells are available, the task of the time-keepers are to determine the time achieved by the skaters in each event. The recorded time results will then be delivered by the time-keeper directly to the tabulator.

SR965.2 In order to guarantee the exact determination of times, it is necessary to observe the following:

A. Times are to be taken by three official time-keepers.

B. Stop-watches are to be of a special type approved for competitions.

C. When two out of three stop-watches are in agreement, the time indicated by such two will be considered official.

D. When the three stop-watches indicate three different times, the average of the three times is considered official. If one of the three watches is 0.5 greater than or less than the other two watches, that time will be excluded and the official time will be the average of the remaining two watches.

E. When only two stop-watches register the time, the slower time indicated will be considered official.

SR965.3 Timers must stand as close to the starting line as possible. In events where the starting line is a long distance from the finishing line, timers can be located at the finishing line and they shall start their stop-watches as soon as they see the smoke of the gun or by the use of a flag which indicates the gun has been fired by the starter.

SR965.4 All timers must report their times in recorded by the watches to the hundredth of a second.

SR964.5 In road races, organizers must also provide transportation for the timers, in order to carry them from the starting line to the finish line if they are in different locations.

SR965.6 For national championships, the use of photo-finish equipment and electronic time-keeping are compulsory. For time trials, the photo-electric cell is compulsory at the start and finish.

**SR970 OFFICIALS UNIFORM**

It is recommended that the uniform of International competition be the dress standards used by USARS officials who officiate any of the outdoor competitions. This dress code consists of white shirt, white slacks or shorts, knee length, (for women, white blouse and white skirt, shorts or slacks), white socks and white shoes. No tank tops or t-shirts will be allowed. In addition, the FIRS badge shall be worn by any international judges in attendance on the left part of their shirt.



## **SPEED SKATING DICTIONARY**

**competitive roller skater** - A person who conducts him or herself in the Olympic tradition of good sportsmanship while engaging in USARS competitions and all other sponsored activities of the Confederation. The competitor must be truthful and honorable in dealing with other athletes and officials and when establishing eligibility for USARS competitive events which are determined by age or previous competitive experience. There are no occupational requisites or restrictions applied to USARS competitive eligibility.

**barrier** - The outside wall, railing, or traffic line forming the boundaries of the skating surface.

**blocking** - A foul; any unnatural method used by one skater to prevent another from passing, with or without body contact.

**captain** - A member chosen by a relay team to represent them in an official capacity. Since only relay team members are allowed on the skating surface during a relay event, rules do not permit appointment of another skater or non-skating captain.

**championship** - 1. A group of contests qualifying a skater to or toward the national championships; sometimes called a qualifying meet. 2. A non-qualifying meet which follows specific rules concerning officials, awards and events, such as a league or unofficial state championship.

**charging** - A foul; a trailing skater overtaking another skater in such a manner as to cause body contact which disrupts the normal progression of the skater or skaters passed.

**chief timekeeper** - The official responsible for determining the official time of a race, which is to be recorded by the tabulator.

**club** - A group of skaters registered in the USARS for the purpose of promoting and enjoying competitive roller skating.

**commission** - A certification granted by USARS to individuals who meet the requirements for officiating or refereeing in speed skating contests.

**competitive age** - The age of a contestant as of January 1st of the current competitive year.

**competitive steward** - An official charged with the undelayed succession of competitors in their proper order for each race. Also charged with checking contestants for compliance with uniform, equipment and safety rules.

**competitive year** - The period beginning on September 1st of one year and ending on August 31st of the next succeeding year, dates inclusive.

**corner** - 1. The area of the skating surface permitting the shortest linear dimension parallel to the barrier, or at right angles to the straightaway; the area of a skating surface of least length. 2. Any one of four positions on a track indicating a proper placement of a corner marker. 3. The area in the vicinity of the corner marker.

**corner marker** - A device, officially designated by rule as to size and construction, placed at each of the four corners of a speed track; also known as pylons.

**disqualification** - 1. Elimination from consideration for placement. 2. Elimination of an individual contestant for an infraction of procedures or rules of conduct. 3. Elimination of a team because of an individual or team

rule infraction. 4. Elimination of an entire club from participation in a contest for flagrant or continual violation of the rules. 5. Elimination from one race in a division of competition. 6. Meet disqualification-Elimination from all races, including relays, in a competition.

**distanced skater** - A skater who is further than one lap behind the leader or leaders of a race and not in a position to place and is disqualified by the referee for being distanced.

**elbowing** - A foul; use of the elbows by a contestant which interferes with the progress of another contestant.

**event** - One race in a division of competition.

**false start** - 1. Any start which must be recalled. 2. Any infraction or irregularity on the part of a skater or skaters which necessitates a restart. 3. Any irregularity on the part of officials or spectators which necessitates a restart.

**final** - The concluding race in a particular distance of a division, or, the concluding race of a division competition.

**final placement** - The rank of the contestants or teams after the completion of all races in a division of competition.

**finish** - The end of any race; the instant the last remaining contestant completes the final lap of a race.

**finish line** - The line marking the completion of a distance at which a race is to end.

**flying start** - An illegal start; a skater being in rolling motion prior to the starting signal for a race. This does not apply to the open-type races where a rolling start is used, with the referee leading a pace lap or laps from the inside of the track to the timing line.

**foul** - A violation of a rule, procedure or conduct. 1. personal-a violation by one skater against another 2.technical-a violation of track rule or procedure 3. team-a violation of team rules in a relay race

**gate area** - 1. A marked or painted system of lanes from which members of a relay team enter a race. 2. The center area of the skating surface located to the inside of the speed track.

**heat** - A preliminary race qualifying contestants to a semi-final or final in a given distance of a division.

**hipping** - A foul; the intentional use of the hips by a contestant to gain an advantage over or disrupt the progress of another contestant.

**jamming** - A foul; a skater suddenly slowing up, causing the trailing skaters to run into each other.

**judge** - 1. Corner judge-a commissioned official stationed outside each corner marker to observe the performance of contestants within the area and to note any infractions, personal or technical, which occur. 2. Placement judge-a commissioned official stationed at the finish line of a race to determine in what order a contestant finished. 3. Auxiliary corner judge-same duties as corner judge. 4. Chief placement judge-a commissioned official assigned the responsibility of listing the placement of all skaters in an event, checking placement of the place judges and submitting place sheet forms, in the order of placement, to the tabulator. 5. Relay judge-a commissioned official responsible for relay team conduct pertaining to number of laps, legality of relay and gate area conduct.

**lane** - Any one single part of a gate area, each lane being a maximum of two-and-a-half feet wide and a maximum of 22 feet long.

**lap** - 1. One complete circuit of the measured and marked track. In relay skating, a complete circuit is considered to be from pylon 4 to pylon 4. (The lap is considered complete when the skater enters the relay zone.) 2. The count of the lap being skated.

**lap counter** - A series of cards or an electronic device used to indicate or announce the number of laps remaining to be skated.

**lapped skater** - A skater who has been overtaken by the leader or leaders of the race and allowed to continue by the referee. The overtaken skater being at least one lap behind and may be in position to place.

**leaving the gate area** - In relays, a contestant is considered to have left the gate area when he or she has all the wheels of both skates outside of the designated gate area.

**loafing** - The act of any skater not skating to the best of his/her ability.

**meet** - A competition consisting of more than one contest.

**meter** - The basic unit of length in the metric system; equivalent to 39.37 inches.

**no contest** - A ruling by the referee which requires that a heat, semi-final or a final be re-run.

**pace** - 1. The stride and rate of movement maintained by a group of skaters in a pack; distinguishable from a sprint by the unity of movement among the several skaters in the pack. 2. The rate of progression of the leading skater in a race.

**pass** - The act of a trailing skater overtaking a leading skater and moving into a more forward position in the pack.

**passing area** - Any part of or location on an official track.

**points** - The value of first, second, third or fourth place in a final race.

**protest** - A written complaint concerning status, eligibility, conduct, competition, officials or membership. (See USARS General Rules, section 12.00.)

**pushing** - A foul; intentional body conduct by one skater against another

**pylon** - Same as corner marker.

**qualifying meet** - A group of contests qualifying a skater to or toward the national championships.

**qualifying placement** - 1. Placement in a race which is high enough to permit advancement to the next race in the same contest. 2. Placing first, second or third in a contest which permits advancement to the same contest in the next higher ranking championship. 3. Placing first, second, third or fourth in a Junior Olympic contest which permits advancement to the same contest in the next higher ranking championship.

**race** - A contest between two or more skaters to determine which can skate a given distance in the fastest time; sometimes called an event.

**re-entry zone** - The area of the track between pylons 1 and 2 through which a member of a relay team must pass when returning to the gate area.

**referee** - A commissioned official to discharge the duties as required by rule and prescribed for the contests to be skated.

**relay** - 1. Any kind of speed skating involving two or more skaters functioning as a unit as provided by rule. 2. The act of relieving a team member in a relay race. When the actual relay is made, both skaters' skates must be inside the relay zone.

**relay zone** - The area of the track within which a relay must be completed as defined by rule and properly designated on the track.

**re-skate** - 1. To repeat any part of a contest; also called re-run. 2. The act of repeating any part of a contest which has been nullified by the referee.

**riding in** - A foul; contestant's body contact from the outside of the track forcing another skater from the line of travel.

**riding out** - A foul; contestant's body contact from the inside of the track forcing another skater from the line of travel.

**right-of-way** - The privilege of leading contestants to an unobstructed track when overtaking a lapped skater or skaters. (This privilege does not include permission for leading contestants to push or make contact with the lapped skater or skaters.)

**shoving** - A foul; one skater intentionally pushing another with the intent to impede his or her progress in the race.

**shuttle skating** - A foul; abnormal movement from side to side across the normal line of travel by a leading skater to hinder a trailing skater.

**sprint** - 1. A distance not to exceed 1500m. 2. The act of a contestant in taking the lead and leaving the pack in a distance race; breaking the pace to take the lead.

**start** - The beginning of any race in a speed contest; the sounding of the starter's gun.

**starter** - The commissioned official whose duty is to start races in a speed contest.

**starting line** - The line marked on the track from which a race is to begin.

**straddling the pylons - Occurring** when a skater has one skate on the floor outside the pylon and one or more wheels of the other skate touching the floor inside the pylon.

**straightaway** - 1. The area of the skating surface permitting the greatest linear dimension parallel to the barrier; the area of a skating surface of greatest length. 2. The area of a track between corner markers 2 and 3, and markers 4 and 1.

**tabulator** - A commissioned official whose duties include recording the entry and tabulation of contest results.

**teamwork** - A foul; two or more skaters acting together to prevent another or others from passing.

**timer** - A commissioned official whose duty is to determine the elapsed time of any race.

**timing line** - The designated position on the track where the timers' watches are started to begin recording the elapsed time of a race. On a 100m track, the timing line will be located in the same position as the finish line.

**track** - An official registered course, laid out and marked on a skating surface for the purpose of running races. The inside boundary of the track is indicated by corner markers, the outside boundary by the wall, barrier or outermost edge of the skating surface.

**tripping** - A foul; action by one skater which obstructs another's footing, whether or not a fall results.

**weaving** - A foul; irregular or unnecessary side to side movement of a contestant when skating the straightaway of the track-a type of blocking.