

MedalLists
2026 U.S. OPEN CHAMPIONSHIPS
Male Dragon
As of 05 MAR 2026

Medal	Name	Noc
GOLD	WONG Kingsley	CAN-Canada



Contest Results
2026 U.S. OPEN CHAMPIONSHIPS
Final Male Dragon
As of 05 MAR 2026



Rank	Contest No	NOC	Name	Score	Acc/Tech	Total	Detail					
					Pre		Game	Score	Acc/Tech	Pre	Total	Deduct
1	376	CAN	WONG Kingsley	7.516	5.966	74.4	Game1	7.733	3.133	4.600	38.7	0.0
					9.066		Game2	7.299	2.833	4.466	35.7	0.0



MedalLists
2026 U.S. OPEN CHAMPIONSHIPS
Male Tiger
As of 05 MAR 2026

Medal	Name	Noc
GOLD	KUZHUPPALLIL Nigel	USA-United States of America
SILVER	LONG Nathan	
BRONZE	AGPALZA Ezra	
	CHANG Ryuji	



Contest Results
2026 U.S. OPEN CHAMPIONSHIPS
Final Male Tiger
As of 05 MAR 2026



Rank	Contest No	NOC	Name	Score	Acc/Tech	Total	Detail					
					Pre		Game	Score	Acc/Tech	Pre	Total	Deduct
1	252	USA	KUZHUPPALLIL Nigel	7.965	6.599	78.8	Game1	7.932	3.266	4.666	39.1	0.0
					9.332		Game2	7.999	3.333	4.666	39.7	0.0
2	249	USA	LONG Nathan	7.866	6.633	78.5	Game1	8.033	3.300	4.733	39.8	0.0
					9.099		Game2	7.699	3.333	4.366	38.7	0.0
3	250	USA	AGPALZA Ezra	7.832	6.566	78.6	Game1	7.766	3.233	4.533	39.1	0.0
					9.099		Game2	7.899	3.333	4.566	39.5	0.0
4	251	USA	CHANG Ryuji	7.616	6.466	75.8	Game1	7.733	3.300	4.433	38.4	0.0
					8.766		Game2	7.499	3.166	4.333	37.4	0.0



MedalLists
2026 U.S. OPEN CHAMPIONSHIPS
Male Youth
As of 05 MAR 2026

Medal	Name	Noc
GOLD	PARK Nicholas Sechan	USA-United States of America
SILVER	ZHOU Aiden	
BRONZE	VILLALOBOS Elon	
	SHIN Jian	



Contest Results
2026 U.S. OPEN CHAMPIONSHIPS
Final Male Youth
As of 05 MAR 2026



Rank	Contest No	NOC	Name	Score	Acc/Tech	Total	Detail					
					Pre		Game	Score	Acc/Tech	Pre	Total	Deduct
1	31002	USA	PARK Nicholas Sechan	8.233	6.700	82.2	Game1	8.433	3.500	4.933	41.9	0.0
					9.766		Game2	8.033	3.200	4.833	40.3	0.0
2	31005	USA	ZHOU Aiden	8.083	6.566	80.4	Game1	8.333	3.433	4.900	41.4	0.0
					9.600		Game2	7.833	3.133	4.700	39.0	0.0
3	31004	USA	VILLALOBOS Elon	8.082	6.532	80.4	Game1	8.299	3.466	4.833	41.3	0.0
					9.633		Game2	7.866	3.066	4.800	39.1	0.0
4	31008	USA	SHIN Jian	8.033	6.400	79.9	Game1	8.166	3.300	4.866	40.8	0.0
					9.666		Game2	7.900	3.100	4.800	39.1	0.0
5	31001	USA	CHOI Jonah	7.999	6.499	79.3	Game1	8.066	3.333	4.733	40.3	0.0
					9.499		Game2	7.932	3.166	4.766	39.0	0.0
6	31003	USA	HAN Boyee	7.999	6.566	79.7	Game1	8.132	3.366	4.766	40.4	0.0
					9.432		Game2	7.866	3.200	4.666	39.3	0.0
7	31007	USA	CHOI Daniel	7.966	6.333	79.9	Game1	8.166	3.333	4.833	41.0	0.0
					9.599		Game2	7.766	3.000	4.766	38.9	0.0





Contest Results
2026 U.S. OPEN CHAMPIONSHIPS
Final Male Youth
As of 05 MAR 2026



Rank	Contest No	NOC	Name	Score	Acc/Tech	Total	Detail					
					Pre		Game	Score	Acc/Tech	Pre	Total	Deduct
8	31006	USA	HAN Alex	7.933	6.400	79.2	Game1	8.166	3.400	4.766	40.8	0.0
					9.466		Game2	7.700	3.000	4.700	38.4	0.0



MedalLists
2026 U.S. OPEN CHAMPIONSHIPS
Male Cadet
As of 05 MAR 2026

Medal	Name	Noc
GOLD	JOMALESA Gabriel	USA-United States of America
SILVER	PHAN Kaiden	
BRONZE	CHOI Jaden	
	TU Nathan	



2026 U.S. OPEN CHAMPIONSHIPS

THU 05 MAR 2026



Male Cadet Contestants: 51

Round of 64 Round of 32 Round of 16 Quarterfinals Semifinals Final Semifinals Quarterfinals Round of 16 Round of 32 Round of 64

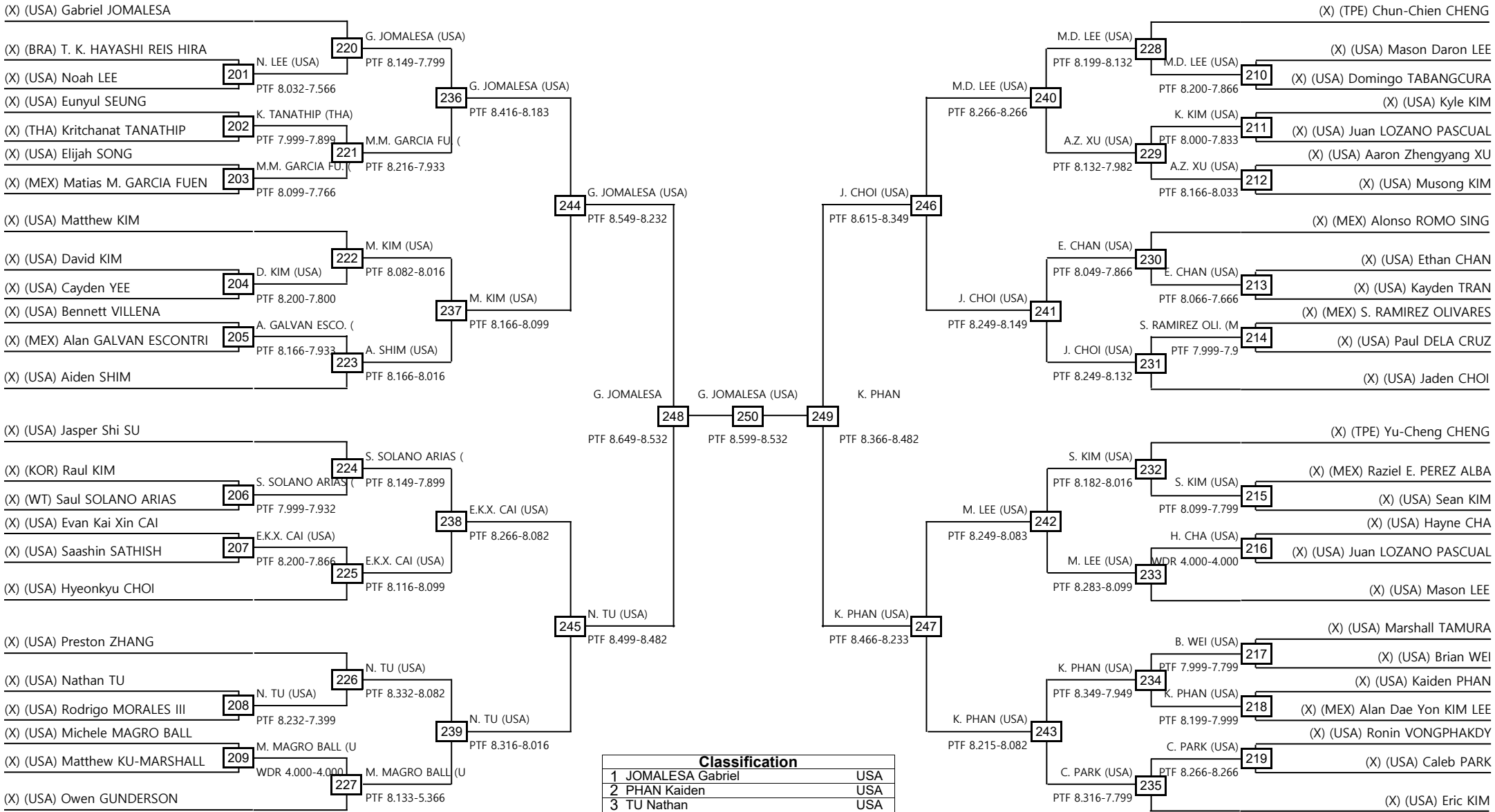

LEGEND
 (x): Seed PTF: Win by final score WDR: Win by Withdrawal



MedalLists
2026 U.S. OPEN CHAMPIONSHIPS
Male Junior
As of 05 MAR 2026

Medal	Name	Noc
GOLD	ONG Whye Jing	USA-United States of America
SILVER	MORENO GOMEZ Juan Carlos	MEX-Mexico
BRONZE	VOILLARD Tim	FRA-France
	TANG Lucas	USA-United States of America



2026 U.S. OPEN CHAMPIONSHIPS

THU 05 MAR 2026



Male Junior Contestants: 41

Round of 64 Round of 32 Round of 16 Quarterfinals Semifinals Final Semifinals Quarterfinals Round of 16 Round of 32 Round of 64

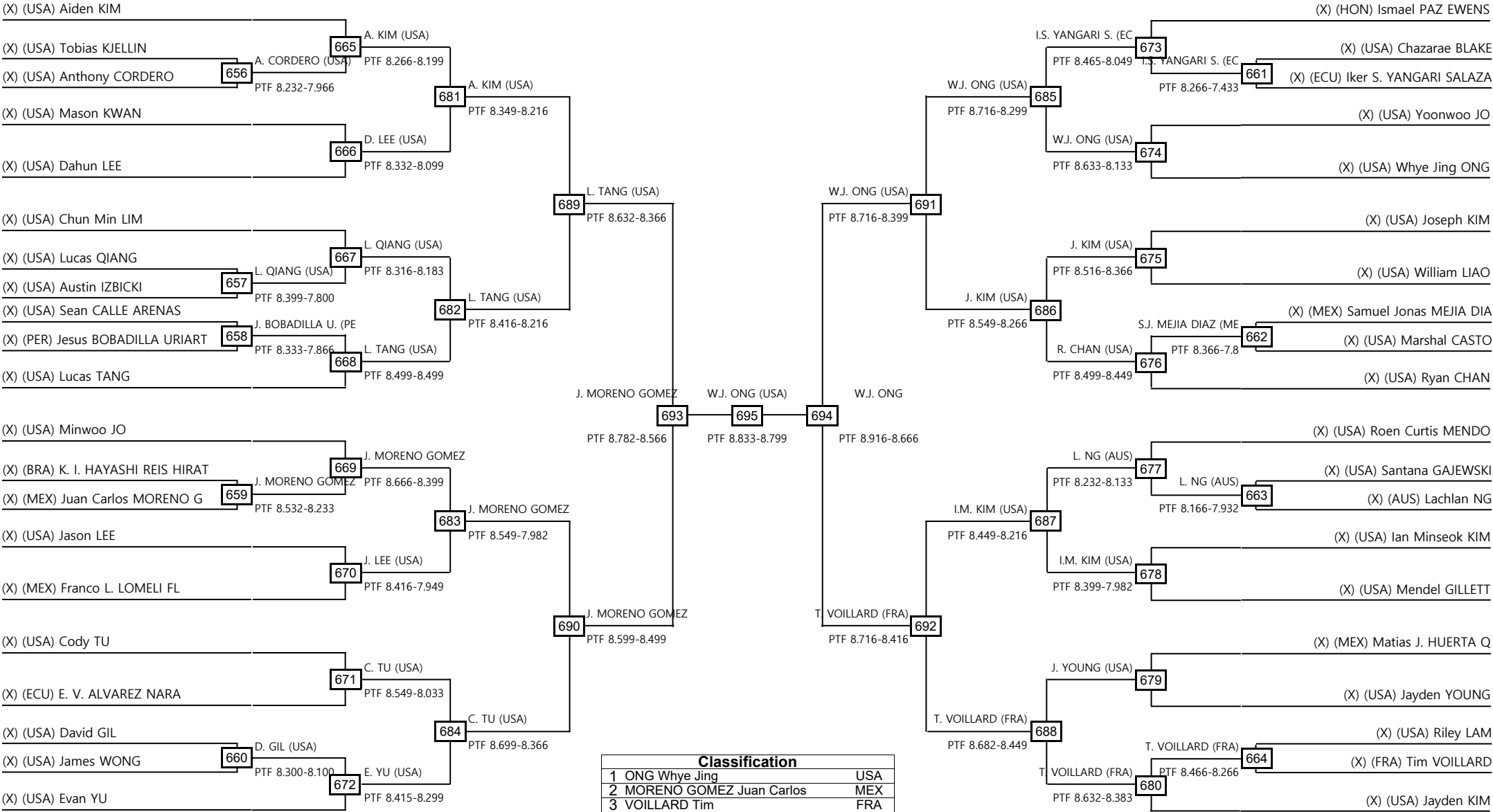

LEGEND
 (x): Seed PTF: Win by final score WDR: Win by Withdrawal



MedalLists
2026 U.S. OPEN CHAMPIONSHIPS
Male Under 30
As of 05 MAR 2026

Medal	Name	Noc
GOLD	GUN Sung Hyun Eric	USA-United States of America
SILVER	REAL Ryan	
BRONZE	LIU Ho Yin	HKG-Hong Kong, China
	ARROYO William	MEX-Mexico



2026 U.S. OPEN CHAMPIONSHIPS

THU 05 MAR 2026



Male Under 30 Contestants: 57

Round of 64 Round of 32 Round of 16 Quarterfinals Semifinals Final Semifinals Quarterfinals Round of 16 Round of 32 Round of 64

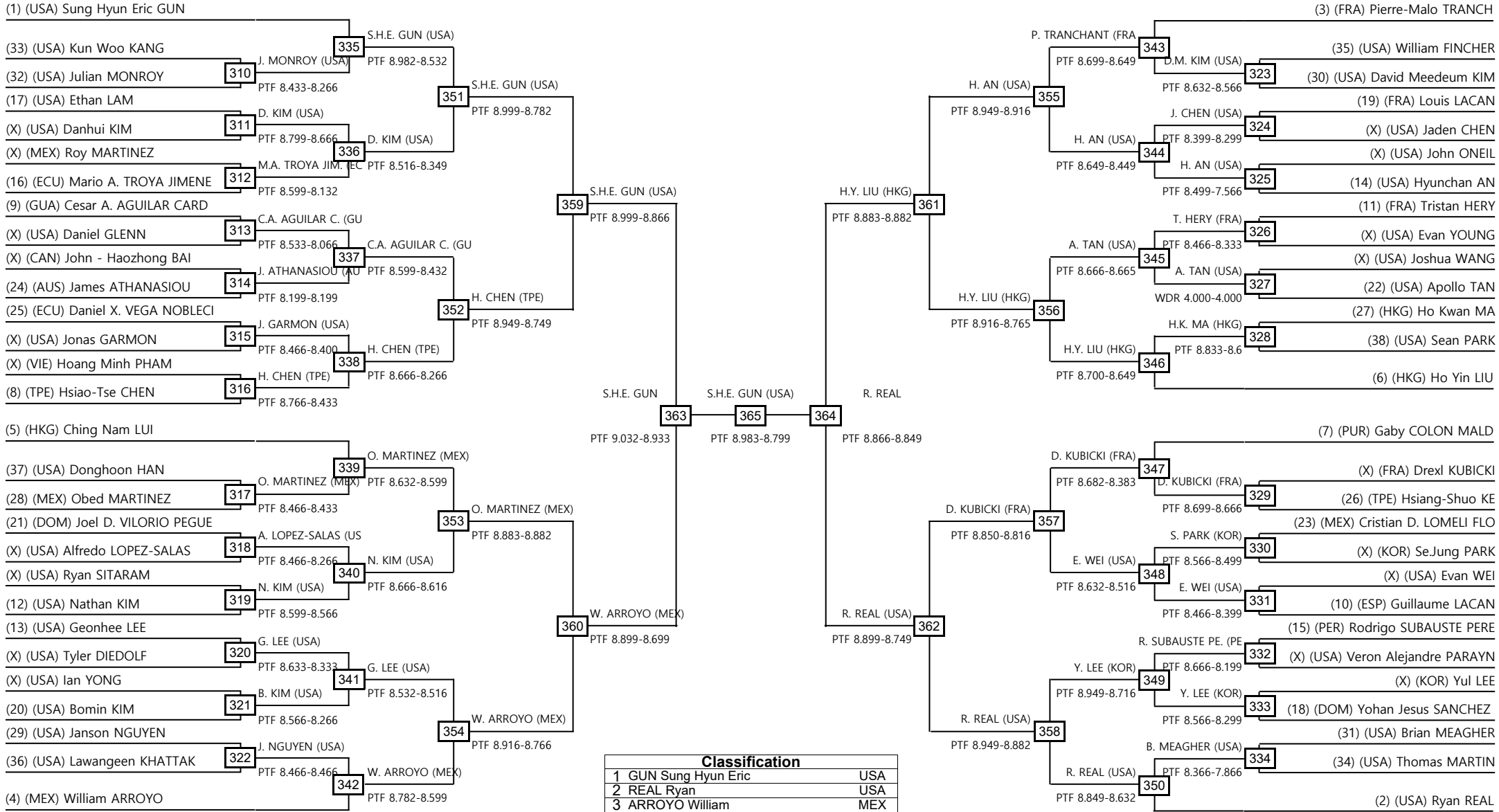

LEGEND
 (x): Seed PTF: Win by final score WDR: Win by Withdrawal



MedalLists
2026 U.S. OPEN CHAMPIONSHIPS
Male Under 40
As of 05 MAR 2026

Medal	Name	Noc
GOLD	LEBLANC Selgi	FRA-France
SILVER	LU Kevin	USA-United States of America
BRONZE	CHOI Minseung	AUS-Australia
	JUNG Sean	USA-United States of America

Male Under 40 Contestants: 8

Quarterfinals Semifinals Final Semifinals Quarterfinals

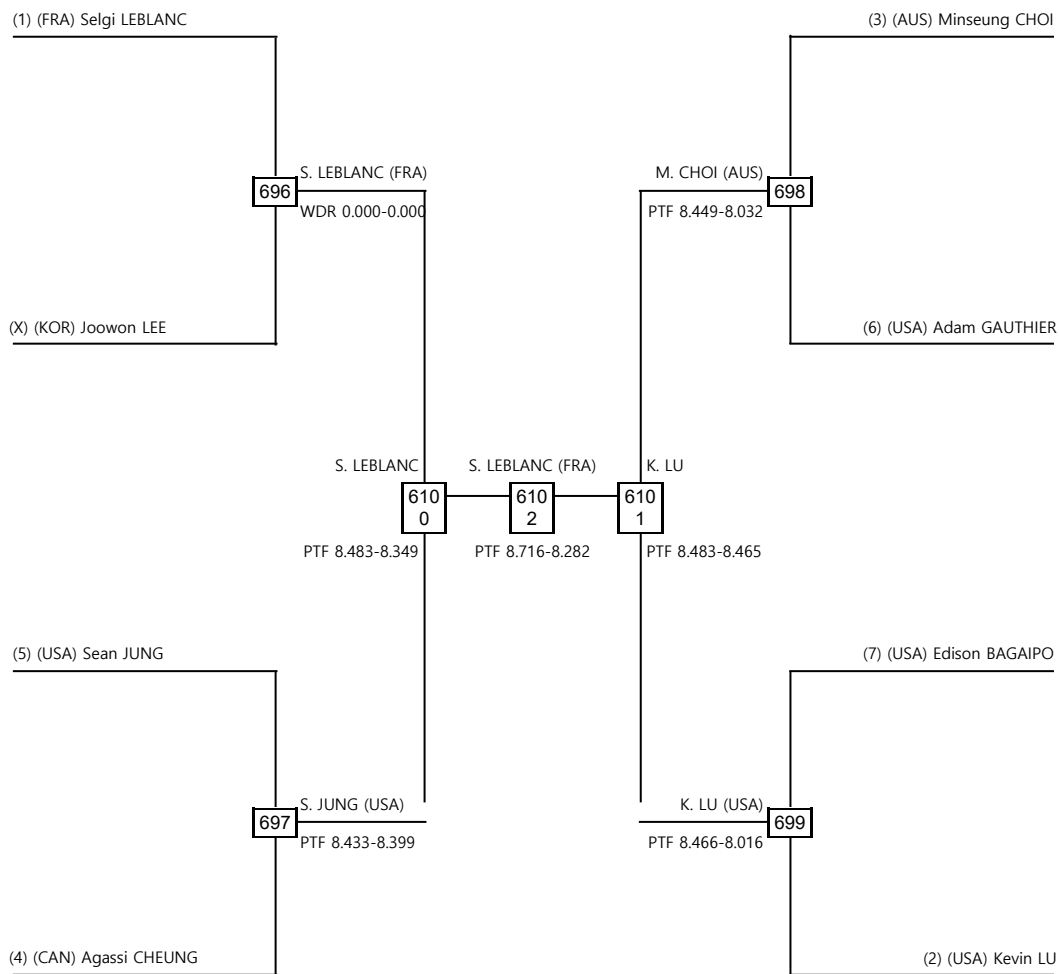

Classification	
1	LEBLANC Selgi FRA
2	LU Kevin USA
3	CHOI Minseung AUS
3	JUNG Sean USA

LEGEND

(x): Seed PTF: Win by final score

WDR: Win by Withdrawal

MedalLists
2026 U.S. OPEN CHAMPIONSHIPS
Male Under 50
As of 05 MAR 2026

Medal	Name	Noc
GOLD	SEONG Minki	USA-United States of America
SILVER	ARAU TORRES Alfonso	MEX-Mexico
BRONZE	MACADIANG Abdoulaye Diaco	SEN-Senegal
	CHO Joon	USA-United States of America

Male Under 50 Contestants: 14

Round of 16 Quarterfinals Semifinals Final Semifinals Quarterfinals Round of 16

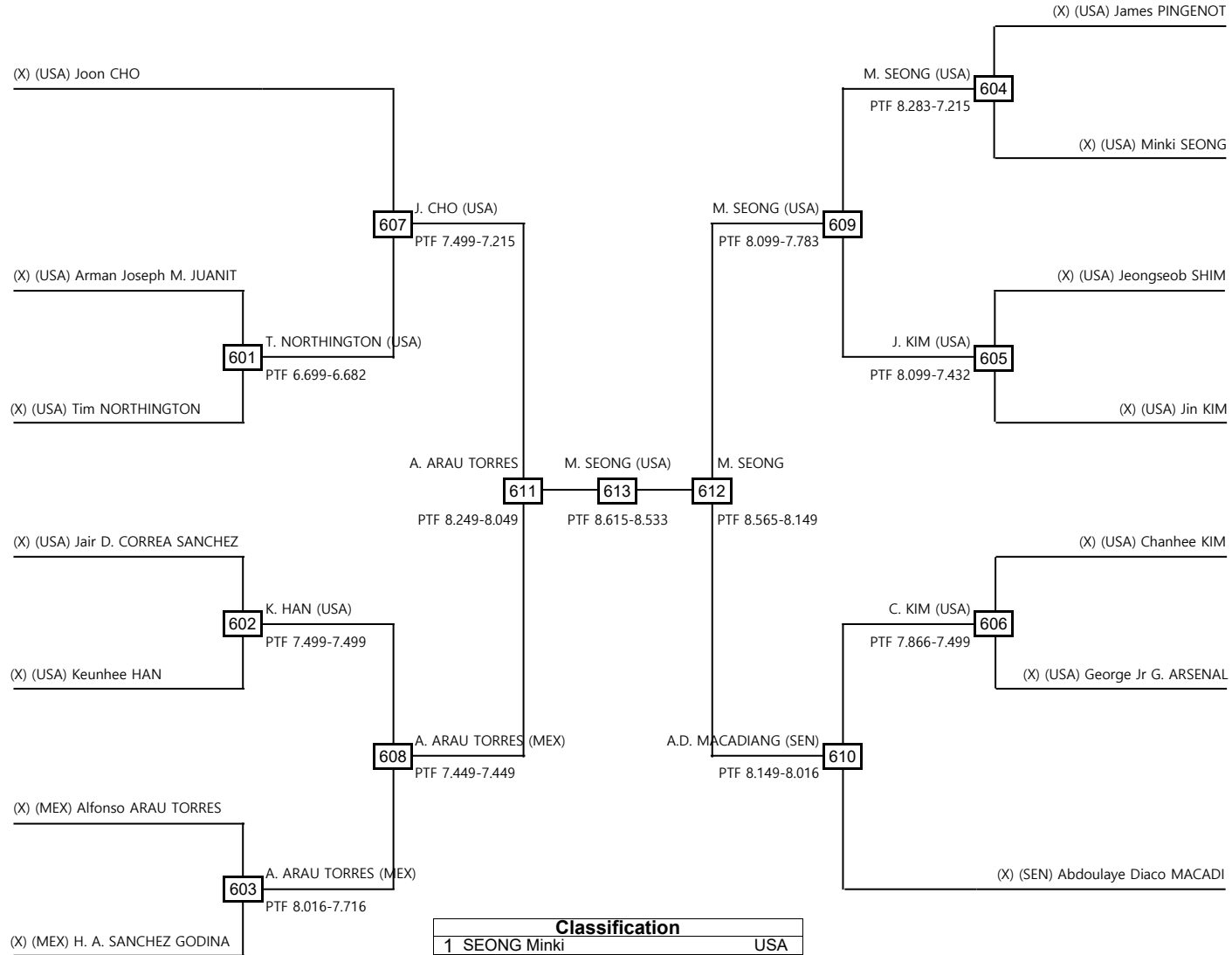

LEGEND
(x): Seed PTF: Win by final score

WDR: Win by Withdrawal

MedalLists
2026 U.S. OPEN CHAMPIONSHIPS
Male Under 60
As of 05 MAR 2026

Medal	Name	Noc
GOLD	YANG Pok Sun	USA-United States of America
SILVER	BRICENO Carlos	
BRONZE	CUASCUT Agustin	
	KIM Giseon	

Male Under 60 Contestants: 11

Round of 16 Quarterfinals Semifinals Final Semifinals Quarterfinals Round of 16

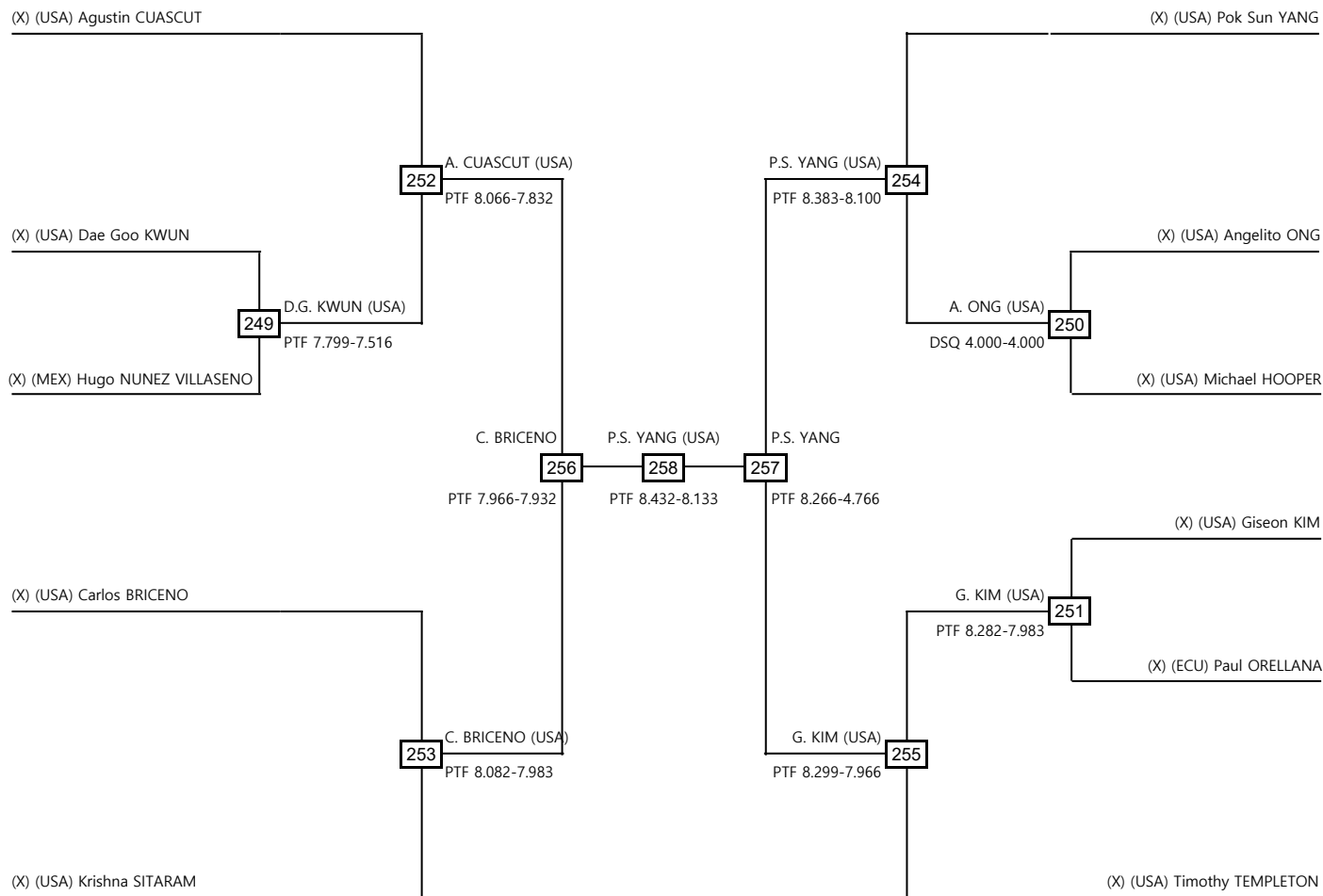

Classification	
1	YANG Pok Sun USA
2	BRICENO Carlos USA
3	CUASCUT Agustin USA
3	KIM Giseon USA

LEGEND

(x): Seed PTF: Win by final score

WDR: Win by Withdrawal

MedalLists
2026 U.S. OPEN CHAMPIONSHIPS
Male Under 65
As of 05 MAR 2026

Medal	Name	Noc
GOLD	LEE Eun Ig	USA-United States of America
SILVER	SOUTHWICK Ronald	
BRONZE	JEONG Kh	
	UM Gi Woo	

Male Under 65 Contestants: 6

Quarterfinals Semifinals Final Semifinals Quarterfinals

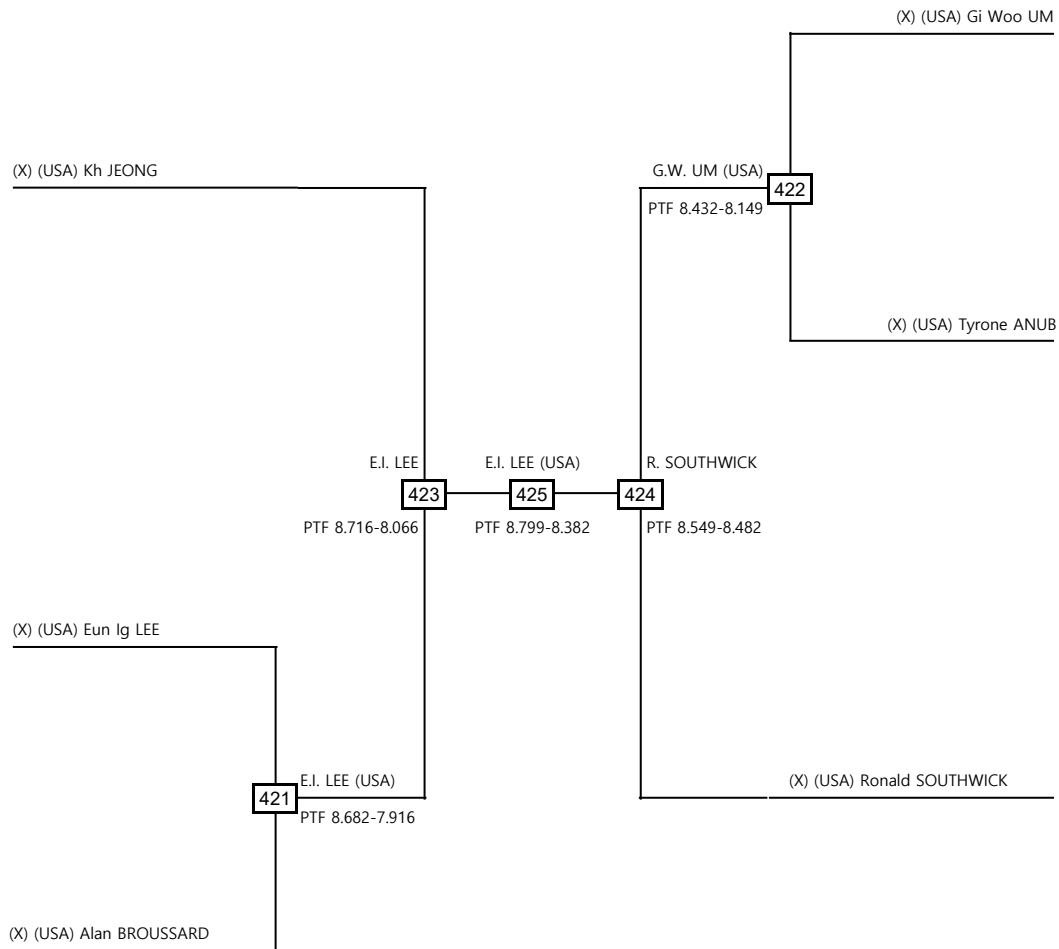

Classification		
1	LEE Eun Ig	USA
2	SOUTHWICK Ronald	USA
3	JEONG Kh	USA
3	UM Gi Woo	USA

LEGEND

(x): Seed PTF: Win by final score

WDR: Win by Withdrawal

MedalLists
2026 U.S. OPEN CHAMPIONSHIPS
Male Over 65
As of 05 MAR 2026

Medal	Name	Noc
GOLD	PARK James	USA-United States of America
SILVER	COUGHLIN Joseph	
BRONZE	GAMBLE William	
	McCUE Kent	

Male Over 65 Contestants: 5

Quarterfinals Semifinals Final Semifinals Quarterfinals

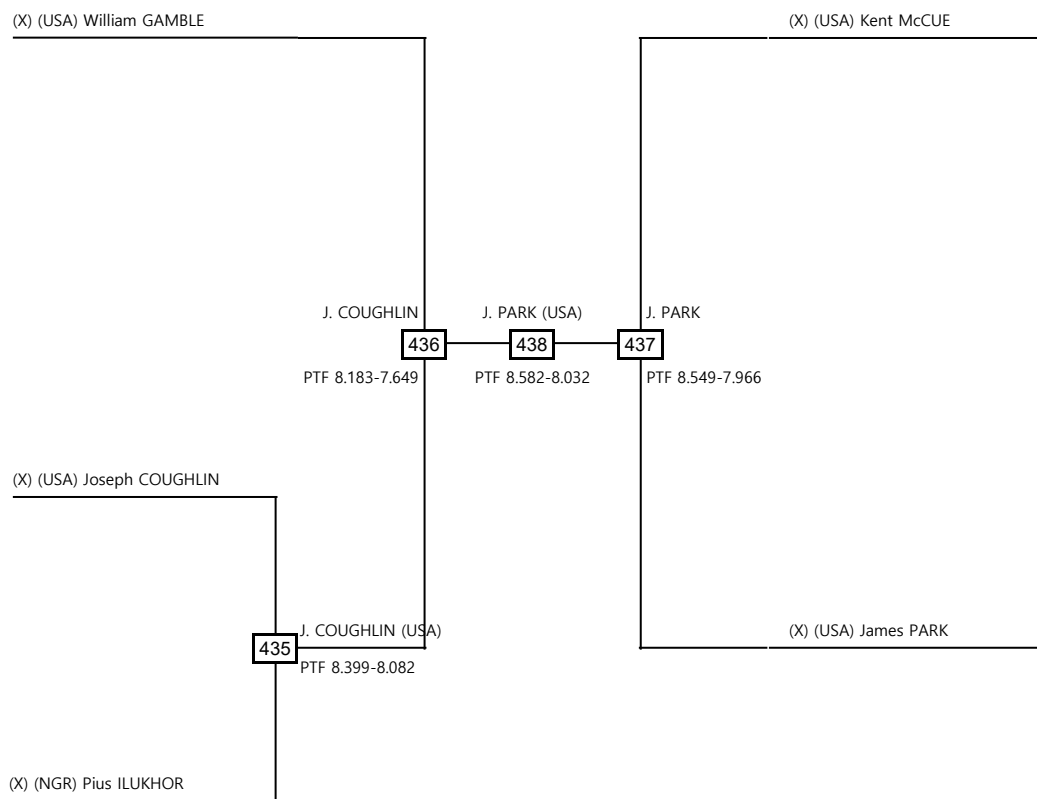

Classification		
1	PARK James	USA
2	COUGHLIN Joseph	USA
3	GAMBLE William	USA
3	McCUE Kent	USA

LEGEND

(x): Seed PTF: Win by final score

WDR: Win by Withdrawal

MedalLists
2026 U.S. OPEN CHAMPIONSHIPS
Female Tiger
As of 05 MAR 2026

Medal	Name	Noc
GOLD	JUNE Joy	USA-United States of America
SILVER	YOON Jia	
BRONZE	WONG Sophia	
	LEAPAGA Haven	



Contest Results
2026 U.S. OPEN CHAMPIONSHIPS
Final Female Tiger
As of 05 MAR 2026



Rank	Contest No	NOC	Name	Score	Acc/Tech	Total	Detail					
					Pre		Game	Score	Acc/Tech	Pre	Total	Deduct
1	635	USA	JUNE Joy	8.283	6.566	83.2	Game1	8.366	3.366	5.000	42.2	0.0
					10.000		Game2	8.200	3.200	5.000	41.0	0.0
2	638	USA	YOON Jia	8.099	6.433	81.2	Game1	8.233	3.333	4.900	41.3	0.0
					9.766		Game2	7.966	3.100	4.866	39.9	0.0
3	636	USA	WONG Sophia	8.082	6.466	80.9	Game1	8.199	3.366	4.833	41.2	0.0
					9.699		Game2	7.966	3.100	4.866	39.7	0.0
4	637	USA	LEAPAGA Haven	7.549	5.899	76.3	Game1	7.999	3.266	4.733	40.6	0.0
					9.199		Game2	7.099	2.633	4.466	35.7	0.0



MedalLists
2026 U.S. OPEN CHAMPIONSHIPS
Female Youth
As of 05 MAR 2026

Medal	Name	Noc
GOLD	HYUN Elisa	USA-United States of America
SILVER	CHU Hailey	
BRONZE	KIM Sion	
	KATAYAMA Jordyn	

Contest Results
2026 U.S. OPEN CHAMPIONSHIPS
Final Female Youth
As of 05 MAR 2026



Rank	Contest No	NOC	Name	Score	Acc/Tech	Total	Detail					
					Pre		Game	Score	Acc/Tech	Pre	Total	Deduct
1	41007	USA	HYUN Elisa	8.133	6.600	81.5	Game1	8.166	3.300	4.866	40.8	0.0
					9.666		Game2	8.100	3.300	4.800	40.7	0.0
2	41006	USA	CHU Hailey	8.033	6.633	80.5	Game1	8.033	3.333	4.700	40.1	0.0
					9.433		Game2	8.033	3.300	4.733	40.4	0.0
3	41008	USA	KIM Sion	8.016	6.566	80.2	Game1	8.066	3.300	4.766	40.3	0.0
					9.466		Game2	7.966	3.266	4.700	39.9	0.0
4	41003	USA	KATAYAMA Jordyn	7.999	6.566	79.3	Game1	7.866	3.200	4.666	39.2	0.0
					9.432		Game2	8.132	3.366	4.766	40.1	0.0
5	41001	USA	DOMINGO Lorinne	7.916	6.499	79.3	Game1	7.899	3.266	4.633	39.8	0.0
					9.333		Game2	7.933	3.233	4.700	39.5	0.0
6	41004	USA	MA Helen	7.850	6.600	78.7	Game1	7.800	3.300	4.500	38.9	0.0
					9.100		Game2	7.900	3.300	4.600	39.8	0.0
7	41002	USA	GONZALES Ailey	7.849	6.366	78.4	Game1	7.766	3.100	4.666	38.9	0.0
					9.332		Game2	7.932	3.266	4.666	39.5	0.0



Contest Results
2026 U.S. OPEN CHAMPIONSHIPS
Final Female Youth
As of 05 MAR 2026



Rank	Contest No	NOC	Name	Score	Acc/Tech	Total	Detail					
					Pre		Game	Score	Acc/Tech	Pre	Total	Deduct
8	41005	USA	HEO Anna	7.699	6.366	77.0	Game1	7.699	3.166	4.533	38.3	0.0
					9.033		Game2	7.700	3.200	4.500	38.7	0.0



MedalLists
2026 U.S. OPEN CHAMPIONSHIPS
Female Cadet
As of 05 MAR 2026

Medal	Name	Noc
GOLD	LEE Arianna	USA-United States of America
SILVER	SUH Katherine	
BRONZE	TSANG Kori	
	YANG Emma	



2026 U.S. OPEN CHAMPIONSHIPS

THU 05 MAR 2026



Female Cadet Contestants: 85

Round of 128 Round of 64 Round of 32 Round of 16 Quarterfinals Semifinals Quarterfinals Round of 16 Round of 32 Round of 64 Round of 128

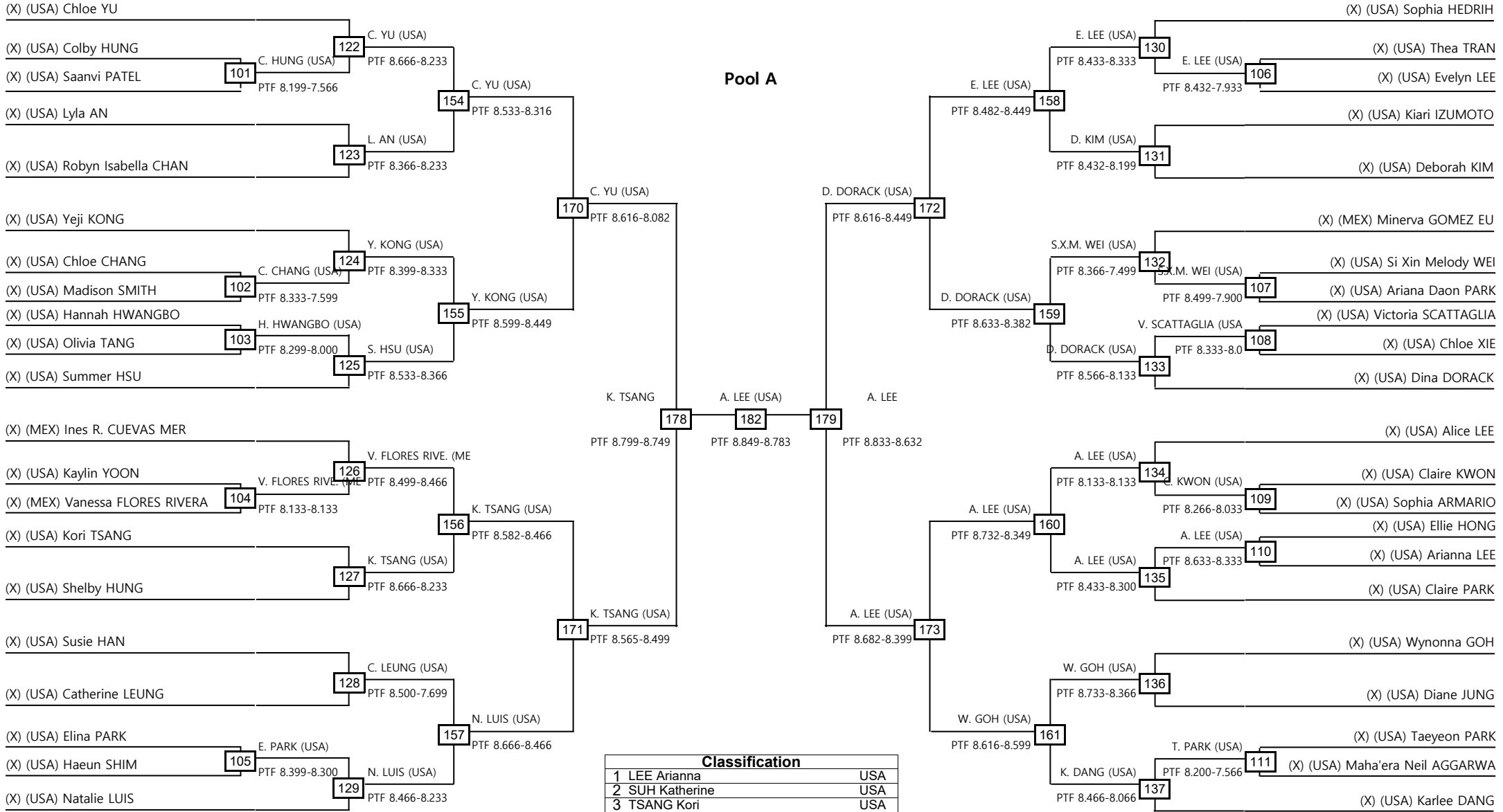

LEGEND

(x): Seed PTF: Win by final score

WDR: Win by Withdrawal





2026 U.S. OPEN CHAMPIONSHIPS

THU 05 MAR 2026



Female Cadet Contestants: 85

Round of 128 Round of 64 Round of 32 Round of 16 Quarterfinals Semifinals Quarterfinals Round of 16 Round of 32 Round of 64 Round of 128

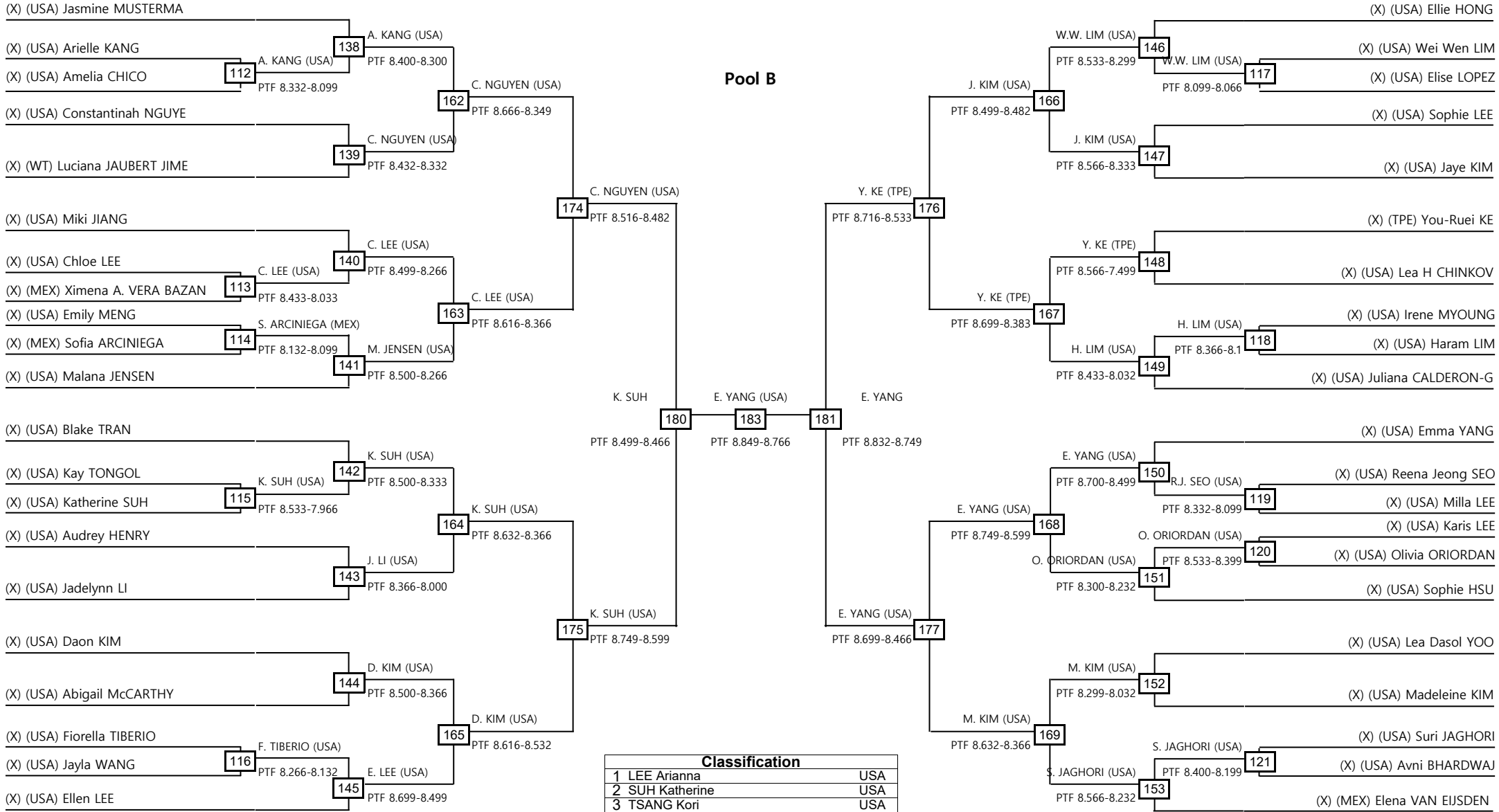

LEGEND
 (x): Seed PTF: Win by final score

WDR: Win by Withdrawal



Female Cadet Contestants: 85

Semifinals Final Semifinals

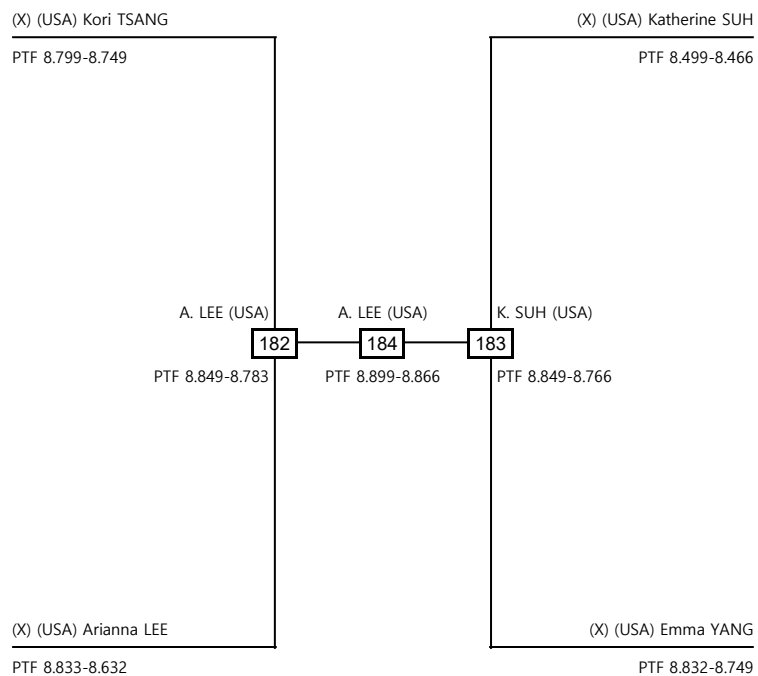

Classification		
1	LEE Arianna	USA
2	SUH Katherine	USA
3	TSANG Kori	USA
3	YANG Emma	USA

LEGEND

(x): Seed PTF: Win by final score

WDR: Win by Withdrawal

MedalLists
2026 U.S. OPEN CHAMPIONSHIPS
Female Junior
As of 05 MAR 2026

Medal	Name	Noc
GOLD	CHEUNG Evelyn	USA-United States of America
SILVER	LEE KIM Seo Yoon Sofia	MEX-Mexico
BRONZE	LIU Sophia	USA-United States of America
	TU Clara	



2026 U.S. OPEN CHAMPIONSHIPS

THU 05 MAR 2026



Female Junior Contestants: 59

Round of 64 Round of 32 Round of 16 Quarterfinals Semifinals Final Semifinals Quarterfinals Round of 16 Round of 32 Round of 64

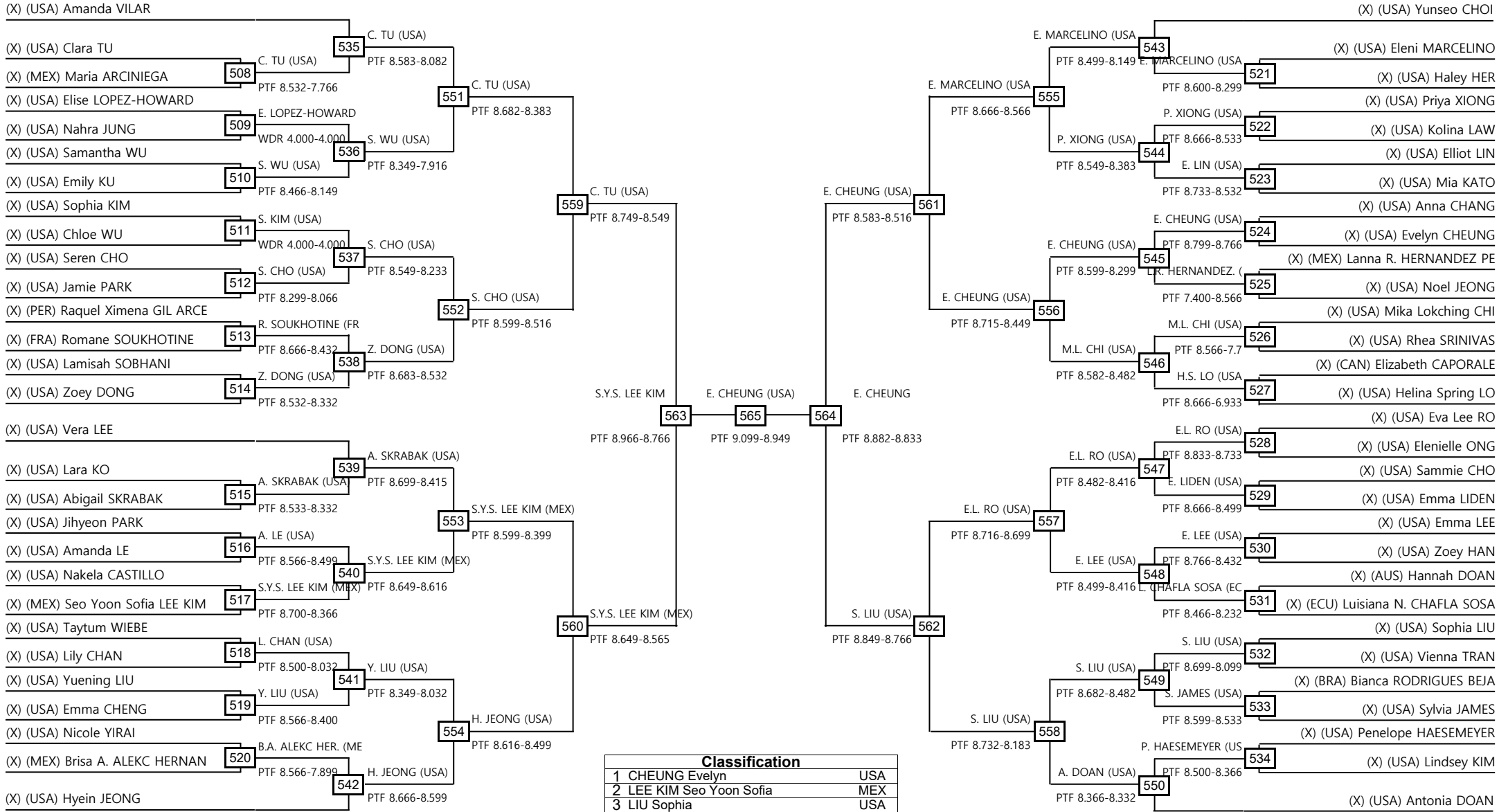

LEGEND
 (x): Seed PTF: Win by final score WDR: Win by Withdrawal



MedalLists
2026 U.S. OPEN CHAMPIONSHIPS
Female Under 30
As of 05 MAR 2026

Medal	Name	Noc
GOLD	RECLUSADO Kaitlyn Marie	USA-United States of America
SILVER	HIGUEROS Alejandra	GUA-Guatemala
BRONZE	VARILLAS Fabiana	PER-Peru
	NGUYEN Phan Khanh Han	VIE-Vietnam



2026 U.S. OPEN CHAMPIONSHIPS

THU 05 MAR 2026



Female Under 30 Contestants: 71

Round of 128 Round of 64 Round of 32 Round of 16 Quarterfinals Semifinals Quarterfinals Round of 16 Round of 32 Round of 64 Round of 128

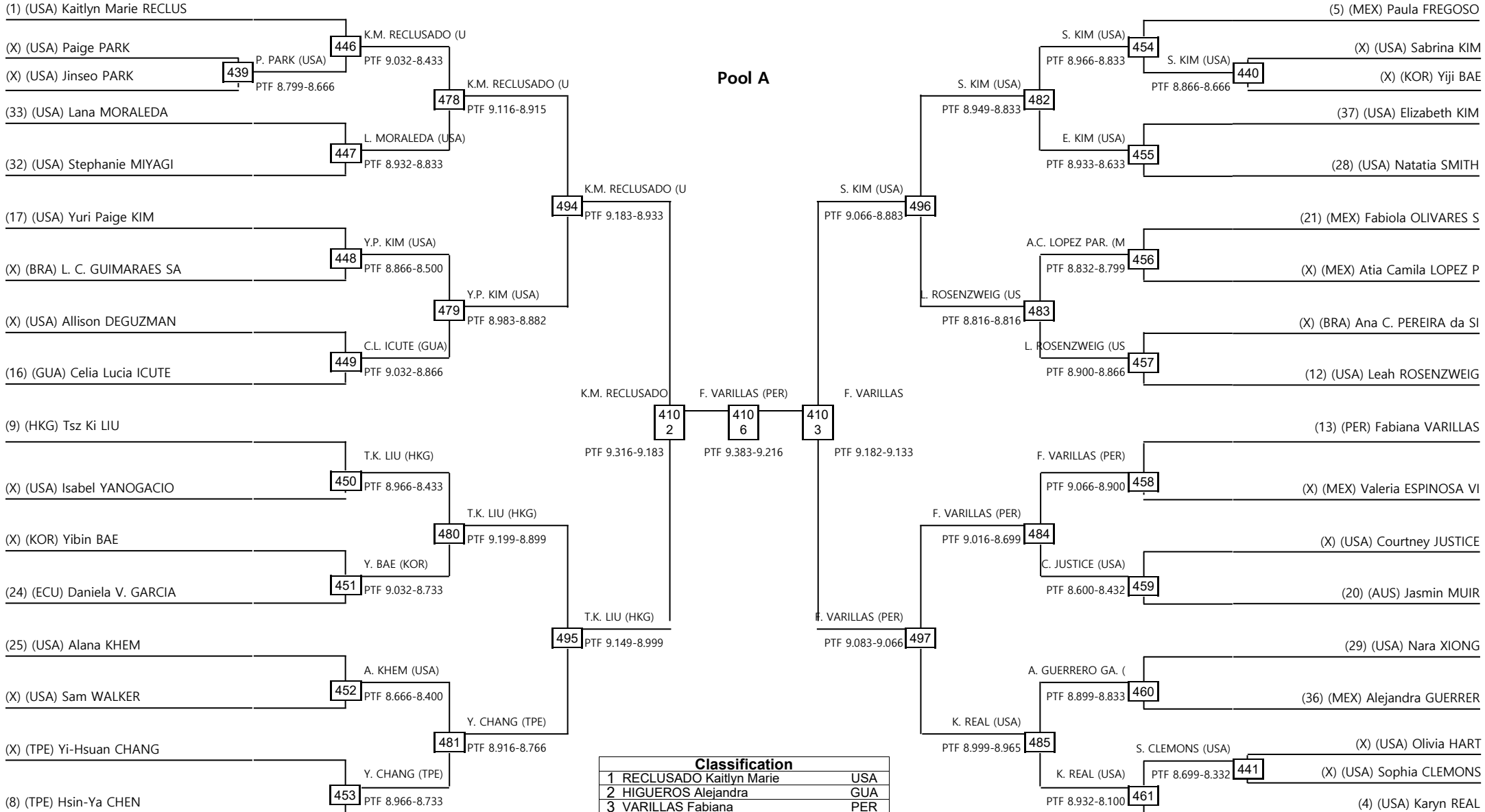

LEGEND
(x): Seed PTF: Win by final score

WDR: Win by Withdrawal





2026 U.S. OPEN CHAMPIONSHIPS

THU 05 MAR 2026



Female Under 30 Contestants: 71

Round of 128 Round of 64 Round of 32 Round of 16 Quarterfinals Semifinals Quarterfinals Round of 16 Round of 32 Round of 64 Round of 128

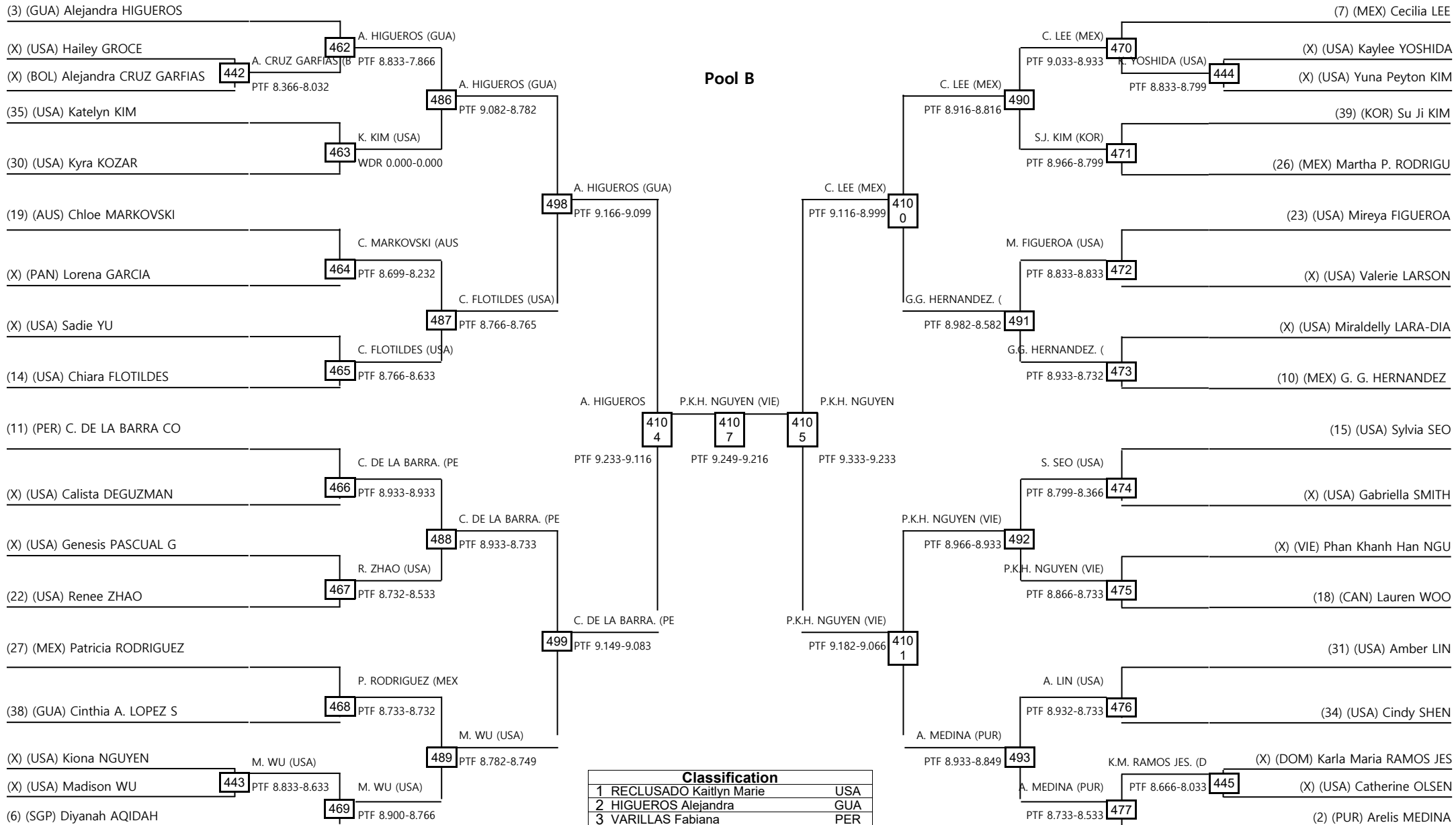

LEGEND
 (x): Seed PTF: Win by final score WDR: Win by Withdrawal



Female Under 30 Contestants: 71

Semifinals Final Semifinals

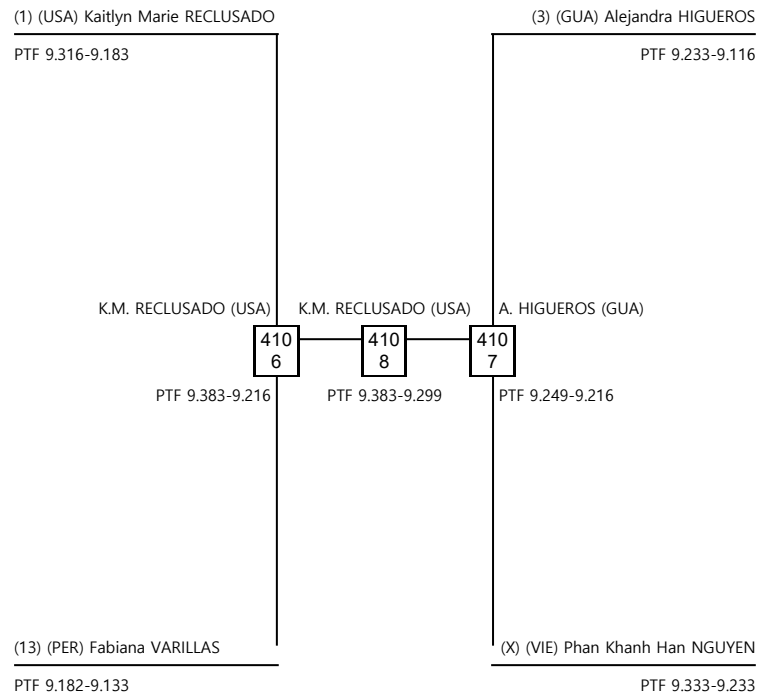

Classification

1	RECLUSADO Kaitlyn Marie	USA
2	HIGUEROS Alejandra	GUA
3	VARILLAS Fabiana	PER
3	NGUYEN Phan Khanh Han	VIE

LEGEND

(x): Seed PTF: Win by final score

WDR: Win by Withdrawal

MedalLists
2026 U.S. OPEN CHAMPIONSHIPS
Female Under 40
As of 05 MAR 2026

Medal	Name	Noc
GOLD	CHAU Tuyet Van	VIE-Vietnam
SILVER	KONG Lai Lee	HKG-Hong Kong, China
BRONZE	FONG Lui Lois	CAN-Canada
	PECK Nathalie	USA-United States of America

Female Under 40 Contestants: 18

Round of 32 Round of 16 Quarterfinals Semifinals Final Semifinals Quarterfinals Round of 16 Round of 32

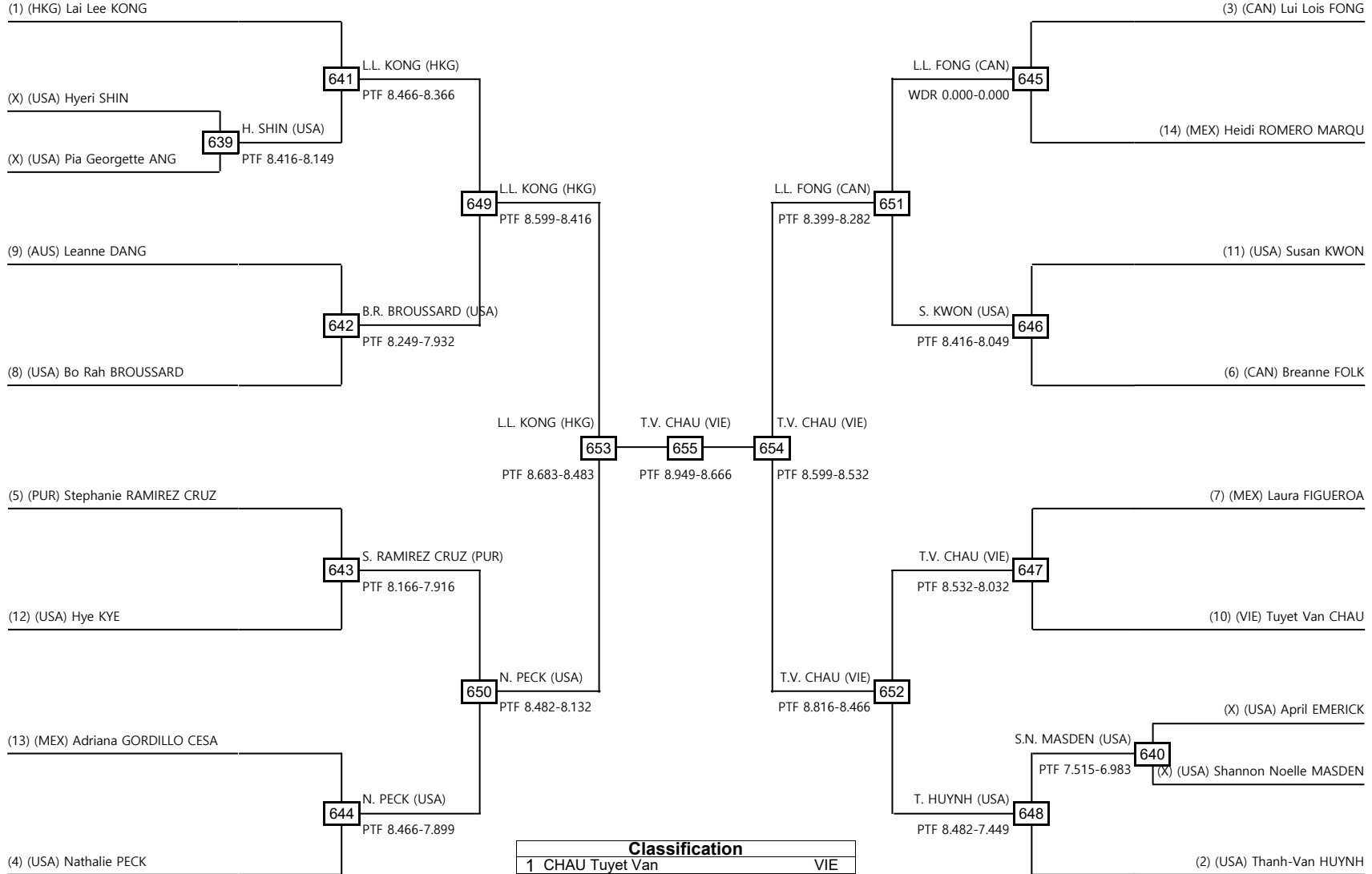

LEGEND
(x): Seed PTF: Win by final score WDR: Win by Withdrawal

MedalLists
2026 U.S. OPEN CHAMPIONSHIPS
Female Under 50
As of 05 MAR 2026

Medal	Name	Noc
GOLD	DO Kathy	USA-United States of America
SILVER	AYRES Jessica Mari	
BRONZE	LUK Joanne	CAN-Canada
	DO Juliet	USA-United States of America

Female Team Under 50 Contestants: 3

Semifinals Final Semifinals

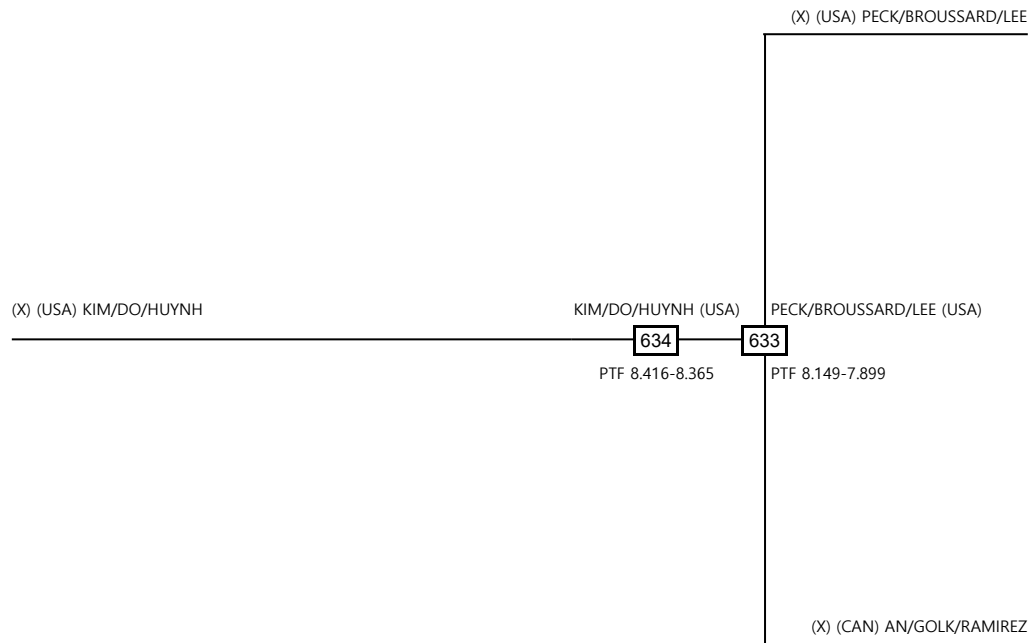

Classification

1	KIM/DO/HUYNH	USA
2	PECK/BROUSSARD/LEE	USA
3	AN/GOLK/RAMIREZ	CAN
3		

LEGEND

(x): Seed PTF: Win by final score

WDR: Win by Withdrawal

MedalLists
2026 U.S. OPEN CHAMPIONSHIPS
Female Under 60
As of 05 MAR 2026

Medal	Name	Noc
GOLD	ADAMS Elva	USA-United States of America
SILVER	GALICHET Marina	FRA-France
BRONZE	KIM Sheena	USA-United States of America
	TRIGG Jan	

Female Under 60 Contestants: 12

Round of 16 Quarterfinals Semifinals Final Semifinals Quarterfinals Round of 16

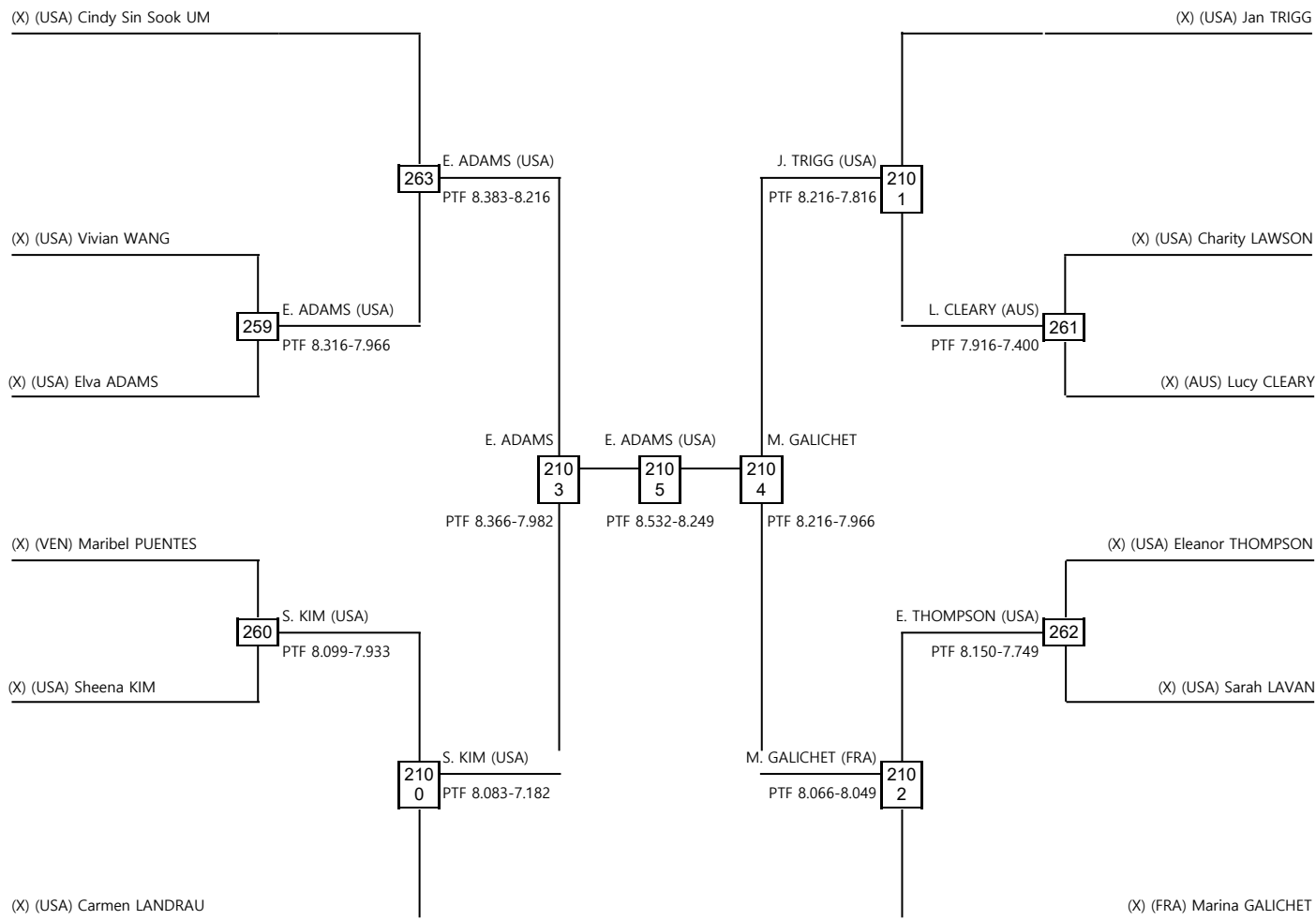

Classification		
1	ADAMS Elva	USA
2	GALICHET Marina	FRA
3	KIM Sheena	USA
3	TRIGG Jan	USA

LEGEND

(x): Seed PTF: Win by final score

WDR: Win by Withdrawal

MedalLists
2026 U.S. OPEN CHAMPIONSHIPS
Female Under 65
As of 05 MAR 2026

Medal	Name	Noc
GOLD	DOOLITTLE Thu	USA-United States of America
SILVER	SMITH Amber	
BRONZE	TOLSTRUP Kirsten	
	TOWNSEND Anita	

Female Under 65 Contestants: 4

Semifinals Final Semifinals

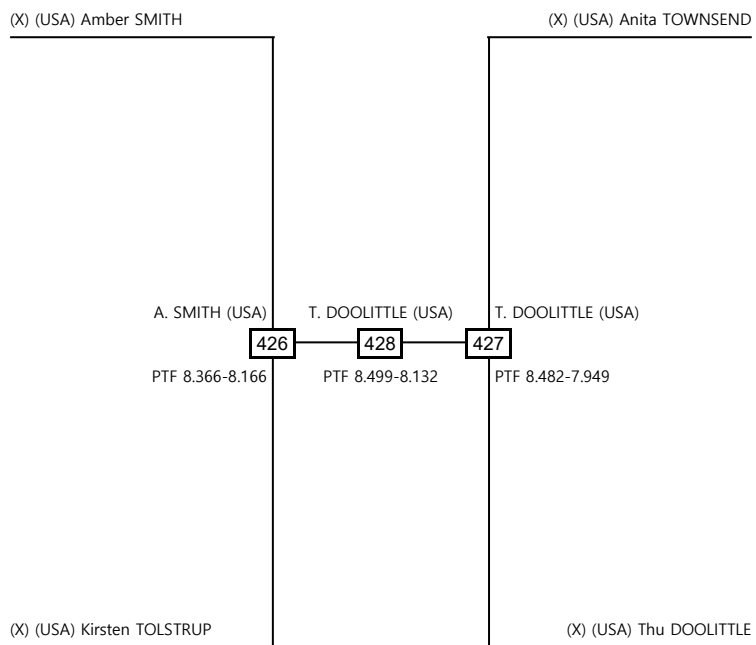

Classification		
1	DOOLITTLE Thu	USA
2	SMITH Amber	USA
3	TOLSTRUP Kirsten	USA
3	TOWNSEND Anita	USA

LEGEND

(x): Seed PTF: Win by final score

WDR: Win by Withdrawal

MedalLists
2026 U.S. OPEN CHAMPIONSHIPS
Female Over 65
As of 05 MAR 2026

Medal	Name	Noc
GOLD	BUTTERWORTH Bronwyn	AUS-Australia
SILVER	NGUYEN Tweedy	USA-United States of America
BRONZE	BURNS Susan	
	SHAW Maria	

Female Over 65 Contestants: 7

Quarterfinals Semifinals Final Semifinals Quarterfinals

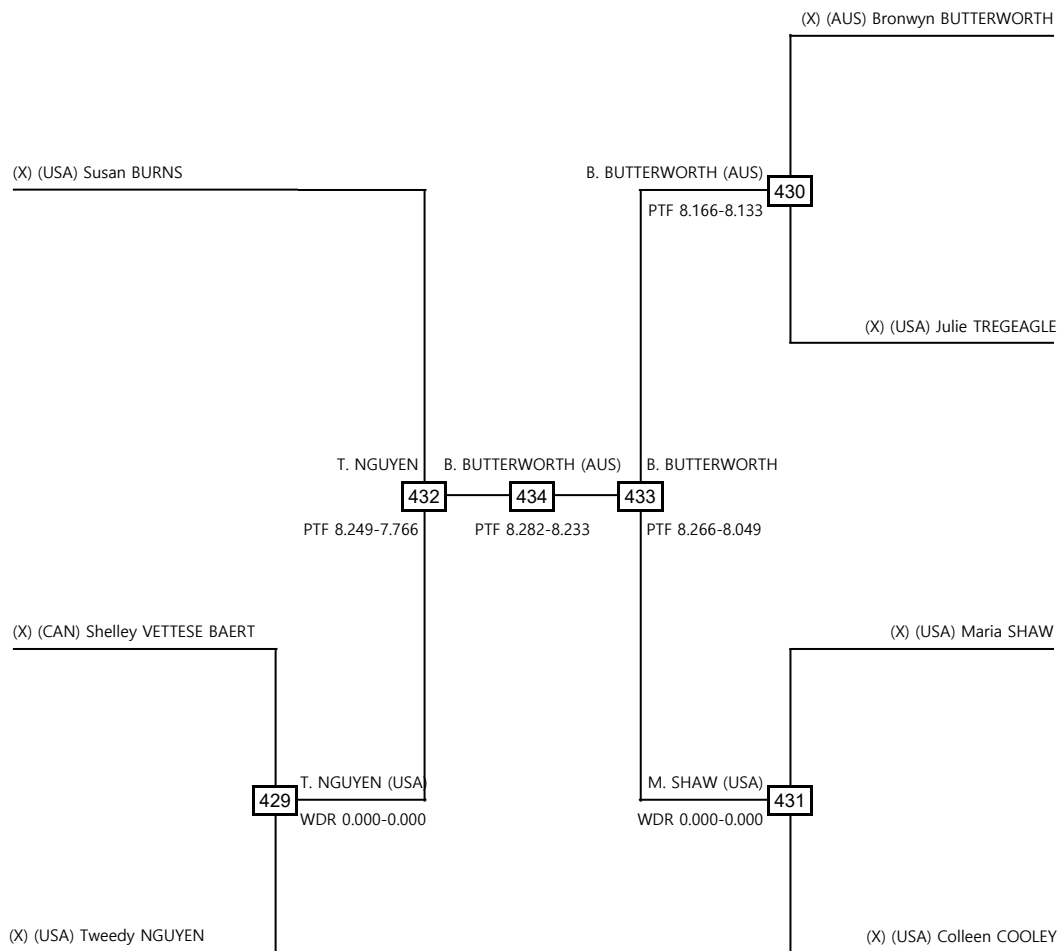

Classification		
1	BUTTERWORTH Bronwyn	AUS
2	NGUYEN Tweedy	USA
3	BURNS Susan	USA
3	SHAW Maria	USA

LEGEND

(x): Seed PTF: Win by final score

WDR: Win by Withdrawal

MedalLists
2026 U.S. OPEN CHAMPIONSHIPS
Pair Cadet
As of 05 MAR 2026

Medal	Name	Noc
GOLD	KIM/PHAN	USA-United States of America
SILVER	YIP/CHIU	
BRONZE	KIM LEE/GOMEZ	MEX-Mexico
	LIN/KE	TPE-Chinese Taipei

Pair Cadet Contestants: 22

Round of 32 Round of 16 Quarterfinals Semifinals Final Semifinals Quarterfinals Round of 16 Round of 32

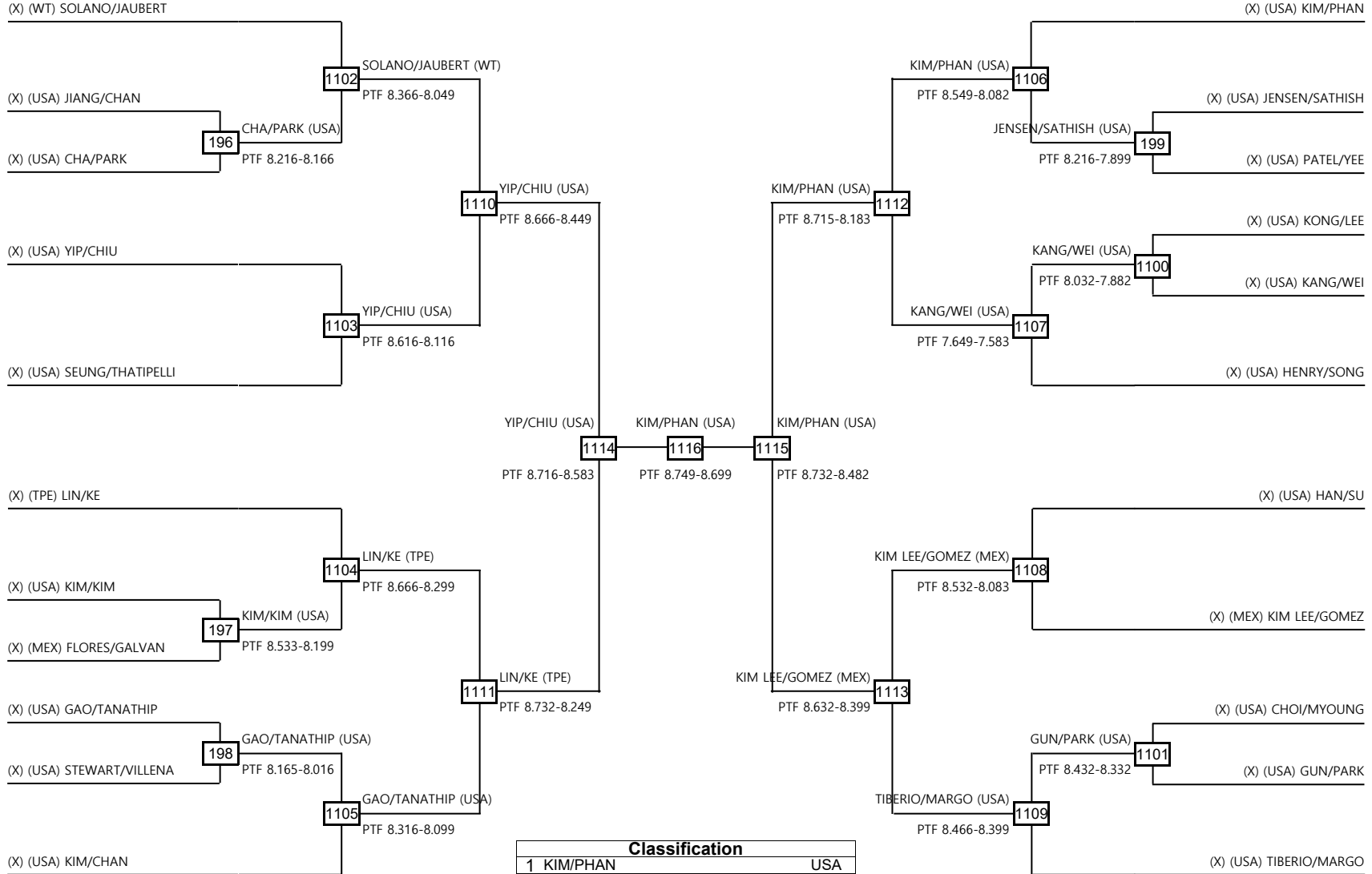

LEGEND
(x): Seed PTF: Win by final score

WDR: Win by Withdrawal

MedalLists
2026 U.S. OPEN CHAMPIONSHIPS
Pair Junior
As of 05 MAR 2026

Medal	Name	Noc
GOLD	CHANG/PARK	USA-United States of America
	CHANG Anna	
	PARK Preston	
SILVER	TU/YIP	
	TU Clara	
	YIP Enoch	
BRONZE	LIAO/MARCELINO	
	LIAO William	
	MARCELINO Eleni	
	QIANG/LIN	
	QIANG Lucas	
	LIN Elliot	

Pair Junior Contestants: 16

Round of 16 Quarterfinals Semifinals Final Semifinals Quarterfinals Round of 16

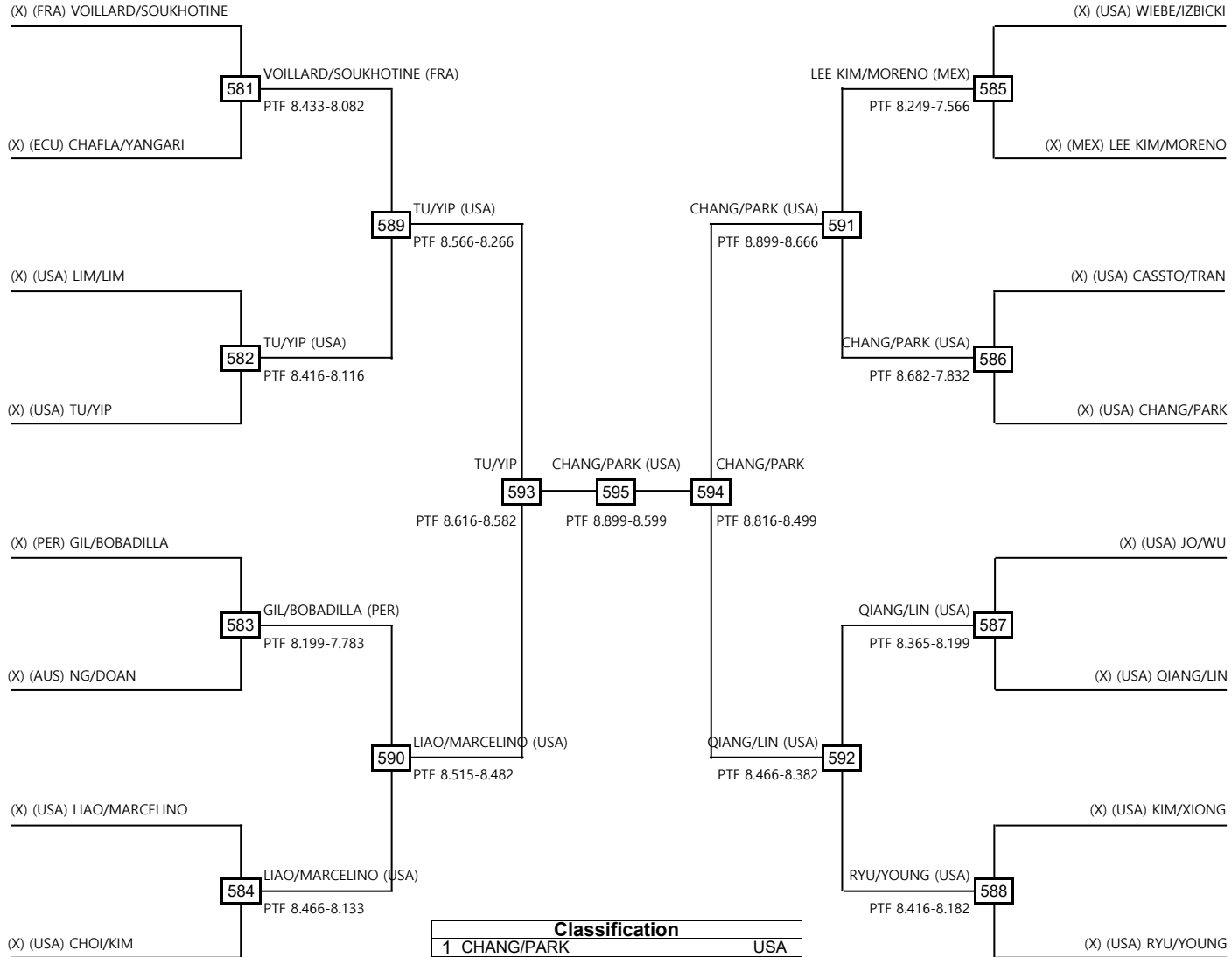

Classification	
1	CHANG/PARK USA
2	TU/YIP USA
3	LIAO/MARCELINO USA
3	QIANG/LIN USA

LEGEND
 (x): Seed PTF: Win by final score

WDR: Win by Withdrawal

MedalLists
2026 U.S. OPEN CHAMPIONSHIPS
Pair Under 30
As of 05 MAR 2026

Medal	Name	Noc
GOLD	SHU/KIM	USA-United States of America
	HSU Victoria	
	KIM David	
SILVER	ZHAO/KHATTAK	
	ZHAO Renee	
	KHATTAK Lawangeen	
BRONZE	SUBAUSTE/VARILLAS	PER-Peru
	SUBAUSTE PEREZ Rodrigo	
	VARILLAS Fabiana	USA-United States of America
	PARK/KIM	
	PARK Sean	
	KIM Elizabeth	

Pair Under 30 Contestants: 15

Round of 16 Quarterfinals Semifinals Final Semifinals Quarterfinals Round of 16

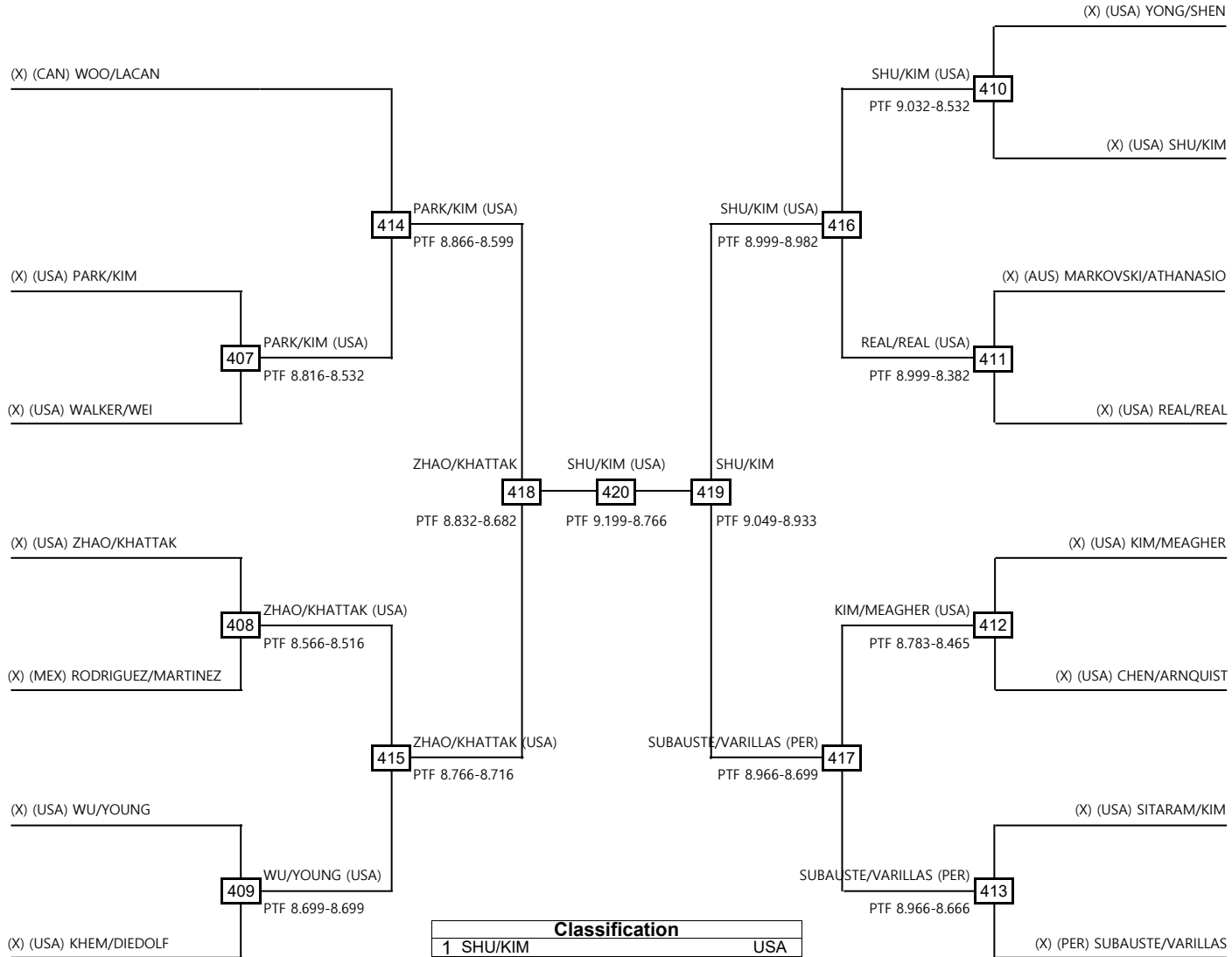

Classification		
1	SHU/KIM	USA
2	ZHAO/KHATTAK	USA
3	SUBAUSTE/VARILLAS	PER
3	PARK/KIM	USA

LEGEND
(x): Seed PTF: Win by final score

WDR: Win by Withdrawal

MedalLists
2026 U.S. OPEN CHAMPIONSHIPS
Pair Under 50
As of 05 MAR 2026

Medal	Name	Noc
GOLD	SEONG/AYRES	USA-United States of America
	SEONG Minki	
	AYRES Jessica Mari	
SILVER	GORDILLO/SANCHEZ	MEX-Mexico
	GORDILLO CESAR Adriana SANCHEZ	
	GODINA Heriberto Abraham	
BRONZE	CUNNINGHAM/TIPPENS	USA-United States of America
	CUNNINGHAM Caitlin	
	TIPPENS Shay	
	ANG/LU	
	ANG Pia Georgette	
	LU Kevin	

Pair Under 50 Contestants: 7

Quarterfinals Semifinals Final Semifinals Quarterfinals

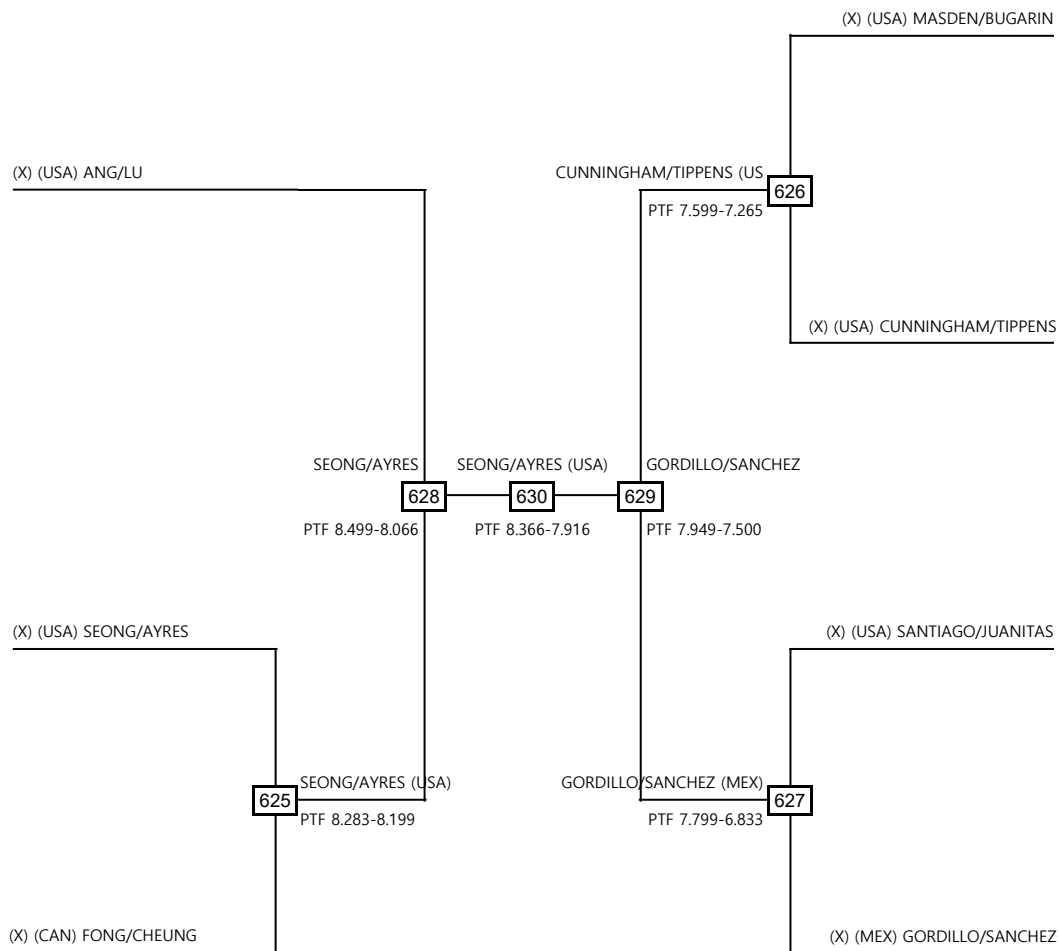

Classification	
1	SEONG/AYRES USA
2	GORDILLO/SANCHEZ MEX
3	CUNNINGHAM/TIPPENS USA
3	ANG/LU USA

LEGEND

(x): Seed PTF: Win by final score

WDR: Win by Withdrawal

MedalLists
2026 U.S. OPEN CHAMPIONSHIPS
Pair Under 60
As of 05 MAR 2026

Medal	Name	Noc
GOLD	NGUYEN/HA NGUYEN Thoa HA Sungwoo	USA-United States of America
SILVER	ONG/THOMPSON ONG Angelito THOMPSON Eleanor	
BRONZE	KIM/SITARAM KIM Sheena SITARAM Krishna TEMPLETON/BAIER TEMPLETON Timothy BAIER Mara	

Pair Under 60 Contestants: 5

Quarterfinals Semifinals Final Semifinals Quarterfinals

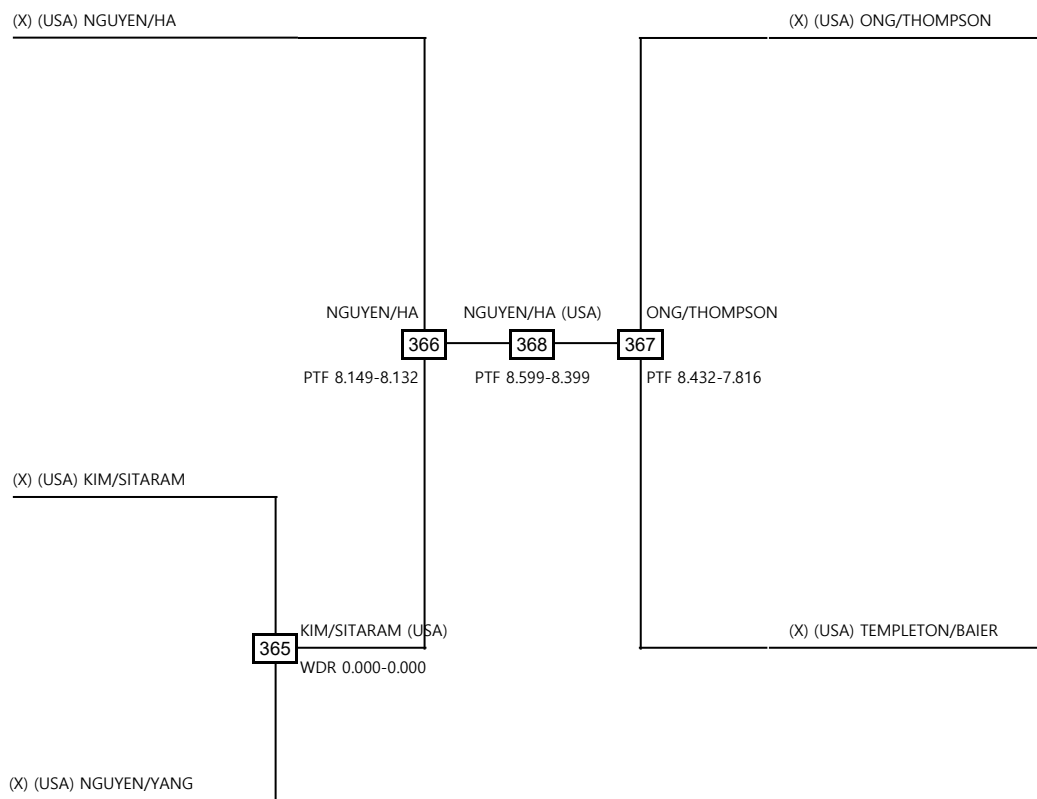

Classification	
1	NGUYEN/HA USA
2	ONG/THOMPSON USA
3	KIM/SITARAM USA
3	TEMPLETON/BAIER USA

LEGEND

(x): Seed PTF: Win by final score

WDR: Win by Withdrawal

MedalLists
2026 U.S. OPEN CHAMPIONSHIPS
Male Team Cadet
As of 05 MAR 2026

Medal	Name	Noc
GOLD	JOMALESA/CHOI/KIM	USA-United States of America
SILVER	LIN/CHENG/CHENG	TPE-Chinese Taipei
BRONZE	KIM/LEE/DELA XU/LEE/GUN	USA-United States of America

Male Team Cadet Contestants: 5

Quarterfinals Semifinals Final Semifinals Quarterfinals

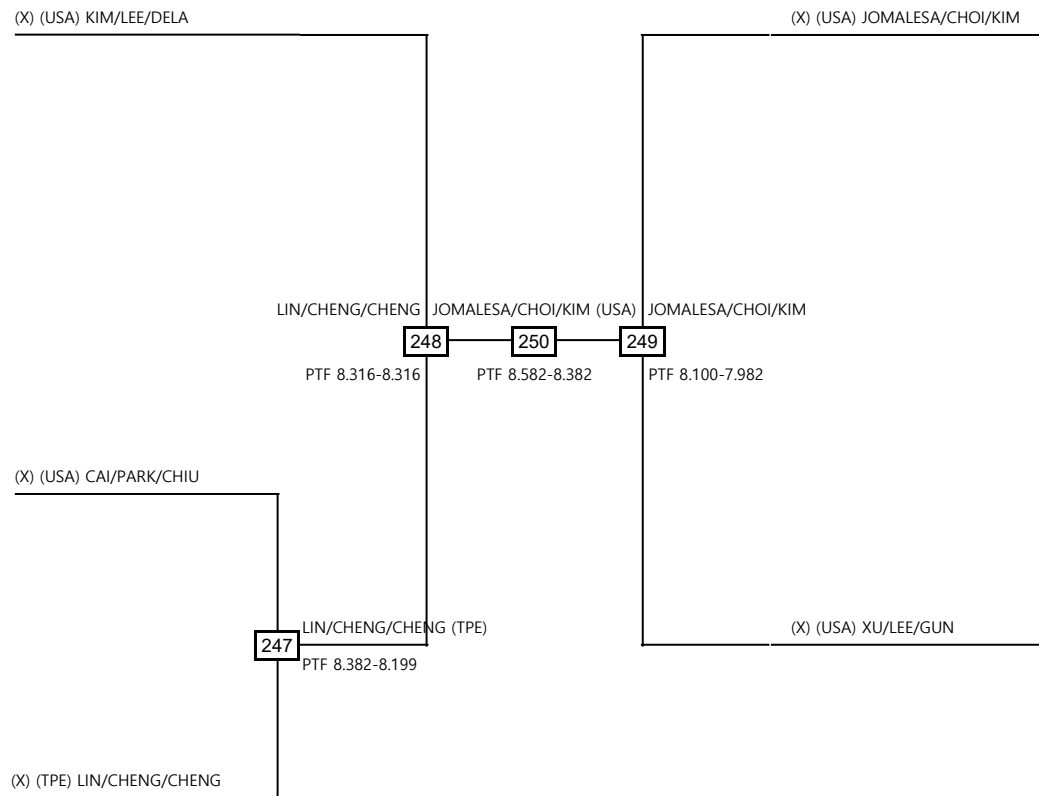

Classification	
1	JOMALESA/CHOI/KIM USA
2	LIN/CHENG/CHENG TPE
3	KIM/LEE/DELA USA
3	XU/LEE/GUN USA

LEGEND

(x): Seed PTF: Win by final score

WDR: Win by Withdrawal

MedalLists
2026 U.S. OPEN CHAMPIONSHIPS
Male Team Junior
As of 05 MAR 2026

Medal	Name	Noc
GOLD	PARK/ONG/GIL	USA-United States of America
	PARK Preston	
	ONG Whye Jing	
	GIL David	
SILVER	KIM/YIP/KIM	
	KIM Daneau	
	YIP Enoch	
	KIM Joseph	
BRONZE	LOMELI/MEJIA/GONZALEZ	MEX-Mexico
	LOMELI FLORES Franco Leonardo	
	MEJIA DIAZ Samuel Jonas	
	GONZALEZ ROSAS Suriel	USA-United States of America
	CHAN/KWAN/TANG	
	CHAN Ryan	
	KWAN Mason	
	TANG Lucas	

Male Team Junior Contestants: 5

Quarterfinals Semifinals Final Semifinals Quarterfinals

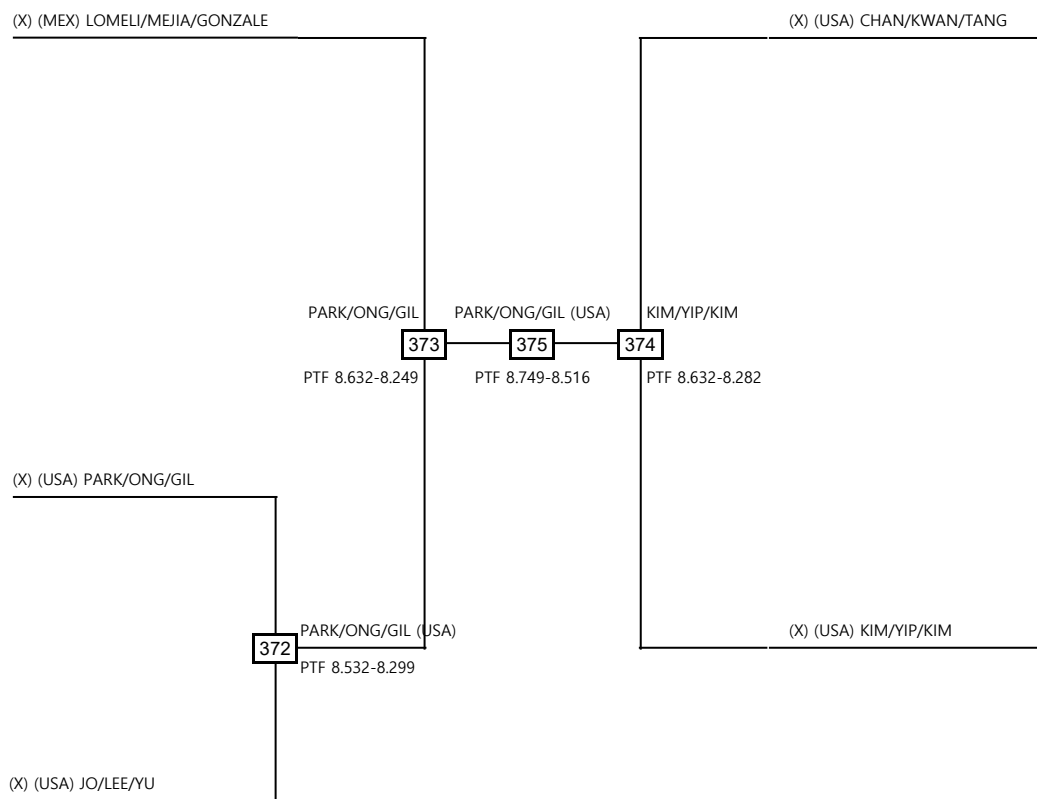

Classification	
1	PARK/ONG/GIL USA
2	KIM/YIP/KIM USA
3	LOMELI/MEJIA/GONZALEZ MEX
3	CHAN/KWAN/TANG USA

LEGEND

(x): Seed PTF: Win by final score

WDR: Win by Withdrawal

MedalLists
2026 U.S. OPEN CHAMPIONSHIPS
Male Team Under 30
As of 05 MAR 2026

Medal	Name	Noc
GOLD	GUN/KIM/LOPEZ	USA-United States of America
SILVER	AN/KIM/KIM	
BRONZE	HERY/KUBICKI/TRANCHANT	FRA-France
	KANG/LEE/FINCHER	USA-United States of America

Male Team Under 30 Contestants: 6

Quarterfinals Semifinals Final Semifinals Quarterfinals

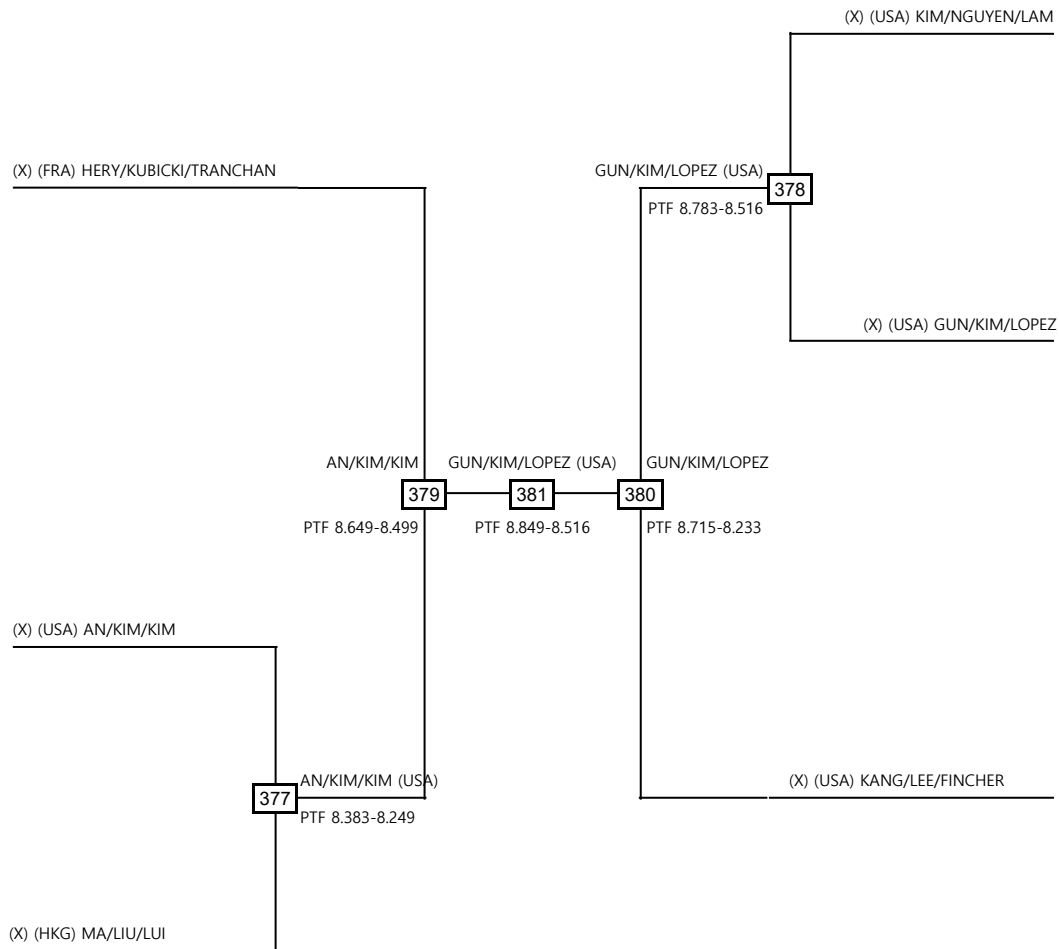

Classification	
1	GUN/KIM/LOPEZ USA
2	AN/KIM/KIM USA
3	HERY/KUBICKI/TRANCHANT FRA
3	KANG/LEE/FINCHER USA

LEGEND

(x): Seed PTF: Win by final score

WDR: Win by Withdrawal

MedalLists
2026 U.S. OPEN CHAMPIONSHIPS
Male Team Under 50
As of 05 MAR 2026

Medal	Name	Noc
GOLD	LEE/QUITAIN/ALOVKONOV	USA-United States of America
	LEE Joowon	
	QUITAIN Osmundo	
	ALOVKONOV Bakhodir	
SILVER	HAN/TIPPENS/KIM	
	HAN Keunhee	
	TIPPENS Shay	
BRONZE	KIM Chanhee	
	BAGAIPO/ARSENAL/BUGARIN	
	BAGAIPO Edison	
	ARSENAL George Jr Guiritan	
	BUGARIN Michael John	



2026 U.S. OPEN CHAMPIONSHIPS
THU 05 MAR 2026



Male Team Under 50 Contestants: 3

Semifinals Final Semifinals

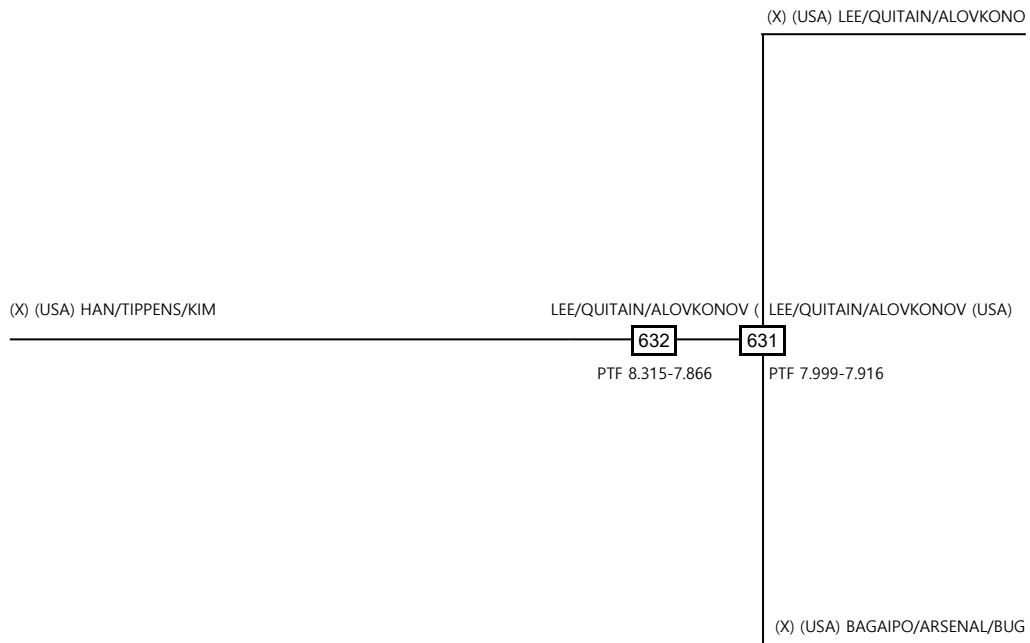

Classification		
1	LEE/QUITAIN/ALOVKONOV	USA
2	HAN/TIPPENS/KIM	USA
3	BAGAIPO/ARSENAL/BUGARIN	USA
3		

LEGEND

(x): Seed PTF: Win by final score

WDR: Win by Withdrawal



MedalLists
2026 U.S. OPEN CHAMPIONSHIPS
Male Team Under 60
As of 05 MAR 2026

Medal	Name	Noc
GOLD	YANG/HA/KIM	USA-United States of America



2026 U.S. OPEN CHAMPIONSHIPS
THU 05 MAR 2026



Male Team Under 60 Contestants: 1

Final

(X) (USA) YANG/HA/KIM (USA) YANG/HA/KIM (X) (WT) .
 _____ **369** _____
 PTF 8.266-0.000

Classification	
1	YANG/HA/KIM USA
2	. WT
3	
3	

LEGEND

(x): Seed PTF: Win by final score

WDR: Win by Withdrawal



MedalLists
2026 U.S. OPEN CHAMPIONSHIPS
Male Team Over 60
As of 05 MAR 2026

Medal	Name	Noc
GOLD	LEE/PARK/UM LEE Eun Ig PARK James UM Gi Woo	USA-United States of America

Final

(X) (USA) LEE/PARK/UM (USA) LEE/PARK/UM (X) (WT) .

370

WDR 0.000-0.000

Classification	
1	LEE/PARK/UM USA
2	. WT
3	
3	

LEGEND

(x): Seed PTF: Win by final score

WDR: Win by Withdrawal

MedalLists
2026 U.S. OPEN CHAMPIONSHIPS
Female Team Cadet
As of 05 MAR 2026

Medal	Name	Noc
GOLD	LEE/DORACK/TSANG	USA-United States of America
SILVER	KIM/SHIM/LEUNG	
BRONZE	SUH/SEO/YANG	
	WEI/DANG/PARK	

Female Team Cadet Contestants: 16

Round of 16 Quarterfinals Semifinals Final Semifinals Quarterfinals Round of 16

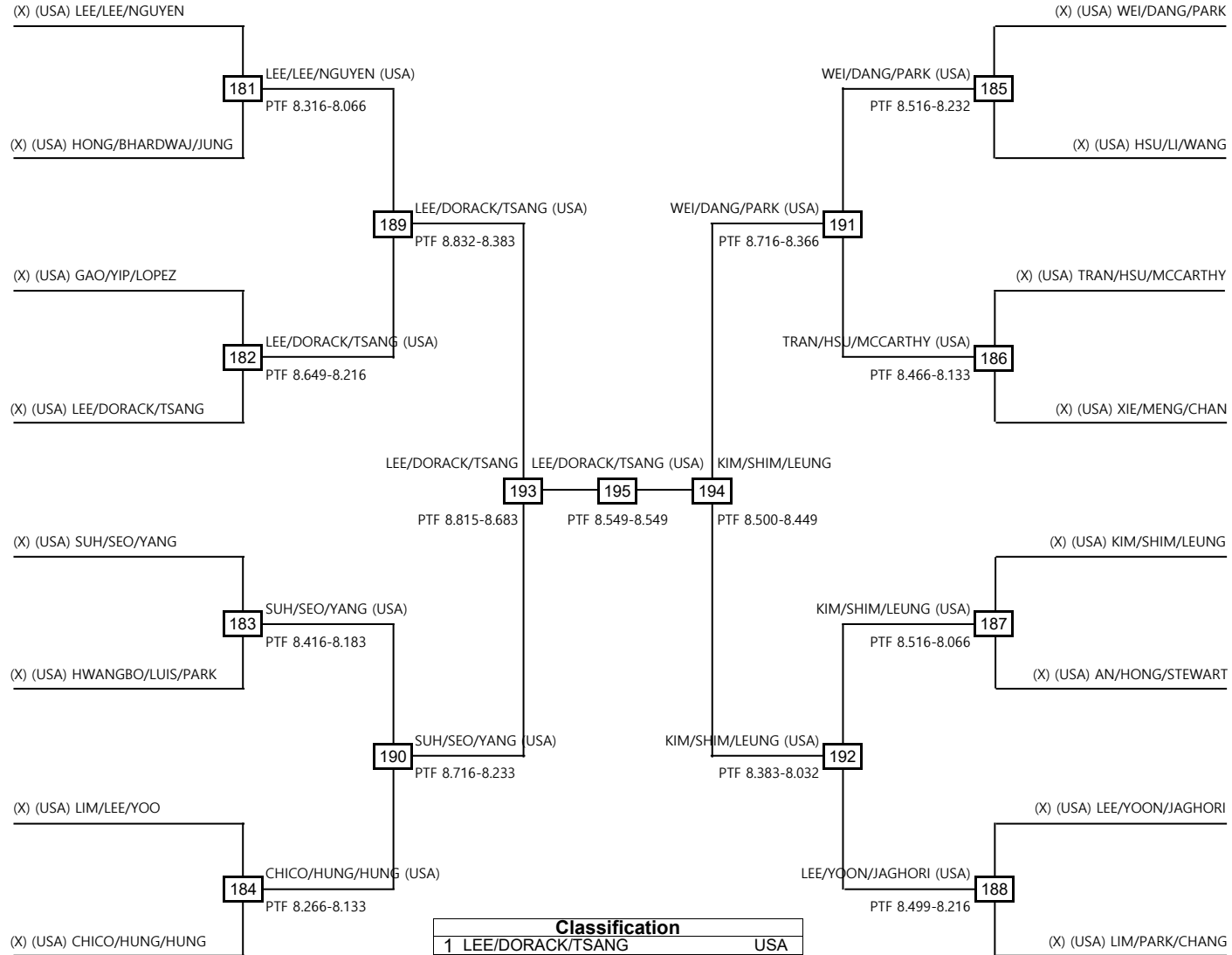

Classification	
1	LEE/DORACK/TSANG USA
2	KIM/SHIM/LEUNG USA
3	SUH/SEO/YANG USA
3	WEI/DANG/PARK USA

LEGEND
 (x): Seed PTF: Win by final score

WDR: Win by Withdrawal

MedalLists
2026 U.S. OPEN CHAMPIONSHIPS
Female Team Junior
As of 05 MAR 2026

Medal	Name	Noc
GOLD	LO/LIU/LEE	USA-United States of America
SILVER	KIM/ONG/CHEUNG	
BRONZE	DONG/JEONG/HAN	
	VILAR/KATO/SOBHANI	

2026 U.S. OPEN CHAMPIONSHIPS THU 05 MAR 2026

Female Team Junior Contestants: 10

Round of 16 Quarterfinals Semifinals Final Semifinals Quarterfinals Round of 16

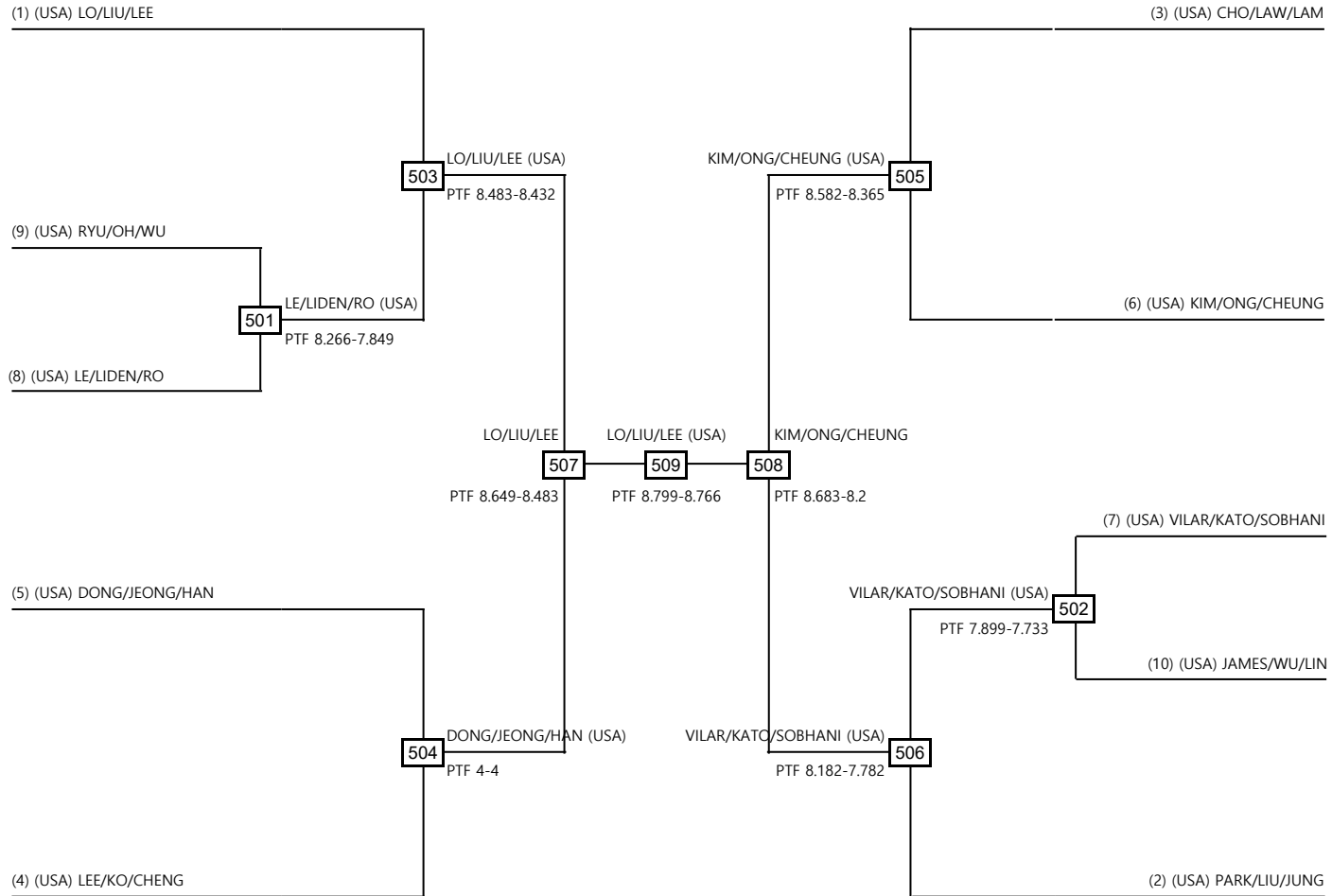

Classification		
1	LO/LIU/LEE	USA
2	KIM/ONG/CHEUNG	USA
3	DONG/JEONG/HAN	USA
3	VILAR/KATO/SOBHANI	USA

LEGEND

(x): Seed PTF: Win by final score

WDR: Win by Withdrawal

MedalLists
2026 U.S. OPEN CHAMPIONSHIPS
Female Team Under30
As of 05 MAR 2026

Medal	Name	Noc
GOLD	MORALEDA/HSU/RECLUSADO	USA-United States of America
SILVER	YOSHIDA/PARK/DEGUZMAN	
BRONZE	SEO/CHAN/ROSENZWEIG	
	FLOTILDES/KIM/FREGOSO	

2026 U.S. OPEN CHAMPIONSHIPS
THU 05 MAR 2026

Female Team Under30 Contestants: 8

Quarterfinals Semifinals Final Semifinals Quarterfinals

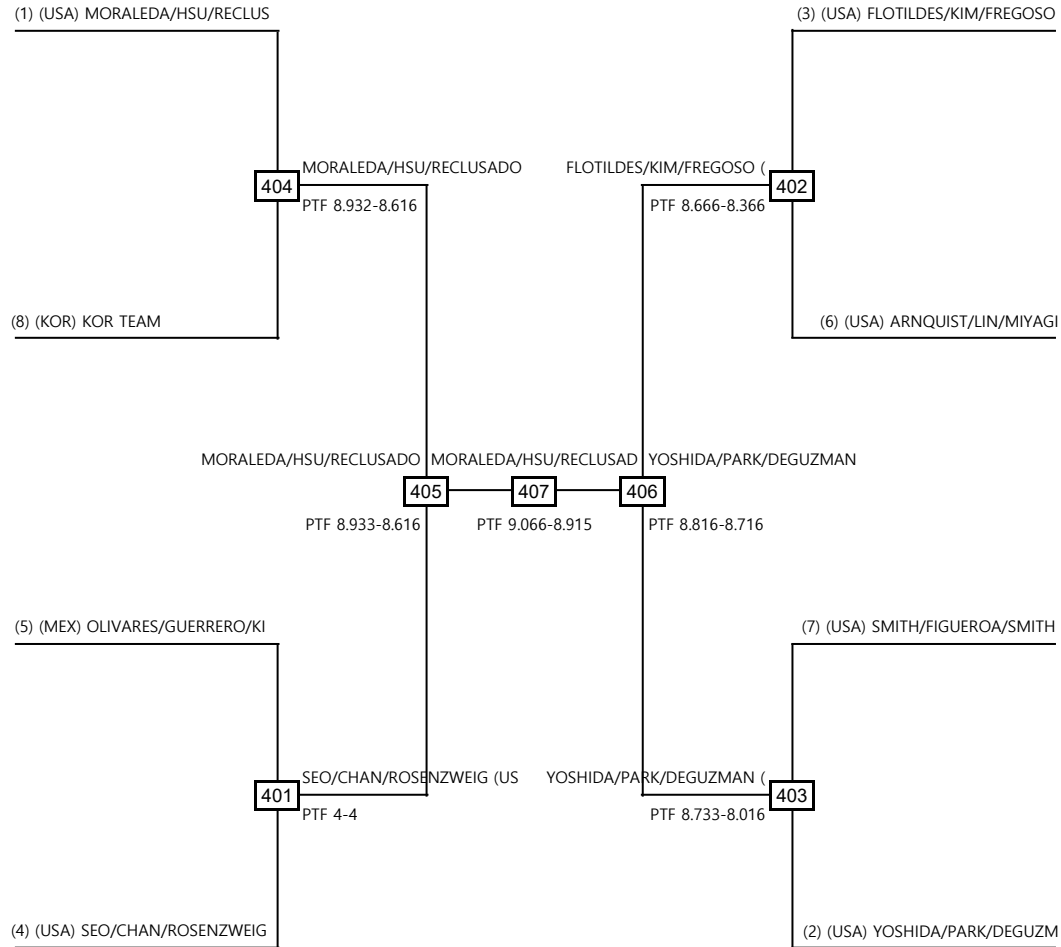

Classification		
1	MORALEDA/HSU/RECLUSADO	USA
2	YOSHIDA/PARK/DEGUZMAN	USA
3	SEO/CHAN/ROSENZWEIG	USA
3	FLOTILDES/KIM/FREGOSO	USA

LEGEND

(x): Seed PTF: Win by final score

WDR: Win by Withdrawal

MedalLists
2026 U.S. OPEN CHAMPIONSHIPS
Female Team Under 50
As of 05 MAR 2026

Medal	Name	Noc
GOLD	KIM/DO/HUYNH	USA-United States of America
	KIM Young-A	
	DO Kathy	
	HUYNH Thanh-Van	
SILVER	PECK/BROUSSARD/LEE	CAN-Canada
	PECK Nathalie	
	BROUSSARD Bo Rah	
	LEE Sung Jin	
BRONZE	AN/GOLK/RAMIREZ	CAN-Canada
	AN Eunhye (Annie)	
	FOLK Breanne	
	RAMIREZ CRUZ Stephanie	

Semifinals Final Semifinals

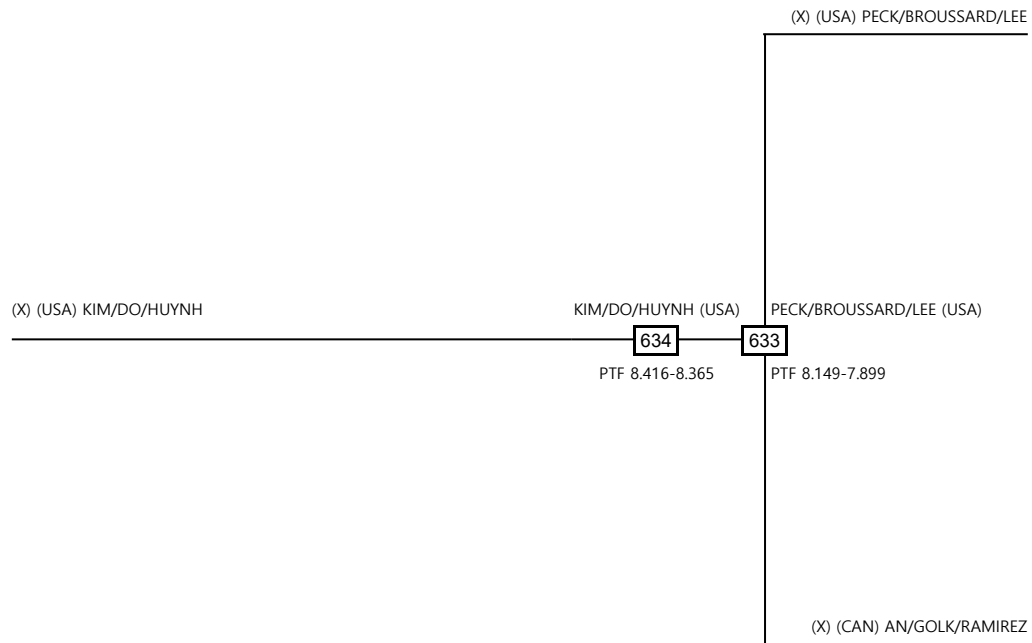

Classification		
1	KIM/DO/HUYNH	USA
2	PECK/BROUSSARD/LEE	USA
3	AN/GOLK/RAMIREZ	CAN
3		

LEGEND

(x): Seed PTF: Win by final score

WDR: Win by Withdrawal

MedalLists
2026 U.S. OPEN CHAMPIONSHIPS
Female Team Under 60
As of 05 MAR 2026

Medal	Name	Noc
GOLD	NGUYEN/ADAMS/UM	USA-United States of America
	NGUYEN Thoa	
	ADAMS Elva	
	UM Cindy Sin Sook	



2026 U.S. OPEN CHAMPIONSHIPS
 THU 05 MAR 2026
 Female Team Under 60 Contestants: 1



Final

(X) (USA) NGUYEN/ADAMS/UM (USA) NGUYEN/ADAMS/UM (X) (WT) .

 369
 PTF 7.999-0.000

Classification	
1	NGUYEN/ADAMS/UM USA
2	. WT
3	
3	

LEGEND
 (x): Seed PTF: Win by final score WDR: Win by Withdrawal



MedalLists
2026 U.S. OPEN CHAMPIONSHIPS
Female Team Over 60
As of 05 MAR 2026

Medal	Name	Noc
GOLD	TOLSTRUP/THORNE/DOOLITTLE TOLSTRUP Kirsten THORNE Anacleta DOOLITTLE Thu	USA-United States of America



2026 U.S. OPEN CHAMPIONSHIPS
 THU 05 MAR 2026
 Female Team Over 60 Contestants: 1



Final

(X) (USA) TOLSTRUP/THORNE/DO (USA) TOLSTRUP/THORNE/D (X) (WT) .
 371
 PTF 7.349-0.000

Classification		
1	TOLSTRUP/THORNE/DOOLITTLE	USA
2	.	WT
3		
3		

LEGEND

(x): Seed PTF: Win by final score

WDR: Win by Withdrawal



MedalLists
2026 U.S. OPEN CHAMPIONSHIPS
Male Under 17
As of 05 MAR 2026

Medal	Name	Noc
GOLD	MORENO GOMEZ Miguel Angel	MEX-Mexico
SILVER	KIM Jayden	USA-United States of America
BRONZE	TU Cody	
	LARSON Grant	



Contest Results
2026 U.S. OPEN CHAMPIONSHIPS
Final Male Under 17
As of 05 MAR 2026



Rank	Contest No	NOC	Name	Score	Acc/Tech	Total	Detail					
					Pre		Game	Score	Acc/Tech	Pre	Total	Deduct
1	733	MEX	MORENO GOMEZ Miguel Angel	9.266	5.566	46.0	Game1	9.266	5.566	3.700	46.0	0.0
					3.700		Game2	0.000	0.000	0.000	0.0	0.0
2	732	USA	KIM Jayden	8.899	5.366	44.6	Game1	8.899	5.366	3.533	44.6	0.0
					3.533		Game2	0.000	0.000	0.000	0.0	0.0
3	731	USA	TU Cody	8.632	5.166	43.2	Game1	8.632	5.166	3.466	43.2	0.0
					3.466		Game2	0.000	0.000	0.000	0.0	0.0
4	730	USA	LARSON Grant	8.299	4.966	41.5	Game1	8.299	4.966	3.333	41.5	0.0
					3.333		Game2	0.000	0.000	0.000	0.0	0.0
5	729	USA	WONG James	8.166	5.000	40.8	Game1	8.166	5.000	3.166	40.8	0.0
					3.166		Game2	0.000	0.000	0.000	0.0	0.0
6	728	USA	CHEN Ethan	8.133	4.900	40.7	Game1	8.133	4.900	3.233	40.7	0.0
					3.233		Game2	0.000	0.000	0.000	0.0	0.0
7	726	USA	TSUCHIDA Kai	7.933	4.800	39.7	Game1	7.933	4.800	3.133	39.7	0.0
					3.133		Game2	0.000	0.000	0.000	0.0	0.0





Contest Results
2026 U.S. OPEN CHAMPIONSHIPS
Final Male Under 17
As of 05 MAR 2026



Rank	Contest No	NOC	Name	Score	Acc/Tech	Total	Detail					
					Pre		Game	Score	Acc/Tech	Pre	Total	Deduct
8	727	USA	MIN Joel	7.199	4.166	35.9	Game1	7.199	4.166	3.033	35.9	0.0
					3.033		Game2	0.000	0.000	0.000	0.0	0.0



MedalLists
2026 U.S. OPEN CHAMPIONSHIPS
Male Over 17
As of 05 MAR 2026

Medal	Name	Noc
GOLD	ARROYO William	MEX-Mexico
SILVER	LEE Chanmin	KOR-Republic of Korea
BRONZE	TROYA JIMENEZ Mario Alejandro	ECU-Ecuador
	PARK Se.Jung	KOR-Republic of Korea



Contest Results
2026 U.S. OPEN CHAMPIONSHIPS
Final Male Over 17
As of 05 MAR 2026



Rank	Contest No	NOC	Name	Score	Acc/Tech	Total	Detail					
					Pre		Game	Score	Acc/Tech	Pre	Total	Deduct
1	797	MEX	ARROYO William	9.466	5.666	47.6	Game1	9.466	5.666	3.800	47.6	0.0
					3.800		Game2	0.000	0.000	0.000	0.0	0.0
2	795	KOR	LEE Chanmin	9.400	5.600	47.1	Game1	9.400	5.600	3.800	47.1	0.0
					3.800		Game2	0.000	0.000	0.000	0.0	0.0
3	794	ECU	TROYA JIMENEZ Mario Alejandro	9.333	5.633	46.7	Game1	9.333	5.633	3.700	46.7	0.0
					3.700		Game2	0.000	0.000	0.000	0.0	0.0
4	796	KOR	PARK Se.Jung	9.299	5.566	46.6	Game1	9.299	5.566	3.733	46.6	0.0
					3.733		Game2	0.000	0.000	0.000	0.0	0.0
5	790	USA	YI Kristian	9.100	5.500	45.1	Game1	9.100	5.500	3.600	45.1	0.0
					3.600		Game2	0.000	0.000	0.000	0.0	0.0
6	792	GUA	AGUILAR CARDONA Cesar Alberto	8.866	5.366	44.4	Game1	8.866	5.366	3.500	44.4	0.0
					3.500		Game2	0.000	0.000	0.000	0.0	0.0
7	791	MEX	REYNA Robinson	8.832	5.366	43.8	Game1	8.832	5.366	3.466	43.8	0.0
					3.466		Game2	0.000	0.000	0.000	0.0	0.0





Contest Results
2026 U.S. OPEN CHAMPIONSHIPS
Final Male Over 17
As of 05 MAR 2026



Rank	Contest No	NOC	Name	Score	Acc/Tech	Total	Detail					
					Pre		Game	Score	Acc/Tech	Pre	Total	Deduct
1000	793	TPE	CHEN Hsiao-Tse	0.000	0.000	0.0	Game1	0.000	0.000	0.000	0.0	0.0
					0.000		Game2	0.000	0.000	0.000	0.0	0.0



MedalLists
2026 U.S. OPEN CHAMPIONSHIPS
Female Under 17
As of 05 MAR 2026

Medal	Name	Noc
GOLD	PHAM Angela	USA-United States of America
SILVER	CUEVAS MERCADO Ines Renata	MEX-Mexico
BRONZE	RODRIGUEZ DIAZ Genesis Renata	
	HER Aeriana	USA-United States of America

Contest Results
2026 U.S. OPEN CHAMPIONSHIPS
Final Female Under 17
As of 05 MAR 2026



Rank	Contest No	NOC	Name	Score	Acc/Tech	Total	Detail					
					Pre		Game	Score	Acc/Tech	Pre	Total	Deduct
1	708	USA	PHAM Angela	8.032	4.766	40.1	Game1	8.032	4.766	3.266	40.1	0.0
					3.266		Game2	0.000	0.000	0.000	0.0	0.0
2	705	MEX	CUEVAS MERCADO Ines Renata	7.533	4.500	38.0	Game1	7.533	4.500	3.033	38.0	0.0
					3.033		Game2	0.000	0.000	0.000	0.0	0.0
3	703	MEX	RODRIGUEZ DIAZ Genesis Renata	7.333	4.400	36.4	Game1	7.333	4.400	2.933	36.4	0.0
					2.933		Game2	0.000	0.000	0.000	0.0	0.0
4	701	USA	HER Aeriana	7.232	4.266	36.1	Game1	7.232	4.266	2.966	36.1	0.0
					2.966		Game2	0.000	0.000	0.000	0.0	0.0
5	702	USA	ARION Kayda	6.966	4.100	34.8	Game1	6.966	4.100	2.866	34.8	0.0
					2.866		Game2	0.000	0.000	0.000	0.0	0.0
6	706	USA	PARK Jihyeon	6.599	3.666	33.4	Game1	6.599	3.666	2.933	33.4	0.0
					2.933		Game2	0.000	0.000	0.000	0.0	0.0
7	704	MEX	HERNANDEZ PEREZ Lanna Roberta	5.533	3.100	28.6	Game1	5.533	3.100	2.433	28.6	0.0
					2.433		Game2	0.000	0.000	0.000	0.0	0.0



Contest Results
2026 U.S. OPEN CHAMPIONSHIPS
Final Female Under 17
As of 05 MAR 2026



Rank	Contest No	NOC	Name	Score	Acc/Tech	Total	Detail					
					Pre		Game	Score	Acc/Tech	Pre	Total	Deduct
1000	707	USA	JEONG Noel	0.000	0.000	0.0	Game1	0.000	0.000	0.000	0.0	0.0
					0.000		Game2	0.000	0.000	0.000	0.0	0.0



MedalLists
2026 U.S. OPEN CHAMPIONSHIPS
Female Over 17
As of 05 MAR 2026

Medal	Name	Noc
GOLD	HIGUEROS Alejandra	GUA-Guatemala
SILVER	CUEVAS MERCADO Ines Renata	
BRONZE	GLINES Valentina	USA-United States of America
	DEGUZMAN Allison	

Contest Results
2026 U.S. OPEN CHAMPIONSHIPS
Finals Female Over 17
As of 05 MAR 2026



Rank	Contest No	NOC	Name	Score	Acc/Tech	Total	Detail					
					Pre		Game	Score	Acc/Tech	Pre	Total	Deduct
1	750	GUA	HIGUEROS Alejandra	8.699	5.133	43.9	Game1	8.699	5.133	3.566	43.9	0.0
					3.566		Game2	0.000	0.000	0.000	0.0	0.0
2	748	GUA	ICUTE Celia Lucia	8.633	5.133	43.0	Game1	8.633	5.133	3.500	43.0	0.0
					3.500		Game2	0.000	0.000	0.000	0.0	0.0
3	741	USA	GLINES Valentina	8.566	5.100	42.8	Game1	8.566	5.100	3.466	42.8	0.0
					3.466		Game2	0.000	0.000	0.000	0.0	0.0
4	749	USA	DEGUZMAN Allison	8.332	4.966	41.9	Game1	8.332	4.966	3.366	41.9	0.0
					3.366		Game2	0.000	0.000	0.000	0.0	0.0
5	745	TPE	CHEN Hsin-Ya	8.000	4.800	40.1	Game1	8.000	4.800	3.200	40.1	0.0
					3.200		Game2	0.000	0.000	0.000	0.0	0.0
6	743	VIE	NGUYEN Phan Khanh Han	7.866	4.733	39.8	Game1	7.866	4.733	3.133	39.8	0.0
					3.133		Game2	0.000	0.000	0.000	0.0	0.0
7	734	TPE	CHANG Yi-Hsuan	7.766	4.666	38.7	Game1	7.766	4.666	3.100	38.7	0.0
					3.100		Game2	0.000	0.000	0.000	0.0	0.0

Contest Results
2026 U.S. OPEN CHAMPIONSHIPS
Finals Female Over 17
As of 05 MAR 2026



Rank	Contest No	NOC	Name	Score	Acc/Tech	Total	Detail					
					Pre		Game	Score	Acc/Tech	Pre	Total	Deduct
8	744	USA	CHAN Kyra	7.632	4.566	38.3	Game1	7.632	4.566	3.066	38.3	0.0
					3.066		Game2	0.000	0.000	0.000	0.0	0.0
9	737	USA	DARLIN Alexa	7.599	4.566	37.7	Game1	7.599	4.566	3.033	37.7	0.0
					3.033		Game2	0.000	0.000	0.000	0.0	0.0
10	736	MEX	ESPINOSA VILLEGAS Valeria	7.499	4.466	37.3	Game1	7.499	4.466	3.033	37.3	0.0
					3.033		Game2	0.000	0.000	0.000	0.0	0.0
11	740	MEX	HERNANDEZ LE ROYAL Gabriela G.	7.133	4.100	35.6	Game1	7.133	4.100	3.033	35.6	0.0
					3.033		Game2	0.000	0.000	0.000	0.0	0.0
12	742	PUR	MEDINA Arelis	7.033	4.000	34.7	Game1	7.033	4.000	3.033	34.7	0.0
					3.033		Game2	0.000	0.000	0.000	0.0	0.0
13	746	MEX	HEINZE Andrea	6.766	3.766	33.6	Game1	6.766	3.766	3.000	33.6	0.0
					3.000		Game2	0.000	0.000	0.000	0.0	0.0
14	738	IRL	TIERNEY Kate	6.533	3.633	32.8	Game1	6.533	3.633	2.900	32.8	0.0
					2.900		Game2	0.000	0.000	0.000	0.0	0.0



Contest Results
2026 U.S. OPEN CHAMPIONSHIPS
Finals Female Over 17
As of 05 MAR 2026



Rank	Contest No	NOC	Name	Score	Acc/Tech	Total	Detail					
					Pre		Game	Score	Acc/Tech	Pre	Total	Deduct
1000	735	DOM	RAMOS JESURON Karla Maria	0.000	0.000	0.0	Game1	0.000	0.000	0.000	0.0	0.0
					0.000		Game2	0.000	0.000	0.000	0.0	0.0
1000	739	SGP	AQIDAH Diyanah	0.000	0.000	0.0	Game1	0.000	0.000	0.000	0.0	0.0
					0.000		Game2	0.000	0.000	0.000	0.0	0.0
1000	747	MEX	LEE Cecilia	0.000	0.000	0.0	Game1	0.000	0.000	0.000	0.0	0.0
					0.000		Game2	0.000	0.000	0.000	0.0	0.0



MedalLists
2026 U.S. OPEN CHAMPIONSHIPS
Pair Under 17
As of 05 MAR 2026

Medal	Name	Noc
GOLD	HER Higan/Aeriana	USA-United States of America
	HER Higan	
	HER Aeriana	
SILVER	RAMIREZ/RODRIGUEZ	MEX-Mexico
	RAMIREZ OLIVARES Sebastian	
	RODRIGUEZ DIAZ Genesis Renata	
BRONZE	HER Aizen/Haley	USA-United States of America
	HER Aizen	
	HER Haley	
	ARION/CHEN	
	ARION Kayda	
	CHEN Ethan	



Contest Results
2026 U.S. OPEN CHAMPIONSHIPS
Final Pair Under 17
As of 05 MAR 2026



Rank	Contest No	NOC	Name	Score	Acc/Tech	Total	Detail					
					Pre		Game	Score	Acc/Tech	Pre	Total	Deduct
1	760	USA	HER Higan/Aeriana Higan HER Aeriana HER	8.132	4.866	40.6	Game1	8.132	4.866	3.266	40.6	0.0
					3.266		Game2	0.000	0.000	0.000	0.0	0.0
2	761	MEX	RAMIREZ/RODRIGUEZ S. RAMIREZ OLIVARES Genesis R. RODRIGUEZ DIAZ	7.799	4.666	39.6	Game1	7.799	4.666	3.133	39.6	0.0
					3.133		Game2	0.000	0.000	0.000	0.0	0.0
3	762	USA	HER Aizen/Haley Aizen HER Haley HER	7.699	4.666	37.9	Game1	7.699	4.666	3.033	37.9	0.0
					3.033		Game2	0.000	0.000	0.000	0.0	0.0
4	759	USA	ARION/CHEN Kayda ARION Ethan CHEN	7.666	4.533	38.7	Game1	7.666	4.533	3.133	38.7	0.0
					3.133		Game2	0.000	0.000	0.000	0.0	0.0



MedalLists
2026 U.S. OPEN CHAMPIONSHIPS
Pair Over 17
As of 05 MAR 2026

Medal	Name	Noc
GOLD	FAUSTO/HER	USA-United States of America
	FAUSTO Stephanie May	
	HER Landon	
SILVER	YI/DARLIN	
	YI Kristian	
	DARLIN Alexa	
BRONZE	NGUYEN/CHAU	VIE-Vietnam
	NGUYEN Quang Phuc	
	CHAU Tuyet Van	
	REYNA/ARELLANO	MEX-Mexico
	REYNA Robinson	
	ARELLANO Marisa	



Contest Results
2026 U.S. OPEN CHAMPIONSHIPS1
Final Pair Over 17
As of 05 MAR 2026



Rank	Contest No	NOC	Name	Score	Acc/Tech	Total	Detail					
					Pre		Game	Score	Acc/Tech	Pre	Total	Deduct
1	764	USA	FAUSTO/HER Stephanie May FAUSTO Landon HER	8.600	5.200	42.8	Game1	8.600	5.200	3.400	42.8	0.0
					3.400		Game2	0.000	0.000	0.000	0.0	0.0
2	763	USA	YI/DARLIN Kristian YI Alexa DARLIN	8.533	5.133	43.0	Game1	8.533	5.133	3.400	43.0	0.0
					3.400		Game2	0.000	0.000	0.000	0.0	0.0
3	765	VIE	NGUYEN/CHAU Quang Phuc NGUYEN Tuyet Van CHAU	8.200	4.900	41.2	Game1	8.200	4.900	3.300	41.2	0.0
					3.300		Game2	0.000	0.000	0.000	0.0	0.0
4	766	MEX	REYNA/ARELLANO Robinson REYNA Marisa ARELLANO	8.166	4.966	40.7	Game1	8.166	4.966	3.200	40.7	0.0
					3.200		Game2	0.000	0.000	0.000	0.0	0.0

