



**WORLD  
AQUATICS**

**ARTISTIC SWIMMING  
MANUAL FOR JUDGES,  
TECHNICAL CONTROLLERS,  
REFEREES & COACHES**

**2022-2025**

In force as from 15 June 2023

## TABLE OF CONTENTS

<b>CHAPTER I. - GENERAL INFORMATION FOR JUDGES, EVALUATORS, TECHNICAL CONTROLLERS AND COACHES .....</b>	<b>1</b>
1. WORLD AQUATICS ARTISTIC SWIMMING JUDGES LIST .....	1
2. THE EVALUATION OF JUDGES .....	2
3. WORLD AQUATICS ARTISTIC SWIMMING EVALUATORS POLICIES AND PROCEDURES.....	7
4. SELECTION OF JUDGES .....	9
5. WORLD AQUATICS CERTIFICATION/DEVELOPMENT SCHOOL FOR JUDGES .....	10
6. TECHNICAL CONTROLLERS (DIFFICULTY & SYNCHRONIZATION).....	19
7. ETHICS IN ARTISTIC SWIMMING .....	28
<b>CHAPTER II. - FIGURES.....</b>	<b>31</b>
8. GENERAL CONCEPTS OF JUDGING FIGURES.....	32
9. GUIDELINES FOR JUDGING FIGURES .....	32
10. IDENTIFYING DIFFICULTY IN FIGURES .....	58
11. ANALYSIS OF FIGURES .....	64
<b>CHAPTER III. - ROUTINES .....</b>	<b>200</b>
12. INTRODUCTION .....	201
13. ROUTINE ELEMENTS AND TRANSITIONS.....	201
14. JUDGING ROUTINES - GENERAL OVERVIEW .....	204
15. JUDGING ELEMENTS .....	204
16. JUDGING ARTISTIC IMPRESSION.....	228
17. TECHNICAL ROUTINES.....	241
18. ACROBATIC ROUTINE.....	284
19. FREE COMBINATION .....	286
20. MIXED DUETS FREE.....	290
21. GLOSSARY OF TERMS FOR ROUTINES.....	291
<b>CHAPTER IV. - REFEREE GUIDELINES .....</b>	<b>294</b>
22. GENERAL GUIDELINES.....	294
23. SUMMARY OF PENALTIES FOR VIOLATIONS OF RULES IN APPENDICES II, III, IV AND V REPORTED TO REFEREE BY DTC .....	299
<b>CHAPTER V. - MEDICAL ISSUES IN ARTISTIC SWIMMING .....</b>	<b>301</b>
24. ILLNESSES IN ARTISTIC SWIMMING.....	301
25. INJURIES IN ARTISTIC SWIMMING.....	304
<b>CHAPTER VI. - GUIDELINES FOR APPROPRIATE CONDUCT AT COMPETITIONS.....</b>	<b>307</b>
26. GENERAL CONDUCT .....	307
27. CONDUCT DURING PRACTICES .....	307
28. CONDUCT DURING THE COMPETITION .....	308

# CHAPTER I. - GENERAL INFORMATION FOR JUDGES, EVALUATORS, TECHNICAL CONTROLLERS AND COACHES

## 1. WORLD AQUATICS ARTISTIC SWIMMING JUDGES LIST

1. Each World Aquatics Artistic Swimming Judge (“World Aquatics Judge”) shall be classified as either a category “A” or “G” on the World Aquatics Artistic Swimming Judges List (“World Aquatics Judges List”).
2. All World Aquatics Member Federations (“Member Federations”) may submit up to eight (8) Judges annually to be considered for their inclusion as category “A” World Aquatics Judges on the World Aquatics Judges List (note: if a Member Federation had ten (10) Judges in category “A” on the Judges List in 2021, Judges of that Member Federation will be legacied through until the Member Federation has eight (8) “A” Judges). All Member Federations may submit up to five (5) Judges annually to be considered for their inclusion as category “G” World Aquatics Judges on the World Aquatics Judges List.
3. World Aquatics “A” Judges must attend the World Aquatics Artistic Swimming Certification School for Judges (“Certification School”) and pass the exam with at least an 85% pass mark every four (4) years.
4. All Member Federations may submit up to five (5) Judges annually to be considered for their inclusion on the World Aquatics Judges List as category “G” Judges.
5. World Aquatics “G” Judges must attend the Certification School and pass the exam with at least an 80% pass mark every four (4) years.
6. All nominated “A” and “G” Judges must pass the World Aquatics Online Assessment annually (“Annual Online Assessment”) in order to be considered an active Judge on the Judges List. “A” Judges need at least an 85% passing mark and “G” Judges need at least an 80% passing mark. The only exception is World Aquatics Instructors who create the assessment and, therefore, do not need to take the assessment.
7. In order to be accepted by World Aquatics as a “G” Judge, candidates must, in the below order, (a – d):
  - a) complete the current World Aquatics school certification pathway,
  - b) pass the World Aquatics Advanced Certification Exam,
  - c) complete the required judging hours and submit their records to the Continental Representative for their approval before their name can be submitted by their Member Federation to the World Aquatics, and
  - d) attend a Certification School and obtain at least an 80% passing mark to qualify as a World Aquatics “G” Judge.
8. All nominations must be submitted to the World Aquatic’s Office in Lausanne, Switzerland by November 1st annually.

9. Each Member Federation must complete and submit to World Aquatics an activity report for each of its World Aquatics “A” and “G” Judges by November 1<sup>st</sup> annually.
10. World Aquatics is the only body which can classify a Judge as World Aquatics “A” or a “G” Judge on the World Aquatics Judges List, subject to the approval of the World Aquatics Bureau.
11. Members of the World Aquatics Technical Artistic Swimming Committee (“TASC”) are in addition to the maximum quota of World Aquatics “A” or “G” Judges allowed per Member Federation and are identified on the World Aquatics Judges List with a letter “F”. When such individuals are no longer members of the TASC, two things shall be considered when determining their subsequent status as a World Aquatics Judge:
  - World Aquatics Judges List category when they became a member of the TASC.
  - Judging activity during their term in the TASC.

If their Member Federation’s quota is at the maximum level, the former TASC member shall be in addition to the quota until a vacancy becomes available. If a former member was not on the World Aquatics Judges List when initially named to the TASC, their status shall be determined based on judging activity during their term on the TASC.

12. The maximum age for a Judge to be included on the World Aquatics Judges List is sixty-five (65) years of age, as per the World Aquatics By-Laws.
13. The World Aquatics Judges List will be generated from the World Aquatics GMS and made available on the World Aquatics website under <http://www.fina.org/content/fina-officials-lists>.

## **2. THE EVALUATION OF JUDGES**

### **2.1 GENERAL REQUIREMENTS**

World Aquatics Judges are required to be evaluated, at a minimum, on four (4) competitions over a period of four (4) consecutive years. Member Federations with Judges on the World Aquatics Judges List should enable them to officiate at competitions where they can be evaluated by a World Aquatics certified Evaluator (“World Aquatics Evaluator”).

The evaluation process will include:

- Observation by one (1) or more World Aquatics Evaluators.
- Statistical evaluation using a World Aquatics approved computer program.
- Evaluations must be from competitions where the current World Aquatics judging scoring and evaluation systems are used.
- Evaluations must be from competitions with at least three (3) Member Federations participating.
- Evaluations must include at least three (3) sessions in the competition.

## 2.2 JUDGES' EVALUATION SCALES

### Overall

90% - 100%	Very Good
80% - 89%	Good
65% - 79%	Satisfactory
50% - 64%	Deficient
0% - 49%	Weak

### Bias

3 - 3/N	Good
2 - 2/N	Acceptable
1 - 1/N	Unacceptable
N/A	Not Applicable (figures only)
N	Neutral

## 2.3 JUDGES CLASSIFICATION CRITERIA

### 2.3.1 World Aquatics "A" Judges

To remain as a category World Aquatics "A" Judge on the World Aquatics Judges List, Judges must:

- Have attended a Certification School and passed the exam with at least an 85% pass mark once every four (4) years, unless otherwise directed by the TASC.
- Pass the annual online exam with a score of at least 85%, unless otherwise directed by TASC.
- Demonstrate and submit annual activity on the Activity Form to the World Aquatics Office.
- Annual activity may include:
  - Officiating at National Championships,
  - Judging at competitions of other Member Federations,
  - Presenting at or attending Judges' Training Clinics/Seminars either domestically or in another country,
  - Judging at International Competitions, or
  - Attend competitions as a World Aquatics Evaluator.
- Obtain at least three (3) evaluations from World Aquatics Evaluators with a pass mark of 85% or greater and a Bias rating of 3/3N in a four (4) year period, from three (3) different competitions, of which two (2) must be in the immediately preceding two (2) years.
  - At least two (2) of the evaluations must be from a World Aquatics Evaluator from a country other than that of the Judge, except for TASC Members who are World Aquatics Evaluators.
  - At least one (1) of the evaluations must be from a Senior competition and one (1) of the evaluations must be from a large Junior, Youth or Age Group competition (at least ten (10) athletes must be in the session for an evaluation to be considered from a large competition).

World Aquatics "A" Judges may be demoted from "A" to "G" category on the World Aquatics Judges List for lack of evaluated international activity and/or unacceptable evaluations.

To remain on the as a category “G” Judge on the World Aquatics Judges List, Judges must:

- Attend a Certification School and pass the exam with at least an 80% pass mark once every four (4) years, unless otherwise directed by TASC.
- Take and pass the Annual Online Assessment with at least 80% pass mark, unless otherwise directed by the TASC.
- Demonstrate and submit Judge’s annual activity on the Activity Form to the World Aquatics Office. Annual activity may include:
  - Officiating at National Championships.
  - Judging at competitions of other Member Federations.
  - Presenting or attending Judges’ Training Clinics/Seminars, either domestically or in another country.
  - Judging at international competitions as an active Judge or as a Practice (shadow) Judge.
  - Obtain at least three (3) evaluations from World Aquatics Evaluators with a rating of 80% or greater and a Bias rating of 3/3N in a four (4) year period, from three (3) different competitions, of which two (2) must be in the immediately preceding two (2) years.
  - At least two (2) of the evaluations must be from a World Aquatics Evaluator from a country other than that of the Judge, except for TASC Members who are World Aquatics Evaluators.
  - At least one (1) of the evaluations must be from a Senior competition and one (1) of the evaluations must be from a large Junior, Youth or Age Group competition (at least ten (10) athletes must be in the session for an evaluation to be considered from a large competition).

### **2.3.2 World Aquatics “G” Judges**

World Aquatics “G” Judges may be removed from the World Aquatics Judges List due to lack of evaluated international activity and/or unacceptable evaluations.

In order to be promoted from “G” to “A” category on the World Aquatics Judges List, Judges must:

- Complete the Certification School and passed the exam with at least an 80% pass mark once every four (4) years.
- Pass the Annual Online Assessment with at least an 80% pass mark.
- Obtain a minimum of four (4) evaluations in a six (6) year period, with the two (2) most recent evaluations in the previous two (2) years:
  - Evaluations must be from a World Aquatics Evaluator.
  - A maximum of one (1) evaluation may be as a Practice Judge.
  - Four (4) evaluations must be with at least an 80% rating and a Bias rating of 3/3N.
  - If a Judge receives an evaluation of “Unacceptable” (1/1N) for Bias from any competition, then the evaluation from that competition shall not be considered.

- At least two (2) evaluations must be from competitions outside Judge's own Continent or from a competition where at least six (6) Federations from two (2) or more Continents participate.
  - At least two (2) evaluations must be from a World Aquatics Evaluator from a different country to that of the Judge, except for TASC Members who are World Aquatics Evaluators.
  - At least two (2) evaluations must be from a Senior competition, and at least two (2) evaluations must be from a large Junior, Youth or Age Group competition (at least ten (10) athletes must be in the session for an evaluation to be considered from a large competition).
  - At least one (1) evaluations must be from a competition with athletes from a different Continent to that of the World Aquatics Judge.
  - Evaluations for Virtual Competitions may be considered.
- Competitions that may be taken into consideration for promotion:
- Continental Championships or Games – Senior, Junior, Youth or Age Group, which have an Evaluator.
  - Competitions that have an Evaluator appointed, either by World Aquatics or by the Host Member Federation.
  - Major Regional or Member Federation Championships that have a World Aquatics Evaluator.

### **2.3.2.1 Practice judging**

Of the four (4) evaluations required for the promotion from category "G" to "A" on the World Aquatics Judges List one (1) may be as a Practice Judge.

For World Aquatics Championships, World Aquatics Cups (formerly World Series), World Aquatics Junior Championships, World Aquatics Youth Championships, and the Olympic Qualification Tournament, Member Federations may submit applications for Practice Judges to the World Aquatics Office. Applications must be submitted no later than sixty (60) days prior to the start of the competition.

Member Federations are permitted to have a maximum of one (1) Practice Judge per competition, and the Host Federation is permitted to have a maximum of two (2) Practice Judges.

Practice judging is not permitted at the Olympic Games.

To be eligible to be a Practice Judge at any of the aforementioned competitions, the World Aquatics "G" Judge must have attended a Certification School and passed the exam with a required pass mark and successfully completed the Annual Online Assessment.

World Aquatics "A" Judges are not permitted to be a Practice Judge at the competitions.

## **2.4 EVALUATION REPORTS**

The evaluation data is reviewed and compiled into individual Judge files by the World Aquatics.

Each report is included in the Judge's file to become part of the basis for decisions regarding remaining on the World Aquatics Judges List and/or promotion/demotion.

The evaluation files are used to assist World Aquatics in selecting World Aquatics Judges for the World Aquatics Championships, the Olympic Games, World Aquatics Cups, and the Olympic Qualification Tournament.

Each World Aquatics Evaluator shall, to the best of their judgment, determine how accurately a Judge scores routines and figures according to the criteria set forth in the World Aquatics Handbook. Additional factors to be considered by the World Aquatics Evaluator include Judges':

- Use of the score range
- Independence of opinion
- Level of concentration
- Evidence of bias
- Promptness in arriving at meetings/events and delivery of scores
- Ability to make decisions and contribute to discussions at Judges' meetings
- Professional attitude/behavior and compliance with the appropriate dress code
- Always demonstrating fair play
- Positive attitude
- Displaying ethical values

The Evaluators are required to provide all their reports together with the individual Judge detailed evaluation reports and comments to the World Aquatics Office within 40 (forty) days of the end of the competition. Distribution of the individual Judges' detailed evaluation reports and all other documents pertaining to Judges' evaluations is the responsibility of the World Aquatics Office.

#### **2.4.1 Appeals Policy**

It needs to be recognized that evaluations are not an exact science; that the World Aquatics Evaluators are human and subject to the same influences as the Judges whether positive or negative. Therefore, there is an appeal process available when a Judge feels that their evaluation is unfair or biased against them. Judges can appeal only if their overall rating is below 50% and/or a Bias rating of 1. An evaluation can be overturned on appeal.

Appeals Process:

- A Judge reports their evaluation to their Member Federation requesting a review within 60 (sixty) days of the date World Aquatics sends their report.
- The Member Federation submits an appeal to the World Aquatics Office.
- The Commission will review the application.
- The World Aquatics may appoint an Independent Evaluator from the current Evaluators List to review and assess the appealed evaluation. The review must include a thorough examination of the rating the Judge received and must provide a rationale for what, if any, adjustment to the Judge's evaluation is required. This review would include reviewing computer printouts, Judge's scores, the panel scores, the Evaluator's scores, and supporting documentation provided by the original World



Aquatics Evaluator on how the rating and/or Bias rating were determined. World Aquatics will provide all reports necessary for the Independent Evaluator to complete the review.

- The independent review is to be completed within sixty (60) days of the appointment of and receipt of supporting documentation by the Independent Evaluator conducting the review.

World Aquatics, the Member Federation, the Judge, and the World Aquatics Evaluator will receive a copy of the independent report conducted by the Independent Evaluator and its conclusions. Any evaluation report that is revised must be sent by the Independent Evaluator to the World Aquatics Office, who is responsible for sending the revised report to the Judge. The World Aquatics Database Manager, the Continental Database Manager and the Member Federation of the Judge will only receive a copy of the revised summary.

The World Aquatics Appeal decision is final.

Judges wishing to discuss their evaluation for the purpose of clarification or additional feedback are encouraged to approach the Evaluator directly, with a copy of the request to the World Aquatics Office.

### **3. WORLD AQUATICS ARTISTIC SWIMMING EVALUATORS POLICIES AND PROCEDURES**

The World Aquatics Artistic Swimming Evaluators list ("World Aquatics Evaluators List") shall be composed of World Aquatics "A" Judges appointed by the TASC for a two (2) year period. World Aquatics will approve a maximum of two (2) World Aquatics Evaluators from the same Member Federation. Member Federations submitting two (2) Evaluator names must select a first-choice pick and a second-choice pick in the event that World Aquatics is unable to select two (2) Evaluators from the same Member Federation due to the number of applications received. Every World Aquatics Judge with a minimum of five (5) years in the "A" category may apply directly to the World Aquatics Office once the procedure is open. It is not necessary to be on the current Judges list to apply but the applicant must demonstrate recent judging activity with World Aquatics and strong evaluations.

The World Aquatics will review the applications and will make the final decision about the World Aquatics Evaluators List.

Applications must be accompanied by a resume of the World Aquatics Judge's experience as a World Aquatics Evaluator and a record of their own judging statistics. World Aquatics Evaluators will not be selected to judge at World Aquatics competitions. Before their approval by World Aquatics, Evaluators must complete and pass a practical exercise.

The World Aquatics Evaluators List will be generated from the GMS and made available on the World Aquatics website under <http://www.fina.org/content/fina-officials-lists>.

World Aquatics is the only body that can approve or remove a World Aquatics Evaluator from the World Aquatics Evaluators List. Positions on the list are not transferable within a Member Federation.

The nominated Evaluators must have a working knowledge of and ability to communicate in English. They must have strong facilitating skills and be able to use the software required for reporting to World Aquatics. World Aquatics Evaluators can remain on the World Aquatics Evaluators List even after their retirement as an “A” Judge. The maximum age of the Evaluator is 70 (seventy).

World Aquatics Evaluators must stay current and attend World Aquatics seminars for World Aquatics Evaluators, as requested to attend (live or online sessions). Evaluators must attend the Certification School and pass the test once every four (4) years as well as to pass the Annual Online Assessment, unless otherwise directed by the World Aquatics. Nominated Evaluators must also take and pass a World Aquatics Evaluator practical assignment in order to be accepted to the Evaluators List.

Member Federations hosting an international competition may invite, at the Member Federation’s expense, an Evaluator. Member Federations are **required to notify the World Aquatics Office** of the name and date of the competition and the name of the invited Evaluator. **All World Aquatics Evaluators must be approved in advance by the World Aquatics Office.** Before accepting an invitation to evaluate at a competition, Evaluators are required to contact the World Aquatics Office to ensure that they have been approved. National Championship evaluations will not be considered by World Aquatics.

Member Federation Organizing Committees where an Evaluator is present are expected to fully co-operate with the Evaluator. The host Member Federation is expected to use a World Aquatics approved computer evaluation software program to accompany the competition results.

### **Roles, Responsibilities and Skills**

World Aquatics Evaluators:

- Are expected to attend and lead all Judges’ meetings to set the World Aquatics standard of excellence during the competition. All meetings are to be conducted in English.
- During routine events should be seated on the pool deck or on the Judges’ platform during the routine events.
- During figures competitions may circulate among the panels on the pool deck.
- Unofficially judge every session to compare their scores to those of the Judges being evaluated.
- At the conclusion of each session, if appropriate, and/or following finals, host judge debrief meetings for the purpose of Judges’ education and accountability.
- Must ensure they have the email addresses of all the Judges at the competition and that all the Judges have their email.
- Must be willing to share technical knowledge with colleagues that are developing as Judges and Evaluators.

The World Aquatics Evaluators may be evaluated by World Aquatics on the following skills:

- How timely they complete and deliver evaluation reports to the World Aquatics Office.
- Their ability to complete all the required forms accurately.
- How effectively they lead the Judges’ meetings and debrief sessions.

- Their ability to confront issues on site, addressing bias, cohort judging, using the correct score range, recognizing athletes of equal level, ranking, Judges having any difficulties with judging, and ethics.
- Feedback from the event Referees, Judges, Coaches, athletes, and TASC will be taken into consideration, as needed.
- Their neutrality and ethics.
- Their computer skills, including Microsoft Word, Excel, Adobe Acrobat, and file sharing programs.

The World Aquatics Evaluator must refrain from posting to any social media outlet in relation to the event, the athletes, the officials, or anyone serving in any capacity at the event while on duty at the competition.

### **Conflict of Interest**

The World Aquatics Evaluator must declare all conflicts of interest to World Aquatics in advance, e.g., if the Evaluator currently is, or has in the past twelve (12) months been, a regular Coach/choreographer of the athletes or when the livelihood of the World Aquatics Evaluator is dependent on or is perceived to be dependent on the result of any athlete in the competition.

## **4. SELECTION OF JUDGES**

Selection of Judges for the Olympic Games, the Olympic Qualification Tournament, the World Aquatics Championships, World Aquatics Cups, and other World Aquatics competitions will include consideration of the following:

- a) World Aquatics Judges List category
- b) Completing all activity requirements (see Section 5)
- c) Continental representation
- d) Evaluations
- e) The ability to demonstrate fair play on and off the field of play
- f) Positive attitude and adherence to World Aquatics ethics (see Section 7)
- g) No bias for or against any athletes on any grounds in competitions
- h) Demonstrated ability to base their marks or decisions only on the current performance without influence by a reputation or past performances

For World Championships, the Olympic Qualification Tournament, and the Olympic Games, only World Aquatics "A" Judges who have judged at least two (2) evaluated international competitions in the previous two (2) years and received evaluations with a rating of 85% or greater and Bias ratings of 3 shall be selected. Refer to World Aquatics By-Laws.

For the World Junior Championships and World Youth Championships each National Federation may send two (2) World Aquatics Judges. This may be World Aquatics "A" and/or a "G" Judge who has judged at a minimum of two (2) international competitions in the previous two (2) years and received evaluations above 85% for "A" Judges or 80% "G" Judges, and Bias ratings of 3.

Qualified TASC Members may be used as Judges at any World Aquatics competition.

The number of Judges appointed to the Olympic Games is determined by the International Olympic Committee (IOC) and/or World Aquatics.

Additional Judges from Member Federations not participating at the competition may be permitted to judge subject to the approval by the World Aquatics Office and the local organizing committee.

**Conflict of Interest:**

World Aquatics Judges with a conflict of interest shall not be selected for events/competitions. The following categories of people are deemed to have a conflict of interest:

- a) A Relative of an athlete
- b) A current Coach of an athlete or Relative of a current Coach of an athlete
- c) A Team Manager or a Relative of a Team Manager
- d) An inhabitant of the same household of the athlete and any of a), b) & c) above
- e) A person who receives money from any Member Federation that has athletes in the competition
- f) When the official currently is, or has in the past twelve (12) months been, the regular Coach/choreographer of the athlete
- g) When the livelihood of the official is dependent on, or is perceived to be dependent on, the outcome

A "Relative" refers to a person connected with another by blood or marriage (including partner). Relative also includes step relationships including parent, child, sibling, uncle, aunt, nephew, niece, first cousin, grandparent, or spouse.

A "Coach" refers to any person who coaches figures and/or routines on a regular basis to the athlete.

## **5. WORLD AQUATICS CERTIFICATION/DEVELOPMENT SCHOOL FOR JUDGES**

### **5.1 INTRODUCTION**

The main goal of this program is to promote sports growth by offering a continuous learning pathway for active artistic swimming Judges, providing, and setting the necessary competencies to become a World Aquatics Judge.

A range of World Aquatics Development and Certification Schools are currently offered by the World Aquatics Development Program, with the objective of establishing a universal and standardized Judges training and certification system.

Through this program, all the participants have access to the same information, guidelines, and interpretation of the World Aquatics Rules, increasing the number of certified officials and enhancing their knowledge.

### **5.2 WORLD AQUATICS OFFICIALS' CERTIFICATION PATHWAY**

The World Aquatics Officials Certification Pathway allows a Technical Official to progress through different steps to become a recognized International Technical Official.

There are a variety of entry points for officials, depending on their existing knowledge, experience, proven abilities, and qualifications. The below flowchart illustrates how the officials may progress along the certification pathway:

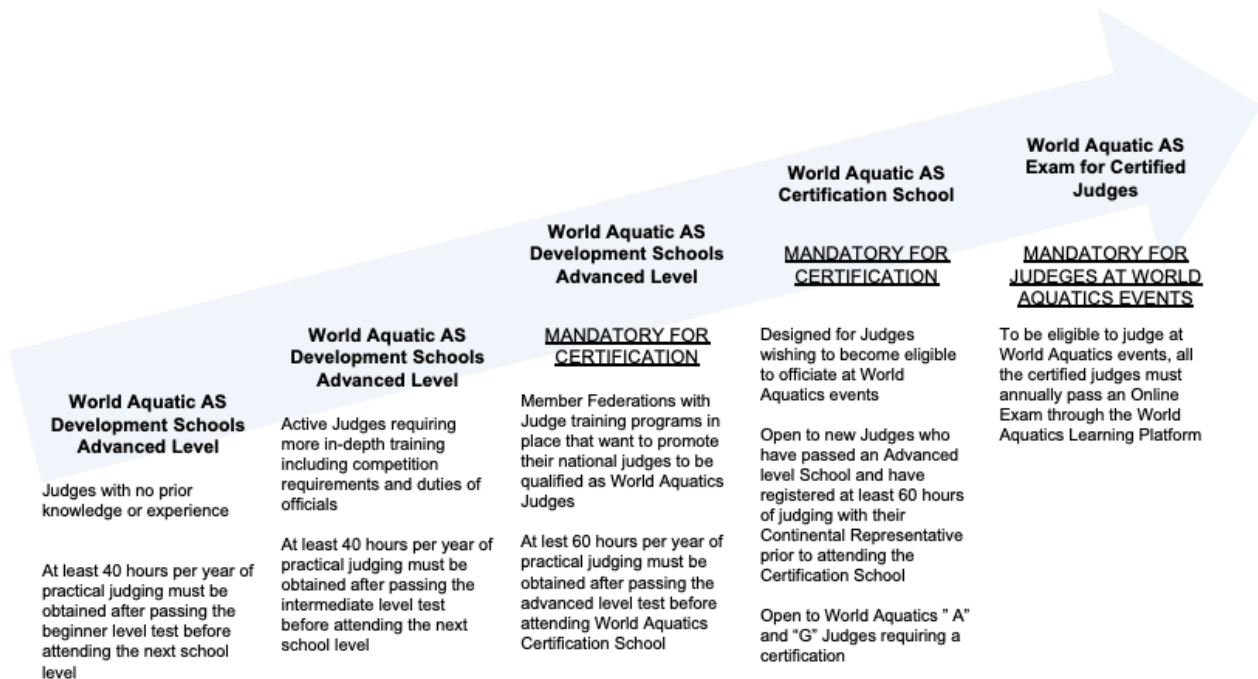

### 5.2.1 Description

The World Aquatics Artistic Swimming Development and Certification Schools are held over a duration of three (3) days concluding with an Exam. Every effort will be made by the host of the school to ensure that the exam is written in the early afternoon so participants may return home that day.

The official working language for the World Aquatics Artistic Swimming Development and Certification Schools for Judges is English.

The curriculum will be based on the World Aquatics Artistic Swimming Manual for Judges, Coaches & Referees 2022-2025, and the World Aquatics Rules 2022-2025.

The courses are given by Instructors, members of the World Aquatics TASC or appointed by the World Aquatics TASC based on the following criteria:

- Continental representation consideration
- Proven experience with teaching and facilitating courses/seminars
- Proven professionalism and neutrality
- Evaluation excellence
- Superior communication skills
- Displayed strong ethics
- Conflicts of Interest

Instructors will be proposed to World Aquatics from the list of current World Aquatics “A” Judges/Evaluators or recently retired World Aquatics “A” Judges/Evaluators. These will be reviewed every four (4) years or as required by World Aquatics.

### **5.2.2 Requirements**

At least ten (10) Judges must attend in order to have a World Aquatics Artistic Swimming Development or Certification School. Maximum registered delegates are thirty (30) people per school, including observers.

- If the maximum number of thirty (30) Judges is not reached at the conclusion of the registration, additional observers are welcome to attend up to the total maximum of 30 delegates.
- No more than one Coach per federation may register as observer.
- No observers have the right to write the exam.
- All candidates and observers must be registered in the World Aquatics GMS by the required deadline to be eligible.

The registration for the schools will be closed once the maximum number of participants has been reached.

All the participants attending a World Aquatics Artistic Swimming Development or Certification School must be nominated by their National Federations through the World Aquatics GMS by the registration deadline. All participants shall ensure that they comply with the below requirements:

- Be at least 18 years of age and not over 65 (sixty-five) years of age at the start of the World Aquatics Development School program.
- Demonstrate a good level of spoken and written skills in English.
- Fully participate in all sessions of the course and complete all required assessments.
- Agree to abide by the World Aquatics Code of Ethics.
- It is strongly recommended that candidates have independent appropriate travel and health insurance coverage before undertaking any independent officials practice covering any unusual circumstances, including Covid.

Only fully submitted registrations will be considered for approval. The nationality of the nominated participants will be verified by the World Aquatics Office.

Please note that only approved participants may attend a World Aquatics Artistic Swimming Development or Certification School.

### **5.2.3 Exam Writing – Code of Conduct**

If a participant is absent one (1) day from the school, they cannot take the test. If a participant is absent a half day for unusual circumstances, they must provide the reason for their absence to the instructor. This will be taken into consideration by the instructor in determining whether the participant will be allowed to take the test.

For the written exam, interpreters, use of online resources, electronic watches, and cell phones are not permitted. Paper dictionaries are allowed but must be shown to the instructor prior to writing the exam.

Disciplinary actions will be taken against those who act in a dishonest way or for any misconduct, including the removal from the World Aquatics List for a two-year period.

### **5.3 WORLD AQUATICS ARTISTIC SWIMMING DEVELOPMENT SCHOOLS FOR JUDGES**

#### **5.3.1 Overview**

For any person to begin training as an Artistic Swimming Judge, World Aquatics offers to all National Federations the possibility to host a World Aquatics Artistic Swimming Development School at three different levels:

- **AS Development Schools – Beginner level** are designed to meet the needs of those National Federations who have requested Judges' instruction and do not have any Judges training program in place. This School caters to those with limited basic knowledge or no experience in judging. These schools are online.
- **AS Development Schools – Intermediate level** are designed for those National Federations that have Judge training programs in place and host national Age Group competitions. Judges participating will be knowledgeable, active, and experienced requiring more in-depth training of skills at an intermediate level, including competition requirements and duties of officials. These schools are online.
- **AS Development Schools – Advanced level** are designed for National Federations that have their own Judges school program and want to promote their national Judges to be qualified as World Aquatics Judges. It is recommended for those Federations running national Artistic Swimming Age Group and Senior competitions. This School caters to those who require more in-depth training of skills at an advanced level and helps to prepare participants to attend, participate, and certify at a World Aquatics Artistic Swimming Certification School for Judges.

Please note that the following individuals do not need to attend a World Aquatics Artistic Swimming Development School and may attend a World Aquatics Artistic Swimming Certification School to write their exam: National Team Elite Artistic Swimming athletes (retired), National Team Coaches, and National Judges, if the following requirements have been met:

- Significant judging activity at a national level involving different age groups for a minimum of three (3) years
- Judging at international events hosted by their own Member Federation
- Proven judging ability with strong evaluations from a World Aquatics Certified Evaluator for a minimum of three (3) years

**Federations wishing to nominate a candidate for exemption must forward the name to the World Aquatics Office and submit the required paperwork (judging activity report and copies of evaluations for a minimum of three (3) years according to the timelines).**

### 5.3.2 Specific course requirements

These courses are open to all the National Federations interested in training Judges that are not on the current World Aquatics List.

All participants attending a World Aquatics Artistic Swimming Development School shall ensure that they comply with the below requirements:

- At least forty (40) hours per year of practical judging must be obtained after passing the test at a World Aquatics Artistic Swimming Development School - Beginner or Intermediate level prior to advancing to the next school level (either from Beginner to Intermediate or from Intermediate to Advanced).
- At least sixty (60) hours per year of practical judging must be obtained after passing the test at a World Aquatics Artistic Swimming Development School - Advanced level prior to attending a World Aquatics Artistic Swimming Certification School. The level of meets that the Judge attends will be considered. Advanced Judges are encouraged to gain experience outside of their federation.

### 5.3.3 Assessment

At the conclusion of the school, all the Judges will take a test. In order to pass a World Aquatics Artistic Swimming Development School, participants must:

- Obtain a minimum score of 80% at the Beginner level
- Obtain a minimum score of 80% at the Intermediate level
- Obtain a minimum score of 85% at the Advanced level

Judges who pass the school will receive a diploma, which entitles the holder to participate at the next World Aquatics Artistic Swimming Development School level subject to having obtained the required judging hours as described in Section 4.2 below.

**IMPORTANT NOTE:** Participants must obtain a minimum score of 85% at the Advanced level test. They then must judge for a minimum of sixty (60) hours. This judging activity must be reported to their Continental Representative before they will be considered eligible to participate at a World Aquatics Artistic Swimming Certification School.

**The judging activity must be sent to the Continental Representative using the Activity Report Form for new Judges, with a copy sent to the World Aquatics Office for approval.**

## 5.4 WORLD AQUATICS ARTISTIC SWIMMING CERTIFICATION SCHOOLS FOR JUDGES

### 5.4.1 Overview

The World Aquatics Artistic Swimming Certification Schools will prepare and certify highly qualified Judges wishing to be registered, or to remain registered on, the World Aquatics List.

**IMPORTANT NOTE:** In order to be considered for judging at a World Aquatics Competition, a Judge must have successfully passed the Judges Exam administered at one of the World Aquatics Artistic Swimming Certification Schools for Judges every four (4) years plus the annual on-line exam, unless otherwise directed by the World Aquatics TASC (World Aquatics Instructors are exempt).



World Aquatics Evaluators must attend a World Aquatics Certification School for Judges and pass the test once every four (4) years, unless otherwise directed by the World Aquatics TASC (World Aquatics Instructors are exempt), as well as pass the annual on-line exam.

Judges who do not pass the Certification Exam have a second opportunity to rewrite the exam within the one-year period and before November 1st of the following year.

#### **5.4.2 Specific course requirements**

The World Aquatics Artistic Swimming Certification Schools are open to Judges wishing to be registered, or to remain registered on, the World Aquatics Judges List. All candidates must comply with one of the following requirements:

- New Judges are eligible to attend a Certification School if they have passed the Advanced level school (minimum score 85%) and have registered at least sixty (60) hours of judging activity after the date of the advanced exam with their Continental Representative. Only those candidates having their judging activity approved by their Continental Representative are eligible to register for a World Aquatics Artistic Swimming Certification School.
- World Aquatics “A” Judges and “G” Judges that are already on the World Aquatics Judges List and require certification may register to a Certification School without having previously passed the Advanced level school’s exam.

Priority for attendance at World Aquatics Artistic Swimming Certification Schools shall be:

- Judges who have registered through the GMS for certification by no later than the registration deadline established per each World Aquatics School.
- One Coach per Member Federation is allowed to attend as an Observer, if they are registered through the World Aquatics GMS by the established deadline and that the maximum number of participants (30) has not been reached. They are expected to attend all sessions except for the examination.
- If there are additional spaces available, World Aquatics age eligible active national level Judges (65 and under) and active national level Coaches may fill the remaining spots. They must be registered through the World Aquatics GMS as an Observer and will be approved by World Aquatics on a first come first serve basis.

#### **5.4.3 Assessment**

To receive the certification, a Judge must attend a World Aquatics Artistic Swimming Certification School and pass the test with a minimum score of 85% for World Aquatics “A” Judges and 80% for “G” Judges.

#### **5.4.4 Assessment retake policy**

Judges who do not pass the exam may take it a second time by no later than 1<sup>st</sup> November at a World Aquatics Artistic Swimming Development or Certification School:

- Judges rewriting the exam may choose to attend the entire course or sit for the exam only.

- They must be registered through the World Aquatics GMS by the established deadline.
- Please note that a Judge is allowed to write **two (2) exams per year only**.

#### **5.4.4.1 World Aquatics “A” Judges**

A World Aquatics “A” Judge must have attended a World Aquatics Artistic Swimming Certification School for Judges and passed the certification exam once every four (4) years with a score of 85% or higher.

- If a World Aquatics “A” Judge fails the certification exam on the first attempt with a score below 85% but passes the exam on the second attempt with a score of 85% or higher, they remain on the World Aquatics Judges List in the “A” category.
- If a World Aquatics “A” Judge fails the certification exam on the first attempt with a score below 85% but passes the exam on the second attempt with a score between 80-84%, they are demoted to World Aquatics “G” Judge status.
- If a World Aquatics “A” Judge fails the certification exam on the first attempt with a score below 85% and fails the certification exam with a score below 80% on the second attempt, they will be removed from the World Aquatics Judges List.

**IMPORTANT NOTE:** A World Aquatics “A” Judge who has been demoted to a World Aquatics “G” Judge status may continue to judge and to receive evaluations that will be considered for reinstatement to the World Aquatics “A” category. Evaluations from the previous two (2) years will be considered along with at least two (2) current evaluations.

#### **5.4.4.2 World Aquatics “G” Judges**

A World Aquatics “G” Judge must have attended a World Aquatics Artistic Swimming Certification School for Judges and passed the certification exam once every four (4) years with a score of 80% or higher.

- If a World Aquatics “G” Judge fails the certification exam on the first attempt with a score below 80% but passes on the second attempt with a score of 80% or higher, they remain on the World Aquatics Judges List in the “G” category.
- If a World Aquatics “G” Judge fails the certification exam on the second attempt with a score below 80%, they will be removed from the World Aquatics Judges List.

**IMPORTANT NOTE:** To be considered for reinstatement to the World Aquatics Judges List, the Judge must attend a World Aquatics Artistic Swimming Development School – Advanced level and pass the advanced level exam with a minimum score of 85%.

In addition, the Judge must comply with the following steps for reinstatement in the World Aquatics “G” category:

- Obtain a minimum score of 85% at the Advanced level test. After the Judge passes the Advanced level test, they must do a practicum and judge at competitions for a minimum of sixty (60) hours. When the Judge has completed the judge practicum, their activity must be submitted to the Continental Representative for approval. Once the Continental Representative has approved the judging activity in the log, the Judge will then become eligible to write the Certification exam.

- Attend a World Aquatics Artistic Swimming Certification School and pass the test with a minimum score of 80%. Judges will not be added to the World Aquatics Judges List until after they pass the Certification test.
- Must have their nomination for the World Aquatics Judges List submitted by their Member Federation.

#### **5.4.5 Procedure for non-attendance at a World Aquatics Artistic Swimming (“AS”) Certification School or Fast Track**

##### **5.4.5.1 World Aquatics “A” Judges**

World Aquatics “A” Judges who have been prevented from attending a Certification School for personal reasons may submit a written request to the World Aquatics with a copy sent to the Continental Representative, to be considered as a candidate for the World Aquatics Fast Track Program for reinstatement in the “A” category.

In order to be considered by the TASC for reinstatement as a World Aquatics “A” Judge, the candidate must provide the following documents to the TASC Commission and to the World Aquatics Office:

- Judge’s evaluations for the past four (4) years.
- Judge’s activity both nationally and internationally, including on continent and off continent events.
- Reasons for not being able to attend the World Aquatics AS Certification School nor write and/or pass the exam.

The Judge would additionally have to commit to doing the following Fast Track Activities by November 1st of the following year:

- Attend a full Certification School.
- Pass the exam with a score of 85% or more.
- Obtain a minimum of two (2) evaluations of Very Good (5) or Good (4) rating with a Bias rating of three (3) from a current World Aquatics Evaluator.
- Have the nomination submitted by their Federation to the World Aquatics Office by November 1st of the following year.

The World Aquatics Judges with previous “A” status that have been removed from the World Aquatics Judges List must have activated the Fast Track within the first year of being demoted from the “A” category to the “G” category.

##### **5.4.5.2 World Aquatics G Judges**

World Aquatics “G” Judges who do not pass the Certification School exam by November 1st in the following year of their nomination will be removed from the World Aquatics Judges List (e.g., if a Judge applies on November 1, 2022, the exam must be written and passed by November 1, 2023).

The steps to be followed for the reinstatement in the “G” category are described in Section 5.4.4.2.

## **5.5 WORLD AQUATICS ARTISTIC SWIMMING – ONLINE EXAM FOR CERTIFIED JUDGES**

Each World Aquatics Judge (unless otherwise directed by the World Aquatics) must annually take the online World Aquatics Artistic Swimming – Exam for Certified Judges.

A minimum score of 85% for World Aquatics “A” Judges and 80% for “G” Judges will be required to earn a passing grade and to be eligible to judge at World Aquatics events.

### **5.5.1 Procedure for World Aquatics “A” and “G” Judges failing or missing the World Aquatics AS Online Exam**

If a candidate does not pass or does not write the annual World Aquatics Artistic Swimming Exam for Certified Judges within the one-month period, they will be listed on the World Aquatics AS Judges List but will not be eligible to officiate at World Aquatics events during the current season.

The Judge will need to write and pass the online World Aquatics Artistic Swimming Exam for Certified Judges the following year and will need to demonstrate a judging activity within their region (complete a minimum of 60 (sixty) hours).

## **6. TECHNICAL CONTROLLERS (DIFFICULTY & SYNCHRONIZATION)**

### **6.1 INTRODUCTION**

Please note that this section of the AS Manual will be reviewed on an ongoing basis as needed with the implementation of the new scoring system and may be subject to edits/changes. Every effort will be made to communicate and inform the World Aquatics Family of these changes.

Two (2) groups of three (3) Technical Controllers must officiate in routines: one (1) group to check the number, order of performance, and predeclared difficulty of Free Elements, and the performance and predeclared order of Technical Required Elements (technical routines), and one (1) group to register the number and type of synchronization errors observed. In addition, one (1) TC Coordinator will be appointed in a supporting role to guide and assist in the organization of the Technical Controllers selected for the competition. The TC Coordinator does not act as an official DTC or STC.

#### **6.1.1 Difficulty Technical Controllers**

There will be **one (1) Difficulty Technical Controller (DTC)** and **two (2) Difficulty Assistant Technical Controllers (DATC)**. The purpose of the role is to verify all Elements (Technical Required Elements (technical routines), Hybrids and Acrobatics) performed in real time as they occur in a routine. They are also responsible for the identification of any technical errors. Technical errors are differences in what is declared on the Coach Card to what is performed in the water OR an error in a Technical Required Element (technical routines). DTCs also verify that other general requirements have been completed in the routine as per the AS Rules. The DTC will have communication to the Referee.

DTCs are to follow all process and written requirements (general, technical, or skill) as per the AS Rules, Appendix II (Technical Routines), Appendix III (Set No. of Elements), Appendix IV (Acrobatic Routine), and Appendix V (Combo) of AS Rules, Introductory Guide for the Application of Declared Difficulty and Addendum (Appendix VI of AS Rules), and the Acrobatics Catalogue (Appendix VII of AS Rules) and Acrobatics Catalogue Quick Reference Sheets for Technical Controllers. If a requirement (general, technical, or skill) is not in writing in an official AS document noted above, then the decision should go in favour of the athlete.

#### **6.1.2 Synchronization Technical Controllers**

There will be three **(3) Synchronization Technical Controllers (STC)** who will record the number of synchronization errors (unequal actions) they observe during the performance of a routine. They will be seated on deck with a clear view of the pool. The STC panel is present only for Duet and Team routines.

##### **6.1.2.1 Synchronization**

Synchronization is the precision of movements in unison - to have actions happen at the same time or correspond exactly in design.

Lack of synchronization can be understood as **unequal action** or **accuracy error** when comparing two (2) or more athletes swimming at the same time. Unequal actions can be due to the timing and/or design errors of the movements that make the "picture" imprecise, inaccurate, and/or not perfect to what the choreography is intended to demonstrate.

Further, unequal action is any movement performed by two (2) or more athletes with a difference in timing or positioning (design/shape). Movements that are choreographed as intentional unequal movements shall not be penalized.

- Difference in timing includes:
  - Movements that are not performed in complete unison; or
  - Actions that do not happen at the exact same time
- Difference in positioning includes differences in:
  - Position of head, arms, legs, or other body parts used
  - Water level of head, arms, legs, or other body parts used
  - Spacing and pattern shape

If two (2) or more athletes show different positioning and it is unknown which athlete performed the intended/correct position and yet it is clear there was a difference, it is considered an unequal action.

Synchronization errors are defined in three categories – small, obvious, or major:

<b>Small Errors</b>	<p>Slight differences that cannot be considered as two (2) different movements but distort the image of perfect synchronization.</p> <p>Small synchronization errors include:</p> <p>Slight differences in timing</p> <p>All differences in positioning (design/shape) (also considered by Elements panel):</p> <p>Non-accurate movements in pattern alignment and spacing</p> <p>Differences in angles or height</p> <p>Non-parallel walkouts</p>
<b>Obvious Errors</b>	<p>Any unintentional difference in matching that produces the effect of two (2) movements being done one after the other.</p> <p>Obvious synchronization errors include clear difference in timing.</p>
<b>Major Errors</b>	<p>Any error that produces an alteration in routine content (missing one or more movements by one or more athletes).</p> <p>Major synchronization errors include missing movements, i.e., any alteration of the routine content by one (1) or more athletes (e.g., one quick backstroke that is missed by an athlete).</p> <p>All major errors must have video review overseen by the Referee since they result in the largest deduction.</p>

STCs are to follow all process and written requirements for recording synchronization errors (unequal actions) as detailed in the Introductory Guide for Scoring Synchronization available here [https://learning.fina.org/wp-content/uploads/2022/10/27\\_09\\_2022\\_Synchronisation\\_Intro\\_Guide\\_v2\\_Sept\\_2022.pdf](https://learning.fina.org/wp-content/uploads/2022/10/27_09_2022_Synchronisation_Intro_Guide_v2_Sept_2022.pdf).

## 6.2 ROLES AND RESPONSIBILITIES

### 6.2.1 DTC and DATC

The role of the Difficulty Technical Controller (DTC) and Difficulty Assistant Technical Controllers (DATC) are as follows:

- The DTC and DATCs shall receive the Coach Cards after the Coach Card submission deadline and prior to the event practice beginning. Upon receipt of Coach Cards, the DTC and DATCs are officially assuming their duties for the event and may not discuss Coach Cards with any athletes, Coaches, Judges, or Member Federation representatives.
- The DTC and DATCs shall hold an initial meeting at the event prior to practice observation to review the submitted Coach Cards for inclusion of requirements (such as Hybrid Connection, Acrobatics DD 2.0-2.65 for Tech Teams, etc.) OR any evident errors that can be flagged prior to the event (such as exceeding the set number of Elements, ineligible bonuses for that event, etc.).
- The DTC and DATCs may watch official event practice times to familiarize themselves with the event routines and Coach Card declarations. Notes may be taken. DTCs or DATCs may not give any Coach Card/Routine feedback to any athletes once the event has begun (inclusive of practice).
- The DTC and DATCs shall hold a meeting prior to each event to review the Difficulty Guide, rules, and their roles and to prepare in general for the specific event that they will be controlling. This includes discussing any notes they may have taken during practice that may better prepare them for the event.
- The DTC and DATCs shall be seated together on deck with a clear view of the pool. The DTC shall sit in the middle with the DATCs on either side of the DTC.
- The DTC will have communication with the Referee.
- The DTC/DATC panel will operate as follows with shared and divided tasks for controlling/checking required difficulty components as per the AS Rules:
  - **Technical Required Elements (TRES):** Technical routines only - verification that the athlete(s) did the TRES as declared and as defined in the rules
  - **Hybrids:**
    - **Declared movements:** (Family/Level) and any other requirements as per the rules.
    - **Bonuses:** Traveling, Placement, Synchronization and Pattern Changes (as applicable to each discipline/event).
  - **Acrobatics:** Declared composition as per catalogue
  - **Other requirements** as defined in the AS Rules (Appendix II, III, IV or V)

Event	DATC-1	DTC	DATC-2
<b>Women and Men Solo Tech</b>	<b>Family/Level + Bonuses</b> TRES Set No. of Elements	<b>Family/Level</b> TRES Set No. of Elements	<b>Bonuses</b> TRES Set No. of Elements
<b>Women and Men Solo Free</b>	<b>Family/Level + Bonuses</b> Set No. of Elements	<b>Family/Level</b> Set No. of Elements	<b>Bonuses</b> Set No. of Elements
<b>Women Duet Tech</b>	<b>Family/Level</b> TRES + Pair Acro Set No. of Elements App II – Gen Req. #6	<b>Family/Level</b> TRES + Pair Acro Set No. of Elements App II – Gen Req. #6	<b>Bonuses</b> TRES + Pair Acro Set No. of Elements App II – Gen Req. #6
<b>Mixed Duet Tech</b>	<b>Family/Level</b> Incl. Hybrid Connection TRES + Pair Acro Set No. of Elements App II – Gen Req. #6	<b>Family/Level</b> Incl. Hybrid Connection TRES + Pair Acro Set No. of Elements App II – Gen Req. #6	<b>Bonuses</b> Incl. Hybrid Connection TRES + Pair Acro Set No. of Elements App II – Gen Req. #6
<b>Women Duet Free</b>	<b>Family/Level</b> Pair Acro Set No. of Elements	<b>Family/Level</b> Pair Acro Set No. of Elements	<b>Bonuses</b> Pair Acro Set No. of Elements
<b>Mixed Duet Free</b>	<b>Family/Level</b> Incl. Hybrid Connection Pair Acro Two Connected Surface Movements completed Set No. of Elements	<b>Family/Level</b> Incl. Hybrid Connection Pair Acro Two Connected Surface Movements completed Set No. of Elements	<b>Bonuses</b> Incl. Hybrid Connection Pair Acro Two Connected Surface Movements completed Set No. of Elements
<b>Team Tech</b>	<b>Family/Level</b> TRES Incl. Cadence Action Acrobatics + DD 2.0-2.65 Set No. of Elements App II - Gen Req. #6 1 Circle max	<b>Family/Level</b> TRES Incl. Cadence Action Acrobatics + DD 2.0-2.65 Set No. of Elements App II - Gen Req. #6 1 Circle max	<b>Bonuses</b> TRES Incl. Cadence Action Acrobatics + DD 2.0-2.65 Set No. of Elements App II - Gen Req. #6 1 Circle max
<b>Team Free (Junior &amp; Senior)</b>	<b>Family/Level</b> Acrobatics Set No. of Elements	<b>Family/Level</b> Acrobatics Set No. of Elements	<b>Bonuses</b> Acrobatics Set No. of Elements
<b>Team Free (Youth)</b>	<b>Family/Level</b> Incl. 1 Thrust & Spin 720° Acrobatics + max DD Set No. of Elements	<b>Family/Level</b> Incl. 1 Thrust & Spin 720° Acrobatics + max DD Set No. of Elements	<b>Bonuses</b> Acrobatics + max DD Set No. of Elements
<b>Team Free (12U)</b>	<b>Family/Level</b> Acrobatics + max DD Set No. of Elements	<b>Family/Level</b> Acrobatics + max DD Set No. of Elements	<b>Bonuses</b> Acrobatics + max DD Set No. of Elements
<b>Acrobatic Routine (Junior &amp; Senior)</b>	Acrobatics Set No. of Elements	Acrobatics Set No. of Elements	Acrobatics Set No. of Elements
<b>Free Combo (Youth/12U)</b>	<b>Family/Level</b> Acrobatics + max DD Set No. of Elements Theme declared App V - Req Elem. #1	<b>Family/Level</b> Acrobatics + max DD Set No. of Elements Theme declared App V - Req Elem. #1	<b>Bonuses</b> Acrobatics + max DD Set No. of Elements Theme declared App V - Req Elem. #1



- Each DTC and DATCs then watches the routine and confirm or denies if the declared difficulty has been performed as declared on the Coach Card and if any other requirements as per the rules have been completed or are incomplete. This is done electronically (selecting “Confirm” or “Base Mark” in the scoring system) or via pencil and paper method depending on the scoring system in place for the competition. The DTC and DATC may also select “Review” if they need to re-watch an Element or requirement to validate their decision to “Confirm” or “Base Mark”.
- If the DTC or a DATC selects “Base Mark” or “Review” then the entire DTC panel must review the Element/requirement and decide together. If a unanimous decision cannot be reached by the DTCs after reviewing three times (3x), the ruling will go in favor of the athlete.
- The DTC or DATC may use video replay (max three times (3x) at normal speed with no zooming) to confirm a decision on an Element or requirement. Note that the video review is for the entire Element. TCs may not watch individual Element components more than three times (3x) each. TCs shall not touch the video device.
- Action when declared difficulty is denied is as per the AS rules:
  - Base Mark for Hybrids and Acrobatics,
  - Zero (0) for Technical Required Elements, and
  - Applicable penalties (as per the AS rules) for missing requirements or violations of requirements.
- As per Rule AS **14.2**, the performance ends with music accompaniment. Therefore, if a declared difficulty component is not completed by the time the music ends, DTCs will apply the Base Mark to that Element because the declared difficulty is incomplete by the end of the routine. For example, if an R4 (spin descending 1080°-1440°) is declared and the athlete has only completed 720° when the music ended, the athlete shall receive the Base Mark for this Element. If the athlete completes their declared difficulty in full by the time the music ends, it is not a Base Mark.  
 If an Element starts after the music ends - this shall be a zero, as the Element is not completed by the time the routine ends and is therefore not part of the routine.
- In case that an DTC/DATC is absent due to illness or other unforeseen circumstances, a substitute/reserve DTC/DATC may be put in place that is available at the event (for example a Judge that is not on a panel and is also a TC). The DTC panel should always operate with three (3) DTCs.

**Review of Declared Difficulty:**

1. Technical Required Elements, Hybrids, Acrobatics, or other requirements are reviewed in the order they were performed.
2. The DTC first states what Element/requirement is being reviewed, the level (if applicable), and asks the DATC who called the review for the reason.

3. During the routine - if the DTC or an DATC sees a reason to review an Element or requirement they select "Review" on the scoring program screen or they may say "Review" as they flag the Element/requirement on the Coach Card if there is no technology involved.
4. The DTC guides all discussions in any review including final decision based on the vote among the three members. If a unanimous decision cannot be reached by the TCs after reviewing three (3) times, the ruling will go in favour of the athlete.
5. How the DTC is to handle the decisions on deductions: DTC confirms all deductions (TC obligation) based on discussion and decision of the panel of DTCs.
6. Unless there is a numerical/calculation error, NO changes can be made once the results have been announced for each routine.
7. Prior to the announcement of the score, the DTC and DATCs may continue to review and confirm or deny Elements/requirements. The DTC must ask the DATCs if they have any other items to discuss PRIOR to authorizing what was submitted on the Coach Card/ observed in the routine.
8. If it was already authorized and the scores have not been announced, alert the Referee immediately to stop the announcement of the score so an error can be corrected.
9. It is NOT possible to change Elements (Technical Required Elements, Hybrids, or Acrobatics) once the score has been announced.
10. Any feedback requested by a Coach/athlete can be provided after the competition.
11. Refer to AS Rule **18.10** for Technical Controller (DTC/DATC/STC) Review Request.
12. The Scorer inputs the codes/levels of difficulty of the Technical Required Elements, Hybrids and Acrobatics into the computer system.

### **6.2.2 STCs**

- The STCs may watch official event practice times to familiarize themselves with the event routines. STCs may not give synchronization feedback to any competing athlete(s) once the event has begun (inclusive of practice).
- The STCs shall hold a meeting prior to Duet and Team events to review the Synchronization Guide, rules, and their roles and to prepare in general for the specific event that they will be controlling.
- The STCs may be seated together or in different seating locations on deck with a clear view of the pool. The STC seating locations will be communicated by the event Referee.
- The STCs will use the synchronization operating system for the event as specified by the scoring system in use and as directed by the Referee. Process as per the Introductory Guide for Scoring Synchronization (Synchronization Device, Synchronization App or Pencil and Paper method/using tally counters and synchro error sheet/chits).
- Synchronization errors entered by STCs are validated as follows:

- **Electronic method**

- At least two (2) STCs must coincide in time to validate an observed synchronization error (unequal action)
- A maximum delay of 0.5 seconds between observations by two (2) STCs will be allowed to validate the observed unequal action
- In case a different type of synchronization error is observed by two (2) STCs, the less punitive error is validated (e.g., when small and obvious error is observed, small error is validated)

- **Pencil and paper method**

- Number and type of the synchronization error is calculated as average number of errors observed by STCs per type and lap
- STCs shall submit their synchronization errors (small, obvious, and major) for each athlete to the scorer/data input operator.
- In the case that a major error has been identified – a video review overseen by the Referee will take place as they result in the largest deduction.
- STCs do not take notes and should not discuss results with Coaches or competing athletes after the event has concluded.
- In the case that an STC is absent due to illness or other unforeseen circumstances, a substitute/reserve STC may be put in place that is available at the event (for example a Judge who is not on a panel and is also a TC). In the case that a substitute can't be found the STC panel may operate with two (2) STCs.

**Review of Major Synchronization Errors:**

1. If a STC logs a major error, video review by the entire STC panel will take place and will be overseen by the Referee.
2. In the case where the synchro device is in place the Referee will automatically see that a major error has taken place and will initiate the video review.
3. In the case where technology is not in place (pencil and paper method), the STC should communicate to the Referee that they have logged a major error.
4. The Referee then oversees the review of the major error(s) with the STC panel by video review.
5. The video may only be reviewed a maximum of three (3) times at normal speed (for each part with the major error(s) identified).
6. If a unanimous decision cannot be reached by the STCs after reviewing three (3) times, the ruling will go in favor of the athlete.
7. At the conclusion of the review the Referee will communicate the final decision of the STC panel regarding major errors to the Scorer.

### 6.2.3 TC Coordinator

TC Coordinator is a supporting role that will be appointed to guide and assist in the organization of TCs selected for a competition. TC Coordinator does not act as an official DTC or STC and does not make any decisions in the competition. They are selected by World Aquatics from the World Aquatics TCs or World Aquatics TC Instructors based on their ethics, leadership and communication skills, system and rules knowledge, and experience with working in the new system.

The roles and responsibilities of the TC Coordinator are as follows:

1. Be a liaison to the TC panels for the World Aquatics TASC Chair and Staff and the Referee.
2. Organize up to date World Aquatics approved TC resources that the TCs may need in case they do not bring them to the competition (Difficulty Guide and Tables, Resource sheets, etc.).
3. Answer questions for the TCs to ensure they are making decisions based on materials in writing and that they are abiding by the role of the TC (is declaration correct) and not making decisions based on the Judge's role (execution).
4. Have all TC rules and resources on hand for reference during the entire competition (for meetings and on panel), as needed, for the TCs to ensure rules in writing are being abided by.
5. Ensure the TC panel has a room to themselves with a big table to organize materials, and that they have been provided the resources they need to organize Coach Cards (clip boards, pencils, paper clips, stapler, etc.)
6. Support World Aquatics TASC Chair and Staff in TC meetings, as requested, and reinforce their messages. Report any unethical behavior to the TASC Chair and Staff. TCs should be abiding by their role as described in this Manual.
7. Advise the TCs, as needed, on World Aquatics approved clarifications and of any newly approved Acrobatics from World Aquatics that may be appearing in the competition.
8. Assist the World Aquatics TASC Chair and Staff, as requested, in any tasks including communication of TC panels (DTC and STC).
9. Along with the World Aquatics TASC Chair and Staff, meet with the TC panel one (1) hour before the start of each official practice sessions.
10. Ensure the TC panel is provided with Coach Cards for watching practice (organized by Federation), and that they have clipboards or binders to organize them in.
11. Ensure that the TC panel has an official location on deck that is blocked off for watching practice and that they are undisturbed by Coaches (or other delegation members).
12. Watch practice with the TC panel.

13. On competition days, meet with the TC panel one (1) hour before training with music starts to organize Coach Cards by start order and to transfer any practice notes over to Coach Cards. Watch training with music together with the TCs.
14. Ensure all practice Coach Cards are collected and destroyed.
15. During the competition sit with DTC panel (at the end of the panel closest to the Referee – Video operator sits at the other end).
16. When a routine is completed, inform the Referee if any video reviews are required and how many.
17. Observe and supervise video reviews to ensure that there is a maximum of three (3) video reviews at regular speed per the entire ELEMENT (reviewing the Element component by component is not permitted), with no zooming, and confirm the TCs' unanimous decision (Pass or Fail) ensuring that if all three (3) TC do not agree, the ruling is in favour of the athlete. The video operator should be the only one to operate the video device – TCs may not touch the video device.
18. Inform the Referee/Swiss Timing that video reviews, if required, are complete and confirm that the correct outcome of the video review is entered into the system (as they have seen on screen).
19. Fill out the Technical Controller Base Mark & Penalty Detail Form for the DTC panel as decisions are made.
20. At the conclusion of the event, have DTCs sign all their Coach Cards, collect all Coach Cards from DTCs and give to the Referee along with the TC Base Mark & Penalty Detail Form, which must also be signed by the DTC Panel.

### **6.3 THE APPOINTMENT OF TECHNICAL CONTROLLERS**

The appointment of the Technical Controllers shall be managed in the following manner:

- World Aquatics will offer training clinics for selected candidates
- World Aquatics will be responsible for training during the clinic and assessing the performance of candidates in the clinic. It is recommended that the total number of participants at each clinic shall not exceed 15 (fifteen) to 20 (twenty) trainees
- Candidates will be trained as Synchronization and Difficulty Technical Controllers
- Candidates will be required to write a certification exam
- Technical Controllers will be selected by World Aquatics

#### **6.3.1 Requirements to apply as a World Aquatics Technical Controller:**

The requirements for TC applicants are as follows:

- Artistic Swimming background
- Open to athletes, Coaches, or Judges
- The maximum age for a Technical Controller to be included on the World Aquatics Technical Controllers List is sixty-five (65) years of age
- Retired elite athletes, Coaches, World Aquatics Judges and World Aquatics Evaluators are eligible to apply

- Must have at least a minimum of 24 (twenty-four) months of international experience.
- Availability for training and competitions
- Be comfortable with technology and using cloud platforms
- Ability to communicate in English
- Strong ethics
- Not be a Relative of a Competitor
- Not be a current Coach of a Competitor or Relative of a current Coach of a Competitor
- Not be a Team Manager or relative of a Team Manager at the Competition
- Not be an inhabitant of the same household of the competitor or any of a relative, a Coach or team manager of a competitor
- Preferably, not be someone who receives money from any Member Federation that has athletes competing in the competition. This conflict will be considered on a case-by-case basis
- Not be allowed when the TC is currently or has in the past twelve months been the regular Coach/choreographer of the competitor/candidate
- Not be allowed when the livelihood of the TC is dependent on, or is perceived to be dependent on the outcome
- "Relative" refers to a person connected with another by blood or marriage (including partner). Relative also includes step relationships and is any of parent, child, sibling, uncle, aunt, nephew, niece, first cousin, grandparent, or spouse. "Coach" refers to any person who coaches figures and/or routines on a regular basis to the competitor. All Technical Controllers will be asked to declare their conflicts with their World Aquatics Applications.

### **6.3.2 Announcement of Appointments**

Appointments of World Aquatic Technical Controllers shall become effective on the date determined by World Aquatics. All World Aquatics TCs are appointed by World Aquatics.

## **7. ETHICS IN ARTISTIC SWIMMING**

Ethics: *"The philosophy of morals "*

*"The rules or standards governing the conduct of the members of a profession "*

*"To feel and act accordingly "*

Artistic Swimming depends on human beings to decide fairly on scores and placings.

The most significant factors in Artistic Swimming judging are Respect, Responsibility, and Integrity:

- Being fair, honest, and impartial in all dealings and decisions concerning the participants in Artistic Swimming, particularly the athletes.
- Being knowledgeable about World Aquatics Rules and applying them fairly.
- Awareness of external pressures, from Club, Country, Member Federation, NOC, and being resistant to these influencing scores.

- Awareness of all possible Bias factors (positive, negative, country, continental, and personal) and knowing how to deal with them ethically.
- Avoiding discussion of athlete performances until the competition is completed.
- Willing to provide constructive feedback to Coaches.
- Exchanging gifts only after the completion of the competition.
- Conforming to acceptable dress codes.
- Being aware and declaring your own conflicts of interest.

As well as with judging, there are other ethical considerations within Artistic Swimming:

- The basics of human lifestyle, and the building of a respect and fairness.
- The review and the evaluation of norms and values.
- What is right, what is questionable and what is not allowed.
- What affects our decisions, and the freedom in making decisions.

### **Cohort judging or cheating**

Cohort judging or cheating of any type will not be tolerated in Artistic Swimming. Any Judge identified in this activity will be removed from further sessions of judging at that competition. A meeting will be held with the World Aquatics Evaluator and a World Aquatics Delegate to determine an action plan for the compromised Judge. When selecting Judges for World Aquatics Championships or Olympic Games, priority will be given to World Aquatics Judges who have demonstrated outstanding ethical practices, including evaluations for Bias.

### **Discrimination**

Persons subject to this Code of Ethics shall not discriminate in any kind against anyone based on reasons such as race, colour, sex, language, religion, political or other opinion, national or social origin, property, birth or other status, or athletic ability.

### **Harassment and Abuse**

Persons subject to this Code of Ethics shall refrain from all forms of harassment and abuse, be it sexual, physical, or psychological, whether occurring in isolation or in combination or whether consisting of a one-off incident or a series of incidents, whether done in person or online, (including but not limited to social media) and in particular from any abuse of authority, i.e., the improper use of a position of influence, power, or authority over another person. Abuse can also take the form of neglect.

### **Ethical Considerations for other groups:**

#### **Coaches:**

- Respect fellow athletes psychologically and physically
- Accept and comply with World Aquatics Rules (including Doping) and Training Schedules.
- Respect creativity
- Respect and cooperate with the Organizing Committees
- Respect and cooperate with the Referee(s)
- Respect Judges' and TC marks and decisions

- Respect the results

**Referees:**

- Enforce the Rules fairly and equitably
- Respect and comply with World Aquatics By-Laws

**Evaluators:**

- Respect and comply with the World Aquatics Policy and Procedures for Evaluators

**Team Managers:**

- Fairness first / share the pool
- Respect and cooperate with the Referee
- Respect and cooperate with the Organizing Committee
- Accept and comply with World Aquatics Rules (including Doping) and Training Schedules

**Technical Controller and Assistant Technical Controller:**

- Respect and comply with World Aquatics Policy and Procedures for Technical Controllers
- Enforce the World Aquatics Rules fairly and equitably



## CHAPTER II. - FIGURES

## 8. GENERAL CONCEPTS OF JUDGING FIGURES

A Figure is a combination of basic body positions and transitions, performed in a manner and order as prescribed by the World Aquatics Handbook rule descriptions.

General concepts on Figures:

1. Figures are defined in terms of their component parts: body positions and transitions.
2. A transition is a continuous movement from one position to another. The completion of a transition should occur simultaneously with the achievement of a body position and desired height. Except where otherwise specified, water level remains constant during a transition.
3. Unless otherwise specified in the figure description, maximum height is always desirable. Height is evaluated based on the water level of body parts.
4. Unless otherwise specified in the figure description, figures are executed in a stationary position. Transitions which allow some movement will be marked with an arrow in the diagram.
5. Diagrams are a guide only. If there is discrepancy between a diagram and a written description, the English written version of the World Aquatics Handbook shall prevail.
6. During the execution of a figure, a pause may occur only in basic body positions which are printed in "**bold type**" and defined in Appendix I of the World Aquatics Handbook.
7. Basic movements are described, in Appendix I of the World Aquatics Handbook and are "*italicized*" when referred to in a figure description.
8. When "and" is used to connect two (2) actions, it means one follows the other; when "as" is used, it means both actions occur simultaneously.
9. When "rapid" or "rapidly" is used in the description, it shall apply specifically to the tempo of the transition in which it is included, and not to the entire figure.
10. Arm/hand positions and actions are optional.

## 9. GUIDELINES FOR JUDGING FIGURES

Unless otherwise specified in the description, Figures shall be executed high and controlled, in uniform motion, with each section clearly defined.

All judgements are made from the standpoint of perfection.

An athlete can obtain points from 0 – 10 using 1/10th points.

Perfect	10	Satisfactory	5.9-5.0
Near Perfect	9.9-9.5	Deficient	4.9-4.0
Excellent	9.4-9.0	Weak	3.9-3.0
Very good	8.9-8.0	Very weak	2.9-2.0
Good	7.9-7.0	Hardly recognizable	1.9-0.1
Competent	6.9-6.0	Completely failed	0

To be able to judge correctly a Judge must have in mind the design and control factors further described below.

## 9.1 DESIGN

That portion of the Figure award attributed to the evaluation of the degree of conformation to the positions and movements specified in the figure description.

As part of the design, Judges consider the accuracy of positions and transitions as specified in the figure description.

**Specific design factors** include accuracy of all body positions and transitions according to the description:

### 1. Accuracy of the lines, angles, and arches

Examples:

- A **Ballet Leg** position is perpendicular to the surface
- A **Fishtail** position has the foot of the extended leg at the surface

### 2. Accuracy of alignment of body parts

Examples:

- In **Vertical Positions**, alignment of ears, shoulder joints, hip joints and ankles
- In a **Split Position**, vertical alignment of head, shoulder, and hip joints; and horizontal alignment of hip and shoulder joints with the two (2) horizontal lines 'square' and parallel to one another.

### 3. Correctness of pikes and tucks

Examples:

- 90° angle in **Front Pike** position
- **Back Pike** position 45° angle or less, with legs and trunk extended
- **Tuck** positions as compact as possible

### 4. Accuracy of transitional movement

Examples:

- In *assuming a Front Pike Position*, the hips replace the head at the surface
- In *Arch to Back Layout Position* and *Walkouts*, head replaces hips at the surface
- In a *Combined Spin*, the *ascending* and *descending spins* must have the same number of revolutions
- In a *Thrust*, a vertical upward movement of the legs and hips is **rapidly** executed **as** the body unrolls
- In *Spins* there is simultaneous rotation and completion of the required spin

## 9.2 CONTROL

That portion of the figure award attributed to the evaluation of how well a performance achieves control factors. The control factor is the use of strength and coordination to demonstrate mastery of figure execution.

Control factors, which are further explained below, include extension, height, stability, clarity, uniform motion, unless otherwise specified in the Figure description.

Control in Figures is the ability to:

- Maintain high stable correct positions
- Move the body smoothly, accurately, and effortlessly through the required transitions
- Remain 'on-the-spot' unless otherwise specified in the description
- Give an overall impression of ease of performance

**Specific control factors include:**

1. **Extension**

Extension of total body throughout the figure, unless otherwise specified.

2. **Sustained maximum height**

Sustained maximum height of body parts in relation to the water surface, unless otherwise specified in the figure description.

3. **Uniform motion**

Uniform motion means a constant speed of action throughout the figure, unless otherwise specified in the figure description.

There shall be constant speed of action through each transitional movement. Transitions are to be executed without any pauses or stops therein. This does not mean that every transition takes the same amount of time, as it depends on the range of movement required. For example: the time to achieve a Split Position from a Front Pike Position takes longer than the time to assume a Front Pike Position from a Front Layout Position because there is a larger range of movement required.

Judging emphasis is placed on controlled uniformity of performance speed, not slowness.

When the rule requires a tempo change during one or more parts of a Figure, the change(s) must conform to the tempo(s) specified.

When the rule states 'rapid' or uses 'rapidly' to describe an action or movement in the figure, it should be obviously visible that there is more speed within this action or movement.

4. **Stationary**

Figures are performed 'on-the-spot', with no travelling, except for movement specified in a figure description.

5. **Stability**

Equilibrium must be maintained and unaffected by change of position.

6. **Clarity**

There must be a clear definition between positions and directions, continuous course of action in the transitions.

Transitions proceed through the most direct and accurate course of action. When the transition is finished, there should be a slight pause - as a 'comma', not a 'period' - to define the position and completion of the transition before the next transition begins.

7. **Ease of performance - overall impression**

Appearance of total confidence and effortless, fluid execution without evidence of strain.

**9.3 BASIC PRINCIPLES OF JUDGING FIGURES**

1. Plumb line points of reference are used when evaluating vertical and horizontal alignments.
2. The head always follows the alignment of the spine.
3. When initiating a transition, the athlete never begins by reversing the specified direction of movement.
4. Unless otherwise specified by the figure description, all movements are executed to be equal in time and space, with simultaneous and concurrent action within transitions. All movements specified within a transition should begin from the specified starting position and be completed with the achievement of the specified final position and level.
5. Axis - a straight line around which the body rotates.
6. Longitudinal axis - the lengthwise center of the body.
7. Lateral axis - extending sideways from the body, either through a cross section (such as the hips), or outside the body.
8. During a specific figure movement, the use of the term horizontal or vertical axis specifies the relationship of the longitudinal axis to the surface of the water.
9. Height is evaluated based on the water level of body parts.

## **9.4 DEDUCTIONS GUIDELINES FOR FIGURES**

### **9.4.1 Directions for the use of deductions guidelines**

Deduction guidelines are meant to be a good companion for Judges and facilitate discussions to unify judging criteria.

Judges are not calculators and are not expected to memorize the list of deviations in Section 3.2.2 Design Guidelines for Figures below. The information is to be used as a tool in assisting the Judges finalizing their score

Athletes are not machines as well and may show a large variety and combinations of inaccuracies or deviations during the performance of figures.

There are many aspects to consider in a Figure, even in the short ones, and the Judge has very little time to summarize all and complete the judging process by giving a mark. It would be great to review the Figure multiple times: once for extension, once for stability, once for design, etc., but this is not possible in competition, only during seminars or practice sessions for continuous learning.

### **9.4.2 Design deductions**

Design deductions are applied for transitions/positions being different from the description by a certain degree (see visible scale of angle deviation) or altering the movement/position concept (see deduction guidelines for figures in Youth and 12& under categories).

When there are inaccuracies, deductions are as follows:

<b>Small</b>	<b>0.2 points</b>
<b>Medium</b>	<b>0.5 points</b>
<b>Large</b>	<b>1 point</b>

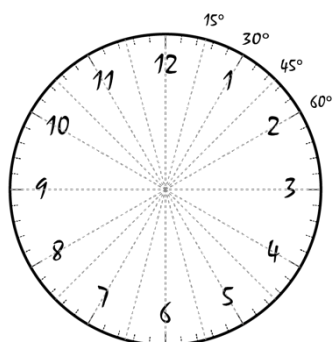
**9.4.2.1 Visible scales of angle deviation**

Apply to plumb line points of reference when evaluating vertical and horizontal alignments required

- Small Deviation**      **1° – 15° (0.2)**
- Medium Deviation**    **16° – 30° (0.5)**
- Large Deviation**      **31° or more (1.0)**

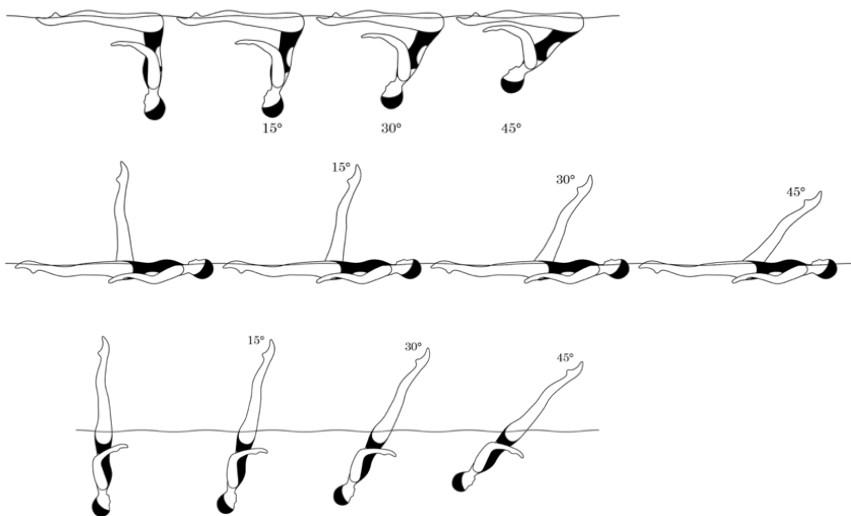

Deviation allowances for the *Thrust* action are unique and allow for the legs to be up to an additional 15° off the vertical line.

- Small Deviation**      **16° – 30° (0.2)**
- Medium Deviation**    **31° – 45° (0.5)**
- Large Deviation**      **more than 45° (1.0)**

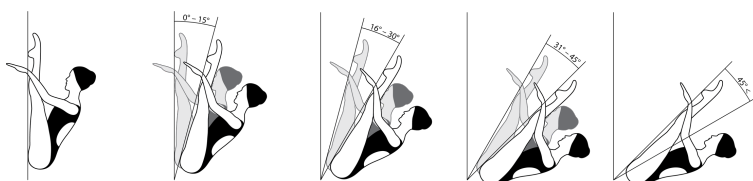

### 9.4.2.2 Design deduction guidelines for World Aquatics 2022-2025 Youth Figures

In addition to the deductions for angle deviations, there are other design problems that require deductions. The following table provides **some examples** of common errors that require deduction.

<b>Deviation Type</b>	<b>Small Deviation</b>	<b>Medium Deviation</b>	<b>Large Deviation</b>
<b>Deduction</b>	<b>0.2</b>	<b>0.5</b>	<b>1.0</b>
<b>Angle deviation</b>	<b>1°-15°</b>	<b>16°- 30°</b>	<b>31° or more</b>

#### Flamingo Bent Knee Twist Spin

<i>Continuous spin 720°</i>	Accelerates and achieves speed after initiating rotation	Slow rotation	Very slow rotation
	Uneven rotation and drop but finishing at correct height	Dropping more than ½ way from height by the end of the 1 <sup>st</sup> rotation	Dropping to ankles by end of 1 <sup>st</sup> rotation and rotating at ankles
	Rotation is less or more than the required amount by <b>90°</b>	Rotation is <b>more than 90° and less than 180°</b> off the required rotation.	Rotation is at the maximum allowance of <b>up to 180°</b> off the required rotation.

#### Cyclone Open 180°

<i>Twirl from Bent Knee Surface Arch Position to Vertical Position</i>		Slow <i>Twirl</i> , not changed speed obviously	Very slow <i>Twirl</i> (twisting not twirling).
<i>180° open rotation from Vertical Position to Split Position</i>	Uneven open between right and left legs		
<i>Split Position</i>	*See chart for splits		



<b>Deviation Type</b>	<b>Small Deviation</b>	<b>Medium Deviation</b>	<b>Large Deviation</b>
<b>Deduction</b>	<b>0.2</b>	<b>0.5</b>	<b>1.0</b>
<b>Angle deviation</b>	<b>1°-15°</b>	<b>16°- 30°</b>	<b>31° or more</b>

**Barracuda Airborne Split Spin up 180°**

<i>Back Layout Position to Back Pike Position</i>	Head tucked in Submerged Back Pike position	Back rounded in Submerged Back Pike position	
	Toes out of the water before the <i>Thrust</i> commences	Toes 15 – 20 cm below surface before rise	
<i>Thrust</i>	Legs 15° to 30° from perpendicular	Legs 31° to 45° from perpendicular	Legs 46° or more from perpendicular
		Body rising in pike, so crown of head is at the surface before the unroll commences	Body rising in pike, so part of the face is dry before the unroll commences
			A hinging, not an unrolling movement. Flat back during the transition
<i>Vertical Position to Split Position</i>		Not achieving the vertical prior to the Split	Starting the Split as the feet leave the water
<i>Spin up 180°</i>		Erratic rises during spin	Obvious push up at the end of <i>Spin Up</i>

**Swordfish Straight Leg Ariana Rotation**

<i>Front Layout Position to Split position</i>	Straight body until lifted leg reaches 30° from vertical	Straight body until lifted leg reaches 45° from vertical	Piking hips to start leg lift
<i>Ariana Rotation</i>			Piked hips in front Split

<b>Deviation Type</b>	<b>Small Deviation</b>	<b>Medium Deviation</b>	<b>Large Deviation</b>
<b>Deduction</b>	<b>0.2</b>	<b>0.5</b>	<b>1.0</b>
<b>Angle deviation</b>	<b>1°-15°</b>	<b>16°- 30°</b>	<b>31° or more</b>

**Whip Continuous Spin 720°**

<i>One leg is lowered rapidly to a <b>Fishtail Position</b> and without a pause is lifted rapidly to a <b>Vertical Position</b></i>		Pausing in fishtail position	Fishtail position not achieved, lifting initiated before
<i>Continuous Spin 720°</i>	See Flamingo Bent Knee Twist Spin	See Flamingo Bent Knee Twist Spin	See Flamingo Bent Knee Twist Spin

**Saturn**

<i>Twirl from Fishtail Position to Vertical Position</i>		Slow, not obvious speed change	Very slow (twisting)
--	--	--------------------------------	----------------------

**Venus**

<i>Rotation in Fishtail Position</i>	Foot of horizontal leg just off the water		Water level mid-calf on horizontal leg (foot) clear of the water
<i>Spinning 360°</i>	Rotation around lateral axis. Rotating slightly less or more than 360°	Rotating clearly less or more than 360° but less than 450° or more than 270° Erratic drops during <i>Spin</i>	Rotating at limit of spin allowance: minimum 270°, maximum 450°

**Albatross Spin Up 360°**

<i>Back Layout Position to Front Pike Position</i>		Arch to nearly a Surface Arch Position before starting the rotation	Rotating from the surface
<i>Front Pike Position to Bent Knee Vertical Position</i>		Starting to bend the leg so the toe of the bending leg is at the ankle of the extended leg before lift commences	Starting to bend the leg so the toe of the bending leg is higher than the ankle of the extended leg before lift commences
<i>Spin Up 360° from Bent Knee Vertical Position to Vertical Position</i>	Rotation around lateral axis. Rotating slightly less or more than 360°	Rotating clearly less or more than 360° but less than 450° or more than 270°	Rotating at limit of spin allowance: minimum 270°, maximum 450°
		Erratic rises during spin	Obvious push up at the end of the <i>Spin Up</i>



<b>Deviation Type</b>	<b>Small Deviation</b>	<b>Medium Deviation</b>	<b>Large Deviation</b>
<b>Deduction</b>	<b>0.2</b>	<b>0.5</b>	<b>1.0</b>
<b>Angle deviation</b>	<b>1°-15°</b>	<b>16°- 30°</b>	<b>31° or more</b>

**Walkover Back Closing 360°**

<i>Back Layout to Surface Arch</i>	Feet and legs travel 30 cm (12 in) or less along surface	Surface Arch Position not shown	At start, head and shoulders press backward to Surface Arch Position
<i>Surface Arch to Split</i>			Lifting at knee height and then rising in knight position
		Erratic speed and height	Leg lifting very quickly and then much slower from knight to split or vice versa
		Body pauses in Knight Position	Body stops in Knight Position
<i>Split to Vertical, closing 360°</i>	Uneven closing between right and left legs		No closing action during the first 180° rotation
	Legs are open 15° when the rotation is completed and then close	Legs are open 30° o when the rotation is completed and then close	Legs are open 45° or more when the rotation is completed and then close

**Ipanema Spinning 180°**

<i>Front pike, rapid 180° rotation to vertical</i>	180° rotation starts when feet are off the water	180° rotation starts when legs are almost ½ way up to vertical	Legs lifting to almost vertical before the 180° rotation starts
			Very slow rotation
<i>Spinning 180° (rapid)</i>	Rotation is slightly less or more than the required amount of rotation Slow at the beginning	Rotation is more or less than 180° by 15° but not at allowance limit of 45° Slow rotation	Rotation is at the maximum allowance of up to 45° off the required rotation Very slow rotation

<b>Deviation Type</b>	<b>Small Deviation</b>	<b>Medium Deviation</b>	<b>Large Deviation</b>
<b>Deduction</b>	<b>0.2</b>	<b>0.5</b>	<b>1.0</b>
<b>Angle deviation</b>	<b>1°-15°</b>	<b>16°- 30°</b>	<b>31° or more</b>

**Kip Combined Spin (360° +360°)**

<i>Inverted Back Tuck Position to Vertical Position</i>	Tuck could be tighter	Head out of line	Knees off chest, head not tucked in
	Body unrolls and legs extend upward simultaneously but vertical attained is slightly in front of or behind midway point described	Unroll is not simultaneously achieved. Legs move to vertical and then back unrolls under legs	Head and back move to vertical and then the legs open at hips (thighs parallel to surface of water and legs straighten to Vertical Position)
			Head leads shoulders backward to open tuck
<i>Combined Spin</i>	Holding the Vertical Position too long at the ankles before starting the ascent	Starting the rotation at constant ankle height before the rise commences-	
		Erratic drops/rises during spins	Obvious push up at the end of the ascending spin

**Rio Straight Leg**

<i>Back Layout Position to Ballet Leg position</i>	Hips drop up to 7.5 cm (3 in) as Ballet Leg is lifted	Hips drop 10 -30 cm (4 – 12 in) to inches as Ballet Leg is lifted	Hips drop more than 32.5 cm (13 in) or more as Ballet Leg is lifted
		Shoulders rounded; head is forward	Body sitting in water more than 30 cm (12 in), head off the water
<i>Ballet Leg Double Position to Submerged Back Pike Position</i>	Head tucked in Submerged Back Pike Position	Back rounded in Submerged Back Pike position	
<i>Thrust</i>	See Barracuda Airborne Split Spin up 180 °	See Barracuda Airborne Split Spin up 180°	See Barracuda Airborne Split Spin up 180°
<i>Spinning 360° (rapid)</i>	Rotation is slightly less or more than the required amount of rotation	Rotation is more than 270° and less than 450°, but not at allowance limit.	Rotation is at limit of allowed, minimum 270°, maximum 450°
	Slow at the beginning	Slow rotation	Very slow rotation

**9.4.2.3 Deduction guidelines for 2022-2025 age group 12 and Under Figures.**

<b>Deviation Type</b>	<b>Small Deviation</b>	<b>Medium Deviation</b>	<b>Large Deviation</b>
<b>Deduction</b>	<b>0.2</b>	<b>0.5</b>	<b>1.0</b>
<b>Angle deviation</b>	<b>1°- 15°</b>	<b>16°- 30°</b>	<b>31° or more</b>

**Straight Ballet Leg**

<i>Back Layout Position to Ballet Leg position</i>	Body travels forward or headfirst up to 15 cm (6 in) as leg is lifted	Body travels forward or headfirst more than 15 cm (6 in) as leg is lifted	
	Hips drop up to 7.5 cm (3 in) as BL is lifted	Hips drop 10 -30 cm (4 - 12 in) to inches as BL is lifted	Hips drop more than 32.5 cm (13 in) or more as BL is lifted
		Shoulders rounded; head is forward	Body sitting in water more than 30 cm (12 in), head off the water
<i>Ballet Leg Position to Bent Knee Back Layout Position</i>	Hips near surface		Hips deep, shoulders rounded, head off surface

**Barracuda**

<i>Back Layout to submerged Back Pike Position</i>	Legs lifted to mid-thigh level	Below knees is only part of legs lifted	Buttocks move forward as legs drop below surface without any lift
	Toes 7-12cm (3-5 in) below surface before rise	Toes 15-30 cm (6-12 in) below surface before rise	Toes more than 30 cm (12 in) below surface before rise
<i>Thrust</i>		Body rising in pike so head crown is at the surface before unrolling commences	Body rising in pike, so part of the face is dry before unrolling commences
			A hinging, not an unrolling movement
		Thrust is faster than layout to Back Pike Position but not rapid	<i>Thrust</i> is slow

**Front Ariana**

<i>Front Pike Position to Split Position</i>	*See chart for <b>Splits</b> (Section 9.5.2)		
<i>Ariana Rotation</i>	*See chart for <b>Splits</b> (Section 9.5.2)		
			Piked hips in front <b>Split</b>

<b>Deviation Type</b>	<b>Small Deviation</b>	<b>Medium Deviation</b>	<b>Large Deviation</b>
<b>Deduction</b>	<b>0.2</b>	<b>0.5</b>	<b>1.0</b>
<b>Angle deviation</b>	<b>1° - 15°</b>	<b>16° - 30°</b>	<b>31° or more</b>

**Tower**

See angles visual chart

**Water Drop Half Twist**

<i>Front Layout Position to Front Pike Position</i>	Hips do not replace position of head, moving forward up to 14 cm (5 1/2in)	Hips do not replace position of head, moving forward 15-30 cm (6-12 in)	No forward movement body hinges down to pike position
<i>Legs lifted to Bent Knee Vertical Position</i>	Legs are lifted to vertical assuming Bent Knee Position just after vertical is reached	Legs are lifted to vertical as they move to Bent Knee Position, arriving in bent knee prior to vertical	Legs are lifted to vertical, movement to Bent Knee Position is delayed
<i>Half Twist</i>	Rotation on lateral axis		
<i>Vertical Descent as bent knee extends to vertical</i>	Drop spaces and extension of bent knee slightly off	Bent knee fully extended before ankles reach surface	Bent knee fully extended as calves reach surface

**Front Ariana**

<i>Front Pike Position to Split Position</i>	*See chart for <b>Splits</b> (Section 9.5.2)		
<i>Ariana Rotation</i>	*See chart for <b>Splits</b> (Section 9.5.2)		Piked hips in front <b>Split</b>

**Swordfish**

<i>Front Layout Bent Knee Position to Surface Arch Bent Knee position</i>	Straight body until lifted leg reaches 30° from vertical	Straight body until lifted leg reaches 45° from vertical	Piking hips to start leg lift
---	--	--	-------------------------------

<b>Deviation Type Deduction Angle deviation</b>	<b>Small Deviation 0.2 1°-15°</b>	<b>Medium Deviation 0.5 16°- 30°</b>	<b>Large Deviation 1.0 31° or more</b>
---	---	--	--

**Kip**

<i>Back Layout Position to Inverted Back Tuck Position</i>	As body moves into tuck position head moves off the surface toward knees to assume tuck position	Head and torso move toward feet to assume a tuck position	
<i>Inverted Back Tuck Position to Vertical Position</i>	Tuck could be tighter	Head out of line	Knees off chest, head not tucked in
	Body unrolls and legs extend upward simultaneously but vertical attained is slightly in front of or behind midway point described	Unroll is not simultaneously achieved  Legs move to vertical and then back unrolls under legs	Head and back move to vertical and then the legs open at hips (thighs parallel to surface of water and legs straighten to vertical
			Head leads shoulders backward to open tuck

**Swanita Spinning 180°**

<i>Back Layout to Bent Knee Surface Arch Position</i>		Body arrives in Surface Arch Position just prior to knee bend	head and shoulders press backward, Surface Arch Position shown before knee bends
<i>Bent Knee Surface Arch to Knight Position</i>		Hips are not parallel and horizontal leg turned outward	Hips are not parallel (15° or more) and horizontal leg turned outward with kneecap perpendicular to surface
<i>Rotation from Knight Position to Fishtail Position</i>		Horizontal leg moves side to side during rotation	Vertical leg makes a circle during 180° rotation toward horizontal leg (off of axis)
<i>Helicopter 180° Rotation</i>	Horizontal and vertical leg join once the rotation and descent is completed at ankles		Descent is completed at ankles after the first 45° rotation, so second rotation half is performed at same height (twisting)



### 9.4.3 Control deductions guidelines

Control factors give an **overall impression** of the mastery level of athletes, that is Judges observe the performance in control terms. The Judge evaluates all control factors to establish the execution range.

In all areas the Judge observes, as the performance goes, if there are small, medium/obvious, or large deviations from perfection, and how often those appear, but does not distract with any calculation.

The Expanded Marking Scale show both, the overall general impression and the specific design and control points, depicting how a performance can look in each scoring range. This does not mean that all areas adjust precisely.

Control factors include:

1. **Height**

Amount of body (body parts) above the water surface.

Sustained maximum height, according to height charts, defines perfect height.

Height should set the maximum score attainable; in other words: a figure that can be considered of perfect execution in terms of design, extension, stability, etc. performed at a height of 8, according to the height scale, should not score more than 8. Judges must consider height shown during all figure performance, not only in difficult parts but easier ones as well and have at the end of the figure an **average** height in mind (e.g., vertical positions, knight, fishtail, split, etc.). See the Guiding Height Scales for stable and dynamic height in Section 9.5 and for splits in Section 9.5.2.

2. **Extension**

“The amount, degree, or range to which something can be stretched to its fullest length. Use of muscular strength to enhance the stretch”.

Consider extension of body, legs, instep, neck.

3. **Stability**

“Solid, with equilibrium maintained and unaffected by change of position”. Position unaffected by movement. Attain position exactly without correction. Fluid without evidence of strain”.

4. **Timing / Uniform motion**

“Constant speed of action throughout the figure unless otherwise specified in the figure description. Transitions are to be executed without any pauses or stops herein”.

5. **Travel**

Figures are to be performed stationary unless otherwise specified. Travel or lack of required travel need to be taken in consideration. Travel occurs when hips move in the horizontal plane.

### Travel deduction guidelines

Maximum deduction for travel from the overall impression score is 0.5.

<b>Small deduction 0.1</b>	<b>Medium deduction 0.3</b>	<b>Large deduction 0.5</b>
Minimal travel or minimal lack of required travel	Obvious travel in one (1) transition, and or/ travel in several transitions	Obvious travel in two (2) or more transitions and or travel throughout

### Summary

As a summary, the process should be:

1. Establish a general impression score range based on the continuous control observations: ease of performance, confidence and effortless, fluidity in execution and height demonstrated (perfect, near perfect, excellent, very good, etc.).
2. From this score, deduct design deviations observed, if any, and travel, if any. It is very important not to miss large design errors.

For example, the general impression places the performance in the good category, but the Judge noted that extension was excellent and must be credited. The Judge must balance and work with the tenths and decide, in this case, maybe to place in mid to high seven (7). There was a medium design error in one transition and a minimal travel, so must deduct 0.5+0.1 (0.6). So, the final score should be low seven (7).

Another example: in a Barracuda Airborne Split, the Judge appreciates excellent height, full extension, on spot performance, a small break in fluidity prior to *Thrust*, and is in a low nine (9.3), but the athlete started to split before reaching first vertical position; a medium 0.5 deduction should be applied, and the final mark should be lowered to 8.8.

Remember that the use of deduction guidelines is to help the Judge arrive at the accurate score based on the performance.

**9.5 GUIDING SCALE FOR HEIGHT QUALITY OF PERFORMANCE**

Water Levels For:	Perfect 10	Excellent/ Near Perfect 9.5	Very Good 8.5	Good 7.5	Competent 6.5	Satisfactory 5.5	Deficient 4.5	Weak 3.5	
<b>Stable Height</b>	<b>Vertical Double Leg</b>	Crotch level or higher	Upper thigh	Upper mid-thigh	Low to mid-thigh	Above kneecap	Kneecap	Below kneecap	Well below kneecap (mid shin)
	<b>Vertical Single Leg, Fishtail/BK</b>	Top of pelvis	Above crotch	Crotch level	Upper thigh	Mid-thigh	Low thigh (Well above kneecap)	Kneecap	Below kneecap
	<b>Knight</b>	Above crotch	Crotch level	Upper thigh	Mid-thigh	Low thigh (Well above kneecap)	Kneecap	Below Kneecap	Mid shin
	<b>Ballet Leg Single</b>	Horizontal leg dry	At top of thigh	Upper thigh	Mid-thigh	Low thigh (Well above kneecap)	Above kneecap	Kneecap	Below kneecap
	<b>Ballet Leg Double</b>	Upper thigh or higher	Mid-thigh	Low thigh	Above kneecap	Kneecap	Below kneecap	Well below kneecap (mid shin)	Low to mid shin
	<b>Eggbeater Kick Double Arm</b>	Top bust or higher	Arm pit dry	Upper bust	Showing collar bone	Showing shoulder	Mid neck	Chin	Mouth
<b>Dynamic Height</b>	<b>Eggbeater Kick Single Arm</b>	Bust above surface	Top bust	Mid bust	Arm pit dry	Upper bust	Showing collar bone	Showing shoulder	Mid neck
	<b>Thrust, Double Leg</b>	Mid ribs or higher	Lower ribs	Waist	Top of pelvis	Showing crotch	Upper thigh	Mid-thigh	Above kneecap
	<b>Thrust, Single Leg</b>	High ribs or higher	Mid ribs	Lower ribs	Waist	Top of pelvis	Showing crotch	Upper thigh	Mid-thigh
	<b>Rocket Split, Airborne Split</b>	Mid ribs or higher	Lower ribs	Waist	Top of pelvis	Showing crotch	Upper thigh	Mid-thigh	Above kneecap
	<b>*Re-join to Vertical Double Leg</b>	Crotch level or higher	Upper thigh	Upper mid-thigh	Low to mid-thigh	Above kneecap	Kneecap	Below kneecap	Well below kneecap (mid shin)
	<b>*Re-join to Vertical Single Leg</b>	Showing hips or higher	Showing hips	Crotch level	Upper thigh	Mid-thigh	Low thigh (Well above kneecap)	Kneecap	Below kneecap
<b>Boost (head up)</b>	Showing air between legs	Crotch level	Mid pelvis	Top of pelvis	Waist	Lower ribs	Arm pit	Showing shoulder	

**\*Rejoin to Vertical Double Leg:** The height of the re-joined to Vertical Positions for the Dynamic Height during unstable actions.

**\*Rejoin to Vertical Single Leg:** The height of the re-joined to Vertical Single Leg for the Dynamic Height during unstable actions.

**9.5.1 GUIDING SCALE FOR HEIGHT - DIAGRAMS**

**9.5.1.1 Eggbeater Kick Double Arms, Boost, Vertical Double Leg, Thrust Double Leg**

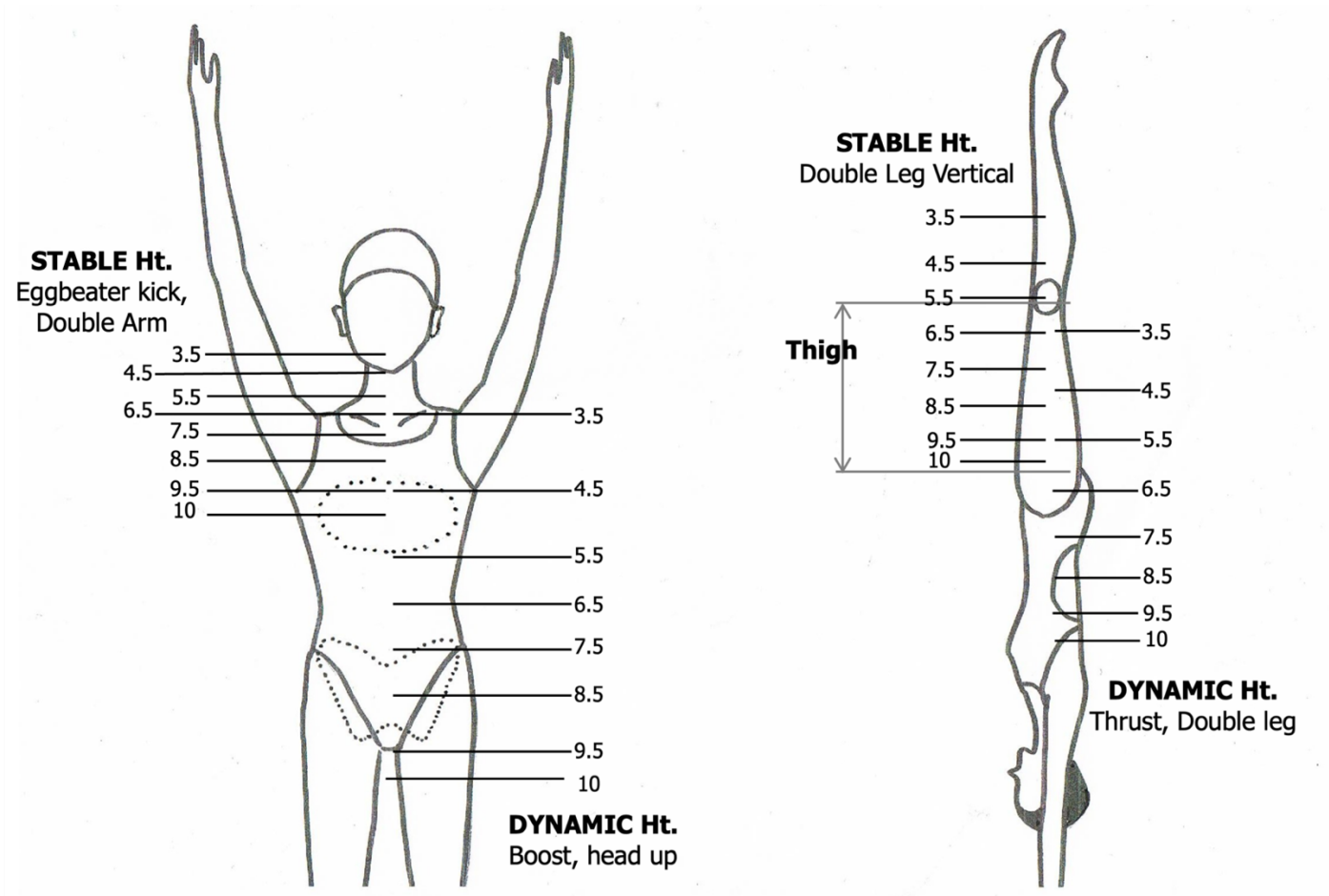

**9.5.1.2 Ballet Leg Single and Ballet Let Double Position**

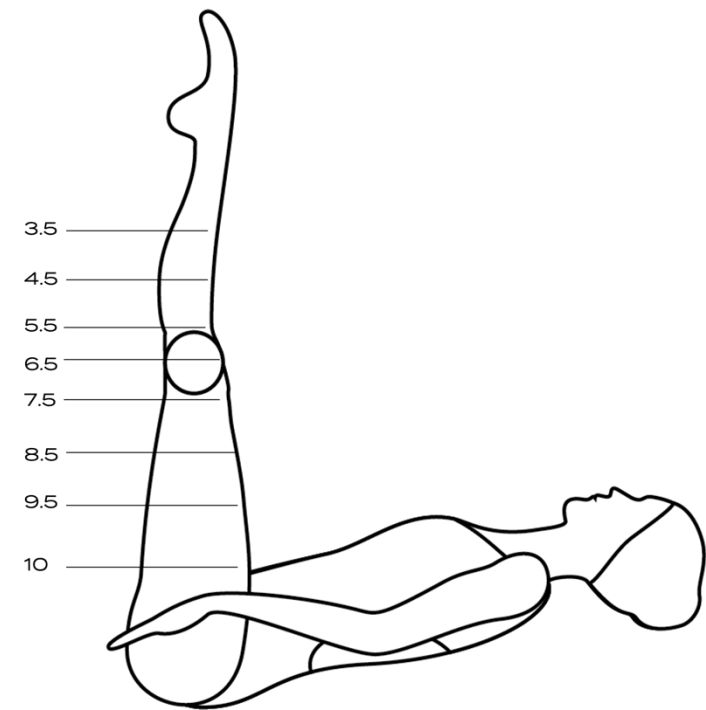
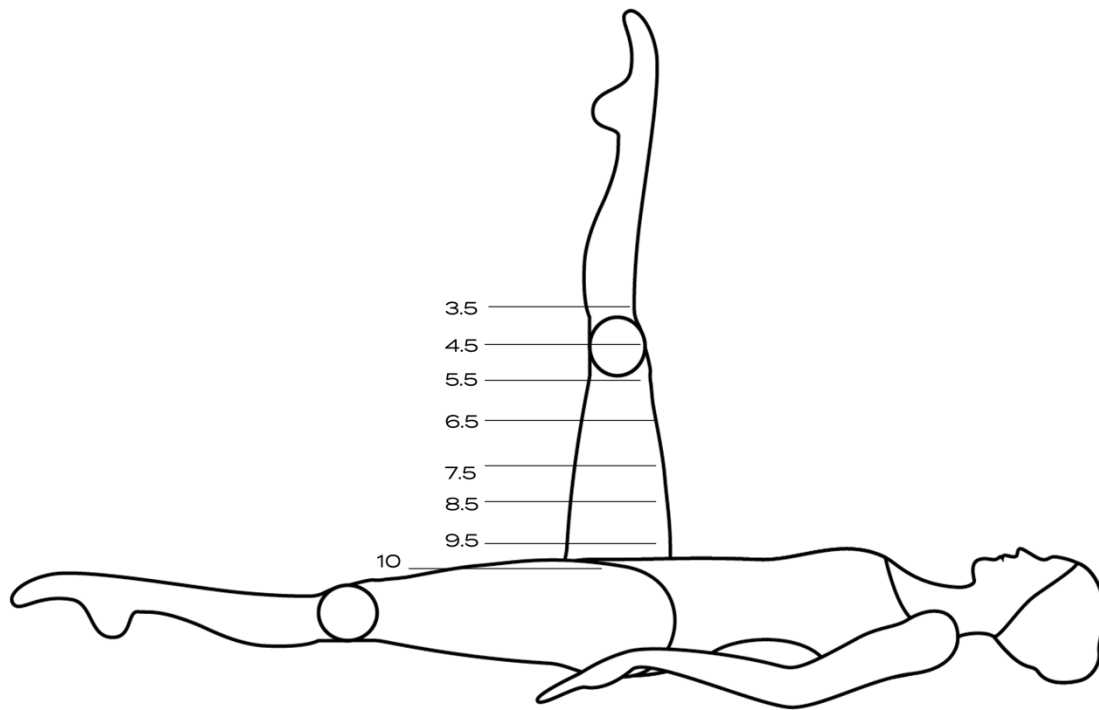

**9.5.1.3 Bent Knee Vertical and Fishtail Position**

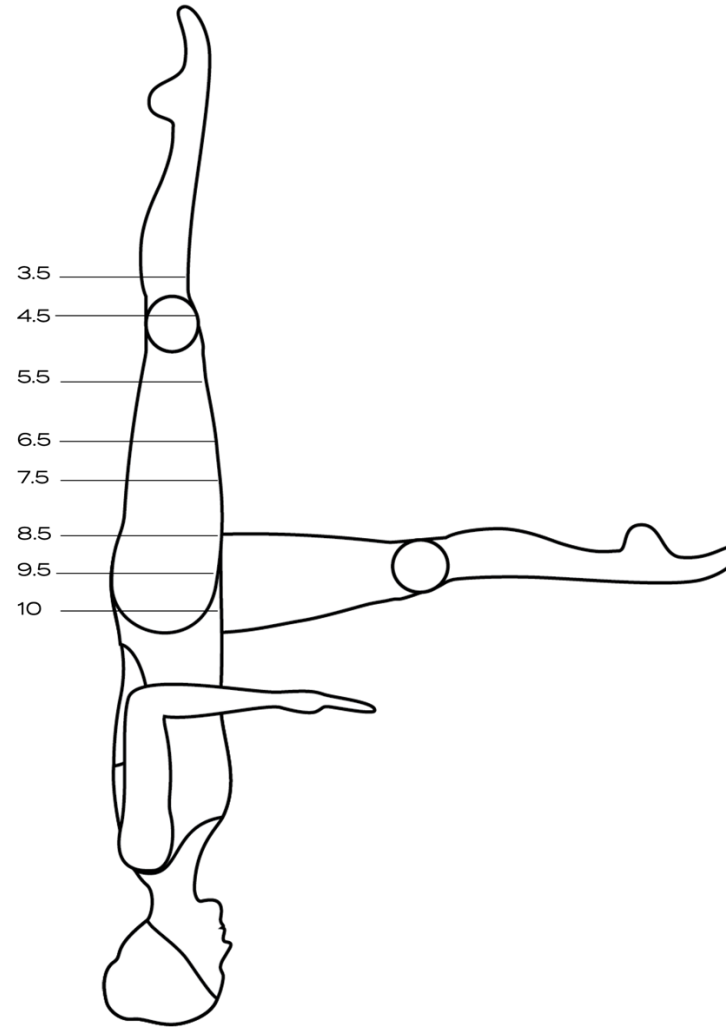
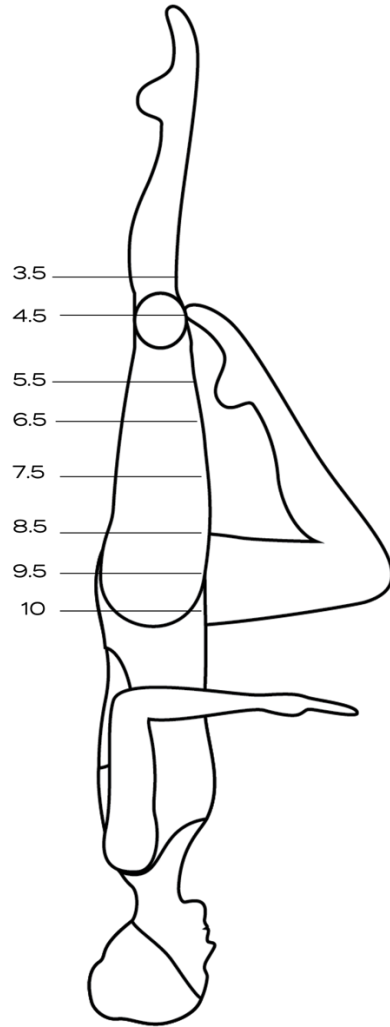

**9.5.1.4 Knight Position and Airborne Split**

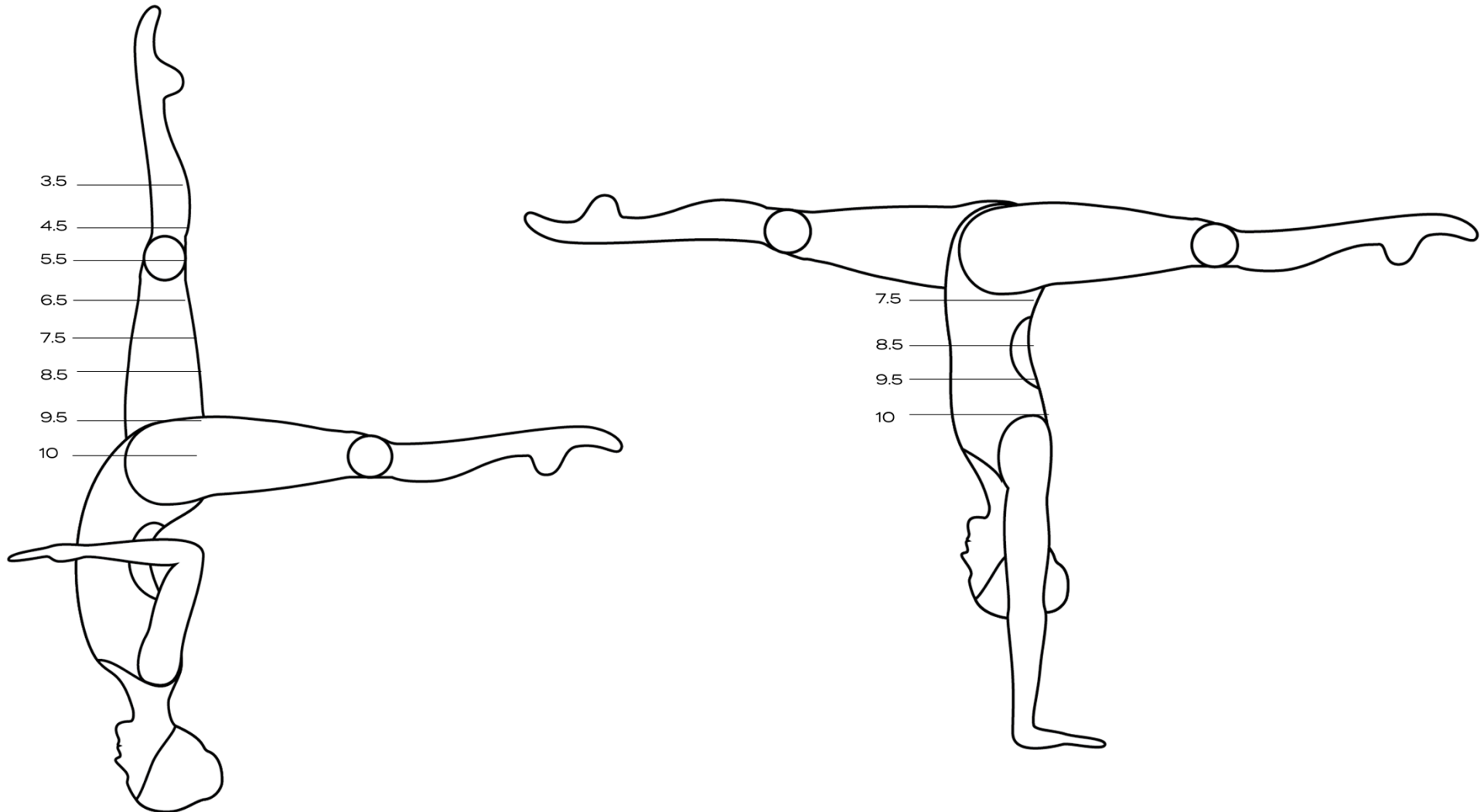



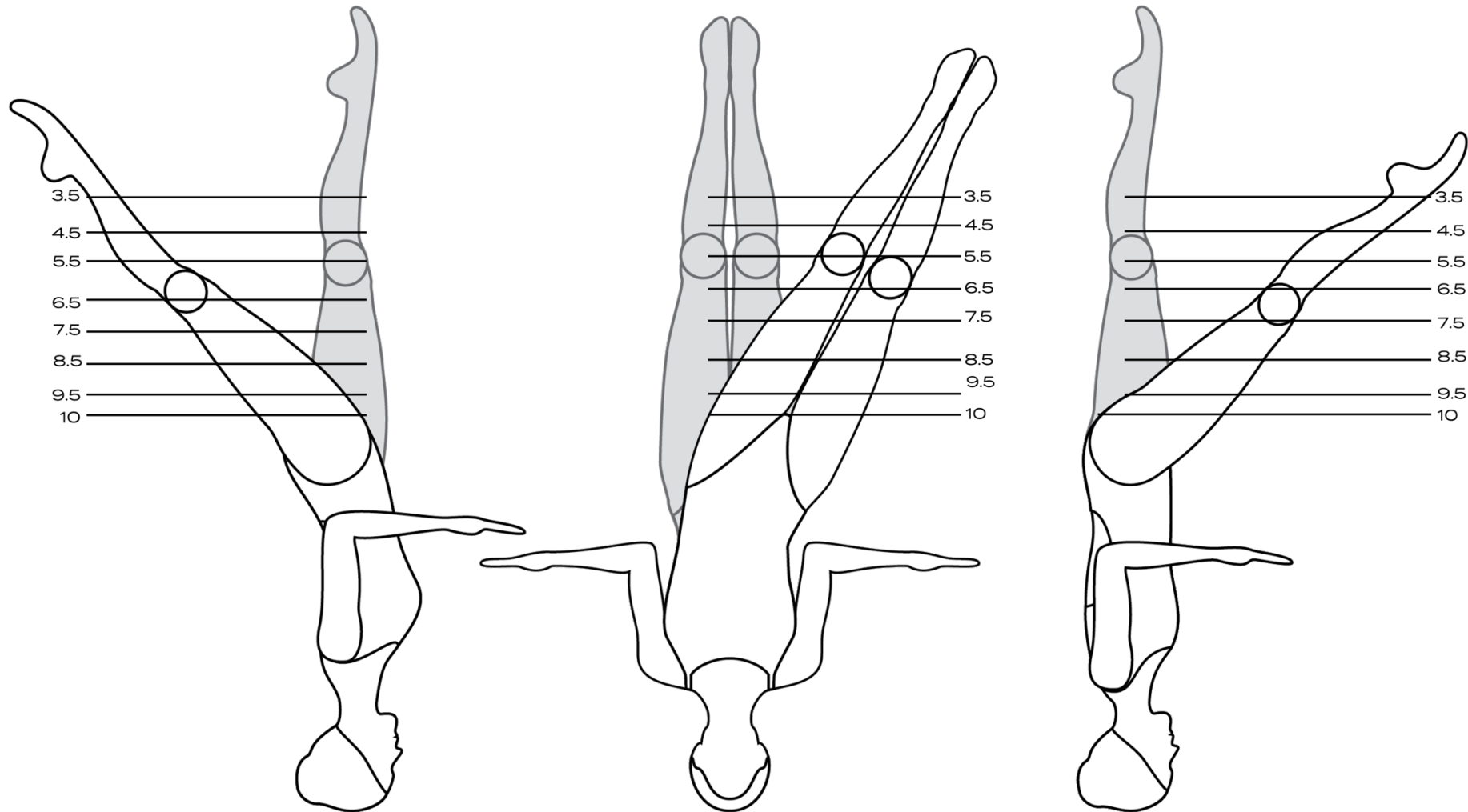





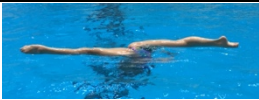







**9.5.1.5 Unbalanced Vertical Double Leg**





**9.5.2 Guiding Scale for Split Position**

SCORE RANGE		ANGLE OF SPLIT (DEGREE)			WATER LEVEL
<b>Excellent/ Near Perfect</b>	<b>9.5</b>	180° (flat)			Crotch & legs dry
<b>Very Good</b>	<b>8.5</b>	170° - 180°			Legs dry
<b>Good</b>	<b>7.5</b>	160° - 170°			Legs almost dry
<b>Competent</b>	<b>6.5</b>	150° - 160°			Lower legs dry Crotch underwater
<b>Satisfactory</b>	<b>5.5</b>	130° - 140°			Lower legs dry Crotch underwater
<b>Deficient</b>	<b>4.5</b>	110° - 120°			Feet above the surface, legs under water
<b>Weak</b>	<b>3.5</b>	up to 100°			Feet come out vertically
<b>Hardly recognizable</b>	<b>0.1 - 2.9</b>	scissors			Feet come out vertically

**9.6 EXPANDED MARKING SCALE FOR FIGURES**

<b>10 Perfect</b>	<b>9.5 to 9.9 Near Perfect</b>	<b>9.0 to 9.4 Excellent</b>	<b>8.0 to 8.9 Very Good</b>	<b>7.0 to 7.9 Good</b>	<b>6.0 to 6.9 Competent</b>
<b>General Impression</b>					
Flawless	Minute deviations from perfection.	Very minor errors but none are significant.	A few minor errors.	Above average.	Average. Comfortable.
<b>Accuracy of Positions / Stability / Ease of performance</b>					
Total accuracy. Stable, controlled. Correct body alignment maintained throughout. Complete ease of performance.	Very precise. Stable. Minute deviation may be difficult to detect. Complete ease of performance.	Accurate but some may lack complete precision. Stable.	Most positions are clear & accurate. A few very minor inaccuracies in stability and/or control.	May lack some accuracy but no major errors. Mostly stable and effortless.	Several minor inaccuracies. Not consistent. Lack of stability and control in difficult parts.
<b>Accuracy of Transitions / Control / Ease of performance</b>					
Efficient and accurate course of action. Complete ease of performance.	Minute wavering from line of transition. Complete ease of performance.	Very minor but slightly noticeable inaccuracies in line of transition or slight breaks in fluidity.	Minor deviations in accuracy, efficiency and/or fluidity. Minor breaks in ease of performance.	Irregularities but none are major. Mostly controlled and effortless.	Inconsistent. Problems with more difficult transitions. Effort evident in difficult parts.
<b>Extension / Clarity / Definition</b>					
Precise distinction between positions and transitions, with maximum extension throughout.	Near perfection. Clear distinction with full extension throughout.	Deviations are very minor. Well extended.	Accurate and clear with a few minor deviations from precision. Minor inconsistencies in extension.	Mostly clear distinction, but not always precise. Full extension not maintained throughout	Some obvious slurring between positions & transitions. Some incomplete extension.
<b>Height – Refer to Height Charts</b>					
Maximum height at all times, with level maintained as required throughout.	Near maximum height with no level changes throughout.	Close to maximum height with minimal level changes.	High, but may lose minor height on difficult transitions and/or positions.	Above average height on easy parts with some minor level changes. May lose height on difficult transitions.	Average height. Inconsistent and changing especially in more difficult positions and transitions.
<b>Timing / Uniform Motion / Stationary</b>					
Smooth, uniform tempo at a comfortable speed except where required. No travel unless otherwise specified.	Minute variation in timing or a position except where required. No travel unless otherwise specified.	Very minor variations in timing or positions. No travel unless otherwise specified.	Timing a little bit faster or slower than as described. Not always uniform. Minor travel.	Timing inaccuracies that are not required in the description. Minimal travel.	Timing may be hurried and/or uneven during uniform motion parts. Some travel in one or more parts.

**EXPANDED MARKING SCALE FOR FIGURES (cont.)**

<b>5.0 to 5.9 Satisfactory</b>	<b>4.0 to 4.9 Deficient</b>	<b>3.0 to 3.9 Weak</b>	<b>2.0 to 2.9 Very Weak</b>	<b>0.1 to 1.9 Hardly Recognizable</b>	<b>0 Completely Failed</b>
<b>General Impression</b>					
Mediocre. Limited. Significant deviations.	Problems frequent and major.	Struggling in all aspects.	Difficult to recognize.	Performance bears almost no resemblance to description.	Complete fail. Penalty assessed.
<b>Accuracy of Positions / Stability / Ease of performance</b>					
Many minor problems or a significant deviation. Effort evident impacting stability. Major errors at lower end of range.	Most positions inaccurate with some major problems in achieving positions. Unstable.	Identifiable but very inaccurate throughout. Lack of control evident.	General outline present, but positions unclear. No control evident.	Complete lack of definition and control.	Complete fail. Penalty assessed.
<b>Accuracy of Transitions and Movements / Ease of performance</b>					
Accuracy inconsistent. Some major deviations. Minimal control. Effort evident throughout.	Evident effort to meet requirements. Major errors throughout. Loses control in many parts.	Little attention to transition specifics. Many major problems in all transitions.	No attention to transition specifics.	Merely moves from one position to another.	Complete fail. Penalty assessed.
<b>Extension / Clarity / Definition</b>					
Some attempt to define positions, but often not clear. Minimal extension.	Clarity is imprecise. Poor extension.	Unclear and poor extension throughout.	Difficult to identify a position or a transition. No extension evident.	No clarity, no extension or definition throughout.	Complete fail. Penalty assessed.
<b>Height – Refer to Height Chart.</b>					
Some height may be evident in easier sections.	Low and inconsistent. Level changes throughout.	Low. Extreme difficulty to achieve any height.	Very low. Natural buoyancy only.	No effort.	Complete fail. Penalty assessed.
<b>Timing / Uniform Motion / Stationary</b>					
Often rushed & seldom stationary. Segmented. Obvious travel evident.	Rushed and uneven timing. Significant travel in one or more parts.	Fast and/or uneven timing. Significant travel throughout.	No apparent consideration for timing or travel requirements.	Completely lacking in correct timing. Significant travel throughout.	Complete fail. Penalty assessed.

**10. IDENTIFYING DIFFICULTY IN FIGURES****10.1 IDENTIFY ESSENTIAL SYNCHRO SPECIFIC ELEMENTS**

For determining degrees of difficulty, the following Essential Synchro Specific Elements (ESSE) were defined and assigned values. The assessed values are based upon the relative difficulty of each component within a given transition.

**Essential Synchro Specific Elements (ESSE)**

1. Sculling Proficiency
2. Center of Gravity and Buoyancy
  - Relationship between Center of Gravity and Buoyancy as it affects stability
  - How the change in the relationship between the center of gravity and buoyancy affects stability
3. Kinesthetic and Spatial Perception
  - Kinesthetic awareness – the ability to know the spatial relationships of the body parts
4. Airborne Weight
5. Water Resistance
  - Resistance as created by buoyancy and/or drag
  - Formula: Drag =  $1/2 \times [\text{water density}] \times [\text{drag coefficient}] \times [\text{cross sectional area (CSA)}] \times [\text{speed of the object}]^2$
6. Joint Flexibility
  - Awarded when required action (not initial position) is beyond normal Range of Movement

## 10.2 TABLES OF TRANSITION

The following table includes the numerical values for each transition.

### 10.2.1 Category 1: Airborne - Horizontal Base

1-01	Back Layout to Ballet Leg (straight)	18.5
1-02	Back Layout to Bent Knee Back Layout	10.5
1-03	Back Layout to Tub	2.0
1-04	Ballet Leg Double 360° Surface Rotation	24.0
1-05	Ballet Leg Double to Ballet Leg (straight)	24.5
1-06	Ballet Leg Double to Tub	19.0
1-07	Ballet Leg to Back Layout (straight)	18.5
1-08	Ballet Leg to Ballet Leg Double (straight)	24.5
1-09	Ballet Leg to Bent Knee Back Layout	11.0
1-10	Ballet Leg to Flamingo	7.5

1-11	Bent Knee Back Layout to Back Layout	10.5
1-12	Bent Knee Back Layout to Ballet Leg	11.0
1-13	Flamingo to Back Layout	15.0
1-14	Flamingo to Ballet Leg Double	13.0
1-15	Flamingo to Bent Knee Back Layout	15.0
1-16	Front Layout to Bent Knee Front Layout	4.0
1-17	Tub to Back Layout	3.0
1-18	Tub to Ballet Leg Double	19.0
1-19	Exchange BL	17.0
1-20	Flamingo to Ballet Leg	13.0

### 10.2.2 Category 2: Airborne - Vertical Base

2-01	Bent Knee Vertical (Unstable base) to Submerged Bent Knee Vertical	11.0
2-02	Bent Knee Vertical (Unstable base) to Submerged Vertical	12.0
2-03	Bent Knee Vertical to Vertical	16.5
2-04	Fishtail to Bent Knee Vertical	12.5
2-05	Fishtail to Front Pike	14.5
2-06	Fishtail to Knight (maintain 90°)	31.0
2-07	Fishtail to Knight at the surface	21.0
2-08	Fishtail to Split	15.5
2-09	Fishtail to Split (Rapid, cross)	20.0
2-10	Fishtail too Vertical	20.5
2-11	Front Pike to Bent Knee Vertical	15.0
2-12	Front Pike to Fishtail	14.5
2-13	Front Pike to Split	20.0
2-14	Front Pike to Vertical	33.0
2-15	Vertical to Airborne Split (Unstable base)	17.0
2-17	Vertical to Fishtail	20.5
2-19	Vertical to Knight	23.5
2-20	Vertical to Split	17.0

2-21	Vertical to Split (Rapid)	19.0
2-22	Vertical to Front Pike	33.0
2-23	Vertical to Bent Knee Vertical	16.5
2-24	Vertical to Bent Knee Vertical (all Unstable base)	18.5
2-25	Bent Knee Vertical to Airborne Split (all Unstable base)	19.0
2-26	Vertical to Bent Knee to Airborne Split to Vertical (All bases unstable)	31.5
2-27	Vertical to Fishtail (all Unstable base)	18.5
2-28	Vertical to Fishtail (Rapid)	22.5
2-29	Front Pike to Fishtail (Rapid)	12.5
2-30	Fishtail to Bent Knee Vertical (Rapid)	12.5
2-31	Bent Knee Vertical to Fishtail (Rapid, switch)	18.5
2-32	Fishtail to Knight (lifting)	28.0
2-34	Fishtail to Bent Knee Vertical (unstable, Switch, Rapid)	17.0
2-35	Bent Knee Vertical to Fishtail	12.0
2-36	Fishtail to Vertical (Unstable base)	14.0
2-37	Vertical to Side Fishtail (all Unstable base)	18.5
2-38	Fishtail to Knight (lifting, rapid)	26.0
2-39	Fishtail too Vertical (rapid)	20.5

### 10.2.3 Category 3: Arched Base or Movement

3-01	Airborne Split to Airborne Split (crossing)	22.0
3-02	Airborne Split to Vertical (Unstable base)	13.0
3-03	Airborne Split to Vertical Bent Knee (Unstable base)	13.0
3-04	Arched Bent Knee Vertical to Ballet Leg	24.5
3-05	Arched Bent Knee Vertical to Knight	20.0
3-06	Arched Fishtail to Fishtail	14.0
3-07	Back Layout to Bent Knee Surface Arch	17.5
3-08	Back Layout to Surface Arch	12.0
3-09	Ballet Leg to Knight	25.0

3-24	Knight to Fishtail (body 180° rotation)	14.0
3-25	Knight to Fishtail at surface	18.0
3-26	Knight to Split	15.5
3-27	Knight to Surface Arch	18.5
3-28	Knight to Vertical	26.5
3-29	Split to Fishtail	14.5
3-30	Split to Front Pike	19.0
3-31	Split to Knight	17.5
3-32	Split to Surface Arch	23.0

3-10	Bent Knee Front Layout to Arched Bent Knee Vertical	31.0	3-33	Split too Vertical	20.0
3-11	Bent Knee Front Layout to Bent knee Surface Arch	47.0	3-34	Split to Vertical at Ankle Level	5.0
3-12	Bent Knee Surface Arch to Bent Knee Vertical	21.0	3-35	Surface Arch to Back Layout	7.0
3-13	Bent Knee Surface Arch to Surface Arch	11.5	3-36	Surface Arch to Knight	23.5
3-15	Bent Knee Surface Arch to Vertical	21.0	3-37	Surface Arch to Split	29.0
3-16	Bent Knee Vertical to Bent Knee Surface Arch	19.0	3-38	Surface Arch to Vertical	37.0
3-17	Fishtail to Bent Knee Surface Arch (Rapid)	36.0	3-39	Bent Knee Surface Arch to Knight	14.0
3-18	Front Layout to Arched Fishtail	30.5	3-40	Vertical to Surface Arch	37.0
3-19	Front Layout to Split	48.0	3-41	Split too Vertical (Rapid)	16.0
3-20	Front Pike to Split on surface	9.0	3-42	Vertical to Surface Arch Bent Knee	21.0
3-21	Knight to Ballet Leg	22.0	3-43	Airborne Split to Vertical with twirl (Unstable base)	27.0
3-22	Knight to Bent Knee Surface Arch	15.0	3-44	Airborne Split to BK Vertical with twirl (Unstable base)	25.0
3-23	Knight to Bent Knee Vertical	21.0	3-45	Front Layout to Split, rapid	43.0

#### 10.2.4 Category 4: Circular Patterns

4-01	Back Layout to Dolphin First Quarter (headfirst)	7.0
------	--	-----

#### 10.2.5 Category 5: Descending

5-01	Back Layout to Submerged Back Pike	7.0	5-11	Vertical Unstable Base to Submerged Vertical	13.0
5-02	Back Layout to Submerged Ballet Leg Double	10.0	5-12	Ballet Leg Double to Submerged Back Pike	12.0
5-03	Ballet Leg Double to Submerged Ballet Leg Double	16.0	5-13	Bent Knee Vertical Unstable Base to Submerged Vertical	9.0
5-04	Ballet Leg to Submerged Ballet Leg	13.5	5-14	Vertical to Submerged Vertical (rapid)	13.0
5-05	Bent Knee Vertical to Submerged Bent Knee Vertical	10.0	5-15	Vertical Unstable Base to ankle level Vertical	13.0
5-06	Bent Knee Vertical to Submerged Vertical	9.0	5-16	Bent Knee Vertical to Submerged Bent Knee Vertical ankle level (rapid)	11.0
5-07	Bent Knee Vertical Unstable Base to Submerged Bent Knee Vertical	11.0	5-17	Bent Knee Vertical to Submerged Bent Knee Vertical (rapid)	11.0
5-08	Vertical at Ankle Level to Submerged Vertical	5.0	5-18	Bent Knee Vertical to Bent Knee Vertical ankle level	10.0
5-09	Vertical to Ankle Level Vertical	14.0	5-19	Fishtail to Submerged Vertical	8.5
5-10	Vertical to Submerged Vertical	14.0			

#### 10.2.6 Category 6: Multi-dimensional

6-01	Arched Bent Knee Vertical to Submerged Flamingo	21.0	6-10	Split through Knight variant to Bent Knee Vertical with 1/2 Twist	22.0
6-02	Back Layout to Front Pike (Albatross turn)	15.0	6-11	Split to Fishtail with rapid 180° rotation	16.5
6-03	Ballet Leg to Fishtail (Catalina Rotation)	24.0	6-12	Submerged Ballet Leg Double to Vertical with 180° rotation	19.0
6-04	Bent Knee Surface Arch to Vertical with 360° rotation	27.5	6-13	Submerged Ballet Leg to Fishtail (Catalina Rotation)	14.5
6-05	Fishtail to Ballet Leg (Catalina Reverse Rotation)	24.0	6-14	Front Pike to Vertical with half twist (180° rotation - Rapid)	33.0
6-06	Fishtail to Ballet Leg Double with Reverse Catalina Rotation	31.5	6-15	45° off angle Vertical to Surface Arch with 90° rotation	26.0
6-07	Front Pike to Split through Side Fishtail	23.0	6-16	Front Pike to Fishtail with full twist (360° rotation)	32.0
6-08	Front Pike to Vertical with a Full Twist	37.0	6-17	Bent Knee Surface Arch to Vertical as Twirl is executed	29.0
6-09	Side Ballet Leg to Front Pike	8.0	6-18	Front Pike to BK Vertical with half twist (180° rotation - Rapid)	17.0

**10.2.7 Category 7: Submerged**

7-01	Submerged Ballet Leg Double to Ballet Leg Double	16.0
7-02	Submerged Ballet Leg Double to Split	11.0
7-03	Submerged Ballet Leg Double to Submerged Ballet Leg	8.0
7-04	Submerged Ballet Leg Double to Submerged Flamingo	3.0
7-05	Submerged Ballet Leg Double to Submerged Heron Pike	5.0
7-06	Submerged Ballet Leg to Ballet Leg	13.5
7-07	Submerged Bent Knee Vertical to Bent Knee Vertical	9.0
7-08	Submerged Flamingo to Ballet Leg	10.5

7-09	Submerged Flamingo to Flamingo	10.0
7-10	Submerged Vertical to Fishtail	7.5
7-11	Submerged Vertical to Submerged Back Pike	12.0
7-12	Submerged Vertical to Submerged Ballet Leg Double	10.0
7-13	Submerged Vertical to Vertical	13.0
7-14	Submerged Ballet Leg Double to Submerged Back Pike	5.0
7-15	Submerged Ballet Leg Double to Flamingo with 180° rotation	15.5
7-16	Submerged Ballet Leg Double to Flamingo with 360° rotation	18.5

**10.2.8 Category 8: Rotation Lateral Axis**

8-01	Back Layout to Back Pike	14.0
8-02	Back Layout to Inverted Tuck through Ballet Leg (Rapid)	16.5
8-03	Back Layout to Tuck	3.0
8-04	Back Pike "V" to Back Layout	5.0
8-05	Back Pike to "V"	13.0
8-06	Ballet Leg to Fishtail (tip)	33.0
8-07	Fishtail to Ballet Leg (tip)	33.0
8-08	Front Layout to Front Pike	6.0

8-09	Front Pike (head down) to Front Layout	6.0
8-10	Front Pike (legs down) to Front Layout	6.0
8-11	Front Pike to Submerged Ballet Leg Double	8.0
8-12	Submerged Ballet Leg Double to Front Pike (legs down)	8.0
8-13	Tuck to Back Layout	3.0
8-14	Tuck to Inverted Tuck	2.0
8-15	Tuck to Tuck	5.0
8-16	Ballet Leg to Inverted Tuck	6.0

**10.2.9 Category 9**
**10.2.9.1 Rotation Longitudinal Axis - Twists**

9.1-01	Ballet Leg to Side Ballet Leg	18.5
9.1-02	Bent Knee Vertical Full Twist	20.0
9.1-03	Bent Knee Vertical Half Twist	15.0
9.1-04	Bent Knee Vertical to Vertical with Full Twist (extending & joining)	22.0
9.1-05	Bent Knee Vertical to Vertical with Half Twist (extending & joining)	16.5
9.1-06	Fishtail 2 Full Twists (720° rotations - Rapid)	50.0
9.1-07	Fishtail Half Twist	17.0
9.1-08	Knight Full Twist	34.0
9.1-09	Knight Half Twist	24.0
9.1-10	Split Half Twist	13.0
9.1-11	Split to Split (Ariana turn)	17.0
9.1-12	Split to Vertical with Full Twist (closing 360°)	27.0
9.1-13	Split to Vertical with Half Twist (closing 180°)	17.0
9.1-14	Vertical Full Twist	32.0
9.1-15	Vertical Half Twist	21.0

9.1-16	Vertical to Bent Knee Vertical with Full Twist	24.5
9.1-17	Vertical to Split with Full Twist (opening 360°)	26.0
9.1-18	Vertical to Split with Half Twist (opening 180°)	20.0
9.1-19	Fishtail to Vertical with 720° rotations - Rapid	37.0
9.1-20	Fishtail to Vertical with 360° rotations - Rapid	26.5
9.1-21	Split to Vertical with Full Twist (closing 360°) - Rapid	29.0
9.1-23	Side Fishtail to 45 off angle Vertical with 180° rotations	23.5
9.1-24	45° off angle Vertical Half Twist	24.0
9.1-25	Fishtail to Vertical with 180° rotations	21.5
9.1-26	Vertical 2 Full Twist (720°)	54.0
9.1-27	Fishtail 360° rotation	24.0
9.1-29	Knight to Vertical with 360° rotations - Rapid	36.0
9.1-30	Vertical to Bent Knee Vertical with half Twist	17.5
9.1-31	Fishtail to Knight at the surface with 360° rotations	33.0

**10.2.9.2 Rotation Longitudinal Axis - Twirls**

9.2-01	Airborne Split to Vertical with Twirl (All Bases Unstable)	30.0
9.2-02	Bent Knee Vertical to Vertical with Twirl	21.5
9.2-03	Bent Knee Vertical Twirl	20.0
9.2-04	Split to Vertical with Twirl	22.0
9.2-05	Vertical to Bent Knee Vertical with Twirl	21.0
9.2-06	Vertical Twirl	26.0
9.2-07	Vertical Twirl - Unstable Base	40.0

9.2-08	Vertical Twirl at Ankle	11.0
9.2-09	Bent Knee Vertical Twirl (Unstable)	25.0
9.2-10	Fishtail to Bent Knee Vertical (Switch) to Fishtail	19.0
9.2-11	Vertical to Bent Knee Vertical with Twirl (unstable)	26.0
9.2-12	Split to Vertical with Twirl (closing 180°) - Rapid	18.0
9.2-13	Fishtail to Vertical with Twirl (Rapid)	23.5
9.2-14	Knight to Vertical with Twirl - Rapid	28.5

**10.2.9.3 Rotation Longitudinal Axis – Descending Spins**

9.3-01	Bent Knee Vertical 180° (Descending)	16.0
9.3-02	Bent Knee Vertical 360° (Descending)	19.0
9.3-03	Bent Knee Vertical Continuous Spin 720° (Rapid)	27.0
9.3-04	Bent Knee Vertical Join Continuous Spin 1080° (Rapid)	28.0
9.3-05	Bent Knee Vertical Join Spin 180° (Descending)	13.0
9.3-06	Bent Knee Vertical Join Spin 180° (Unstable Base - Rapid)	18.0
9.3-07	Bent Knee Vertical Join Spin 360° (Descending)	16.0
9.3-08	Fishtail to Vertical Continuous Spins 720° (Helicopter spin - Rapid)	29.5
9.3-09	Fishtail to Vertical Spin 360° (Helicopter spin)	17.5
9.3-10	Vertical 180° (Descending)	16.0
9.3-11	Vertical 180° (Unstable Base - Rapid)	24.0
9.3-12	Vertical 360° (Descending)	19.0
9.3-13	Vertical 360° (Unstable Base - Rapid)	39.0
9.3-14	Vertical Continuous Spin 1080° (Rapid)	49.0
9.3-15	Vertical Continuous Spin 1440° (Rapid)	60.0

9.3-16	Vertical Continuous Spin 720° (Rapid)	34.0
9.3-17	Vertical Continuous Spin 720° (Unstable Base - Rapid)	67.0
9.3-18	Bent Knee Vertical Join Continuous Spin 720° (Rapid)	24.0
9.3-19	Bent Knee Vertical 180° (Descending, Unstable Base - Rapid)	21.0
9.3-20	Bent Knee Vertical 360° (Descending, Unstable Base - Rapid)	27.0
9.3-21	Bent Knee Vertical Continuous Spin 720° (Unstable Base - Rapid)	36.0
9.3-22	Bent Knee Vertical Join Spin 360° (Unstable Base - Rapid)	24.0
9.3-23	Fishtail - Bent Knee - Vertical join Spin 360° (Unstable Base - Rapid)	26.0
9.3-24	Fishtail to Vertical Spin 360° (Unstable Base, rapid Helicopter spin)	25.5
9.3-25	Fishtail to Vertical Spin 180° (Helicopter spin)	12.5
9.3-26	Vertical 360° (Descending-Rapid)	23.0
9.3-27	Vertical Continuous Spin 540° (Unstable Base - Rapid)	44.0
9.3-28	Fishtail to Vertical Spin 180° (Unstable Base, rapid Helicopter spin)	17.5
9.3-29	Vertical 180° (Descending-Rapid)	19.0

**10.2.9.4 Rotation Longitudinal Axis – Ascending Spins**

9.4-01	Bent Knee Vertical 180° (Ascending)	16.0
9.4-02	Bent Knee Vertical 360° (Ascending)	17.0
9.4-03	Bent Knee Vertical Join 180° (Ascending)	17.5
9.4-04	Bent Knee Vertical Join 360° (Ascending)	18.5

9.4-05	Vertical 180° (Ascending)	20.0
9.4-06	Vertical 360° (Ascending)	21.0
9.4-07	Vertical 180° (Ascending, rapid)	21.0



**10.2.9.5 Rotation Longitudinal Axis – Combined Actions**

9.5-01	Bent Knee Combined Spin (360° + 360°)	48.0	9.5-07	Reverse Combined Spin (1080° + 1080°)	63.0
9.5-02	Bent Knee Combined Spin Joining and Bending (360° + 360°)	40.0	9.5-08	Twist Spin	48.0
9.5-03	Combined Spin (1080°+ 1080°)	63.0	9.5-09	Combined Spin (360° + 360°) (Rapid)	42.0
9.5-04	Combined Spin (360° + 360°)	40.0	9.5-10	Combined Spin (720° + 720°) (Rapid)	50.0
9.5-05	Reverse Bent Knee Combined Spin (360° + 360°)	32.0	9.5-11	Combined Spin (720° + 720°)	44.0
9.5-06	Reverse Combined Spin (360° + 360°)	40.0	9.5-12	Combined Spin (1080°+ 1080°) (Rapid)	69.0

**10.2.10 Category 10: Unrolls**

10-01	Ballet Leg Double to Vertical	28.0	10-07	Submerged Back Pike to Bent Knee Vertical Unstable (Thrust)	28.0
10-02	Flamingo to Bent Knee Vertical	20.0	10-08	Submerged Back Pike to Vertical Unstable (Thrust)	31.0
10-03	Flamingo to Fishtail	22.5	10-09	Submerged Ballet Leg Double to Knight (Aurora)	16.0
10-04	Inverted Tuck to Bent Knee Vertical	15.0	10-10	Submerged Ballet Leg Double to Vertical (moderate)	19.0
10-05	Inverted Tuck to Vertical	23.0	10-11	Submerged Heron Pike to Bent Knee Vertical Unstable (Thrust)	28.0
10-06	Inverted Tuck to Vertical with 360° rotation	25.0	10-12	Inverted Tuck to Vertical (Rapid)	20.0

**10.3 PROCEDURES FOR DETERMINING DEGREES OF DIFFICULTY**

- Determine the numerical value of each transition within a figure or an Element (as shown in the above Table)
- Add the NVT (Numerical Value of a Transition) of all transitions:

$$NV = \sum NVT$$

NV = numerical value of the summation of difficulties of all transitions within the figure or Element

- Formula:

$$DD = NV/K + C$$

K & C: constants selected to allow conversion of all NVs to DDs within a selected DD range. For the existing range of NVs (2--69), with a designated DD range from 1.1 to 3.7

$$K = 54.3$$

$$C = 0.85$$

DD = degree of difficulty of a Figure or an Element

**11. ANALYSIS OF FIGURES**
**11.1 ANALYSIS OF BASIC BODY POSITIONS**



In all basic Body Positions:

- a) Arm positions are optional,
- b) Toes must be pointed, ankles must be extended,
- c) Legs, trunk, and neck are fully extended unless otherwise specified, and
- d) Diagrams are a guide only. If there is a discrepancy between a diagram and a written description, the English written Body Position description prevails.



The below table includes a list of basic Body Positions in Artistic Swimming, detailed description of which is included in the subsequent sections.

<b>BP #</b>	<b>BP Type</b>	<b>BP #</b>	<b>BP Type</b>
BP 1	<b>Back Layout Position</b>	BP 11	<b>Back Pike Position</b>
BP 2	<b>Front Layout Position</b>	BP 12	
BP 3	<b>Ballet Leg Position</b>	BP 13	<b>Surface Arch Position</b>
BP 4	<b>Flamingo Position</b>	BP 14	<b>Bent Knee Position</b>
BP 5	<b>Ballet Leg Double Position</b>	BP 15	<b>Tub Position</b>
BP 6	<b>Vertical Position</b>	BP 16	<b>Split Position</b>
BP 7	<b>Crane Position</b>	BP 17	<b>Knight Position</b>
BP 8	<b>Fishtail Position</b>	BP 18	<b>Knight Varian Position</b>
BP 9	<b>Tuck Position</b>	BP 19	<b>Side Fishtail Position</b>
BP 10	<b>Front Pike Position</b>		

**11.1.1 BP 1 Back Layout Position**

Body Position Description	Diagrams	Major Desired Actions
1. Body extended with face, chest, thighs, and feet at the surface of the water.		1. Gives the impression that the body is stretched horizontally to its maximum. Front of the trunk will also be at the surface of the water.
2. Head (ears specifically), hips and ankles in horizontal alignment.		2. Judgement is made by checking visual points of the horizontal alignment: ears, shoulder joints, hip joints and ankles. This imaginary line should also pass through the middle of the side of the trunk.

**11.1.2 BP 2 Front Layout Position**

Body Position Description	Diagrams	Major Desired Actions
1. Body extended with head, upper back, buttocks, and heels at the surface of the water.		1. Gives the impression that the body is stretched horizontally to its maximum. Judgement made by checking visual points of the horizontal alignment: ears, shoulder joints, hip joints and heels.
2. Unless otherwise specified, face may be in or out of the water.		2. Once the head position is established as in or out of the water the position is maintained. When the face is out of the water the ears will not be on the horizontal axis and the back may be slightly lower and arched. Hip joints, calves and heels remain at the surface of the water.

**11.1.3 BP 3 Ballet Leg Position**

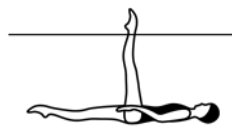
Body Position Description	Diagrams	Major Desired Actions
<p><b>a) Surface</b></p> <p>1. Body in <b>Back Layout Position</b>.</p> <p>2. One leg extended perpendicular to the surface of the water.</p>		<p>1. See BP 1 <b>Back Layout Position</b>. Ears, shoulder joints, hip joints and ankle of extended leg in line at maximum horizontal alignment.</p> <p>2. 90° angle between the extended leg and the surface of the water and between the extended leg and the trunk with maximum horizontal alignment maintained throughout.</p>
<p><b>b) Submerged</b></p> <p>1. Head, trunk, and horizontal leg parallel to the surface of the water.</p> <p>2. One leg perpendicular to the surface with the water level between the knee and the ankle.</p>		<p>1. See body alignment requirements of BP 1 <b>Back Layout Position</b>.</p> <p>2. The angles between the ballet leg and the body must remain at 90° throughout.</p>

**11.1.4 BP 4 Flamingo Position**

Body Position Description	Diagrams	Major Desired Actions
<p><b>a) Surface</b></p> <p>1. One leg extended perpendicular to the surface of the water.</p> <p>2. The other leg bent with the mid-calf opposite the vertical leg. Foot, shin, and knee at and parallel to the surface of the water.</p> <p>3. Face at the surface of the water.</p>		<p>1. 90° angle between the extended leg and the surface of the water.</p> <p>2. The top of the bent leg from knee to toes should be dry with the vertical leg extended perpendicular midway between knee and ankle of the horizontal leg.</p> <p>3. Chest close to the surface of the water with the shoulders back. Ears, shoulder joints and hip joints aligned with the spine straight and extended.</p>



**BP 4 Flamingo Position (cont.)**

Body Position Description	Diagrams	Major Desired Actions
<b>b) Submerged</b> 1. Trunk, head, shin, and foot of the bent leg parallel to the surface of the water.  2. 90° angle between the trunk and extended leg.  3. Water level between knee and ankle of the extended leg.		1. Ears, shoulder joints and hip joints aligned.  2. The vertical leg is extended perpendicular to the bent leg midway between the knee and the ankle of the horizontal leg.

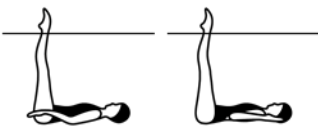
**11.1.5 BP 5 Ballet Leg Double Position**

Body Position Description	Diagrams	Major Desired Actions
<b>a) Surface</b> 1. Legs together and extended perpendicular to the surface of the water.  2. Head in line with the trunk.  3. Face at the surface of the water.		1. Full extension of the legs at a 90° angle to the surface of the water.  2. Chest close to the surface of the water with the shoulders back. Ears, hip joints and shoulder joints aligned, with the spine straight and extended.
<b>b) Submerged</b> 1. Trunk and head parallel to the surface of the water.  2. 90° angle between the trunk and the extended legs. 3. Water level between knees and ankles of the extended legs.		1. Ears, shoulder joints and hip joints aligned.  2. Legs perpendicular to the surface of the water. Body extended horizontally at 90° angle to the surface of the water.

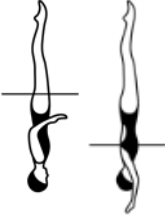
**11.1.6 BP 6 Vertical Position**

Body Position Description	Diagrams	Major Desired Actions
1. Body extended perpendicular to the surface of the water; legs together, head downward.		1. Full extension of the body.
2. Head (ears specifically), hips and ankles in line.		2. Judgement made by checking visual points of the vertical alignment: ears, shoulder joints, hip joints and ankles.

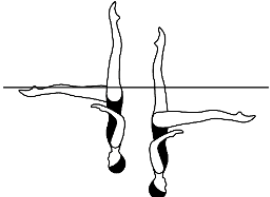

**11.1.7 BP 7 Crane Position - this position is currently not performed in any World Aquatics figure.**

Body Position Description	Diagrams	Major Desired Actions
1. Body extended in <b>Vertical Position</b> with one leg extended forward at a 90° angle to the body.		1. Refer to BP 6 <b>Vertical Position</b> re body alignment. Forward extended leg must be parallel to the surface. Hip joints must be on a horizontal line.

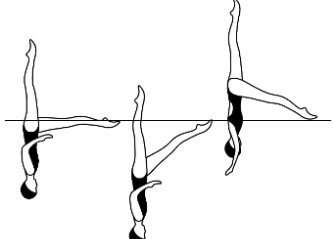

**11.1.8 BP 8 Fishtail Position**

Body Position Description	Diagrams	Major Desired Actions
1. Body extended in <b>Vertical Position</b> with one leg extended forward. The foot of the forward leg is at the surface of the water regardless of the height of the hips.		1. See BP 6 <b>Vertical Position</b> for body alignment. The foot of the forward leg must be at the surface of the water. Hip joints must be on a horizontal line.



**11.1.9 BP 9 Tuck Position**

Body Position Description	Diagrams	Major Desired Actions
1. Body as compact as possible, with the back rounded and the legs together.		1. Legs together with shins at the surface of the water and tucked tightly to the front of the body.
2. Heels close to buttocks.		2. Compact tuck. Chin tucked in.
3. Head close to knees.		3. In BP 9 inverted <b>Tuck Position</b> , shins are perpendicular to the surface of the water, buttocks remain at the surface and the water level is between the ankle and mid foot.

**11.1.10 BP 10 Front Pike Position**

Body Position Description	Diagrams	Major Desired Actions
1. Body bent at hips to form a 90° angle.		1. Exact 90° angle.
2. Legs extended and together.		2. Full extension of legs, with ankles aligned with hip joints.
3. Trunk extended with the back straight and head in line.		3. Back flat, with vertical alignment of ears, shoulder joints and hip joints once the position is established.

**11.1.11 BP 11 Back Pike Position**

Body Position Description	Diagrams	Major Desired Actions
1. Body bent at hips to form an acute angle of 45° or less.		1. Legs close to chest while maintaining the straight-line alignment of the extended spine and head.
2. Legs extended and together.		2. Full extension of the legs, ankles, and feet.
3. Trunk extended with the back straight and head in line.		3. Back flat, with ears, shoulder joints, middle of side of torso, and hip joints aligned. Once the pike position is established the degree of the angle remains constant.

**11.1.12 BP 13 Surface Arch Position**



Body Position Description	Diagrams	Major Desired Actions
1. Lower back arched with hips, shoulders, and head on a vertical line.		1. Hip joints and shoulder joints on a horizontal line with both of these alignments 'square' and parallel to one another. Head (ears specifically) in line with shoulders.
2. Legs together and at the surface of the water.		2. Hip joints at the surface of the water.

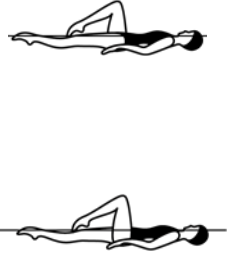

**11.1.13 BP 14 Bent Knee Positions**

Body Position Description	Diagrams	Major Desired Actions
<p>1. Body in <b>Front Layout, Back Layout, Vertical</b>, or <b>Arched Positions</b>.</p> <p>2. One leg bent, with the toe of the bent leg in contact with the inside of the extended leg at the knee or higher.</p>		<p>1. See BP 2, BP 1, BP 6, and BP 13.</p> <p>2. The relationship of the toe of the bent leg to the extended leg may vary depending on the figure but should remain constant once established, and not extend in front of or behind the extended leg.</p>
<b>a) Bent Knee Front Layout Position</b>		<p>1. In BP 2 <b>Front Layout Position</b> the alignment of the extended leg, trunk and head remains constant.</p> <p>2. Once established as in or out of the water, the head position is maintained. When the face is out of the water, the ears will not be on the horizontal axis, and the back may be slightly lower and arched. Hip joints, and the calf and heel of the extended leg remain at the surface of the water.</p>
<b>b) Bent Knee Back Layout Position</b>		<p>1. In BP 1 <b>Back Layout Position</b> ears, shoulder joints, hip joints and ankle of extended leg in line at maximum horizontal alignment.</p> <p>2. 90° angle between the thigh and the surface of the water, and 90° angle maintained between the thigh and the trunk. At maximum height an air pocket will be evident between the back of the thigh and calf of the bent leg and the surface of the water.</p>
<p>1. Body extended in <b>Back Layout Position</b>.</p> <p>2. The thigh of the bent leg is perpendicular to the surface of the water.</p>		

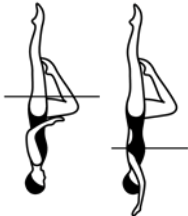

**BP 14 Bent Knee Positions (cont.)**

Body Position Description	Diagrams	Major Desired Actions
<b>c) Bent Knee Vertical Position</b>		1. In BP 6 <b>Vertical Position</b> the alignment of the extended leg, trunk and head remains constant.
<b>d) Bent Knee Surface Arch Position</b>		1.1 In BP 13 <b>Surface Arch Position</b> shoulder joints and hip joints on a horizontal line with both of these alignments 'square' and parallel to one another. Head (ears specifically) in line with shoulders.
2. The thigh of the bent leg is perpendicular to the surface of the water.		1.2 Hips at the surface of the water. 2. 90° angle between the thigh of the bent leg and the surface of the water. An air pocket will be evident between the back of the thigh and calf of the bent leg and the surface of the water.

**11.1.14 BP 15 Tub Position**

Body Position Description	Diagrams	Major Desired Actions
<p>1. Legs bent and together, feet and shins at and parallel to the surface of the water with thighs perpendicular.</p> <p>2. Head in line with trunk.</p> <p>3. Face at the surface of the water.</p>		<p>1. Knees and hip joints aligned vertically with thighs perpendicular to the surface of the water. Legs dry from toes to knees.</p> <p>2. Chest close to the surface of the water, with the shoulders back. Ears, shoulder joints and hip joints aligned, with the spine extended.</p>

**11.1.15 BP 16 Split Position**

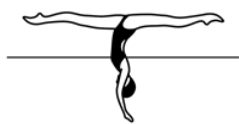
Body Position Description	Diagrams	Major Desired Actions
<p>1. Legs evenly split forward and back.</p> <p>2. The legs are parallel to the surface of the water.</p> <p>3. Lower back arched, with hips, shoulders, and head on a vertical line.</p> <p>4. 180° angle between the extended legs (flat split), with inside of each leg aligned on opposite sides of a horizontal line, regardless of the height of the hips.</p>		<p>1. Full extension of the legs at or above the surface of the water.</p> <p>4. Flat split. Hip joints and shoulder joints on a horizontal line with both of these alignments 'square' and parallel to each other.</p>
<p><b>a) Surface Split Position</b></p> <p>1. Legs are dry at the surface of the water.</p>		<p>1. Full extension of the legs. Crotch and legs dry at the surface of the water.</p>
<p><b>b) Airborne Split Position</b></p> <p>1. Legs are above the surface of the water.</p>		<p>1.1 Full extension of the legs completely above the surface of the water. Maximum height is desirable.</p> <p>1.2 Both legs equidistant from the surface of the water.</p>

**11.1.16 BP 17 Knight Position**

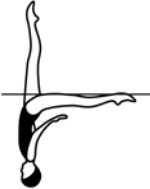
Body Position Description	Diagrams	Major Desired Actions
1. Lower back arched, with hips, shoulders, and head on a vertical line.		1. Arch is in the lower part of the spine only.
2. One leg vertical.		2. Vertical alignment through ears, shoulder joints, hip joints and ankle of the vertical leg.
3. Other leg extended backward with the leg at the surface of the water and as close to horizontal as possible.		3. Hip joints and shoulder joints on a horizontal line with both of these alignments 'square' and parallel to each other. The top of the horizontal extended leg faces upward.

**11.1.17 BP 18 Knight Variant Position**

Body Position Description	Diagrams	Major Desired Actions
1. Lower back arched, with hips, shoulders, and head on a vertical line.		1. Arch is in the lower part of the spine only.
2. One leg vertical.		2. Vertical alignment through ears, shoulder joints, hip joints and ankle of the vertical leg.
3. The other leg is behind the body with the knee bent at an angle of 90° or less.		3. Hip joints and shoulder joints on a horizontal line with both of these alignments 'square' and parallel to each other. The top of the horizontal extended leg faces upward.
4. The thigh and shin of the bent leg are parallel to the surface of the water.		4. The inside of the bent leg faces upward and is at or near the surface of the water.

**11.1.18 BP 19 Side Fishtail Position**

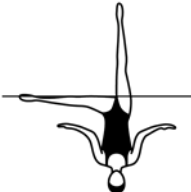

Body Position Description	Diagrams	Major Desired Actions
<p>1. Body extended in <b>Vertical Position</b> with one leg extended sideways with the foot at the surface of the water regardless of the height of the hips.</p>		<p>1. BP 6 <b>Vertical Position</b> alignment must be evident from a front or back view of the extended body. The head, trunk, and extended leg face forward.</p>

## 11.2 ANALYSIS OF BASIC MOVEMENTS



The below table includes a list of Basic Movements in Artistic Swimming, detailed description of which is included in the subsequent sections.

BM #	BM Type	BM #	BM Type
BM 1	<i>To Assume a Ballet Leg</i>	BM 10	<i>Vertical Descent</i>
BM 2	<i>To Lower a Ballet Leg</i>	BM 11	<i>Rocket Split</i>
BM 3	<i>To Assume a Front Pike Position</i>	BM 12	<i>Twists</i>
BM 4	<i>To Assume a Submerged Ballet Leg Double Position from a Front Pike Position</i>	BM 13	<i>Spins</i>
BM 5	<i>Arch to Back Layout Position</i>	BM 14	<i>To Assume a Surface Arch Position</i>
BM 6	<i>Walkouts</i>	BM 15	<i>To Assume a Bent Knee Surface Arch Position</i>
BM 7	<i>Catalina Rotation</i>	BM 16	<i>Ariana Rotation</i>
BM 8	<i>Catalina Reverse Rotation</i>	BM 17	<i>Helicopter Rotation</i>
BM 9	<i>Thrust</i>	BM 18	<i>Fouetté Rotation</i>



### 11.2.1 BM 1 To Assume a Ballet Leg/A Ballet Leg is assumed

Basic Movement Description	NVT	Diagrams	Major Desired Actions
<p>1. Begin in a <b>Back Layout Position</b>. One leg remains at the surface of the water throughout.</p>			1. See BP 1 <b>Back Layout Position</b> .
<p>2. The foot of the other leg is drawn along the inside of the extended leg to assume a <b>Bent Knee Back Layout Position</b>.</p>	10.5		2. See BP 14b <b>Bent Knee Back Layout Position</b> . The toe of the bending leg remains in contact with the inside of the extended leg. Minimal drop in hips. Position held only long enough to demonstrate control and accuracy.
<p>3. The bent leg is straightened without movement of the thigh to assume a <b>Ballet Leg Position</b>.</p>	11.0		3.1 See BP 3a <b>Surface Ballet Leg Position</b> . Height remains constant throughout the movement. 3.2 The head and trunk remain stationary throughout.

**BM 1B To Assume a Straight Ballet Leg/ A Straight Ballet Leg is assumed**

Basic Movement Description	NVT	Diagrams	Major Desired Actions
1. From a Back Layout Position one leg is raised straight to a Ballet Leg Position.			1.1 See BP 1 <b>Back Layout Position</b> . Ears, shoulder joints, hip joints and ankles of extended legs at maximum horizontal alignment.
	18.5		1.2 One leg is raised straight to BP 3a <b>Surface Ballet Leg Position</b> while keeping the horizontal alignment of the horizontal leg and trunk with minimal drop of the hips. 1.3 The head and trunk remain stationary throughout.

**11.2.2 BM 2 To Lower a Ballet Leg/The Ballet Leg is lowered**

Basic Movement Description	NVT	Diagrams	Major Desired Actions
1. From a <b>Ballet Leg Position</b> the ballet leg is bent without movement of the thigh to a <b>Bent Knee Back Layout Position</b> .			1.1 See BP 3a <b>Surface Ballet Leg Position</b> and BP 14b <b>Bent Knee Back Layout Position</b> . Height remains constant throughout the movement.
2. The toe moves along the inside of the extended leg until a <b>Back Layout Position</b> is assumed.	11.0		2.1 Full extension in BP 1 <b>Back Layout Position</b> to be achieved as the feet are joined.
	10.5		2.2 The head and trunk remain stationary throughout.

**11.2.3 BM 3 To Assume a Front Pike Position/A Front Pike Position is assumed**

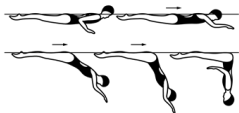
Basic Movement Description	NVT	Diagrams	Major Desired Actions
<p>1. From a <b>Front Layout Position</b> with the face in the water the trunk moves downward to assume a <b>Front Pike Position</b>. The buttocks, legs and feet travel along the surface of the water until the hips occupy the position of the head at the beginning of this action.</p>	6.0		<p>1.1 See BP 2 <b>Front Layout Position</b> and BP 10 <b>Front Pike Position</b>. Uniform motion in downward movement of the trunk. The trunk remains straight throughout the movement. Hips and head lock into position simultaneously.</p> <p>1.2 Unless otherwise specified, <i>To Assume a Front Pike Position</i> starts from a <b>Front Layout Position</b>.</p>

**11.2.4 BM 4 To Assume a Submerged Ballet Leg Double Position from a Front Pike Position/A Submerged Ballet Leg Double Position is assumed**

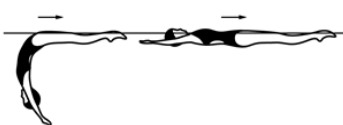

Basic Movement Description	NVT	Diagrams	Major Desired Actions
<p>1. While maintaining a <b>Front Pike Position</b> the body somersaults forward around a lateral axis as the buttocks, legs and feet move downward. The hips replace the head to assume a <b>Submerged Ballet Leg Double Position</b>.</p>	8.0		<p>1.1 See BP 10 <b>Front Pike Position</b> and BP 5b <b>Submerged Ballet Leg Double Position</b>. 90° angle between the trunk and the legs maintained throughout the rotation.</p> <p>1.2 Body alignment and extension maintained throughout.</p>

**11.2.5 BM 5 Arch to Back Layout Position**



Basic Movement Description	NVT	Diagrams	Major Desired Actions
<p>1. From a <b>Surface Arch Position</b> the hips, chest, and face surface sequentially at the same point with foot first movement to a <b>Back Layout Position</b> until the head occupies the position of the hips at the beginning of this action.</p>	7.0		<p>1. See BP 13 <b>Surface Arch Position</b>. Sharp arch in lower back. The body straightens, rises, and moves along the surface of the water with a stationary BP 1 <b>Back Layout Position</b> achieved as the face surfaces. Full extension maintained throughout.</p>





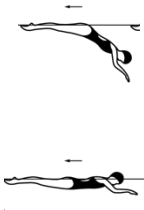

**11.2.6 BM 6 Walkouts**

Basic Movement Description	NVT	Diagrams	Major Desired Actions
<p>1. These movements start in a <b>Split Position</b> unless otherwise specified in the figure description. The hips remain stationary as one leg is lifted in an arc over the surface of the water to meet the opposite leg.</p>			<p>1. See BP 16a <b>Surface Split Position</b>.</p>
<p><b>a) Walkout Front</b></p> <p>2. The front leg is lifted in a 180° arc over the surface of the water to meet the opposite leg in a <b>Surface Arch Position</b> and with continuous movement an <i>Arch to Back Layout Position</i> is executed.</p>	23.0		<p>2.1 Hip height remains constant and at the surface of the water.</p> <p>2.2 Arcing leg moves continuously with uniform motion.</p> <p>2.3 Both legs maintain full extension.</p> <p>2.4 The trunk remains stationary until the feet join.</p> <p>2.5 No pause in BP 13 <b>Surface Arch Position</b>, however an accurate surface arch must be evident before the body begins to rise and straighten.</p> <p>2.6 Foot first surfacing motion begins when the feet are joined.</p> <p>2.7 See BP 13 <b>Surface Arch Position</b> and BM 5 <i>Arch to Back Layout Position</i>.</p>
	7.0		



**BM 6 Walkouts (cont.)**

Basic Movement Description	NVT	Diagrams	Major Desired Actions
<p>1. These movements start in a <b>Split Position</b> unless otherwise specified in the figure description. The hips remain stationary as one leg is lifted in an arc over the surface of the water to meet the opposite leg.</p>			<p>1. See BP 16a <b>Surface Split Position</b>.</p>
<p><b>b) Walkout Back</b></p>	19.0		<p>3.1 Hip height remains constant and at the surface of the water.</p> <p>3.2 Arcing leg moves continuously with uniform motion.</p> <p>3.3 Both legs maintain full extension.</p> <p>3.4 The trunk remains stationary until the feet join.</p> <p>3.5 An accurate BP 10 <b>Front Pike Position</b> should be evident before the body begins to straighten and rise. See BP 10 <b>Front Pike</b> and BP 2 <b>Front Layout Position</b>.</p>
<p>4. The head surfaces at the position occupied by the hips at the beginning of this action.</p>	6.0		<p>4. The body straightens, rises, and moves along the surface simultaneously with a stationary BP 2 <b>Front Layout Position</b> achieved as the head surfaces.</p>

**11.2.7 BM 7 Catalina Rotation**

Basic Movement Description	NVT	Diagrams	Major Desired Actions
1. From a <b>Ballet Leg Position</b> a rotation of the body is initiated.	24.0		1. See BP 3 <b>Ballet Leg Position</b> .
2. The head, shoulders and trunk begin the rotation at the surface of the water while descending without lateral movement to a <b>Fishtail Position</b> .		 	<p>2.1 Rotation begins no later than when the nose goes beneath the surface of the water.</p> <p>2.2 Simultaneous rotation and descent of the trunk along the vertical line established by the vertical leg.</p> <p>2.3 At the halfway point, the body is in a tilted 'Y' position, with the trunk at a 45° angle to the surface of the water, and the head, trunk and legs face forward.</p> <p>2.4 Height and uniform motion throughout.</p> <p>2.5 See BP 8 <b>Fishtail Position</b>.</p>
3. The vertical leg remains perpendicular to the surface of the water while the foot of the horizontal leg remains at the surface of the water throughout the rotation. Unless otherwise specified, <i>Catalina Rotation</i> starts from a <b>Ballet Leg Position</b> .			3. Each leg rotates around its respective horizontal or vertical axis, simultaneously throughout the rotation of the descending trunk.

**11.2.8 BM 8 Catalina Reverse Rotation**

Basic Movement Description	NVT	Diagrams	Major Desired Actions
1. From a <b>Fishtail Position</b> the hips rotate as the trunk rises without lateral movement to assume a <b>Ballet Leg Position</b> .	24.0		1.1 See BP 8 <b>Fishtail</b> and BP 3a <b>Surface Ballet Leg Positions</b> . 1.2 Height maintained and uniform motion throughout. 1.3 The body rotates and rises simultaneously along the vertical line established by the vertical leg. 1.4 The transition is completed as the face surfaces and the body locks into BP 3a <b>Surface Ballet Leg Position</b> . 1.5 At the halfway point, the body is in a tilted 'Y' position, with the trunk at a 45° angle to the surface of the water and the head, trunk and legs face forward.
2. The vertical leg remains perpendicular to the surface of the water while the foot of the horizontal leg remains at the surface of the water throughout the rotation.			2. Each leg rotates around its respective horizontal or vertical axis simultaneously throughout the rotation of the ascending trunk.

**11.2.9 BM 9 Thrust**

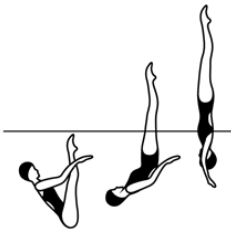
Basic Movement Description	NVT	Diagrams	Major Desired Actions
<p>1. From a Submerged <b>Back Pike Position</b> with the legs perpendicular to the surface of the water a vertical upward movement of the legs and hips is rapidly executed as the body unrolls to assume a <b>Vertical Position</b>.</p> <p>2. Maximum height desirable.</p>	31.0		<p>1.1 See BP 11 <b>Back Pike Position</b>. The toes are just below the surface of the water. Once established, the degree of the angle of the pike position between the legs and the body must not change prior to initiation of the <i>Thrust</i>.</p> <p>1.2 See BP 6 <b>Vertical Position</b>. The body unrolls rapidly under the legs to assume BP 6 <b>Vertical Position</b> along the same perpendicular line to the surface of the water established by the legs in the BP 11 <b>Back Pike Position</b>.</p> <p>1.3 Obvious increase in speed from the initiation of body unrolling through the vertical upward movement.</p> <p>2. Maximum height and BP 6 <b>Vertical Position</b> achieved simultaneously.</p>

**Thrust Allowance**

Deviation allowances for the *Thrust* action are unique and allow for the legs to be up to an additional 15° off the vertical line. Deductions are as follows:



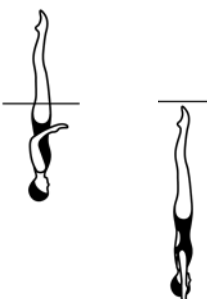

Deviation Type	Angle Deviation	Deduction Amount
Small Deviation	16° – 30°	.2
Medium Deviation	31° – 45°	.5
Large Deviation	More than 45°	1.0

**11.2.10 BM 10 Vertical Descent**

Basic Movement Description	NVT	Diagrams	Major Desired Actions
1. Maintaining a <b>Vertical Position</b> the body descends along its longitudinal axis until the toes are submerged.	14.0		1. See BP 6 <b>Vertical Position</b> . Unless otherwise stated, the tempo of the descent is uniform and at the same speed as the rest of the figure.

Clarification: If the athlete clearly and purposefully tucks from ankles (or above ankles) in a *Vertical Descent* this would be an incomplete Basic Movement resulting in a zero (0). If the athlete is making an attempt to submerge in the Vertical Position and the position collapses at the very end of the movement this can be considered a deduction.

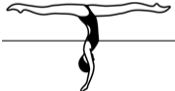
**11.2.11 BM 11 Rocket Split**

Basic Movement Description	NVT	Diagrams	Major Desired Actions
1. A <i>Thrust</i> is executed to a <b>Vertical Position</b> . Maintaining maximum height, the legs are split simultaneously and rapidly to assume an <b>Airborne Split Position</b> and re-join to a <b>Vertical Position</b> , followed by a <i>Vertical Descent</i> .	31.0		1.1 See BM 9 <i>Thrust</i> (steps 1.1 to 2), BP 11 <b>Back Pike Position</b> , BP 6 <b>Vertical Position</b> , BP16b <b>Airborne Split Position</b> .
			1.2 The toes are just below the surface of the water.
	17.0		1.3 Full extension of the legs above and parallel to the surface of the water.
	13.0		1.4 The legs split evenly and re-join in the same vertical line. No travel permitted.
2. The <i>Vertical Descent</i> is executed at the same tempo as the <i>Thrust</i> .	13.0		2. See BM 10 <i>Vertical Descent</i> .

**11.2.12 BM 12 Twists**

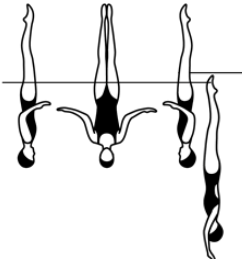
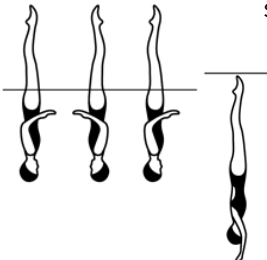
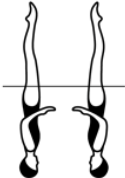
Basic Movement Description	NVT	Diagrams	Major Desired Actions
1. A <i>Twist</i> is a rotation at a sustained height.			1. Height remains constant throughout the rotation. Stability and alignment of the position is evident before, during and upon completion of the <i>Twist</i> . The amount of height is judged by the relationship of the hip joints to the surface of the water with maximum height desirable.
2. The body remains on its longitudinal axis throughout the rotation.			2. The longitudinal axis runs through the centre of the body and is perpendicular to the surface of the water. On the spot rotation around this axis.
3. Unless otherwise specified when performed in a <b>Vertical Position</b> a <i>Twist</i> is completed with a <i>Vertical Descent</i> .			3. See BM 10 <i>Vertical Descent</i> . Unless otherwise specified the speed of the descent is the same as that of the root figure.
4.			See <i>Twist Allowance</i> .
<b>a) Half Twist:</b> a <i>Twist</i> of 180°.	21.0		
<b>b) Full Twist:</b> a <i>Twist</i> of 360°.	32.0		See <i>Twist allowance</i> .
<b>c) A Twirl:</b> a rapid <i>Twist</i> of 180°.	26.0		See <i>Twist allowance</i> . 4. c) Definite increase in speed from the root figure. Stability of body alignment and height remains constant during and after completion of the <i>Twirl</i> .

**Twist Allowance**

The acceptable allowance for *Twist* rotations (*Half Twist*, *Full Twist* and *Twirl*) is up to ¼ less than/more than the required rotation.

Clarification for non-*Twist* or *Twirl* rotations (rotating maintaining the same height): rotations performed at a sustained height not described as a *Twist* or a *Twirl* have an allowance of 90° more or less than the designated degrees of rotation.

**11.2.13 BM 13 Spins**

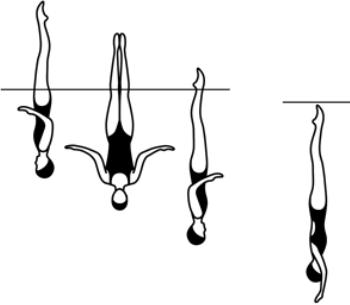
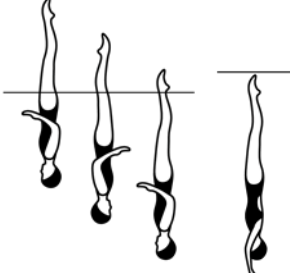

Basic Movement Description	NVT	Diagrams	Major Desired Actions
<p>1. A <i>Spin</i> is a rotation in a <b>Vertical Position</b>.</p> <p>2. The body remains on its longitudinal axis throughout the rotation.</p> <p>3. Unless otherwise specified <i>Spins</i> are executed in uniform motion and are completed with a <i>Vertical Descent</i> executed at the same tempo as the <i>Spin</i>.</p> <p>4. A <i>descending Spin</i> must start at the height of the vertical and be completed as the ankle(s) reach(es) the surface of the water. Unless otherwise specified a <i>descending Spin</i> is completed with a <i>Vertical Descent</i> which is executed at the same tempo as the <i>Spin</i>.</p>			<p>1. See BP 6 <b>Vertical Position</b>. Height and position attained before the <i>Spin</i> begins.</p> <p>2. The longitudinal axis runs through the centre of the body and is perpendicular to the surface of the water.</p> <p>3. Uniform motion of the <i>Spin</i> and <i>Vertical Descent</i> to be at the same tempo as the root figure unless otherwise specified.</p> <p>See BM 10 <i>Vertical Descent</i>.</p> <p>4.1 Stability and vertical alignment before, during and at completion of the designated rotation.</p> <p>4.2 Simultaneous rotation and descent of the body with even drop spaces to complete the spin as the ankles reach the surface of the water.</p>
<p>5. <b>d) 180° Spin/Spinning 180°:</b> a <i>descending Spin</i> with a rotation of 180°.</p>	<p>16.0 (stable) 24.0 (unstable-rapid)</p>		<p>See <i>Spin</i> Allowance.</p>
<p><b>e) 360° Spin/Spinning 360°:</b> a <i>descending Spin</i> with a rotation of 360°.</p>	<p>19.0 (stable) 39.0 (unstable-rapid)</p>		<p>See <i>Spin</i> Allowance.</p>

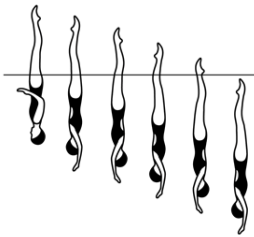
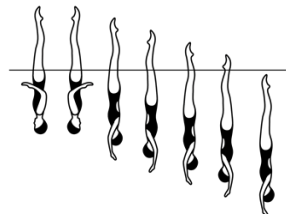

**BM 13 Spins (cont.)**

Basic Movement Description	NVT	Diagrams	Major Desired Actions
<p>5.</p> <p><b>f) Continuous Spin.</b> a <i>descending Spin</i> with a rapid rotation of 720° (2), 1080° (3), or 1440° (4) which is completed as the ankles reach the surface of the water and continues through submergence.</p> <p><i>Continuous Spin 720° shown →</i></p>	34.0 (720°) (rapid) 67.0 (720°) (rapid-unstable) 49.0 (1080°) (rapid) 60.0 (1440°) (rapid)		<p>See <i>Spin Allowance</i>.</p> <p>5 f) A <i>Continuous Spin</i> must achieve and maintain a rapid rotation throughout.</p>
<p><b>g) Twist Spin.</b> A <i>Half Twist</i> is executed and without a pause is followed by a <i>Continuous Spin</i> of 720° (2) performed in the same direction as the <i>Half Twist</i>.</p>	48.0		<p>See <i>Spin Allowance</i>.</p> <p>5 g) In a <i>Twist Spin</i>, the BM 12a <i>Half Twist</i> is performed at the same tempo as the root figure. The <i>Continuous Spin</i> must be performed rapidly and in the same direction as the <i>Half Twist</i>. See BM 12a <i>Half Twist</i> and BM13 f <i>Continuous Spin</i>.</p>
<p>6. An <i>ascending Spin</i> begins with the water level at the ankles unless otherwise specified.</p>	20.0 (Asc. 180°) 21.0 (Asc. Rpd 180°) 21.0 (Asc. 360°)		<p>See <i>Spin Allowance</i>.</p> <p>6.1 Body rises and rotates simultaneously, evenly and at the same tempo as the root figure unless otherwise specified.</p> <p>6.2 The designated rotation is completed simultaneously with achievement of maximum height.</p> <p>6.3 Stability and vertical alignment maintained before, during and at completion of the designated rotation. Refer to BM 6 <b>Vertical Position</b> evident prior to <i>Vertical Descent</i>.</p>
<p>7. A vertical upward <i>Spin</i> is executed until a water level is established between the knees and hips.</p>			<p>8. See BM10 <i>Vertical Descent</i>. Speed of descent is the same as that specified in the root figure, unless otherwise specified.</p>
<p>8. An <i>ascending Spin</i> is finished with a <i>Vertical Descent</i>.</p>			

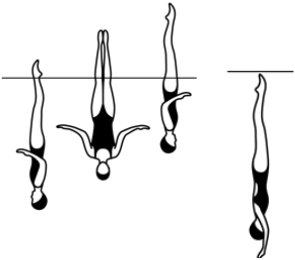
**BM 13 Spins (cont.)**

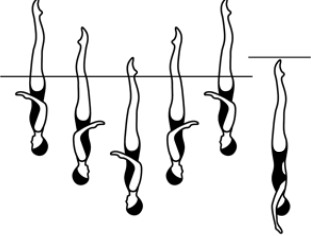
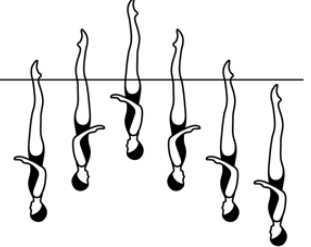
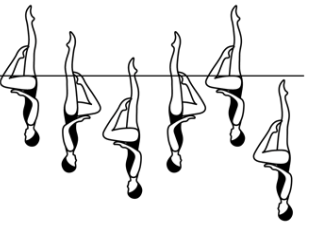
Basic Movement Description	NVT	Diagrams	Major Desired Actions
9.			See <i>Spin Allowance</i> .
<b>h) Spin Up 180°:</b> an <i>ascending Spin</i> with a rotation of 180°.	18.0 14.0		
<b>i) Spin Up 360°:</b> an <i>ascending Spin</i> with a rotation of 360°.	19.0 14.0		See <i>Spin Allowance</i> .
<b>j) Combined Spin:</b> a <i>descending Spin</i> of at least 360° followed without a pause by an equal <i>ascending Spin</i> in the same direction. The <i>ascending Spin</i> reaches the same height where the <i>descending Spin</i> started.	38.0 14.0		See requirements for <i>ascending</i> and <i>descending Spins</i> , with uniform motion at the tempo specified in the figure description.
<b>k) Reverse Combined Spin:</b> an <i>ascending Spin</i> of at least 360° followed without a pause by an equal <i>descending Spin</i> in the same direction.	38.0		See requirements for <i>ascending</i> and <i>descending Spins</i> , with uniform motion at the tempo specified in the figure description.
<b>l) Bent Knee Combined Spin:</b> a <i>descending Spin</i> in a <b>Bent Knee Vertical Position</b> of at least 360° followed without a pause by an equal <i>ascending Spin</i> in the same direction in a <b>Bent Knee Vertical Position</b> . The <i>ascending Spin</i> reaches the same height where the <i>descending Spin</i> started.	30.0 10.0		See requirements for <i>ascending</i> and <i>descending Spins</i> , with uniform motion at the tempo specified in the figure description.

**BM 13 Spins (cont.)**

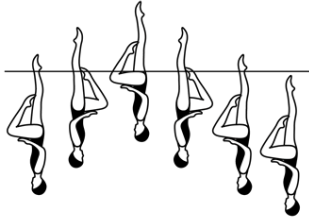
Basic Movement Description	NVT	Diagrams	Major Desired Actions
<p><b>9 m) Reverse Bent Knee Combined Spin:</b> an ascending Spin in a <b>Bent Knee Vertical Position</b> of at least 360° followed without a pause by an equal descending Spin in the same direction in a <b>Bent Knee Vertical Position</b>.</p>	30.0		See requirements for ascending and descending Spins, with uniform motion at the tempo specified in the figure description.



**Spins Allowance**

1. The acceptable allowance for a *Continuous Spin* is up to 180° less than/more than the required rotation.
2. The acceptable allowance for other *Spins* (180° Spin, 360° Spin, 720° Spin, Twist Spin, Spin Up 180°, Spin Up 360°) is up to ¼ less than/more than the required rotation.



Clarification on NVT: *Descending Spins'* NVT include the *Vertical Descent* value. The draws showing ankle level before submersion are to indicate the water level to meet after the required rotation. Consequently, the drawings in the boxes showing the descent portion from ankles to submerged descent indicate NVT O.

Clarification on Vertical Descent: If the athlete clearly and purposefully tucks from ankles (or above ankles) in a *Vertical Decent* this would be an incomplete Basic Movement resulting in a zero (O). If the athlete is making an attempt to submerge in the Vertical Position and the position collapses at the very end of the movement this can be considered a deduction.

**11.2.14 BM 14 To Assume a Surface Arch Position/A Surface Arch Position is Assumed**

Basic Movement Description	NVT	Diagrams	Major Desired Actions
<p>1. From a <b>Back Layout Position</b> with the head leading, the head, hips and feet move along the surface of the water.</p>			1. See BP 1 Back Layout Position.
<p>2. With continuous movement the head leaves the surface of the water as the back is arched more to assume a <b>Surface Arch Position</b> with the hips occupying the position of the head at the beginning of this action.</p>	12.0		2. Continuous uniform movement from the BP 1 <b>Back Layout Position</b> to BP 13 <b>Surface Arch Position</b> . Hip height remains constant. Hip joints on a horizontal line.

**11.2.15 BM 15 To Assume a Bent Knee Surface Arch Position/A Bent Knee Surface Arch is Assumed**

Basic Movement Description	NVT	Diagrams	Major Desired Actions
<p>1. From a <b>Back Layout Position</b> with the head leading, the head, hips and feet move along the surface of the water.</p>			<p>1. See BP 1 <b>Back Layout Position</b>.</p>
<p>2. With continuous movement the head leaves the surface of the water as the back is arched more to assume a <b>Bent Knee Surface Arch Position</b> with the hips occupying the position of the head at the beginning of this action.</p>	17.5		<p>2.1 Continuous uniform movement from the BP 1 <b>Back Layout Position</b> to BP 14d <b>Bent Knee Surface Arch Position</b>. Hip height remains constant. Hip joints on a horizontal line.</p> <p>2.2 The toe of the bent leg must remain in contact with the inside of the extended leg while assuming the <b>Bent Knee Surface Arch Position</b>.</p>

**11.2.16 BM 16 Ariana Rotation**

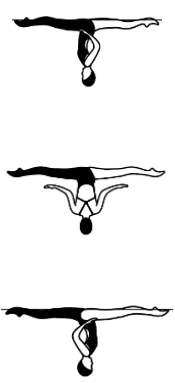
Basic Movement Description	NVT	Diagrams	Major Desired Actions
<p>1. From a <b>Split Position</b> maintaining the relative position of the legs to the surface of the water the hips rotate 180°.</p>	17.0		<p>1.1 See BP 16a <b>Surface Split Position</b>.</p> <p>1.2 The trunk turns 180° around its longitudinal axis, while the legs rotate with no lateral movement at the surface of the water.</p> <p>1.3 Height and extension of the <b>Split Position</b> is maintained throughout.</p> <p>1.4 Uniform motion throughout.</p> <p>1.5 Lower back arched with hips, shoulders, and head on a vertical line.</p> <p>1.6 Hip joints and shoulder joints on a horizontal line with both alignments 'square' and parallel to each other.</p>

**11.2.17 BM 17 Helicopter Rotation**

Basic Movement Description	NVT	Diagrams	Major Desired Actions
<p>1. From a <b>Fishtail Position</b> the horizontal leg is lifted while closing into the vertical leg to assume a <b>Vertical Position</b> during a descending rotation and is completed as the ankles reach the surface of the water.</p>			<p>1.1 See BP 8 <b>Fishtail Position</b>. The legs are joined while descending and rotating to assume a BP 6 <b>Vertical Position</b> at ankle level. This position is reached as the legs are joined and the rotation is completed.</p> <p>1.2 The vertical leg maintains the vertical line throughout the rotation.</p> <p>1.3 Longitudinal axis is maintained throughout the rotation.</p> <p>1.4 Unless otherwise specified, the tempo of the rotation and descent is uniform and at the same speed as the root figure.</p> <p>1.5 Refer to Section BM 13 <i>Spins</i> and <i>Spin Allowances</i>.</p>

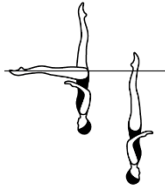
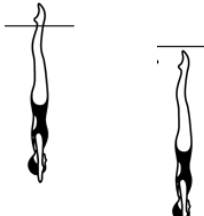
Basic Movement Description	NVT	Diagrams	Major Desired Actions
<p><b>a) Spinning 180°</b></p> <p>1. <b>Spinning 180°</b>: A descending <i>Spin</i> with a rotation of 180°.</p>	12.5		<p>1. Refer to BM 17 <i>Helicopter Rotation</i> Step 1 Major Desired Actions.</p>
<p>2. Maintaining a <b>Vertical Position</b> the body descends along its longitudinal axis until the toes are submerged.</p>	0		<p>2. See BP 6 <b>Vertical Position</b> and BM 10 <i>Vertical Descent</i>. The tempo of the descent is uniform and at the same speed as the rest of the figure.</p>

**BM 17 Helicopter Rotation (cont.)**

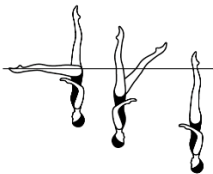
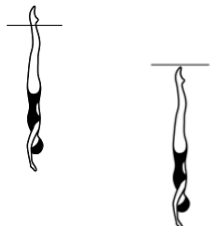
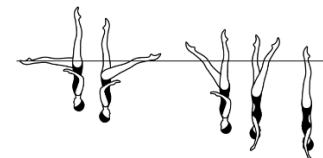
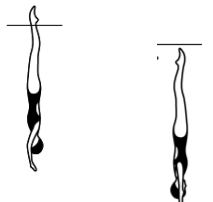
Basic Movement Description	NVT	Diagrams	Major Desired Actions
<b>b) Spinning 360°</b>			
1. <i>Spinning 360°</i> : A <i>descending Spin</i> with a rotation of 360°.	17.5		1. Refer to BM 17 <i>Helicopter Rotation</i> Step 1 Major Desired Actions.
2. Maintaining a <b>Vertical Position</b> the body descends along its longitudinal axis until the toes are submerged.	0		2. See BP 6 <b>Vertical Position</b> and BM 10 <i>Vertical Descent</i> . The tempo of the descent is uniform and at the same speed as the rest of the figure.
<b>c) Continuous Spin 720°</b>			
1. <b>Continuous Spin 720°</b> : a <i>descending Spin</i> with a rapid rotation of 720° (2 rotations), completed as the ankles reach the surface of the water and continues through submergence.	29.5		1. Refer to BM 17 <i>Helicopter Rotation</i> Step 1 Major Desired Actions.
2. Maintaining a <b>Vertical Position</b> the body continues its rotation and descends along its longitudinal axis until the toes are submerged.	0		2. See BP 6 <b>Vertical Position</b> and BM 10 <i>Vertical Descent</i> . The <i>Vertical Descent</i> is performed rapidly.

**BM 17 Helicopter Rotation (cont.)**

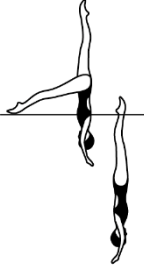
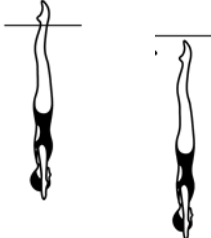
Basic Movement Description	NVT	Diagrams	Major Desired Actions
<b>d) Rapid Airborne Spinning 180°</b>			
<p>1. <b>Rapid Airborne Spinning 180°</b> from an airborne <b>Fishtail Position</b> the horizontal leg is rapidly lifted while closing into the vertical leg to a <b>Vertical Position</b> during a rapid <i>descending Spin</i> with a rotation of 180° and is completed as the ankles reach the surface of the water.</p>	17.5		<p>1.1 See BP 8 airborne <b>Fishtail Position</b>. The legs are rapidly joined while rapidly descending and rotating to assume a BP 6 <b>Vertical Position</b> at ankle level. This position is reached as the legs are joined and the rotation is completed.</p> <p>1.2 The vertical leg maintains the vertical line throughout the rotation.</p> <p>1.3 Longitudinal axis is maintained throughout the rotation.</p> <p>1.4 Refer to Section BM 13 <i>Spins</i> and <i>Spin</i> allowances.</p>
<p>2. Maintaining a <b>Vertical Position</b> the body rapidly descends along its longitudinal axis until the toes are submerged.</p>	0		<p>2. See BP 6 <b>Vertical Position</b> and BM 10 <i>Vertical Descent</i>. The <i>Vertical Descent</i> is performed rapidly.</p>

**11.2.18 BM 18 Fouetté Rotation**

Basic Movement Description	NVT	Diagrams	Major Desired Actions
<p><b>Fouetté Rotation</b></p> <p>1. From a <b>Fishtail Position</b> with the horizontal leg leading toward the vertical leg a rapid 180° rotation is executed as the front leg bends to assume a <b>Bent Knee Vertical Position</b>. The bent leg rapidly extends to a <b>Fishtail Position</b>.</p>	19.0		<p>1.1 A rapid rotation of 180° and simultaneous bending of the horizontal leg to assume a BP 14c <b>Bent Knee Vertical Position</b>.</p> <p>1.2 The bent leg rapidly extends to a BP 8 <b>Fishtail Position</b>.</p> <p>The water level remains constant throughout.</p> <p>1.4 Vertical alignment of the vertical leg and trunk maintained throughout.</p> <p>1.5 Stability and control evident.</p> <p>1.6 Rapid uniform motion throughout.</p> <p>1.7 Longitudinal axis maintained throughout the rotation.</p> <p>1.8 Rotation allowances as in BM 12 <i>Twists</i>.</p>



**11.3 ANALYSIS OF YOUTH WORLD AQUATICS FIGURES 2022-2025**

Section	Group	Figure Number	Figure Name	DD
<b>A</b>	<b>1</b>	140g	Flamingo Bent Knee, Twist Spin	2.9
		437	Cyclone, Open 180°	2.6
	<b>2</b>	308h	Barracuda Airborne Split Spin Up 180°	2.9
		407	Swordfish Straight Leg Ariana Rotation	2.6
<b>B</b>	<b>3</b>	356f	Whip Continuous Spin 720°	3.0
		441	Saturn	2.5
	<b>4</b>	352	Venus	3.0
		240i	Albatross Spin up 360°	2.5
<b>C</b>	<b>5</b>	144	Rio Straight Leg	3.1
		421	Walkover Back Closing 360°	2.4
	<b>6</b>	440d	Ipanema Spinning 180°	3.1
		311j	Kip Combined Spin	2.4

**11.3.1 Figure – 140g FLAMINGO BENT KNEE TWIST SPIN DIFFICULTY – 2.9**

A *Ballet Leg* is assumed. The shin of the horizontal leg is drawn along the surface of the water to assume a **Surface Flamingo Position**. With the ballet leg maintaining its vertical position the hips are lifted as the trunk unrolls while the bent leg moves to a **Bent Knee Vertical Position**. The bent leg is extended to a **Vertical Position**. A *Twist Spin* is executed.









								Total
NVT=	10.5	11.0	7.5	20.0	16.5	48.0		113.5
PV =	0.93	0.97	0.66	1.76	1.45	4.23		10

Figure Description	NVT	Diagrams	Major Desired Actions
--------------------	-----	----------	-----------------------

1. A *Ballet Leg* is assumed.



1. See BM 1 To Assume a *Ballet Leg*.

10.5



1. See BM 1 To Assume a *Ballet Leg*.

11.0



2. The shin of the horizontal leg is drawn along the surface of the water to assume a **Surface Flamingo Position**.

7.5



2. See BP 4a **Surface Flamingo Position**. Height of the ballet leg remains constant.

3. With the ballet leg maintaining its vertical position, the hips are lifted as the trunk unrolls while the bent leg moves to a **Bent Knee Vertical Position**.

20.0

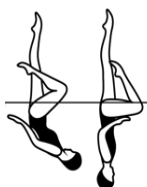



3.1 See BP 14c **Bent Knee Vertical Position**. The bent leg moves simultaneously to the **Bent Knee Vertical Position** as the hips are lifted and the trunk unrolls.

3.2 The vertical leg remains perpendicular to the surface of the water.

3.3 All actions are simultaneously completed as maximum height is achieved.

3.4 The **Bent Knee Vertical Position** is assumed under, and in the same plane as the ballet leg of the BP 4a **Surface Flamingo Position**.

**Figure – 140g FLAMINGO BENT KNEE TWIST SPIN (cont.)**
**DIFFICULTY – 2.9**

Figure Description	NVT	Diagrams	Major Desired Actions
4. The bent leg is extended to <b>Vertical Position</b> .	16.5		<p>4.1 BP 6 <b>Vertical Position</b> assumed under and in the same plane as the <b>Bent Knee Vertical Position</b>. The height of the <b>Bent Knee Vertical Position</b> is maintained as the bent leg is extended to <b>Vertical Position</b>.</p> <p>4.2 Vertical alignment is maintained during the leg join. Stability and control evident throughout.</p> <p>4.3 The <b>Vertical Position</b> is held only long enough to define the position and to demonstrate completion of the transition prior to the <i>Twist Spin</i>.</p>
5. A <i>Twist Spin</i> is executed.	48.0	 	<p>5. See BM 13g <i>Twist Spin</i>, BM12a <i>Half Twist</i> and BM13f <i>Continuous Spin</i>.</p> <p>A <i>Half Twist</i> is executed and without a pause is followed by a <i>Continuous Spin</i> of 720° (2 rotations) performed in the same direction as the <i>Half Twist</i>.</p> <p>In a <i>Twist Spin</i>, the BM 12a <i>Half Twist</i> is performed at the same tempo as the root figure. The <i>Continuous Spin</i> must be performed rapidly and in the same direction as the <i>Half Twist</i>. See BM 12a <i>Half Twist</i> and BM13f <i>Continuous Spin</i>.</p>

**BP 1 Back Layout Position**

Body Position Description	Diagrams	Major Desired Actions
1. Body extended with face, chest, thighs, and feet at the surface of the water.		1. Gives the impression that the body is stretched horizontally to its maximum. Front of the trunk will also be at the surface of the water.

**Figure – 140g FLAMINGO BENT KNEE TWIST SPIN (cont.)**
**DIFFICULTY – 2.9**
**BP 1 Back Layout Position (cont.)**

Body Position Description	Diagrams	Major Desired Actions
2. Head (ears specifically), hips and ankles in horizontal alignment.		2. Judgement is made by checking visual points of the horizontal alignment: ears, shoulder joints, hip joints and ankles. This imaginary line should also pass through the middle of the side of the trunk.

**BP 14 Bent Knee Positions**

Body Position Description	Diagrams	Major Desired Actions
One leg bent with the toe of the bent leg in contact with the inside of the extended leg at the knee or higher.		The relationship of the toe of the bent leg to the extended leg may vary depending on the figure but should remain constant once established, and not extend in front of or behind the extended leg.

**b) Bent Knee Back Layout Position**

1. Body extended in **Back Layout Position**.



1. In BP 1 **Back Layout Position** ears, shoulder joints, hip joints and ankle of extended leg in line at maximum horizontal alignment.

2. The thigh of the bent leg is perpendicular to the surface of the water.

2. 90° angle between the thigh and the surface of the water, and 90° angle maintained between the thigh and the trunk. At maximum height an air pocket will be evident between the back of the thigh and calf of the bent leg and the surface of the water.

**c) Bent Knee Vertical Position**

1. Body extended in **Vertical Position** with the thigh of the bent leg parallel to the surface of the water.



1. In BP 6 **Vertical Position** the alignment of the extended leg, trunk and head remains constant.

**Figure – 140g FLAMINGO BENT KNEE TWIST SPIN (cont.)**
**DIFFICULTY – 2.9**
**BP 3 Ballet Leg Position**

Body Position Description	Diagrams	Major Desired Actions
<p><b>a) Surface</b></p> <p>1. Body in <b>Back Layout Position</b>.</p> <p>2. One leg extended perpendicular to the surface of the water.</p>		<p>1. See BP 1 <b>Back Layout Position</b>. Ears, shoulder joints, hip joints and ankle of extended leg in line at maximum horizontal alignment.</p> <p>2. 90° angle between the extended leg and the surface of the water and between the extended leg and the trunk with maximum horizontal alignment maintained throughout.</p>



**BP 4 Flamingo Position**

Body Position Description	Diagrams	Major Desired Actions
<p><b>a) Surface</b></p> <p>1. One leg extended perpendicular to the surface of the water.</p> <p>2. The other leg bent with the mid-calf opposite the vertical leg. Foot, shin, and knee at and parallel to the surface of the water.</p> <p>3. Face at the surface of the water.</p>		<p>1. 90° angle between the extended leg and the surface of the water.</p> <p>2. The top of the bent leg from knee to toes should be dry with the vertical leg extended perpendicular midway between the knee and ankle of the horizontal leg.</p> <p>3. Chest close to the surface of the water with the shoulders back. Ears, shoulder joints and hip joints aligned with the spine straight and extended.</p>

**Figure – 140g FLAMINGO BENT KNEE TWIST SPIN (cont.)**
**DIFFICULTY – 2.9**
**BP 6 Vertical Position**

Body Position Description	Diagrams	Major Desired Actions
1. Body extended perpendicular to the surface of the water; legs together, head downward.		1. Full extension of the body.
2. Head (ears specifically), hips and ankles in line.		2. Judgement is made by checking visual points of the vertical alignment: ears, shoulder joints, hip joints and ankles.

**BM 1 To Assume a Ballet Leg/A Ballet Leg is assumed**

Basic Movement Description	NVT	Diagrams	Major Desired Actions
1. Begin in a <b>Back Layout Position</b> . One leg remains at the surface of the water throughout.			1. See BP 1 <b>Back Layout Position</b> .
2. The foot of the other leg is drawn along the inside of the extended leg to assume a <b>Bent Knee Back Layout Position</b> .	10.5		2. See BP 14b <b>Bent Knee Back Layout Position</b> . The toe of the bending leg remains in contact with the inside of the extended leg. Minimal drop in hips. Position is held only long enough to demonstrate control and accuracy.
3. The bent leg is straightened without movement of the thigh to assume a <b>Ballet Leg Position</b> .	11.0		3.1 See BP 3a <b>Surface Ballet Leg Position</b> . Height remains constant throughout the movement. 3.2 The head and trunk remain stationary throughout.

**Figure – 140g FLAMINGO BENT KNEE TWIST SPIN (cont.)**
**DIFFICULTY – 2.9**
**BM13 g) Twist Spin**

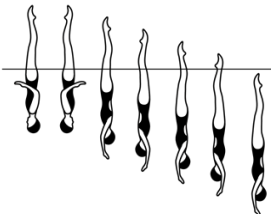
Basic Movement Description	NVT	Diagrams	Major Desired Actions
<p><b>g) <i>Twist Spin</i>.</b> a <i>Half Twist</i> is executed and without a pause is followed by a <i>Continuous Spin</i> of 720° (2) performed in the same direction as the <i>Half Twist</i>.</p>	48.0		<p>g) In a <i>Twist Spin</i>, the BM 12a <i>Half Twist</i> is performed at the same tempo as the root figure. The <i>Continuous Spin</i> must be performed rapidly and in the same direction as the <i>Half Twist</i>. See BM 12a <i>Half Twist</i> and BM13 f <i>Continuous Spin</i>.</p>

**BM 12 Twists**

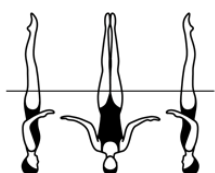
Basic Movement Description	NVT	Diagrams	Major Desired Actions
<p>1. A <i>Twist</i> is a rotation at a sustained height.</p>			<p>1. Height remains constant throughout the rotation. Stability and alignment of the position is evident before, during and upon completion of the <i>Twist</i>. The amount of height is judged by the relationship of the hip joints to the surface of the water with maximum height desirable.</p>
<p>2. The body remains on its longitudinal axis throughout the rotation.</p>			<p>2. The longitudinal axis runs through the centre of the body and is perpendicular to the surface of the water. On the spot rotation around this axis.</p>
<p><b>a) <i>Half Twist</i>:</b> a <i>Twist</i> of 180°.</p>			<p>a) The acceptable allowance for <i>Half Twist</i> is up to ¼ less than/more than the required rotation.</p>

**Figure – 140g FLAMINGO BENT KNEE TWIST SPIN (cont.)**
**DIFFICULTY – 2.9**
**BM 13 Spins**

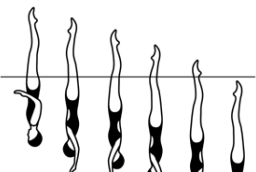
Basic Movement Description	NVT	Diagrams	Major Desired Actions
<p>1. A <i>Spin</i> is a rotation in a <b>Vertical Position</b>.</p> <p>2. The body remains on its longitudinal axis throughout the rotation.</p> <p>3. A <i>descending Spin</i> must start at the height of the vertical and be completed as the ankles reach the surface of the water.</p>			<p>1. See BP 6 <b>Vertical Position</b>. Height and position attained before the <i>Spin</i> begins.</p> <p>2. The longitudinal axis runs through the centre of the body and is perpendicular to the surface of the water.</p> <p>3.1 Stability and vertical alignment before, during and at completion of the designated rotation.</p> <p>3.2 Simultaneous rotation and descent of the body with even drop spaces to complete the <i>Spin</i> as the ankles reach the surface of the water.</p>
<p><b>f) <i>Continuous Spin</i></b>: a <i>descending Spin</i> with a rapid rotation of 720° (2), 1080° (3), or 1440° (4) which is completed as the ankles reach the surface of the water and continues through submergence.</p> <p>Continuous Spin 720° shown →</p>			<p>f) A <i>Continuous Spin</i> must achieve and maintain a rapid rotation throughout.</p> <p>The acceptable allowance for a <i>Continuous Spin</i> is up to 180° less than/more than the required rotation.</p>



**11.3.2 Figure – 437 CYCLONE OPEN 180°**
**DIFFICULTY – 2.6**

From a **Back Layout Position** a *Bent Knee Surface Arch Position* is assumed. The legs are simultaneously lifted to a **Vertical Position** as a *Twirl* is executed. Continuing in the same direction the legs are opened symmetrically to a **Split Position** as a 180° rotation is executed. A *Walkout Front* is executed.







						Total
NVT=	17.5	29.0	20.0	23.0	7.0	96.5
PV =	1.81	3.01	2.07	2.38	0.73	10

Figure Description	NVT	Diagrams	Major Desired Actions
--------------------	-----	----------	-----------------------

1. From a **Back Layout Position** a *Bent Knee Surface Arch Position* is assumed.

17.5

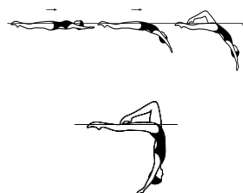

1. See BP 1 **Back Layout Position**, BP 14d **Bent Knee Surface Arch Position** and BM 15 *To Assume a Bent Knee Surface Arch Position*.  
 Continuous uniform movement from **Back Layout Position** to **Bent Knee Surface Arch Position**.

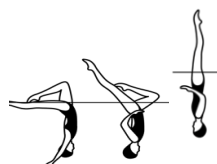

2. The legs are simultaneously lifted to a **Vertical Position** as a *Twirl* is executed.

29.0

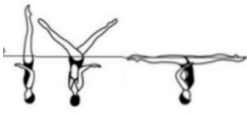

2.1 See BP 6 **Vertical Position** and BM 12c *Twirl*.  
 Trunk alignment maintained between hips and shoulders. Hips and shoulders aligned horizontally and 'square'.  
 2.2 Straightening of the bent leg is completed simultaneously with completion of the *Twirl*. A rapid 180° rotation is executed with minimal lateral movement.  
 2.3 The hips maintain constant height and are the pivot point for the lift to **Vertical Position**.

**Figure – 437 CYCLONE OPEN 180° (cont.)**
**DIFFICULTY – 2.6**

Figure Description	NVT	Diagrams	Major Desired Actions
3. Continuing in the same direction the legs are opened symmetrically to a <b>Split Position</b> as a 180° rotation is executed.	20.0		3. With continuous motion the body turns 180° on its longitudinal axis as the legs lower simultaneously to BP 16a <b>Surface Split Position</b> . Hip level remains constant, and legs are equidistant from the surface of the water at all times.
4. A <i>Walkout Front</i> is executed.	23.0		4. See BM 6a <i>Walkout Front</i> and BM 5 <i>Arch to Back Finish Action</i> .
	7.0		

**BP 1 Back Layout Position**

Body Position Description	Diagrams	Major Desired Actions
1. Body extended with face, chest, thighs, and feet at the surface of the water.		1. Gives the impression that the body is stretched horizontally to its maximum. Front of the trunk will also be at the surface of the water.
2. Head (ears specifically), hips and ankles in horizontal alignment.		2. Judgement is made by checking visual points of the horizontal alignment: ears, shoulder joints, hip joints and ankles. This imaginary line should also pass through the middle of the side of the trunk.

**BP 14 Bent Knee Position**

Body Position Description	Diagrams	Major Desired Actions
One leg bent with the toe of the bent leg in contact with the inside of the extended leg at the knee or higher.		The relationship of the toe of the bent leg to the extended leg may vary depending on the figure but should remain constant once established, and not extend in front of or behind the extended leg.

**Figure – 437 CYCLONE OPEN 180° (cont.)**
**DIFFICULTY – 2.6**
**BP 14 Bent Knee Position (cont.)**

Body Position Description	Diagrams	Major Desired Actions
<p><b>d) Bent Knee Surface Arch Position</b></p> <p>1. Lower back arched with hips, shoulders, and head on a vertical line.</p> <p>2. The thigh of the bent leg is perpendicular to the surface of the water.</p>		<p>1.1 In BP 13 <b>Surface Arch Position</b> shoulder joints and hip joints on a horizontal line with both of these alignments 'square' and parallel to one another. Head (ears specifically) in line with shoulders.</p> <p>1.2 Hips at the surface of the water.</p> <p>2. 90° angle between the thigh of the bent leg and the surface of the water. An air pocket will be evident between the back of the thigh and calf of the bent leg and the surface of the water.</p>

**BP 6 Vertical Position**

Body Position Description	Diagrams	Major Desired Actions
<p>1. Body extended perpendicular to the surface of the water; legs together, head downward.</p> <p>2. Head (ears specifically), hips and ankles in line.</p>		<p>1. Full extension of the body.</p> <p>2. Judgement is made by checking visual points of the vertical alignment: ears, shoulder joints, hip joints and ankles.</p>

**BP 16 Split Position**

Body Position Description	Diagrams	Major Desired Actions
<p>1. Legs evenly split forward and back.</p> <p>2. The legs are parallel to the surface of the water.</p> <p>3. Lower back arched, with hips, shoulders, and head on a vertical line.</p> <p>4. 180° angle between the extended legs (flat split), with inside of each leg aligned on opposite sides of a horizontal line, regardless of the height of the hips.</p>		<p>1. Full extension of the legs at or above the surface of the water.</p> <p>4. Flat split.</p> <p>Hip joints and shoulder joints on a horizontal line, with both of these alignments 'square' and parallel to each other.</p>



**Figure – 437 CYCLONE OPEN 180° (cont.)**
**DIFFICULTY – 2.6**
**BP 16 Split Position (cont.)**

Body Position Description	Diagrams	Major Desired Actions
<b>a) Surface Split Position</b> 1. Legs are dry at the surface of the water.		1. Full extension of the legs. Crotch and legs dry at the surface of the water.

**BP 13 Surface Arch Position**

Body Position Description	Diagrams	Major Desired Actions
1. Lower back arched with hips, shoulders, and head on a vertical line.		1. Hip joints and shoulder joints on a horizontal line with both of these alignments 'square' and parallel to one another. Head (ears specifically) in line with shoulders.
2. Legs together and at the surface of the water.		2. Hips joints at the surface of the water.

**BM 15 To Assume a Bent Knee Surface Arch Position/ A Bent Knee Surface Arch is Assumed**

Basic Movement Description	NVT	Diagrams	Major Desired Actions
1. From a <b>Back Layout Position</b> with the head leading, the head, hips and feet move along the surface of the water.			1. See BP 1 <b>Back Layout Position</b> .
2. With continuous movement the head leaves the surface of the water as the back is arched more to assume a <b>Bent Knee Surface Arch Position</b> with the hips occupying the position of the head at the beginning of this action.	17.5		2.1 Continuous uniform movement from the BP 1 <b>Back Layout Position</b> to BP 14d <b>Bent Knee Surface Arch Position</b> . Hip height remains constant. Hip joints on a horizontal line. 2.2 The toe of the bent leg must remain in contact with the inside of the extended leg while assuming the <b>Bent Knee Surface Arch Position</b> .





**Figure – 437 CYCLONE OPEN 180° (cont.)**
**DIFFICULTY – 2.6**
**BM 12 Twist**

Basic Movement Description	NVT	Diagrams	Major Desired Actions
<p>1. A <i>Twist</i> is a rotation at a sustained height.</p> <p>2. The body remains on its longitudinal axis throughout the rotation.</p>			<p>1. Height remains constant throughout the rotation. Stability and alignment of the position is evident before, during and upon completion of the <i>Twist</i>. The amount of height is judged by the relationship of the hip joints to the surface of the water with maximum height desirable.</p> <p>2. The longitudinal axis runs through the centre of the body and is perpendicular to the surface of the water. On the spot rotation around this axis.</p>
<p>c) <b>Twirl</b>, a rapid <i>Twist</i> of 180°. For 437 Cyclone Open 180° the <i>Twirl</i> starts in a BP 14d <b>Bent Knee Surface Arch Position</b> and is completed in the BP 6 <b>Vertical Position</b>.</p>	29.0		<p>c) The acceptable allowance for <math>\frac{1}{2}</math> <i>Twist</i> rotations is up to <math>\frac{1}{4}</math> less than/more than the required rotation.</p> <p>Definite increase in speed from the root figure. Stability of body alignment and height remains constant during and after completion of the <i>Twirl</i>.</p>



**BM 6 Walkout**

Basic Movement Description	NVT	Diagrams	Major Desired Actions
<p>1. These movements start in a <b>Split Position</b> unless otherwise specified in the figure description. The hips remain stationary as one leg is lifted in an arc over the surface of the water to meet the opposite leg.</p>			<p>1. See BP 16a <b>Surface Split Position</b>.</p>

**Figure – 437 CYCLONE OPEN 180° (cont.)**
**DIFFICULTY – 2.6**
**BM 6 Walkout (cont.)**

Basic Movement Description	NVT	Diagrams	Major Desired Actions
<b>a) Walkout Front</b> 2. The front leg is lifted in a 180° arc over the surface of the water to meet the opposite leg in a <b>Surface Arch Position</b> and with continuous movement an <i>Arch to Back Layout Position</i> is executed.	23.0	   	2.1 Hip height remains constant and at the surface of the water. 2.2 Arcing leg moves continuously with uniform motion. 2.3 Both legs maintain full extension. 2.4 The trunk remains stationary until the feet join. 2.5 No pause in BP 13 <b>Surface Arch Position</b> , however an accurate surface arch must be evident before the body begins to rise and straighten. 2.6 Foot first surfacing motion begins when the feet are joined. 2.7 See BP 13 <b>Surface Arch Position</b> and BM 5 <i>Arch to Back Layout Position</i> .
	7.0		

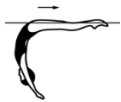
**BM 5 Arch to Back Layout Position**

Basic Movement Description	NVT	Diagrams	Major Desired Actions
1. From a <b>Surface Arch Position</b> the hips, chest, and face surface sequentially at the same point with foot first movement to a <b>Back Layout Position</b> until the head occupies the position of the hips at the beginning of this action.	7.0	 	1. See BP 13 <b>Surface Arch Position</b> . Sharp arch in the lower back. The body rises, straightens, and moves along the surface of the water with a stationary BP 1 <b>Back Layout Position</b> achieved as the face surfaces. Full extension maintained throughout.

**11.3.3 Figure – 308h BARRACUDA AIRBORNE SPLIT SPIN UP 180° DIFFICULTY – 2.9**

From a **Back Layout Position** the legs are raised to a vertical as the body is submerged to a **Back Pike Position** with the toes just under the surface of the water. All remaining movements are performed rapidly. A *Rocket Split* is executed. A *Vertical Descent* is executed and is completed as the ankles reach the surface of the water. A *Spin Up 180°* is executed. A *Vertical Descent* is executed.







								Total
NVT=	7.0	31.0	17.0	13.0	13.0	20.0	13.0	114
PV =	0.61	2.72	1.49	1.14	1.14	1.75	1.14	10

Figure Description	NVT	Diagrams	Major Desired Actions
--------------------	-----	----------	-----------------------

1. From a **Back Layout Position** the legs are raised to vertical as the body is submerged to a **Back Pike Position** with the toes just under the surface of the water.

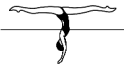





7.0

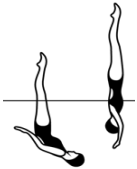
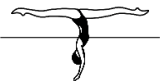

1.1 See BP 1 **Back Layout Position** and BP 11 **Back Pike Position**. In the submerged Back Pike Position the hips are directly beneath the position they occupied in the Back Layout Position.

1.2 The pike is held only long enough to define the position and complete the transition.

**Figure – 308h BARRACUDA AIRBORNE SPLIT SPIN UP 180° DIFFICULTY – 2.9**

Figure Description	NVT	Diagrams	Major Desired Actions
2. A <i>Rocket Split</i> is executed.			
	31.0		2.1 See BM 9 <i>Thrust</i> and BM 11 <i>Rocket Split</i> . Rapid speed evident from the BM 9 <i>Thrust</i> until completion of the figure. 2.2 Maximum height and BP 6 <b>Vertical Position</b> achieved simultaneously.
	17.0		2.3 See BP 16 <b>Split Position</b> and BP 16b <b>Airborne Split Position</b> . Full extension of the legs split evenly and completely above and parallel to the surface of the water followed by a rejoin to <b>Vertical Position</b> .
	13.0		2.4 BP 6 <b>Vertical Position</b> evident prior to descent.
3. A <i>Vertical Descent</i> is executed and is completed as the ankles reach the surface of the water	13.0	 	3. See BM 10 <i>Vertical Descent</i> . Must be rapid and remain on the same vertical line as the <i>Thrust</i> and is completed as the ankles reach the surface of the water.
4. A <i>Spin Up 180°</i> is executed.	20.0		4. See BM 13i <i>Spin Up 180°</i> With the water level at the ankles a rapid <i>ascending Spin</i> of 180° is executed until a water level is established between the knees and hips. Stability and vertical alignment maintained throughout the <i>Spin Up</i> .
5. A <i>Vertical Descent</i> is executed.	13.0		5. See BM 10 <i>Vertical Descent</i> . Must be rapid and remain on the same vertical line as the <i>Thrust</i> throughout submergence.



**Figure – 308h BARRACUDA AIRBORNE SPLIT SPIN UP 180° DIFFICULTY – 2.9  
(cont.)**
**BP 1 Back Layout Position**

Body Position Description	Diagrams	Major Desired Actions
<p>1. Body extended with face, chest, thighs, and feet at the surface of the water.</p>		<p>1. Gives the impression that the body is stretched horizontally to its maximum. Front of the trunk will also be at the surface of the water.</p>
<p>2. Head (ears specifically), hips and ankles in horizontal alignment.</p>		<p>2. Judgement is made by checking visual points of the horizontal alignment: ears, shoulder joints, hip joints and ankles. This imaginary line should also pass through the middle of the side of the trunk.</p>

**BP 11 Back Pike Position**

Body Position Description	Diagrams	Major Desired Actions
<p>1. Body bent at hips to form an acute angle of 45° or less.</p>		<p>1. Legs close to chest while maintaining the straight-line alignment of the extended spine and head.</p>
<p>2. Legs extended and together.</p>		<p>2. Full extension of the legs, ankles, and feet.</p>
<p>3. Trunk extended with the back straight and head in line.</p>		<p>3. Back flat, with ears, shoulder joints, middle of side of torso, and hip joints aligned. Once the pike position is established the degree of the angle remains constant.</p>

**BP 6 Vertical Position**

Body Position Description	Diagrams	Major Desired Actions
<p>1. Body extended perpendicular to the surface of the water; legs together, head downward.</p>		<p>1. Full extension of the body.</p>
<p>2. Head (ears specifically), hips and ankles in line.</p>		<p>2. Judgement is made by checking visual points of the vertical alignment: ears, shoulder joints, hip joints and ankles.</p>

**Figure – 308h BARRACUDA AIRBORNE SPLIT SPIN UP 180°  
(cont.)**
**DIFFICULTY – 2.9**
**BP 16 Split Position**

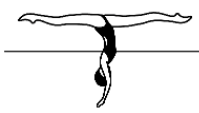
Body Position Description	Diagrams	Major Desired Actions
<ol style="list-style-type: none"> <li>1. Legs evenly split forward and back.</li> <li>2. The legs are parallel to the surface of the water.</li> <li>3. Lower back arched, with hips, shoulders, and head on a vertical line.</li> <li>4. 180° angle between the extended legs (flat split), with inside of each leg aligned on opposite sides of a horizontal line, regardless of the height of the hips.</li> </ol>		<ol style="list-style-type: none"> <li>1. Full extension of the legs at or above the surface of the water.</li> </ol>
<p><b>b) Airborne Split Position</b></p> <ol style="list-style-type: none"> <li>1. Legs are above the surface of the water.</li> </ol>		<ol style="list-style-type: none"> <li>4. Flat split.</li> </ol> <p>Hip joints and shoulder joints on a horizontal line, with both of these alignments 'square' and parallel to each other.</p> <ol style="list-style-type: none"> <li>1.1 Full extension of the legs completely above the surface of the water. Maximum height is desirable.</li> <li>1.2 Both legs equidistant from the surface of the water.</li> </ol>

**BM 9 Thrust**

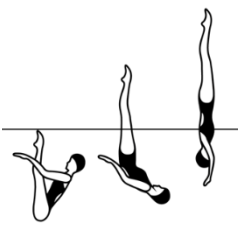
Basic Movement Description	NVT	Diagrams	Major Desired Actions
<ol style="list-style-type: none"> <li>1. From a Submerged <b>Back Pike Position</b> with the legs perpendicular to the surface of the water a vertical upward movement of the legs and hips is rapidly executed as the body unrolls to assume a <b>Vertical Position</b>.</li> </ol>	31.0		<ol style="list-style-type: none"> <li>1.1 See BP 11 <b>Back Pike Position</b>. The toes are just below the surface of the water. Once established, the degree of the angle of the pike position between the legs and the body must not change prior to initiation of the <i>Thrust</i>.</li> <li>1.2 See BP 6 <b>Vertical Position</b>. The body unrolls rapidly under the legs to assume BP 6 <b>Vertical Position</b> along the same perpendicular line to the surface of the water established by the legs in the BP 11 <b>Back Pike Position</b>.</li> <li>1.3 Obvious increase in speed from initiation of body unrolling through vertical upward movement.</li> </ol>

**Figure – 308h BARRACUDA AIRBORNE SPLIT SPIN UP 180° DIFFICULTY – 2.9  
(cont.)**
**BM 9 Thrust (cont.)**

Basic Movement Description	NVT	Diagrams	Major Desired Actions
----------------------------	-----	----------	-----------------------

2. Maximum height desirable.

2. Maximum height and BP  
**6 Vertical Position**  
 achieved simultaneously.

**Thrust Allowance**

Deviation allowances for the *Thrust* action are unique and allow for the legs to be up to an additional 15° off the vertical line. Deductions are as follows:

Deviation Type	Angle Deviation	Deduction Amount
Small Deviation	16° – 30°	.2
Medium Deviation	31° – 45°	.5
Large Deviation	More than 45°	1.0

**BM 11 Rocket Split**

Body Position Description	Diagrams	Major Desired Actions
---------------------------	----------	-----------------------

1. A *Thrust* is executed to a **Vertical Position**. Maintaining maximum height, the legs are split simultaneously and rapidly to assume an **Airborne Split Position** and rejoin to a **Vertical Position**.

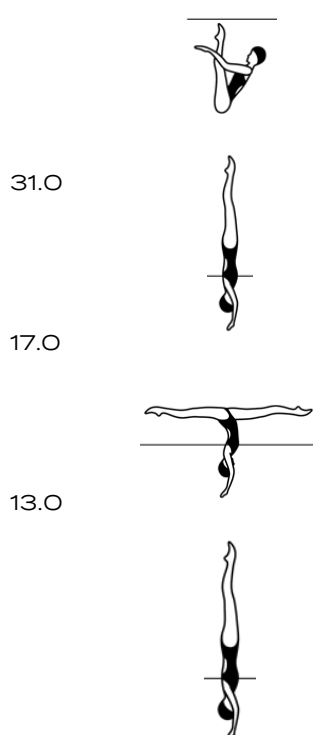

1.1 See BM 9 *Thrust* (steps 1.1 to 2), BP 11 **Back Pike Position**, BP 6 **Vertical Position**, BP 16b **Airborne Split Position**.

1.2 The toes are just below the surface of the water.

1.3 Full extension of the legs above and parallel to the surface of the water.

1.4 The legs split evenly and rejoin in the same vertical line. No travel permitted.

**Figure – 308h BARRACUDA AIRBORNE SPLIT SPIN UP 180° DIFFICULTY – 2.9 (cont.)**

**BM 10 Vertical Descent – from Thrust to ankles**

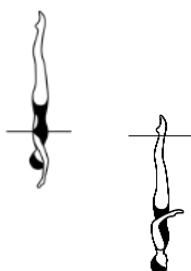
Basic Movement Description	NVT	Diagrams	Major Desired Actions
<p>1. Maintaining a <b>Vertical Position</b> the body descends along its longitudinal axis until the ankles reach the surface of the water.</p>	13.0		<p>1. See BP 6 <b>Vertical Position</b>. The <i>Vertical Descent</i> is executed at the same tempo as the <i>Thrust</i>.</p>

**BM 13 Spins**

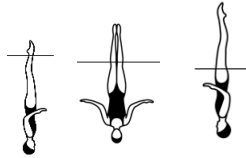
Basic Movement Description	NVT	Diagrams	Major Desired Actions
<p>1. A <i>Spin</i> is a rotation in a <b>Vertical Position</b>.</p> <p>2. The body remains on its longitudinal axis throughout the rotation.</p> <p>6. An <i>ascending Spin</i> begins with the water level at the ankles.</p> <p><b>h) Spin Up 180°:</b> an <i>ascending Spin</i> with a rotation of 180°.</p>	20.0		<p>1. See BP 6 <b>Vertical Position</b>.</p> <p>2. The longitudinal axis runs through the centre of the body and is perpendicular to the surface of the water.</p> <p>6.1 Body rises and rotates simultaneously, evenly, and rapidly.</p> <p>6.2 The designated rotation is completed simultaneously with achievement of maximum height.</p> <p>6.3 Stability and vertical alignment maintained before, during and at completion of the <i>Spin Up</i>. BP 6 <b>Vertical Position</b> evident prior to <i>Vertical Descent</i>.</p> <p>The acceptable allowance for a <i>Spin Up 180°</i> rotation is up to ¼ less than/more than the required rotation.</p> <p>7. A vertical upward <i>Spin</i> is executed until a water level is established between the knees and hips.</p>

**Figure – 308h BARRACUDA AIRBORNE SPLIT SPIN UP 180° DIFFICULTY – 2.9  
(cont.)**

**BM 10 Vertical Descent**

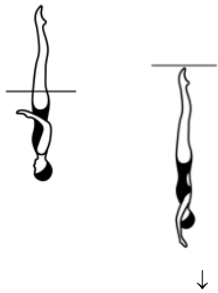
Basic Movement Description	NVT	Diagrams	Major Desired Actions
<p>1. Maintaining a <b>Vertical Position</b> the body descends along its longitudinal axis until the toes are submerged.</p>	13.0		<p>1. See BP 6 <b>Vertical Position</b>. The <i>Vertical Descent</i> is executed rapidly.</p>

**11.3.4 Figure – 407 SWORDFISH STRAIGHT LEG ARIANA ROTATION - DIFFICULTY 2.6**

From a **Front Layout Position** the back arches more as one leg is lifted in a 180° arc over the surface of the water to a **Split Position**. Maintaining the relative position of the legs to the surface of the water an *Ariana Rotation* is performed. A *Walkout Front* is executed.





					Total
NVT=	48.0	17.0	23.0	7.0	95
PV =	5.05	1.79	2.42	0.74	10

Figure Description	NVT	Diagrams	Major Desired Actions
--------------------	-----	----------	-----------------------

1. From a **Front Layout Position** the back arches more as one leg is lifted in a 180° arc over the surface of the water to a **Split Position**.

48.0

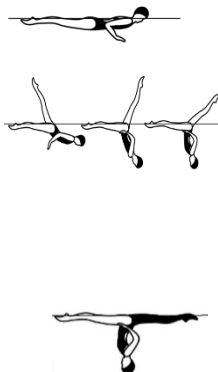

1.1 See BP 2 **Front Layout Position** and BP 16a **Surface Split Position**.

The lifting of the leg and arching of the back occur simultaneously. The foot of the lifted leg comes off the surface of the water as the head goes under the surface of the water.





1.2 There is uniform continuous motion as the leg is lifted in a 180° arc over the surface of the water to a **Surface Split Position**.

1.3 The hips remain stationary, maintain constant height and are the pivot point for the body rotation.



1.4 The head is in vertical alignment with the hips when the foot of the arcing leg passes the vertical position.

1.5 The non-arcing leg remains fully extended and at the surface of the water.

**Figure – 407 SWORDFISH STRAIGHT LEG ARIANA ROTATION DIFFICULTY – 2.6  
(cont.)**

Figure Description	NVT	Diagrams	Major Desired Actions
2. Maintaining the relative position of the legs to the surface of the water an <i>Ariana Rotation</i> is performed.	17.0	 	2. See BM 16 <i>Ariana Rotation</i> .
3. A <i>Walkout Front</i> is executed.	23.0	 	3. See BM 6a <i>Walkout Front</i> and BM 5 <i>Arch to Back Layout Position</i> .
	7.0		



**BP 2 Front Layout Position**

Body Position Description	Diagrams	Major Desired Actions
1. Body extended with head, upper back, buttocks, and heels at the surface of the water.		1. Gives the impression that the body is stretched horizontally to its maximum. Judgement made by checking visual points of the horizontal alignment: ears, shoulder joints, hip joints and heels.
2. Unless otherwise specified, face may be in or out of the water.		2. Once the head position is established as in or out of the water the position is maintained. When the face is out of the water the ears will not be on the horizontal axis and the back may be slightly lower and arched. Hip joints, calves and heels remain at the surface of the water.

**BP 16 Split Position**

Body Position Description	Diagrams	Major Desired Actions
1. Legs evenly split forward and back.		1. Full extension of the legs at or above the surface of the water.
2. The legs are parallel to the surface of the water.		
3. Lower back arched, with hips, shoulders, and head on a vertical line.		

**Figure – 407 SWORDFISH STRAIGHT LEG ARIANA ROTATION DIFFICULTY – 2.6  
(cont.)**
**BP 16 Split Position (cont.)**

Body Position Description	Diagrams	Major Desired Actions
<p>4. 180° angle between the extended legs (flat split), with inside of each leg aligned on opposite sides of a horizontal line, regardless of the height of the hips.</p>		<p>4. Flat split. Hip joints and shoulder joints on a horizontal line, with both of these alignments 'square' and parallel to each other.</p>
<p><b>a) Surface Split Position</b></p> <p>1. Legs are dry at the surface of the water.</p>		<p>1. Full extension of the legs. Crotch and legs dry at the surface of the water.</p>

**BP 13 Surface Arch Position**

Body Position Description	Diagrams	Major Desired Actions
<p>1. Lower back arched, with hips, shoulders, and head on a vertical line.</p>		<p>1. Hip joints and shoulder joints on a horizontal line with both of these alignments 'square' and parallel to one another. Head (ears specifically) in line with shoulders.</p>
<p>2. Legs together and at the surface of the water.</p>		<p>2. Hips joints at the surface of the water.</p>

**BP 1 Back Layout Position**

Body Position Description	Diagrams	Major Desired Actions
<p>1. Body extended with face, chest, thighs, and feet at the surface of the water.</p>		<p>1. Gives the impression that the body is stretched horizontally to its maximum. Front of the trunk will also be at the surface of the water.</p>
<p>2. Head (ears specifically), hips and ankles in horizontal alignment.</p>		<p>2. Judgement is made by checking visual points of the horizontal alignment: ears, shoulder joints, hip joints and ankles. This imaginary line should also pass through the middle of the side of the trunk.</p>



**Figure – 407 SWORDFISH STRAIGHT LEG ARIANA ROTATION DIFFICULTY – 2.6  
(cont.)**



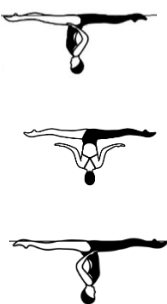

**BM 16 Ariana Rotation**

Basic Movement Description	NVT	Diagrams	Major Desired Actions
<p>1. From a <b>Split Position</b> maintaining the relative position of the legs to the surface of the water the hips rotate 180°.</p>	17.0		<p>1.1 See BP 16a <b>Surface Split Position</b>.</p> <p>1.2 The trunk turns 180° around its longitudinal axis, while the legs rotate horizontally with no lateral movement at the surface of the water.</p> <p>1.3 Height and extension of the <b>Split Position</b> is maintained throughout.</p> <p>1.4 Uniform motion throughout.</p> <p>1.5 Lower back arched with hips, shoulders, and head on a vertical line.</p> <p>1.6 Hip joints and shoulder joints on a horizontal line with both of these alignments 'square' and parallel to each other.</p>

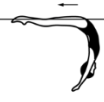

**BM 6 Walkouts**

Basic Movement Description	NVT	Diagrams	Major Desired Actions
<p>1. These movements start in a <b>Split Position</b> unless otherwise specified in the figure description. The hips remain stationary as one leg is lifted in an arc over the surface of the water to meet the opposite leg.</p>			<p>1. See BP 16a <b>Surface Split Position</b>.</p>

**Figure – 407 SWORDFISH STRAIGHT LEG ARIANA ROTATION DIFFICULTY – 2.6  
(cont.)**
**BM 6 Walkouts (cont.)**

Basic Movement Description	NVT	Diagrams	Major Desired Actions
<b>a) Walkout Front</b> 2. The front leg is lifted in a 180° arc over the surface of the water to meet the opposite leg in a <b>Surface Arch Position</b> and with continuous movement an <i>Arch to Back Layout Position</i> is executed.	23.0	  	2.1 Hip height remains constant and at the surface of the water. 2.2 Arcing leg moves continuously with uniform motion. 2.3 Both legs maintain full extension. 2.4 The trunk remains stationary until the feet join. 2.5 No pause in BP 13 <b>Surface Arch Position</b> , however an accurate surface arch must be evident before the body begins to rise and straighten. 2.6 Foot first surfacing motion begins when the feet are joined. 2.7 See BP 13 <b>Surface Arch Position</b> and BM 5 <i>Arch to Back Layout Position</i> .
	7.0		

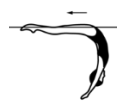
**BM 5 Arch to Back Layout Position**

Basic Movement Description	NVT	Diagrams	Major Desired Actions
1. From a <b>Surface Arch Position</b> the hips, chest, and face surface sequentially at the same point with foot first movement to a <b>Back Layout Position</b> until the head occupies the position of the hips at the beginning of this action.	7.0	 	1. See BP 13 <b>Surface Arch Position</b> . Sharp arch in the lower back. The body rises, straightens, and moves along the surface of the water with a stationary BP 1 <b>Back Layout Position</b> achieved as the face surfaces. Full extension maintained throughout.

**11.3.5 Figure – 356f**
**WHIP CONTINUOUS SPIN 720°**
**DIFFICULTY – 3.0**

From a **Front Layout Position** a *Front Pike Position* is assumed. The legs are lifted to **Vertical Position**. All remaining movements are performed rapidly. One leg is lowered to a **Fishtail Position** and without a pause is lifted to a **Vertical Position**. Without a pause a *Continuous Spin 720°* is executed.













						Total
NVT=	6.0	33.0	22.5	20.5	34.0	116
PV =	0.52	2.84	1.94	1.77	2.93	10

Figure Description	NVT	Diagrams	Major Desired Actions
1. From a <b>Front Layout Position</b> , a <i>Front Pike Position</i> is assumed.	6.0	 	1. See BP 2 <b>Front Layout</b> , BP 10 <b>Front Pike Position</b> and BM 3 <i>To Assume a Front Pike Position</i> . Smooth even movement downwards of the trunk.
2. The legs are lifted to a <b>Vertical Position</b> .	33.0		2.1 See BP 6 <b>Vertical Position</b> . The trunk remains on the vertical line as the legs are lifted. 2.2 Maximum height and <b>Vertical Position</b> achieved simultaneously. 2.3 The <b>Vertical Position</b> is held only long enough to define the position and to demonstrate completion of the transition.
3. One leg is lowered to a <b>Fishtail Position</b> and without a pause is lifted to a <b>Vertical Position</b> .	22.5		3.1 This action is performed rapidly. See BP 8 <b>Fishtail Position</b> .
	20.5		3.2 Height is constant as one leg is lowered and then lifted with the trunk and the vertical leg each maintaining vertical alignment.

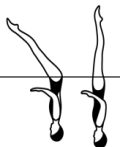
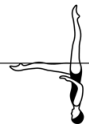

**Figure – 356f WHIP CONTINUOUS SPIN 720° (cont.)**
**DIFFICULTY – 3.0**

Figure Description	NVT	Diagrams	Major Desired Actions
4. Without a pause a <i>Continuous Spin 720°</i> is executed.	34.0		4. See BM 13 <i>Spins</i> and 13f <i>Contin. Spin</i>

**BP 2 Front Layout Position**

Body Position Description	Diagrams	Major Desired Actions
1. Body extended with head, upper back, buttocks, and heels at the surface of the water.		1. Gives the impression that the body is stretched horizontally to its maximum. Judgement made by checking visual points of the horizontal alignment: ears, shoulder joints, hip joints and heels.
2. Unless otherwise specified, face may be in or out of the water.		2. Once the head position is established as in or out of the water the position is maintained. When the face is out of the water the ears will not be on the horizontal axis and the back may be slightly lower and arched. Hip joints, calves and heels remain at the surface of the water.

**BP 10 Front Pike Position**

Body Position Description	Diagrams	Major Desired Actions
1. Body bent at hips to form a 90° angle.		1. Exact 90° angle.
2. Legs extended and together.		2. Full extension of legs, with ankles aligned with hip joints.
3. Trunk extended with the back straight and head in line.		3. Back flat, with vertical alignment of ears, shoulder joints and hip joints once the position is established.

**Figure – 356f WHIP CONTINUOUS SPIN 720° (cont.)**
**DIFFICULTY – 3.0**
**BP 6 Vertical Position**

Body Position Description	Diagrams	Major Desired Actions
1. Body extended perpendicular to the surface of the water; legs together, head downward.		1. Full extension of the body.
2. Head (ears specifically), hips and ankles in line.		2. Judgement is made by checking visual points of the vertical alignment: ears, shoulder joints, hip joints and ankles.

**BP 8 Fishtail Position**

Body Position Description	Diagrams	Major Desired Actions
1. Body extended in <b>Vertical Position</b> with one leg extended forward. The foot of the forward leg is at the surface of the water regardless of the height of the hips.		1. See BP 6 <b>Vertical Position</b> for body alignment. The foot of the forward leg must be at the surface of the water. Hip joints must be on a horizontal line.

**BM 3 To Assume a Front Pike Position/A Front Pike Position is assumed**

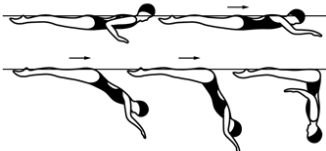
Basic Movement Description	NVT	Diagrams	Major Desired Actions
1. From a <b>Front Layout Position</b> with the face in the water the trunk moves downward to assume a <b>Front Pike Position</b> . The buttocks, legs and feet travel along the surface of the water until the hips occupy the position of the head at the beginning of this action.	6.0		1.1 See BP 2 <b>Front Layout Position</b> and BP 10 <b>Front Pike Position</b> . Uniform motion in downward movement of the trunk. The trunk remains straight throughout the movement. Hips and head lock into position simultaneously. 1.2 Unless otherwise specified, <i>To Assume a Front Pike Position</i> starts from a <b>Front Layout Position</b> .

**Figure – 356f WHIP CONTINUOUS SPIN 720° (cont.)**
**DIFFICULTY – 3.0**
**BM 13 Spins**

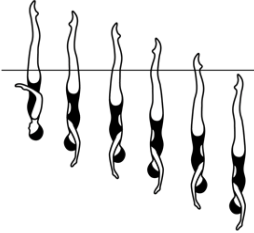
Basic Movement Description	NVT	Diagrams	Major Desired Actions
<p>A <i>Spin</i> is a rotation in a <b>Vertical Position</b>.</p>			<p>See BP 6 <b>Vertical Position</b>. Height and position attained before the <i>Spin</i> begins.</p>
<p>The body remains on its longitudinal axis throughout the rotation.</p>			<p>The longitudinal axis runs through the center of the body and is perpendicular to the surface of the water.</p>
<p>A <i>descending Spin</i> must start at the height of the vertical and be completed as the ankles reach the surface of the water.</p>			<p>Stability and vertical alignment before, during and at completion of the designated rotation.</p> <p>Simultaneous rotation and descent of the body with even drop spaces to complete the spin as the ankles reach the surface of the water.</p>
<p>f) <i>Continuous Spin</i>: a <i>descending Spin</i> with a rapid rotation of 720° (2) which is completed as the ankles reach the surface of the water and continues through submergence.</p>	34.0 (720°) (rapid)		<p>The acceptable spin allowance for a <i>Continuous Spin</i> is up to 180° less than/more than the required rotation.</p>
<p>Continuous Spin 720° shown →</p>			<p>5 f) A <i>Continuous Spin</i> must achieve and maintain a rapid rotation throughout.</p>

**11.3.6 Figure – 441 SATURN**
**DIFFICULTY – 2.5**

From a **Back Layout Position** a *Surface Arch Position* is assumed. One leg is lifted to assume a **Knight Position**. Maintaining the vertical alignment, the body rotates 180° to assume a **Fishtail Position**. Continuing in the same direction a *Twirl* is executed as the horizontal leg is lifted to a **Vertical Position**. A *Vertical Descent* is executed.













						Total
NVT=	12.0	23.5	14.0	23.5	14.0	87
PV =	1.38	2.70	1.61	2.70	1.61	10

Figure Description	NVT	Diagrams	Major Desired Actions
1. From a <b>Back Layout Position</b> a <b>Surface Arch Position</b> is assumed.	12.0		1. See BP 1 <b>Back Layout Position</b> , BP 13 <b>Surface Arch Position</b> and BM 14 <i>To Assume a Surface Arch Position</i> .  Continuous uniform movement from <b>Back Layout Position</b> to <b>Surface Arch Position</b> .
2. One leg is lifted to assume a <b>Knight Position</b> .	23.5		2.1 See BP 17 <b>Knight Position</b> . Horizontal alignment of hips and shoulders 'square' and maintained throughout the lift to <b>Knight Position</b> .  2.2 Height and full extension of the legs maintained throughout the lifting of the leg.
3. Maintaining the vertical alignment the body rotates 180° to assume a <b>Fishtail Position</b> .	14.0		3.1 See BP 8 <b>Fishtail Position</b> . The vertical leg remains stationery and height remains constant throughout the rotation.  3.2 The foot of the horizontal leg is at the surface of the water and not above or below the surface of the water.  3.3 Full extension of both legs throughout the 180° rotation.

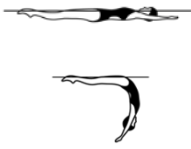
**Figure – 441 SATURN (cont.)**
**DIFFICULTY – 2.5**

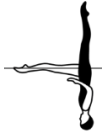
Figure Description	NVT	Diagrams	Major Desired Actions
4. Continuing in the same direction a <i>Twirl</i> is executed as the horizontal leg is lifted to a <b>Vertical Position</b> .	23.5		4.1 See BP 6 <b>Vertical Position</b> and BM 12c <i>Twirl</i> . Trunk alignment maintained beneath hips and shoulders. 4.2 Hips and shoulders aligned horizontally and 'square'. 4.3 The lifting of the horizontal leg to <b>Vertical Position</b> and the completion of the <i>Twirl</i> occur simultaneously. 4.4 A rapid 180° rotation is executed with minimal lateral movement.
5. A <i>Vertical Descent</i> is executed.	14.0		5. See BM 10 <i>Vertical Descent</i> performed at the same tempo as the beginning of the figure to the <b>Fishtail Position</b> .

**BP 1 Back Layout Position**

Body Position Description	Diagrams	Major Desired Actions
1. Body extended with face, chest, thighs, and feet at the surface of the water.		1. Gives the impression that the body is stretched horizontally to its maximum. Front of the trunk will also be at the surface of the water.
2. Head (ears specifically), hips and ankles in horizontal alignment.		2. Judgement is made by checking visual points of the horizontal alignment: ears, shoulder joints, hip joints and ankles. This imaginary line should also pass through the middle of the side of the trunk.



**Figure – 441 SATURN (cont.)**
**DIFFICULTY – 2.5**
**BP 13 Surface Arch Position**

Body Position Description	Diagrams	Major Desired Actions
1. Lower back arched with hips, shoulders, and head on a vertical line.		1. Hip joints and shoulder joints on a horizontal line with both of these alignments 'square' and parallel to one another. Head (ears specifically) in line with shoulders.
2. Legs together and at the surface of the water.		2. Hips joints at the surface of the water.

**BP 17 Knight Position**

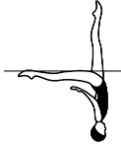
Body Position Description	Diagrams	Major Desired Actions
1. Lower back arched, with hips, shoulders, and head on a vertical line.		1. Arch is in the lower part of the spine only.
2. One leg vertical.		2. Vertical alignment through ears, shoulder joints, hip joints and ankle of the vertical leg.
3. Other leg extended backward with the leg at the surface of the water and as close to horizontal as possible.		3. Hip joints and shoulder joints on a horizontal line with both of these alignments 'square' and parallel to each other. The top of the horizontal extended leg faces upward.

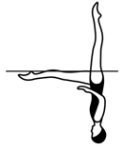

**BP 8 Fishtail Position**

Body Position Description	Diagrams	Major Desired Actions
1. Body extended in <b>Vertical Position</b> with one leg extended forward. The foot of the forward leg is at the surface of the water regardless of the height of the hips.		1. See BP 6 <b>Vertical Position</b> for body alignment. The foot of the forward leg must be at the surface of the water. Hip joints must be on a horizontal line.

**Figure – 441 SATURN (cont.)**
**DIFFICULTY – 2.5**
**BP 6 Vertical Position**

Body Position Description	Diagrams	Major Desired Actions
1. Body extended perpendicular to the surface of the water; legs together, head downward.		1. Full extension of the body.
2. Head (ears specifically), hips and ankles in line.		2. Judgement is made by checking visual points of the vertical alignment: ears, shoulder joints, hip joints and ankles.

**BM 14 To Assume a Surface Arch Position/A Surface Arch Position is Assumed**

Basic Movement Description	NVT	Diagrams	Major Desired Actions
1. From a <b>Back Layout Position</b> with the head leading, the head, hips and feet move along the surface of the water.			1. See BP 1 Back Layout Position.
2. With continuous movement the head leaves the surface of the water as the back is arched more to assume a <b>Surface Arch Position</b> with the hips occupying the position of the head at the beginning of this action.	12.0		2. Continuous uniform movement from the BP 1 <b>Back Layout Position</b> to BP 13 <b>Surface Arch Position</b> . Hip height remains constant. Hip joints on a horizontal line.

**BM 12 Twists**

Basic Movement Description	NVT	Diagrams	Major Desired Actions
1. A Twist is a rotation at a sustained height.			1. Height remains constant throughout the rotation. Stability and alignment of the position is evident before, during and upon completion of the Twist. The amount of height is judged by the relationship of the hip joints to the surface of the water with maximum height desirable.

**Figure – 441 SATURN (cont.)**
**DIFFICULTY – 2.5**
**BM 12 Twists (cont.)**

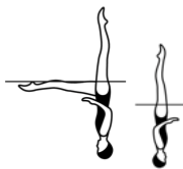
Basic Movement Description	NVT	Diagrams	Major Desired Actions
2. The body remains on its longitudinal axis throughout the rotation.			2. The longitudinal axis runs through the center of the body and is perpendicular to the surface of the water. On the spot rotation around this axis.
c) <b>Twirl.</b> a rapid <i>Twist</i> of 180°. For 441 Saturn the Twirl starts in a BP 8 <b>Fishtail Position</b> and is completed in the BP 6 <b>Vertical Position</b> .	29.0		The acceptable allowance for ½ Twist rotations is up to ¼ less than/more than the required rotation.  Definite increase in speed from the root figure. Stability of body alignment and height remains constant throughout and after completion of the Twirl.

**BM 10 Vertical Descent**

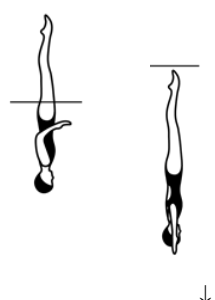
Basic Movement Description	NVT	Diagrams	Major Desired Actions
1. Maintaining a <b>Vertical Position</b> the body descends along its longitudinal axis until the toes are submerged.	14.0		1. See BP 6 <b>Vertical Position</b> . The descent is uniform and at the same tempo as the beginning of the figure to the <b>Fishtail Position</b> .

**11.3.7 Figure – 352 VENUS**
**DIFFICULTY – 3.0**

From a **Front Layout Position** a *Front Pike Position* is assumed. All remaining movements are performed rapidly. One leg is lifted to a **Fishtail Position**. The horizontal leg is bent to assume a **Bent Knee Vertical Position**. The bent leg is extended to vertical as the vertical leg is lowered to become the horizontal leg in **Fishtail Position**. A rotation of 360° is executed in the **Fishtail Position**. The horizontal leg is lifted to **Vertical Position**. A 360° *Spin* is executed.











											Total
NVT=	6.0	12.5	12.5	18.5	24.0	20.5	23.0	0	0	0	117
PV =	0.51	1.07	1.07	1.58	2.05	1.75	1.97	0	0	0	10

Figure Description	NVT	Diagrams	Major Desired Actions
--------------------	-----	----------	-----------------------

1. From a **Front Layout Position** a *Front Pike Position* is assumed.

6.0

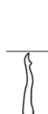

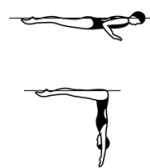
1. See BP 2 **Front Layout**, BP 10 **Front Pike Position** and BM 3 *To Assume a Front Pike Position*. Smooth even movement downwards of the trunk.

2. One leg is lifted to a **Fishtail Position**. The horizontal leg is bent to assume a **Bent Knee Vertical Position**.

12.5



2.1 This action is performed rapidly.

2.2 See BP 8 **Fishtail Position**. A clear **Fishtail Position** is shown.

Height and vertical alignment of the trunk is maintained. Stability and control evident.

2.3 See BP 14c **Bent Knee Vertical Position**.

Height, stability, and vertical body alignment maintained throughout the bending of the horizontal leg to assume a **Bent Knee Vertical Position**.

It is important to note that the vertical leg in the **Fishtail Position** must remain the vertical leg in the **Bent Knee Vertical Position**.

The diagram shows the **Fishtail Position** to **Bent Knee Vertical Position** movement performed with the left (L) leg shaded black however either leg can be used to perform the action.



12.5





**Figure – 352 VENUS (cont.)**
**DIFFICULTY – 3.0**

Figure Description	NVT	Diagrams	Major Desired Actions
<p>3. The bent leg is extended to vertical as the vertical leg is lowered to become the horizontal leg in <b>Fishtail Position</b>.</p> <p>It is important to note that the vertical leg in the <b>Bent Knee Vertical Position</b> becomes the horizontal leg in the <b>Fishtail Position</b>.</p> <p>The diagram shows the <b>Bent Knee Vertical Position</b> to the <b>Fishtail Position</b> movement performed with the left (L) leg shaded black however either leg can be used to perform the action.</p>	18.5	 	<p>3.1 This action is performed rapidly.</p> <p>3.2 See BP 14c <b>Bent Knee Vertical Position</b> and BP 8 <b>Fishtail Position</b>.</p> <p>Both legs should move simultaneously to assume a Fishtail Position with height and vertical alignment of the trunk maintained throughout. Stability and control evident.</p>
<p>4. A rotation of 360° is executed in the <b>Fishtail Position</b>.</p>	24.0	 	<p>4.1 This action is performed rapidly.</p> <p>4.2 See BP 8 <b>Fishtail Position</b>. The vertical leg remains stationary and height remains constant throughout the rapid rotation. The foot of the horizontal leg is at the surface of the water and not above or below.</p> <p>4.3 There is full extension of the horizontal leg throughout the 360° rotation in BP 8 <b>Fishtail Position</b>.</p>
<p>5. The horizontal leg is lifted to <b>Vertical Position</b>.</p>	20.5		<p>5.1 This action is performed rapidly.</p> <p>5.2 See BP 8 <b>Fishtail Position</b>. The horizontal leg is lifted to BP 6 <b>Vertical Position</b> with height and vertical alignment of the trunk maintained throughout. Stability and control evident.</p>
<p>6. A 360° <i>Spin</i> is executed.</p>	23.0		<p>6.1 This action is performed rapidly.</p> <p>6.2 See BM 13 <i>Spins</i> and <i>Spin</i> allowances.</p>
	0		

**Figure – 352 VENUS (cont.)**
**DIFFICULTY – 3.0**
**BP 2 Front Layout Position**

Body Position Description	Diagrams	Major Desired Actions
1. Body extended with head, upper back, buttocks, and heels at the surface of the water.		1. Gives the impression that the body is stretched horizontally to its maximum. Judgement made by checking visual points of the horizontal alignment: ears, shoulder joints, hip joints and heels.
2. Unless otherwise specified, face may be in or out of the water.		2. Once the head position is established as in or out of the water the position is maintained. When the face is out of the water the ears will not be on the horizontal axis and the back may be slightly lower and arched. Hip joints, calves and heels remain at the surface of the water.



**BP 10 Front Pike Position**

Body Position Description	Diagrams	Major Desired Actions
1. Body bent at hips to form a 90° angle.		1. Exact 90° angle.
2. Legs extended and together.		2. Full extension of legs, with ankles aligned with hip joints.
3. Trunk extended with the back straight and head in line.		3. Back flat, with vertical alignment of ears, shoulder joints and hip joints once the position is established.



**Figure – 352 VENUS (cont.)**
**DIFFICULTY – 3.0**
**BP 8 Fishtail Position**

Body Position Description	Diagrams	Major Desired Actions
<p>1. Body extended in <b>Vertical Position</b> with one leg extended forward. The foot of the forward leg is at the surface of the water regardless of the height of the hips.</p>		<p>1. See BP 6 <b>Vertical Position</b> for body alignment. The foot of the forward leg must be at the surface of the water. Hip joints must be on a horizontal line.</p>

**BP 14 Bent Knee Position**

Body Position Description	Diagrams	Major Desired Actions
<p>One leg bent with the toe of the bent leg in contact with the inside of the extended leg at the knee or higher.</p>		<p>The relationship of the toe of the bent leg to the extended leg may vary depending on the figure but should remain constant once established, and not extend in front of or behind the extended leg.</p>
<p><b>c) Bent Knee Vertical Position</b></p> <p>1. Body extended in <b>Vertical Position</b> with the thigh of the bent leg parallel to the surface of the water.</p>		<p>1. In BP 6 <b>Vertical Position</b> the alignment of the extended leg, trunk and head remains constant.</p>

**BP 6 Vertical Position**

Body Position Description	Diagrams	Major Desired Actions
<p>1. Body extended perpendicular to the surface of the water; legs together, head downward.</p>		<p>1. Full extension of the body.</p>
<p>2. Head (ears specifically), hips and ankles in line.</p>		<p>2. Judgement is made by checking visual points of the vertical alignment: ears, shoulder joints, hip joints and ankles.</p>

**Figure – 352 VENUS (cont.)**
**DIFFICULTY – 3.0**
**BM 3 To Assume a Front Pike Position/A Front Pike Position is assumed**

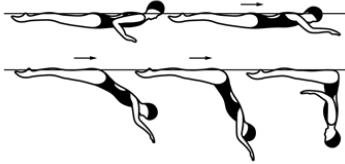
Basic Movement Description	NVT	Diagrams	Major Desired Actions
<p>1. From a <b>Front Layout Position</b> with the face in the water the trunk moves downward to assume a <b>Front Pike Position</b>. The buttocks, legs and feet travel along the surface of the water until the hips occupy the position of the head at the beginning of this action.</p>	6.0		<p>1.1 See BP 2 <b>Front Layout Position</b> and BP 10 <b>Front Pike Position</b>. Uniform motion in downward movement of the trunk. The trunk remains straight throughout the movement. Hips and head lock into position simultaneously.</p> <p>1.2 Unless otherwise specified, <i>To Assume a Front Pike Position</i> starts from a <b>Front Layout Position</b>.</p>

**BM 13 Spins**

Basic Movement Description	NVT	Diagrams	Major Desired Actions
<p>1. A Spin is a rotation in a <b>Vertical Position</b>.</p> <p>2. The body remains on its longitudinal axis throughout the rotation.</p> <p>3. The <i>Spin</i> is performed rapidly and is completed with a <i>Vertical Descent</i> executed at the same tempo as the <i>Spin</i>.</p> <p>4. A <i>descending Spin</i> must start at the height of the vertical and be completed as the ankle(s) reach(es) the surface of the water.</p>			<p>1. See BP 6 <b>Vertical Position</b>. Height and position attained before the <i>Spin</i> begins.</p> <p>2. The longitudinal axis runs through the centre of the body and is perpendicular to the surface of the water.</p> <p>3. Uniform motion of the <i>Spin</i> and <i>Vertical Descent</i> performed rapidly. See BM 10 <i>Vertical Descent</i>.</p> <p>4.1 Stability and vertical alignment before, during and at completion of the designated rotation.</p> <p>4.2 Simultaneous rotation and descent of the body with even drop spaces to complete the spin as the ankles reach the surface of the water.</p>

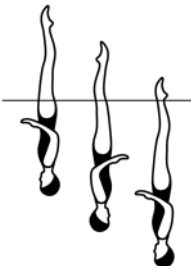



**Figure – 352 VENUS (cont.)**

**DIFFICULTY – 3.0**

**BM 13 Spins (cont.)**

Basic Movement Description	NVT	Diagrams	Major Desired Actions
<p><b>e) 360° Spin/Spinning 360°:</b> a <i>descending Spin</i> with a rotation of 360°.</p>	23.0		<p>The acceptable allowance for a 360° Spin is up to ¼ less than/more than the required rotation.</p>

**BM 10 Vertical Descent - from ankle level**

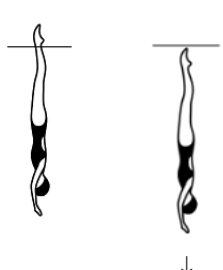
Basic Movement Description	NVT	Diagrams	Major Desired Actions
<p>1. Maintaining a <b>Vertical Position</b> the body descends along its longitudinal axis until the toes are submerged.</p>	0		<p>1. See BP 6 <b>Vertical Position</b>. The tempo of the descent is uniform and rapid.</p>

**11.3.8 Figure – 240i**
**ALBATROSS SPIN UP 360°**
**DIFFICULTY – 2.5**

From a **Back Layout Position** with the head leading, the head, hips and feet move along the surface of the water. The hips, legs and feet continue to move along the surface of the water as the body rolls onto the face and a *Front Pike Position* is assumed with the hips occupying the position of the head at the beginning of this action. The legs are lifted simultaneously to a **Bent Knee Vertical Position**. A *Half Twist* is executed. Maintaining a **Bent Knee Vertical Position**, a *Vertical Descent* is executed until the ankle of the extended leg reaches the surface of the water. A *Spin Up 360°* is executed as the bent leg is extended to **Vertical Position**. A *Vertical Descent* is executed.







							Total
NVT=	15.0	15.0	15.0	10.0	18.5	14.0	87.5
PV =	1.71	1.71	1.71	1.14	2.11	1.60	10

Figure Description	NVT	Diagrams	Major Desired Actions
--------------------	-----	----------	-----------------------

1. From a **Back Layout Position** with the head leading, the head, hips and feet move along the surface of the water.



1. See BP 1 **Back Layout Position** and BM 3 *To Assume a Front Pike Position*.

2. The hips, legs and feet continue to move along the surface of the water as the body rolls onto the face and a *Front Pike Position* is assumed with the hips occupying the position of the head at the beginning of this action.

15.0



2.1 See BP 10 **Front Pike Position** and BM 3 *To Assume a Front Pike Position*. The body roll, trunk descent and hip movement along the surface of the water occurs simultaneously, with the transition completed as the trunk becomes vertical and the hips replace the head at the surface of the water.

2.2 The hips and head lock into the **Front Pike Position** simultaneously.

3. The legs are lifted simultaneously to a **Bent Knee Vertical Position**.

15.0







3. See BP 14c **Bent Knee Vertical Position**.

The trunk remains on the vertical line.

The **Bent Knee Vertical Position** is achieved as the vertical is reached.

**Figure – 240i ALBATROSS SPIN UP 360° (cont.)**
**DIFFICULTY – 2.5**

Figure Description	NVT	Diagrams	Major Desired Actions
4. A <i>Half Twist</i> is executed.	15.0		4. See BM 12a <i>Half Twist</i> . The <i>Half Twist</i> is performed in a <b>Bent Knee Vertical Position</b> .
5. Maintaining a <b>Bent Knee Vertical Position</b> , a <i>Vertical Descent</i> is executed until the ankle of the extended leg reaches the surface of the water.	10.0		5. Maintaining the vertical line, stability and control is evident throughout the descent to ankle level.
6. A <i>Spin Up 360°</i> is executed as the bent leg is extended to <b>Vertical Position</b> .	18.5		6.1 See BP 6 <b>Vertical Position</b> and BM 13j <i>Spin Up 360°</i> . With the water level at the ankles an <i>ascending Spin</i> of 360° is executed until a water level is established between the knees and hips. 6.2 Continuous straightening of the bent leg is completed simultaneously with completion of the <i>Spin Up 360°</i> . 6.3 Stability and vertical alignment maintained throughout the <i>Spin Up</i> .
7. A <i>Vertical Descent</i> is executed.	14.0		7. See BM 10 <i>Vertical Descent</i> .



**Figure – 240i ALBATROSS SPIN UP 360° (cont.)**
**DIFFICULTY – 2.5**
**BP 1 Back Layout Position**

Body Position Description	Diagrams	Major Desired Actions
1. Body extended with face, chest, thighs, and feet at the surface of the water.		1. Gives the impression that the body is stretched horizontally to its maximum. Front of the trunk will also be at the surface of the water.
2. Head (ears specifically), hips and ankles in horizontal alignment.		2. Judgement is made by checking visual points of the horizontal alignment: ears, shoulder joints, hip joints and ankles. This imaginary line should also pass through the middle of the side of the trunk.

**BP 10 Front Pike Position**

Body Position Description	Diagrams	Major Desired Actions
1. Body bent at hips to form a 90° angle.		1. Exact 90° angle.
2. Legs extended and together.		2. Full extension of legs, with ankles aligned with hip joints.
3. Trunk extended with the back straight and head in line.		3. Back flat, with vertical alignment of ears, shoulder joints and hip joints once the position is established.

**BP 14 Bent Knee Position**

Body Position Description	Diagrams	Major Desired Actions
One leg bent with the toe of the bent leg in contact with the inside of the extended leg at the knee or higher.		The relationship of the toe of the bent leg to the extended leg may vary depending on the figure but should remain constant once established, and not extend in front of or behind the extended leg.
<b>c) Bent Knee Vertical Position</b>		
1. Body extended in <b>Vertical Position</b> with the thigh of the bent leg parallel to the surface of the water.		1. In BP 6 <b>Vertical Position</b> the alignment of the extended leg, trunk and head remains constant.

**Figure – 240i ALBATROSS SPIN UP 360° (cont.)**
**DIFFICULTY – 2.5**
**BP 6 Vertical Position**

Body Position Description	Diagrams	Major Desired Actions
1. Body extended perpendicular to the surface of the water; legs together, head downward.		1. Full extension of the body.
2. Head (ears specifically), hips and ankles in line.		2. Judgement is made by checking visual points of the vertical alignment: ears, shoulder joints, hip joints and ankles.

**BM 3 To Assume a Front Pike Position – adapted from Back Layout Position**

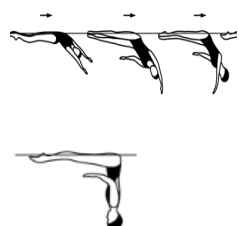
Basic Movement Description	NVT	Diagrams	Major Desired Actions
1. From a <b>Back Layout Position</b> with the head leading, the head, hips and feet move along the surface of the water.			1. See BP 1 <b>Back Layout Position</b> . Uniform motion in downward movement of the trunk. Continuous uniform movement from <b>Back Layout Position</b> .
2. The hips, legs and feet continue to move along the surface of the water as the body rolls onto the face and a <i>Front Pike Position</i> is assumed with the hips occupying the position of the head at the beginning of this action.	15.0		2. See BP 10 <b>Front Pike Position</b> and BM 3 <i>To Assume a Front Pike Position</i> . Uniform motion in downward movement of the trunk. The body roll, trunk descent and hip movement along the surface of the water occurs simultaneously. The hips and head lock into the <b>Front Pike Position</b> simultaneously.

**Figure – 240i ALBATROSS SPIN UP 360° (cont.)**
**DIFFICULTY – 2.5**
**BM 12 Twists a) Half Twist in Bent Knee Vertical Position – adapted**

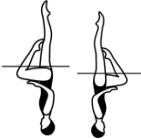
Basic Movement Description	NVT	Diagrams	Major Desired Actions
1. A <i>Twist</i> is a rotation at a sustained height.			1. Height remains constant throughout the rotation. Stability and alignment of the position is evident before, during and upon completion of the <i>Twist</i> . The amount of height is judged by the relationship of the hip joints to the surface of the water with maximum height desirable.
2. The body remains on its longitudinal axis throughout the rotation.			2. The longitudinal axis runs through the center of the body and is perpendicular to the surface of the water. On the spot rotation around this axis.
<b><i>Half Twist in Bent Knee Vertical Position</i></b>			
4. <b>a) <i>Half Twist</i></b> . a <i>Twist</i> of 180°.	15.0		4. The <b>Bent Knee Position</b> is maintained throughout the <i>Half Twist</i> .  The acceptable allowance for a <i>Half Twist</i> rotation is up to ¼ less than/more than the required rotation.

**Figure – 240i ALBATROSS SPIN UP 360° (cont.)**
**DIFFICULTY – 2.5**
**BM 10 Vertical Descent in Bent Knee Vertical Position to ankle level**

Basic Movement Description	NVT	Diagrams	Major Desired Actions
<p>1. Maintaining a <b>Bent Knee Vertical Position</b>, the body descends along its longitudinal axis until the ankle of the extended leg reaches the surface of the water.</p>	10.0		<p>1. The tempo of the descent is uniform and at the same speed as the rest of the figure.</p>

**BM 13 Spins**

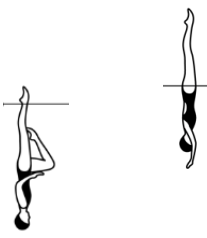
Basic Movement Description	NVT	Diagrams	Major Desired Actions
<p>1. A Spin is a rotation in a <b>Vertical Position</b>.</p> <p>2. The body remains on its longitudinal axis throughout the rotation.</p> <p>6. An ascending <i>Spin</i> begins with the water level at the ankles.  <b>i) Spin Up 360°</b>: an ascending Spin with a rotation of 360°.</p>	18.5		<p>1. See BP 6 <b>Vertical Position</b>.</p> <p>2. The longitudinal axis runs through the centre of the body and is perpendicular to the surface of the water.</p> <p>6.1 Body rises and rotates simultaneously and evenly.</p> <p>6.2 Continuous straightening of the bent leg is completed simultaneously with completion of the <i>Spin Up 360°</i> and achievement of maximum height.</p> <p>6.3 Stability and vertical alignment maintained before, during and at completion of the <i>Spin Up</i>.  <b>BM 6 Vertical Position</b> evident prior to <i>Vertical Descent</i>.</p> <p>The acceptable allowance for a 360° spin rotation is up to ¼ less than/more than the required rotation.</p>
<p>7. A vertical upward <i>Spin</i> is executed until a water level is established between the knees and hips.</p>			



**Figure – 240i ALBATROSS SPIN UP 360° (cont.)**

**DIFFICULTY – 2.5**

Basic Movement Description	NVT	Diagrams	Major Desired Actions
----------------------------	-----	----------	-----------------------

**BM 10 Vertical Descent**

1. Maintaining a **Vertical Position** the body descends along its longitudinal axis until the toes are submerged.

14.0

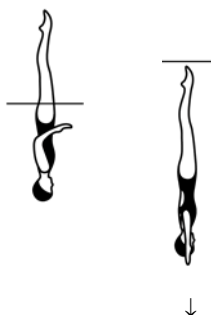

1. See BP 6 **Vertical Position**. The tempo of the descent is uniform and at the same speed as the rest of the figure.

**11.3.9 Figure – 144 RIO STRAIGHT LEG**
**DIFFICULTY – 3.1**

A *Straight Ballet Leg* is assumed. The knee, shin and toes of the horizontal leg are drawn along the surface of the water to assume a **Surface Flamingo Position**. The bent leg is straightened to a **Surface Ballet Leg Double Position**. The body submerges vertically to a **Back Pike Position** with the toes just under the surface of the water. A *Thrust* is executed to a **Vertical Position**. A *Spinning 360°* is executed at the same tempo as the *Thrust*.

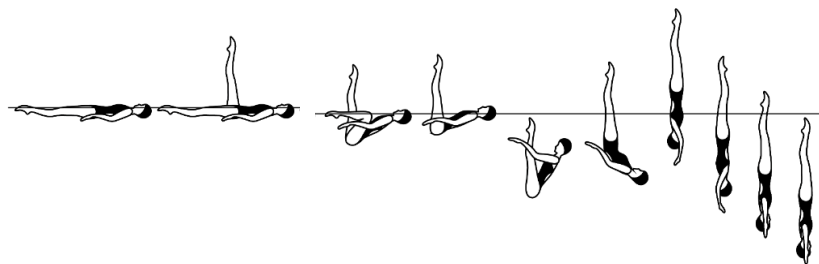





									Total
NVT=		18.5	7.5	13.0	12.0	31.0	39.0	0	121
PV =		1.53	0.62	1.07	0.99	2.56	3.22	0	10

Figure Description	NVT	Diagrams	Major Desired Actions
--------------------	-----	----------	-----------------------

1. A *Straight Ballet Leg* is assumed.

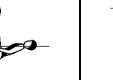
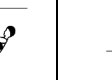
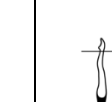
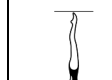

1. See BM1B *To Assume A Straight Ballet Leg*.

18.5



2. The knee, shin and toes of the horizontal leg are drawn along the surface of the water to assume a **Surface Flamingo Position**.

7.5



2. See BP 4a **Surface Flamingo Position**. Height of the ballet leg remains constant.

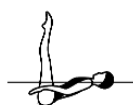

3. The horizontal leg is extended to a **Surface Ballet Leg Double Position**.

13.0

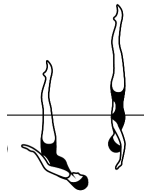

3. See BP 5a **Surface Ballet Leg Double Position**. This position is held only long enough to define the position and to demonstrate completion of the transition.

**Figure – 144 RIO STRAIGHT LEG (cont.)**
**DIFFICULTY – 3.1**

Figure Description	NVT	Diagrams	Major Desired Actions
4. The body submerges vertically to a <b>Back Pike Position</b> with the toes just under the surface of the water.	12.0		4. As the body submerges maintaining the back straight and head in line, a submerged BP 11 <b>Back Pike Position</b> is shown with the legs remaining on the vertical line. The legs and hips are directly beneath the position they occupied in the BP 5a <b>Surface Ballet Leg Double Position</b> .
5. A <i>Thrust</i> is executed to a <b>Vertical Position</b> .	31.0		5.1 See BM 9 <i>Thrust</i> . Obvious increase in speed. The body unrolls under the legs to assume BP 6 <b>Vertical Position</b> along the same perpendicular line established by the legs in the <b>Back Pike Position</b> . 5.2 Maximum height and <b>Vertical Position</b> are achieved simultaneously, with full extension of the <b>Vertical Position</b> shown prior to initiation of the descent.
6. A Spinning 360° is executed at the same tempo as the <i>Thrust</i> to complete the figure.	39.0		6. See BM 13e <i>Spins</i> . Uniform rapid motion at the same rate of speed as the <i>Thrust</i> .
	0		After completion of the 360° <i>Spin</i> , a <i>Vertical Descent</i> is executed at the same tempo as the spin.

**BP 1 Back Layout Position**

Body Position Description	Diagrams	Major Desired Actions
1. Body extended with face, chest, thighs, and feet at the surface of the water.		1. Gives the impression that the body is stretched horizontally to its maximum. Front of the trunk will also be at the surface of the water.

**Figure – 144 RIO STRAIGHT LEG (cont.)**
**DIFFICULTY – 3.1**
**BP 1 Back Layout Position (cont.)**

Body Position Description	Diagrams	Major Desired Actions
2. Head (ears specifically), hips and ankles in horizontal alignment.		2. Judgement is made by checking visual points of the horizontal alignment: ears, shoulder joints, hip joints and ankles. This imaginary line should also pass through the middle of the side of the trunk.

**BP 3 Ballet Leg Position**

Body Position Description	Diagrams	Major Desired Actions
<b>a) Surface</b> 1. Body in <b>Back Layout Position</b> .  2. One leg extended perpendicular to the surface of the water.		1. See BP 1 <b>Back Layout Position</b> . Ears, shoulder joints, hip joints and ankle of extended leg in line at maximum horizontal alignment.  2. 90° angle between the extended leg and the surface of the water and between the extended leg and the trunk with maximum horizontal alignment maintained throughout.

**BP 4 Flamingo Position**

Body Position Description	Diagrams	Major Desired Actions
<b>a) Surface</b> 1. One leg extended perpendicular to the surface of the water.  2. The other leg bent with the mid-calf opposite the vertical leg. Foot, shin, and knee at and parallel to the surface of the water.  3. Face at the surface of the water.		1. 90° angle between the extended leg and the surface of the water.  2. The top of the bent leg from knee to toes should be dry with the vertical leg extended perpendicular midway between the knee and ankle of the horizontal leg.  3. Chest close to the surface of the water with the shoulders back. Ears, shoulder joints and hip joints aligned with the spine straight and extended.

**Figure – 144 RIO STRAIGHT LEG (cont.)**
**DIFFICULTY – 3.1**
**BP 5 Ballet Leg Double Position**

Body Position Description	Diagrams	Major Desired Actions
<p><b>a) Surface</b></p> <ol style="list-style-type: none"> <li>1. Legs together and extended perpendicular to the surface of the water.</li> <li>2. Head in line with the trunk.</li> <li>3. Face at the surface of the water.</li> </ol>		<ol style="list-style-type: none"> <li>1. Full extension of the legs at a 90° angle to the surface of the water.</li> <li>2. Chest close to the surface of the water with the shoulders back. Ears, hip joints and shoulder joints aligned, with the spine straight and extended.</li> </ol>

**BP 11 Back Pike Position**

Body Position Description	Diagrams	Major Desired Actions
<ol style="list-style-type: none"> <li>1. Body bent at hips to form an acute angle of 45° or less.</li> <li>2. Legs extended and together.</li> <li>3. Trunk extended with the back straight and head in line.</li> </ol>		<ol style="list-style-type: none"> <li>1. Legs close to chest while maintaining the straight-line alignment of the extended spine and head.</li> <li>2. Full extension of the legs, ankles, and feet.</li> <li>3. Back flat, with ears, shoulder joints, middle of side of torso, and hip joints aligned. Once the pike position is established the degree of the angle remains constant.</li> </ol>

**BP 6 Vertical Position**

Body Position Description	Diagrams	Major Desired Actions
<ol style="list-style-type: none"> <li>1. Body extended perpendicular to the surface of the water; legs together, head downward.</li> </ol>		<ol style="list-style-type: none"> <li>1. Full extension of the body.</li> </ol>

**Figure – 144 RIO STRAIGHT LEG (cont.)**
**DIFFICULTY – 3.1**
**BP 6 Vertical Position (cont.)**

Body Position Description	Diagrams	Major Desired Actions
2. Head (ears specifically), hips and ankles in line.		2. Judgement is made by checking visual points of the vertical alignment: ears, shoulder joints, hip joints and ankles.

**BM 1B To Assume a Straight Ballet Leg**

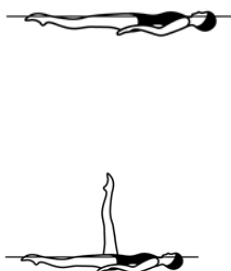
Basic Movement Description	NVT	Diagrams	Major Desired Actions
1. From a <b>Back Layout Position</b> one leg is raised straight to a <b>Ballet Leg Position</b> .			1.1 See BP 1 <b>Back Layout Position</b> . Ears, shoulder joints, hip joints and ankles of extended legs at maximum horizontal alignment.  1.2 One leg is raised straight to BP 3a <b>Surface Ballet Leg Position</b> while keeping the horizontal alignment of the horizontal leg and trunk with minimal drop of the hips. Uniform motion throughout.  1.3 The head and trunk remain stationary throughout.

**BM 9 Thrust**

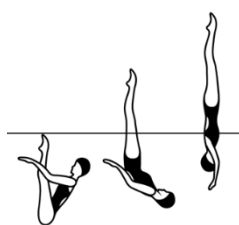
Basic Movement Description	NVT	Diagrams	Major Desired Actions
1. From a <b>Submerged Back Pike Position</b> with the legs perpendicular to the surface of the water a vertical upward movement of the legs and hips is rapidly executed as the body unrolls to assume a <b>Vertical Position</b> .			1.1 See BP 11 <b>Back Pike Position</b> . The toes are just below the surface of the water. Once established, the degree of the angle of the pike position between the legs and the body must not change prior to initiation of the <i>Thrust</i> .  1.2 See BP 6 <b>Vertical Position</b> . The body unrolls rapidly under the legs to assume BP 6 <b>Vertical Position</b> along the same perpendicular line to the surface of the water established by the legs in the BP 11 <b>Back Pike Position</b> .  1.3 Obvious increase in speed from the initiation of body unrolling through the vertical upward movement.

**Figure – 144 RIO STRAIGHT LEG (cont.)**
**DIFFICULTY – 3.1**
**BM 9 Thrust (cont.)**

Basic Movement Description	NVT	Diagrams	Major Desired Actions
2. Maximum height desirable.			2. Maximum height and BP 6 <b>Vertical Position</b> achieved simultaneously.

**BM 13 Spin**

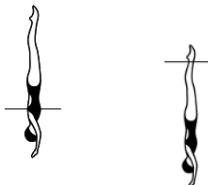
Basic Movement Description	NVT	Diagrams	Major Desired Action
1. A <i>Spin</i> is a rotation in a <b>Vertical Position</b> .			1. See BP 6 <b>Vertical Position</b> . Height and position attained before the <i>Spin</i> begins.
2. The body remains on its longitudinal axis throughout the rotation.			2. The longitudinal axis runs through the centre of the body and is perpendicular to the surface of the water.
3. The 360° <i>Spin</i> is executed rapidly and is completed with a <i>Vertical Descent</i> executed rapidly.			3. Uniform motion of the <i>Spin</i> and <i>Vertical Descent</i> each performed rapidly.
4. A <i>descending Spin</i> must start at the height of the vertical and be completed as the ankles reach the surface of the water.			4.1 Stability and vertical alignment before, during and at completion of the designated rotation. 4.2 Simultaneous rotation and descent of the body with even drop spaces to complete the spin as the ankles reach the surface of the water.
e) <b>360° Spin/Spinning 360°</b> : a <i>descending Spin</i> with a rotation of 360°.	39.0		The acceptable allowance for a 360° <i>Spin</i> rotation is up to ¼ less than/more than the required rotation.

**Figure – 144 RIO STRAIGHT LEG (cont.)**
**DIFFICULTY – 3.1**
**BM 10 Vertical Descent - from ankle level**

Basic Movement Description	NVT	Diagrams	Major Desired Actions
----------------------------	-----	----------	-----------------------

1. Maintaining a **Vertical Position** the body descends along its longitudinal axis until the toes are submerged.

○

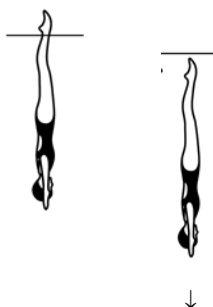

1. See BP 6 **Vertical Position**. The *Vertical Descent* is executed rapidly.



**11.3.10 Figure – 421 WALKOVER BACK CLOSING 360°**
**DIFFICULTY – 2.4**

From a **Back Layout Position** a *Surface Arch Position* is assumed. One leg is lifted in a 180° arc over the surface of the water to a **Split Position**. With continuous motion a rotation of 360° is executed as the legs are symmetrically lifted and closed to a **Vertical Position**. A *Vertical Descent* is executed.







					Total
NVT=	12.0	29.0	27.0	14.0	82
PV =	1.46	3.54	3.29	1.71	10

Figure Description	NVT	Diagrams	Major Desired Actions
1. From a <b>Back Layout Position</b> a <i>Surface Arch Position</i> is assumed.	12.0	 	1. See BP 1 <b>Back Layout Position</b> , BP 13 <b>Surface Arch Position</b> and BM 14 <i>To Assume a Surface Arch Position</i> .  Continuous movement evident from the <b>Back Layout Position</b> to the <b>Surface Arch Position</b> .

**Figure – 421 WALKOVER BACK CLOSING 360° (cont.)**

**DIFFICULTY – 2.4**

Figure Description	NVT	Diagrams	Major Desired Actions
2. One leg is lifted in a 180° arc over the surface of the water to a <b>Split Position</b> .	29.0		<p>2.1 Both legs remain fully extended.</p> <p>2.2 Hips remain stationary and aligned horizontally. 2.3 Hip height remains constant and at the surface of the water.</p> <p>2.4 Continuous uniform motion of arcing leg to BP 16a <b>Surface Split Position</b>.</p>
3. With continuous motion a rotation of 360° is executed as the legs are symmetrically lifted and closed to a <b>Vertical Position</b> .	27.0		<p>3.1 Both legs are always equidistant from the surface of the water with a 90° angle between them at the halfway point of the 360° rotation.</p> <p>3.2 The rotation and the closing action of the legs to achieve BP 6 <b>Vertical Position</b> occurs simultaneously.</p> <p>3.3 Height remains constant and longitudinal axis maintained throughout the rotation.</p> <p>3.4 The <b>Vertical Position</b> is held only long enough to define the position and to demonstrate completion of the transition prior to the descent.</p>
4. A <i>Vertical Descent</i> is executed.	14.0		<p>4. See BM 10 <i>Vertical Descent</i>.</p>

**BP 1 Back Layout Position**

Body Position Description	Diagrams	Major Desired Actions
1. Body extended with face, chest, thighs, and feet at the surface of the water.		<p>1. Gives the impression that the body is stretched horizontally to its maximum. Front of the trunk will also be at the surface of the water.</p>

**Figure – 421 WALKOVER BACK CLOSING 360° (cont.)**
**DIFFICULTY – 2.4**
**BP 1 Back Layout Position (cont.)**

Body Position Description	Diagrams	Major Desired Actions
<p>2. Head (ears specifically), hips and ankles in horizontal alignment.</p>		<p>2. Judgement is made by checking visual points of the horizontal alignment: ears, shoulder joints, hip joints and ankles. This imaginary line should also pass through the middle of the side of the trunk.</p>

**BP 13 Surface Arch Position**

Body Position Description	Diagrams	Major Desired Actions
<p>1. Lower back arched with hips, shoulders, and head on a vertical line.</p>		<p>1. Hip joints and shoulder joints on a horizontal line with both of these alignments 'square' and parallel to one another. Head (ears specifically) in line with shoulders.</p>
<p>2. Legs together and at the surface of the water.</p>		<p>2. Hips joints at the surface of the water.</p>

**BP 16 Split Position**

Body Position Description	Diagrams	Major Desired Actions
<p>1. Legs evenly split forward and back.</p> <p>2. The legs are parallel to the surface of the water.</p> <p>3. Lower back arched, with hips, shoulders, and head on a vertical line.</p> <p>4. 180° angle between the extended legs (flat split), with inside of each leg aligned on opposite sides of a horizontal line, regardless of the height of the hips.</p>		<p>1. Full extension of the legs at or above the surface of the water.</p> <p>4. Flat split.</p> <p>Hip joints and shoulder joints on a horizontal line, with both of these alignments 'square' and parallel to each other.</p>

**a) Surface Split Position**

1. Legs are dry at the surface of the water.





1. Full extension of the legs. Crotch and legs dry at the surface of the water.

**Figure – 421 WALKOVER BACK CLOSING 360° (cont.)**
**DIFFICULTY – 2.4**
**BP 6 Vertical Position**

Body Position Description	Diagrams	Major Desired Actions
1. Body extended perpendicular to the surface of the water; legs together, head downward.		1. Full extension of the body.
2. Head (ears specifically), hips and ankles in line.		2. Judgement is made by checking visual points of the vertical alignment: ears, shoulder joints, hip joints and ankles.

**BM 14 To Assume a Surface Arch Position/A Surface Arch Position is Assumed**

Basic Movement Description	NVT	Diagrams	Major Desired Actions
1. From a <b>Back Layout Position</b> with the head leading, the head, hips and feet move along the surface of the water.			1. See BP 1 <b>Back Layout Position</b> .
2. With continuous movement the head leaves the surface of the water as the back is arched more to assume a <b>Surface Arch Position</b> with the hips occupying the position of the head at the beginning of this action.	12.0		2. Continuous uniform movement from the BP 1 <b>Back Layout Position</b> to BP 13 <b>Surface Arch Position</b> . Hip height remains constant. Hip joints on a horizontal line.

**BM 10 Vertical Descent**

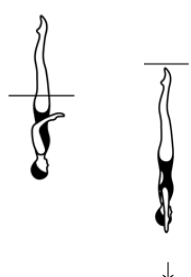
Basic Movement Description	NVT	Diagrams	Major Desired Actions
1. Maintaining a <b>Vertical Position</b> the body descends along its longitudinal axis until the toes are submerged.	14.0		1. See BP 6 <b>Vertical Position</b> . The tempo of the descent is uniform and at the same speed as the rest of the figure.

**11.3.11 Figure – 440d IPANEMA SPINNING 180°**
**DIFFICULTY – 3.1**

From a **Back Layout Position** a *Bent Knee Surface Arch Position* is assumed. The horizontal leg is lifted to vertical as the bent leg is straightened to assume a **Vertical Position**. The legs are lowered to a **Front Pike Position**. A rapid 180° rotation is executed as the legs are lifted to a **Vertical Position**. Continuing in the same direction a rapid 180° *Spin* is executed.







							Total
NVT=	17.5	21.0	33.0	33.0	19.0	0	123.5
PV=	1.42	1.70	2.67	2.67	1.54	0	10

Figure Description	NVT	Diagrams	Major Desired Actions
--------------------	-----	----------	-----------------------

1. From a **Back Layout Position** a *Bent Knee Surface Arch Position* is assumed.

17.5

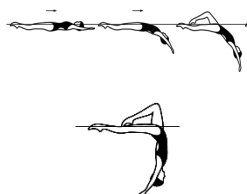

1. See BP 1 **Back Layout Position**, BP 14d **Bent Knee Surface Arch Position** and BM 15 *To Assume a Bent Knee Surface Arch Position*.  
Continuous uniform movement from **Back Layout Position** to **Bent Knee Surface Arch Position**.

2. The horizontal leg is lifted to vertical as the bent leg is extended to assume a **Vertical Position**.

21.0

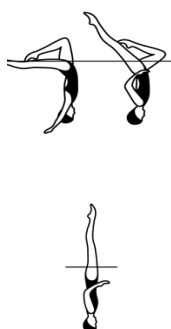





2.1 See BP 14d **Bent Knee Vertical Surface Arch Position** and BP 6 **Vertical Position**.

Horizontal alignment of hips and shoulders 'square' and maintained during the lift.

2.2 The bent leg straightens to **Vertical Position** simultaneously with completion of the feet joining. The bent leg is extended upward at the same rate of space and time of the vertical leg.

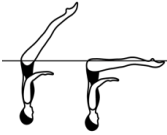
2.3 The hips maintain constant height and are the pivot point for the lift to **Vertical Position**.

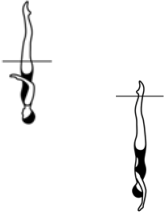
**Figure – 440d IPANEMA SPINNING 180° (cont.)**
**DIFFICULTY – 3.1**

Figure Description	NVT	Diagrams	Major Desired Actions
3. The legs are lowered to a <b>Front Pike Position</b> .	33.0		3. Without loss of height or horizontal alignment of head, hips and shoulders, the legs are lowered to BP 10 <b>Front Pike Position</b> .
4. A rapid 180° rotation is executed as the legs are lifted to a <b>Vertical Position</b> .	33.0		4. Without loss of height, the body rapidly rotates 180° as it straightens to BP 6 <b>Vertical Position</b> . At the halfway point of the rotation the legs are at a 45° angle to the surface of the water.
5. Continuing in the same direction a rapid 180° <i>Spin</i> is executed.	19.0		5. See BM 13 <i>Spins</i> and BM 13d 180° <i>Spin</i> .
	0		

**BP 1 Back Layout Position**

Body Position Description	Diagrams	Major Desired Actions
1. Body extended with face, chest, thighs, and feet at the surface of the water.		1. Gives the impression that the body is stretched horizontally to its maximum. Front of the trunk will also be at the surface of the water.
2. Head (ears specifically), hips and ankles in horizontal alignment.		2. Judgement is made by checking visual points of the horizontal alignment: ears, shoulder joints, hip joints and ankles. This imaginary line should also pass through the middle of the side of the trunk.

**Figure – 440d IPANEMA SPINNING 180° (cont.)**
**DIFFICULTY – 3.1**
**BP 14 Bent Knee Position**

Body Position Description	Diagrams	Major Desired Actions
<p>One leg bent with the toe of the bent leg in contact with the inside of the extended leg at the knee or higher.</p>		<p>The relationship of the toe of the bent leg to the extended leg may vary depending on the figure but should remain constant once established, and not extend in front of or behind the extended leg.</p>
<p><b>d) Bent Knee Surface Arch Position</b></p> <p>1. Lower back arched with hips, shoulders, and head on a vertical line.</p>		<p>1.1 In BP 13 <b>Surface Arch Position</b> shoulder joints and hip joints on a horizontal line with both of these alignments 'square' and parallel to one another. Head (ears specifically) in line with shoulders.</p> <p>1.2 Hips at the surface of the water.</p>
<p>2. The thigh of the bent leg is perpendicular to the surface of the water.</p>		<p>2. 90° angle between the thigh of the bent leg and the surface of the water. An air pocket will be evident between the back of the thigh and calf of the bent leg and the surface of the water.</p>

**BP 6 Vertical Position**

Body Position Description	Diagrams	Major Desired Actions
<p>1. Body extended perpendicular to the surface of the water; legs together, head downward.</p>		<p>1. Full extension of the body.</p>
<p>2. Head (ears specifically), hips and ankles in line.</p>		<p>2. Judgement is made by checking visual points of the vertical alignment: ears, shoulder joints, hip joints and ankles.</p>



**BP 10 Front Pike Position**

Body Position Description	Diagrams	Major Desired Actions
<p>1. Body bent at hips to form a 90° angle.</p>		<p>1. Exact 90° angle.</p>

**Figure – 440d IPANEMA SPINNING 180° (cont.)**
**DIFFICULTY – 3.1**
**BP 10 Front Pike Position (cont.)**

Body Position Description	Diagrams	Major Desired Actions
2. Legs extended and together.		2. Full extension of legs, with ankles aligned with hip joints.
3. Trunk extended with the back straight and head in line.		3. Back flat, with vertical alignment of ears, shoulder joints and hip joints once the position is established.

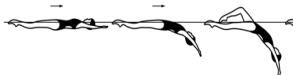
**BM 15 To Assume a Bent Knee Surface Arch Position / A Bent Knee Surface Arch is Assumed**



Basic Movement Description	NVT	Diagrams	Major Desired Actions
1. From a <b>Back Layout Position</b> with the head leading, the head, hips and feet move along the surface of the water.			1. See BP 1 <b>Back Layout Position</b> .
2. With continuous movement the head leaves the surface of the water as the back is arched more to assume a <b>Bent Knee Surface Arch Position</b> with the hips occupying the position of the head at the beginning of this action.	17.5		2.1 Continuous uniform movement from the BP 1 <b>Back Layout Position</b> to BP 14d <b>Bent Knee Surface Arch Position</b> . Hip height remains constant. Hip joints on a horizontal line. 2.2 The toe of the bent leg must remain in contact with the inside of the extended leg while assuming the <b>Bent Knee Surface Arch Position</b> .

**BM 13 Spin**

Basic Movement Description	NVT	Diagrams	Major Desired Actions
1. A <i>Spin</i> is a rotation in a <b>Vertical Position</b> .			1. See BP 6 <b>Vertical Position</b> . Height and position attained before the <i>Spin</i> begins.
2. The body remains on its longitudinal axis throughout the rotation.			2. The longitudinal axis runs through the centre of the body and is perpendicular to the surface of the water.
3. The 180° Spin is executed rapidly and is completed with a Vertical Descent executed rapidly.			3. Uniform motion of the Spin and Vertical Descent each performed rapidly.



**Figure – 440d IPANEMA SPINNING 180° (cont.)**
**DIFFICULTY – 3.1**
**BM 13 Spin (cont.)**

Basic Movement Description	NVT	Diagrams	Major Desired Actions
<p>4. A <i>descending Spin</i> must start at the height of the vertical and be completed as the ankles reach the surface of the water.</p>			<p>4.1 Stability and vertical alignment before, during and at completion of the designated rotation.</p>
<p><b>d) 180° Spin/Spinning 180°:</b> a <i>descending Spin</i> with a rotation of 180°.</p>	<p>19.0</p>		<p>4.2 Simultaneous rotation and descent of the body with even drop spaces to complete the spin as the ankles reach the surface of the water.</p>
	<p>0</p>		<p>d) The acceptable allowance for a 180° spin rotation is up to ¼ less than/more than the required rotation.</p>

**11.3.12 Figure – 311j KIP COMBINED SPIN (360° + 360°)**
**DIFFICULTY – 2.4**

From a **Back Layout Position** the knees, shins and toes are drawn along the surface of the water to assume a **Tuck Position**. With continuous motion the tuck becomes more compact, and a partial Somersault Back Tuck is executed until the shins are perpendicular to the surface of the water. The trunk unrolls as the legs are straightened to assume a **Vertical Position** midway between the former vertical line through the hips and the former vertical line through the head and the shins. A rapid *Combined Spin* (360° + 360°) is executed followed by a rapid *Vertical Descent*.













							Total
NVT=	3.0	2.0	23.0	40.0	14.0		82
PV =	0.37	0.24	2.80	4.88	1.71		10

Figure Description	NVT	Diagrams	Major Desired Actions
<p>1. From a <b>Back Layout Position</b> the knees, shins and toes are drawn along the surface of the water to assume a <b>Tuck Position</b>. With continuous motion the tuck becomes more compact, and a partial Somersault Back Tuck is executed until the shins are perpendicular to the surface of the water.</p>	<p>3.0</p> <p>2.0</p>	  	<p>1.1 See BP 1 <b>Back Layout</b> and BP 9 <b>Tuck Positions</b>. With the head and shoulders remaining stationary, the knees, shins and toes are drawn to the body to assume a tight tuck at the position occupied by the trunk in the <b>Back Layout Position</b>.</p> <p>1.2 There is continuous motion from the initiation of the leg draw to achievement of the inverted BP 9 <b>Tuck Position</b>.</p>
<p>2. The trunk unrolls as the legs are straightened to assume a <b>Vertical Position</b> midway between the former vertical line through the hips and the former vertical line through the head and shins.</p>	23.0		<p>2.1 BP 6 <b>Vertical Position</b> and maximum height achieved simultaneously.</p> <p>2.2 The <b>Vertical Position</b> is held only long enough to define the position and to demonstrate completion of the transition prior to the <i>Combined Spin</i>.</p>

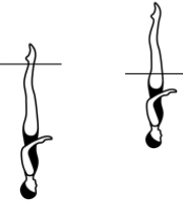

**Figure – 311j**
**KIP COMBINED SPIN (360° + 360°) (cont.)**
**DIFFICULTY – 2.4**

Figure Description	NVT	Diagrams	Major Desired Actions
3. A rapid <i>Combined Spin</i> (360° + 360°) is executed followed by a rapid <i>Vertical Descent</i> .	40.0		3. See BM 13 <i>Spins</i> and 13j) <i>Combined Spins</i> and BM 10 <i>Vertical Descent</i> .
	14.0		

**BP 1 Back Layout Position**

Body Position Description	Diagrams	Major Desired Actions
1. Body extended with face, chest, thighs, and feet at the surface of the water.		1. Gives the impression that the body is stretched horizontally to its maximum. Front of the trunk will also be at the surface of the water.
2. Head (ears specifically), hips and ankles in horizontal alignment.		2. Judgement is made by checking visual points of the horizontal alignment: ears, shoulder joints, hip joints and ankles. This imaginary line should also pass through the middle of the side of the trunk.

**BP 9 Tuck Position**

Body Position Description	Diagrams	Major Desired Actions
1. Body as compact as possible, with the back rounded and the legs together.		1. Legs together with shins at the surface of the water and tucked tightly to the front of the body.
2. Heels close to buttocks.		2. Compact tuck. Chin tucked in.

**Figure – 311j KIP COMBINED SPIN (360° + 360°) (cont.)**
**DIFFICULTY – 2.4**
**BP 9 Tuck Position (cont.)**

Body Position Description	Diagrams	Major Desired Actions
3. Head close to knees.		3. In BP 9 inverted <b>Tuck Position</b> shins are perpendicular to the surface of the water, buttocks remain at the surface and the water level is between the ankle and mid foot.

**BP 6 Vertical Position**

Body Position Description	Diagrams	Major Desired Actions
1. Body extended perpendicular to the surface of the water; legs together, head downward.		1. Full extension of the body.
2. Head (ears specifically), hips and ankles in line.		2. Judgement is made by checking visual points of the vertical alignment: ears, shoulder joints, hip joints and ankles.

**BM 13 Spins**

Basic Movement Description	NVT	Diagrams	Major Desired Actions
1. A Spin is a rotation in a <b>Vertical Position</b> .			1. See BP 6 <b>Vertical Position</b> . Height and position attained before the <i>Spin</i> begins.
2. The body remains on its longitudinal axis throughout the rotation.			2. The longitudinal axis runs through the centre of the body and is perpendicular to the surface of the water.
3. A rapid <i>Combined Spin</i> (360° + 360°) is executed in uniform motion and is completed with a rapid <i>Vertical Descent</i> .			3. See BM 10 <i>Vertical Descent</i> .

**Figure – 311j KIP COMBINED SPIN (360° + 360°) (cont.)**
**DIFFICULTY – 2.4**
**BM 13 Spins (cont.)**

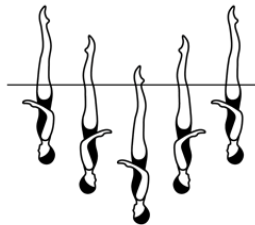
Basic Movement Description	NVT	Diagrams	Major Desired Actions
<p>4. A rapid <i>descending Spin</i> must start at the height of the vertical and be completed as the ankles reach the surface of the water.</p> <p>6. A rapid <i>ascending Spin</i> begins with the water level at the ankles.</p> <p>7. A vertical upward <i>Spin</i> is executed until a water level is established between the knees and hips.</p> <p>8. An ascending Spin is finished with a Vertical Descent.</p> <p><b>j) Combined Spin:</b> a descending Spin of 360° followed without a pause by an equal ascending Spin in the same direction. The ascending Spin reaches the same height where the descending Spin started.</p>	40.0		<p>4.1 Stability and vertical alignment before, during and at completion of the designated rotation.</p> <p>4.2 Simultaneous rotation and descent of the body with even drop spaces to complete the spin as the ankles reach the surface of the water.</p> <p>6.1 Body rises and rotates simultaneously and evenly.</p> <p>6.2 The designated rotation is completed simultaneously with achievement of maximum height.</p> <p>6.3 Stability and vertical alignment maintained before, during and at completion of the designated rotation.</p> <p><b>BM 6 Vertical Position</b> evident prior to <i>Vertical Descent</i>.</p> <p>The <i>Combined Spin</i> must be rapid. There is no <i>Spin</i> allowance for <i>Combined Spins</i>.</p>

**BM 10 Vertical Descent**

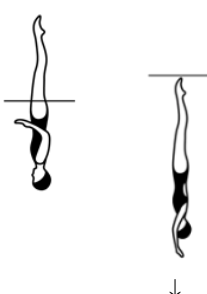
Basic Movement Description	NVT	Diagrams	Major Desired Actions
<p>1. Maintaining a <b>Vertical Position</b> the body descends along its longitudinal axis until the toes are submerged.</p>	14.0		<p>1. See BP 6 <b>Vertical Position</b>. The tempo of the descent is rapid.</p>

**11.4 ANALYSIS OF 12 & UNDER World Aquatics FIGURES 2022-2025**

Group Type	Group Number	Figure Number	Figure Name	DD
<b>Compulsory</b>		106	Straight Ballet Leg	1.6
		301	Barracuda	1.8
<b>Optional</b>	<b>1</b>	359	Front Ariana	2.2
		348	Tower	1.9
	<b>2</b>	363	Water Drop	1.8
		401	Swordfish	2.1
	<b>3</b>	311	Kip	1.6
		227d	Swanita Spinning 180°	1.9

**11.4.1 Compulsory Group**
**11.4.1.1 Figure – 106 STRAIGHT BALLET LEG**
**DIFFICULTY – 1.6**

From a **Back Layout Position**, one leg is raised straight to a **Ballet Leg Position**. The Ballet Leg is lowered.





				Total
NVT=	18.5	11.0	10.5	40
PV =	4.63	2.75	2.63	10

Figure Description	NVT	Diagrams	Major Desired Actions
--------------------	-----	----------	-----------------------

1. From a **Back Layout Position**, one leg is raised straight to a **Ballet Leg Position**.



1. See BM 1B *To Assume A Straight Ballet Leg.*

18.5



2. The Ballet Leg is lowered.

11.0



2. See BM 2 *To Lower a Ballet Leg.*

10.5



**Figure – 106 STRAIGHT BALLET LEG (cont.)**
**DIFFICULTY – 1.6**
**BP 1 Back Layout Position**

Body Position Description	Diagrams	Major Desired Actions
1. Body extended with face, chest, thighs, and feet at the surface of the water.		1. Gives the impression that the body is stretched horizontally to its maximum. Front of the trunk will also be at the surface of the water.
2. Head (ears specifically), hips and ankles in horizontal alignment.		2. Judgement is made by checking visual points of the horizontal alignment: ears, shoulder joints, hip joints and ankles. This imaginary line should also pass through the middle of the side of the trunk.

**BP 3 Ballet Leg Position**

Body Position Description	Diagrams	Major Desired Actions
<b>a) Surface</b> 1. Body in <b>Back Layout Position</b> .		1. See BP 1 <b>Back Layout Position</b> . Ears, shoulder joints, hip joints and ankle of extended leg in line at maximum horizontal alignment.
2. One leg extended perpendicular to the surface of the water.		2. 90° angle between the extended leg and the surface of the water and between the extended leg and the trunk with maximum horizontal alignment maintained throughout.

**BP 14 Bent Knee Position**

Body Position Description	Diagrams	Major Desired Actions
One leg bent with the toe of the bent leg in contact with the inside of the extended leg at the knee or higher.		The relationship of the toe of the bent leg to the extended leg may vary depending on the figure but should remain constant once established, and not extend in front of or behind the extended leg.
<b>b) Bent Knee Back Layout Position</b> 1. Body extended in <b>Back Layout Position</b> .		1. In BP 1 <b>Back Layout Position</b> ears, shoulder joints, hip joints and ankle of extended leg in line at maximum horizontal alignment.



**Figure – 106 STRAIGHT BALLET LEG (cont.)**
**DIFFICULTY – 1.6**
**BP 14 Bent Knee Position (cont.)**

Body Position Description	Diagrams	Major Desired Actions
---------------------------	----------	-----------------------

**b) Bent Knee Back Layout Position (cont.)**

2. The thigh of the bent leg is perpendicular to the surface of the water.

2. 90° angle between the thigh and the surface of the water, and 90° angle maintained between the thigh and the trunk. At maximum height an air pocket will be evident between the back of the thigh and calf of the bent leg and the surface of the water.

**BM 1B To Assume a Straight Ballet Leg/A Straight Ballet Leg is assumed**

Basic Movement Description	NVT	Diagrams	Major Desired Actions
----------------------------	-----	----------	-----------------------

1. From a **Back Layout Position** one leg is raised straight to a **Ballet Leg Position**.



1.1 See BP 1 **Back Layout Position**. Ears, shoulder joints, hip joints and ankles of extended legs at maximum horizontal alignment.



1.2 One leg is raised straight to BP 3a **Surface Ballet Leg Position** while keeping the horizontal alignment of the horizontal leg and trunk with minimal drop of the hips.

1.3 The head and trunk remain stationary throughout.

**BM 2 To Lower a Ballet Leg/A Ballet Leg is lowered**

Basic Movement Description	NVT	Diagrams	Major Desired Actions
----------------------------	-----	----------	-----------------------

1. From a **Ballet Leg Position** the ballet leg is bent without movement of the thigh to a **Bent Knee Back Layout Position**.



1. See BP 3a **Surface Ballet Leg Position** and BP 14b **Bent Knee Back Layout Position**. Height remains constant throughout the movement.

2. The toe moves along the inside of the extended leg until a **Back Layout Position** is assumed.

11.0



2.1 Full extension in BP 1 **Back Layout Position** to be achieved as the feet are joined.

10.5



2.2 The head and trunk remain stationary throughout.

11.4.1.2 **Figure – 301 BARRACUDA**
**DIFFICULTY – 1.8**

From a **Back Layout Position** the legs are raised to vertical as the body is submerged to a **Back Pike Position** with the toes just under the surface of the water. A *Thrust* is executed to a **Vertical Position**. A *Vertical Descent* is executed at the same tempo as the *Thrust*.





				Total
NVT=	7.0	31.0	13.0	51
PV =	1.37	6.08	2.55	10

Figure Description	NVT	Diagrams	Major Desired Actions
--------------------	-----	----------	-----------------------

1. From a **Back Layout Position** the legs are raised to vertical as the body is submerged to a **Back Pike Position** with the toes just under the surface of the water.

7.0

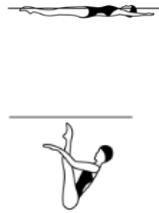

1.1 See BP 1 **Back Layout Position** and BP 11 **Back Pike Position**.

In the submerged **Back Pike Position** the hips are directly beneath the position they occupied in the **Back Layout Position**.

1.2 The pike is held only long enough to define the position and complete the transition.

2. A *Thrust* is executed to **Vertical Position**.

31.0

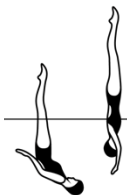

2.1 See BM 9 *Thrust*. Obvious increase in speed.

2.2 The body unrolls under the legs to assume BP 6 **Vertical Position**.

2.3 Maximum height and clearly defined BP 6 **Vertical Position** prior to initiation of the descent.

**Thrust Allowance**

Deviation allowances for the *Thrust* action are unique and allow for the legs to be up to an additional 15° off the vertical line.

Deductions are as follows:

Deviation Type	Angle Deviation	Deduction Amount
Small Deviation	16° – 30°	.2
Medium Deviation	31° – 45°	.5
Large Deviation	More than 45°	1.0

**Figure – 301 BARRACUDA (cont.)**
**DIFFICULTY – 1.8**

Figure Description	NVT	Diagrams	Major Desired Actions
3. A <i>Vertical Descent</i> is executed at the same tempo as the <i>Thrust</i> .	13.0		3. See BM 10 <i>Vertical Descent</i> . Must be rapid and remain on the same vertical line as the <i>Thrust</i> .

**BP 1 Back Layout Position**

Body Position Description	Diagrams	Major Desired Actions
1. Body extended with face, chest, thighs, and feet at the surface of the water.		1. Gives the impression that the body is stretched horizontally to its maximum. Front of the trunk will also be at the surface of the water.
2. Head (ears specifically), hips and ankles in horizontal alignment.		2. Judgement is made by checking visual points of the horizontal alignment: ears, shoulder joints, hip joints and ankles. This imaginary line should also pass through the middle of the side of the trunk.

**BP 11 Back Pike Position**

Body Position Description	Diagrams	Major Desired Actions
1. Body bent at hips to form an acute angle of 45° or less.		1. Legs close to chest while maintaining the straight-line alignment of the extended spine and head.
2. Legs extended and together.		2. Full extension of the legs, ankles, and feet.
3. Trunk extended with the back straight and head in line.		3. Back flat, with ears, shoulder joints, middle of side of torso, and hip joints aligned. Once the pike position is established the degree of the angle remains constant.

**Figure – 301 BARRACUDA (cont.)**
**DIFFICULTY – 1.8**
**BP 6 Vertical Position**

Body Position Description	Diagrams	Major Desired Actions
1. Body extended perpendicular to the surface of the water; legs together, head downward.		1. Full extension of the body.
2. Head (ears specifically), hips and ankles in line.		2. Judgement is made by checking visual points of the vertical alignment: ears, shoulder joints, hip joints and ankles.

**BM 9 Thrust**

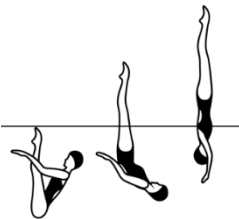
Basic Movement Description	NVT	Diagrams	Major Desired Actions
1. From a <b>Submerged Back Pike Position</b> with the legs perpendicular to the surface of the water a vertical upward movement of the legs and hips is rapidly executed as the body unrolls to assume a <b>Vertical Position</b> .	31.0		<p>1.1 See BP 11 <b>Back Pike Position</b>. The toes are just below the surface of the water. Once established, the degree of the angle of the pike position between the legs and the body must not change prior to initiation of the <i>Thrust</i>.</p> <p>1.2 See BP 6 <b>Vertical Position</b>. The body unrolls rapidly under the legs to assume BP 6 <b>Vertical Position</b> along the same perpendicular line to the surface of the water established by the legs in the BP 11 <b>Back Pike Position</b>.</p> <p>1.3 Obvious increase in speed from the initiation of body unrolling through the vertical upward movement.</p>
2. Maximum height desirable.			2. Maximum height and BP 6 <b>Vertical Position</b> achieved simultaneously.

**Thrust Allowance**

Deviation allowances for the *Thrust* action are unique and allow for the legs to be up to an additional 15° off the vertical line. Deductions are as follows:

Deviation Type	Angle Deviation	Deduction Amount
Small Deviation	16° – 30°	.2
Medium Deviation	31° – 45°	.5
Large Deviation	More than 45°	1.0

**Figure – 301 BARRACUDA (cont.)**

**DIFFICULTY – 1.8**

**BM 10 Vertical Descent – from Thrust**

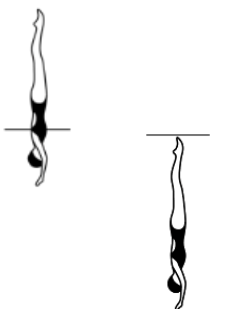
Basic Movement Description	NVT	Diagrams	Major Desired Actions
<p>1. Maintaining a <b>Vertical Position</b> the body descends along its longitudinal axis until the toes are submerged.</p>	<p>13.0</p>		<p>1. See BP 6 <b>Vertical Position</b>. The <i>Vertical Descent</i> is executed at the same tempo as the <i>Thrust</i>.</p>

**11.4.2 Optional Group 1**
**11.4.2.1 Figure – 359 FRONT ARIANA**
**DIFFICULTY – 2.2**

From a **Front Layout Position** a *Front Pike Position* is assumed. One leg is lifted in a 180° arc over the surface of the water to a **Split Position**. Maintaining the relative position of the legs to the surface of the water, an *Ariana Rotation* is performed. A *Walkout Front* is executed.







							Total
NVT		6.0	20.0	17.0	23.0	7.0	73
PVT		0.82	2.74	2.33	3.15	0.96	10

Figure Description	NVT	Diagrams	Major Desired Actions
--------------------	-----	----------	-----------------------

1. From a **Front Layout Position** a **Front Pike Position** is assumed.

6.0

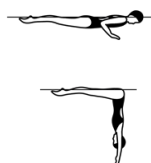

1. See BP 2 **Front Layout**, BP 10 **Front Pike Position** and BM 3 *To Assume a Front Pike Position*.

Smooth even movement downwards of the trunk.

2. One leg is lifted in a 180° arc over the surface of the water to a **Split Position**.

20.0



2.1 See 16a **Surface Split Position**. Constant height and continuous uniform motion to achieve BP 16a **Surface Split Position**. 2.2 Trunk maintains its vertical alignment, with hips and shoulders 'square'.

2.3 Full extension of the horizontal leg at the surface of the water.

3. Maintaining the relative position of the legs to the surface of the water, an *Ariana Rotation* is performed.

17.0

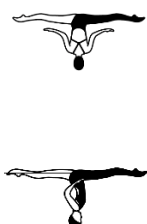

3. See BP 16a **Surface Split Position** and BM 16 *Ariana Rotation*. The trunk turns 180° around its longitudinal axis, while the legs rotate horizontally at the surface of the water, with full extension of the legs maintained throughout.



4. A *Walkout Front* is executed.

23.0





See BM 6a *Walkout Front* and BM 5 *Arch to Back Layout Position*.

**Figure – 359 FRONT ARIANA (cont.)**
**DIFFICULTY – 2.2**
**BP 2 Front Layout Position**

Body Position Description	Diagrams	Major Desired Actions
1. Body extended with head, upper back, buttocks, and heels at the surface of the water.		1. Gives the impression that the body is stretched horizontally to its maximum. Judgement made by checking visual points of the horizontal alignment: ears, shoulder joints, hip joints and heels.
2. Unless otherwise specified, face may be in or out of the water.		2. Once the head position is established as in or out of the water the position is maintained. When the face is out of the water the ears will not be on the horizontal axis and the back may be slightly lower and arched. Hip joints, calves and heels remain at the surface of the water.

**BP 10 Front Pike Position**

Body Position Description	Diagrams	Major Desired Actions
1. Body bent at hips to form a 90° angle.		1. Exact 90° angle.
2. Legs extended and together.		2. Full extension of legs, with ankles aligned with hip joints.
3. Trunk extended with the back straight and head in line.		3. Back flat, with vertical alignment of ears, shoulder joints and hip joints once the position is established.

**BP 16 Split Position**

Body Position Description	Diagrams	Major Desired Actions
1. Legs evenly split forward and back.		1. Full extension of the legs at or above the surface of the water.
2. The legs are parallel to the surface of the water.		
3. Lower back arched, with hips, shoulders, and head on a vertical line.		

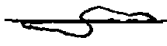
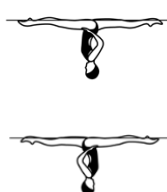

**Figure – 359 FRONT ARIANA (cont.)**
**DIFFICULTY – 2.2**
**BP 16 Split Position (cont.)**

Body Position Description	Diagrams	Major Desired Actions
<p>4. 180° angle between the extended legs (flat split), with inside of each leg aligned on opposite sides of a horizontal line, regardless of the height of the hips.</p>		<p>4. Flat split. Hip joints and shoulder joints on a horizontal line, with both of these alignments 'square' and parallel to each other.</p>
<p>a) Surface Split Position</p> <p>1. Legs are dry at the surface of the water.</p>		<p>1. Full extension of the legs. Crotch and legs dry at the surface of the water.</p>

**BP 13 Surface Arch Position**

Body Position Description	Diagrams	Major Desired Actions
<p>1. Lower back arched with hips, shoulders, and head on a vertical line.</p>		<p>1. Hip joints and shoulder joints on a horizontal line with both of these alignments 'square' and parallel to one another. Head (ears specifically) in line with shoulders.</p>
<p>2. Legs together and at the surface of the water.</p>		<p>2. Hips joints at the surface of the water.</p>

**BP 1 Back Layout Position**

Body Position Description	Diagrams	Major Desired Actions
<p>1. Body extended with face, chest, thighs, and feet at the surface of the water.</p>		<p>1. Gives the impression that the body is stretched horizontally to its maximum. Front of the trunk will also be at the surface of the water.</p>
<p>2. Head (ears specifically), hips and ankles in horizontal alignment.</p>		<p>2. Judgement is made by checking visual points of the horizontal alignment: ears, shoulder joints, hip joints and ankles. This imaginary line should also pass through the middle of the side of the trunk.</p>



**Figure – 359 FRONT ARIANA (cont.)**

**DIFFICULTY – 2.2**

**BM 3 To Assume a Front Pike Position/A Front Pike Position is assumed**

Basic Movement Description	NVT	Diagrams	Major Desired Actions
<p>1. From a <b>Front Layout Position</b> with the face in the water the trunk moves downward to assume a <b>Front Pike Position</b>. The buttocks, legs and feet travel along the surface of the water until the hips occupy the position of the head at the beginning of this action.</p>	6.0		<p>1.1 See BP 2 <b>Front Layout Position</b> and BP 10 <b>Front Pike Position</b>. Uniform motion in downward movement of the trunk. The trunk remains straight throughout the movement. Hips and head lock into position simultaneously.</p> <p>1.2 Unless otherwise specified, <i>to Assume a Front Pike Position</i> starts from a <b>Front Layout Position</b>.</p>





**BM 16 Ariana Rotation**

Basic Movement Description	NVT	Diagrams	Major Desired Actions
<p>1. From a <b>Split Position</b> maintaining the relative position of the legs to the surface of the water the hips rotate 180°.</p>	17.0		<p>1.1 See BP 16a <b>Surface Split Position</b>.</p> <p>1.2 The trunk turns 180° around its longitudinal axis, while the legs rotate horizontally with no lateral movement at the surface of the water.</p> <p>1.3 Height and extension of the <b>Split Position</b> is maintained throughout.</p> <p>1.4 Uniform motion throughout.</p> <p>1.5 Lower back arched with hips, shoulders, and head on a vertical line.</p> <p>1.6 Hip joints and shoulder joints on a horizontal line with both of these alignments 'square' and parallel to each other.</p>

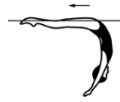
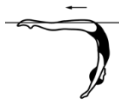

**Figure – 359 FRONT ARIANA (cont.)**

**DIFFICULTY – 2.2**

**BM 6 Walkout**

Basic Movement Description	NVT	Diagrams	Major Desired Actions
<p>1. These movements start in a <b>Split Position</b> unless otherwise specified in the figure description. The hips remain stationary as one leg is lifted in an arc over the surface of the water to meet the opposite leg.</p> <p><b>a) Walkout Front</b></p> <p>2. The front leg is lifted in a 180° arc over the surface of the water to meet the opposite leg in a <b>Surface Arch Position</b> and with continuous movement an <i>Arch to Back Layout Position</i> is executed.</p>	<p>23.0</p> <p>7.0</p>	   	<p>1. See BP 16a <b>Surface Split Position</b>.</p> <p>2.1 Hip height remains constant and at the surface of the water.</p> <p>2.2 Arcing leg moves continuously with uniform motion.</p> <p>2.3 Both legs maintain full extension.</p> <p>2.4 The trunk remains stationary until the feet join.</p> <p>2.5 No pause in BP 13 <b>Surface Arch Position</b>, however an accurate surface arch must be evident before the body begins to rise and straighten.</p> <p>2.6 Foot first surfacing motion begins when the feet are joined.</p> <p>2.7 See BP 13 <b>Surface Arch Position</b> and BM 5 <i>Arch to Back Layout Position</i>.</p>

**BM 5 Arch to Back Layout Position**

Basic Movement Description	NVT	Diagrams	Major Desired Actions
<p>1. From a <b>Surface Arch Position</b> the hips, chest, and face surface sequentially at the same point with foot first movement to a <b>Back Layout Position</b> until the head occupies the position of the hips at the beginning of this action.</p>	<p>7.0</p>	 	<p>1. See BP 13 <b>Surface Arch Position</b>. Sharp arch in the lower back. The body rises, straightens, and moves along the surface of the water with a stationary BP 1 <b>Back Layout Position</b> achieved as the face surfaces. Full extension maintained throughout.</p>

**11.4.2.2 Figure – 348 TOWER**
**DIFFICULTY – 1.9**

From a **Front Layout Position** a *Front Pike Position* is assumed. One leg is lifted to a **Fishtail Position**. The horizontal leg is lifted to a **Vertical Position**. A *Vertical Descent* is executed.











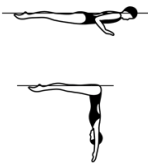

					Total
NVT=	6.0	14.5	20.5	14.0	55
PV =	1.09	2.64	3.73	2.55	10

Figure Description	NVT	Diagrams	Major Desired Actions
1. From a <b>Front Layout Position</b> a <i>Front Pike Position</i> is assumed.	6.0		1. See BP 2 <b>Front Layout</b> , BP 10 <b>Front Pike Position</b> and BM 3 <i>To Assume a Front Pike Position</i> .  Smooth even movement downwards of the trunk.
2. One leg is lifted to a <b>Fishtail Position</b> .	14.5		2.1 See BP 8 <b>Fishtail Position</b> . Height and vertical alignment of the trunk maintained throughout.  2.2 The <b>Fishtail Position</b> is held only long enough to define the position and to demonstrate completion of the transition.
3. The horizontal leg is lifted to a <b>Vertical Position</b> .	20.5		3.1 See BP 6 <b>Vertical Position</b> . Height is constant as the legs join, with the trunk and the vertical leg maintaining vertical alignment throughout.  3.2 The <b>Vertical Position</b> is held only long enough to define the position and to demonstrate completion of the transition prior to descent.
4. A <i>Vertical Descent</i> is executed.	14.0		4. See BM 10 <i>Vertical Descent</i> .

**Figure – 348 TOWER (cont.)**
**DIFFICULTY – 1.9**
**BP 2 Front Layout Position**

Body Position Description	Diagrams	Major Desired Actions
<p>1. Body extended with head, upper back, buttocks, and heels at the surface of the water.</p>		<p>1. Gives the impression that the body is stretched horizontally to its maximum. Judgement made by checking visual points of the horizontal alignment: ears, shoulder joints, hip joints and heels.</p>
<p>2. Unless otherwise specified, face may be in or out of the water.</p>		<p>2. Once the head position is established as in or out of the water the position is maintained. When the face is out of the water the ears will not be on the horizontal axis and the back may be slightly lower and arched. Hip joints, calves and heels remain at the surface of the water.</p>

**BP 10 Front Pike Position**

Body Position Description	Diagrams	Major Desired Actions
<p>1. Body bent at hips to form a 90° angle.</p>		<p>1. Exact 90° angle.</p>
<p>2. Legs extended and together.</p>		<p>2. Full extension of legs, with ankles aligned with hip joints.</p>
<p>3. Trunk extended with the back straight and head in line.</p>		<p>3. Back flat, with vertical alignment of ears, shoulder joints and hip joints once the position is established.</p>

**BP 8 Fishtail Position**

Body Position Description	Diagrams	Major Desired Actions
<p>1. Body extended in <b>Vertical Position</b> with one leg extended forward. The foot of the forward leg is at the surface of the water regardless of the height of the hips.</p>		<p>1. See BP 6 <b>Vertical Position</b> for body alignment. The foot of the forward leg must be at the surface of the water. Hip joints must be on a horizontal line.</p>

**Figure – 348 TOWER (cont.)**
**DIFFICULTY – 1.9**
**BP 6 Vertical Position**

Body Position Description	Diagrams	Major Desired Actions
1. Body extended perpendicular to the surface of the water; legs together, head downward.		1. Full extension of the body.
2. Head (ears specifically), hips and ankles in line.		2. Judgement is made by checking visual points of the vertical alignment: ears, shoulder joints, hip joints and ankles.

**BM 3 To Assume a Front Pike Position/A Front Pike Position is assumed**

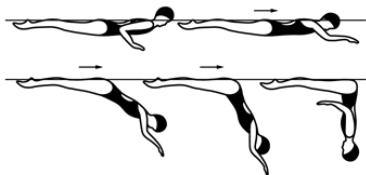
Basic Movement Description	NVT	Diagrams	Major Desired Actions
1. From a <b>Front Layout Position</b> with the face in the water the trunk moves downward to assume a <b>Front Pike Position</b> . The buttocks, legs and feet travel along the surface of the water until the hips occupy the position of the head at the beginning of this action.	6.0		1.1 See BP 2 <b>Front Layout Position</b> and BP 10 <b>Front Pike Position</b> . Uniform motion in downward movement of the trunk. The trunk remains straight throughout the movement. Hips and head lock into position simultaneously. 1.2 Unless otherwise specified, <i>To Assume a Front Pike Position</i> starts from a <b>Front Layout Position</b> .

**BM 10 Vertical Descent**

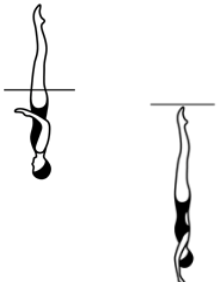
Basic Movement Description	NVT	Diagrams	Major Desired Actions
1. Maintaining a <b>Vertical Position</b> the body descends along its longitudinal axis until the toes are submerged.	14.0		1. See BP 6 <b>Vertical Position</b> . The tempo of the descent is uniform and at the same speed as the rest of the figure.

**11.4.3 Optional Group 2**
**11.4.3.1 Figure – 363 WATER DROP**
**DIFFICULTY – 1.8**

From a **Front Layout Position** a *Front Pike Position* is assumed. The legs are lifted simultaneously to a **Bent Knee Vertical Position**. A *Half Twist* is executed. A  $180^\circ$  *Spin* is executed in the same direction as the bent leg is extended to a **Vertical Position** and completed as the ankles reach the surface of the water. A *Vertical Descent* is executed.







						Total
NVT=	6.0	15.0	15.0	13.0	0	49
PV =	1.22	3.06	3.06	2.65	0	10

Figure Description	NVT	Diagrams	Major Desired Actions
--------------------	-----	----------	-----------------------

1. From a **Front Layout Position** a *Front Pike Position* is assumed.

6.0

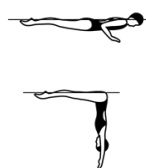

1. See BP 2 **Front Layout**, BP 10 **Front Pike Position** and BM 3 *To Assume a Front Pike Position*.

Smooth even movement downwards of the trunk.



2. The legs are lifted simultaneously to a **Bent Knee Vertical Position**.

15.0



2. See BP 14c **Bent Knee Vertical Position**. The trunk remains on the vertical line. The **Bent Knee Vertical Position** is achieved as the vertical is reached.

**Figure – 363 WATER DROP (cont.)**
**DIFFICULTY – 1.8**

Figure Description	NVT	Diagrams	Major Desired Actions
3. A <i>Half Twist</i> is executed.	15.0		3. See BM 12a <i>Half Twist</i> . The <i>Half Twist</i> is performed in a <b>Bent Knee Vertical Position</b> .
4. A 180° <i>Spin</i> is executed in the same direction as the bent leg is extended to a <b>Vertical Position</b> and completed as the ankles reach the surface of the water.	13.0		4.1 See BM 13d 180° <i>Spin</i> and BP 6 <b>Vertical Position</b> . Body alignment remains constant during the extension of the bent leg. 4.2 The joining of the bent leg to vertical, the completion of the 180° <i>Spin</i> and the establishment of the BP 6 <b>Vertical Position</b> at ankle level are achieved simultaneously. The bent leg is extended upward and the 180° <i>Spin</i> is executed at the same rate of space and time as that of the drop spaces of the vertical leg. 4.3 Simultaneous descent and extension of bent leg as feet join.
5. A <i>Vertical Descent</i> is executed.	0		5. See BM 10 <i>Vertical Descent</i>

**BP 2 Front Layout Position**

Body Position Description	Diagrams	Major Desired Actions
1. Body extended with head, upper back, buttocks, and heels at the surface of the water.		1. Gives the impression that the body is stretched horizontally to its maximum. Judgement made by checking visual points of the horizontal alignment: ears, shoulder joints, hip joints and heels.

**Figure – 363 WATER DROP (cont.)**
**DIFFICULTY – 1.8**
**BP 2 Front Layout Position (cont.)**

Body Position Description	Diagrams	Major Desired Actions
<p>2. Unless otherwise specified, face may be in or out of the water.</p>		<p>2. Once the head position is established as in or out of the water the position is maintained. When the face is out of the water the ears will not be on the horizontal axis and the back may be slightly lower and arched. Hip joints, calves and heels remain at the surface of the water.</p>

**BP 10 Front Pike Position**

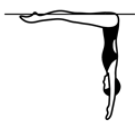
Body Position Description	Diagrams	Major Desired Actions
<p>1. Body bent at hips to form a 90° angle.</p>		<p>1. Exact 90° angle.</p>
<p>2. Legs extended and together.</p>		<p>2. Full extension of legs, with ankles aligned with hip joints.</p>
<p>3. Trunk extended with the back straight and head in line.</p>		<p>3. Back flat, with vertical alignment of ears, shoulder joints and hip joints once the position is established.</p>

**BP 14 Bent Knee Position**

Body Position Description	Diagrams	Major Desired Actions
<p>One leg bent with the toe of the bent leg in contact with the inside of the extended leg at the knee or higher.</p>		<p>The relationship of the toe of the bent leg to the extended leg may vary depending on the figure but should remain constant once established, and not extend in front of or behind the extended leg.</p>
<p><b>c) Bent Knee Vertical Position</b></p> <p>1. Body extended in <b>Vertical Position</b> with the thigh of the bent leg parallel to the surface of the water.</p>		<p>1. In BP 6 <b>Vertical Position</b> the alignment of the extended leg, trunk and head remains constant.</p>



**Figure – 363 WATER DROP (cont.)**
**DIFFICULTY – 1.8**
**BP 6 Vertical Position - ankle level**

Body Position Description	Diagrams	Major Desired Actions
1. Body extended perpendicular to the surface of the water; legs together, head downward.  2. Head (ears specifically), hips and ankles in line.		1. Full extension of the body.  2. Judgement is made by checking visual points of the vertical alignment: ears, shoulder joints, hip joints and ankles.

**BM 3 To Assume a Front Pike Position/A Front Pike Position is assumed**

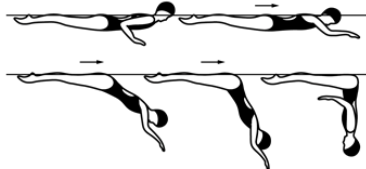
Basic Movement Description	NVT	Diagrams	Major Desired Actions
1. From a <b>Front Layout Position</b> with the face in the water the trunk moves downward to assume a <b>Front Pike Position</b> . The buttocks, legs and feet travel along the surface of the water until the hips occupy the position of the head at the beginning of this action.	6.0		1.1 See BP 2 <b>Front Layout Position</b> and BP 10 <b>Front Pike Position</b> . Uniform motion in downward movement of the trunk. The trunk remains straight throughout the movement. Hips and head lock into position simultaneously.  1.2 Unless otherwise specified, <i>To Assume a Front Pike Position</i> starts from a <b>Front Layout Position</b> .

**BM 12 Twist – Half Twist in Bent Knee Vertical Position**

Basic Movement Description	NVT	Diagrams	Major Desired Actions
1. A <i>Twist</i> is a rotation at a sustained height.  2. The body remains on its longitudinal axis throughout the rotation.			1. Height remains constant throughout the rotation. Stability and alignment of the position is evident before, during and upon completion of the Twist. The amount of height is judged by the relationship of the hip joints to the surface of the water with maximum height desirable.  2. The longitudinal axis runs through the centre of the body and is perpendicular to the surface of the water. On the spot rotation around this axis.

**Figure – 363 WATER DROP (cont.)**
**DIFFICULTY – 1.8**
**BM 12 Twist – Half Twist in Bent Knee Vertical Position (cont.)**

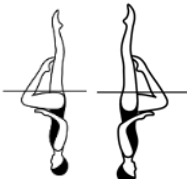
Basic Movement Description	NVT	Diagrams	Major Desired Actions
<b>Half Twist in Bent Knee Vertical Position</b>			
4. <b>a) Half Twist:</b> a <i>Twist</i> of 180°.	15.0		The acceptable allowance for a ½ Twist rotation is up to ¼ less than/more than the required rotation.

**BM 13d 180° Spin – adapted for Bent Knee Vertical joining to Vertical at ankle level**

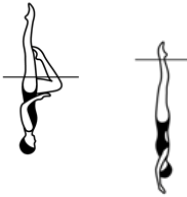
Basic Movement Description	NVT	Diagrams	Major Desired Actions
1. A 180° <i>Spin</i> is a descending rotation executed as the bent leg is extended to a <b>Vertical Position</b> and is completed as the ankles reach the surface of the water.	13.0		1. See BP 14c <b>Bent Knee Vertical Position</b> .
2. The body remains on its longitudinal axis throughout the rotation.			2. The longitudinal axis runs through the centre of the body and is perpendicular to the surface of the water.
3. The <i>Spin</i> is executed in uniform motion and is completed with a <i>Vertical Descent</i> which is executed at the same tempo as the <i>Spin</i> .			3. Uniform motion to be at the same tempo as the root figure. See BM 10 <i>Vertical Descent</i> .
4. A <i>descending Spin</i> must start at the height of the vertical and be completed as the ankle(s) reach(es) the surface of the water.			4.1 Stability and vertical alignment before, during and at completion of the designated rotation. 4.2 Simultaneous rotation and descent of the body with even drop spaces to complete the spin as the ankles reach the surface of the water. 4.3 The acceptable allowance for a 180° <i>Spin</i> rotation is up to ¼ less than/more than the required rotation.

**Figure – 363 WATER DROP (cont.)**

**DIFFICULTY – 1.8**

**BM 10 Vertical Descent – from ankle level**

Basic Movement Description	NVT	Diagrams	Major Desired Actions
----------------------------	-----	----------	-----------------------

1. Maintaining a **Vertical Position** the body descends along its longitudinal axis until the toes are submerged.

○

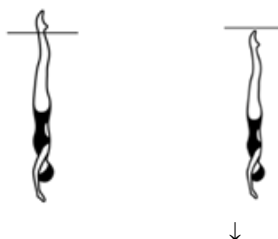

1. See BP 6 **Vertical Position**. The tempo of the descent is uniform and at the same speed as the rest of the figure.

**11.4.3.2 Figure – 401 SWORDFISH**
**DIFFICULTY – 2.1**

From a **Front Layout Position** a **Bent Knee Front Layout Position** is assumed. The back arches more as the extended leg is lifted in a 180° arc over the surface of the water to assume a **Bent Knee Surface Arch Position**. The bent leg is straightened to assume a **Surface Arch Position**. With continuous motion an *Arch to Back Layout Position* is executed.











					Total
NVT=	4.0	47.0	11.5	7.0	69.5
PV =	0.58	6.76	1.65	1.01	10

Figure Description	NVT	Diagrams	Major Desired Actions
1. From a <b>Front Layout Position</b> a <i>Bent Knee Front Layout Position</i> is assumed.	4.0	 	1. See BP 2 <b>Front Layout</b> and BP 14a <b>Bent Knee Front Layout Position</b> . There can be no change of head position once the leg starts to bend to assume the <b>Bent Knee Front Layout Position</b> .

**Figure – 401 SWORDFISH (cont.)**
**DIFFICULTY – 2.1**

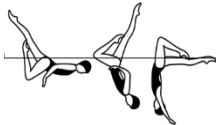
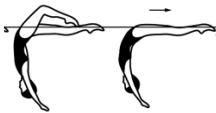
Figure Description	NVT	Diagrams	Major Desired Actions
<p>2. The back arches more as the extended leg is lifted in a 180° arc over the surface of the water to assume a <b>Bent Knee Surface Arch Position</b>.</p>	47.0		<p>2.1 See BP 14d <b>Bent Knee Surface Arch Position</b>. The lifting of the extended leg and arching of the back occur simultaneously. The foot of the extended leg comes off the surface of the water as the head goes under the surface of the water.</p> <p>2.2 There is continuous motion as the extended leg is lifted in a 180° arc over the surface of the water to a <b>Bent Knee Surface Arch Position</b> with the toe of the bent leg remaining in contact with the inside of the extended leg.</p> <p>2.3 The hips maintain constant height and are the pivot point for the body rotation.</p>
<p>3. The bent leg is straightened to assume a <b>Surface Arch Position</b>.</p>	11.5		<p>3. See BP 13 <b>Surface Arch Position</b>. The trunk maintains the same position until the feet join. The <b>Surface Arch Position</b> should be shown, but not held prior to the start of the surfacing action. Hip joints remain on a horizontal line, full extension of the legs with thighs and feet at the surface of the water.</p>
<p>4. With continuous motion an <i>Arch to Back Layout Position</i> is executed.</p>	7.0		<p>4. See BM 5 <i>Arch to Back Layout Position</i>.</p>

**Figure – 401 SWORDFISH (cont.)**
**DIFFICULTY – 2.1**
**BP 2 Front Layout Position**

Body Position Description	Diagrams	Major Desired Actions
1. Body extended with head, upper back, buttocks, and heels at the surface of the water.		1. Gives the impression that the body is stretched horizontally to its maximum. Judgement made by checking visual points of the horizontal alignment: ears, shoulder joints, hip joints and heels.
2. Unless otherwise specified, face may be in or out of the water.		2. Once the head position is established as in or out of the water the position is maintained. When the face is out of the water the ears will not be on the horizontal axis and the back may be slightly lower and arched. Hip joints, calves and heels remain at the surface of the water.

**BP 14 Bent Knee Position**

Body Position Description	Diagrams	Major Desired Actions
One leg bent with the toe of the bent leg in contact with the inside of the extended leg at the knee or higher.		The relationship of the toe of the bent leg to the extended leg may vary depending on the figure but should remain constant once established, and not extend in front of or behind the extended leg.
<b>a) Bent Knee Front Layout Position</b>		
1. Body extended in <b>Front Layout Position</b> with the thigh of the bent leg perpendicular to the surface of the water.		1. In BP 2 <b>Front Layout Position</b> the alignment of the extended leg, trunk and head remains constant.
2. Unless otherwise specified face may be in or out of the water.		2. Once established as in or out of the water, the head position is maintained. When the face is out of the water, the ears will not be on the horizontal axis, and the back may be slightly lower and arched. Hip joints and the calf and heel of the extended leg remain at the surface of the water.

**Figure – 401 SWORDFISH (cont.)**
**DIFFICULTY – 2.1**

Body Position Description	Diagrams	Major Desired Actions
---------------------------	----------	-----------------------

**BP 14 Bent Knee Position (cont.)**
**d) Bent Knee Surface Arch Position**

1. Lower back arched with hips, shoulders, and head on a vertical line.



1.1 In BP 13 **Surface Arch Position** shoulder joints and hip joints on a horizontal line with both of these alignments 'square' and parallel to one another. Head (ears specifically) in line with shoulders.

1.2 Hips at the surface of the water.

2. The thigh of the bent leg is perpendicular to the surface of the water.

2. 90° angle between the thigh of the bent leg and the surface of the water. An air pocket will be evident between the back of the thigh and calf of the bent leg and the surface of the water.

**BP 13 Surface Arch Position**

Body Position Description	Diagrams	Major Desired Actions
---------------------------	----------	-----------------------

1. Lower back arched with hips, shoulders, and head on a vertical line.



1. Hip joints and shoulder joints on a horizontal line with both of these alignments 'square' and parallel to one another. Head (ears specifically) in line with shoulders.

2. Legs together and at the surface of the water.

2. Hips joints at the surface of the water.

**BP 1 Back Layout Position**

Body Position Description	Diagrams	Major Desired Actions
---------------------------	----------	-----------------------

1. Body extended with face, chest, thighs, and feet at the surface of the water.



1. Gives the impression that the body is stretched horizontally to its maximum. Front of the trunk will also be at the surface of the water.

2. Head (ears specifically), hips and ankles in horizontal alignment.

2. Judgement is made by checking visual points of the horizontal alignment: ears, shoulder joints, hip joints and ankles. This imaginary line should also pass through the middle of the side of the trunk.

**Figure – 401 SWORDFISH (cont.)**
**DIFFICULTY – 2.1**
**BM 5 Arch to Back Layout Position**

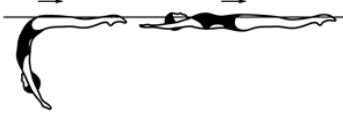
Basic Movement Description	NVT	Diagrams	Major Desired Actions
1. From a <b>Surface Arch Position</b> the hips, chest, and face surface sequentially at the same point with foot first movement to a <b>Back Layout Position</b> until the head occupies the position of the hips at the beginning of this action.	7.0		1. See BP 13 <b>Surface Arch Position</b> . Sharp arch in the lower back. The body rises, straightens, and moves along the surface of the water with a stationary BP 1 <b>Back Layout Position</b> achieved as the face surfaces. Full extension maintained throughout.



**11.4.4 Optional Group 3**
**11.4.4.1 Figure – 311 KIP**
**DIFFICULTY – 1.6**

From a **Back Layout Position** the knees, shins and toes are drawn along the surface of the water to assume a **Tuck Position**. With continuous motion the tuck becomes more compact, and a partial Somersault Back Tuck is executed until the shins are perpendicular to the surface of the water. The trunk unrolls as the legs are straightened to assume a **Vertical Position** midway between the former vertical line through the hips and the former vertical line through the head and shins. A *Vertical Descent* is executed.











					Total
NVT=	3.0	2.0	23.0	14.0	42
P =	0.71	0.48	5.48	3.33	10

Figure Description	NVT	Diagrams	Major Desired Actions
1. From a <b>Back Layout Position</b> the knees, shins and toes are drawn along the surface of the water to assume a <b>Tuck Position</b> . With continuous motion the tuck becomes more compact, and a partial Somersault Back Tuck is executed until the shins are perpendicular to the surface of the water	3.0	  	1.1 See BP 1 <b>Back Layout</b> and BP 9 <b>Tuck Positions</b> . With the head and shoulders remaining stationary, the knees, shins and toes are drawn to the body to assume a tight tuck at the position occupied by the trunk in the <b>Back Layout Position</b> . 1.2 There is continuous motion from the initiation of the leg draw to achievement of the inverted BP 9 <b>Tuck Position</b> .
2. The trunk unrolls as the legs are straightened to assume a <b>Vertical Position</b> midway between the former vertical line through the hips and the former vertical line through the head and shins.	23.0		2.1 BP 6 <b>Vertical Position</b> and maximum height achieved simultaneously. 2.2 The <b>Vertical Position</b> is held only long enough to define the position and to demonstrate completion of the transition prior to the descent.



**Figure – 311 KIP (cont.)**
**DIFFICULTY – 1.6**

Figure Description	NVT	Diagrams	Major Desired Actions
3. A <i>Vertical Descent</i> is executed.	14.0		3. See BM 10 <i>Vertical Descent</i> .

**BP 1 Back Layout Position**

Body Position Description	Diagrams	Major Desired Actions
1. Body extended with face, chest, thighs, and feet at the surface of the water.		1. Gives the impression that the body is stretched horizontally to its maximum. Front of the trunk will also be at the surface of the water.
2. Head (ears specifically), hips and ankles in horizontal alignment.		2. Judgement is made by checking visual points of the horizontal alignment: ears, shoulder joints, hip joints and ankles. This imaginary line should also pass through the middle of the side of the trunk.

**BP 9 Tuck Position**

Body Position Description	Diagrams	Major Desired Actions
1. Body as compact as possible, with the back rounded and the legs together.		1. Legs together with shins at the surface of the water and tucked tightly to the front of the body.
2. Heels close to buttocks.		2. Compact tuck. Chin tucked in.
3. Head close to knees.		3. In BP 9 inverted Tuck Position shins are perpendicular to the surface of the water, buttocks remain at the surface and the water level is between the ankle and mid foot.

**Figure – 311 KIP (cont.)**
**DIFFICULTY – 1.6**
**BP 6 Vertical Position**

Body Position Description	Diagrams	Major Desired Actions
1. Body extended perpendicular to the surface of the water; legs together, head downward.		1. Full extension of the body.
2. Head (ears specifically), hips and ankles in line.		2. Judgement is made by checking visual points of the vertical alignment: ears, shoulder joints, hip joints and ankles.

**BM 10 Vertical Descent**

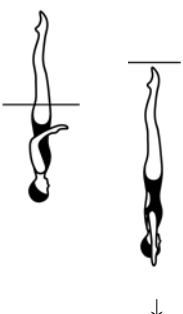
Basic Movement Description	NVT	Diagrams	Major Desired Actions
1. Maintaining a <b>Vertical Position</b> the body descends along its longitudinal axis until the toes are submerged.	14.0		1. See BP 6 <b>Vertical Position</b> . The tempo of the descent is uniform and at the same speed as the rest of the figure.

**11.4.4.2 Figure – 227d**
**SWANITA SPINNING 180°**
**DIFFICULTY – 1.9**

From a **Back Layout Position** a *Bent Knee Surface Arch Position* is assumed. The bent leg is straightened to assume a **Knight Position**. The body rotates 180° to assume a **Fishtail Position**. Continuing in the same direction a *descending Spinning 180°* rotation is executed as the horizontal leg is lifted to a **Vertical Position** and is completed as the ankles reach the surface of the water. A *Vertical Descent* is executed.







						Total
NVT=	17.5	14.0	14.0	12.5	0	58
PV =	3.02	2.41	2.41	2.16	0	10

Figure Description	NVT	Diagrams	Major Desired Actions
--------------------	-----	----------	-----------------------

1. From a **Back Layout Position** a *Bent Knee Surface Arch Position* is assumed. 17.5



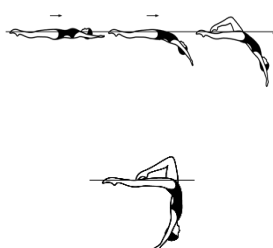

1. See BP 1 **Back Layout Position**, BP 14d **Bent Knee Surface Arch Position** and BM 15 *To Assume a Bent Knee Surface Arch Position*. Continuous uniform movement from **Back Layout Position** to **Bent Knee Surface Arch Position**.

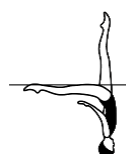
2. The bent leg is straightened to assume a **Knight Position**. 14.0

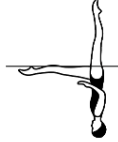
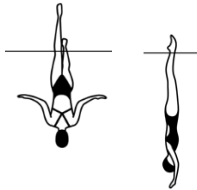

2.1 See BP 17 **Knight Position**. Horizontal alignment of hips and shoulders 'square' and maintained during the lift to **Knight Position**.  
2.2 Height remains constant during the straightening of the leg to **Knight Position** with full extension of the horizontal leg maintained  
2.3 The bent leg is straightened along the vertical line established by the thigh in the **Bent Knee Surface Arch Position**.

**Figure – 227d SWANITA SPINNING 180° (cont.)**
**DIFFICULTY – 1.9**

Figure Description	NVT	Diagrams	Major Desired Actions
3. The body rotates 180° to assume a <b>Fishtail Position</b> .	14.0		<p>3.1 See BP 8 <b>Fishtail Position</b>. The vertical leg remains stationery and height remains constant during the rotation.</p> <p>3.2 The foot of the horizontal leg remains at the surface of the water and not above or below.</p> <p>3.3 Full extension of the horizontal leg throughout the 180° rotation</p>
4. Continuing in the same direction a descending <i>Spinning 180°</i> rotation is executed as the horizontal leg is lifted to a <b>Vertical Position</b> and is completed as the ankles reach the surface of the water.	12.5		<p>4.1 The legs are joined while descending and rotating to assume a BP 6 <b>Vertical Position</b> at ankle level.</p> <p>4.2 The vertical leg maintains the vertical line throughout the rotation.</p> <p>4.3 Longitudinal axis is maintained throughout the rotation.</p> <p>4.4 The tempo of the rotation and descent is uniform and at the same speed as the root figure.</p>
5. A <i>Vertical Descent</i> is executed.	0		<p>5. See BM 10 <i>Vertical Descent</i>. The tempo of the descent is uniform and at the same speed as the rest of the figure.</p>

**BP 1 Back Layout Position**

Body Position Description	Diagrams	Major Desired Actions
1. Body extended with face, chest, thighs, and feet at the surface of the water.		<p>1. Gives the impression that the body is stretched horizontally to its maximum. Front of the trunk will also be at the surface of the water.</p>

**Figure – 227d SWANITA SPINNING 180° (cont.)**
**DIFFICULTY – 1.9**
**BP 1 Back Layout Position (cont.)**

Body Position Description	Diagrams	Major Desired Actions
2. Head (ears specifically), hips and ankles in horizontal alignment.		2. Judgement is made by checking visual points of the horizontal alignment: ears, shoulder joints, hip joints and ankles. This imaginary line should also pass through the middle of the side of the trunk.

**BP 14 Bent Knee Position**

Body Position Description	Diagrams	Major Desired Actions
One leg bent, with the toe of the bent leg in contact with the inside of the extended leg at the knee or higher.		The relationship of the toe of the bent leg to the extended leg may vary depending on the figure but should remain constant once established, and not extend in front of or behind the extended leg.

**d) Bent Knee Surface Arch Position**

1. Lower back arched with hips, shoulders, and head on a vertical line.



2. The thigh of the bent leg is perpendicular to the surface of the water.

1.1 In BP 13 **Surface Arch Position** shoulder joints and hip joints on a horizontal line with both of these alignments 'square' and parallel to one another. Head (ears specifically) in line with shoulders.

1.2 Hips at the surface of the water.

2. 90° angle between the thigh of the bent leg and the surface of the water. An air pocket will be evident between the back of the thigh and calf of the bent leg and the surface of the water.

**Figure – 227d SWANITA SPINNING 180° (cont.)**
**DIFFICULTY – 1.9**
**BP 17 Knight Position**

Body Position Description	Diagrams	Major Desired Actions
<p>1. Lower back arched, with hips, shoulders, and head on a vertical line.</p>		<p>1. Arch is in the lower part of the spine only.</p>
<p>2. One leg vertical.</p>		<p>2. Vertical alignment through ears, shoulder joints, hip joints and ankle of the vertical leg.</p>
<p>3. Other leg extended backward with the leg at the surface of the water and as close to horizontal as possible.</p>		<p>3. Hip joints and shoulder joints on a horizontal line with both of these alignments 'square' and parallel to each other. The top of the horizontal extended leg faces upward.</p>

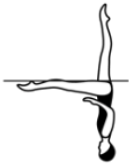

**BP 8 Fishtail Position**

Body Position Description	Diagrams	Major Desired Actions
<p>1. Body extended in <b>Vertical Position</b> with one leg extended forward. The foot of the forward leg is at the surface of the water regardless of the height of the hips.</p>		<p>1. See BP 6 <b>Vertical Position</b> for body alignment. The foot of the forward leg must be at the surface of the water. Hip joints must be on a horizontal line.</p>

**BP 6 Vertical Position - ankle level**

Body Position Description	Diagrams	Major Desired Actions
<p>1. Body extended perpendicular to the surface of the water; legs together, head downward.</p>		<p>1. Full extension of the body with the water level at the ankles.</p>
<p>2. Head (ears specifically), hips and ankles in line.</p>		<p>2. Judgement is made by checking visual points of the vertical alignment: ears, shoulder joints, hip joints and ankles.</p>

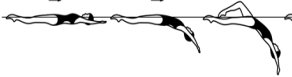
**Figure – 227d SWANITA SPINNING 180° (cont.)**
**DIFFICULTY – 1.9**
**BM 15 To Assume a Bent Knee Surface Arch Position/A Bent Knee Surface Arch is Assumed**

Basic Movement Description	NVT	Diagrams	Major Desired Actions
<p>1. From a <b>Back Layout Position</b> with the head leading, the head, hips and feet move along the surface of the water.</p>			<p>1. See BP 1 <b>Back Layout Position</b>.</p>
<p>2. With continuous movement the head leaves the surface of the water as the back is arched more to assume a <b>Bent Knee Surface Arch Position</b> with the hips occupying the position of the head at the beginning of this action.</p>	17.5		<p>2.1 Continuous uniform movement from the BP 1 <b>Back Layout Position</b> to BP 14d <b>Bent Knee Surface Arch Position</b>. Hip height remains constant. Hip joints on a horizontal line.</p> <p>2.2 The toe of the bent leg must remain in contact with the inside of the extended leg while assuming the <b>Bent Knee Surface Arch Position</b>.</p>

**BM 13d 180° Spin – adapted from Fishtail Position joining to Vertical at ankle level**

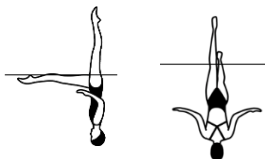
Basic Movement Description	NVT	Diagrams	Major Desired Actions
<p>1. Continuing in the same direction a descending <i>Spinning 180°</i> rotation is executed as the horizontal leg is lifted to a <b>Vertical Position</b> and is completed as the ankles reach the surface of the water.</p>	12.5		<p>1. See BP 8 <b>Fishtail Position</b>.</p>
<p>2. The body remains on its longitudinal axis throughout the rotation.</p>			<p>2. The longitudinal axis runs through the center of the body and the vertical leg which is perpendicular to the surface of the water.</p>
<p>3. The <i>Spin</i> is executed in uniform motion and is completed with a <i>Vertical Descent</i> which is executed at the same tempo as the <i>Spin</i>.</p>			<p>3. Uniform motion to be at the same tempo as the root figure. See BM 10 <i>Vertical Descent</i>.</p>



**Figure – 227d SWANITA SPINNING 180° (cont.)**
**DIFFICULTY – 1.9**
**BM 13d 180° Spin – adapted from Fishtail Position joining to Vertical at ankle level (cont.)**

Basic Movement Description	NVT	Diagrams	Major Desired Actions
<p>4. A <i>descending Spin</i> must start at the height of the vertical and be completed as the ankle(s) reach the surface of the water.</p>			<p>4.1 Stability and vertical alignment before, during and at completion of the designated rotation.</p> <p>4.2 Simultaneous rotation and descent of the body with even drop spaces to complete the spin as the ankles reach the surface of the water.</p> <p>4.3 The acceptable allowance for a 180° <i>Spin</i> rotation is up to ¼ less than/more than the required rotation.</p>

**BM 10 Vertical Descent – from ankle level**

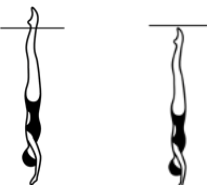
Basic Movement Description	NVT	Diagrams	Major Desired Actions
<p>1. Maintaining a <b>Vertical Position</b> the body descends along its longitudinal axis until the toes are submerged.</p>	○		<p>1. See BP 6 <b>Vertical Position</b>. The tempo of the descent is uniform and at the same speed as the rest of the figure.</p>

## CHAPTER III. - ROUTINES

## 12. INTRODUCTION

Artistic Swimming is an aquatic discipline that at a competitive level requires a large variety of highly refined athletic skills. Many of these skills take place while athletes are in apnea. Routines are the artistic expression of the discipline. A routine is a choreography to music performed in the water. In routines athletes demonstrate their mastery in skills combining techniques to create movements that match with the selected music.

Routines can start in or out of the water but must finish in the water. How athletes present themselves before the routine starts (walk-on) as well as the movements performed during this period of 20 - 30 seconds is considered under the Artistic Impression Performance mark. Deck movements (10 seconds) are also considered under Artistic Impression Performance mark.

It is recommended that all Judges and Technical Controllers attend routine practice training sessions with the Coach Card to familiarize themselves with the routine and the content of the Coach Card in advance, so everyone is well prepared for the day of competition. Practice session viewing has no impact on results on the day of the competition. On the day of the competition the Judges and Technical Controllers will consider the performance on the day of the competition only. No changes can be made to the Coach Card after it has been submitted.

## 13. ROUTINE ELEMENTS AND TRANSITIONS

Routines are composed of Elements and Transitions.

1. **Elements** include:

- **Hybrids (free content)**
- **Acrobatics**
- **Technical Required Elements** ("TRE"), which are precisely described combinations of positions and transitions to be performed by all athletes in Technical Routines only

2. **Transitions** are the linking actions between the Elements, including propulsion techniques, strokes, ballet leg combinations, flexibility surface actions, surface pattern changes, or pair assisted actions.

### 13.1 ROUTINE TYPES

There are two (2) types of routines depending on its content:

1. **Technical Routines**, which require the inclusion of TRE
2. **Free Routines**, which do not include TRE

The routine types by number of participating athletes are:

- Women Solo (1 athlete) and Men Solo (1 athlete) Technical and Free
- Women Duet (2 athletes) and Mixed Duet (2 athletes) Technical and Free
- Team (4 to 8 athletes) Technical and Free
- Acrobatic Routine (4 to 8 athletes) Free
- Free Combination Routine (4 to 10 athletes) Free

## 13.2 PANELS AND JUDGEMENT OF ROUTINES

### 13.2.1 Checked or Monitored by Technical Controllers: Difficulty and Synchronization

With the new scoring system to be implemented by January 1, 2023, the difficulty of the Elements that the routine contains is declared by the participants before the competition through the Coach Card. Whether the declared difficulty of the Hybrids and Acrobatics or the correct TRE is executed is checked by **Difficulty Technical Controllers** (DTC) during the competition. DTCs must officiate in all routines. The difficulty of Transitions is not declared or checked as transitions are part of the Artistic Impression score.

The three (3) DTC check the following:

- The number, order of performance and predeclared difficulty of Elements
- The performance and predeclared order of Technical Required Elements (technical routines)

Declared difficulty (DD) values can be found in Appendixes VI and VII to the World Aquatics AS Rules and the Coach Card format can be found in Appendix VIII to World Aquatics AS Rules. World Aquatics reserves the right to adjust the components assigned to each category as required.

The three (3) **Synchronization Technical Controllers (STC)** are to observe and record the number and type of synchronization errors. STCs will register the number and magnitude of unequal actions in all routines, except for Solo events (**AS 16.1.1** and **AS 16.1.2**).

Please refer to Section CHAPTER I. - 6 for more information concerning Difficulty Technical Controllers and Synchronization Technical Controllers.

### 13.2.2 Judged by panel of Judges: Elements Panel and Artistic Impression Panel

As per **AS 16.1** two (2) panels of five (5) Judges must officiate in all routines with one (1) panel for Elements and one (1) panel for Artistic Impression.

#### 1. Elements Panel

Elements panel of five (5) Judges shall award one (1) score for the execution of each Element (Hybrids, Acrobatics and Technical Required Elements).

Judges consider the level of excellence in performing highly specialized skills. Execution of all routine Elements: Technical Required Elements, Hybrids and Acrobatics (**AS 17.2.1**).

#### 2. Artistic Impression Panel

Artistic Impression panel of five (5) Judges shall award three (3) scores:

- a) One (1) score for **Choreography and Musicality**, the creative skill of composing a routine that combines artistic and technical components. The design and weaving together of variety, creativity, and innovation of all movements: Elements and Transitions. The pool coverage. Expression of the mood of the music, the use of the music's structure and the synchronization of movements with music.
- b) One (1) score for **Performance**

Performance is the manner in which the athletes present the routine to the viewers as well as the walk-on and the deck movements. The use of body language to

express physical and emotional power, confidence, and total command of the performance.

c) One (1) score for **Transitions**.

Judges consider the artistry and mastery of varied and purposeful movements, propulsions and strokes that link routine Elements.

As per **AS 17.1** and **AS 17.2** in all Routines each Judge shall award scores from 0-10 points in increments of 0.25:

Perfect	10	Satisfactory	5.75 – 5.0
Near perfect	9.75 – 9.5	Deficient	4.75 – 4.0
Excellent	9.25 – 9.0	Weak	3.75 – 3.0
Very Good	8.75 – 8.0	Very weak	2.75 – 2.0
Good	7.75 – 7.0	Hardly recognizable	1.75 – 0.25
Competent	6.75 – 6.0	Completely failed	0

## 14. JUDGING ROUTINES - GENERAL OVERVIEW

Accurate judging can only be achieved by a Judge who is well prepared and has become thoroughly familiar with each of the judging categories (Elements and Artistic Impression) and routine components (Elements and Transitions).

Judges must have developed the ability to apply a consistent and validated scale of excellence to each athlete. The Judge must apply those scales while utilizing the criteria objectively. With training and conscientious application of the standards, all Judges should be able to award valid scores.

The ultimate goal for Judges should be **a knowledgeable and objective judging by application of the criteria prescribed in this Manual, the World Aquatics AS Rules and other documents, as applicable, free from prejudice and preconceptions:**

- Each panel of Judges should be independent and should not influence each other.
- Judges must not judge based on what they expected to see or what they saw in the past. Judges must not be influenced by previous results or other factors that are not part of the criteria to base the judgement on.
- In Duets, Team, Free Combination and Acrobatic Routines, Judges must judge the performance of all athletes.

## 15. JUDGING ELEMENTS

The Elements panel of Judges considers the execution of Elements. Execution is the level of excellence demonstrated through the athlete's mastery of highly specialized skills. Execution is how well the athlete performs the Elements they choose to perform. Elements consist of Hybrids, Acrobatics and Technical Required Elements, judging of which is further described in paragraphs below.

As per Rule AS **14.2**, the performance ends with music accompaniment. Therefore, if an Element is performed but not completed by the time the music ends, Element Judges shall not consider the part of the Element performed after the end of music accompaniment in their mark for that Element.

### 15.1 Hybrids

A **Hybrid** is defined as a combination of two (2) or more movements performed with lower limbs with intentional apnea (head down under hips level). Note, however, that horizontal movements along the surface with one (1) to two (2) lower limb actions that have consequential apnea (rolling over, kicking, etc.) are considered Transitions.

The following factors should be considered when judging Hybrids:

#### **Design**

Components of Hybrids may show the precise characteristics of positions, movements or transitions described in the Appendix I to the World Aquatics Rules (BP and BM, and Figures) and in the declared difficulty reports, but this does not have to be the case. On many occasions the components will not match any of those described positions or movements at all or only in parts.

Also, Hybrids may be performed close to or far from Judges' position and/or in moving water caused by the (intentional) power of actions, the number of athletes performing, or the moving progression ("travelling") of the Hybrid. Judges must focus on what they see at or over the water surface. It is also common to see Hybrids components performed at a fast speed.

Considering these factors, the design accuracy in Hybrids is defined as to clearly show the intended action/position whether it is vertical, tilted, arched, bent, split, angles, twisting, spinning, travelling etc. For example, a vertical descent can be performed travelling, but body alignment must be present; descending spinning requires the even distribution of rotation during descent, but a rapid spin does not mean that it has to be continuous, the action can be stopped at the ankles, reversed and combined with leg or feet movements during the descent or ascent.

### **Control**

As part of control factors consider the following components:

#### **a) Height**

See the Guiding Height Scales for stable and dynamic height in CHAPTER II. - 9.5. and for splits in CHAPTER II. - 9.5.2.

#### **b) Extension, full body extension throughout action**

Extension is a range to which something can be stretched to its fullest length. In this case, it is the use of the muscular strength to bring a joint to its maximum physiological extension function.

In Hybrids, the knees, ankles, feet, and toes should always be fully extended with no relaxation of extension during any part of the execution, unless clearly intended otherwise in the choreography.

#### **c) Stability**

Solid, with equilibrium maintained and unaffected by change of the position. Position that is unaffected by movement. Attain position exactly, without correction. Fluid without evidence of strain.

## 15.2 Acrobatics

Execution of Acrobatics is judged by the same principles as those guiding other Elements. The Judge must be cautious to evaluate the whole action, from set-up to completion and not just the actions above the water. Judges evaluate the position achieved or the stable platform with the 'statue' in control on top. All Acrobatics must clearly demonstrate height, timing, and control with an efficiency of movement in the execution.

All acrobatic movements are divided into **4 Main Groups**:

1. Group **A** – stands for "**Airborne**". All elements in this group are performed by a Featured Swimmer in the air. Subgroups are Jumps and Throws.
2. Group **B** – stands for "**Balance**". Acrobatic movements in this group are performed on a support/base. Subgroups are Stacks and Lifts.
3. Group **C** – stands for "**Combined**". The Combined group encompasses characteristics of groups A, B and/or P. Subgroups are Onto Support, Through Support and Other.
4. Group **P** – stands for "**Platform**". The coordinated effort of athletes to form a stable support on which one (1) or more athletes are lifted to pose or perform actions. Platforms may have jump or "dismount" ending (water entry). Subgroups are Standard and Float.

### 15.2.1 Acrobatics Terminology

- **Base Swimmers** are athletes who push or lift the Featured Swimmer or the Support Swimmer with the Featured Swimmer on top.
- **Support Swimmer** is an athlete in the middle of Construction working or maintaining position on top of the Base Swimmers in a "three-tier level" Construction. Support Swimmer can be used, for example in Stacks in Group B, Standard Platforms in Group P or "Jump from Shoulders" Construction in Group A.
- **Featured Swimmer** is the athlete on top, which executes acrobatic actions or movements on support or in the air.
- **Spotter** ("helper") is an athlete with a role of additional support (lift or push) inside the Construction. Usually placed near or close to the "main" Construction. It is possible to have a few separate Spotters.
- **Construction** is a generalized name for a collaborated work of all athletes according to their assigned role in the acrobatic movement (Base Swimmers+ Support Swimmers + Featured Swimmers).
- **Construction of the base** is the name of the coordinated actions of the athletes to form a support (under or at the water surface) from which or on which one (1) or more Featured Swimmers can execute acrobatic actions.
- **Formation** is two (2) or more groups of athletes, from which Construction can comprise (for example Group C, subgroup Onto support). Well synchronized actions of this group guarantee execution of acrobatic movements. Without proper work from one (1) of the Formations a whole acrobatic movement is likely to fail.
- **Pair Acrobatics** is an acrobatic movement consisting of two (2) athletes, that can be a Lift or a Throw/Jump, where the Base Swimmer is underwater and lifts/throws the



Featured Swimmer up in the air. Pair Acrobatics is considered an Element in Women Duets and Mixed Duets only and thus judged by Element Judges. If Pair Acrobatics occurs in Team routines, it is only judged under Artistic Impression and not judged by the Elements panel of Judges. See the Acrobatics Catalogue for examples of Pair Acrobatics.

- **Pair Assisted Action** is a movement involving two (2) athletes, one assisting the other, where the Base Swimmer may remain under or on the surface of the water, but the Featured Swimmer always remains on the surface of the water (not lifted up). “Boost type” assisted movements are also considered as pair assisted actions. Pair assisted actions are always considered Transitions only, regardless of the type of routine, and are never specifically declared in the Coach Card. See the Acrobatics Catalogue for examples of Pair Assisted Actions.

Athletes' roles in acrobatic movements are depicted below:

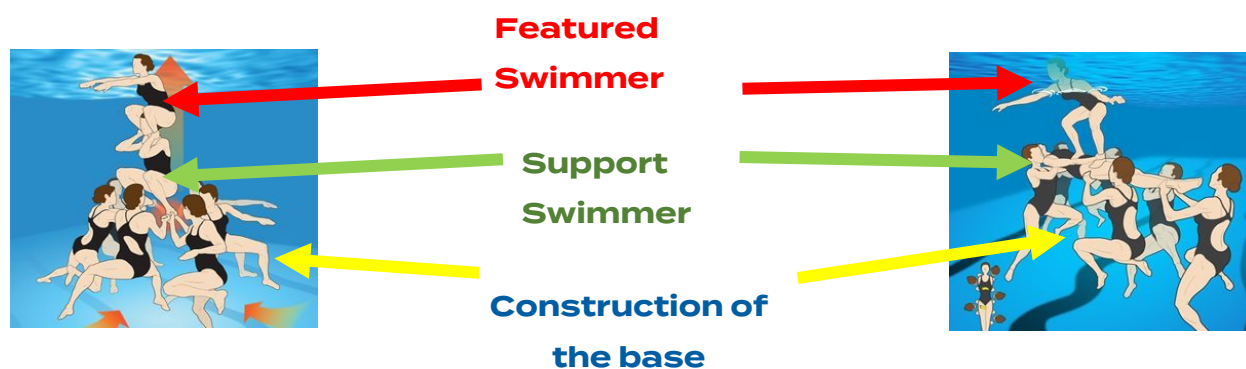

**Important:** If two (2) acrobatic movements occur one after another without submerging it should be considered as two (2) separate acrobatic movements. If two (2) different acrobatic movements are performed simultaneously, it should be considered as two (2) different acrobatic movements. If two (2) identical acrobatic movements are performed simultaneously, it should be considered and calculated as one (1) acrobatic movement with synchronization bonus.

It is cautioned that if two (2) different acrobatic movements are performed simultaneously, Judges may not be aware of which Acrobatics is intended to be scored first.

### 15.2.2 Acrobatics judging points

When judging acrobatic movements, Judges consider the following:

#### a) Height

Height determines execution range for all groups of Acrobatics. Height can be referred to for Featured Swimmer in the Airborne group or the Support Swimmer(s) in Balance and Platform. See the Acrobatics High Scale in Sections 15.2.4 and 15.2.5 below for more details on judging height in Acrobatics.

#### b) Clearly defined action

The Acrobatics must be clear and easily recognizable, shown long enough to be understood and displaying a definite completion or finishing of the action.

Judges consider the movements of the Featured Swimmer in relation to:

- Angles for **accuracy** of positions
- Full body **extension**
- **Control** for deliberate movements
- **Direction / distance accuracy**. An incorrect direction line may influence a general impression for the acrobatic movement and can be dangerous for other athletes
- **Water entry** that is clean and intentional

See the Deduction Guidelines for Acrobatics in Section 15.2.6.

c) **Stability in achieving and maintaining position(s)**

There should not be any 'falling off', loss of balance, or instability of the Support and/or Featured Swimmer. Stability of the Construction should be considered as well.

Judges consider the support / construction of the Base Swimmers for:

- Design for efficiency and effectiveness
- Stability and sustainability of the Construction
- Stability and sustainability of the Support
- Push problem while supporting the Featured Swimmer

See the Deduction Guidelines for Acrobatics in Section 15.2.6.

**Note** that if an acrobatic action is attempted but it does not surface, or it can be considered a complete failure, or it is unclear which Acrobatics was intended to be performed, the Element panel of Judges will give a minimum of 3.0 points.

d) **Minimal set-up and recovery time**

A minimal time should be given to the set-up and the recovery time after the completion of the acrobatic action. Both should be achieved without any underwater scramble or struggle.

### 15.2.3 Pair Acrobatics

To be able to apply Elements score for the Pair Acrobatics (Lifts, Jumps, or Throws) Judges need to evaluate a general impression of the acrobatic movement based on the main control factors of the Featured Swimmer (height, clarity, angles, extension). Judges must also evaluate design, stability, and sustainability of the entire acrobatic movement, including the Base Swimmer and the Featured Swimmer and the way they interact. Judges are looking for a clear water entry, and pay attention to unintentional falls, push problems and other execution issues.

Please see the Pair Acrobatics Height Scale in Section 15.2.5.3 below for more details on judging height in Pair Acrobatics.

**15.2.4 Guiding Scale for Height Quality of Performance - Acrobatics**

ACRO GROUP & SUBGROUP:		CONSIDER HEIGHT OF:	POSITION / TYPE OF SUPPORT:	10	9	8	7	6	5	4	
GROUP A	JUMP / THROW	FEATURED SWIMMER	ANY	Two (2) full bodies		One and half (1½) body		One (1) body		Half (½) body	
	SMALL JUMP / THROW	FEATURED SWIMMER	ANY	One (1) body		Half (½) body		Less than half (½) body			
GROUP B	LIFT	BASE SWIMMER	ARMS/HANDS	Upper chest (head and shoulders above water surface)		Shoulders (head above water surface)	Chin & upper arms	Half head	Top of head and elbow	Wrist	
			HEAD	Upper chest (head and shoulders above water surface)		Shoulders (head above water surface)		Head only (chin dry)		Below water surface	
			SHOULDERS	Chest above water surface	Upper chest	Collar bone	Shoulders	Chin	Top of head	Below water surface	
	STACK	SUPPORT SWIMMER	HEAD UP	Kneecap and higher	Crotch	Waist	Chest	Neck	Top of head	Below water surface	
			HEAD DOWN	VERTICAL	Waist or higher	Lower back	Mid-thigh	Kneecap	Mid-shin	Ankle	Feet under water
				CRANE PIKE SPLIT	Lower ribs	Waist	Horizontal leg(s) dry	Mid-horizontal leg(s)	Some parts of horizontal leg(s) dry	Horizontal leg(s) just below water surface	Horizontal leg(s) well below water surface
	SMALL LIFT	BASE SWIMMER	ARMS/HANDS	Shoulders	Mid-neck	Chin	Half head	Top of head	Upper Arm	Below water surface	
	SMALL STACK	SUPPORT SWIMMER	HEAD UP	Top of pelvis	Waist	Mid-chest	Neck	Half head	Top of head	Below water surface	
			HEAD DOWN	Mid-thigh or higher	Above kneecap	Kneecap	Mid-shin	Ankle	Top of feet	Below water surface	
	GROUP C	ONTO SUPPORT	SUPPORT / BASE SWIMMER	ANY (depends on the acrobatic movement)	The applicable height chart is based on the type of Acrobatics in the <u>main (bigger) formation</u> (Platform, Stack, etc.) of the Construction. Once you determine the Acrobatics type, use the height chart for " <u>big</u> " Acrobatics. (Exception: in "Stack + throw with two Featured Swimmers in connection with each other," apply the height chart for Group A (Small Acro) to each of the two Featured Swimmers and calculate the average mark)						
THROUGH SUPPORT		SUPPORT / BASE SWIMMER									
GROUP P	STANDARD	SUPPORT SWIMMER	BACK / FRONT LAYOUT POSITION	All body parts dry	Majority of body parts dry	Some body parts dry	Two (2) body parts dry	Just below water surface	Well below water surface		
			BALLET LEG SINGLE & DOUBLE	Majority of body parts at surface	Some body parts at surface	Two (2) body parts at surface	Upper thigh	Mid-thigh	Above kneecap	Kneecap or lower	
			BACK LAYOUT WITH BOTH KNEES BENT	Majority of body parts at surface	Some body parts at surface	Two (2) body parts at surface	Kneecap above surface	Just below water surface	Well below surface		
	FLOAT	BASE SWIMMERS	ARMS/HANDS	Mid-chest (head and shoulders above water)		Head & shoulders above water, arms on surface		Head and neck out of water. Arms on or below surface		Below water surface	
PAIR ACRO	LIFT	FEATURED SWIMMER	HEAD UP	Ankle	Kneecap	Mid-thigh	Crotch	Lower back	Waist		
			HEAD DOWN	Head above surface	Chin	Armpits	Mid-ribs	Lower back	Crotch	Mid-thigh	
	THROW / JUMP	FEATURED SWIMMER	HEAD UP	Feat above surface	Ankle	Mid-shin	Kneecap	Mid-thigh	Crotch		
			HEAD DOWN	Entire arm above water surface	Wrist	Top of the head	Shoulders	Lower ribs	Lower back	Crotch	

### 15.2.5 Guiding Scale for Height– Acrobatics Diagrams

#### 15.2.5.1 GROUP A (AIRBORN)

Judges consider the height of the Featured Swimmer in relation to the surface of the water. Considering that the physical height of each athlete is different, Judges need to visually estimate how many “full bodies” (from head to toe) can fit within the jump amplitude (from the water surface to the point of maximum height in the air). **The point of maximum height** is considered in the **place where “center of mass of Featured Swimmers” gets in the air** (person’s center of mass is slightly below their belly button, which is nearly the geometric center of a person. Men and Women have different centers of mass, with Women's centers of mass being lower than those of Men).

**BIG ACROBATICS** (Construction consisting of seven (7) or more athletes)

**SMALL ACROBATICS** (Construction consisting of four (4) to six (6) athletes)

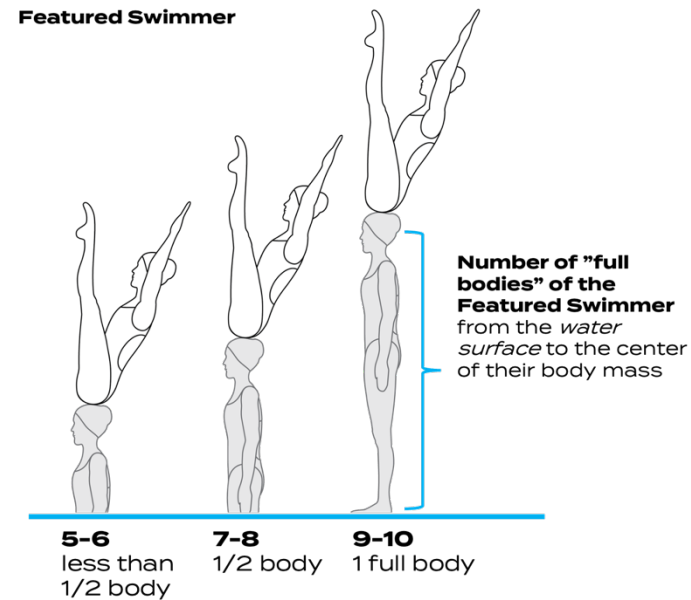
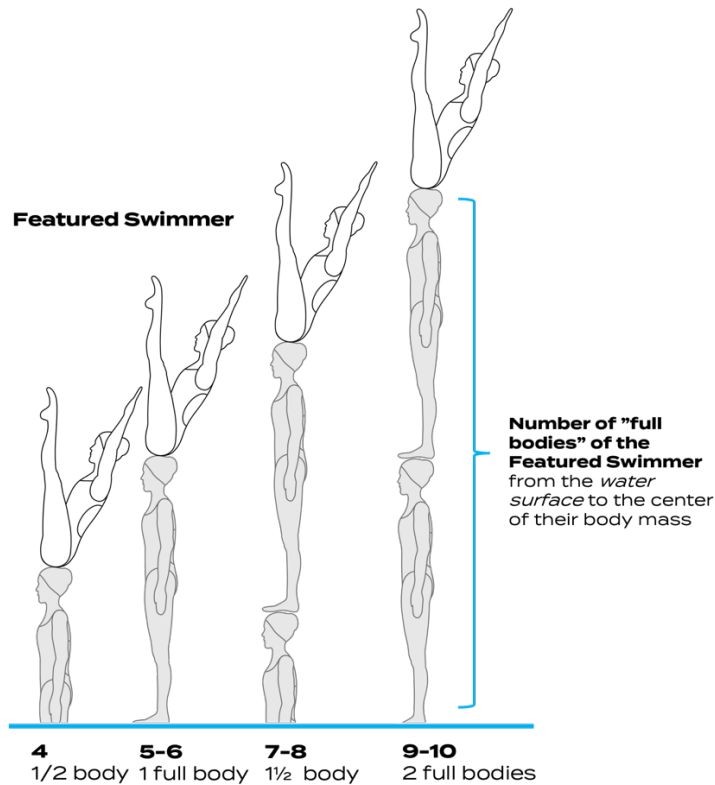

**15.2.5.2 GROUP B (BALANCE) STACK - Big Acrobatics** (Construction consisting of seven (7) or more athletes)

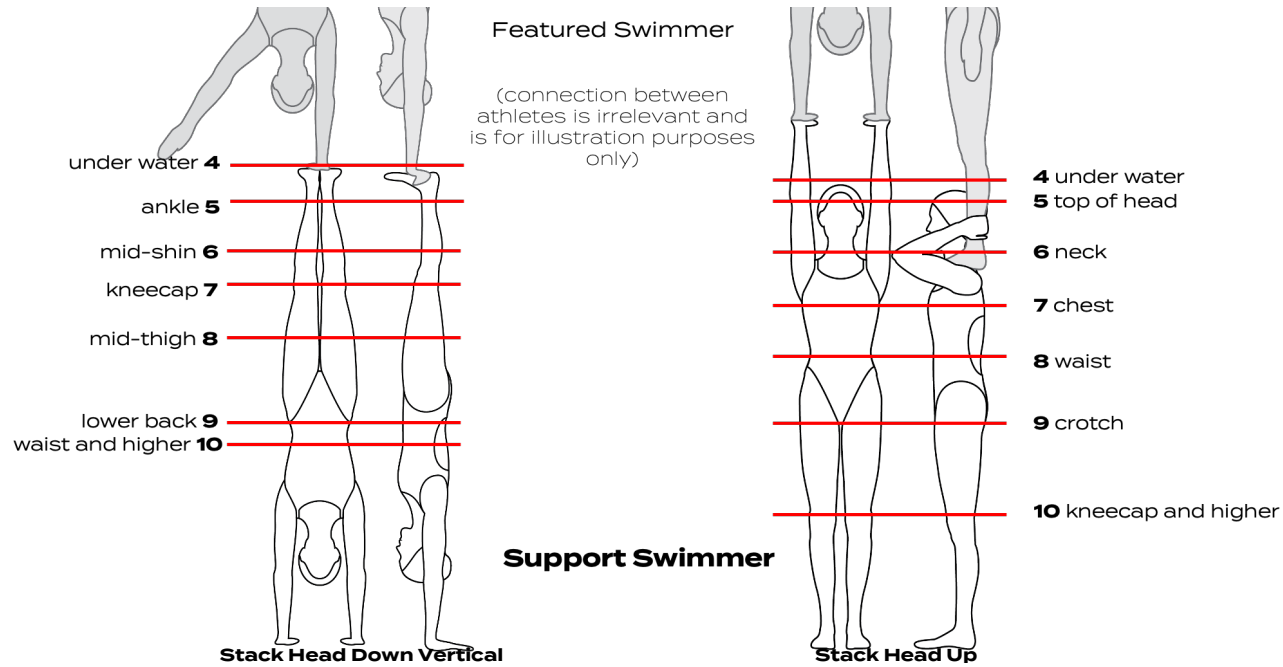

Other examples of positions of the Support Swimmers:

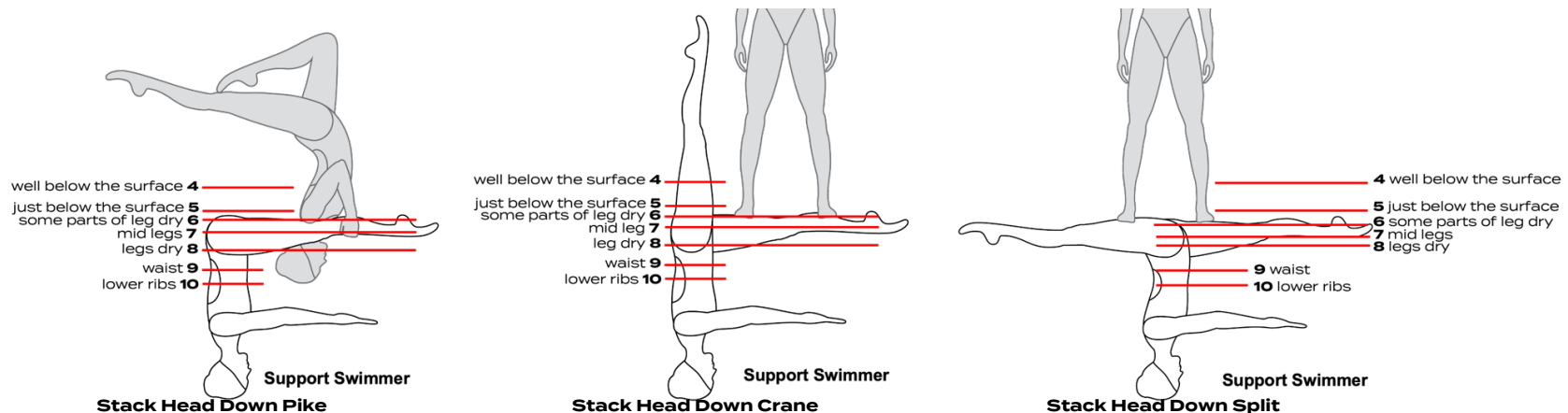

**15.2.5.3 GROUP B (BALANCE) STACK - Small Acrobatics** (Construction consisting of four (4) to six (6) athletes)

In **Stacks with two (2) Support Swimmers** the height is calculated as the **average height of two (2) Support Swimmers**. For example, if one (1) Support Swimmer was lifted head-up to “waist” height level (9 points) but the second Support Swimmer was lifted head-down to “mid-thigh or higher” height level (10 points), the Judges calculate the average of 9 and 10, which is 9.5. If two identical small Stacks occur at the same time, Elements Judges average scores for each Stack.

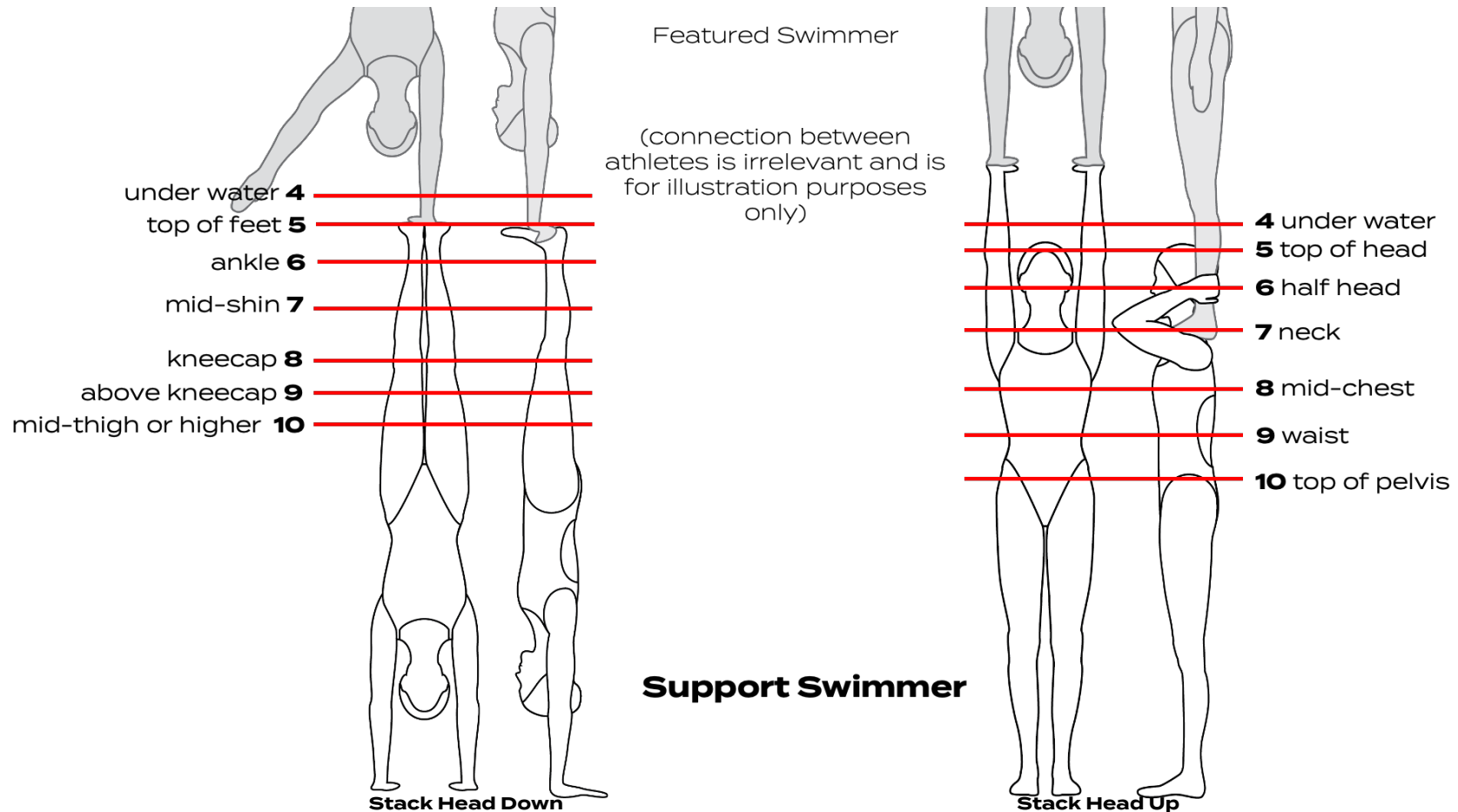

15.2.5.4 **GROUP B (BALANCE) LIFT - Big Acrobatics** (Construction consisting of seven (7) and more athletes)

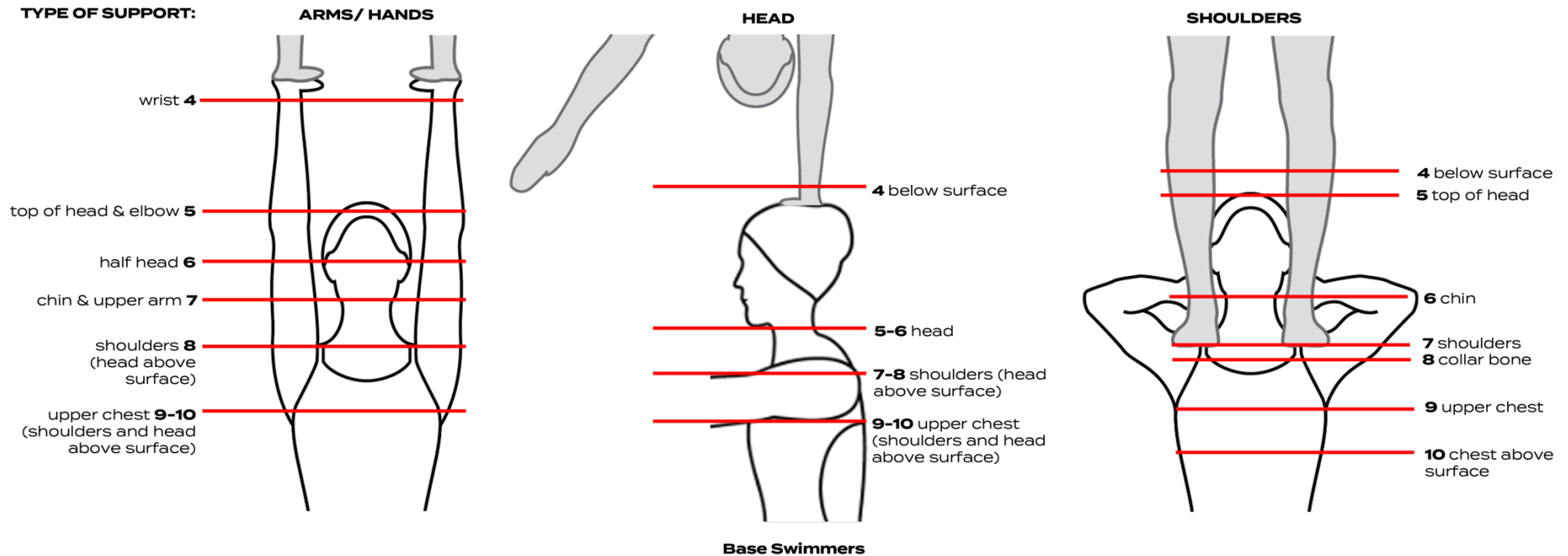

15.2.5.5 **GROUP B (BALANCE) LIFT -Small Acrobatics** (Construction consisting of four (4) to six (6) athletes)

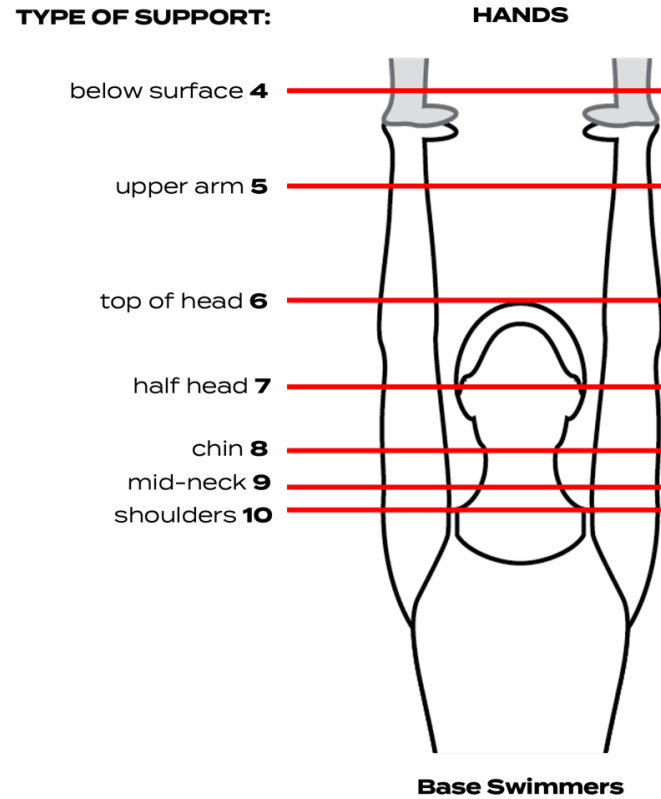



**15.2.5.6 GROUP P (PLATFORM)**

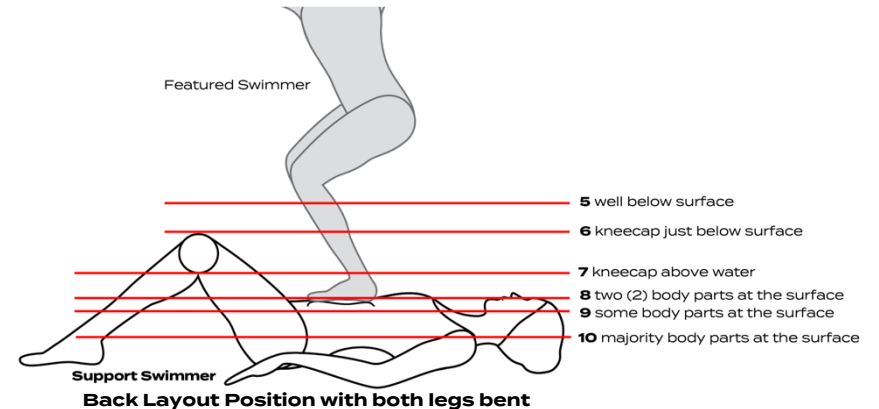
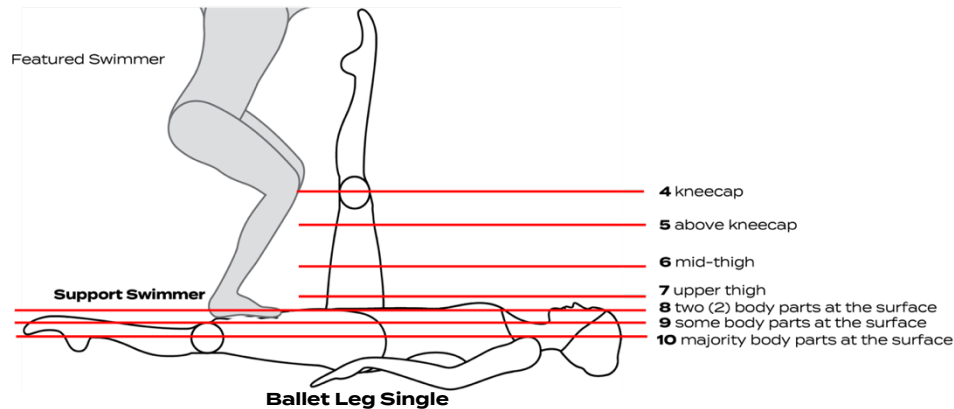
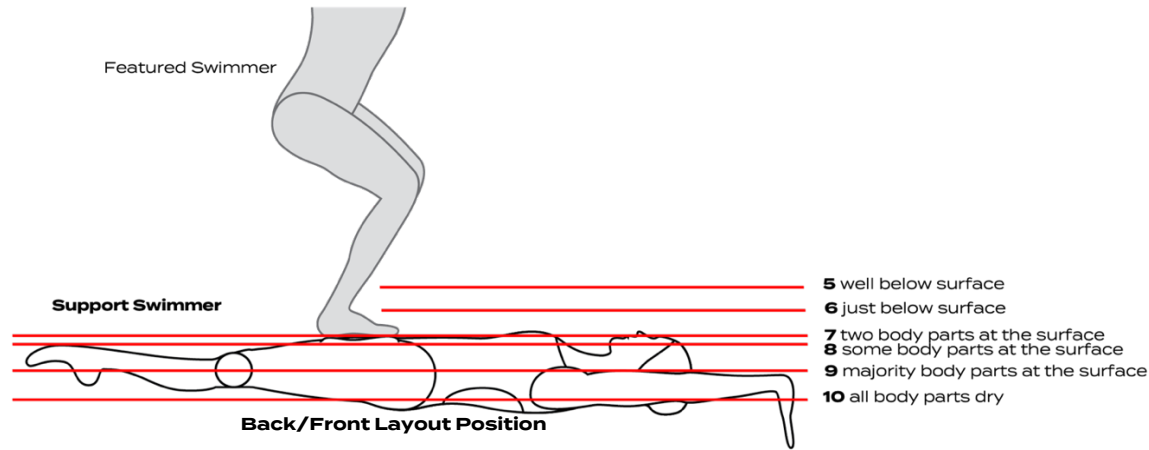

The above diagram also applies if the Support Swimmer is in Ballet Leg Double Position.

**15.2.5.7 PAIR ACROBATICS**

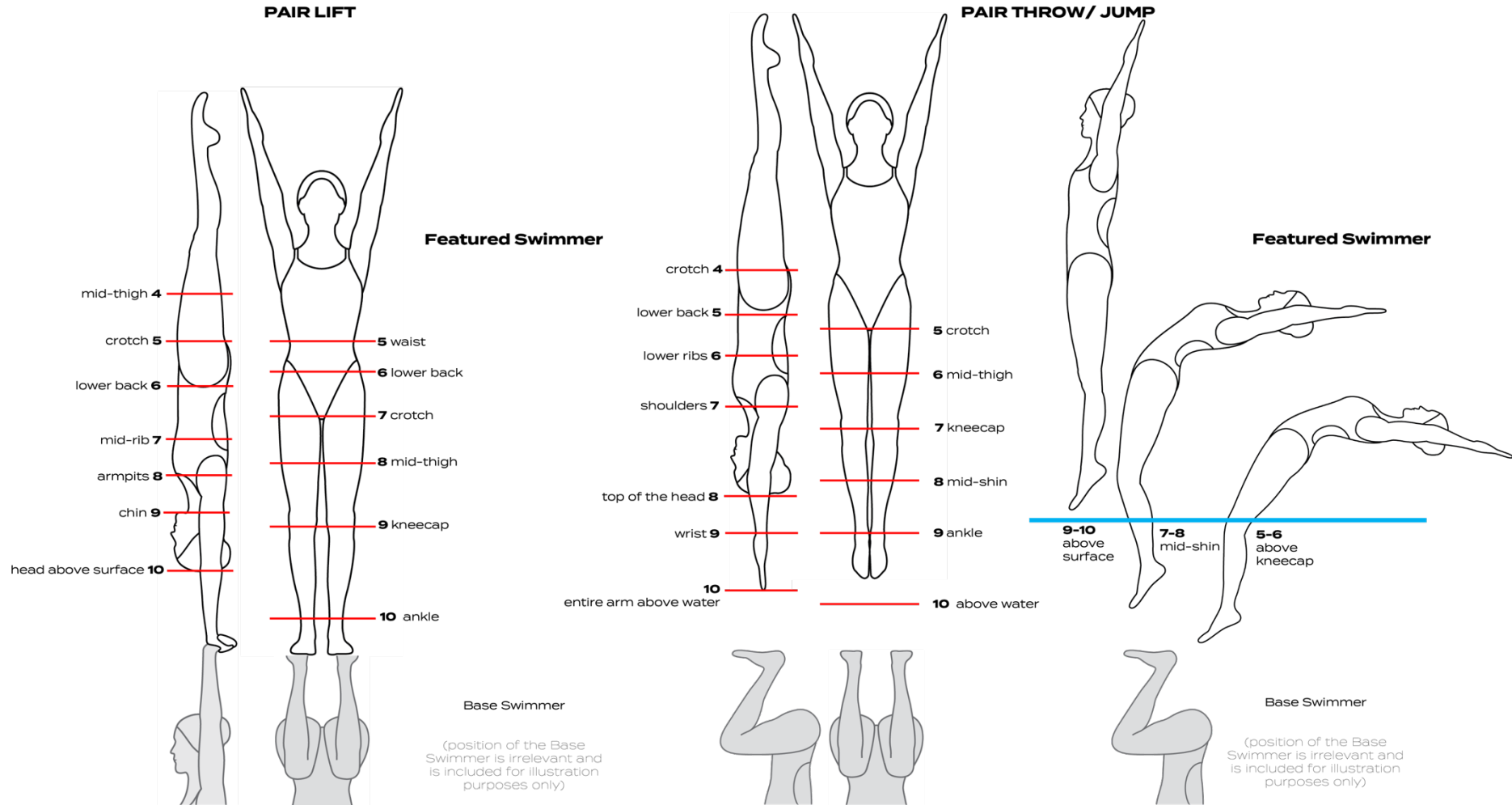

**15.2.5.8 GROUP C**

In Group C, the applicable height chart is based on the type of Acrobatics in the main (bigger) formation (Platform, Stack, etc.) of the Construction. Once the Acrobatics type is determined, the height chart for “big” Acrobatics is generally used (see Stack + throw with two Featured Swimmers in connection with each other below as an exception to this rule). Below are examples of Group C Acrobatics that indicate the athlete the Judges should focus on to determine the height.

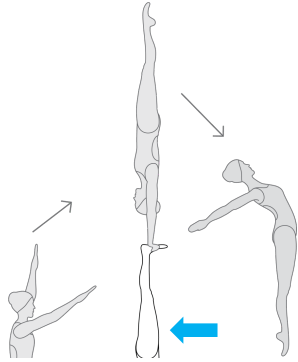

For “Jump through head- down support” apply the height chart for Group B – Stack head down (Big Acro)

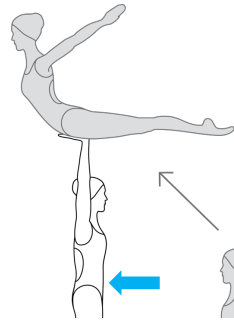

For “Onto support from spotter” apply the height chart for Group B – Stack head up (Big Acro)

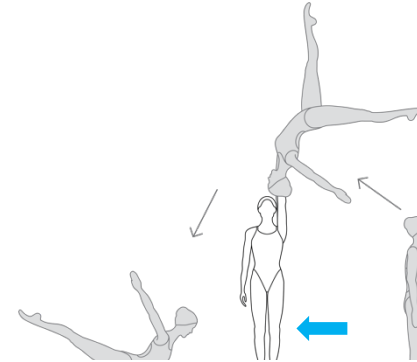

For “Jump through head-up support” apply the height chart for Group B – Stack head up (Big Acro)

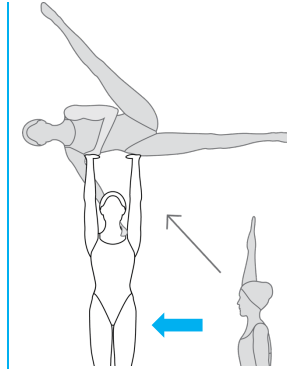

For “Transit onto support from spotter” apply the height chart for Group B – Stack head up (Big Acro)



For “Through: Platform from 1+” apply the height chart for Group P – Platform (Big Acro)

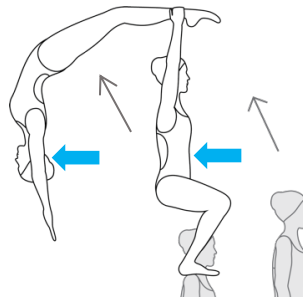

For “Stack + throw with two Featured Swimmers in connection with each other”, apply the height chart for Group A (Small Acro) to each of the two Featured Swimmers and calculate the average mark

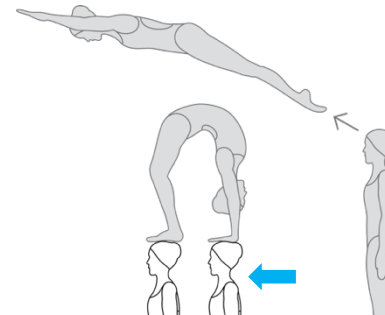

For the “Fly above formation” apply the height chart for Group B – Lift head down support (Big Acro)

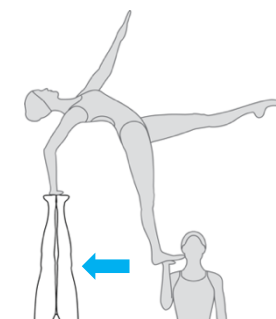

For “Transit jump through head-down support” apply the height chart for Group B – Stack head down (Big Acro)

**15.2.6 Deduction Guidelines for Acrobatics**

<b>DEDUCTIONS IN RELATION TO THE FEATURED SWIMMER</b> Deductions: small 0.25, medium 0.5 - 0.75, large 1.0 - 2.0					
Acro Phase	Deduction Category	Deduction Description	Main Group	Type	Examples
<b>BEGINNING / MAIN PHASE</b>	<b>ANGLES</b>	Featured Swimmer deviates from an ideal position.	A, B, C, P	S	5° - 15° deviation of the Featured Swimmer from an ideal position.
				M	16° – 44° deviation of the Featured Swimmer from an ideal position.
				L	45° and more deviation of the Featured Swimmer from an ideal position.
	<b>EXTENSION</b>	Featured Swimmer displays a lack of extension during the movement.	A, B, C, P	S	Not extended for a small part of the movement.
				M	Knees and/or feet are not tight throughout the movement.
				L	Lacking extension for majority of movement.
	<b>CONTROL</b>	Featured Swimmer displays a lack of control causing repeated actions or extra movements (not intentional).	A, B, C, P	S	<b>A:</b> Hands splashing before stack or uncontrolled kicking of legs at surface while submerging. <b>B:</b> Featured Swimmer stands up slowly and/or hips go before head. May achieve position but passes through first position. <b>B:</b> Slip of hand or leg during balancing but Featured Swimmer does not fall. <b>P:</b> One (1) (or more) Base Swimmer decides to give additional support to a Featured Swimmer either in Platform or Float to prevent a fall.
				M	The same issue as small, but more significant problem that causes medium deduction.
				L	The same issue as medium, but more significant problem that causes large deduction.
	<b>DIRECTION/ DISTANCE</b>	An incorrect "direction" line of the Featured Swimmer during the jump. This influences the general impression for the acrobatic movement and can be dangerous for other athletes.	A, C	S	The same issue as medium, but less significant problem that causes small deduction.
M				<b>A:</b> The jump or throw does not follow the direct intended line from the Construction. <b>A:</b> The jump or throw should not be too far from the Construction (unless choreographed). <b>A:</b> The jump or throw should not be too close to the Construction. <b>C:</b> "Onto support/ throw on a platform" Featured Swimmer jumps but platform is too far, Feature s Swimmer does not jump on the designated part of the body of the 2 <sup>nd</sup> Formation (trying to save acrobatic movement) and is very unstable.	
L				The same issue as medium, but more significant problem that causes large deduction.	
<b>END PHASE</b>	<b>WATER ENTRY</b>	Water entry of the Featured Swimmer should be clean and intentional.	A, B, C, P	S	<b>A, C:</b> Featured Swimmer's jump is inaccurate and causes a splash not intentional. <b>B, P:</b> Entry into the water is not controlled (for example all acrobatic movement were ok but after rotation of the construction base – Featured Swimmer slips)
				M	<b>A, C:</b> When the water entry is excessively splashy and unclear (called "whale falls") Note: It is a job of the TC to see if in this case the rotation is within the "allowance" or if it is a Base Mark.
				L	<b>A, C:</b> Featured Swimmer was supposed to demonstrate a somersault (rotations in the air that are done by Featured Swimmer in sagittal plane) but due to the poor execution they fall on the back or stomach (or swimmer performs "fall on the face" – when the somersault in tuck position occurs, but the swimmer did not complete the somersault around 90° and "smacks" the water surface).

<b>DEDUCTIONS IN RELATION TO THE SUPPORT SWIMMERS/CONSTRUCTION/BASE SWIMMERS</b>					
<b>Deductions: small 0.25, medium 0.5 - 0.75, large 1.0 - 2.0</b>					
	<b>DESIGN</b>	Visibly poor design.	A, B, C, P	S	<b>A:</b> Throw from surface is not synchronized when pushing the Featured Swimmer in the air. <b>B:</b> Poor timing in two (2) stacks or a Split position lift when one (1) leg is lifted before the other leg. <b>P:</b> Clear arch required in the construction but the arched is not visible.
				M	The same issue as small, but more significant problem that causes medium deduction.
				L	The same issue as medium, but more significant problem that causes large deduction.
	<b>STABILITY / SUSTAINABILITY OF CONSTRUCTION</b>	Construction is not at the surface of the water.	A, B, C, P	S	<b>P:</b> The Construction is not on the surface at all times but goes up and down because of lack of strength of the Base Swimmer. <b>P:</b> The Float made from hands is under water and the Base Swimmer goes up to take a breath.
				M	The same issue as small, but more significant problem that causes medium deduction.
				L	The same issue as medium, but more significant problem that causes large deduction.
	<b>STABILITY / SUSTAINABILITY OF SUPPORT</b>	Lack of stability of the support.	A, B, C, P	S	<b>B:</b> Arms of the Support Swimmer are bent when they should be straight, or arms are spread to sides when they should be vertical.
				M	<b>A:</b> Pushing Stack type construction and Support Swimmer is not stable and falls (jump still happens). <b>A:</b> "Basket/square" construction breaks and randomly submerges. <b>A:</b> While pushing feet to feet (or from two (2) support legs) legs of the support goes one after another causing the Featured Swimmer to be unstable. <b>B:</b> Stack is lifted but does not stop at maximum height. <b>C:</b> "Onto jump from dynamic stack on "balance" stack and remain on palms"- Featured Swimmer jumps and can only balance for a second on straight hands of the Support Swimmer before the Support Swimmer bends their arms while trying to hold Featured Swimmer. <b>P:</b> A connection between two (2) Featured Swimmers is broken while performing acrobatic movement. <b>P:</b> In a straight body construction the legs or torso of the Support Swimmer are under water. <b>P:</b> In a Ballet Leg or Double Ballet Leg construction the legs of the support are not stable and move to prevent a fall.
				L	The same issue as medium, but more significant problem that causes large deduction.
	<b>PUSH PROBLEM</b>	Difficulty with supporting the Featured Swimmer.	A, B, C, P	S	The same issue as medium, but less significant problem that causes small deduction.
				M	<b>B:</b> Support is shaking with visible difficulty pushing Featured Swimmer (for example in "twins" grip) <b>P:</b> In a "Ballet leg" construction the Support Swimmer is unable to extend the vertical leg on which they attempt to push up the Featured Swimmer
				L	<b>B:</b> Support Swimmer is unable to lift-up the Featured Swimmer above the head and their arms remain bent and/or shaking. Appears very unstable and almost falls. <b>C:</b> Acrobatic movement from subgroup "Snake-stack type" that barely lifts out of the water and is done on the surface.

<b>FALLS</b>					
<b>Deductions: small 1.0, medium 2.0, large 3.0</b>					
	<b>SMALL FALL</b>	Support Swimmer falls.	A, B, C, P	S	<b>B:</b> Acrobatics does not fall but the Construction with two (2) Support Swimmers moves or falls forwards or backwards.
	<b>MEDIUM FALL</b>	Featured Swimmer may be close to falling or falls at the end of acrobatic movement.	A, B, C, P	M	<b>A:</b> During a return of the Featured Swimmer to the Construction the legs of the Featured Swimmer slip through or off the Construction. <b>B:</b> Both the Support Swimmer and the Featured Swimmer fall, or the Support Swimmer falls while the Featured Swimmer stands inaccurately. <b>B:</b> Legs of the Support Swimmer from the vertical or a "V" position open and the Featured Swimmer falls.
	<b>LARGE FALL</b>	Featured Swimmer falls.	A, B, C, P	L	<b>A:</b> The Featured Swimmer returns on the Support Swimmer's hands, but the Support Swimmer does not hold well, and the Featured Swimmer slips in the water. <b>B:</b> Falling from the Support Swimmer or falling with the Support Swimmer to a side during rotation. <b>C:</b> During "Run on the back" the Featured Swimmer slips and falls. <b>C:</b> During "Jump on the stack" Featured Swimmer did what was declared but could not hold the balance and falls. <b>C:</b> Featured Swimmer jumps from a simple throw and attempts to do a cartwheel through support on the surface, but the push was not enough resulting in a fall. <b>C:</b> "Through Base Swimmer from simple throw", the Featured Swimmer jumps on the hands of the base but due to unsynchronized action within the construction, the athlete falls in the water not completing the action. <b>P:</b> In a "bent knee" construction, knees are not stable causing the Featured Swimmer to a fall. <b>P:</b> In "Float from two (2) parallel supports" or the "Rhombus" Float- one (1) of the supports disconnects and swims away.
<b>SET-UP AND RECOVERY TIME</b>		There is no deduction for a long set-up or recovery time (grouping / forming a Construction and after acrobatic movement – "ungrouping"). The Elements Judges may, however, award a small credit for fast set-up time and recovery after the completion of the acrobatic movement.			
<b>COMPLETE FAILURE</b>		If an acrobatic action is attempted but it does not surface, or it can be considered a complete failure, or it is unclear which Acrobatics was intended to be performed, the Element Judges will give a 3.0 mark (a minimum score).			

### 15.3 Technical Required Elements (TRE)

When judging TREs Judges must follow judging guidelines as for Figures.

Judges need to know the TRE well but do not have to consider the rules regarding allowance for *Spins* or *Twists*, omitting part or performing an incorrect action that would result in a zero (0) when scoring a Figure. Judges in Elements panel must focus on the accuracy of design in positions, transitions, and speed requirements, along with control factors, and deliver a score for each TRE. Difficulty Technical Controllers (DTCs) will identify if any part of the TRE is omitted or does not conform with the requirements and assign a zero (0) as the declared difficulty for the Element (**AS 18.7.1**).

Judges use the same deduction guidelines adapted to the scoring in routine: small 0.25, medium 0.50 and large 1 point, for any deviation from the TRE description.

### 15.4 Use of Expanded Marking Scales

Expanded Marking Scales depict examples of what could be commonly seen in athletes' performance. Typically, athletes develop all necessary skills progressively, therefore, it is uncommon to see a performance that is excellent in control but with large deviations; however, any situation may occur. Judges must be prepared for these situations and use the marking scales correctly. For each score range, Expanded Marking Scales depict a general impression of the performance, including the type and the number of mistakes/deviations from the standpoint of perfection.

**In order to determine the mark for Elements** Judges use the respective Expanded Marking Scales for TREs (the same as Figures, see CHAPTER II. - 9.6), Hybrids (see Section 15.4.1) and Acrobatics (see Section 15.4.2).

**First**, Judges set a score range for the general impression based on the control factors height, extension and stability. **The score ceiling is set based on the average height achieved by the athlete(s) for all types of Elements.** Dynamic and stable height scales and split scales for Hybrids and TRE are the same as for Figures (see CHAPTER II. - 9.5 and CHAPTER II. - 9.5.2, respectively); for Acrobatics a specific height scale is provided (see 15.2.4).

Perfect execution at a height of 7 cannot be scored over 7. Consider which scale is applicable (stable or dynamic) and what position should be evaluated (in Hybrids vertical position with one (1) leg or two (2) legs, fishtail, split, table, tuck, etc.; in Acrobatics position of Supporting, Featured or Base Swimmer(s)).

- Judges do not consider actions performed at ankles for height average.
- Height in pushed up non-sustained movements is not included in the Guiding Scale for Height Quality of Performance. Judges do not establish the average height considering the push-up actions, but in the final execution evaluation, the number and height of these actions may lead to move a quarter point (0.25) up or down of the Judge's score.
- Guiding scales are divided by one (1) point. A height between 8.5 and 7.5 on the scale can be scored 7.75, 8.0 or 8.25.
- Evaluate the performance in terms of low, medium, and high score range. In case of doubt, go with the higher mark.

**Second**, Judges deduct from the general impression score for any deviations observed that do not correspond with the description of the general impression score range that applies to each type of Element. Remember, each score range describes the type of deviation/ mistake commonly observed.

An example of a deviation that might occur in a Hybrid may be in the position during a vertical descents or ascents (after rockets, during spinning, from sustained vertical position); unwanted travelling (clear for duets and teams altering positioning); unintended deviations from vertical in fishtails, vertical positions etc. Judges use quarter points according to the magnitude of deviation (small 0.25, medium 0.50-0.75, large 1.0).

**DEDUCTIONS** (for TRE and Hybrids see suggested deductions in Figures section (see CHAPTER II. - 9.4) and for Acrobatics (see Section 15.2.6).

	<b>SMALL</b>	<b>MEDIUM</b>	<b>LARGE</b>
<b>TRE &amp; HYBRIDS</b>	0.25	0.5-0.75	1
<b>ACROBATICS (General)</b>	0.25	0.5-0.75	1-2
<b>ACROBATICS (Falls)</b>	1	2	3

When scoring Hybrids or TREs in team routines consideration must be given to the number of athletes performing a large deviation (obvious mistake). If half of the team demonstrates the deficiency a deduction -0.5 should be applied to the Element. If more than half of the team demonstrates a large deviation, then a -1.0 should be applied to that Element by the Elements panel. For example:

- In a team of eight (8) athletes -
  - **One (1) to four (4)** athletes demonstrate the deficiency = **0.5** deduction.
  - **Five (5) to eight (8)** athletes demonstrate the deficiency = **1.0** deduction.
- In a team of six (6) athletes -
  - **One (1) to three (3)** athletes demonstrate the deficiency = **0.5** deduction.
  - **Four (4) to six (6)** athletes demonstrate the deficiency = **1.0** deduction.

**Judges must remember that the difficulty of Elements should not be considered at all. This will be factored in through the degree of difficulty and the calculation of the result.**

Examples how to determine the mark for Elements:

Example 1: The Elements Judge places a performance in the satisfactory score range according to the Expanded Marking Scale. It means that the average height was between 5.5 and 6.5 and that medium and large deviations may have been detected. The Judge does not deduct 2 or 3 points for large deviations but decides if the final score has to be in high 4 or in mid 5 depending on height attained and number of deviations.

Example 2: The Elements Judge places a performance in the good score range according to the Expanded Marking Scale, which means that small and medium deviations may have been detected, and that the average height was between 7.5 and 8.5. To decide the final score, the Judge considers if there were medium deviations, and how many, to stay in the high good (7.75) or good (7.0) category.



Example 3: The Elements Judge places a performance in near perfect score range according to the Expanded Marking Scale, which means full control, near maximum height and maybe one (1) or two (2) small deviations. In such case, the Judge awards the maximum score they can, that is as for height attained (9.5 -9.75). If all requirements in Expanded Marking Scale for the near perfect execution were there BUT a large or medium deviation was observed, the Judge deducts 1 or 0.5 point. The score does not fall into competent or good category but clearly demonstrates the impact of the large or medium mistake/deviation and distinguishes it from a similar performance level without large or medium mistakes/deviations.

**15.4.1 Expanded Marking Scale for Hybrids Execution**

CATEGORY	MARK	HYBRIDS EXECUTION				
		HEIGHT	EXTENSION/ CONTROL	DEVIATIONS	FLEXIBILITY RANGE	PATTERNS (TEAMS)
<b>Perfect</b>	<b>10</b>	Maximum-over 9.5 in scale both dynamic and stable	Full control - solid stability Accurate lines in all Hybrids. Full extension of body and all joints. Effortless, clean	No deviations	Extreme flexibility (hips, shoulders, spine)	Sharp, precise, totally controlled pattern and accurate pattern changes during the Hybrid
<b>Near Perfect</b>	<b>9.5-9.75</b>	Near maximum (scale 9.5)	Full extension. Stable, effortless, clean	Only very few (1-2) small deviations	Extreme	Small misplacement of the pattern (1-2) for very short duration of time during the Hybrid
<b>Excellent</b>	<b>9.0-9.25</b>	Average clearly on 9.0-9.5	Full extension. Minimum problems in stability	Few (2-3) small deviations	Extreme	Small misplacement of the pattern (1-2) for very short duration of time during the Hybrid
<b>Very Good</b>	<b>8.0-8.75</b>	Average 8.5 to 9.5	May lose full extension or total stability but for a minimum duration	Few (2-3) small deviations	Large	Few small misplacements during the Hybrid but pattern remains very clear
<b>Good</b>	<b>7.0-7.75</b>	Average 7.5 to 8.5	May lose full extension or total stability for a few moments during Hybrids (obvious)	Small and medium deviations. No large deviation	Average / medium	The pattern during the Hybrid is clear and understandable but may have 1 or 2 athletes 'out' of placement
<b>Competent</b>	<b>6.0-6.75</b>	Average 6.5 to 7.5	Not full extension at any moment, but not poor either. May show obvious lack of stability	Small and medium deviations No large deviation	Medium to small	Misplacements causing the pattern to be imprecise during majority of the Hybrid. Corrections required by 1 or 2 athletes
<b>Satisfactory</b>	<b>5.0-5.75</b>	Average 5.5 to 6.5	Not full extension at any moment, even poor occasionally. Obvious lack of stability	Medium and large deviations	Small	Pattern is not clear for most of the Hybrid. Frequent modifications required by athletes
<b>Deficient</b>	<b>4.0-4.75</b>	Average 4.5 to 5.5.	Poor extension and obvious lack of stability during all Hybrids	Medium and large deviations	Small	Very unclear with continuous, unnecessary movements that do not correct the misplaced pattern during the Hybrid
<b>Weak</b>	<b>3.0-3.75</b>	Low height	Struggling in all aspects	Large deviations	Small to none	Difficult to identify the pattern during the Hybrid

**15.4.2 Expanded marking scale for Acrobatics Execution**

CATEGORY	MARK	ACROBATICS EXECUTION
<b>Perfect</b>	<b>10</b>	<b>A:</b> Maximum height with very minimal setup and recovery time Clean entries <b>P</b> and <b>B:</b> High, stable Very strong and powerful Precise, accurate positions and movements of the Featured Swimmer(s)
<b>Near Perfect</b>	<b>9.75</b>	<b>A:</b> Near maximum height with very minimal setup and recovery time Clean entries Very strong and powerful <b>P</b> and <b>B:</b> High, stable (maybe a minimum problem with stability) Precise, accurate positions and movements of the Featured Swimmer(s)
	<b>9.5</b>	
<b>Excellent</b>	<b>9.25</b>	<b>A:</b> Near maximum height. Minimal set-up and recovery time May have small deviation at entry Very strong and powerful <b>P</b> and <b>B:</b> High, stable May have small inaccuracies in positions and or movements of the Featured Swimmer(s)
	<b>9.0</b>	
<b>Very Good</b>	<b>8.75</b>	<b>A:</b> High, stable, and convincing Some noticeable set-up and recovery time required Mostly strong and powerful Clean entry <b>P</b> and <b>B:</b> high and stable. Small Inaccuracies in positions and or movements of the Featured Swimmer(s)
	<b>8.5</b>	
	<b>8.25</b>	
	<b>8.0</b>	
<b>Good</b>	<b>7.75</b>	<b>A:</b> Medium height and lacks some accuracy in positions. <b>P</b> and <b>B:</b> Stability not maintained throughout. Medium height Noticeable setup time and recovery time Lack of strength and power Entry not clean Small Inaccuracies in positions and or movements of the Featured Swimmer(s)
	<b>7.5</b>	
	<b>7.25</b>	
	<b>7.0</b>	
<b>Competent</b>	<b>6.75</b>	<b>A:</b> Medium height with inaccurate achievement of positions <b>P</b> and <b>B:</b> Unstable throughout. Medium height Lack strength and power Long set-up and recovery time Entries are not clean
	<b>6.5</b>	
	<b>6.25</b>	
	<b>6.0</b>	
<b>Satisfactory</b>	<b>5.75</b>	Acrobatics is attempted but is low and unstable. One (1) or more athletes about to fall (not the whole structure) Very long set-up and recovery time Poor entry
	<b>5.5</b>	
	<b>5.25</b>	
	<b>5.0</b>	
<b>Deficient</b>	<b>4.75</b>	Acrobatics may be attempted but very low and unstable. One (1) or more athletes can fall (still something is done). Poor entry, if finished
	<b>4.5</b>	
	<b>4.25</b>	
	<b>4.0</b>	
<b>Weak</b>	<b>3.75</b>	Acrobatics is unstable and unclear. Looks failed- One (1) or more athletes fall (still something is done) Minimum or no height (i.e., platform looks like a low boost) If present, hardly recognizable except at surface (3.0)
	<b>3.5</b>	
	<b>3.25</b>	
	<b>3.0</b>	

**15.5 PROCEDURE GUIDELINES FOR ELEMENTS JUDGES**

When judging Elements:

1. Judges will be provided with a simplified program for each routine, including the type of Element (TRE, Hybrid, Acrobatics) numbered in the correct order of performance, as submitted on the Coach Card. The simplified program will be provided on the electronic scoring device and/or paper copy.
2. Judges will score the Elements in the order according to the program provided.
3. If an Element is missed or misplaced the Judges should not score but skip the field for entering the score leaving it empty and move to the next Element. Judges do not look back in the program to reallocate a score out of order.
4. Judges score each Element based on execution criteria and are not concerned with the content of the Element.

Examples of entering the score if Elements are performed in an incorrect order or if an Element is missed:

 Example 1: **Missed Element** (Senior Women Duet Technical)

DECLARED		
ELEMENT	#	SCORE
TRE 4a	1	
PAIR ACRO	2	
TRE 1a	3	
HYBRID	4	
TRE 2b	5	
TRE 3a	6	
TRE 5b	7	
HYBRID	8	

PERFORMED			
ELEMENT	#	ELEMENTS JUDGES SCORE	TC
TRE 4a	1	8.75	
PAIR ACRO	2	8.50	
TRE 1a	3	7.50	Zero
<b>HYBRID</b>	<b>4</b>	<b>NOT PERFORMED - NO SCORE</b>	<b>2-point penalty</b>
TRE 2b	5	8.50	
TRE 3a	6	8.0	
TRE 5b	7	7.75	
HYBRID	8	8.25	

 Example 2: **Extra Element** (Senior Women Duet Technical)

DECLARED		
ELEMENT	#	SCORE
TRE 4a	1	
PAIR ACRO	2	
TRE 1a	3	
HYBRID	4	
TRE 2b	5	
TRE 3a	6	
TRE 5b	7	
HYBRID	8	

PERFORMED			
ELEMENT	#	ELEMENTS JUDGES SCORE	TC
TRE 4a	1	8.75	
PAIR ACRO	2	8.50	
TRE 1a	3	7.75	
HYBRID	4	8.25	
TRE 2b	5	8.50	
TRE 3a	6	8.0	
TRE 5b	7	7.75	
HYBRID	8	8.25	
<b>HYBRID</b>	<b>9</b>	<b>NO SCORE</b>	<b>2-point penalty</b>

Example 3: **Extra Element** (Senior Women Duet Technical)

DECLARED			PERFORMED			
ELEMENT	#	SCORE	ELEMENT	#	ELEMENTS JUDGES SCORE	TC
TRE 4a	1		PAIR ACRO or HYBRID		No score, wait for TRE as Element 1	-2 points for extra Element
PAIR ACRO	2		TRE 4a	1	8.75	
TRE 1a	3		PAIR ACRO	2	8.0	
HYBRID	4		TRE 1a	3	7.50	
TRE 2b	5		HYBRID	4	8.25	
TRE 3a	6		TRE 2b	5	8.50	
TRE 5b	7		TRE 3a	6	8.0	
HYBRID	8		TRE 5b	7	7.75	
			HYBRID	8	8.25	

 Example 4: **Extra Element and Missed Element** (Senior Women Duet Technical)

DECLARED			PERFORMED			
ELEMENT	#	SCORE	ELEMENT	#	JUDGES ELEMENTS SCORE	TC
TRE 4a	1		TRE 4a	1	8.75	
HYBRID	2		HYBRID	2	8.0	
TRE 1a	3		TRE 1a	3	7.50	
HYBRID	4		HYBRID	4	9.0	
TRE 2b	5		TRE 2b	5	8.50	
TRE 3a	6		TRE 3a	6	8.0	
TRE 5b	7		TRE 5b	7	7.75	
HYBRID	8		HYBRID	8	8.25	Eliminate scores -2 points for 1 extra Hybrid -2 points for 1 Acro missed

 Example 5: **Altered order of TRE** (Senior Women Duet Technical)

DECLARED			PERFORMED			
ELEMENT	#	SCORE	ELEMENT	#	JUDGES ELEMENTS SCORE	TC
TRE 4a	1		TRE 1a	1	8.75	Zero
PAIR ACRO	2		PAIR ACRO	2	8.50	
TRE 1a	3		TRE 4a	3	7.75	Zero
HYBRID	4		HYBRID	4	8.25	
TRE 2b	5		TRE 2b	5	8.50	
TRE 3a	6		TRE 3a	6	8.0	
TRE 5b	7		TRE 5b	7	7.75	
HYBRID	8		HYBRID	8	8.25	

 Example 6: **Altered order** of Acrobatic Routine

DECLARED			PERFORMED			
ELEMENT	#	SCORE	ELEMENT	#	ELEMENTS JUDGES SCORE	TC
ACRO A	1		ACRO B	1	8.75	Different from declared: BM (Performed Acro 3)
ACRO C	2		ACRO C	2	8.50	
ACRO B	3		ACRO A	3	7.75	Different from declared: BM (Performed Acro 1)
ACRO P	4		ACRO P	4	8.25	
ACRO A	5		ACRO A	5	8.50	
ACRO B	6		ACRO B	6	8.0	
ACRO C	7		ACRO C	7	7.75	

## 16. JUDGING ARTISTIC IMPRESSION

Artistic Impression is an effect, image or feeling retained as a result of the demonstration of skill by the athlete(s). The Artistic Impression score covers three areas: **Choreography and Musicality, Performance** and **Transitions**. Each area is scored separately from 1 to 10 points with 0.25 increments.

The aim of the Artistic Impression score is to give Coaches and athletes the opportunity to exploit athlete's artistic qualities. The scores given by this panel, should not be influenced by the other areas that determine the total score: Difficulty, Synchronization and Elements execution. It is very important that Judges realize that a routine with low (declared) difficulty can achieve a perfect score in the Artistic Impression area. The strategy of the Coach and the athlete is aimed at maximizing the total score, so Judges in the Artistic Impression panel should make sure to only reward the Artistic Impression area.

Due to the subjective nature of many parts in this component, wide latitude must be allowed. What may be considered artistic to one may seem common to another. An appreciation of a variety of cultures, styles, music types and interpretations should be cultivated. Personal feelings, i.e., whether one likes the routine or not, should not sway the Judges' perception. Evaluations and scores awarded should be based on how the routine fits the judging criteria.

### 16.1 CHOREOGRAPHY AND MUSICALITY

#### 16.1.1 Approaches to choreography

Choreography (from Greek *choreo*: circle, dance, *graphy*: writing) is the art of composing dances. The design of movements and structures inside a routine (dance) so that Elements (TRE, Hybrids, Acrobatics), patterns and Transitions are combined, and an aesthetic effect is produced. In Artistic Swimming routines are choreographed to music.

Choreography is the creative skill of composing a routine that combines artistic and technical components. It involves the design and weaving together a variety, creativity, and innovation of all movements: Elements and Transitions.

Choreography is defined as the art of assembling movements so that they have:

- Meaning (an idea that is expressed physically): the routine can tell a story, create an abstract experience, or give a physical form to music. There should be purpose to the combination of movements.
- Form/ structure: primary organizing principle for expressing and unifying the meaning/ intention. Music plays a central role determining the structure of a piece.
- Style: matching movements of a particular dance models with music styles (classic, popular, urban, hip-hop...etc.) or the creation of a personal own style.

The pillars of choreography are:

- Weight and size (movements can be heavy or light, big or small)
- Time (movements can be sudden or sustained, cadenced or in unison)
- Space (pathways or lines of travel, direction-facing during movements)
- Flow (movements bound and controlled or free and unrestrained)

The routine is not just a combination of unrelated actions. It should resemble a novel rather than a collection of short stories.

It is extremely important for the Judge to retain an open mind and the ability to appreciate a variety of styles, even though they may prefer one style over another. Judges should always be prepared to judge something they have not seen before and evaluate it according to the appropriate judging criteria.

Beyond the aesthetic experience, when evaluating the choreography, the Judge *must* consider the following areas: **variety**, **creativity** and **innovation** and **pool coverage**. As there is a separate score to award for artistic impression of Transitions, in the Choreography and Musicality score, Judges should consider the overall variety, creativity and pool coverage considering all routine parts - Elements and Transitions.

Note that when an athlete does not complete their choreography by the time the music accompaniment ends, Artistic Impression Judges must also consider and factor the length of time that movements continue when the music accompaniment ends into their Choreography and Musicality score.

### **16.1.2 Variety - diversity, assortment. The condition of being diverse.**

The athlete(s) should demonstrate a variety of body positions, figure movements, strokes, arm movements and propulsion techniques to demonstrate proficiency in the various Artistic Swimming skills. When demonstrating these skills, it is desirable to use a variety of levels of space. The athlete(s) should show a balance of strokes, figures, and propulsion techniques appropriate to the music. It is not necessary to include every skill, and some repetition may enhance the performance.

#### **1. Hybrids composition**

There are uncountable variations possible in Hybrids:

- Body positions: vertical, pike, tuck, split, bent knee, etc.
- Components from the different Families in different combinations
- Multi-dimensional movements including simple and complex angles
- Varied beginnings and endings
- Ascending, descending, continuous, combined, opening, and closing spins, twirls, and sustained rotations, all in a multitude of body positions and combinations
- Travelling or stationary movements
- Connected movements, movements in unison or in cadence

#### **2. Transitions**

A variety of transitional actions should be employed when moving from Element to Element (Hybrids, TRE, or Acrobatics). These actions include:

**Strokes and propulsion techniques.** Examples of variety in these techniques include the following:

- Bent, straight, angled, or curved arms
- Single or double arms
- Spread, flat, angled, cupped, straight, closed, or curved hand and finger positions
- Tilt, turn, lift, or stay erect head and body angles

- Height or body position changes can be made within a stroking sequence
- Front to back to side
- Horizontal to vertical and vice versa
- Boosts
- Flutter, eggbeater, scissors, whip, dolphin
- Torpedo (with or without leg or arm movements added, rolled, etc.)

**Ballet leg(s)**

- All possible combination: single, double, flamingo, from side, straight, rolled, etc.

**Surface flexibility actions**

- Surface splits in any variant
- Prone spine flexibility actions (ex: ring feet-head)

**Pair assisted actions**

- Actions performed by two (2) athletes where the bottom (base) athlete may remain under the water surface or on it, but the Featured Swimmer always remains on the surface (not lifted). Also “boost-type” assist movements are considered as pair assists actions.

**3. Speed, direction, and level:**

- The speed of actions can change from fast to slow, accelerate or slow down, stop or become extremely rapid, and include ‘frozen’ moments
- Height of movement can vary from extremely high to the surface or underwater level
- Direction change can be from straight to side, to an angle, to turning, etc.
- Direction may be forward, backward, sideways, headfirst or foot first

**Patterns and pattern changes**

- Patterns and pattern changes can also vary
- Spread patterns and close formations
- Curved lines and circles
- Straight lines and diagonals
- Moving or stationary patterns
- Symmetric and asymmetric patterns
- Box, diamond, triangle, V, X, cross
- Groups in a team can be varied:
  - All 8 athletes



- 4-4 athletes, 2-2-2-2 athletes, 3-2-3 athletes, 1-7 athletes, 2-6 athletes, etc.

#### 4. **Acrobatics**

- Different groups (A, B, P and C)
- Variety in positions, directions, rotation, planes
- Pair Acrobatics

### **16.1.3 Creativity - the act of being original or imaginative**

Creativity should be considered in the broad sense of making something out-of-the-ordinary, something unexpected or surprising. It may entail combining or changing familiar material to offer something unique, or it may be the way in which music is used to make something happen, to cause an element of surprise, or to replace the obvious stereotype with the unexpected. The meaning of *creative* should not be restricted to new or original, but instead should be understood as the *making of a lasting impression, something truly unique, a 'memorable moment'*.

In Duets and Teams, connections between athletes may add to the creativity of the choreography.

The routine may also demonstrate a creative use of the music. This refers to using the music in an appropriate manner but in other than the expected stereotype for the music used.

Look for creativity in all actions: Hybrids, Acrobatics, Transitions, patterns, and pattern changes, paired and group actions. A superior routine will use a wide variety of creative movements and patterns.

#### a) **Uniqueness**

Look for unique, unusual, innovative, out-of-the-ordinary, surprising, or unexpected actions.

#### b) **Paired and team actions**

These may include joined or intertwined movements in pairs or groups, floats and connected actions, lifts, throws (such as somersaults in the air) and platforms with statues.

#### c) **Highlights and memorable moments**

In addition to the above, memorable moments may come from:

- a combination of actions
- rapidly changing combinations of float sequences
- combinations of figure and/or stroke sequences
- peel-off or add-on cadence actions
- exciting figure actions such as Rocket Splits, Thrusts, Thrust Spins or open and closed multiple spins of varying tempos

***Look for movements that are distinctive!***

#### **16.1.4 Pool coverage, pool pattern**

Pool coverage or pool pattern is described as the area through which the athlete moves or the pathway the athlete takes through the water. *Constant travel* throughout the routine is desired. How the athlete moves throughout the pool area and the pattern of movement they create should be major considerations.

A well-choreographed routine will be constantly moving and will cover the whole pool. In a routine with good pool coverage, athletes will avoid spending extended periods of time in a small area of the pool.

##### **a) Constant flowing action**

Routines travel the length, on angles, to corners and sides of the pool while moving in and out of patterns. The flow should continue without abrupt stops, reverse actions, or retracing paths unless they are for choreographic effect. Time spent in any one spot should be minimal.

##### **b) Effective use of space**

Although the space should be effectively used for movement to cover all areas of the pool, consideration should also be given to the placement of highlights and special actions. These special actions should be placed where they can be effectively seen and appreciated.

#### **16.1.5 Musicality - Use and Interpretation of music**

Musicality is defined as "musical quality or character"; therefore, all music and its interpretation have musicality. We understand musicality in artistic swimming as the ability of athletes to express what the music says and how it makes them feel, based on their personality. Athletes must be expressing the mood of the music, while making use of the music's structure.

The use of music refers to how the athlete(s) use the structure of the music. The use of music should be judged with an open mind, allowing for a wide latitude of individual interpretation. Maybe a spoken word piece is used or there are deliberate silences in the routine. Judges should be prepared to reward the use of all kinds of sound or the absence of it.

Music has a far greater influence because the music is the basis for all the other categories. Choreography is dependent upon it; performance relates to the feeling the athlete has for the music. Using music effectively should be thought of as the blending of movements and music into a oneness of expression.

In the Solo event, when use and interpretation of the music are done to perfection, it will appear as if the *soloist and their music are one*. It is as though the music was written for them.

##### **Interpretation of character, mood, feeling**

Music Interpretation in Artistic Swimming means the translation of sounds, rhythms, dynamics, melodies, moods, accents, and highlights in the music to suitable expression of movement in water. The nature of the music, from full symphonic orchestration to a single violin concerto, from symphonic choral works to pop ballads, determines the type of action that the choreographer chooses to use to express its mood and the emotional responses needed for its portrayal.

Music may range from strong, forceful, staccato, and loud to soft, subdued, delicate and flowing. Strong, dynamic music calls for powerful, grandiose actions and movements. Soft, flowing music calls for a more lyrical interpretation with rounder, more fluid and delicate actions. Fast, quick, complex movements fit music with a fast tempo, whereas slow, graceful movements must be created for slower passages. The mood of the music may induce tension or excitement, joy, or tranquility in the listener. Some music calls for continuous flowing action; other music has stops and starts demanding intermittent or staccato action. The nature and demands of the music should all be found in the athlete's portrayal of it. An exceptional performance will give the effect of the athlete being the music, exploring all qualities and adding their own special interpretation.

**a) Character, quality**

Consider the sound: full symphonic orchestration or single instrument; pop vocal or military band; chamber quartet to rock band; strident, overriding beats or soft, flowing melody. Then consider whether the character of the music has been portrayed by the movements in the water.

**b) Mood, meaning**

Consider the mood or meaning of the music, strong, romantic, joyous, sorrowful, patriotic, etc. Consider both the obvious and subtle qualities of the music and whether they have been interpreted and provide meaning.

**c) Feeling, fervor, and passion**

Consider the emotional impact of the music and how it has been interpreted. The athlete must be able to bring out the emotion heard by the viewers through the interpretation given.

**Use of the music's dynamics**

The term 'use' means 'availing oneself of something as a means to an end'. The music's rhythms, dynamics and accent points set the tempo and power for the actions. Literally, use of the music is how the athlete use the beats and measures, the 'highs and lows', varying melodic themes, different instrumental sounds, and the dynamic changes (highlights and accent points).

Highlights or accent points in the music call for something special such as boosts, platforms, lifts, throws, split rockets, multiple spins, etc. A superior routine will match the highlights to the special accents in the music. These are the memorable moments that remain with the viewers.

**a) Tempo changes**

Actions must match the tempo - fast, moderate, slow, or stopped—and change when the music does.

**b) Power and delicacy**

Movements match the strength and delicacy heard. Strong, angular, and forceful actions are used for dynamic music. Flowing, curving, soft actions are best for lyrical, melodious parts. The highs and lows in the music are matched by actions, up high or low in the water.

**c) Accents and highlights**

Memorable moments are matched to the accents and highlights in the music—the crescendos and decrescendos, big cymbal clangs, drum rolls, etc.

The athlete can portray a special performance by using the music in a very different way as the 'standard' description above, giving additional effects that are only brought out in this specific performance.

### **Synchronization with music**

The Judge must consider whether athlete's actions are coordinated with the rhythm, melody, accents, or highlights and whether there is synchronization with the special effects in the music that may be used for spins, rockets, boosts, stacks, lifts, and throws. Changes of the pace of movements should occur in conjunction with the tempo changes in the music.

Judges should take into consideration major deviations from the tempo or feeling of the music, or obvious failure to match actions with a musical accent or highlight.

Please note that this should not be confused with athletes not being in unison. The synchronization with music can be perceived as being more prominent in Solo routines and in the execution of acrobatic movements.

## **16.2 PERFORMANCE**

Performance is the way the athlete or athletes present the routine to the viewers, as well as how they "dominate" the space.

Performance involves the use of the face and the whole body. The athletes must demonstrate they that they are in total command throughout. The impression is one of a richness of movement, with the athlete 'owning the water'. Total command requires a completeness of performance that demonstrates confidence, poise, and effortlessness; a high-energy level, both physical and emotional; and consistency of performance with the maintenance of an illusion of ease throughout. There must be responsiveness to the emotions expressed by the music and appropriate to the choreography, along with the ability to communicate with sincerity and enjoyment to viewers so that they are drawn into and feel as if they are a part of the performance.

Routines that receive top scores in this category show dynamism and strength yet are also fluid, graceful and captivating. They have an allure, an appeal to the senses, a magnetism; in short, they have charisma.

### **a) Completeness of performance**

#### **Use of whole body, body language**

Superior athletes will demonstrate excellent carriage and posture and be able to display and make use of body language in head and torso positions, in leg, arm and hand movements and in facial expressions, to carry a message to the viewers.

#### **Focus of body and face**

Look for eye contact and use of the head. The focus can be erect and upright, with straight or squared shoulders, or it may be soft, curving, turning with tilting shoulders and accompanied by appropriate facial expressions to carry a message to the viewers.

#### **Use of varied moods**

The athlete should be able to demonstrate a desired mood (love, power, joy, sorrow, anger, pain, etc.) to allow the audience to also feel the emotions heard in the music.

### **b) Aura of total command, confidence**

#### **Convincing presentation**

The entire performance should be purposeful, riveting, and demanding attention, with an air of confidence and command maintained throughout. Athletes(s) show complete personal involvement in the routine.

Consider in the scoring the initial appearance (self-introduction): the walk-on and deck movements and positions should be assured, with sharp, clear, and commanding positioning. The ending position should also be sharp, clear, and commanding.

Note that while the swimsuit is not of a principal importance, if a very special creative or innovative design to match the theme or music is shown, Judges may consider rewarding it with a bonus of maximum of 0.25 points.”

***The performance should seem fresh and spontaneous throughout.***

c) **Effortlessness throughout**

An illusion of ease should be maintained throughout the performance. The breathing should be quiet and not explosive or wheezing. All movements should appear effortless and powerful without splash or struggle. The return to the surface and ‘break-through’ should be smooth and easy, without sputtering, blowing bubbles or fountains of water. The athlete should not look frantic or panicky and should remain poised and confident throughout.

**Consistency of performance**

Top athletes will not look rushed or exhausted but will demonstrate a consistency in their level of performance from start to finish. The routine will flow seamlessly, with continual movement throughout, so that the viewer is led from one action to the next, never able to look away even momentarily because there are no stops or resting points where movement lags.

d) **Charisma and communication**

**Ability to communicate with viewers**

The personal presence of the athlete(s) can be captivating, enchanting, intriguing, fascinating, etc. The routine seems too short when it is done so well.

**Facial expressions**

If the mood of the music changes, so may the facial expressions. A ‘pasted-on’ smile is seldom appropriate, especially if the feeling of the music is serious, strong, angry, or sad and sorrowful. Throughout the routine, the athlete or athletes need to portray confidence and at ease in all their movements.

**Sincerity**

To be convincing, athletes should be able to establish an eye contact with the Judges and audience.

**Showmanship**

The terms magnetism, charm, appeal, and charisma signify how the athlete projects to the audience. Athletes must ‘sell’ their performance every time it is executed, always appearing new and fresh. Each performance should bring obvious

enjoyment eliciting spontaneous applause from the viewers. You could watch it again and again.

### 16.3 TRANSITIONS

Routines are not a loose collection of isolated movements. One of the most important features of a choreography is the way in which movements are connected.

A Transition is a movement or series of movements bound together by a physical impulse or line of energy that result in the recognition of logical connection that prevents Elements from appearing arbitrary and isolated.

Transitions are defined as all actions that are not Elements (TRE, Hybrids and Acrobatics). While Hybrids are defined as a combination of two (2) or more movements performed with lower limbs with intentional apnea, Transitions afford all creative and expressive possibilities with upper body as well as movements with lower limbs along the surface or with one (1) or two (2) lower limb actions that have consequential apnea (rolling over, kicking, etc.). Note that connected surface movements with travel required for Mixed Duets Free in Appendix III to AS Rules are considered under Transitions score.

Transitions are not only a connection between one Element with next and the main contribution to pool coverage; Transitions are as important as the Elements they bring together.

For Elements, the difficulty is rewarded through the declared difficulty (DD) as checked by the Technical Controllers. In the Transition score Execution, Choreography and complexity of Transitions should be considered without focus being given to one specific category. The ability of the athlete to perform a larger variety of transitional movements, showing constant movement of many different body parts in an excellent manner will affect the Transitions score. For the execution of Transitions, please refer to the height charts for Eggbeater and Ballet Legs in CHAPTER II. - 9.5.

In addition, it should be noted that while the variety, creativity and pool coverage of Transitions is also considered by Artistic Impression Judges under the Choreography and Musicality score in order to properly award Transitions in routines a separate Transitions score is awarded as Transitions are not considered by the Elements Judges.

In Transitions score Judges evaluate the **“richness”** or **“intricacy”** of Transitions, determined by the design and ability to perform artistic sequences of movements to facilitate emotional and physical power demonstration:

- Exploring the complete range of possible body movements (upper body and horizontal movements expressive and creative qualities)
- Defining and linking styles: use of the same or varied styles of upper and lower body movements to define the narrative or organic character of the routine structure
- Defining, building, and keeping the flow throughout

Judges should consider the complexity and the amount of body movement (the “richness”). Complexity of Transitions increases with the inclusion of:

- Complicated actions that contain many parts.
- Multiple changes in body positions, angles, directions, and water levels.
- Actions with a large variation of pattern changes.

- Very rapid, multiple quick movements to change arm, hand, leg, or foot positions.
- The complex combination of changing angles of the arms.
- Strokes that require an extreme range of flexibility, such as those with the extended arm behind the shoulder line.

Judges should also consider the following aspects:

- Transitions should be smooth and seemingly effortless, without bouncing, jerkiness or splashing, unless clearly intended otherwise in the choreography.
- There should not be any excessive, extraneous movements, loss of control, extension, or height during Transition.
- The tempo should be consistent (except when altered for choreographic effect).
- Fluidity must be seen through all Transitions.

The most effective Transitions are hardly perceived by the viewer and are accomplished so smoothly and naturally that they are finished before one is aware what has happened. Whether from stroke to Element, Element to stroke, all Transitions should flow from start to finish smoothly, logically, and effortlessly. They should be efficient and purposeful.

There should be evidence of a high energy level with no loss of power, speed, or height throughout the routine.

**16.3.1 MARKING SCALE FOR ARTISTIC IMPRESSION PANEL**

<b>Choreography and Musicality</b>	<b>9 - 10 Excellent/Perfect Bonus</b>	<b>8-8.75 Very Good Bonus</b>	<b>7-7.75 Good Standard</b>	<b>6 - 6.75 Competent Deductions</b>	<b>5 - 5.75 Satisfactory Deductions</b>	<b>4 - 4.75 Deficient Deductions</b>	<b>3.0 Weak Deductions</b>
<b>General Impression – Aesthetic experience</b>	Routine captivates, fascinates and/or enchants viewers.	Routine has an emotional effect on viewers.	Viewers enjoy the routine but might not be engaged throughout.	Predictable, and ordinary routine. Viewers may lose interest during part of the routine.	Viewers lose interest during the routine.	Very basic and simple routine.	Minimal. Limited by athlete's ability.
<b>Variety Diversity - assortment</b>	<p>The routine has a particular recognizable style.</p> <p>There is a deep harmony among the varied and assorted movements.</p>	<p>Routine is cohesive and movements flow naturally from one into another.</p> <p>The choreography shows variety in movements related to weight and size, the use of time and space and flow. Repetition of movements enhances the effect of the routine on viewers.</p> <p>Variety is blended harmoniously</p> <p>Duet and team show good variety in Acrobatics, pattern changes and number of athletes used.</p>	<p>The routine is well balanced between Elements and Transitions.</p> <p>Routine contains a variety of body positions and movements in Elements and Transitions. Repetition of movements does not result in a lack of variety.</p> <p>The athletes use different propulsion techniques and show a variety of Acrobatics, patterns, and pattern changes.</p>	<p>The routine has a lack of balance between Elements and Transitions.</p> <p>Repetition of body positions and movements in Elements and Transitions results in a lack of variety.</p> <p>There is a lack of variety in propulsion techniques, Acrobatics and/or patterns.</p>	<p>The routine is monotonous with limited variety.</p> <p>Repetition of positions and movements is disturbing.</p> <p>Only a small number of different propulsion techniques, Acrobatics and/or patterns are used.</p>	The routine has very limited content and contains a very small number of different actions in both Transitions and Elements.	The routine contains only a few basic / beginner movements and propulsion techniques.



<b>Choreography and Musicality</b>	<b>9 - 10 Excellent/Perfect Bonus</b>	<b>8-8.75 Very Good Bonus</b>	<b>7-7.75 Good Standard</b>	<b>6 – 6.75 Competent Deductions</b>	<b>5 – 5.75 Satisfactory Deductions</b>	<b>4 – 4.75 Deficient Deductions</b>	<b>3.0 Weak Deductions</b>
<b>Creativity - Innovation</b>	<p>The routine tells a story, athletes give special meaning to the music with the movements.</p> <p>The routine has innovative Elements and viewers are surprised by distinctive actions ("wow" moments).</p> <p>The performance is perceived as a unique and memorable piece of art.</p>	<p>The choreography is full and interesting throughout.</p> <p>The routine has several memorable moments achieved through creative combinations of movements.</p> <p>The routine is perceived as 'different from other routines', out-of-the-ordinary.</p>	<p>The routine contains mainly standard movements that are combined in a way which is not always surprising for the viewers.</p> <p>Perception is that of an engaging routine with one or more less interesting parts.</p>	<p>The routine is predictable with little or no memorable moments.</p> <p>Repetitive movements.</p> <p>Perception is that of a somewhat ordinary routine.</p>	<p>The routine consists of common basic actions and contains several gaps in creativity.</p> <p>Excess repetitive movements.</p> <p>Perception is that of an obligatory routine.</p>	<p>There is a lack of connection between the different parts and movements during part majority of the routine.</p>	<p>The routine lack's structure and seems to be a series of unrelated actions.</p>
<b>Pool Coverage - Pool Pattern</b>	<p>Constant flowing action, covering the pool in different directions.</p> <p>Travel maintained in Elements and during creative pattern changes.</p>	<p>All areas of the pool are covered.</p> <p>Generally good flow. Effective use of space, highlights are well placed.</p>	<p>Some areas of the pool may be missed.</p> <p>Standard use of the space, some actions may be poorly placed.</p>	<p>Pool coverage misses several areas or is limited to one side of the pool.</p> <p>No variety in patterns and pattern changes.</p>	<p>Pool coverage is unbalanced as the flow is interrupted frequently during the routine.</p> <p>Athletes stay in one pattern for an extended period.</p>	<p>Pool coverage is very limited.</p> <p>Patterns and pattern changes are few and basic.</p>	<p>Little (if any) pool coverage.</p> <p>Difficult to determine patterns and pattern changes.</p>
<b>Musicality</b>	<p>The (structure of the) music plays a central role in the choreography.</p> <p>The combination of movements and music creates a oneness of expression. Music enhances the sensation of the movements.</p> <p>Solo/Acrobaties: Highlights are perfectly match with the music creating a special effect.</p>	<p>The nature and demands of the music are translated into movements.</p> <p>The character of the music is portrait in the water, exploiting most opportunities the music provides.</p> <p>Solo/Acrobaties: Actions match the music.</p>	<p>In general, the athlete's movements match the music.</p> <p>Some opportunities provided by the music are not used in the choreography.</p> <p>Solo/Acrobaties: Few and small mismatches of the action with the music.</p>	<p>Most actions fit the music.</p> <p>Mainly use of the obvious rhythm or melody. Some attempt to project mood or theme.</p> <p>Solo/Acrobaties: Several small or one of obvious mismatch of actions with the music.</p>	<p>Some actions fit the music.</p> <p>The character of the music is not captured by the movements.</p> <p>Solo/Acrobaties: Several obvious mismatches of actions with the music.</p>	<p>Music is mainly used as background to synchronize the movements.</p> <p>Simple use of rhythm results in monotonous pace of movements.</p> <p>Solo/Acrobaties: Major errors in synchronizing actions with the music.</p>	<p>Music is mostly ignored by the athletes.</p> <p>Any music could be used.</p>

	<b>9 - 10 Excellent/Perfect Bonus</b>	<b>8-8.75 Very Good Bonus</b>	<b>7-7.75 Good Standard</b>	<b>6 - 6.75 Competent Deductions</b>	<b>5 - 5.75 Satisfactory Deductions</b>	<b>4 - 4.75 Deficient Deductions</b>	<b>3.0 Weak Deductions</b>
<b>Performance</b>	Total command throughout routine with use of face and whole body (90-100% of the routine). Flawless. Outstanding charisma. Routine appears effortless.	Well accomplished total command during routine with use of face and whole body (80% of the routine). Minor breaks in total command. Majority of the routine is performed effortlessly.	Achieved total command and use of face/body (70% of the routine) but may lack physical and/or emotional energy to stay connected for entire routine.	Attempts command (60% of the routine) but lacks physical and/or emotional energy to stay connected for entire routine.	Some attempt at command (50% of the routine). Only able to project for ½ of the routine while the remainder of the routine is inner focused. Lacks physical and/or emotional energy causing the routine to appear insecure.	Majority of the routine is inner focused with small attempts to connect to audience (40% of the routine). Unconfident.	Inward focused for the entire of the routine.
<b>Transitions</b>	<p>Performs a large variety of transitional movements showing constant action of many different body parts performed in an excellent manner.</p> <p>Rich variety: each Transition demonstrates an intricate set of movements.</p> <p>Complexity is performed effortlessly and can be appreciated throughout the routine.</p> <p>Assorted, complex precise surface pattern changes: Clear, accurate, with even spacing throughout.</p>	<p>Logical and interesting connections between Elements. Movements are seamlessly and accurately performed, within fluid pattern changes.</p> <p>Rich variety for the different kinds of Transitions.</p> <p>Shows complexity in most Transitions.</p> <p>Interesting, varied surface pattern changes, accurate and well planned. Few spacing problems.</p>	<p>Logical connection of actions but may lack fluency in a few instants; efficiency and execution level may deteriorate as routine progress.</p> <p>Variety in Transitions although mainly standard actions.</p> <p>Complexity may appear at some points in arm movements, surface flexibility actions or ballet leg combinations.</p> <p>Surface pattern changes are diverse and fluent, but changes are obvious (noticeable time to change patterns) Few spacing problems.</p>	<p>Some Transitions produce a lack of fluidity; execution level is limited by the athlete's abilities.</p> <p>Limited variety with some repetitions.</p> <p>Simple Transitions: no complexity. May show lack of efficiency in propulsions/ sculling techniques in some spots.</p> <p>Surface pattern changes are not precise. Patterns take time to be achieved. Spacing problems more often.</p>	<p>Transitions are not well linked to Elements and often appear as separate actions. Fluency is poor and routines lacks fluidity. Difficulties with execution of the Transitions.</p> <p>Limited variety with mostly repetitions.</p> <p>Simple Transitions with evident problems in execution. Lack of efficiency evident in propulsions/ sculling.</p> <p>Lack of pattern precision and spacing problems in surface pattern changes.</p>	<p>Transitions are mostly breathing/resting sections. No fluency. Mostly, low execution level.</p> <p>Few different Transitions, and mostly basic strokes.</p> <p>Very simple Transitions with large problems in execution. Lack of efficiency in propulsions/ sculling</p> <p>Surface patterns are mostly unclear due to both lack of propulsions ability and control of timing.</p>	<p>Transitions seem to be used to complete regulated routine time. Even the simplest movements show large execution problems.</p> <p>No variety.</p> <p>Very simple Transitions, difficult to identify with large problems in execution.</p> <p>Surface patterns are very unclear and inaccurate.</p>

## **17. TECHNICAL ROUTINES**

### **17.1 GENERAL REQUIREMENTS**

In Olympic Games, Olympic Games Qualifier, World Aquatics Cup, World Aquatics Senior & Junior and Youth World Championships and other World Aquatics competitions as designated, Required Elements are used.

Unless otherwise specified in the description:

1. All required Elements must be executed according to the requirements described in the World Aquatics AS Manual for Judges, Coaches, Technical Controllers and Referees.
2. If one (1) or more athletes omit all or part of an Element or perform an incorrect action in an Element, refer to 2022-2025 World Aquatics Handbook for penalties regarding incorrect or omitted actions.
3. Technical Required Elements #1 - #5 can be performed in any order.
4. Technical Required Elements #1 - #5 - It is required that the Technical Required Elements, the selected degree of difficulty for each Technical Required Element, and the selected order of performance, must be declared and submitted on the Coach Card for the Technical Routine. The Coach Card must be submitted prior to the Competition/Event.
5. Additional Hybrids and the degrees of difficulty for each Hybrid selected, and the order to be performed, must be declared, and submitted on the Coach Card for the Technical Routine. This form must be submitted prior to the Competition/Event.
6. Except for Deck Work, Entry, Hybrid Connected action (Mixed Duet), Acrobatic movement (Team), Pair Acrobatics (Women Duet and Mixed Duet), cadence action (Team) and circle pattern (Team), Technical Required and Free Elements and Transitions are to be performed simultaneously and facing the same direction by all Duet or Team members.
7. Additional movements can be added immediately before and after (breath to breath) Technical Required Elements #1 - #5. Those movements will not add any extra difficulty nor will be considered as the additional Hybrids.
8. Time limits – refer to 2022-2025 World Aquatics Handbook.

#### **Recommendation for all Technical Routines**

For clarity of judgment, it is strongly recommended that Technical Required Elements #1 - #5 are separated by other content.

Declared difficulty (DD) values are subject to adjustment by World Aquatics.

**17.2 TECHNICAL REQUIRED ELEMENTS**
**17.2.1 WOMEN AND MEN SOLO TECHNICAL REQUIRED ELEMENTS**

Element #	Element Version	Women and Men Technical Required Elements	DD
1	A	Thrust Continuous Spin 720°	2.7
	B	Thrust Spinning 360°	2.1
2	A	Combined Spin 1080° – Continuous Spin 1080°	3.0
	B	Combined Spin 720° – Continuous Spin 1080°	2.7
3		Swordfish Straight Leg - Knight	3.2
4	A	Fishtail Half Twist - Continuous Spin 720°	2.9
	B	Fishtail - Continuous Spin 720°	2.6
5	A	Rocket Split Bent Knee Joining 360°	2.4
	B	Rocket Split Bent Knee	2.1



**SOLO Technical Routine Additional Requirements**

**Two (2) additional Hybrids** must be performed. These may be placed anywhere in the routine.

**WOMEN'S AND MEN'S SOLO TECHNICAL REQUIRED ELEMENTS**
**Element 1**
**1A - Thrust Continuous Spin 720°**
**DD - 2.7**

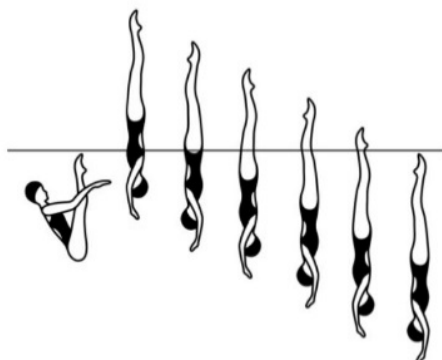
From a **Submerged Back Pike Position**, with the legs perpendicular to the surface, a *Thrust Continuous Spin 720°* (2 rotations) is executed.



			Total
NVT=	31.0	67.0	98
PV =	3.16	6.84	10



## Clarification:

- All movements are executed rapidly.
- BP 11 **Submerged Back Pike Position** is executed with the legs perpendicular to the surface of the water.
- BM 9 *Thrust* allowance: Deviation allowances for the *Thrust* action are unique and allow for the legs to be up to an additional 15° off the vertical line.
- Refer to BM 9 *Thrust*.

**WOMEN AND MEN SOLO TECHNICAL REQUIRED ELEMENTS**
**Element 1**
**1B - Thrust Spinning 360°**
**DD - 2.1**

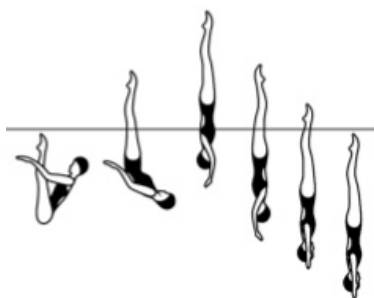
From a **Submerged Back Pike Position**, with the legs perpendicular to the surface, a *Thrust Spinning 360°* (1 rotation) is executed.

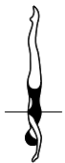

				Total
NVT=	31.0	39.0	0	70
PV =	4.43	5.57	0	10





## Clarification:

- All movements are executed rapidly.
- BP 11 **Submerged Back Pike Position** is executed with the legs perpendicular to the surface of the water.
- BM 9 *Thrust* allowance: Deviation allowances for the *Thrust* action are unique and allow for the legs to be up to an additional 15° off the vertical line.
- Refer to BM 9 *Thrust*.

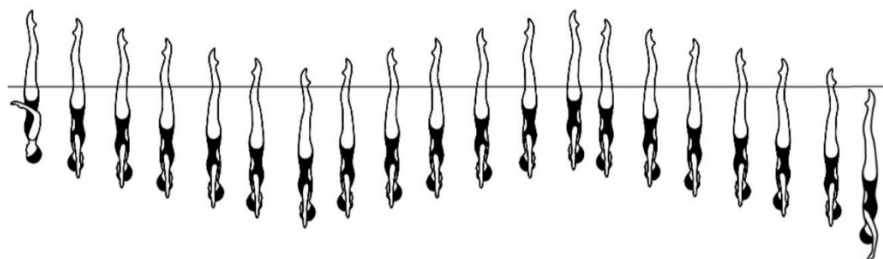
**WOMEN AND MEN SOLO TECHNICAL REQUIRED ELEMENTS**
**Element 2**
**2A – Combined Spin 1080° – Continuous Spin 1080°**
**DD - 3.0**

From a **Vertical Position** a *Combined Spin of 1080°* is executed (3 rotations + 3 rotations). Continuing in the same direction and without a pause a *Continuous Spin 1080°* (3 rotations) is executed.



					Total
NVT=		69.0	49.0		118
PV =		5.85	4.15		10





Clarification:

- BM 13 f) *Continuous Spin* is executed rapidly.
- The height of the starting and ending of BP 6 **Vertical Position** in *Combined Spin* is the same.

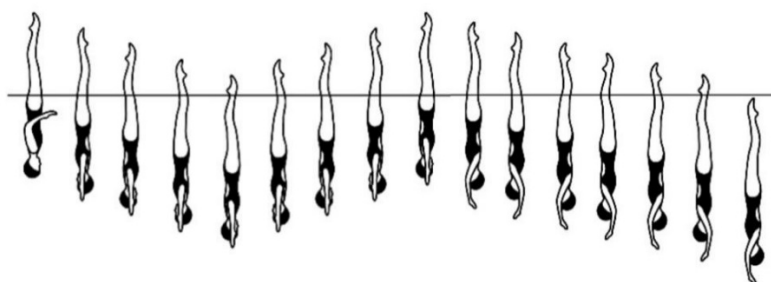
**WOMEN AND MEN SOLO TECHNICAL REQUIRED ELEMENTS**
**Element 2**
**2B – Combined Spin 720° – Continuous Spin 1080°**
**DD - 2.7**

From a **Vertical Position** a *Combined Spin of 720°* is executed (2 rotations + 2 rotations). Continuing in the same direction and without a pause a *Continuous Spin 1080°* (3 rotations) is executed.



					Total
NVT=		50.0		49.0	99
PV =		5.05		4.95	10

Clarification:





- BM 13 f) *Continuous Spin* is executed rapidly.
- The height of the starting and ending of BP 6 **Vertical Position** in *Combined Spin* is the same.

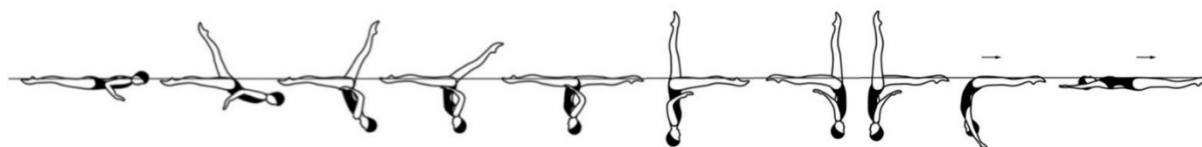

**WOMEN AND MEN SOLO TECHNICAL REQUIRED ELEMENTS**
**Element 3**
**3- Swordfish Straight Leg - Knight**
**DD-3.2**

From a **Front Layout Position**, the back arches as one leg is lifted in a 180° arc over the surface to a **Split Position**. A hip rotation of 180° is executed as the front leg is rapidly raised to assume a **Fishtail Position**. Maintaining the vertical alignment of the body and with accelerating speed, the foot of the horizontal leg is moved in a horizontal arc of 180° at the surface to a **Knight Position** and with continuous motion and continuing in the same direction an additional 180° rotation is executed. The vertical leg is lowered to a **Surface Arch Position** and with continuous motion an *Arch to Back Layout Position* is executed.

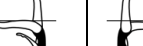

						Total	
NVT=	43.0	16.5	21.0	24.0	18.5	7.0	130
PV =	3.31	1.27	1.62	1.85	1.42	0.54	10



## Clarification:

- The action from BP 16 **Split Position** to BP 8 **Fishtail Position** is executed rapidly. From BP 8 **Fishtail Position** to BP 17 **Knight Position** the horizontal leg moves with accelerating speed at the surface of the water and with continuous acceleration and continuing in the same direction an additional 180° rotation is executed.

**WOMEN AND MEN SOLO TECHNICAL REQUIRED ELEMENTS**
**Element 4**
**4A – Fishtail Half Twist - Continuous Spin 720°**
**DD – 2.9**

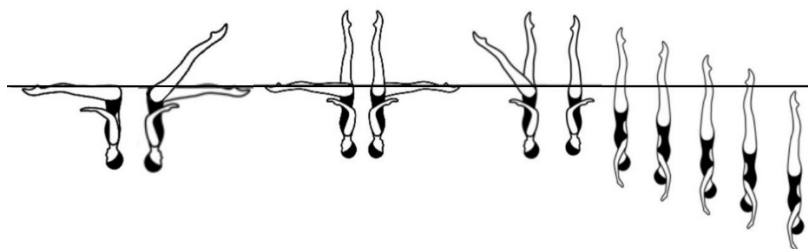
From a **Front Pike Position**, a rotation of 360° is executed as one leg is lifted to a **Fishtail Position**. Continuing in the same direction a *Half Twist* in a **Fishtail Position** is executed. Continuing in the same direction another rotation of 360° is executed, as the horizontal leg is lifted to a **Vertical Position**. Continuing in the same direction, a *Continuous Spin of 720°* (2 rotations) is executed.

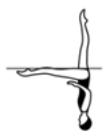
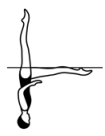

						Total
NVT=		32.0	17.0	26.5	34.0	109.5
PV =		2.92	1.55	2.42	3.11	10





## Clarification:

- All rotations are executed in the same direction.
- From BP 10 **Front Pike Position**, either right or left leg can be lifted.
- The foot of the horizontal leg remains at the surface of the water throughout the rotation of 360° to **Fishtail Position** and the *Half Twist* in **Fishtail Position**.

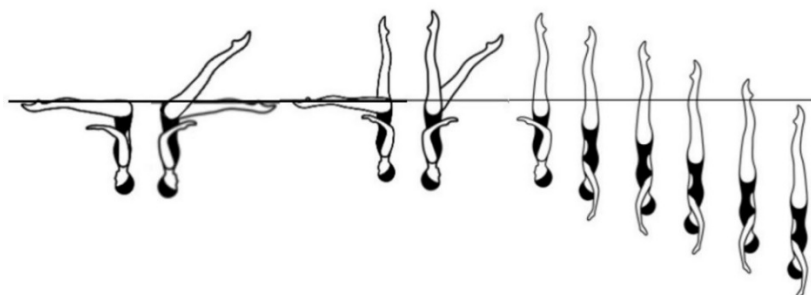
**WOMEN AND MEN SOLO TECHNICAL REQUIRED ELEMENTS**
**Element 4**
**4B - Fishtail - Continuous Spin 720**
**DD - 2.6**

From a **Front Pike Position**, a rotation of 360° is executed as one leg is lifted to a **Fishtail Position**. Continuing in the same direction another rotation of 360° is executed, as the horizontal leg is lifted to a **Vertical Position**. Continuing in the same direction a *Continuous Spin of 720°* (2 rotations) is executed.



				Total
NVT=	32.0	26.5	34.0	92.5
PV =	3.46	2.86	3.68	10





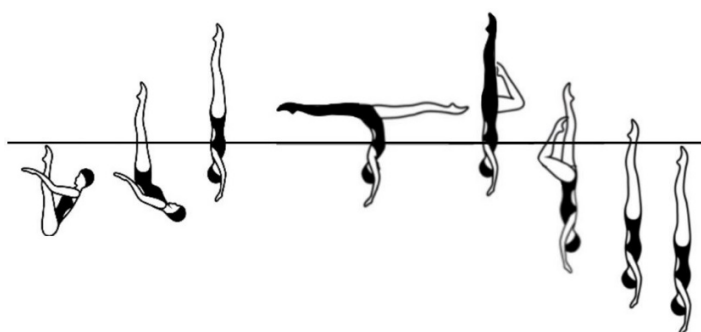

## Clarification:

- All rotations are executed in the same direction.
- From BP 10 **Front Pike Position**, either right or left leg can be lifted.
- The foot of the horizontal leg remains at the surface of the water throughout the rotation of 360° to **Fishtail Position**.

**WOMEN AND MEN SOLO TECHNICAL REQUIRED ELEMENTS**
**Element 5**
**5A – Rocket Split Bent Knee Joining 360°**
**DD - 2.4**

From a **Submerged Back Pike Position**, with the legs perpendicular to the surface, a *Thrust* is executed to a **Vertical Position**. Maintaining maximum height, the legs are split rapidly to assume an **Airborne Split Position**. The back leg is rapidly lifted to vertical as the front leg bends to assume a **Bent Knee Vertical Position**. A rapid *360° Spin* is executed as the bent knee is extended to a **Vertical Position** completed as the ankles reach the surface of the water followed by a *Vertical Descent* at the same tempo as the *Thrust*.



						Total
NVT=	31.0	17.0	13.0	24.0	0	85.0
PV =	3.65	2.00	1.53	2.82	0	10



**Clarification:**

- All movements are executed rapidly.
- BP 11 **Submerged Back Pike Position** is executed with the legs perpendicular to the surface of the water.
- BM 9 *Thrust* allowance: Deviation allowances for the *Thrust* action are unique and allow for the legs to be up to an additional 15° off the vertical line.
- Refer to BM 9 *Thrust*.
- Refer to the \*Rejoin to Vertical Single Leg water level in the Dynamic Height Scale for the differing height standard requirements following a BM 9 *Thrust* airborne move.

**WOMEN AND MEN SOLO TECHNICAL REQUIRED ELEMENTS**
**Element 5**
**5B – Rocket Split Bent Knee**
**DD - 2.1**

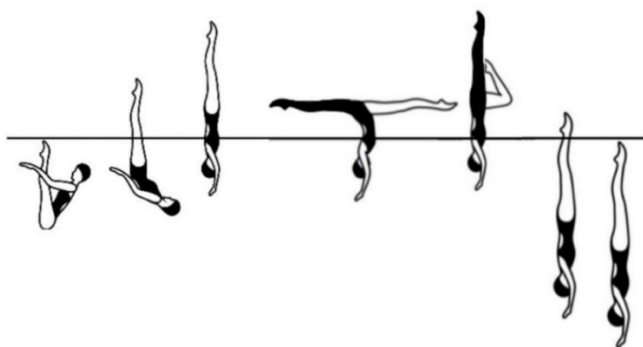
From a **Submerged Back Pike Position**, with the legs perpendicular to the surface, a *Thrust* is executed to a **Vertical Position**. Maintaining maximum height, the legs are split rapidly to assume an **Airborne Split Position**. The back leg is rapidly lifted to vertical and the forward leg bends to assume a **Bent Knee Vertical Position**. A *Vertical Descent* is executed with the bent knee extended to a **Vertical Position** completed as the ankles reach the surface of the water, followed by a *Vertical Descent* at the same tempo as the *Thrust*.

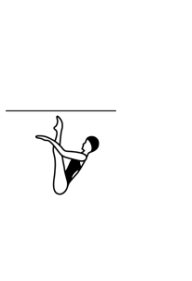
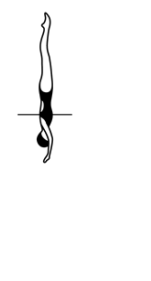
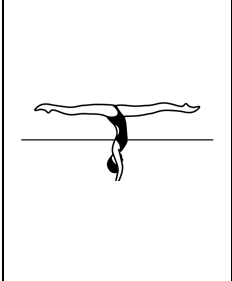

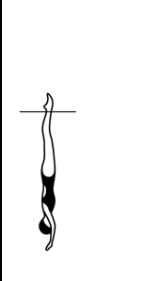
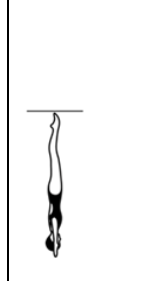
						Total
NVT=	31.0	17.0	13.0	9.0	0	70
PV =	4.43	2.43	1.86	1.29	0	10

## Clarification:

- All movements are executed rapidly.
- BP 11 **Submerged Back Pike Position** is executed with the legs perpendicular to the surface of the water.
- BM 9 *Thrust* allowance: Deviation allowances for the *Thrust* action are unique and allow for the legs to be up to an additional 15° off the vertical line. Refer to BM 9 *Thrust*.
- Refer to the \*Rejoin to Vertical Single Leg water level in the Dynamic Height Scale for the differing height standard requirements following a BM 9 *Thrust* airborne move.

**17.2.2 WOMEN DUET TECHNICAL REQUIRED ELEMENTS**

Element #	Element Version	Women Duet Required Elements	DD
1	A	Walkover Back Closing 360° – Continuous Spin 1080°	3.0
	B	Walkover Back Closing 180° – Continuous Spin 720°	2.5
2	A	Rocket Split Alternating Legs – Spinning 180°	2.8
	B	Rocket Split – Spinning 180°	2.4
3	A	Flamingo Full Twist Hybrid	2.9
	B	Flamingo Half Twist Hybrid	2.6
4	A	Fishtail – Knight - Continuous Spin 1080°	3.2
	B	Fishtail – Knight - Continuous Spin 720°	2.7
5	A	Thrust Bent Knee Twirl Spin 360°	2.3
	B	Thrust - Bent Knee Twirl	2.1





**WOMEN DUET Technical Routine Additional Requirements**

**Two (2) additional Hybrids** and **one (1) Pair Acrobatics** must be performed. These may be placed anywhere in the routine.

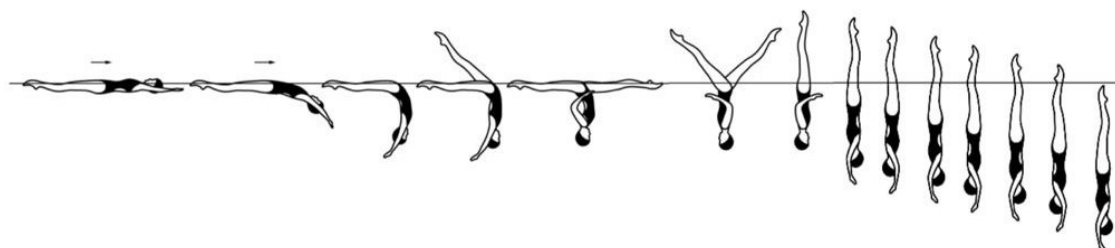
**WOMEN'S DUET TECHNICAL REQUIRED ELEMENTS**
**Element 1**
**1A – Walkover Back Closing 360° – Continuous Spin 1080°**
**DD – 3.0**

From a **Back Layout Position** a *Surface Arch Position* is assumed. One leg is lifted in a 180° arc over the surface to a **Split Position**. A rotation of 360° is executed, as the legs symmetrically close to a **Vertical Position**. Continuing in the same direction a *Continuous Spin of 1080°* (3 rotations) is executed.



						Total
NVT=		12.0	29.0	27.0	49.0	117
PV =		1.03	2.48	2.31	4.19	10





Clarification:

- All rotations are executed in the same direction.
- *BM 13f The Continuous Spin* is executed rapidly.

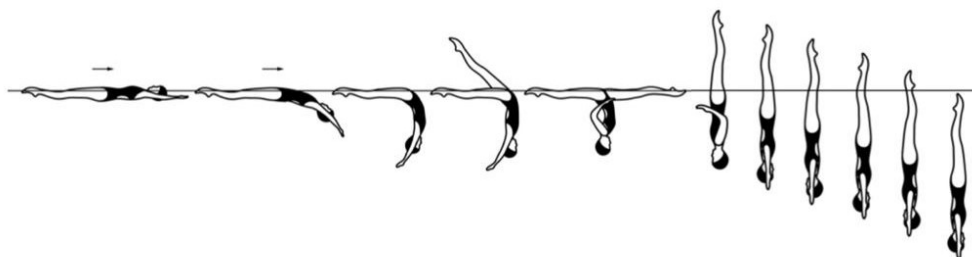
**WOMEN'S DUET TECHNICAL REQUIRED ELEMENTS**
**Element 1**
**1B – Walkover Back Closing 180° – Continuous Spin 720°**
**DD – 2.5**

From a **Back Layout Position** a *Surface Arch Position* is assumed. One leg is lifted in a 180° arc over the surface to a **Split Position**. A rotation of 180° is executed, as the legs symmetrically close to a **Vertical Position**. Continuing in the same direction a *Continuous Spin of 720°* (2 rotations) is executed.



						Total
NVT=		12.0	29.0	17.0	34.0	92
PV =		1.30	3.15	1.85	3.70	10

## Clarification:







- All rotations are executed in the same direction.
- BM 13f *The Continuous Spin* is executed rapidly.

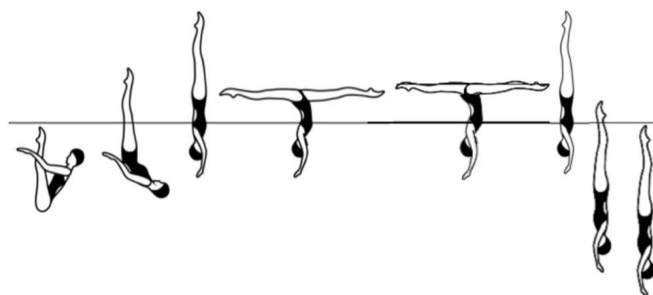

**WOMEN'S DUET TECHNICAL REQUIRED ELEMENTS**
**Element 2**
**2A – Rocket Split Alternating Legs – Spinning 180°**
**DD - 2.8**

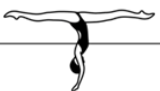
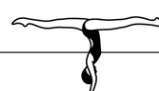
From a **Submerged Back Pike Position**, with the legs perpendicular to the surface, a *Thrust* is executed to a **Vertical Position**. Maintaining maximum height, the legs are split rapidly to assume two (2) alternating **Airborne Split Positions**. The legs rapidly re-join to a **Vertical Position**. A rapid *180° Spin* is executed.



								Total
NVT=		31.0	17.0	22.0	13.0	24.0	0	107
PV =		2.90	1.59	2.06	1.21	2.24	0	10





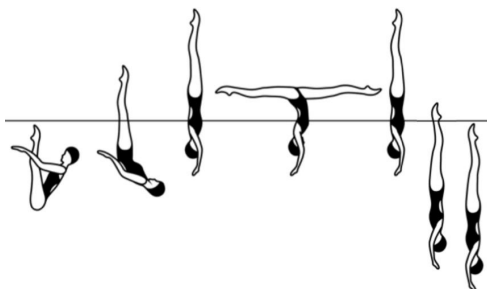

## Clarification:

- All movements are executed rapidly.
- BP 11 **Submerged Back Pike Position** is executed with the legs perpendicular to the surface of the water.
- BM 9 *Thrust* allowance: Deviation allowances for the *Thrust* action are unique and allow for the legs to be up to an additional 15° off the vertical line.
- Refer to BM 9 *Thrust*.
- Refer to the \*Rejoin to Vertical Double Leg water level in the Dynamic Height Scale for the differing height standard requirements following a BM 9 *Thrust* airborne move.

**WOMEN'S DUET TECHNICAL REQUIRED ELEMENTS**
**Element 2**
**2B - Rocket Split – Spinning 180°**
**DD - 2.4**

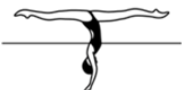
From a **Submerged Back Pike Position**, with the legs perpendicular to the surface, a *Thrust* is executed to a **Vertical Position**. Maintaining maximum height, the legs are split rapidly to assume an **Airborne Split Position**. The legs rapidly re-join to **Vertical Position**. A rapid *180° Spin* is executed.



							Total
NVT=	31.0	17.0	13.0	24.0	0	85	
PV =	3.65	2.00	1.53	2.82	0	10	





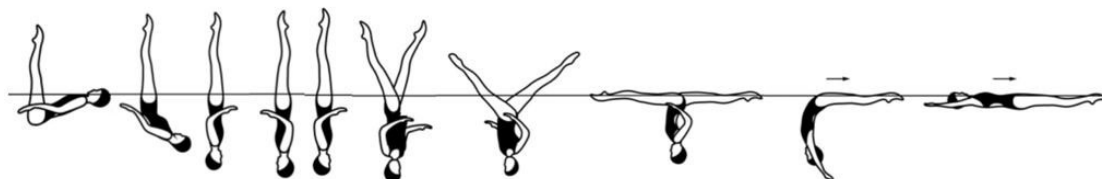

## Clarification:

- All movements are executed rapidly.
- BP 11 **Submerged Back Pike Position** is executed with the legs perpendicular to the surface of the water.
- BM 9 *Thrust* allowance: Deviation allowances for the *Thrust* action are unique and allow for the legs to be up to an additional 15° off the vertical line.
- Refer to BM 9 *Thrust*.
- Refer to the \*Rejoin to Vertical Double Leg water level in the Dynamic Height Scale for the differing height standard requirements following a BM 9 *Thrust* airborne move.

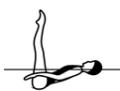
**WOMEN'S DUET TECHNICAL REQUIRED ELEMENTS**
**Element 3**
**3A- Flamingo Full Twist Hybrid**
**DD – 2.9**

From a **Surface Ballet Leg Double Position**, maintaining the vertical position of the legs, the hips are lifted as the trunk is unrolled to a **Vertical Position**. A *Full Twist* is executed. Continuing in the same direction and without a pause an additional rotation of 180° is executed as the legs are symmetrically opened to assume a **Split Position**. A *Walkout Front* is executed.



							Total
NVT=	28.0	32.0	20.0	23.0	7.0		110
PV =	2.55	2.91	1.82	2.09	0.64		10



Clarification:

- All rotations are executed in the same direction.
- From BP 6 **Vertical Position**, either leg can be the forward leg to assume BP 16 **Split Position**.

**WOMEN'S DUET TECHNICAL REQUIRED ELEMENTS**
**Element 3**
**3B- Flamingo Half Twist Hybrid**
**DD - 2.6**

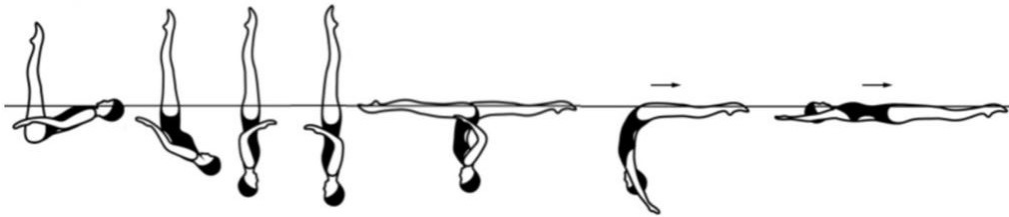
From a **Surface Ballet Leg Double Position**, maintaining the vertical position of the legs, the hips are lifted as the trunk is unrolled to a **Vertical Position**. A *Half Twist* is executed. Without a pause the legs open symmetrically to a **Split Position**. A *Walkout Front* is executed.

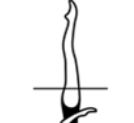
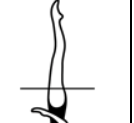

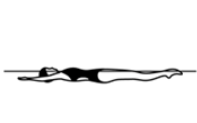
						Total
NVT=	28.0	21.0	17.0	23.0	7.0	96
PV =	2.92	2.19	1.77	2.40	0.73	10





Clarification:

- From BP 6 **Vertical Position**, either leg can be the forward leg to assume BP 16 **Split Position**.

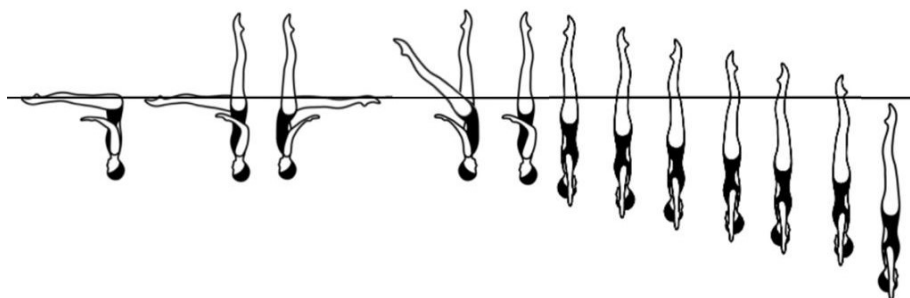
**WOMEN'S DUET TECHNICAL REQUIRED ELEMENTS**
**Element 4**
**4A - Fishtail – Knight - Continuous Spin 1080°**
**DD - 3.2**

**A** - From a **Front Pike Position** one leg is lifted to a **Fishtail Position**. The horizontal leg is rapidly lifted through an arc of 180° to assume a **Knight Position**. A rapid *Full Twist* is executed as the horizontal leg is lifted to a **Vertical Position**. Continuing in the same direction a *Continuous Spin 1080° (3 rotations)* is executed.

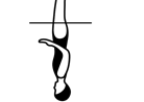

						Total
NVT=	14.5	26.0	36.0	49.0	125.5	
PV =	1.16	2.07	2.87	3.90	10	





Clarification:

- All movements are executed rapidly from the BP 8 **Fishtail Position**.

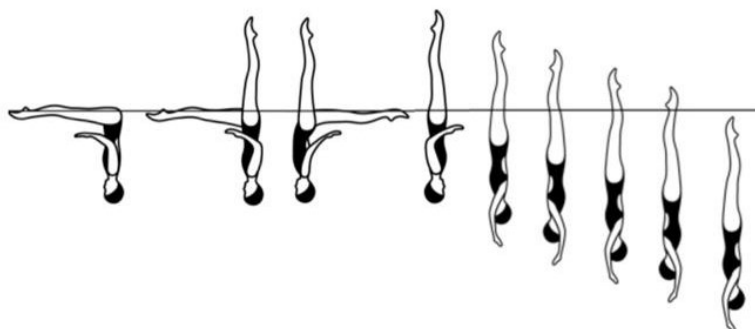
**WOMEN'S DUET TECHNICAL REQUIRED ELEMENTS**
**Element 4**
**4B - Fishtail – Knight - Continuous Spin 720°**
**DD – 2.7**

From a **Front Pike Position** one leg is lifted to a **Fishtail Position**. The horizontal leg is rapidly lifted through an arc of 180° to assume a **Knight Position**. A rapid *Half Twist* is executed as the horizontal leg is lifted to a **Vertical Position**. Continuing in the same direction a *Continuous Spin 720° (2 rotations)* is executed.

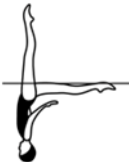

					Total
NVT=	14.5	26.0	28.5	34.0	103
PV =	1.41	2.52	2.77	3.30	10





Clarification:

- All movements are executed rapidly from the BP 8 **Fishtail Position**.

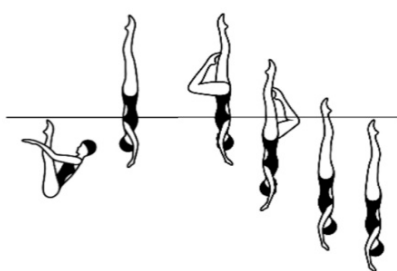
**WOMEN DUET TECHNICAL REQUIRED ELEMENTS**
**Element 5**
**5A – Thrust Bent Knee Twirl Spin 360°**
**DD - 2.3**

From a **Submerged Back Pike Position**, with the legs perpendicular to the surface, a *Thrust* is executed to a **Vertical Position**. One leg is lowered to a **Bent Knee Vertical Position** as a *Twirl* is executed. Continuing in the same direction and without a pause a rapid *360° Spin* is executed as the bent knee is extended to join the vertical leg in a **Vertical Position** completed as the ankles reach the surface of the water, followed by a *Vertical Descent* at the same tempo as the *Thrust*.



					Total
NVT=	31.0	26.0	24.0	0	81
PV =	3.83	3.21	2.96	0	10





## Clarification:

- All movements are executed rapidly.
- BP 11 **Submerged Back Pike Position** is executed with the legs perpendicular to the surface of the water.
- BM 9 *Thrust* allowance: deviation allowances for the *Thrust* action are unique and allow for the legs to be up to an additional 15° off the vertical line.
- Refer to BM 9 *Thrust*.

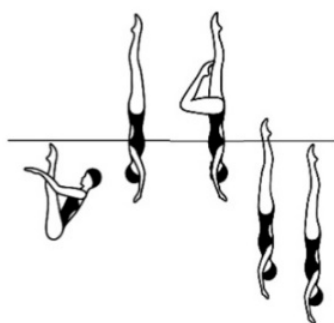
**WOMEN DUET TECHNICAL REQUIRED ELEMENTS**
**Element 5**
**5B - Thrust - Bent Knee Twirl**
**DD 2.1**

From a **Submerged Back Pike Position**, with the legs perpendicular to the surface, a *Thrust* is executed to a **Vertical Position**. One leg is lowered to a **Bent Knee Vertical Position** as a *Twirl* is executed. Without a pause a *Vertical Descent* is executed as the bent knee is extended to join the vertical leg in a **Vertical Position** completed as the ankles reach the surface of the water, followed by a *Vertical Descent* at the same tempo as the *Thrust*.



						Total
NVT =		31.0	26.0	9.0	0	66
PV =		4.70	3.94	1.36	0	10

## Clarification:

- All movements are executed rapidly.
- BP 11 **Submerged Back Pike Position** is executed with the legs perpendicular to the surface of the water
- BM 9 *Thrust* allowance: deviation allowances for the *Thrust* action are unique and allow for the legs to be up to an additional 15° off the vertical line.
- Refer to BM 9 *Thrust*.



**17.2.3 MIXED DUET TECHNICAL REQUIRED ELEMENTS**

Element #	Element Version	Mixed Duet Required Elements	DD
1	A	Rocket Split Twirl Spin 180°	2.7
	B	Rocket Split Twirl	2.5
2	A	Front Pike – Vertical 360° Rotation - Full Twist to Bent Knee - Continuous Spin 720°	2.4
	B	Front Pike – Vertical 180° Rotation – 1/2 Twist to Bent Knee - Continuous Spin 720°	2.2
3		London Hybrid	3.3
4	A	Nova Hybrid – Half Twist – Continuous Spin 1080°	3.0
	B	Nova Hybrid –Continuous Spin 1080°	2.6
5	A	Thrust Fishtail Hybrid Bent Knee to Vertical Spinning 180°	2.4
	B	Thrust Fishtail Helicopter Spinning 180°	2.1





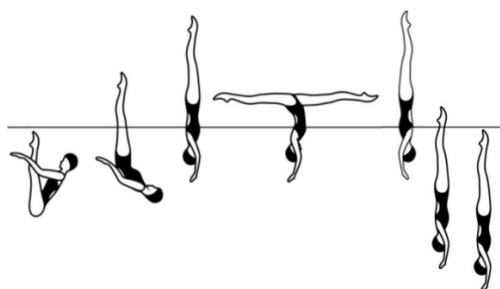

**MIXED DUET Technical Routine Additional Requirements**

**Two (2) additional Hybrids**, one of which must include a Hybrid connection, and **one (1) Pair Acrobatics** must be performed. These may be placed anywhere in the routine.

**MIXED DUET TECHNICAL REQUIRED ELEMENTS**
**Element 1**
**1A – Rocket Split Twirl Spin 180°**
**DD – 2.7**

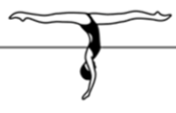
From a **Submerged Back Pike Position**, with the legs perpendicular to the surface, a *Thrust* is executed to a **Vertical Position**. Maintaining maximum height, the legs are split rapidly to assume an **Airborne Split Position**. A *Twirl* is executed, as the legs symmetrically close to a **Vertical Position**. Continuing in the same direction a rapid *180° Spin* is executed.



							Total
NVT =	31.0	17.0	30.0	24.0	0	0	102
PV =	3.04	1.67	2.94	2.35	0	0	10

## Clarification:

- All movements are executed rapidly.
- BP 11 **Submerged Back Pike Position** is executed with the legs perpendicular to the surface of the water.
- BM 9 *Thrust* allowance: deviation allowances for the *Thrust* action are unique and allow for the legs to be up to an additional 15° off the vertical line.
- Refer to BM 9 *Thrust*.
- Refer to the \*Rejoin to Vertical Double Leg water level in the Dynamic Height Scale (see CHAPTER II. - 9.5) for the differing height standard requirements following a BM 9 *Thrust* airborne move.

**MIXED DUET TECHNICAL REQUIRED ELEMENTS**
**Element 1**
**1B – Rocket Split Twirl**
**DD – 2.5**

From a **Submerged Back Pike Position**, with the legs perpendicular to the surface, a *Thrust* is executed to a **Vertical Position**. Maintaining maximum height, the legs are split rapidly to assume an **Airborne Split Position**. A *Twirl* is executed, as the legs symmetrically close to a **Vertical Position**. A *Vertical Descent* is executed at the same tempo as the *Thrust*.

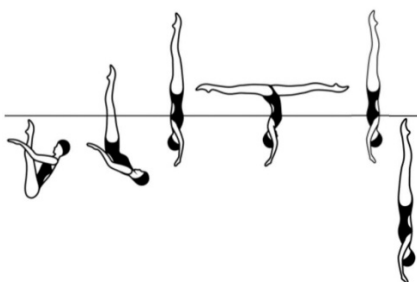

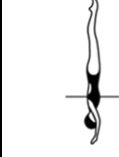
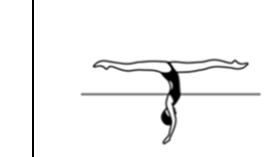
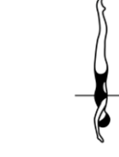
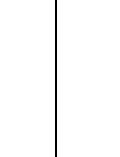
					Total
NVT=	31.0	17.0	30.0	13.0	91
PV =	3.41	1.87	3.30	1.43	10





## Clarification:

- All movements are executed rapidly.
- BP 11 **Submerged Back Pike Position** is executed with the legs perpendicular to the surface of the water.
- BM 9 *Thrust* allowance: Deviation allowances for the *Thrust* action are unique and allow for the legs to be up to an additional 15° off the vertical line
- Refer to BM 9 *Thrust*.
- Refer to the \*Rejoin to Vertical Double Leg water level in the Dynamic Height Scale for the differing height standard requirements following a BM 9 *Thrust* airborne move.

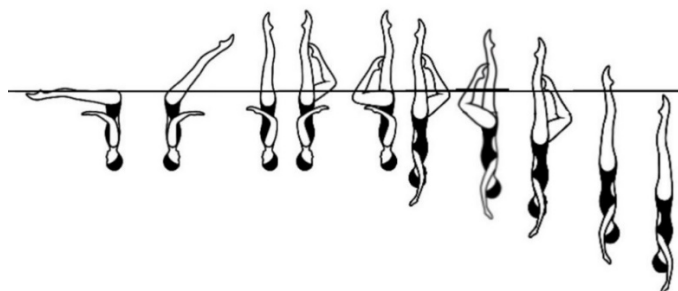
**MIXED DUET TECHNICAL REQUIRED ELEMENTS**
**Element 2**
**2A - Front Pike – Vertical 360° Rotation - Full Twist to Bent Knee - Continuous Spin 720°  
 DD 2.4**

From a **Front Pike Position**, the legs are lifted to **Vertical Position** as a rotation of 360° is executed. Continuing in the same direction a *Full Twist* is executed as one leg is lowered to a **Bent Knee Vertical Position**. Continuing in the same direction a *Continuous Spin 720°* (2 rotations) is executed as the bent knee is extended to join the vertical leg to a **Vertical Position** completed as the ankles reach the surface of the water and continues through submergence.



					Total
NVT =	37.0	24.5	24.0	0	85.5
PV =	4.33	2.87	2.81	0	10





Clarification:

- All rotations are executed in the same direction.
- BM 13f *The Continuous Spin* is executed rapidly.

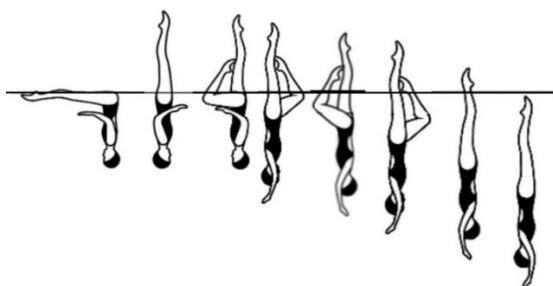
**MIXED DUET TECHNICAL REQUIRED ELEMENTS**
**Element 2**
**2B - Front Pike – Vertical 180° Rotation – 1/2 Twist to Bent Knee – Continuous Spin 720°**
**DD 2.2**

From a **Front Pike Position**, the legs are lifted to **Vertical Position** as a rotation of 180° is executed. Continuing in the same direction, a *Half Twist* is executed as one leg is lowered to a **Bent Knee Vertical Position**. Continuing in the same direction a *Continuous Spin 720°* (2 rotations) is executed as the bent knee is extended to join the vertical leg to a **Vertical Position** completed as the ankles reach the surface of the water and continues through submergence.



					Total
NVT=	33.0	17.5	24.0	0	74.5
PV =	4.43	2.35	3.22	0	10









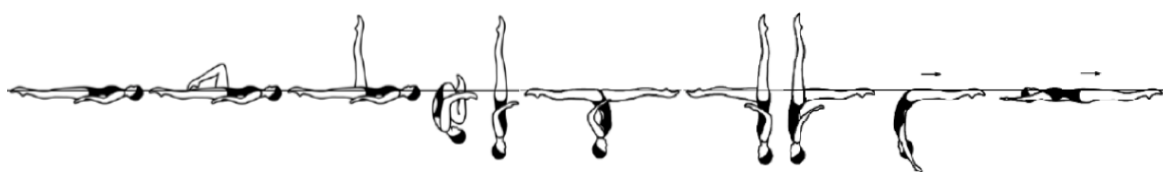

Clarification:

- All rotations are executed in the same direction.
- BM 13f *The Continuous Spin* is executed rapidly.

**MIXED DUET TECHNICAL REQUIRED ELEMENTS**
**Element 3**
**3 – London Hybrid**
**DD 3.3**

A *Ballet Leg* is assumed followed by a partial Somersault Back Tuck as both legs are drawn into a **Tuck Position**, until the shins are perpendicular to the surface. The trunk unrolls rapidly as the legs are rapidly straightened to assume a **Vertical Position** midway between the former vertical line through the hips and the former vertical line through the head and the shins. The legs are symmetrically lowered to a **Split Position**, and without a pause a rapid hip rotation of 180° is executed as the front leg is raised to assume a **Fishtail Position**. The horizontal leg is rapidly lifted through an arc of 180° to assume a **Knight Position**. The vertical leg is lowered to assume a **Surface Arch Position**, and with continuous motion an *Arch to Back Layout Position* is executed.



										Total
NVT=	10.5	11.0	6.0	20.0	17.0	16.5	26.0	18.5	7.0	132.5
PV=	0.79	0.83	0.45	1.51	1.28	1.25	1.96	1.40	0.53	10





## Clarification:

- The inverted BP 9 **Tuck Position** to BP 6 **Vertical Position**, the BP 16 **Split Position** to BP 8 **Fishtail Position**, and the BP 8 **Fishtail Position** to assume BP 17 **Knight Position** are executed rapidly.
- A *Ballet Leg* is assumed as per the BM 1, stationary.

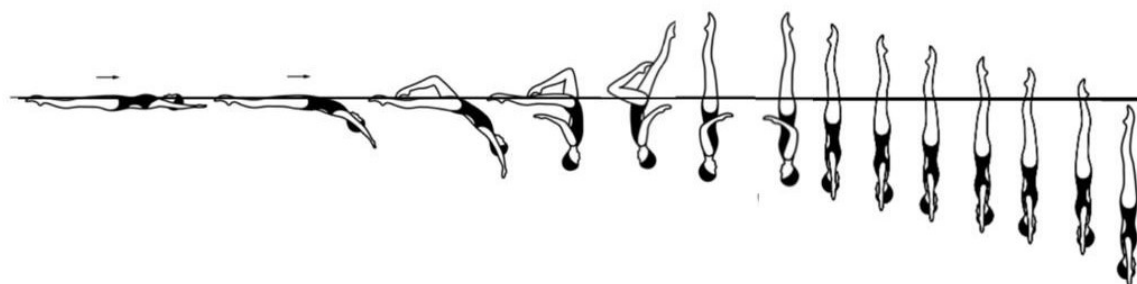
**MIXED DUET TECHNICAL REQUIRED ELEMENTS**
**Element 4**
**4A - Nova Hybrid – Half Twist – Continuous Spin 1080°**
**DD – 3.0**

From a **Back Layout Position** a *Bent Knee Surface Arch Position* is assumed. The legs are lifted and join simultaneously to a **Vertical Position**, as a *Full Twist* is executed. Continuing in the same direction and without a pause a *Half Twist* is executed. Continuing in the same direction and without a pause a *Continuous Spin 1080°* (3 rotations) is executed.



						Total
NVT =		17.5	27.5	21.0	49.0	115
PV =		1.52	2.39	1.83	4.26	10





Clarification:

- All rotations are executed in the same direction.
- BM 13f *The Continuous Spin* is executed rapidly.

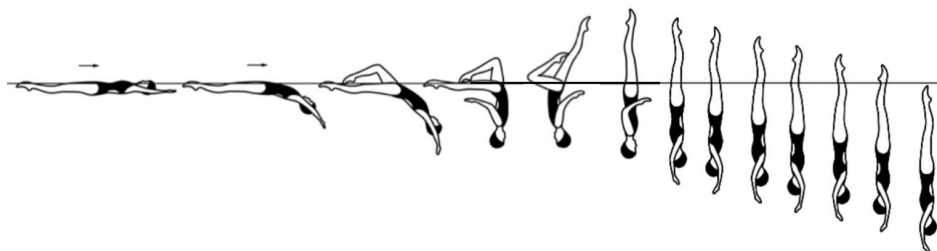
**MIXED DUET TECHNICAL REQUIRED ELEMENTS**
**Element 4**
**4B - Nova Hybrid –Continuous Spin 1080°**
**DD – 2.6**

From a **Back Layout Position** a *Bent Knee Surface Arch Position* is assumed. The legs are lifted and join simultaneously to a **Vertical Position**, as a *Full Twist* is executed. Continuing in the same direction and without a pause a *Continuous Spin 1080°* (3 rotations) is executed.



				Total
				
NVT=	17.5	27.5	49.0	94
PV =	1.86	2.93	5.21	10

## Clarification:



- All rotations are executed in the same direction.
- BM 13f *The Continuous Spin* is executed rapidly.

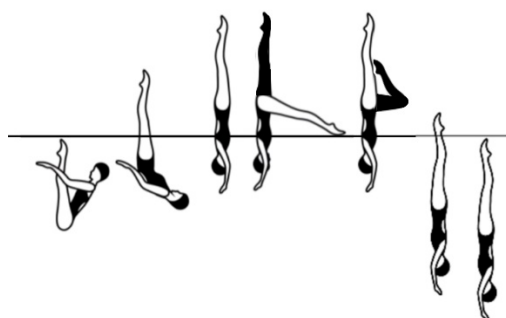

**MIXED DUET TECHNICAL REQUIRED ELEMENTS**
**Element 5**
**5A -Thrust Fishtail Hybrid Bent Knee to Vertical Spinning 180°**
**DD - 2.4**

From a **Submerged Back Pike Position**, with the legs perpendicular to the surface, a *Thrust* is executed to a **Vertical Position**. With no loss of height, one leg is rapidly lowered to an airborne position midway between a **Side Fishtail Position** and a **Fishtail Position** with the foot of the lowered leg touching the surface of the water. The horizontal leg is rapidly lifted as the vertical leg is rapidly lowered to assume a **Bent Knee Vertical Position**. A rapid *180° Spin* is executed, as the bent knee is extended to join the vertical leg in a **Vertical Position** completed as the ankles reach the surface of the water followed by a *Vertical Descent*.

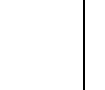
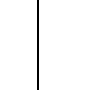

						Total
NVT=	31.0	18.5	17.0	18.0	0	84.5
PV =	3.67	2.19	2.01	2.13	0	10

## Clarification:

- All movements are executed rapidly.
- BP 11 **Submerged Back Pike Position** is executed with the legs perpendicular to the surface of the water.
- BM 9 *Thrust* allowance: Deviation allowances for the *Thrust* action are unique and allow for the legs to be up to an additional 15° off the vertical line.
- Refer to BM 9 *Thrust*.
- Refer to the \*Rejoin to Vertical Single Leg water level in the Dynamic Height Scale for the differing height standard requirements from BP 8 **Fishtail Position** to BP 14c **Bent Knee Vertical Position**.

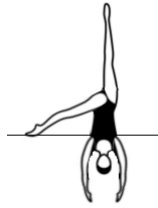



**Fishtail Hybrid Airborne Position**

One leg is rapidly lowered to an airborne position midway between a **Side Fishtail Position** and a **Fishtail Position** with the foot of the lowered leg touching the surface of the water. Body is extended in a **Vertical Position** and hip joints must be on a horizontal line.

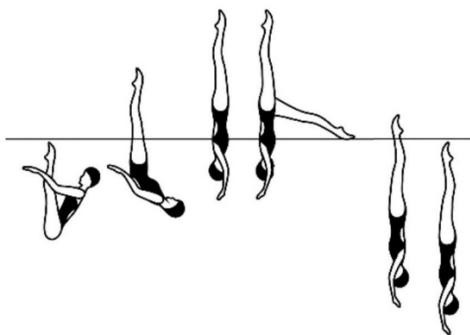
**MIXED DUET TECHNICAL REQUIRED ELEMENTS**
**Element 5**
**5B - Thrust Fishtail Helicopter Spinning 180°**
**DD - 2.1**

From a **Submerged Back Pike Position**, with the legs perpendicular to the surface, a *Thrust* is executed to a **Vertical Position** and with no loss of height one leg is rapidly lowered to an airborne **Fishtail Position**. A rapid *Helicopter Rotation Spinning 180°* is executed with the horizontal leg lifted to a **Vertical Position** during the rotation and is completed as the ankles reach the surface of the water followed by a *Vertical Descent*.



					Total
NVT=	31.0	18.5	17.5	0	67
PV =	4.63	2.76	2.61	0	10

## Clarification:

- All movements are executed rapidly.
- BP 11 **Submerged Back Pike Position** is executed with the legs perpendicular to the surface of the water.
- BM 9 *Thrust* allowance: Deviation allowances for the *Thrust* action are unique and allow for the legs to be up to an additional 15° off the vertical line.
- Refer to BM 9 *Thrust*.

**17.2.4 TEAM TECHNICAL REQUIRED ELEMENTS**

Element #	Element Version	Team Technical Required Elements	DD
1	A	Flying Fish Hybrid Spinning 180°	2.5
	B	Flying Fish Hybrid	2.3
2	A	Vertical - Full Twist to Bent Knee - Full Twist to Vertical – Open 180° - Walkout	2.6
	B	Vertical - Half Twist to Bent Knee - Half Twist to Vertical – Split - Walkout	2.3
3	A	Two Fouetté Rotations – Vertical – Continuous Spin 720°	2.6
	B	Two Fouetté Rotations – Vertical – Spinning 360°	2.3
4		Butterfly Hybrid	2.9
5	A	Rocket Split Bent Knee Twirl Hybrid	2.4
	B	Rocket Split Bent Knee Hybrid	2.1





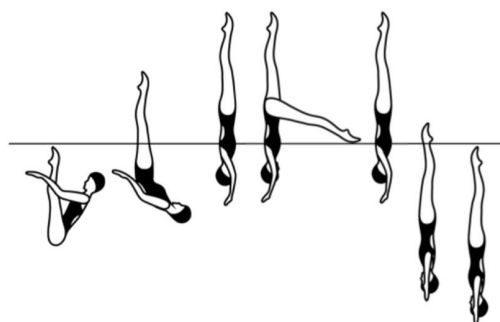

**TEAM Technical Routine Additional Requirements**

- **Three (3) additional Hybrids**, one of which must include a **cadence action**, and one (1) **acrobatic movement** must be **performed by all team members**. These may be placed anywhere in the routine. The DD for the acrobatic movement must not be less than 2.0 nor exceed 2.65 (in the Appendix VII).
- **Cadence Action**: Identical movement(s) performed sequentially, one by one, by all team members. When more than one cadence action is performed, they must be consecutive and not separated by other optional or required Elements. A second cadence action may begin before the first cadence action is completed by all team members, but each team member must do the action of each cadence.
- **Acrobatic movements**: A general term for jumps, throws, lifts, stacks, platforms, etc., which are performed as spectacular gymnastic feats and/or risky actions and are mostly achieved with assistance from other athlete(s). An acrobatic movement is considered when it starts and ends once all team members are in the water.
- A routine may contain a maximum of **one (1) circle pattern**.
- The direction of **propulsion** may vary if all athletes are facing the same direction.
- Variations in propulsion and direction facing are permitted only during underwater pattern changes, underwater actions, and making and finishing a circle.

**TEAM TECHNICAL REQUIRED ELEMENTS**
**Element 1**
**1A – Flying Fish Hybrid Spinning 180°**
**DD – 2.5**

From a **Submerged Back Pike Position** with the legs perpendicular to the surface, a *Thrust* is executed to a **Vertical Position** and with no loss of height one leg is rapidly lowered to an airborne **Fishtail Position**. Without a pause the horizontal leg is rapidly lifted to a **Vertical Position**, followed by a rapid *180° Spin*.



						Total
NVT=	31.0	18.5	14.0	24.0	0	87.5
PV =	3.54	2.11	1.60	2.74	0	10





## Clarification:

- All movements are executed rapidly.
- BP 11 **Submerged Back Pike Position** is executed with the legs perpendicular to the surface of the water.
- BM 9 *Thrust* allowance: Deviation allowances for the *Thrust* action are unique and allow for the legs to be up to an additional 15° off the vertical line.
- Refer to BM 9 *Thrust*.
- Refer to the \*Rejoin to Vertical Double Leg water level in the Dynamic Height Scale for the differing height standard requirements following a BM 9 *Thrust* airborne move.

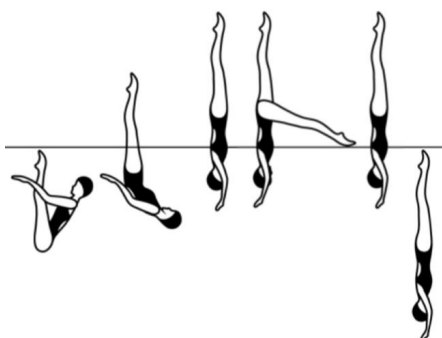
**TEAM TECHNICAL REQUIRED ELEMENTS**
**Element 1**
**1B – Flying Fish Hybrid**
**DD – 2.3**

From a **Submerged Back Pike Position** with the legs perpendicular to the surface, a *Thrust* is executed to a **Vertical Position** and with no loss of height one leg is rapidly lowered to an airborne **Fishtail Position**. Without a pause the horizontal leg is rapidly lifted to a **Vertical Position** followed by a *Vertical Descent*.



					Total
NVT=	31.0	18.5	14.0	13.0	76.5
PV =	4.05	2.42	1.83	1.70	10





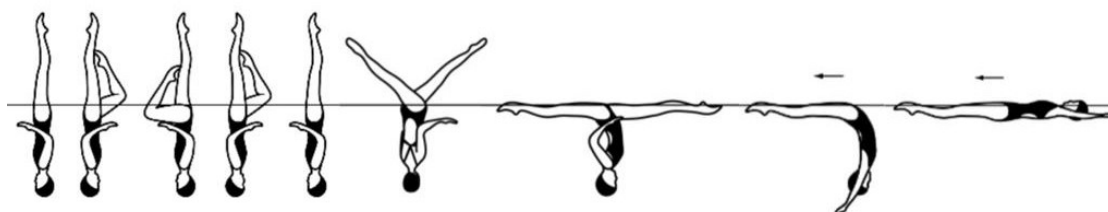

## Clarification:

- All movements are executed rapidly.
- BP 11 **Submerged Back Pike Position** is executed with the legs perpendicular to the surface of the water.
- BM 9 *Thrust* allowance: Deviation allowances for the *Thrust* action are unique and allow for the legs to be up to an additional 15° off the vertical line.
- Refer to BM 9 *Thrust*.
- Refer to the \*Rejoin to Vertical Double Leg water level in the Dynamic Height Scale for the differing height standard requirements following a BM 9 *Thrust* airborne move.

**TEAM TECHNICAL REQUIRED ELEMENTS**
**Element 2**
**2A - Vertical - Full Twist to Bent Knee - Full Twist to Vertical – Open 180° - Walkout DD - 2.6**

Starting in a **Vertical Position**, a *Full Twist* is executed as one leg is lowered to a **Bent Knee Vertical Position**. Continuing in the same direction another *Full Twist* is executed, as the bent knee is extended to a **Vertical Position**. Continuing in the same direction a *Half Twist* is executed as the legs are symmetrically lowered to a **Split Position**. A *Walkout Front* is executed.



						Total
NVT=	24.5	22.0	20.0	23.0	7.0	96.5
PV =	2.54	2.28	2.07	2.38	0.73	10







Clarification:

- All rotations are executed in the same direction.

**TEAM TECHNICAL REQUIRED ELEMENTS**
**Element 2**
**2B - Vertical - Half Twist to Bent Knee - Half Twist to Vertical – Split – Walkout DD - 2.3**

Starting in a **Vertical Position**, a *Half Twist* is executed as one leg is lowered to a **Bent Knee Vertical Position**. Continuing in the same direction another *Half Twist* is executed, as the bent knee is extended to a **Vertical Position**. The legs are symmetrically lowered to a **Split Position**. A *Walkout Front* is executed.



						Total
NVT=	17.5	16.5	17.0	23.0	7.0	81
PV =	2.16	2.04	2.10	2.84	0.86	10

Clarification:







- All rotations are executed in the same direction.

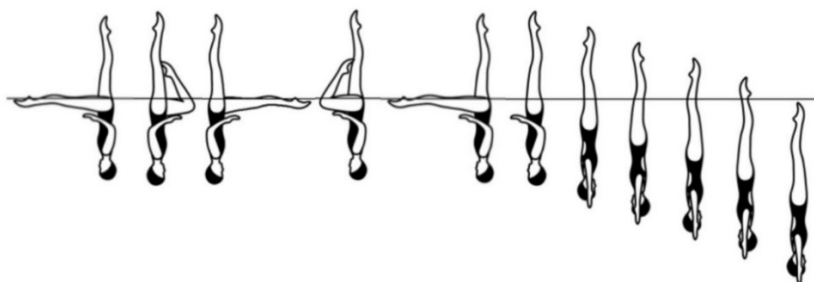

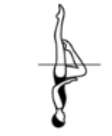
**TEAM TECHNICAL REQUIRED ELEMENTS**
**Element 3**
**3A – Two Fouetté Rotations – Vertical – Continuous Spin 720°**
**DD – 2.6**

From a **Fishtail Position**, 2 *Fouetté rotations* (180°+180°) are executed. The horizontal leg is rapidly lifted to a **Vertical Position**. Continuing in the same direction a *Continuous Spin of 720°* (two (2) rotations) is executed.



	 	 			Total
NVT=	19.0	19.0	20.5	34.0	92.5
PV =	2.05	2.05	2.22	3.68	10





## Clarification:

- All rotations are executed in the same direction.
- Refer to BM 18 *Fouetté Rotation*.
- In *Fouetté Rotation*, either leg may be used.
- A rotation towards the vertical leg means that a right horizontal leg start requires the left shoulder back for the initiation of the 180° rotation. Conversely, a left horizontal leg start requires the right shoulder back for the initiation of the 180° rotation.

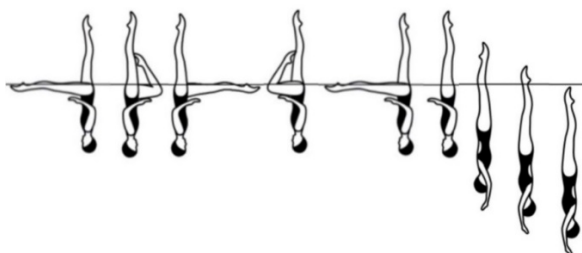
**TEAM TECHNICAL REQUIRED ELEMENTS**
**Element 3**
**3B – Two Fouetté Rotations – Vertical –Spinning 360°**
**DD – 2.3**

From a **Fishtail Position**, 2 *Fouetté* rotations (180°+180°) are executed. The horizontal leg is rapidly lifted to a **Vertical Position**. Continuing in the same direction, a rapid *Spinning* 360° (one (1) rotation) is executed.



					Total
NVT=	19.0	19.0	20.5	19.0	77.5
PV =	2.45	2.45	2.65	2.45	10







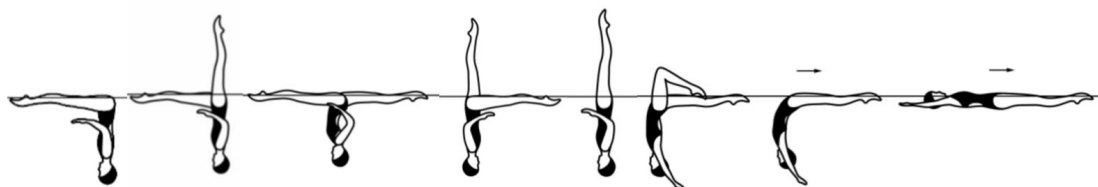

## Clarification:

- All rotations are executed in the same direction.
- Refer to BM 18 *Fouetté Rotation*.
- In *Fouetté Rotation*, either leg may be used.
- A rotation towards the vertical leg means that a right horizontal leg start requires the left shoulder back for the initiation of the 180° rotation. A left horizontal leg start requires the right shoulder back for the initiation of the 180° rotation.

**TEAM TECHNICAL REQUIRED ELEMENTS**
**Element 4**
**4 - Butterfly Hybrid**
**DD – 2.9**

The Butterfly Hybrid is to be performed rapidly. From a **Front Pike Position**, one leg is lifted to a **Fishtail Position**. The horizontal leg is lifted through an arc of 180° as the vertical leg is lowered to assume a **Split Position**. Without a pause a hip rotation of 180° is executed as the front leg is raised to assume a **Fishtail Position**. Continuing in the same direction a 180° rotation is executed as the horizontal leg is lifted to a **Vertical Position**. The legs are lowered simultaneously to a **Bent Knee Surface Arch Position**. (Note: The **Bent Knee Surface Arch Position** can be assumed by using either leg). The bent knee is straightened to a **Surface Arch Position** and with continuous motion an *Arch to Back Layout Position* is executed.



								Total
NVT=	14.5	20.0	16.5	23.5	21.0	11.5	7.0	114
PV =	1.27	1.75	1.45	2.06	1.84	1.01	0.61	10





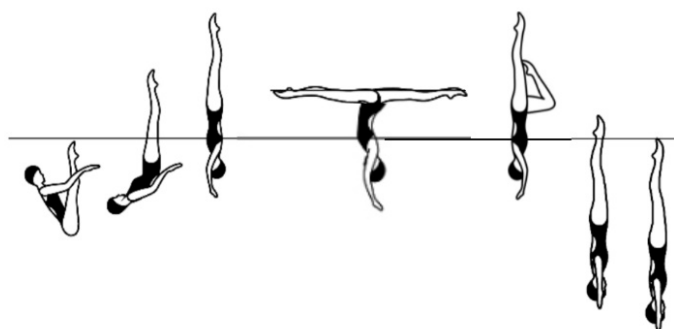

Clarification:

- The Butterfly Hybrid is to be performed rapidly.
- BP 14d) **Bent Knee Surface Arch Position** can be assumed by using either leg.

**TEAM TECHNICAL REQUIRED ELEMENTS**
**Element 5**
**5A-Rocket Split Bent Knee Twirl Hybrid**
**DD – 2.4**

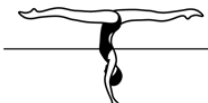
From a **Submerged Back Pike Position** with the legs perpendicular to the surface, a *Thrust* is executed to a **Vertical Position**. Maintaining maximum height, the legs are split rapidly to assume an **Airborne Split Position**, followed by a rapid 180° rotation to assume an airborne **Bent Knee Vertical Position** with the front leg bent. A rapid *Vertical Descent* is executed as the bent knee is extended to join the vertical leg completed as the ankles reach the surface of the water followed by a *Vertical Descent*.



							Total
NVT=		31.0	17.0	25.0	9.0	0	82
PV =		3.78	2.07	3.05	1.10	0	10





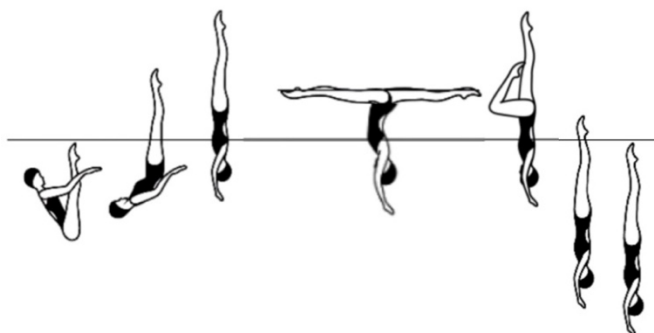

## Clarification:

- All movements are executed rapidly.
- BP 11 **Submerged Back Pike Position** is executed with the legs perpendicular to the surface of the water.
- BM 9 *Thrust* allowance: Deviation allowances for the *Thrust* action are unique and allow for the legs to be up to an additional 15° off the vertical line.
- Refer to BM 9 *Thrust*.
- Refer to the \*Rejoin to Vertical Single Leg water level in the Dynamic Height Scale for the differing height standard requirements following a BM 9 *Thrust* airborne move.

**TEAM TECHNICAL REQUIRED ELEMENTS**
**Element 5**
**5B-Rocket Split Bent Knee Hybrid**
**DD – 2.1**

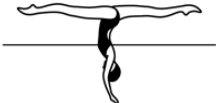
From a **Submerged Back Pike Position** with the legs perpendicular to the surface, a *Thrust* is executed to a **Vertical Position**. Maintaining maximum height, the legs are split rapidly to assume an **Airborne Split Position** followed by the front leg rapidly bending and the back leg rapidly lifting to a vertical to assume an airborne **Bent Knee Vertical Position**. A *Vertical Descent* is executed as the bent knee is extended to join the vertical leg completed as the ankles reach the surface of the water followed by a *Vertical Descent*.



						Total
NVT=	31.0	17.0	13.0	9.0	0	70
PV =	4.43	2.43	1.86	1.29	0	10

## Clarification:

- All movements are executed rapidly.
- BP 11 **Submerged Back Pike Position** is executed with the legs perpendicular to the surface of the water.
- BM 9 *Thrust* allowance: Deviation allowances for the *Thrust* action are unique and allow for the legs to be up to an additional 15° off the vertical line.
- Refer to BM 9 *Thrust*.
- Refer to the \*Rejoin to Vertical Single Leg water level in the Dynamic Height Scale for the differing height standard requirements following a BM 9 *Thrust* airborne move.

## 18. ACROBATIC ROUTINE

Acrobatic Routine is an audience favourite and was renamed from Highlight Routine to help promote the powerful and innovative Acrobatics that athletes now perform in the water.

Acrobatic Routines allow athletes and Coaches to use a different skill set to showcase their creativity, power, and strength in the water.

The declared difficulty and the difficulty score of this routine are solely based on Acrobatics. Hybrids performed in this routine will be reflected in the Artistic Impression score.

Overall, Acrobatics are split into four (4) groups: Airborne, Balance, Combined, and Platform. For the Acrobatic Routine, a total of seven (7) Acrobatics are required, and at least one (1) from each of these groups must be featured. Teams are free to do any Hybrids, but with no declared difficulty assigned and thus not counted towards the difficulty score.

### 18.1 General requirements

- The Acrobatic Routine has four (4) to eight (8) athletes performing a predetermined number of Elements
- Acrobatic Routines are only performed in Senior and Junior categories
- Time Limits as in AS 14.1.5: 3:00 (three minutes)
- Required Elements #1 - #7 may be performed in any order
- As with all routines, the Coach Card must show Elements according to Appendix III to AS rules and the selected order of performance of Elements and Transitions

Note that the declared difficulty in this routine is based solely on Acrobatics.

### 18.2 Acrobatic Routine Elements

Elements required in the Acrobatic Routine are seven (7) acrobatic Team movements:

- Four (4) acrobatic movements that consist of one (1) from each acrobatic group (A, B, C and P)
- Three (3) Acrobatic movements of free group choice

Hybrids are free with no difficulty awarded.

**Acrobatic movement** is a general term for jumps, throws, lifts, stacks, platforms, etc., which are performed as spectacular gymnastic feats and/or risky actions and are mostly achieved with assistance by another athlete(s).

**A team acrobatic movement** is considered as an Element, with at least four (4) athletes or more (for example: three (3) Base Swimmers plus one (1) Featured Swimmer; or two (2) Base Swimmers plus one (1) Support Swimmer who pushes one (1) Featured Swimmer). Team Acrobatic movements must start and finish in the water. All other actions are considered as pair Acrobatics or pair assist actions.

### 18.3 Judging Acrobatic Routines

As in all routines, two (2) panels of five (5) Judges will officiate and provide the scores:

1. First panel: **Elements**
2. Second panel: **Artistic Impression**

Two (2) groups of three (3) Technical Controllers must officiate in the Acrobatic Routine:

1. **Difficulty Technical Controllers** (DTCs) who check the number and the declared difficulty of Elements and the order of performance of Transitions and Elements.
2. **Synchronization Technical Controllers** (STCs) who register the number and type of synchronization errors (unequal actions) observed.

### **18.3.1 Elements Panel of Judges**

Elements panel of Judges shall award one (1) score for the execution of each Element. In acrobatic routines the Elements being judged are all acrobatic movements. Note that Elements Judges do not judge Hybrids if they are included in Acrobatic Routines.

Execution is the level of excellence demonstrated by the athlete's mastery of highly specialized skills. Execution considers how well the athletes perform the Acrobatics they choose to perform. Execution of Acrobatics is judged by the same principles as those guiding other Elements.

The Judge must be cautious to evaluate the whole Acrobatic action, from set-up to completion. Judges evaluate the position achieved, or the stable platform with the Featured Swimmer in control on top.

All Acrobatics must clearly demonstrate height, timing, and control with an efficiency of movement in the execution. Refer to Acrobatics height scale in Section 15.2.4 and Section 15.2.6 for deductions in Acrobatics.

Note that if an acrobatic action is attempted but it does not surface or can be considered a complete failure, or it is unclear which Acrobatics was intended to be performed the Element Judges will give a 3.0 mark (a minimum score).

For general information on judging Elements, including Acrobatics, please refer to Section on Judging Elements starting on page 204 of this Manual.

### **18.3.2 Artistic Impression Panel of Judges**

Artistic Impression panel Judges shall award three separate scores, one (1) score for **Choreography and Musicality**, one (1) score for **Performance** and one (1) score for **Transitions**.

The design of movements and structures inside this Acrobatic Routine must impact the audience giving an aesthetic and surprising effect.

The combination of the Elements required in Acrobatic Routine (seven (7) acrobatic movements) should be using all kind of variations in construction and movements, with the creativity in specialized free transitions skills, Hybrids, patterns, that would lead to success in choreography.

In Acrobatic Routines athletes demonstrate their mastery of Acrobatics combined with creative techniques of Hybrids and Transitions.

Transitions are the linking actions between the Elements. These transitional actions should be used when moving from one Element to another using propulsive techniques, strokes, ballet leg combinations, flexibility surface actions, and surface pattern changes. Transitions not only connect one Element with next but are the main contribution to the pool coverage; Transitions are as important as the Elements. They are the glue that brings the total routine together. For general information on judging Artistic Impression, see Section 16.

## **19. FREE COMBINATION**

The Free Combination must have four (4) to ten (10) athletes who make a combination of routines.

The routines have a predetermined number of Elements (**AS 4.4**) choreographed to music (see Appendix III).

This event is for age groups Youth and 12 and under only.

While the execution is important in the Free Combination, the Artistic Impression is at the heart of this type of routine.

### **19.1 GENERAL REQUIREMENTS**

1. Time limits as in ASAG 5 - 3:00 minutes.
2. Start may be on the deck or in the water, or a combination of both.
3. All subsequent parts must start in the water.
4. A new part begins in very close proximity to the previous part.
5. As in all routines, the Coach Card must show Elements and Transitions in the selected order of performance.
6. The Routine must portray a Theme, which must be declared on the Coach Card.
7. At least two (2) parts must have fewer than three (3) athletes and at least two (2) parts must have all athletes.

For the two (2) or more parts to be considered as having fewer than three (3) athletes, all remaining athletes must be maintaining a pose or doing another movement without disrupting the action of the athletes performing the part. There is no required time length, but a minimum of three (3) seconds is a suggested guideline. The term "parts" refers to the various sections with different numbers of athletes that make up the Free Combination routine.

8. Elements prescribed for Free Combinations as in Appendix III to the AS Rules:
  - Youth category:
    - Four (4) acrobatic movements, and
    - ONLY one (1) Solo Hybrid, one (1) Duet Hybrid and three (3) Team Hybrids (with minimum of four (4) athletes required)
  - 12 and under category:



- Three (3) acrobatic movements
  - ONLY one (1) Solo Hybrid, one (1) Duet Hybrid and three (3) Team Hybrids (with minimum of four (4) athletes required)
- Acrobatic Elements of any group (free choice) cannot have a declared difficulty (DD) higher than listed below:
- Group A – 2.65
  - Group B – 2.60
  - Group C – 2.45
  - Group P – 2.50

Refer to World Aquatics Acrobatics Catalogue for acrobatic movements and their assigned difficulty values. Difficulty values are subject to adjustment by World Aquatics, as required.

The intent of the Free Combination Routine is to be free, with limited rules and regulations with special attention given to Artistic Impression and exchanges between parts.

The term “**exchanges**” refers to the switching from one part to the next part. The exchanges can be viewed as the glue to fitting the parts of the puzzle together seamlessly to make a whole cohesive fluent and artistically meaningful routine following the declared Theme. The intention is that the routine should flow and be logical not requiring Judges or TV cameras to search for the next athlete. The distance between athletes must be safe for the for them, especially in team exchanges. At the same time, obvious distance between exchanges will affect the fluidity of the routine and, therefore, the Judges’ score and will also be subject to a penalty based on the Referee’s decision.

## **19.2 JUDGING FREE COMBINATION ROUTINES**

As in all routines, two (2) panels of five (5) Judges will officiate and provide the scores:

1. First panel: **Elements**
2. Second panel: **Artistic Impression**

Two (2) groups of three (3) Technical Controllers must officiate in the Free Combination Routine:

3. **Difficulty Technical Controllers** (DTCs) who check the number and the declared difficulty of Elements and the order of performance of Transitions and Elements
4. **Synchronization Technical Controllers** (STCs) who register the number and type of synchronization errors (unequal actions) observed

### **19.2.1 Elements Panel**

Elements Judges shall award one (1) score for the execution of each Element required for the Free Combination – Acrobatics and Hybrids.

Execution is the level of excellence in performing highly specialized skills.

For general information of judging execution of Elements see sections starting on page 204 above.

### 19.2.2 Artistic Impression Panel

Artistic Impression Judges award one (1) score for each of the following three (3) components:

#### 1. **Choreography and Musicality**

Choreography is a creative skill of composing of a routine that combines artistic and technical components. It includes variety and creativity in Hybrids and Transitions, the design, and the weaving together of all movements and also the pool coverage.

Musicality covers the use and interpretation of music, expressing the mood of the music, use of the music's structure and also the synchronization with music. How well does the athlete in each part interpret the music?

Each routine must interpret a Theme and declare it on the Coach Card. Does the Theme make sense? Does the overall flow of the routine match the Theme?

Exchanges are a characteristic feature of this type of routine. Thus, Judges should consider the choreography around the exchanges as a key factor in judging the Free Combinations:

- Judges should consider the variety of exchanges. Are team exchanges done involving different numbers of athletes?
- Is there variety in the moves used within exchanges? Are exchanges between parts creative and *unique* or predictable? Is there an element of surprise?

Judges should also consider:

- The variety and creativity of moves. The stronger athletic performances will show energetic, original, imaginative moves in the parts and exchanges.
- Are the same athletes always used for solo/duet/trio and highlight parts or is there a variety of athletes used in all parts?
- The number and order of parts. Are there too many parts so that the Judge does not have time to appreciate what is being done? Are the parts with less than three (3) athletes interspersed between team parts OR are there several solo/duet parts in a row?
- Does the routine flow logically and cover the pool or is it fragmented by the parts with a lack of logical movement? How well are the parts woven together? There should be a harmonious blend of all parts. Each part should seem needed in order to make the routine seem whole.
- Is the routine seamless with each part and exchange flowing and adding to the overall impression of the routine? Does each part work well together?

#### 2. **Performance**

Consider the manner in which athletes present the routine to viewers, total command of the performance of the routine. Throughout each part of the music, athletes should ideally be showing TOTAL COMMAND, compelling Judges to watch. In addition to athletes currently performing the part of the routine, the athletes waiting should also give the feeling that they are involved and part of the routine.

Judges also consider:

- Efficiency, power, and energy level for strokes. Does the level of execution, power and energy change within parts or vary as the routine goes on?
- Are the parts with less than three (3) athletes performed better than the parts with four (4) or more athletes or vice versa?

### 3. Transitions

Judges should consider the artistry and mastery of varied and purposeful movements, propulsions and strokes that link routine Elements. Lack of creativity and variety in Transitions, will adversely influence the exchanges (surface pattern changes, connections).

Judges also consider:

- How is the execution performance ending one part and starting into the next part? Does it flow smoothly and start where the last part finished?
- How clear are the pattern formations between exchanges?

### Free Combination Exchanges Marking Scale

The below Marking Scale for exchanges should be considered by Artistic Swimming Judges in both Transitions (when the exchange occurs during Transitions) and in Choreography and Musicality score.

Category	Mark	Description
<b>Perfect</b> <b>Near perfect</b> <b>Excellent</b>	<b>9.0-10</b>	Surprising exchanges, unexpected, "WOW" factor: no distraction during exchanges, athletes just 'disappear' when finished and 'appear' to start
<b>Very Good</b>	<b>8.0-8.75</b>	Very good and interesting exchanges, no wait time but more obvious what is happening; some distraction by athletes at the time of exchange
<b>Good</b>	<b>7.0-7.75</b>	Good but somewhat predictable exchanges, minimal wait time, may stay on one side of the pool for too long, some distraction by athletes at the actual exchange
<b>Competent</b>	<b>6.0-6.75</b>	Ordinary and predictable exchanges with wait time, athletes finishing a part and those starting a part are distracting
<b>Satisfactory</b>	<b>5.0-5.75</b>	Exchanges are satisfactory and simple with a lot of wait time (body boost under to finish part, waiting and surfacing to start next part); swimming in and out of the exchanges is awkward
<b>Deficient</b>	<b>4.0-4.75</b>	Exchanges do not appear to link routine, look like separate sections with lack of connection

## 20. MIXED DUETS FREE

All rules, routine panels and judgments of routines are the same as for Women Duet Free.

Judging Elements is the same as for Women Duet Free. There are nine (9) Elements, which are judged by the Elements panel of Judges, include:

- **Six (6) Hybrids**, one (1) which must include a Hybrid connection (refer to the Introductory Guide for the Application of Declared Difficulty for more information on Hybrid connections), and
- **Three (3) Pair Acrobatics** (one (1) Lift, one (1) Throw/Jump and one (1) free choice).

The routines must also include **two (2) (or more) connected surface movements with travel**, which are considered Transitions (with no penalty for additional connected surface movements with travel which applies to Elements). These movements are judged by the Artistic Impression panel only.

The Artistic Impression panel will, as in the Women Duet Free, score the Mixed Duet Free for Choreography and Musicality, Performance and Transitions. Within these scores the Judges should consider the uniqueness of athletes' ability to:

- Showcase both the men and the women in **unique interactions**
- Represent their **own style** of performance
- Establish a **distinctive connection** between them throughout the performance
- Captivate and create **memorable moments**
- Provide a strong **emotional impact**
- **Complement each other** while showing strength, flexibility, and power

Size difference of the athletes may occur and cannot be seen as a problem but rather an opportunity to extend the concept of complementary actions.

Finally, the Mixed Duet Free allows for diversity in creativity and innovation of the program, but an essential factor for consideration is a well-balanced routine. The routine should demonstrate a balance in its choice of actions, should arrange the movements to make the routine feel complete and should embrace the concept of a man and woman presenting a vibrant, innovative display of artistry and athleticism.

**21. GLOSSARY OF TERMS FOR ROUTINES**

<b>Accent</b>	A display of different stress, or emphasis, often in contrast to what has gone before. Stress is differentiated by its greater or lesser force.
<b>Acrobatic movements</b>	A general term for jumps, throws, lifts, stacks, platforms, etc., which are performed as spectacular gymnastic feats and/or risky actions and are mostly achieved with assistance from other athlete(s). Refer to Acrobatics Catalogue.
<b>Amplitude</b>	Greatness of size, magnitude, fullness, copiousness, breadth, or range
<b>Asymmetry</b>	Uneven balance or proportion in time, space, or energy. Opposite to symmetry: an arrangement marked by regularity and balanced proportions.
<b>Artistic Impression</b>	An effect, image or feeling retained as a result of demonstration of skill and good taste of the athlete(s).
<b>Boost</b>	A rapid, headfirst rise, with a maximum amount of the body above the surface of the water.
<b>Choreography</b>	The craft of composing and arranging movement into a comprehensive framework.
<b>Complex</b>	Something made up of or involving an intricate combination of components.
<b>Difficulty</b>	The quality of being hard to achieve.
<b>Dynamic</b>	The energy or effort of movement, expressed in varying quality, intensity, texture, or gradations in tension.
<b>Eggbeater Kick</b>	With the body in a relatively vertical sitting position, the lower limbs move alternately, as the left foot moves clockwise, and the right foot moves counterclockwise. The technique of the eggbeater kick provides continuous propulsive force for athletes to maintain the high of the head and upper body above the water.
<b>Energy</b>	Vigor in the exertion of power; strength in action; forcefulness of expression. Varying levels of energy can be displayed through the quality and intensity of the movement and the stressed action or accent of certain notes.
<b>Execution</b>	Refers to the performance level of the skills demonstrated.
<b>Extension</b>	The amount, degree, or range to which something can be stretched to its fullest length. Use of muscular strength to enhance the stretch.
<b>Flexibility</b>	The ability to bend or flex, pliable, range of motion.
<b>Float</b>	Two or more athletes attached to make a surface formation.
<b>Fluidity</b>	The ability to move with ease, able to flow, seamless.
<b>Focus</b>	The gathering of forces to increase the projection of intent - e.g., athlete's sight line. Adds meaning to movement.
<b>Highlight</b>	A portion or detail of a routine of major significance or special interest; a memorable moment.
<b>Hybrid Figure</b>	A figure of mixed origin or composition, and other than those described in the rules.
<b>Intensity</b>	Presence of a greater or lesser degree of energy.

<b>Interpretation of Music</b>	A concept of the music expressed by the performance of the athlete(s). Use of music.
<b>Jump</b>	Same as Stack. But supported person becomes airborne at peak of lift. See Acrobatics Catalogue.
<b>Kinesthetic Awareness</b>	The ability of the individual to know the spatial relationship of the body parts.
<b>Lateral axis</b>	Extending sideways from the body, either through a cross section (such as the hips), or outside the body.
<b>Levels</b>	High/Medium/Low – in relation to water surface. In other words, from high boosts or lifts, to underwater.
<b>Lift</b>	Please refer to the Acrobatics Catalogue.
<b>Longitudinal axis</b>	The lengthwise center of the body.
<b>Manner of Presentation</b>	The way in which the athlete presents his/her routine for the consideration of the public and/or judges. Total command of one's performance, amplitude.
<b>Patterns</b>	Refers to formations made by the spatial relationship between members of a team.
<b>Platform</b>	Please refer to Acrobatics Catalogue.
<b>Pool Pattern</b>	The pathway the athlete(s) take(s) through the water.
<b>Power</b>	The amount of strength or force exerted, might, the rate at which work is done, (strength plus speed).
<b>Projection</b>	Communication of meaning or feeling to the audience.
<b>Propulsion Technique</b>	The process by which the body uses arms and/or legs to move through the water. A driving force.
<b>Rhythm</b>	A structure of movement patterns in time. The pulse or beat.
<b>Risk Factor</b>	Skills which expose the athlete to a chance of a lesser performance.
<b>Routine</b>	A composition consisting of strokes, figures, and parts thereof, choreographed to music.
<b>Spatial Design</b>	Interrelationship of athletes to each other and to the space through which they are moving.
<b>Stability</b>	Resistant to change, especially sudden change; consistent.
<b>Stack</b>	Please refer to Acrobatics Catalogue.
<b>Strength</b>	The state or quality of being strong, physical power.
<b>Stroke</b>	Refers to swimming strokes. A single complete movement which includes a pull and a recovery of the arms(s) accompanied by an appropriate kick.
<b>Style</b>	A personal or characteristic manner of performing or choreographing.
<b>Sustained Height</b>	The ability to maintain a constant level of height above the water.
<b>Sustained Movement</b>	A quality of movement that is smooth and unaccented, with no apparent start or stop, but gives a feeling of a continuity of energy flow.
<b>Synchronization</b>	To swim or execute movements in unison, one with the other and the accompaniment.
<b>Tempo</b>	Pace or speed.

**Throw**

Please refer to Acrobatics Catalogue.

**Transitions**

Are the linking actions between the Elements, including propulsion techniques, strokes, ballet leg combinations, flexibility surface actions, surface pattern changes, or pair assisted actions.

**Variety**

Diversity; assortment. The condition of being varied or diverse.

## CHAPTER IV. - REFEREE GUIDELINES

### 22. GENERAL GUIDELINES

In order to be an effective Referee in Artistic Swimming, they must demonstrate the following:

- Know the rules and how to apply them.
- Have common sense and be able to apply it.
- Be able to analyze the conduct of the competition before, during and after the event.
- Be diplomatic in all interactions with Officials, Coaches, athletes, and organizers.
- Have the capacity to work collaboratively in a team environment.
- Be proficient in English as the official language of World Aquatics.
- Be willing to share knowledge and help facilitate learning throughout the event.
- Ensure the safety of the competition.
- Have experience in demonstrating strong leadership skills on event management at the facility.
- Deliver a positive environment and maintain a calm and respectful demeanor during all aspects of the event.

Modifications of a technical nature may be implemented by World Aquatics on a trial basis in International Competitions.

The World Aquatics Rulebook, **Rule AS 22** defines the duties and responsibilities of the Referee at a competition.

At Olympic Games, World Championships, Artistic Swimming World Cup or other World Aquatics events, certain Referee responsibilities are done in collaboration with the Commission as per GR 9.5 Commissions.

To be able to conduct a successful competition, the Referee must have the following at their disposal 48 hours before the start of the first competition:

All rules pertaining to that competition: World Aquatics plus any Continental, Regional and/or National rule modifications specific to that competition. The Referee shall review and know the rules thoroughly.

All personnel necessary to organize and conduct the competition. In particular, the Referee requires a suitable number of trained deck officials - Judges, Technical Controllers, score keepers, timekeepers, music controllers, announcers, video recorders, etc. The competition organizing committee should also designate an on-deck liaison to the Referee to deal with logistical organization issues affecting the conduct of the event.

All the necessary equipment and materials, including score cards, music equipment, video equipment, stopwatches, appropriate seating for the Judges, computer scoring whenever possible, draw kit, tables, chairs, pens, clip boards etc.

All information regarding entries.



Ensure Organizing Committee has approved World Aquatics power point presentation for Team Leaders Meeting and Judges meeting. These meetings occur prior to the start of the competition.

Receive all competition flow maps and ensure a rehearsal of all procedures has been completed.

Ensure Wi-Fi is available, and that the password has been received.

In the Judges meeting room ensure that a screen and projector are available to show routines.

The meet organizers should provide an officials' liaison to work with the Referee to ensure that all Officials have the necessary equipment (e.g., flash cards, clipboards, scoring papers, etc.) and refreshments, as needed.

The Referee in collaboration with the World Aquatics Delegate, Commission and Evaluators shall have control of the event. The Referee shall enforce the decisions of the group. The Referee will take attendance and provide the Judges with logistical information for the session (for example if there is a break or if there are any scratches). The Evaluators will lead all Judge panel discussions and Judge debriefs.

The Referee shall be responsible for:

1. Overseeing the Draw or Order of Appearance of all sessions.
2. Recording changes of athletes prior to each session.
3. Checking the electronic score system.
4. Checking computer results.
5. Ensuring that an evaluation program is provided.
6. Ensure Coach Cards have been uploaded for the Technical Controllers and that Judges have routine maps for each event.
7. Ensure Judges have routine map for each routine.
8. Be in communication with the Announcer, Medical Personnel, Music Master, Lifeguards and.
9. Receive Coach Card changes and ensure that they are distributed to Scorers, Technical Controller, Announcer, Media, and Broadcast.
10. Ensuring Judges know how to operate keypads for inputting scores. Advise all Judges to raise their hand immediately if they accidentally submit an incorrect score. Judges' scores cannot be adjusted once they have been displayed on the score board.
11. Assisting in the overseeing and supervising of all Officials in any matter relating to the conduct of the actual competition.
12. Ensure that headsets are available to use between opposite sides of the deck.

13. When the event is complete ensure that the correct results are signed by the Referee and available as quickly as possible to enable organizers to proceed with the award ceremonies in a timely manner. Ensure that copies of results are given to the World Aquatics Delegate, Commission and Evaluators.
14. Ensure that all required Officials are in their respective positions on time to conduct the session.
15. In the case of a formal protest, the Referee will convene the protest procedure as per **GR 9.2**.
16. Attending practices with the Judges and Technical Controllers.
17. Ensuring that medical personnel is poolside for the entire event.
18. Inform Judges, Technical Controllers, Announcers, Media, and Music Master if there are any scratches in the event.
19. Signalling the start of the event.
20. During the competition, the Referee must function from a position which enables quick and efficient communication with all personnel as well as the World Aquatics Delegate and Commission.

## Reviews

If a review is required for potential timing penalties or making use of the bottom of the pool, the Referee will inform the Announcer who will immediately announce that the routine is currently under review.

It is recommended that any reviews are done by three (3) reviewers from three (3) different Member Federations.

If the team of reviewers concludes that it is a penalty the Referee will ensure all penalties are applied. The Announcer will only announce scores for the routine after the reviews are completed.

Review process for Difficulty or Synchronization as per Section I (F): Technical Controllers (Difficulty & Synchronization).

In the case of a Technical Controller Review Request **AS 18.10** Technical Controller (DTC/DATC/STC) Review Request is to be followed.

**AS 22.2 The Referee shall be responsible for the running of the deck and overall flow of the event. Rules will be enforced by the Referee after collaboration with the World Aquatics Delegate /Commission. The Evaluators may be consulted as necessary. The Referee in collaboration with the World Aquatics Delegate/ Commission are responsible for questions and decisions of the events relating to the conduct of the event.**

**AS 22.3 The Referee shall ensure that all the necessary officials are in their respective positions to conduct the session. They ensure that officials have their assignments for each routine and are provided with a routine map for each competitor.**

**AS 22.4 The Referee may appoint Reserve Judges for any persons who are absent, incapable of acting or found to be inefficient or biased after consultation with the World Aquatics Delegate /Commission.**

One or more Reserve Judges should be named for each event. They must be present before the start of the event at the Judges meeting room with the rest of the designated panel and Reserve Judges must come prepared to judge.

In addition, to satisfy the Judges' Conflict of Interest rule, the Referee has the authority to remove a Judge from the panel, if they discover a Judge has not disclosed a Conflict of Interest. Judges must observe the World Aquatics Code of Ethics, Section I (G) (Conflict of Interest). If a Judge fails to declare their conflict of interest, the World Aquatics President or one of the World Aquatics Executive members may refer the matter to the Ethics Panel.

**AS 22.6 The Referee ensures that the athletes are ready and signal for the start of the accompaniment. They shall approve the penalties resulting from any infraction to the rules. The Referee and World Aquatics Delegate/Commission shall approve the rules before they are announcements.**

Before the official results are announced, the Referee, World Aquatics Delegate /Commission must ensure that all pertinent information has been included, e.g., penalties, and accurately processed, with all the scores accurately recorded and calculated. When everything has been checked, the Referee signs the result sheets to certify that the results are correct. If a penalty or a deduction (to required elements in technical routines) is to be applied, the Referee must ensure that the Coach or a delegate of the affected participant is informed in time to permit them to present a protest if they wish to do so.

**AS 22.7 The Referee may intervene in the event at any stage to ensure that the World Aquatics regulations are observed and shall adjudicate all protests related to the event with the World Aquatics Delegate/Commission related to the session in progress.**

When a technical problem occurs during a routine performance, the Referee may allow a re-swim.

Guidelines for timing of a re-swim:

- If less than half of the routine has been performed, schedule the re-swim after the next two (2) routines (approximately 15 minutes recovery time).
- If more than half of the routine has been performed, schedule the re-swim after the next three (3) routines (approximately 20 minutes recovery time).
- If the original start number was just prior to a break, the routine could re-swim as the first competitor after the break.
- If a problem occurs during the final routine of the event, the Referee should determine a suitable recovery time (e.g., 10-15 minutes, or sooner if the athlete(s) is/are ready) and ask the Officials to remain in their places until the re-swim has occurred.
- When a technical problem such as power failure resulting in no underwater music, weather conditions, etc., requires a re-swim, the Referee should inform the Coach personally, and the Officials and audience through the Announcer.

- A Men Solo, Women Solo, Women Duet, Mixed Duet, Team Technical, Team Free, Free Combo or Acrobatic Routine can be asked by the Referee to swim earlier than scheduled. The athletes will have two (2) minutes to prepare themselves and then must walk on and be ready to compete.

**AS 22.8 The Referee shall recommend disqualification of any athlete for any violation of the rules that they personally observe by reporting the offender to World Aquatics Delegate/Commission.**

**AS 22.9 The Referee must attend the Team Leaders meeting and ensure logistics for the event are in place.**

**AS 22.10 The Referee runs the draws at the Team Leaders' meetings. Draws will commence after all media information sheets have been submitted to the LOC on each routine.**

World Aquatics approved electronic draws may be used.

World Aquatics recommends that where there are no preliminary events in a direct tech final event if a team or athlete has drawn 1st in tech event they will not draw first in free final or acrobatic event. The same principles apply to Solo, Duet, and Mixed Duets.

For final routine events, see the current World Aquatics Handbook. **AS 7, AS 1.**

**AS 22.11 The Referee ensures that World Aquatics has set up chat groups with Coaches group at the Team Leaders meeting and Officials' groups at the Judges meeting.**

**23. SUMMARY OF PENALTIES FOR VIOLATIONS OF RULES IN APPENDICES II, III, IV AND V REPORTED TO REFEREE BY DTC**

TYPE OF DEVIATION	TECH ROUTINES	FREE ROUTINES	ACROBATIC ROUTINE	FREE COMBINATION	RULE TO APPLY	SCORE (ELEMENT JUDGES)	DEDUCT FROM
<b>EXTRA ELEMENT*</b> (Above allowed number per routine)	-2 points each	-2 points each	-2 points each for each Acro less than 7	-2 points each	<b>AS 18.4</b>	NO score (for extra Element)	Elements score
<b>MISSED ELEMENT</b> (Missing one or more of the required Elements)	-2 points each (Solo exception for HYBRID)	NONE	-2 points each for each Acro less than 7	-2 points each missing Acro	<b>AS 18.7.4</b> <b>AS 18.8.1</b> <b>AS 18.9.2</b>	NO score (for missing Element)	Elements score
<b>LESS ADDITIONAL REQUIRED COMPONENTS</b>		-0,5 points each (Mixed Duet and Youth Team)			<b>AS 18.5</b>	Score	Artistic Impression score
<b>ACROBATICS DECLARED DIFFICULTY</b> (Incorrectly declared more or less difficulty)	-2 points each (Team)			-2 points each	<b>AS 18.7.4</b> <b>As 18.8.2</b>	Score	Elements score
<b>ACROBATICS GROUP</b> (For each of the four (4) Acro Groups not performed)			-2 points each		<b>AS 18.9.2</b>	Score	Elements score
<b>MISSED CONNECTED ACTION/CADENCE</b>	-2 points (Mixed Duet, Team)				<b>AS 18.7.4</b>	Score	Elements score
<b>EXTRA CIRCLE</b>	-2 points each more than one (1) (Team)				<b>AS 18.7.4</b>	Score	Elements score
<b>TRE ORDER TRE #1 to #5 out of order</b>	ZERO				<b>AS 18.7.2</b>	Score	Elements score
<b>MIRROR ACTIONS</b>	-0,5 points each				<b>AS 18.7.3</b>	Score	Elements score
<b>HYBRID &amp; ACRO ORDER OF PERFORMANCE</b> (Performed out of order from what is on the Coach Card)	Base Mark (BM)	Base Mark (BM)	Base Mark (BM)	Base Mark (BM)	<b>AS 18.3</b> <b>AS 18.7.2</b>	NO score Exception: Acro Routine (SCORE)	Elements score
<b>FREE COMBINATION GENERAL REQUIREMENTS Missing #2,3,4,5,6</b>				-2 point each	<b>AS 18.8.1</b>	Score	Routine score

\*The number and the description of required routine components are included in Appendix II and Appendix III.

Note that other penalties, including penalties for noncompliance with routine time requirements and bottom of pool (see AS **18.3.1** to **18.3.5**), which are not included in the above table, may apply.

### **23.1 ACCUMULATED PENALTIES**

Examples of accumulated penalties:

#### **Example 1:**

In Acrobatic Routine only five (5) Acrobatics are performed, and no Acrobatics from Group A was performed. This results in three (3) violations of **18.9.2**, and thus three (3) penalties will be applied to the score:

- Two (2) for performing two (2) Acrobatics less than required (with one (1) penalty for each missing Acrobatics), and
- One (1) for missing Group A.

#### **Example 2:**

In a Mixed Duet Tech athletes perform five (5) TREs, one (1) Hybrid and two (2) Pair Acrobatics. There is no connected action during the Hybrid. This will result in three (3) penalties applied to the score:

- One violation of **AS 18.4** for one (1) extra Element (2 Pair ACRO), and
- Two violations of **AS 18.7.3**: one (1) for lacking one (2) Hybrid, and one (1) for not performing the connected action.

## CHAPTER V. - MEDICAL ISSUES IN ARTISTIC SWIMMING

### 24. ILLNESSES IN ARTISTIC SWIMMING

#### 24.1 ASTHMA

The prevalence of asthma in Artistic Swimming at the Olympic Games in Beijing in 2008 was the second highest of all sports at 21.2%. The overall incidence of asthma for all sports was 7.2%.

Postulation on the cause of this high prevalence of asthma in Artistic Swimming as an endurance discipline suggests that this may be the result of chronic exposure of the lungs to environmental allergens while breathing rapidly and deeply during endurance training. The exposure of the lungs to irritant chloramines, by-products of chlorine, is a major factor. Partial reversibility of these findings appears to occur upon retirement from elite sport. More research is required to determine a strategy to minimize or reduce the adverse effects of training on airways.

Treatment of asthma in the elite athlete is restricted by the conditions of the World Anti-Doping Association as many of the inhaled treatments (beta2agonists) are prohibited. Attention to these requirements is essential to avoid an anti-doping rule violation. Medical attention should be sought in the athlete who complains of prolonged intermittent cough, wheezing, difficulty breathing or chest tightness.

#### 24.2 RELATIVE ENERGY DEFICIENCY in SPORT (RED-S)

Relative Energy Deficiency in Sport (RED-S) is a clinical syndrome resulting from **relative energy deficiency** that affects many aspects of physiological and psychological function beyond menstrual cycle and bone health. The IOC has defined RED-s as a syndrome that

*“Refers to impaired physiological functioning caused by relative energy deficiency, and includes but is not limited to metabolic rate, menstrual function, bone health, immunity, protein synthesis, and cardiovascular health”*

RED-s is caused by **energy deficiency** relative to the balance between the *energy intake* and the *energy expenditure* of homeostasis (beating heart, body functions), + the physical activity of daily living (walking and moving) + sport activity.

Energy availability is defined as energy intake minus energy expenditure. An athlete runs into difficulty when their energy output exceeds their energy intake. This can occur as a result of an eating disorder or by disordered eating. In some cases, an energy deficit can occur in the absence of these scenarios simply by inadequate intake of nutrition to meet the energy output or prolonged exercise. One physiological result of the energy deficit is menstrual dysfunction ranging in a spectrum from an abnormal menstrual cycle to a complete lack of menses (amenorrhea). Another consequence to the energy deficit is altered bone health. This can range from optimal bone health to progressive thinning of the bone known as osteoporosis. In athletes, the first presentation of unhealthy bone density is often a stress fracture. This may go unrecognized in Artistic Swimming during an athlete's competitive years due to the relatively low impact of training; however, healthy bone mass density is necessary to prevent problems later life. Other body systems can also be affected as seen in the diagram below:

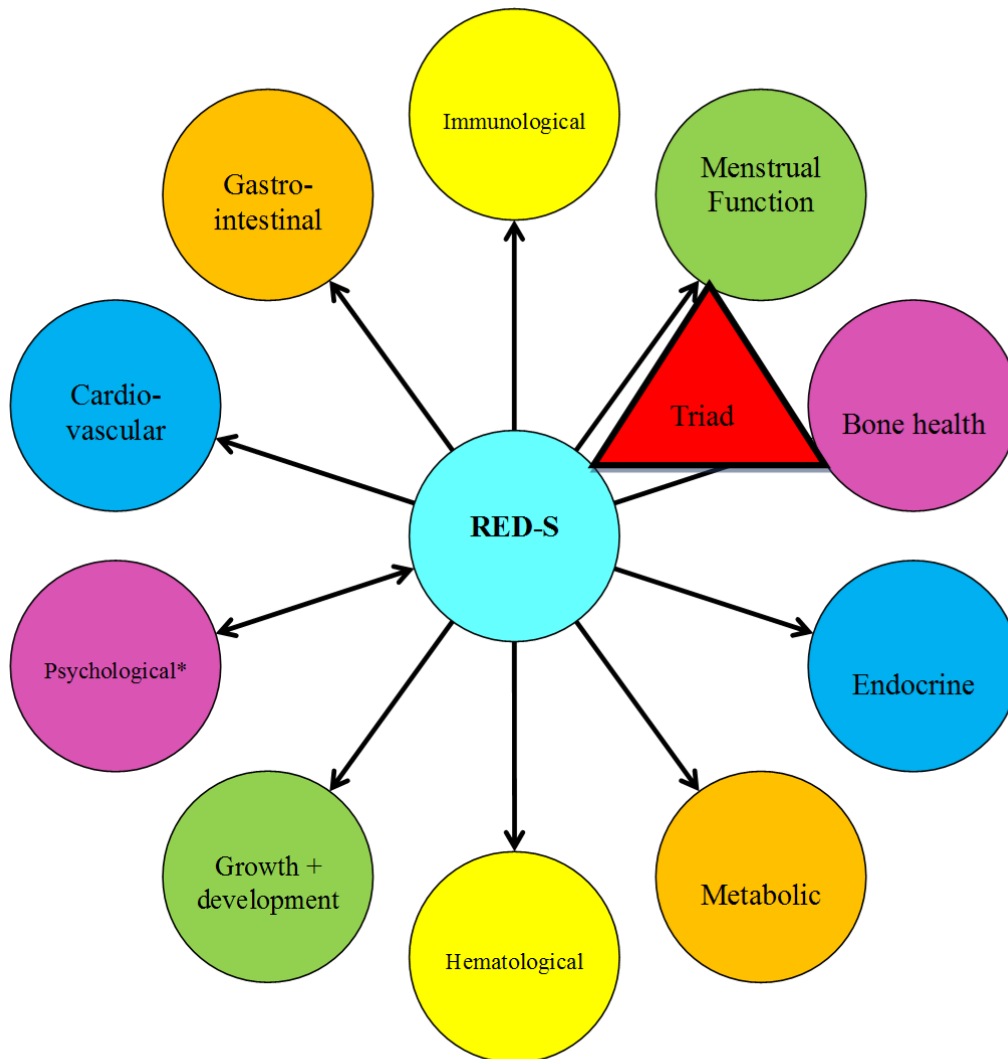

RED-S can also negatively affect athlete sport performance.

The exact prevalence of the Triad in Artistic Swimming is unknown however it is often seen in clinical practice.

An artistic swimmer who does not have one or more of the body systems affected in the diagram above should seek medical attention to rule out the presence of the RED-S.

### **24.3 EATING DISORDERS / DISORDERED EATING**

The sports medicine scientific literature clearly acknowledges that athletes in esthetic sports such as Artistic Swimming are at higher risk for developing an eating disorder or disordered eating.

Due to the judged nature of Artistic Swimming, there is a pressure for these athletes to be lean and thin. In some cases, this may lead to a clinical eating disorder or disordered eating.



An eating disorder is a psychiatric diagnosis characterized by a disturbance in eating behaviors. There are four (4) types of eating disorders: anorexia nervosa, bulimia nervosa, binge eating disorder, and other specified and unspecified feeding or ED (OSFED). Anorexia nervosa is characterized by marked restriction of eating with a 15% weight loss from expected norm. Despite this, the athlete feels overweight and has a fear of gaining weight. Bulimia nervosa is characterized by repetitive cycles of bingeing –eating followed by purging. They are usually of normal weight.

Disordered eating occurs when there are abnormal eating behaviors which are not severe enough or have occurred long enough to meet the diagnostic criteria for an eating disorder. The prevalence of eating disorders in esthetic sports that emphasize leanness in the literature ranges between 18 - 45% in comparison to 5% in the general population. A desire to be leaner to enhance performance seems to predict later development of disordered eating. Finally, disordered eating seems to be influenced by perfectionism, competitiveness, pain tolerance and the perceived performance advantage of weight loss.

The consequences of eating disorders are serious affecting both the physical and psychological health of the athlete. Psychological sequelae include depression, anxiety, and low self-esteem. Physical sequelae of eating disorders affect all body systems. There is a six-fold mortality rate with a high suicide rate. Prognosis for long term recovery from eating disorders is guarded. This health issue is a serious problem for athletes in esthetic sports – and for artistic sports.

### **Management of Eating Disorders**

In a non-threatening environment, the athlete is more likely to accept support and minimize the risk of progressive illness. Another initiative which may assist in the early stages of managing the anorexic athlete includes psychotherapy with a trained sport psychiatrist/psychologist. Nutritional advice and the establishment of firm weight goals in consultation with the team physician are also recommended. Prevention through sensitive and private body composition measurements, as well as educational initiatives are recommended.

### **24.4 HYPOXIA**

Prolonged breath holding carries with it the risk of Hypoxia [reduced blood oxygen]. When associated with physical activity in an underwater setting, the potential for loss of consciousness [‘black out’] is of significant concern. Available medical evidence strongly suggests that the combination of prolonged breath holding - more than 45 seconds - and vigorous physical activity can have serious medical consequences. ‘Black out’ under water is clearly a serious and potentially lethal situation.

Hyperventilation [over breathing] prior to a competition is also known to increase the risk of a black out and should be actively discouraged. The practice of hyperventilation lowers the levels of carbon dioxide in the blood stream and abolishes an important trigger for normal breathing.

Hypoxia has been demonstrated in Artistic Swimming, resulting in confusion in the past, when the emphasis in Artistic Swimming routines was on prolonged breath-holding. The style in Artistic Swimming has changed since then to a more acrobatic and artistic style with emphasis on execution and less emphasis on breath-holding. Although hypoxia is now rare, Coaches should be aware of this phenomenon and prevent prolonged breath holding practices.

## **25. INJURIES IN ARTISTIC SWIMMING**

### **25.1 SHOULDER**

In Artistic Swimming, the most common cause of injury to the musculoskeletal system is overuse. The athlete trains for cardiovascular fitness by swimming freestyle. In addition to this training, they also do repetitive synchro-specific skills such as arm actions in routines, support scull with lifts and boosts and dry land drill –an on-land rehearsal of the routine. These activities occur repetitively for several hours daily. All these repetitive actions over time may result in micro-trauma to the rotator cuff muscles of the shoulder. Another mechanism may be impingement of inflamed soft tissue structures of the shoulder such as the subacromial bursa.

Flexibility and balanced muscle strength are essential requisites for all successful artistic swimming athletes.

The athlete with a shoulder injury will complain of pain of lifting the arm away from the body or of shoulder movement which progresses to the point where the athlete is unable to continue training.

#### **The Management of Shoulder Pain in Artistic Swimmers**

The successful management of shoulder pain in any athlete demands the cooperation of athletes, Coach, physician, and other allied healthcare expertise. Management begins with an accurate clinical diagnosis, which is the prime responsibility of the sports physician. To distinguish between the various causes of shoulder pain, a full clinical examination followed by specialized ultrasound, MRI or CT scans may be necessary.

Early conservative management includes rest from all provocative activities. An athlete could still attend training and do kicking drills or dry land workouts. The use of ice massage and other physiotherapy modalities should be included. The correction of technical problems may require video analysis and biomechanical expertise, and there will be obvious input from the Coach. Communication between physician, athlete and Coach is essential.

The athlete can maintain aerobic fitness during rehabilitation by incorporating cross training activities into the program. For example, while resting an injured shoulder, cycling, jogging, and kicking drills are appropriate alternatives.

Return to sport demands the recovery of full pain free movement. If poor technique has been ignored, then it is only a matter of time before symptoms return and the vicious cycle of pain and limited movement returns.

## **25.2 LUMBAR SPINE**

Resulting from the fast mechanical movements seen in Artistic Swimming team and duet events, the lumbar spine of the athlete is particularly vulnerable to injury. Injury to the lumbar spine is thought to be caused from the repetitive and rapid arching. A unique move in Artistic Swimming that adds further stress on the lumbar spine is the 'rocket-boost' and the 'knight' position. Training errors can be blamed for the development of lumbar dysfunction and should be taken into consideration when evaluating the athlete for the cause of the injury and when developing the treatment plan. These errors include excessive repetitions, explosive speeds, arching with a rotational component, excessive over-arching, inadequate neuromuscular training, poor core stability & posture, inadequate flexibility, and premature progression to higher risk skills.

There are many injuries that occur to the lumbar spine. These range from muscle strains to more serious injuries, including stress fractures of the spine (spondylolysis) or neurological compromise requiring urgent medical intervention. The athlete who complains of lumbar pain should seek medical attention. A thorough physical examination and appropriate imaging studies as indicated are necessary to ensure the accurate diagnosis and subsequent treatment plan.

## **25.3 KNEE**

Like the breast-stroker and the water polo player, the athlete in Artistic Swimming is vulnerable to chronic overuse injury of the knee. This can be attributed to the eggbeater kick. Progressively difficult eggbeater drills are used as foundation training for the development of strength and skill.

The athlete may present with either medial or anterior joint pain. The medial joint pain can be explained by the medial joint stress caused by the positioning of the knee during the eggbeater kick. Anterior joint pain is attributed to abnormal tracking of the kneecap in the notch of the femur. The athlete will complain of stiffness after rest and anterior knee pain while kneeling and using the stairs. It may be aggravated by the eggbeater kick at later stages.

Knee pain in the Artistic Swimming athlete most often can be managed with non-surgical interventions. Alteration to the duration and intensity of the eggbeater kick during training is necessary. Cross training on the bicycle for fitness is preferred to jogging during the rehabilitative process, which may aggravate knee injuries.

## **25.4 CONCUSSION**

Emphasis in recent years in Artistic Swimming has been on the development of high-risk acrobatic moves, especially in the team routine.

The brain is a complex organ that does not respond well to trauma. It often does not heal as predictably as bony or muscular injuries. This unpredictability may lead to difficulty in detection, treatment, and recovery from concussion.

Concussion is defined as:

1. A disruption of brain function caused by an external force, AND
2. Manifests as an alteration of attention or mental state, AND
3. Is indicated clinically by new onset or worsening of a range of evolving signs and symptoms that are influenced by both intrinsic and extrinsic factors.

4. Exclusion: Manifestations of concussion must not be due to drugs, alcohol, medications, caused by other injuries or treatment for other injuries or caused by other factors such as psychological trauma, language barrier, or co-existing medical conditions.

Several common features that incorporate clinical, pathological, and biomechanical injury constructs that may be utilized in defining the nature of a concussive head injury include:

1. Concussion may be caused either by a direct blow to the head, face, neck or elsewhere on the body with an “impulsive” force transmitted to the head.
2. Concussion typically results in the rapid onset of short-lived impairment of neurologic function that resolves spontaneously.
3. Concussion results in a graded set of clinical syndromes that may or may not involve loss of consciousness. Resolution of the clinical and cognitive symptoms typically follows a sequential course. However, it is important to note that in a small percentage of cases post-concussive symptoms may be prolonged.
4. Concussion does not result in an abnormality on standard structural neuroimaging studies.

The diagnosis of concussion should be considered by Coaches in the athlete who has had a blow to the head if they portray any of the following scenarios:

1. Symptoms - somatic (e.g., headache), cognitive (e.g., feeling like in a fog) and/or emotional symptoms
2. Physical signs (e.g., loss of consciousness, amnesia)
3. Behavioural changes (e.g., swimming the wrong way)
4. Cognitive impairment (e.g., slowed reaction times)
5. Sleep disturbance (e.g., drowsiness)

The athlete who is suspected to have a concussion should seek immediate medical attention. Return to training should occur under medical supervision and only occur once the athlete is completely symptom free and has undergone a graduated program of increasing cognitive challenges (return to learn or return to work) followed by a graduated program of increasing physical activity (return to play) with no recurrence of symptoms.

## CHAPTER VI. - GUIDELINES FOR APPROPRIATE CONDUCT AT COMPETITIONS

### 26. GENERAL CONDUCT

Coaches and other team personnel should:

- Exemplify conduct they wish their athletes to adopt in dress and behavior.
- Accept responsibility for their athletes' conduct.
- Demonstrate mutual respect among themselves and towards personnel of all entries.
- Cooperate fully with meet organizers and officials during practices and events.

To uphold their independence and impartiality, World Aquatics Judges, World Aquatics Technical Controllers and World Aquatics Evaluators may not wear their Member Federation's uniforms or any clothes indicating their Member Federations or country of their Member Federation.

### 27. CONDUCT DURING PRACTICES

Coaches should follow guidelines for practice procedures as provided by meet management and ensure that their athletes clear the pool as soon as their practice time is over.

With Music

- Coaches have the right to deny other teams access to the pool during their allotted music spacing time.
- If a Coach wishes to make use of the pool during another team's designated time, they must ask permission of that team's Coach and abide by the decision.
- When a team uses the pool during another team's music time, it should only be for figure and/or routine Elements which do not require audible marking of time – i.e., 'banging'/tapping – or infringe on the designated team's use of the pool space.

Without Music

- During open practices which are scheduled for a specific event, Coaches should have only the athletes for that specific event in the pool. For example, only Solos swim during the practice time designated for Solos.
- 'Banging' or tapping is not allowed at any time.
- Request permission of meet management to use unscheduled empty pool/space between events.

For Figures Competitions

- When practice time is divided due to a large entry, decisions of management must be respected. Athletes can practice only in that portion of the time and pool to which they are assigned.

**28. CONDUCT DURING THE COMPETITION**

All team personnel should keep clear of music center, scoring tables and Judges' panels. The Referee will ensure Coaches and teams remain in designated areas throughout the sessions to ensure smooth delivery of the event.

Coaches and all team personnel must be in special team designated areas.

Applause for a performance should be in an appropriate manner. Screams and screeches as expressions of enthusiasm and support for friends or team-mates can be annoying to spectators, distracting to Judges and may have a negative impact on the atmosphere the performance is attempting to establish. This is at the discretion of the Referee.