

# OFFICIAL TOURNAMENT RULES

*January 25, 2025*



Questions of interpretation and suggestions for improvement or changes in the rules should be forwarded to the AWSA Rules Committee.

These rules may be amended at any time by the Board of Directors, on its own initiative or at the recommendation of the Rules Committee. After amendment by the board, the amended rules shall become effective immediately, unless a different date is specified. A notice of the amendment shall be promptly posted on the official AWSA website.

*All rule changes subsequent to the 2024 Rule Book are written in **bold italics***

**USA Water Ski & Wake Sports**  
**2701 Lake Myrtle Park Road**  
**Auburndale, FL 33823-9360**  
**• 863-324-4341 phone • 863-325-8259 fax**  
**E-mail: [competition@usawaterski.org](mailto:competition@usawaterski.org)**  
**Website: [usawaterski.org](http://usawaterski.org)**

**American Water Ski Association**  
**Official Tournament Rules**

**TABLE OF CONTENTS**

<u>RULE 1 - GENERAL.....</u>	<u>1</u>
<u>RULE 2 - TOURNAMENT EVENTS, ENTRY, REGISTRATION, ORDER OF CONTESTANTS .....</u>	<u>5</u>
<u>RULE 3 - DIVISIONS OF COMPETITION AND PERFORMANCE RANKINGS .....</u>	<u>7</u>
<u>RULE 4 - TOURNAMENT QUALIFICATION REQUIREMENTS.....</u>	<u>11</u>
<u>RULE 5 - OVERALL AND TEAM COMPETITION .....</u>	<u>15</u>
<u>RULE 6 - OFFICIALS.....</u>	<u>17</u>
<u>RULE 7 - RERIDES, PROTESTS AND DISQUALIFICATION .....</u>	<u>22</u>
<u>RULE 8 - EQUIPMENT AND DEFINITIONS .....</u>	<u>26</u>
<u>RULE 9 - JUMPING .....</u>	<u>32</u>
<u>RULE 10 - SLALOM.....</u>	<u>43</u>
<u>RULE 11 - TRICKS .....</u>	<u>58</u>
<u>RULE 12 - SAFETY REQUIREMENTS.....</u>	<u>71</u>
<u>RULE 13 - OPTIONAL TOURNAMENT FORMATS .....</u>	<u>73</u>
<u>RULE 14 - RECORDS .....</u>	<u>76</u>
<u>RULE 15 - RECORD CAPABILITY TOURNAMENTS .....</u>	<u>79</u>
<u>RULE 16 - CASH PRIZE TOURNAMENTS.....</u>	<u>83</u>

**APPENDIX**

<u>Rules Interpretations.....</u>	<u>85</u>
<u>2025 IWWF/AWSA Rules Differences.....</u>	<u>86</u>
<u>Officials Development Program .....</u>	<u>88</u>
<u>Tow Line Dimensions.....</u>	<u>90</u>
<u>Official Slalom Course.....</u>	<u>91</u>
<u>Tow-Pylon Specifications Diagram .....</u>	<u>92</u>
<u>Handle Measuring.....</u>	<u>92</u>
<u>Official Jump Course Diagram .....</u>	<u>93</u>
<u>Ramp Setting Chart .....</u>	<u>94</u>
<u>AWSA Computer Benchmark for Jump Meter Set-Up (See TC Manual).....</u>	<u>94</u>
<u>AWSA Computer Benchmark for Jump Distance Calculation (See TC Manual) .....</u>	<u>94</u>
<u>Official Trick Course .....</u>	<u>95</u>
<u>Trick Descriptions and Point Values.....</u>	<u>96</u>
<u>Speed Control Parameter Adjustment Chart for Jump .....</u>	<u>97</u>
<u>Speed Control Parameter Adjustment Chart for Slalom .....</u>	<u>98</u>
<u>Allowable Boat Adjustments .....</u>	<u>99</u>
<u>AWSA Jumping Event Timing Tolerance Table.....</u>	<u>100</u>
<u>Slalom Timing Chart - Record Tolerance ABT.....</u>	<u>101</u>
<u>Slalom Timing Chart - Standard Tolerance ABT.....</u>	<u>102</u>
<u>AWSA National Championships Event Class.....</u>	<u>103</u>
<u>Rules Jurisdiction Chart .....</u>	<u>104</u>
<u>Tournament Classification Requirements .....</u>	<u>106</u>

## **RULE 1 - GENERAL**

### **1.01 Application**

- A. The rules set forth here govern all sanctioned tournaments.
- B. For all sanctioned tournaments, certain deviations are permitted. The exceptions are listed in the section of the rules to which they apply.
- C. Whenever the masculine is used, the same shall be construed as meaning the feminine where the context so requires.
- D. IWWF Class L & R events conducted under USA Water Ski & Wake Sports (USA-WSWS) sanctioning will be conducted administratively by applying AWSA rules and, in instances where skiing conditions are affected, by applying IWWF rules when different from AWSA.
1. The intention is that performances, considered for placement on world ranking lists or for world records, be conducted under conditions identical to events conducted elsewhere in the world (i.e. a level playing field).
  2. Examples of administrative issues where AWSA rules would apply:
    - a. Tournament Entry Registration.
    - b. Tie breaking rules at Nationals, Regionals and State tournaments.
    - c. Starting line lengths.
  3. Examples of skiing conditions where IWWF rules would prevail:
    - a. Trick falls before the course.
    - b. Number of flips scored in a trick run.
    - c. Waiver of conditions encountered in jump.
    - d. Reride actions in jump.
  4. Slalom, Jump and Trick courses and equipment shall be in accordance with IWWF Rules except as noted in this rule book for classes E/C/F.
- E. Contact USA-WSWS for additional variations permissible for Class F tournaments.

### **1.02 Tournament Classification**

- A. Sanctioned tournaments shall be designated:
1. CLOSED (limited to residents within a certain locality or to certain classes or groups of skiers except as limited by Rule 3.01)
  2. OPEN
  3. COLLEGIATE (National Collegiate Water Ski Association).
- B. All tournaments are further classified as:

1. RECORD CAPABILITY (Class R, L and E)

Class R – World and National Records may be set also all IWWF and AWSA ranking lists performances may be earned.

Class L – National Records may be set also IWWF and AWSA ranking list performances may be earned.

Class E – National records may be set and only AWSA ranking list performances earned. For National Records to be set in Class E, the same skier criteria must be used as identified in Class L where applicable (same speed/no additional falls/flips) difference may be less or lower judges' rating, judges' position.

2. CLASS C - Standard local tournaments in which all AWSA ranking list performances may be earned.

3. CLASS F (Grass Roots), primarily for beginning skiers, which allow wide variations from the requirements of the other classifications. To add jumping to a Class F (Grass Roots) classification a minimum of a State Safety Director and Regular (**D3**) Driver is required.

4: CLASS X - Used for experimental formats; i.e. change in course configuration, different boat speeds, etc., where scores WOULD NOT be placed on the ranking lists. Also see Rule 1.09 C.

C. Tournament classifications may be combined. For example, a Class R tournament may be run in conjunction with a Class C (or other).

D. Tournament fees: Please see USA-WSWS website under AWSA heading. Additional regional fees are also shown. (Class F & X same fee)

E. A skier may not ski in more than one class or division in the same event in the same round at one tournament and may not ski more than three rounds in an event at a tournament with the exception of skiers using the option in rule 3.03 Elite Skiers Overall. (See Rule 1.09, 3.03F and Rule 13)

### **1.03 Sponsor Qualifications**

All tournaments shall have at least one USA-WSWS affiliated club as one of the sponsors.

### **1.04 Executive Vice President Approval**

The approval of the Regional Executive Vice President (EVP) shall be required for all tournament classifications.

### **1.05 Regional and National Dates**

Tournaments are held on an annual basis. The Regional Tournaments shall conclude one to six weeks prior to the National Tournament.

### **1.06 Exceptions to the Rules**

Where compliance with the rules is infeasible, the Chief Judge shall, with the approval of a majority of the Appointed Judges, make the necessary change, inform each contestant, and send a report to the Rules Committee. Where the rules are definite and feasible, a vote of the judges to decide whether to enforce any provision is prohibited.

### **1.07 Interpretation of the Rules**

Questions of interpretations of the rules should be referred to the Chairman of the Rules Committee when possible. In the interest of expediency, the Chairman may give his own interpretation, which shall be binding until the committee has been polled. This shall serve, however, only as a temporary interpretation until the Chairman refers the question to the entire committee for a vote in the normal fashion. Such a poll shall take place as promptly and in the most practical manner possible. Otherwise, the interpretation shall be made by a majority vote of the Appointed Judges, and the Chief Judge shall make a report to the Rules Committee concerning the question. **Contact the Rules Committee representative from your Region if you need assistance.**

[American Water Ski Association Committees \(usawaterski.org\)](http://usawaterski.org)

### **1.08 Amendments to the Rules**

The rules may be amended at any time by the Board of Directors, on its own initiative or at the recommendation of the Rules Committee. After amendment by the board, the amended rules shall become effective immediately, unless a different date is specified. A notice of the amendment shall be promptly posted on the official AWSA website. An individual may submit to the Rules Committee, prior to August 31, proposed rule changes, including new tricks, to be evaluated for the next year's rules.

### **1.09 Tournament Limitations**

A. SANCTION PERIOD LIMITATION: Tournaments, except the US Nationals, shall be sanctioned for a period of not more than six consecutive days, except where an official postponement is necessary for reasons of safety.

B. TOURNAMENTS PER DAY: Except for the Nationals, U.S. Open, and Team Trials, a tournament site or sponsor shall be limited to a single tournament each day

C. ROUNDS PER TOURNAMENT: There shall not be more than three rounds per tournament unless subsequent rounds after the third round are elimination based or sanctioned as Class X. Alternatively; one tournament may have four rounds if held over two or more days. Also, see Rule 13.01.A.

### **1.10 Prizes and Awards (This rule was deleted in 2008.)**

### 1.11 Rule Change Authorization

Rule changes may be authorized for a particular tournament as follows:

- A. At the request of the Rules Committee, for the purpose of trying out new provisions under consideration by the committee, and with the approval of a majority of the Appointed Judges for the tournament; or
- B. At the request of the sponsoring affiliated club, and with the approval of a majority of the Appointed Judges, to conform with unusual situations, provided that such requests shall be presented to the Chairman of the Rules Committee at least three weeks in advance of the tournament date; and he shall give his decision at least one week in advance of the tournament date; or
- C. At the request of the sponsoring affiliated club, for purposes of experimentation, promotion of spectator appeal, or other reasons, provided that such requests shall be presented with the request for sanction, and in any event at least six weeks in advance of the tournament, to the Rules Committee, which shall approve, amend, or deny the request, and shall give its decision at least one week in advance of the tournament date.

**For all above requests go to the [www.usawaterski.org](http://www.usawaterski.org) rules section and submit a rules exception request.**

### 1.12 Tolerances

In any activity involving the performance of an official where a tolerance is involved, it is the official's responsibility to be as close as possible to the actual specification. All tolerances are to allow for human error and the use of tolerances by Officials to improve skier performance will not be tolerated.

### 1.13 Tournament Reporting

All tournament scorebooks from USA-WSWS sanctioned tournaments class C and above, and scores from IWWF sanctioned international competitions to which USA-WSWS sends official team delegations, shall be submitted for inclusion in the USA-WSWS National Ranking List. The list will rank skiers based on the average of their top three tournament scores in slalom, tricks, jumping and overall unless a higher score is calculated using less than three tournaments and applying the appropriate penalty (see details below). For tournaments having multiple rounds only the best single round score will be taken for that tournament. A skier having fewer than three tournament scores will have penalties applied to the average of the scores they do have, in the respective classes reported, and based on the table below:

	<u>Penalty</u>
One Class C Score	10%
One Class E or above Score	5%
Two Class C Scores	5%

One Class E Score AND one Class C Score	2.5%
Two Class E or above Scores	0.0%

If the skier has two or more scores, then the Ranking List Score will be the highest of the following possibilities:

1. The best single score with penalty for that one score according to the chart above;
2. The average of the best two scores with penalty for those two scores according to the chart above;
3. The average of the best three scores with no penalty.
4. The average of the best two Class E/L/R scores.

(See Rule 3.06 for limitations on scores below a class C)

Only skiers with a USA Federation code and USA Citizenship will be included in the Ranking list labeled "USA only". However, a competitor with dual citizenship who skis in an international competition for another federation shall not be eligible for placement until after the next international tournament competition (same type as previously skied in: Worlds/Sr Worlds/Pan Am Games/World Games) in which the competitor did not ski for another federation. It will then be the skier's responsibility to initiate a code change with the USA-WSWS HQ Staff. This would apply to Rules 4.02, 4.03A4 and 14.01.

### **1.14 Judging Standards**

When a judgment call is too close to call and cannot be decided by allowable reviews, then the benefit of the doubt shall go to the skier.

## **RULE 2 - TOURNAMENT EVENTS, ENTRY, REGISTRATION, ORDER OF CONTESTANTS**

### **2.01 Events**

The events in a tournament are Jumping, Slalom, and Tricks, with a champion and succeeding places determined in each event based on highest scores. Except for the Boys 1 and Girls 1 divisions, which do not include the Jumping event, National and Regional Tournaments must include all three events. The events to be scheduled at other sanctioned tournaments shall be determined by the sponsoring affiliated club and shall be listed in the tournament announcement.

### **2.02 Schedule of Events**

A schedule showing the order of the events and divisions, the date on which they will occur and the starting hour for competition shall be published and made available upon request no later than two weeks prior to the start of the tournament. A schedule of starting times for individual events, if shown, shall be for the guidance of the contestants only, and any deviation from the schedule shall not constitute a change.

### **2.03 Schedule Changes**

Changes in the schedule during the tournament shall be made only for weather, water conditions, safety, technological delays, or to avoid having one division compete in two or more events at the same time on separate lakes, or a similar reason, and not for the convenience of any skier. A majority of the Appointed Judges must approve the change, and all affected contestants or their representatives shall be notified. Notification will be posted on site and through skiers' registration contact information. Although schedule changes are discouraged, the judges should not hesitate to make adjustments required for safety.

### **2.04 Entry:**

#### **A. Nationals:**

1. On-line Entry: All entries for the National tournament (with the required entry fees) shall be submitted on-line by 12:00am ET on the Tuesday preceding the week of the Nationals to avoid penalty. Skiers shall enter on the USA-WSWS web site ([usawaterski.org](http://usawaterski.org)) under Water Ski National Championships /Tournament Registration/Online Registration, within the time frame listed in the rules. No other form of entry will be accepted.

2. Late Entry: Late entries shall be accepted on-line up to one-half hour prior to the start of the contestant's first event. Entries submitted after the 12:00am entry deadline will include a late fee established by the Board of Directors, per 24-hour period or portion thereof.

B. Other Tournaments: Before the start of all tournaments, except the Nationals, the entry list shall be closed. Entries later than those noted may be allowed at the option of the sponsoring affiliated club. However, no entries shall be accepted later than ten minutes before the event is expected to begin.

### **2.05 Registration**

A. Nationals: All contestants must register for the National Tournament on-line no later than one-half hour before the scheduled start of the contestant's first event. If the skier's registration on [usawaterski.org](http://usawaterski.org) is incomplete or is NOT shown as qualified and fully paid in the online registration system, then they would need to contact the Chief Registrar or present themselves at on-site Registration within the allowable hours as listed on [usawaterski.org](http://usawaterski.org) or [waterskinationals.com](http://waterskinationals.com).

B. Other Tournaments: All contestants must register for the tournament, either in person, by mail or fax, by web registration, or through a representative, providing all required proof of qualification and paying the entry fee. In all cases, registration must occur within the allowable hours as listed on the tournament announcement or at registration. No skier may complete his registration later than ten minutes before the contestant's first event is expected to begin.



- C. In the event registration is done by mail, fax, or web registration, the contestant assumes all responsibility for assuring that all proof of qualification and entry fees have been received and recorded by the Registrar.

## **2.06 Order of Contestants**

- A. Nationals: For the National Tournament, entry shall be closed as noted in Rule 2.04A, and the order of contestants in each event shall be determined and posted by the AWSA National Rankings before the start of the contestant's event. The contestants in each event will be ordered according to their ranking, with the highest seeded skier skiing last, and shall be guided by the performances during the year preceding the National Tournament.
- B. Other Tournaments: The order of contestants shall be made by random draw or shall be seeded before the start of the tournament. The Chief Judge shall designate the order of late entries pertaining to the manner in which they will be added to the order of contestants.
- C. Except at Regional or National Tournaments, in the interest of expediency, a change in the order of contestants may be allowed by a majority decision of the Appointed Judges. Such a change is to occur prior to the start of the event.
- D. For any division in which skiers request a lower ramp height, these skiers shall be grouped together and, at seeded tournaments, shall ski prior to those using the higher ramp height for that division.
- E. For Regional and National Tournaments, nonplacement skiers shall ski prior to placement skiers (For Jump, see Rule 2.06D).

## **RULE 3 - DIVISIONS OF COMPETITION AND PERFORMANCE RANKINGS**

### **3.01 Amateur and Professional Status**

There shall be no distinction between amateurs and professionals.

### **3.02 Divisions**

- A. Competition for the three major events shall be separated into the following divisions as determined by the contestant's age. The "ski year" shall begin on the day after the conclusion of the Nationals, and shall end on the final day of the following Nationals. The contestant's age on December 31 of the ski year shall determine his division for the entire ski year. For example, if a skier's birthday within the "ski year" could result in an age division change and his birthday is between the day after the conclusion of Nationals and December 31 inclusive of that "ski year", he will ski in the older division, beginning the day after Nationals. Otherwise, he will remain in the younger division for one more season concluding with the end of the following Nationals.

<b>Age Divisions</b>	<b>Age</b>
Boys 1/Girls 1	9 years and under
Boys 2/Girls 2	11 years and under
Boys 3/Girls 3	13 years and under
Boys 4/Girls 4	15 years and under
Boys 5/Girls 5	17 years and under
Men 1/Women 1	18 - 24 years inclusive
Men 2/Women 2	25 - 34 years inclusive
Men 3/Women 3	35 - 44 years inclusive
Men 4/Women 4	45 - 54 years inclusive
Men 5/Women 5	55 - 59 years inclusive
Men 6/Women 6	60 - 64 years inclusive
Men 7/Women 7	65 - 69 years inclusive
Men 8/Women 8	70 - 74 years inclusive
Men 9/Women 9	75 - 79 years inclusive
Men 10/Women 10	80 - 84 years inclusive
Men 11/Women 11	85 and over
<b>Elite Divisions</b>	
Open Men/Open Women	any age
Masters Men/Masters Women	35 and over

For Boys 1/Girls 1, only the Slalom and Tricks events may be scheduled, and overall scores will be determined from these two events.

For Boys 1-4/Girls 1-4, entry in these divisions is optional. Skiers in the younger divisions may elect to ski in any older division up to Boys or Girls 5 (including Jumping), and may be eligible for overall in that division if he skis all three events in that division.

As to qualification for Open Men, Open Women and Masters divisions, see Rule 3.03.

- B. At the option of the sponsoring affiliated club, one or more of the age divisions listed may be consolidated and/or divided into two or more groups, except as limited by Rule 3.01. This shall be noted in the tournament announcement.
- C. A foreign skier's division may be listed, which would allow a foreign skier to ski under the same conditions as he skis under in his home federation. It is up to the skier to provide proof of membership and conditions. This would be a separate division, and competitors therein would not compete with USA Water Ski members for placement.
- D. Except at Regionals and Nationals, skiers, upon proof of eligibility to try out in an event for any U.S. National Team, may be allowed to compete in that event

under IWWF Rules and conditions. The results and conditions must be so noted in the scorebook and these skiers will not compete for placement when conditions are advantageous.

E. Skiers must ski as same sex on their birth certificate.

### **3.03 Elite Division Competition**

A. Elite Divisions: There shall be two Elite Divisions of competition:

1. The Open Division may be entered by any skier of any age who is Open Qualified.
2. The Masters Division may be entered by any skier age 35 or greater who is Masters Qualified.

B. Open Qualification:

A skier of any age shall be ELIGIBLE to compete in the Open Division in an event (or in Overall) if his ranking score in any reported division for that event equals or exceeds the Level 9 Cutoff ranking score for that event on any date within the last twelve months.

C. Masters Qualification:

A skier age 35 or greater shall be ELIGIBLE to compete in the Masters Division in an event (or in Overall) if his ranking score in any reported division for that event equals or exceeds the Level 9 Cutoff ranking score for that event on any date within the last twelve months.

D. Duration:

Skiers will maintain their Level 9 Open or Masters qualification status if their ranking score in any reported division for that event equals or exceeds the Level 9 Cutoff ranking score for that event on any date within the past 12 months.

E. Elite Overall Provisions:

1. GENERAL: A skier having an OVERALL Elite qualification may compete in the Elite Division in any of the three events, even if an Elite qualification is not held for the individual event.
2. Skiers, who have an Elite ranking in Overall and wish to compete in Overall, may choose to ski in their age division or in their Elite division for Overall. A skier who is Open qualified in one or two events and also 35+(Masters) may ski for Overall in the Masters Division, if overall Masters qualified, as an age division skier as defined in rule 3.03F3 and 3.03F4. This applies ONLY to the Masters Division.
3. TOURNAMENTS WITH PLACEMENT: Skiers with a level 9 qualification in one or two events and skiing in a tournament with placement, such as Regional or National tournaments, and skiing for age division Overall may ski in the Elite division for placement and must also ski a second time in their age division event, for Overall score purposes only, if desiring to compete for age

division Overall placement. If skiing for Elite division Overall, skiers may ski in age division for placement in any event and, also ski a second time in the skiers' Elite division in that event for overall score purposes only.

4. TOURNAMENTS WITHOUT PLACEMENT: At all other tournaments, skiers must compete in the same division in all three events to attain an overall score. (see Rule 5.03B.)

F. Determination of Elite Cutoff Scores:

1. WHEN: The Open and Masters Cutoff ranking scores shall be determined each day, from the distributions of ranking scores in each event on that day.
2. OPEN CUTOFFS: The Open Cutoff ranking score for each event shall be the lowest ranking score in Level 9 as determined by the collection of skiers in that event with ranking scores in the M1, M2, and OM divisions for men and the W1, W2, and OW divisions for women.
3. MASTERS CUTOFFS: The Masters Cutoff ranking score for each event shall be the lowest ranking score in Level 9 of the collection of skiers in that event with ranking scores in the M3, M4 and MM divisions for men, and the W3, W4 and MW divisions for women.
4. GOVERNANCE: The percentile targets for Level 9 shall be set by the Skiers Qualification Committee in accordance with directives approved by the AWSA board.
5. DUAL RANKINGS: If a particular skier has rankings in more than one of the divisions in either of these collections for an event, that skier shall only be counted once for that collection, with the higher of those scores.

### **3.04 Scheduling of Divisions**

National and Regional Tournaments must schedule all of the above divisions.

Other sanctioned tournaments may schedule any or all divisions. The divisions to be scheduled at such tournaments, and whether or not skiers in excluded divisions will be allowed to ski with a scheduled division, shall be determined by the affiliated club sponsoring the tournament, and noted in the tournament announcement.

### **3.05 Scheduled Division Events**

A scheduled division event shall be held as long as one skier is entered and registered.

### **3.06 Performance Rankings**

Within each age division, each skier is ranked in each event and overall. The ability levels are 3 through 8 with 8 being the highest level in each age division. Level 9 are the elite ranking levels, as defined in Rule 3.03. The ranking list is continually updated.

Scores for inclusion in the ranking list may be obtained in any sanctioned tournament, in any of the first three rounds (see Rule 1.02), or first four rounds (see Rule 1.09C). Exceptions include certain instances in elimination-based competitions (see 13.02). A class F (Grass Roots) score above zero may be included in the Ranking calculations if it does not exceed the Level 5 Cut-Off Average from the previous Ski Year Rankings. Those class F scores which "exceed" the Level 5 Cut-Off Average from the previous Ski Year Rankings may be included but the score will be reduced to equal the Level 5-Cut Off Average for the purposes of inclusion in the Rankings calculations.

Scores for inclusion in the ranking list cannot be obtained in a run-off of a tie.

Performances accomplished at a multi-round tournament shall be credited as one tournament only.

## **RULE 4 - TOURNAMENT QUALIFICATION REQUIREMENTS**

### **4.01 General Qualifications**

- A. Event Qualification: A skier must be qualified in each event he enters.
- B. Membership: An entrant in a sanctioned tournament must be a USA-WSWS member with current dues paid. Each skier must be an Active member for Class C and higher tournaments. Grass Roots membership is the minimum requirement for all other tournament classifications. This requirement shall be considered satisfied if the skier pays his dues to the tournament committee before competing, and completes all required USA-WSWS application and membership documents.
- C. Tournament Qualification: For tournament qualification, the following are valid:
  - 1. Water Ski Athlete Performance Record card (signed by the required officials). Performance records issued by other IWWF-affiliated Federations are acceptable equivalents.
  - 2. Record of performance in official scorebooks of AWSA-sanctioned tournaments.
  - 3. Current Ranking List Average as listed on the National Ranking List on the USA-WSWS website.

## 4.02 National Tournament Qualifications

General: A contestant in the National Tournament must have competed in the corresponding event at his Regional Tournament (see Rules 4.03 and 4.06) during the same year. To have competed in an event at a Regional Tournament means to have attained skiing position in each event as defined in Rule 8.07. In addition, a contestant must qualify under Rules 4.02.A, 4.02.B, or 4.02.C (below) and must be a U.S. Citizen. Any skier competing in international competitions representing Guatemala, Costa Rica, Puerto Rico, Dominican Republic, Cuba, Ecuador, Bolivia, Panama, Paraguay, Uruguay and Venezuela with dual US citizenship would be exempt from rule 4.02.A and 4.03.A for the period of January 1, **2025** until December 31, **2025**. **See Rule 1.13.**

A skier who enters the Open division at the Nationals in any event is not required to ski in his Regional Tournament except if skiing for age division overall (See Rule 4.06).

If a Level 9 skier is qualified to ski in an Elite division at Regionals, the skier is then qualified to ski Nationals in that Elite division.

If the Appointed Judges at a Regional Tournament disqualify a skier for any reason listed under Rule 7.07, then the skier will not have met the requirement of skiing in the Regionals and thus would not be allowed to ski in the Nationals.

### A. Placement Qualifications:

1. The top five non-elite-qualified skiers in each age division or overall at the current year's Regionals or previous year's Nationals shall qualify for Nationals.
2. Events: For those qualified by placement in an event without a Level 8 ranking, scores from the current Regionals or immediate past Nationals must be above zero in the event.
3. Overall: For those qualified by placement in overall, scores for all events required for overall for the applicable division at the current Regionals or immediate past Nationals, must be above zero in all events unless there are scores on the current ranking list above zero in each event. (Also see 5.01-overall qualification)
4. The above qualifications from past National placements apply even if a skier changes divisions.
5. If more than one round of competition is held at a Regional Tournament, the scoring must still result in a single set of qualifiers for the National Tournament.

### B. Ranking List Qualifications: a skier may qualify for the National Tournament in any event or overall by being ranked Level 8 at the Cutoff Date, which is 3:00

a.m. Eastern Time on February 15 after the preceding National Tournament. Revised 8-8-23. The rankings average of the last ranked skier in level 8 at that time will be considered the Level 8 Cut Off Average for that event and division (See Ranking List Section of Website for specific details). A skier may also qualify for Nationals after the Cut Off Date by increasing his Ranking List Average above the Level 8 Cut Off Average for his respective event and division between the Cut Off Date and Nationals; or by attaining a score equal to or greater than the Level 8 Cut Off Average for his respective event and division at the Regional Tournament or at any class C or above event between the Cut-Off Date and the first day of Nationals or by being ranked Level 8 at any point between the Cut-Off Date and the first day of Nationals.

- C. Standards for Graduating Skiers who change divisions within the last 12 months: The rolling 12-month version of the National Ranking List will carry scores achieved in the prior division, into the skier's new age division, subject to the following special considerations:
1. Where the new Slalom division has a maximum speed equal to or faster than that of the original division -- the performance is carried into the new division at the same total buoy count.
  2. Where the new Slalom division has a maximum speed slower than that of the original performance -- the buoy count score carried into the new division will be reduced by 6 buoys if the score was achieved in a Class E, L, or R tournament (10.06.C).
  3. Where the new Jump division has a maximum speed slower or a maximum ramp height lower than the speed and/or ramp height of the actual performance accomplished in the original division -- the performance will not be carried into the rankings of the new age division.
- D. Only US Citizens may ski in the AWSA Nationals unless the LOC puts in a request for international skiers that meet the qualification requirements. This will be posted on the tournament announcement.

#### **4.03 Regional Tournament Qualifications**

- A. General: Each Region shall determine the required qualifications for its own Regional Tournament.
1. In any year, a skier shall be qualified to enter only one Regional Tournament for placement. A skier shall ski for placement in the Region where he does more than half of his tournament skiing during the ten weeks prior to the Regional Tournament, but has the option to return to his Region of legal residence to ski for placement.

2. If this rule is clearly inequitable, the Regional Executive Vice Presidents of the affected Regions may correct the situation at the request of the skier prior to July 16 immediately preceding Nationals. EVP's from the Regions involved must be in agreement.
  3. If the skier has not done more than half his skiing in the ten-week period in any single Region, he shall ski in the Region in which he has skied most. If a skier is in doubt as to the Region in which he is qualified to ski, he shall present all the facts to the Regional Executive Vice President in the Region in which he has legal residence prior to July 16<sup>th</sup> immediately preceding Nationals and the Regional Executive Vice President's decision shall be final. If there is any question regarding a particular skier's Region, the Executive Vice President is required to rule based on the legal residence of the skier. This may be accomplished with the information contained in the USA-WSWS membership database. A skier skiing "out of Region", based on the ten-week rule, may thereby satisfy the requirement to compete in a Regional Tournament to qualify for the National Tournament (Rule 4.02.A), and may ski for rankings only. He may not ski for Regional placement.
  4. All entrants in a Regional Tournament shall be U.S. citizens, unless the Region determines to allow non-US citizens (or resident aliens) to participate, but not for placement. See Rule 1.13.
- B. Excuses: A skier who is unable to compete in a Regional Tournament may be excused from the Regional Tournament provision of Rule 4.02.A for the following reasons:
1. AWSA Representatives: An individual, officially selected by the AWSA to represent the Association at an international competition on the same dates as his Regional Tournament, may be excused. This may be extended to include not only athletes but judges, scorers, drivers, delegates, and other officials.

In the case of minors, this may also be extended to include parents or legal guardians of same.

2. Other Excuses: The EVP may excuse a skier from this requirement if the skier provides proof, at least 48 hours prior to the start of the Regional Tournament, that he is confined to a full-facility hospital; is on extended military service; is on jury duty; is involved in an immediate family tragedy; or has suffered an injury or illness that precludes him from participating. The proof provided to the EVP must be sufficient to allow the EVP to make a fair and objective determination regarding the skier's ability to ski at the Regional Tournament. If the skier does not provide sufficient documentation (e.g., hospital admittance form, jury duty notice, etc.) within the stated time frame, the skier must appear before the EVP at the Regional Tournament, prior to the skier's scheduled event, at which time



the EVP will make a determination as to the skier's ability to ski in the tournament. The EVP may excuse a skier for reasons other than those listed above, and with less than 48 hours notice, under extraordinary circumstances. An EVP's approved excuse may only be granted for events a skier is qualified to compete in at Nationals. Any skier misrepresenting his situation to the EVP shall be precluded from skiing in the National Tournament for the current year.

#### **4.04 U.S. Open Qualifications** (Rule deleted 2019)

#### **4.05 Other Tournament Qualifications**

The sponsoring affiliated club shall determine the required qualification standards for its tournament.

#### **4.06 Event and Division Limitations**

The division that a skier competes in at the Regional Tournament in any event shall be the division that said skier competes in, in the same event, at the National Tournament except that a skier not currently qualified may qualify for the Open or Masters division of the Nationals by meeting the requirements for that division at or after the Regional Tournament.

### **RULE 5 - OVERALL AND TEAM COMPETITION**

#### **5.01 Overall Qualification**

To be considered for overall standings, a contestant must be qualified for, entered in, and attain skiing position in all three events, except Boys 1/Girls 1 where overall is based on only two events and for divisions 8 and up the skier may use scores from ANY two events or all three events towards the overall title.

#### **5.02 Overall Placement**

Places in the overall championship shall be determined by adding each contestant's overall points in the three events (except Boys 1/Girls 1, as noted above).

An age division overall score can include an Elite score provided the score does not exceed the division's parameters (speed or ramp height). At Regional and National tournaments, or other tournaments with placement, skiers with an Elite event ranking may obtain a division overall score only by skiing a second time in that division's event for overall scoring purposes only.

### 5.03 Overall Scoring

- A. In scoring for overall positions within each division, each competitor shall receive a NOPS (Normalized Overall Performance Score) for each event, calculated from his performance in that event, relative to standards for that specific division and event, using a smooth curved mathematical fit to those standards.
1. The standards for each division and event shall be set annually by the Skier's Qualification Committee, based on the distribution of scores for the skiers in that particular division and event, over the preceding 12-month period.
  2. The smooth curved function for each division and event shall be formulated such that:
    - a. In slalom and tricks, a raw event score of zero will produce a NOPS score of zero.
    - b. In jumping, a raw event score of less than 15% of the National Record Jump Score for that division will produce a NOPS score of zero.
    - c. A raw event score that equals the Median (50th percentile ranking) score for that division and event shall receive a NOPS score of exactly 500 points.
    - d. A raw event score that equals the National Record score for that division and event shall receive a NOPS score of exactly 1500 points.
    - e. The smooth curved function for each division and event shall be based on the ratio of the skier's raw performance score in that division and event, divided by the standard score for that division and event, with that ratio raised to a specified power. The specified power values for each division and event shall be computed to best fit provisions a-d above.
  3. The Skier's Qualification Committee shall annually publish a table of the NOPS standards, and the associated computational formulas and power factors, for each division and event for the next ski year.
- B. 1,000 Point Overall Standard: For other than the National and Regional Tournaments, the following overall scoring may be used. At the option of the sponsoring affiliated club, the highest scoring three-event skier (or the highest scoring team-affiliated skier, if the tournament includes team competition) in each event shall be awarded 1,000 points for overall. If this option is used, it shall be noted in the tournament announcement. Each remaining contestant in the Slalom and Tricks events shall receive points in the proportion that his score bears to the winner's score. For example, a trick skier receiving a total of 1,130 points compared with the winner's 2,560 would be entitled to  $(1,130/2,560) \times 1,000$ , or 441 points toward overall. Each remaining

contestant in the Jumping event shall receive points in the proportion that the square of his score bears to the square of the winner's score. For example, a jumper receiving a total of 130 points compared with the winner's 150 would be entitled to  $[(130 \times 130)/(150 \times 150)] \times 1,000$ , or 751 points toward overall.

All three performances for an overall score shall be achieved in the same division and must be performed in the same round of a multi-round tournament (i.e., first time skied in a division per event = Round #1, second time skied in a division per event = Round #2, etc.). An exception would be an Elite qualified skier who is using rule 3.03F options for overall score.

Run-offs of ties are used solely to determine placement in an event and are not used for any other purpose such as scoring overall, setting records or inclusion in ranking list.

#### **5.04 Team Scoring** (Rule deleted 2019)

### **RULE 6 - OFFICIALS**

#### **6.01 National Tournament**

- A. The Chief Judge and Assistant Chief Judges shall be three-event Senior **(J2)** Judges appointed by the AWSA President.
- B. Other Appointed Judges (with equal representation from each region) shall be three-event Senior **(J2)** Judges appointed by the Regional Executive Vice President with approval of the Regional Council.
- C. Event judges shall be chosen by the Chief Judge from among the Appointed and Assigned Judges. When the Appointed and Assigned Judges are not available as event judges, the Chief Judge may choose other Senior **(J2)** or Regular **(J3)** Judges as event judges. In all events, the majority of the event judges must be Senior **(J2)** Judges unless the event is Class R, which requires all judges to be Senior **(J2)** Judges.
- D. The Chief Boat Driver shall be a three-event Senior **(D2)** Driver appointed by the AWSA President.
- E. Boat Drivers (with equal representation from each region) shall be two and three-event Senior **(D2)** Boat Drivers appointed by the Regional Executive Vice President with the approval of the Regional Council. Each Region shall appoint at least one three-event driver.

Additional drivers shall be chosen by the AWSA President at his discretion from alternate drivers proposed by the Executive Vice Presidents. When an adequate number of Appointed Drivers and Alternate Drivers are not available, the Chief Driver may choose other Senior **(D2)** two or three-event Drivers to drive an event. For the Open division only, non-appointed drivers

may be used, at the discretion of the Chief Driver, in consultation with the LOC, and with the approval of the AWSA President.

- F. The Chief Scorer shall be a three-event Senior **(S2)** Scorer appointed by the AWSA President. Assistant Chief Scorers with a three-event Senior **(S2)** Scorer's rating may also be appointed.
- G. Scorers (with equal representation from each region) shall be three-event Senior **(S2)** Scorers appointed by the Regional Executive Vice President with the approval of the Regional Council. Event scorers shall be chosen by the Chief Scorer from the Appointed Scorers. When the Appointed Scorers are not available as event scorers, the Chief Scorer may choose other Senior **(S2)** Scorers or Regular **(S3)** Scorers as event scorers, with the approval of the Chief Judge.
- H. The Chief Safety Director shall be a National Safety Director appointed by the AWSA President. Assistant Chief Safety Directors with a National or Regional Safety Director rating may be appointed by the AWSA President. Other safety personnel, with a minimum rating of State Safety Director, may be chosen by the Chief Safety Director.
- I. The Chief Technical Controller shall be appointed by the AWSA President. Assistant Chief Technical Controllers may also be appointed.
- J. In addition to Chief and Assistant Chief officials, the following are recommended quantities of officials for National Tournament sites.
  - 1. Four lakes, per Region: 5 judges - 2 Appointed, 3 Assigned; 2 drivers; 2 scorers.
  - 2. Three lakes, per Region: 4 judges - 2 Appointed, 2 Assigned; 2 drivers; 2 scorers
  - 3. Two lakes, per Region: 2 Judges, both Appointed, 1 driver; 1 scorer.

It is also recommended for the National Tournament LOC to appoint 1 safety director, 1 technical controller and 1 announcer per lake.

## **6.02 Regional Tournaments**

- A. The Chief Judge shall be a three-event Senior **(J2)** Judge appointed by the Regional Executive Vice President with approval of the Regional Council. Assistant Chief Judges with a three-event Senior **(J2)** or Regular **(J3)** Judge rating may also be appointed.
- B. Five three-event Appointed Judges (Senior **(J2)** or Regular **(J3)**) shall be appointed by the Regional Executive Vice President with the approval of the Regional Council.

- C. Event judges shall be chosen by the Chief Judge from among the Appointed Judges or other Senior **(J2)** or Regular **(J3)** Judges in attendance at the tournament.
- D. The Chief Boat Driver shall be a three-event Senior **(D2)** Driver appointed by the Regional Executive Vice President with the approval of the Regional Council. Assistants with three-event Senior **(D2)** or Regular **(D3)** Driver's ratings may also be appointed. Event Drivers shall be chosen by the Chief Boat Driver from the Appointed Drivers, or other Senior **(D2)** or Regular **(D3)** Drivers, subject to the approval of the Chief Judge.
- E. The Chief Scorer shall be a three-event Senior **(S2)** Scorer appointed by the Regional Executive Vice President with the approval of the Regional Council. Assistant Chief Scorers with a three-event Senior **(S2)** or Regular **(S3)** Scorer's rating may also be appointed. Other scorers, with a Senior **(S2)** or Regular **(S3)** Scorer's rating, may be selected by the Chief Scorer from those in attendance at the tournament, with the approval of the Chief Judge. Where there is a shortage of Regular **(S3)** and Senior **(S2)** Scorers, an Assistant **(S3)** Scorer may work under the supervision of a Senior **(S2)** or Regular **(S3)** Scorer.
- F. The Chief Safety Director shall be a Regional Safety Director appointed by the Regional Executive Vice President with the approval of the Regional Council. Assistant Chief Safety Directors, with a minimum rating of Regional Safety Director, may also be appointed. Other safety personnel, with a minimum rating of State Safety Director, may be chosen by the Chief Safety Director.
- G. The Chief Technical Controller shall be appointed by the LOC with the approval of the Regional Executive Vice President. Assistant Chief Technical Controllers may also be appointed.

### **6.03 Other Tournaments**

- A. A Chief Judge and at least two other judges (all Senior **(J2)** or Regular **(J3)** in the events being held) shall be appointed by the sponsoring affiliated club with the approval of the Regional Executive Vice President. An Assistant Chief Judge, holding not less than an Assistant **(J4)** Judge's rating, may also be appointed.
- B. The event judges shall be chosen by the Chief Judge from among the Appointed Judges or other judges in attendance at the tournament holding not less than an Assistant **(J4)** Judge's rating or a judge's rating from a federation affiliated with the IWWF. It is recommended that, insofar as practical, the Chief Judge select event judges from among the most capable judges available.
- C. A Chief Boat Driver (with Senior **(D2)** or Regular **(D3)** rating) shall, and the necessary assistants, may be appointed by the sponsoring club with the approval of the Regional Executive Vice President.

Event drivers shall be chosen by the Chief Boat Driver from the Appointed Drivers, or other Senior **(D2)**, Regular **(D3)**, or Assistant **(D4)** Drivers available, subject to the approval of the Chief Judge. It is recommended that the Chief Boat Driver select event drivers from the most capable drivers available.

In areas where no Senior **(D2)** or Regular **(D3)** Drivers are available, the sponsoring club of a Class C tournament or below may appoint Assistant **(D4)** Drivers as event drivers (with the approval of the Regional Executive Vice President), in which case the Chief Judge will assume the duties of the Chief Boat Driver.

- D. A Chief Scorer (with Senior **(S2)** or Regular **(S3)** rating) shall be appointed by the sponsoring affiliated club with the approval of the Regional Executive Vice President.

In areas where no Senior **(S2)** or Regular **(S3)** Scorers are available, the sponsoring club of a Class C tournament may appoint an Assistant **(S4)** Scorer as Chief Scorer (with the approval of the Regional Executive Vice President), under the supervision of the Chief Judge.

Event Scorers shall be selected by the Chief Scorer from other scorers in attendance at the tournament subject to the approval of the Chief Judge.

- E. At Class C tournaments or Class C portions of mixed-class tournaments:
1. The chief officials shall preferably be separate officials.
  2. An official (Chief Judge, Driver and Scorer) may co-chief (both officials simultaneously on site) with an official who is currently rated for those events to satisfy the requirements for advancement to Senior **(J2)** Judge.

- F. A Class F (Grass Roots) tournament may be limited to an Assistant **(J4)** Judge, an Assistant **(D4)** Driver, and a State Safety Director. To add jumping to a Class F (Grass Roots) classification, a minimum of a State Safety director and Regular **(D3)** Driver is required.

- G. A Chief Safety Director, with a minimum rating of State Safety Director, shall be appointed by the sponsoring affiliated club with the approval of the Regional Executive Vice President. An Assistant Chief Safety Director may also be appointed. The Assistant Chief Safety Director and other safety personnel may be aspiring State Safety Directors.

- H. For Record Capability tournaments, a Technical Controller shall be appointed by the sponsoring affiliated club with the approval of the Regional Executive Vice President. For all computer operations involving video jump distance measurement or frame count trick timing, a rated Technical Controller shall be considered fully qualified to operate the computer while working with an

appropriately rated judge. (**see 15.04A**)

I. Judging for all events must be performed on the tournament site.

#### **6.04 Secondary Personnel**

Personnel to fill secondary positions shall be selected by the Chief Judge from other rated judges or USA-WSWS insured members who desire training in tournament work.

#### **6.05 Disagreement**

In any disagreement among judges, the majority rules, and all issues shall be settled before the next contestant starts.

#### **6.06 Inspection of Forms**

The scoring of each judge shall be made available for inspection as soon as possible, but not later than the end of the tournament.

#### **6.07 Separation of Judges**

Judges shall be separated to ensure completely independent opinions. Where it is not feasible for judges to be separated, judges' positions shall be designated by the Chief Judge.

#### **6.08 Changes in Scoring Forms**

Any changes in scoring forms must be approved by the Chief Judge once the results of that event have been posted. A judge may not change his scoring form more than 30 minutes after the results of the event are posted. The results of a day's last event on each lake may be posted at the beginning of the next day (except for the final day). In this manner, the Chief Judge can comply with the rules while all those concerned have a fair opportunity to verify their results.

#### **6.09 Changing Officials**

At the discretion of the Chief Judge, any or all officials may be changed during a large Slalom or Jumping event. The event may be divided into groups to accommodate officials changing, although no such group shall have fewer than 10 skiers. Under exceptional circumstances, the Chief Judge may change any official at any point during an event.

The Chief Judge may decide to use two boats and boat crews in the same event in an alternating manner. Alternating manner shall mean the next available towboat will be used for each successive skier. See Rules 8.02.D, 8.02.E, and 8.02.F.

## 6.10 Defining Judge, Scorer, and Driver

The term "Judge", "Scorer", and "Driver" refers to an official with a Senior, Regular or Assistant Judge, Scorer, or Driver rating or any equivalent or higher rating (**see chart below, example J2 or higher**). Other federations' or confederations' judges', scorers', and drivers' ratings are equated to those of AWSA as noted in the IWWF Rule Book for use in assigning tournament personnel and may be used in the same capacity in an AWSA tournament if they have a USA-WSWS membership and have completed any additional training.

<b>AWSA Official</b>	<b>AWSA Class</b>
PanAm J1/S1/D1/H1	All AWSA and IWWF
Senior J2/S2/D2/H2	C, E, L & R
Regular J3/S3/D3/ <b>H3</b>	C, E, L
Assistant J4/S4/D4	C

## 6.11 Judge, Scorer & Driver Emeritus

A Senior (**J2**) Judge Emeritus or Senior (**S2**) Scorer Emeritus or Senior (**D2**) Driver Emeritus may officiate in a Class C or lower tournament, including serving as the Chief Official. In addition, a Senior (**J2**) Judge Emeritus may serve as an equivalent of an assistant (**J4**) judge in a Class E tournament.

## 6.12 Multi-Round Tournaments

Officiating duties accomplished at a multi-round tournament shall be credited as one tournament only.

## 6.13 Chief and Appointed Officials

A. Chief and appointed officials for any tournament shall hold the required rating level for all events that are scheduled in that tournament, and these officials shall remain available in person on the site throughout the entire event(s) for which they serve.

B. If a tournament is sanctioned for more than 5 days the appointed officials may be split. This change in appointed officials must be announced in the tournament announcement at least 30 days prior to the start of the tournament.

C. A Class C tournament may have different Chief Officials for each individual or multiple events.

## **RULE 7 - RERIDES, PROTESTS AND DISQUALIFICATION**

### 7.01 Unfair Conditions

When unfair conditions or a malfunction of tournament committee-supplied equipment occurs, which, in the opinion of a majority of the event judges adversely affects a contestant, he shall be granted the option of a reride only on the passes affected. In the case of a malfunction of committee-supplied equipment or if there



should be fast slalom times, slow jump times, or short trick times, then, if such an optional reride is taken, the official score shall be the better of the reride score or the score obtained on the original adversely affected pass(es). In all other instances if the reride is taken, the result of the reride is the official score (unless 8.10F applies).

When a condition gives a contestant an unfair advantage, a reride is mandatory, and the result of that reride shall become the official score.

### **7.02 Reride Time Limits**

A reride must be taken no later than five minutes after being granted, and may be taken immediately at the option of the contestant (see Rule 9.10 for Jumping rerides, Rule 10.10 for Slalom rerides, and Rule 11.10 for Tricks rerides). If the contestant elects to take a five-minute rest, the next contestant in order shall ski, and the reride shall be taken at the conclusion of the skier's run during which the five-minute rest period expires.

### **7.03 Requests for Rerides**

A request for a reride may be initiated by a judge for the event before the next contestant starts or may be initiated, as soon as possible, by the contestant or his representative. In either case, the reride shall be decided upon before any further contestants start. If, in the opinion of the judges for the event, the request was not initiated as soon as possible after the contestant skied, the request shall be denied.

### **7.04 Protest Procedure**

Protests shall be made to the Chief Judge and shall be considered by the Appointed Judges. Protests must be in writing, give the reason for the protest, be signed by the contestant, and be filed no later than 30 minutes after the results of the event are posted and the judges' scoring forms are available for inspection. If there is a tie vote of the appointed judges on a protest resolution, the Chief Judge shall break the tie.

### **7.05 Protests**

Protests shall be considered only for failure of the tournament committee or the officials to comply with these rules. No protest shall ever be considered on judgment decisions by the judges except as noted in 10.08E and 11.09D which are considered challenges.

### **7.06 Posting Scores and Correcting Scoring Errors**

A. Official posting of scores:

1. During hours of actual competition, official results will only be those on paper signed by the Chief Scorer and posted at a designated location at

the competition venue. All other versions/postings of the results are unofficial.

2. Two hours after each event's results are posted, they are considered final (also see 7.06.B.2 below). Should corrections be made within that two-hour window, the revised posting time will be noted on the revision, and another two-hour review period will begin. The results of a day's last event on each lake may be posted at the beginning of the next day (except for the final day). In this manner, the Chief Judge can comply with the rules while all those concerned have a fair opportunity to verify their results.
3. If no corrections are made within two hours, the results become official.
4. Upon completion of the tournament, the paper results will be converted into an electronic format and made available on the official USA Water Ski website. These will then be considered the official results.
5. If a discrepancy is discovered between the posting of the paper results on site and the post-tournament electronic posting, the Chief Judge and Chief Scorer will review the matter and update the electronic edition as needed.

#### B. Correcting scoring errors

1. A correction of an error in the computation of scores will not be considered a protest.
2. Such correction will be made upon the approval of the Chief Judge and the Chief Scorer if requested within two hours after the results of the event have been posted according to 7.06.A.2 above and the judge's scoring forms made available for inspection.
3. Correction of scores on the Ranking List only:
  - a. Such changes will be made with the approval of the Chief Scorer and Chief Judge provided the error change was initiated within seven days of inclusion in the Ranking List.
  - b. This seven-day limitation will only apply to changes in the score value. Corrections of errors in competitor identity, age division, or tournament format will be made whenever identified and verified by the Regional Seeding Representative and Executive Vice President.
  - c. Such a change will not affect the official tournament results or placements.

## **7.07 Disqualification**

- A. General: Disqualification is the most severe penalty that a skier may receive in competition. When disqualified, a skier is barred from continued participation in the tournament in all rounds and all events and is ineligible for placement in any event or overall. Any scores recorded prior to the skier's disqualification shall be removed from the scorebook, and the scorebook shall be amended to reflect the skier's status as disqualified. Any skier who is disqualified at a Regional Tournament shall be ineligible to enter and compete in the National Tournament.
- B. Disqualification Procedures: Contestants may be disqualified by a two-thirds majority vote of the Appointed Judges for any one of the reasons listed in Sections C-F below. The Chief Judge shall submit a written report to the AWSA Board of Directors regarding any such disqualification.
- C. Cheating: A skier shall be subject to disqualification procedures if he (or his representative) willfully violates the rules to gain an unfair advantage in competition. This shall include misrepresentation of age or ranking. Handle lengths that are found to be out of tolerance after a skier's performance shall not be considered a willful violation of the rules or a cause for disqualification. (See Rule 10.16.B.2.b regarding slalom handles out of tolerance.)
- D. Unsportsmanlike Conduct: Any contestant (or his representative) or official whose conduct is deemed unsportsmanlike or whose conduct may cause discredit to USA-WSWS, either on or off the tournament site before, during, or after the tournament, may be disqualified from participation in the tournament.
- E. Under the Influence of a Mind-Altering Substance: Being under the influence of alcohol, drugs, or any other mind-altering substance, or if his participation would be a danger to himself or others, subjects a competitor to disqualification procedures.
- F. Threatening a tournament official: Making or implying a threat to an official, whether physical, verbal, legal, or otherwise, is grounds for disqualification. If the person making threats is a skier's representative, the represented skier shall be disqualified. Threats made before, during, or after a tournament could subject the person(s) involved to disqualification procedures.

## **7.08 Tournament Review-Escalation Process**

After the completion of a tournament, if information regarding any conduct during a tournament is raised within 30 days, that concern or issue shall be reported directly to the Chief Judge of the tournament and the Regional EVP. The Chief

Judge in consultation with the Appointed Judges shall review the issue and take appropriate action within 10 days, and inform the Regional EVP of actions taken.

The Regional EVP including the Regional Council and Regional AWSA Directors shall review the issue and take appropriate action within 15 days by responding in writing to the individual who raised the issue and copying the AWSA President, along with the Pan Am Water Ski representative for AWSA if applicable.

The AWSA President can accept the findings of the Regional Council as final or appoint a special committee to review the findings or Council Report and recommend a course of action for vote by the AWSA Board of Directors.

Actions, at any review level, may include disallowing affected scores, events or the entire competition may be withheld from the ranking lists and/or the sanction for the entire tournament may be downgraded.

The intention of this rule is to assure that appropriate standards of conduct are maintained at tournaments and to assure that only performances conducted using appropriate standards are included in any ranking list. Conduct encountered at a tournament which is in violation of the rules under which the tournament was conducted shall not be tolerated.

This procedure may also be initiated by the Chief Judge of the tournament, the applicable Regional EVP, AWSA President, Chair of the AWSA Rules Committee, the Chair of AWSA Technical Committee, Chair of AWSA Judges & Scorers Committee, or Chair of AWSA Drivers Committee. The process outlined above begins with the Chief Judge and Regional EVP unless they are the subject of the issue or conduct, in which case the first level of review shall escalate to the next level.

It is incumbent upon the person alleging any failure to follow the rules to first personally complete due diligence to assure that the correct rules are considered before filing any complaint. Failure to comply can result in discipline to a member who files complaints that are not accurate as determined by Council, BOD or AWSA President.

## **RULE 8 - EQUIPMENT AND DEFINITIONS**

### **8.01 Competition Area**

The suggested tournament layout is shown in the Slalom, Jumping, and Tricks Diagrams contained in the Appendix. Courses' dimensions shall be as indicated. However, the layout of the competitive area may be varied to suit the tournament site. No buoys or markers other than those indicated by the official course diagrams are permitted within the competition area, except safety hazard or turning point markers, boat path alignment buoys, or video jump distance buoys (See 9.02). Any such additional buoys shall be distinguishable from tournament buoys and shall be pointed out to skiers at the start of the competition.

Dimensions and Tolerances: Metric dimensions, when given, are official. Accompanying notations stated in feet and inches or pounds are approximate and are provided as a convenience only. Tolerances on dimensions are to allow for uncontrollable site variations and human error only. See Rule 1.12

When courses overlap, buoys from the unused course that may cause confusion or a safety hazard shall be removed.

## **8.02 Boats**

- A. General: All tournaments, Class C and higher, are required to use only AWSA-Approved Tournament Towboats. Contact USA-WSWS Headquarters for approval requirements and details as set forth in the AWSA Towboat Manual.
- B.
  - 1. Added Weight: It is the duty of the boat judge, in consultation with the driver, to supervise adding a suitable weight in any event in the passenger compartment, side to side to even out boat balance, wakes, spray, or handling. In addition, weight not exceeding 50 lbs. may be added to the bow of the boat for purposes of leveling the boat. Any added weight shall not present a hazard to the boat occupants or potentially damage the boat's interior.
  - 2. For tricks, the skier may place a tournament-supplied weight of between 20-50 kg (44-110 pounds) in the boat (either on the floor by the feet of the release operator or behind the engine cover) with side to side positioning as decided by the skier or release operator.
  - 3. For tricks if equipped, the ballast system starting level may be chosen by the skier (0%, 25%, 50%, 75%, or 100%). The skier may select +/- 50% for his second pass based on his first pass selection. The LOC along with the CJ may set a maximum upper ballast level. If so, the skier may not exceed that limit when selecting a second pass change. See rules interpretations and Allowable Boat Adjustment Chart for newest guidelines.
- C. Boat Availability: Any boat that is to be used in the tournament shall remain available until the end of the tournament unless released by the Chief Judge. Only designated persons may occupy official towboats during competition.
- D. Boat Selection: For the National and U.S. Open Tournaments, the selection of boats and the assignment of boats to specific events shall be made by USA-WSWS Headquarters. National Towboat selection shall occur no later than July 1st. For Regionals, USA-WSWS Headquarters shall make the selection of boats, and the assignment shall be made by the Chief Judge and the Chief Boat Driver. At all other tournaments, the selection of towboats shall be made by the Chief Boat Driver, with the approval of the Chief Judge.
- E. Boat Use in Each Event: The same driver and boat shall be used by all

contestants in each Slalom and Jumping event. However, in cases where two drivers of similar abilities and two boats of the same model, manufacturer and engine size are available, the Chief Judge may decide to use two drivers and two boats in the same event in an alternating manner. Alternating manner shall mean the next available towboat will be used. However, in Jumping and Slalom tie run-offs, only one boat and driver shall be used. For the tricks event, the skier may select a boat from any of the designated towboats, and multiple teams of drivers and boat officials may be assigned to the Tricks event at the option of the Chief Judge.

F. Towboat Breakdown: When a towboat breakdown occurs, the Chief Driver with the concurrence of the Chief Judge may select a similar towboat to complete the event. For the purpose of towboat malfunction, "similar" shall mean an AWSA-approved tournament towboat of the same power and design. For Regionals, Nationals and Cash Prize tournaments, any substitute towboat shall be of the same model and manufacturer. However, when running dual boats, the event may be continued with one boat, or if substitution is necessary, the two boats continuing the event must be of the same model and manufacturer.

G. Reference Appendix for Boat Manufacturers Specific's.

### 8.03 Skis

All skis regardless of the tournament classification shall be in accordance with IWWF Rule 5.08.

A. Slalom and Jump ski maximum width shall not exceed 30% of length. Trick/Jump skis within the 30% maximum width may be used in the slalom event.

B. Trick ski maximum width shall not exceed 35% of length.

C. Attaching two separate skis together in any manner is prohibited in all classes.

### 8.04 Tow Lines

The Tournament Committee shall furnish tow lines that meet the specification in IWWF Rule 5.09. For Slalom Light lines, reference Rule 10.16B.

It is the responsibility of the Tow Line manufacturers to ensure their product meets specifications per IWWF Rule 5.09 for towlines and IWWF Rule 5.11 for handles. Reference Rule 10.16B for Light lines.

## **8.05 Boat Speeds**

All speeds are “speeds over the bottom”; compensate in all cases where a current exists. The boat path in all events is intended to be a straight line, run at a constant speed. Variation in speed during any pass may not exceed  $\pm .8$  kph (.5 mph), except during the second segment in the jump course when using the optional faster second segment option. In the Slalom and Jumping events, the recorded times through the timing segments must also be within the applicable tolerances. (See Rules 9.06, 9.17, 10.06, 10.17, and 11.06, and the Timing Tolerances Tables.)

## **8.06 A Fall**

A fall in any event is when any one of the following occurs:

- A. The skier loses possession of the tow line (except as noted in Rules 9.11, 10.11 and 11.11); or
- B. The skier does not have at least one ski on one foot; or
- C. The weight of the skier is not primarily supported by his ski or skis, and in addition the skier is unable ultimately to regain skiing position.

If the skier does not lose possession of the tow line, has at least one ski on at all times, and ultimately regains skiing position, there has been no fall.

## **8.07 Skiing Position**

Skiing position is defined as that position in which all of the following exist:

- A. The skier has possession of the tow line; and
- B. The skier is riding forward or backward on the water with a ski or skis on his feet; and
- C. The weight of the skier is supported by his ski or skis or the skier is ultimately able to regain control.

## **8.08 The Wake**

In the application of rules where the wake plays a major role in the decision-making process, “the wake” is to be considered as the area of water disturbed by the passage of the towboat, lying at the rope’s length between and inclusive of the outermost waves. The crest of the wave is the nominal boundary of the wake. With some waves there is a curl that identifies the crest, but if the wave is rounded, the crest is determined as the point where the wave takes a downturn to the outside of the wake.

## 8.09 Buoys

- A. Buoys must have provisions for attaching anchor lines, and must be fastened by means of a tensioning device.
- B. All buoy specifications shall be per IWWF Rule 8.07.
  1. Boat guide buoys may be spherical, cylindrical, or bullet-shaped. Spherical buoys 9" (23cm) are recommended, with the height out of the water 4.5" (11.5cm) also recommended. Non-spherical cylindrical buoys are recommended to be 6-8" exposed above the water. For Boat path alignment gates, green is recommended. Jump boat guides should be per the Appendix. Slalom boat guides (excluding pre gates) are yellow.
  2. Gate buoys 7.8" (20cm) are recommended with the height out of the water 3.9" (11.5cm) also recommended. The color should be orange/red with orange recommended. Gate buoys shall be provided with an elastic device (recommend minimum length 18" for elastic between line and buoy). This will allow the gate buoys to rise and fall under tension with the passage of the wake for judging the gates.
  3. Skier buoys 7.8" (20cm) are recommended with height out of the water 3.35" to 3.9" (8.5-9cm) also recommended. A line or mark on the buoy at the 8cm limit is also recommended so that it can be easily determined that the buoy height is in tolerance. The color should be orange/red with orange recommended.

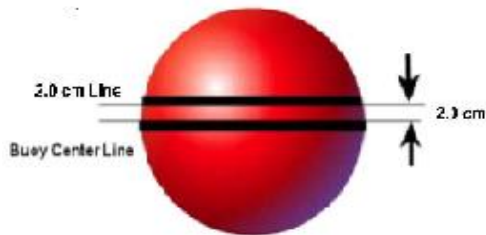

## 8.10 Speed Control

- A. All tournaments Class C and above are required to use speed control.
- B. The principal job of the speed control is to provide independence from the manual operator and to give speeds as close as possible to the ideal times.
- C. The boat judge and driver shall jointly agree on the setting of the speed control and the allowed adjustments, with the goal of having the device produce ideal times for each pass. If agreement cannot be reached the Chief Judge, or his designee, shall make the decision.
- D. A table showing the allowed ranges for all adjustable speed control parameters, and the circumstances under which each of these may be changed, and by whom, is provided in the Appendix.
- E. If the speed control unit becomes inoperable and cannot be quickly repaired,



and a replacement boat or unit is not available, the tournament shall be continued with manual driving and timing in compliance with timing tolerances.

- F. When the speed control cuts out or fails to operate properly or there is otherwise a deviation from normal operation (i.e., a malfunction), the skier is entitled to a reride for failure of tournament-supplied equipment (See 7.01, 9.10 and 10.10B4). If the time is out of tolerance due to a malfunction of tournament supplied equipment the skier may accept the highest score with a good time or receive an optional reride with a protected score equal to the highest score with a good time (See rule 10.10B4). If the skier supplies his own 80# jump switch, then the skier shall accept responsibility for any malfunction of the switch, including malfunctions that produce an out of tolerance time. When a malfunction results in a fast time and the skier is at maximum speed, the jump shall be scored as a pass. When a malfunction results in either a slow time or a fast time and the skier is below maximum speed, the skier shall accept the distance as his score, with no option of a reride.
- G. Tournaments are only allowed to use speed control devices tested in conjunction with the towboats approved for use by the Towboat Committee. Approved towboats, including equipment as tested, are listed on the USA-WSWS website under the Towboat section.
- H. Software changes are permitted as approved by the Towboat Committee at any time during the season, except that no changes that affect skier pull will be permitted between July 1 and the conclusion of that year's National Tournament.

## **RULE 9 - JUMPING**

### **9.01 General**

Each contestant shall be allowed three passes through the jump course. Any contestant who fails to be on immediate hand and in condition to ski when the boat is ready for the contestant shall not be allowed to ski in that round of the event. However, the Chief Judge or his designee, may grant up to three additional minutes for emergencies developing or discovered just prior to the contestant's turn to ski (e.g., ripped binding). In the case where a skier has been disqualified or has scratched, a one-minute delay shall be granted to the next skier in the starting order. If more than one skier has been disqualified or has scratched, the time allotted to the next skier shall be one minute for each skier disqualified or scratched.

### **9.02 Jump Course**

The jump course begins with the 180-meter cut-out buoy and ends with the 100-meter end-course buoys as shown in the Official Jump Course Diagram in the Appendix. Buoy specifications are presented in Rule 8.09. No obstructions or marker buoys (used for video distance measurement or spectator reference buoys) shall be within 8m from the ramp centerline for safety purposes so that they will not interfere with the skier while landing.

### **9.03 Pass or Jump**

- A. A pass or jump shall be registered when a skier, in skiing position, passes the 180-meter buoy marking the beginning of the jump course (see Official Jump Course Diagram in Appendix), except when, in the opinion of the boat driver or boat judge, there is a hazard because of rough water, interference of another boat or other reasons. In this case the boat driver or boat judge shall hold up his hand and slow the boat a perceptible amount before the boat passes the ramp.
- B. A pass shall also be registered if a skier falls within or outside the course, or if the reason for a handle throw is not acceptable to the judges (Rule 9.11).
- C. A jump shall be scored when a skier passes over the ramp, lands, and skis away with a tight line in skiing position without falling. If a skier falls as a result of a jump, he loses that jump. If he shall purposely touch any part of the tow line other than the handle while in the air, he shall receive no score for that jump.
- D. A pass is defined as the movement of the boat by and parallel to the ramp, regardless of what the skier does. A balk occurs when the skier refuses the ramp by either skiing to the left of the ramp and releasing the handle or by following the boat past the ramp while holding on to the rope. A skier shall receive no further jumps in a round if, after leaving the boat's wake on a

definite cut to the ramp, the skier elects to pass between the boat course and the ramp, whether or not he retains the tow line. A judgment decision is required by a majority of the Event judges as to whether the cut is "definite".

- E. The outcome of each attempt shall be communicated to the skier, including the distance and any reride possibilities, before the boat proceeds to any subsequent attempt by the same skier.

#### **9.04 Falls**

- A. Definition: See Rules 8.06 and 8.07.
- B. A fall within or outside the jump course shall be registered as a pass.
- C. In the event of a fall, if the skier is not on his skis within three minutes from the time the towboat returns to pick him up, he shall receive no further jumps.
- D. If damaged equipment is involved, see Rule 9.15.

#### **9.05 Boat Selection**

See Rules 8.02.D, 8.02.E, and 8.02.F.

#### **9.06 Boat Speed**

The boat speed for each attempt shall be chosen by the skier from those listed in the table in the Appendix, up to the maximums listed below. Skiers may choose to go slower than the speeds listed in the Appendix, in which case the times will not be required. In addition, the skier shall be given a choice of having the speed control deliver a faster speed throughout the 41m segment, or having the speed control return to the baseline (RTB) speed for the 41m segment. The speed control shall be engaged before the 180m (590 foot) buoy. The driver shall not deviate the boat speed in an attempt to aid the skier's landing in order to ride out the jump.

- A. Open Men, Masters Men, Men 1, 2, 3: 57 kph /35.4 mph
- B. Open Women, Women 1, 2, Men 4: 54 kph/ 33.6 mph
- C. Masters Women, Women 3, 4, 5, 6; Men 5, 6, 7, 8; Boys 4 & 5; Girls 4 & 5: 51 kph/31.7 mph
- D. Women 7, Men 9, 10; Boys 3: 48 kph/29.8 mph
- E. Women 8, 9, 10, 11; Boys 2; Girls 2, 3; Men 11: 45 kph/28.0 mph

## **9.07 Boat Path**

The jumper shall tell the boat driver at what off-set distance to pass the ramp. The boat shall follow a straight path parallel to the course through the EC buoys. The driver shall not deviate the boat path in an attempt to aid the skier's landing and ride out of the jump.

## **9.08 Officials**

- A. Boat Judge: A judge shall ride in the boat to check speeds, observe the boat path and alone determine if the skier lands and skis away in skiing position without falling. He shall be authorized to grant rerides for deviations there from, as governed by Rules 9.03, 9.06 and 9.07.
- B. Event Judges: The Chief Judge may appoint two event judges in addition to the judge in the boat.
- C. Boat Timers: When speed control is not being used, a boat timer shall ride in the boat to check speeds with a stop watch (see Rule 9.09), and a backup timer is also required. Automatic timing devices may be substituted for the boat timers.
- D. Boat Crew: There shall be two or three people in the boat.
- E. Video Distance Measurement: For the video system, there shall be two designated officials operating the system who shall jointly agree on the marking of the impact point. If these two officials disagree, the Chief Judge (or his designee) will resolve the disagreement.

## **9.09 Timing**

- A. General: The boat speed shall be validated by timing on each pass from the speed control system (see 8.10.G). The timing shall be in two segments – 82 meters and 41 meters. The 82m segment shall be from the timing course start buoy 72 meters (236' 1") before the jump to the intermediate timing course buoy 10 meters (32' 10") past the jump. The 41m segment shall be from the 10-meter buoy to the timing course end buoy 51 meters (167' 3") past the jump. Timing will be required to be recorded in three segments of 52m, 82m, and 41m, however the 82m and 41m segment times will be controlling. Acceptable timing methods may be magnetic point to point or calculated virtual timing provided such methods and timing components of the speed control system are tested and approved. It is not necessary to time the jump pass if the skier falls in the course before the boat enters the timing course. In the case where a skier refuses the ramp or falls on the approach to the ramp, the maximum tolerance allowable shall be increased by .05 seconds and only the 82m segment timing is required. This may be done by either subtracting .05 seconds from the maximum speed tolerance or by adding .05 seconds to the time recorded.

- B. Tolerances: Tolerances shall be in accordance with Rule 9.17.
- C. If the boat path is between the jump ramp and the 15-meter buoys, timing is not required, but is recommended if practical.
- D. Speed Control: If the boat officials feel that a significant change must be made in settings for the jump event to obtain the proper speed, they will notify the skier of the change when it is made, before his next jump.

### **9.10 Rerides**

- A. Unfair Conditions: See Rules 7.01, 7.02 and 7.03.
- B. Time Out of Tolerance: See tables below for appropriate actions and IWWF Rule 10.06 for Class E/L/R.
  - 1. Balk (Pass) -- immediate optional reride awarded if 82m segment time is out of tolerance (either fast or slow): 41m segment time does not apply.
  - 2. Fall -- immediate optional reride awarded if EITHER 82m OR 41m segment time is out of tolerance (either fast or slow)
  - 3. If the time for either segment is missed, a reride shall be mandatory.

4. On a successful jump, when the skier has selected a speed below the maximum allowable for his division, follow the appropriate action as directed by the table below.

**Boat Times and Reride Situations**  
(Skier below Division Maximum Speed)

<b>Segment</b>		<b>Action</b>
<b>82m</b>	<b>41m</b>	
Any	Fast	<p>If time exceeds the fast tolerance for the division maximum speed <u>AND</u> the jump is:</p> <p style="padding-left: 40px;">A. the best distance in set: Mandatory reride at the end of the set.</p> <p style="padding-left: 40px;">B. <u>NOT</u> the best distance in set: No reride, and the jump is not scored due to longer jump in same set.</p> <p>If time does <u>NOT</u> exceed the fast tolerance for the division maximum speed: No reride, and score counts.</p>
OK	Any	None
Fast	Any	<p>If time exceeds the fast tolerance for the division maximum speed: Mandatory reride, and the score is not protected.</p> <p>If time does <u>NOT</u> exceed the fast tolerance for the division maximum speed: Optional reride, and the score is protected.</p>
Slow	Any	Optional reride, with protected score.

5. On a successful jump, when the skier has selected the maximum speed allowable for his division follow the appropriate action as directed by the table below.

**Boat Times and Reride Situations**  
(Skier at Division Maximum Speed)

Segment		Action
82m	41m	
OK	OK	None
OK	Fast	If best distance in set: Mandatory reride at the end of the set. If <u>NOT</u> best distance in set: No reride, and the jump is not scored due to longer jump in same set.
OK	Slow	Optional reride, and score is protected. Use RTB slow column if applicable (See 9.17).
Slow	OK	Optional reride, and score is protected.
Slow	Fast	
Slow	Slow	Optional reride, and score is protected. Use RTB slow column if applicable (See 9.17).
Fast	Any	If best distance in set: Mandatory reride at the end of the set. If <u>NOT</u> best distance in set: No reride, and the jump is not scored due to longer jump in same set.

- C. Procedure: If a reride is granted, it shall be taken at the same speed as that requested for the affected jump. If there are more than two rerides, the skier shall have the option of requesting a five-minute rest before continuing. Also see Rule 7.02.
- D. Once a skier has taken a definite cut toward the ramp, he automatically waives any reride request regarding any conditions encountered prior to the start of the timing course.
- E. When weather, tournament-supplied equipment, or some other reason not the fault of the skier causes a delay of more than ten minutes between jumps, the skier shall have the option of requesting an unscored jump to be taken before the remaining jump(s). However, the Chief Judge, with the approval of the majority of the Appointed Judges, may deny this option if there is reason to believe that further delays will preclude finishing the tournament in a timely manner or otherwise work to the disadvantage of the remaining skiers.

### 9.11 Handle Throws

A contestant may refuse to enter the official jump course on any pass by throwing the handle in the air before the 180-meter (590') course entry buoy. He shall not be penalized for so doing, provided the refusal was for a reason acceptable to a majority of the Event Judges. The skier must be ready to ski immediately upon the boat's return. Should the skier not be ready or should the reason for the handle throw not be acceptable, one pass shall be deemed as taken. (See Rule 9.15 regarding damaged equipment.)

### 9.12 Distance Measurement

- A. General: All video computer measurement systems shall be approved by the World Waterski Council (IWWF). For Class C, a computer measurement system is recommended for use to measure jumps, but is required for all other classes (E/L/R). If using meter stations for Class C, distances shall be derived using sightings taken from a system of Johnson-type meter stations, which shall be set up according to guidelines described in the Technical Handbook.
- B. Rounding: All distances shall be calculated to the nearest whole foot. Partial distances of one-half foot or more will be rounded up to the next higher whole foot, while partial distances of less than one-half foot will be dropped. Metric distances shall be calculated as well, and in similar fashion rounded to the nearest whole tenth of a meter.
- C. Three Meter System: See Technical Controllers Manual
- D. Two Meter System: See Technical Controllers Manual
- E. Video Computer Systems: See IWWF 10.12 or the Technical Controller Manual.

Such video computer measurement systems must be configured in a fashion so that the maximum differential in jump distances which would result from one-pixel movements on the video screen, either of any of the required reference point markers or of the landing point marker itself, and in either the horizontal or vertical direction - not exceed the following values at any point in the landing zone. This criterion value depends on the class of the tournament, as follows:

World Record (Class R)	10 cm (4 inches)
Standing List (Class L and E)	15 cm (6 inches)
Local Tournaments (Class C)	20 cm (8 inches)



### **9.13 Scoring**

- A. Each contestant's longest single jump distance, in feet as determined according to Rule 9.12, shall become his official score for the event. Where a computer is being used that calculates metric distances (see Rule 9.12.B), the metric distance of the longest single jump shall also be reported.
- B. Scoring Ties: In the case where two or more skiers have the same official score above zero, the skier with the longest metric distance (if available) shall be declared the winner. In the event a tie exists, it shall be run off as provided under Rule 9.14.

### **9.14 Ties**

- A. If a tie results, it shall be run off, with a new drawing for order. Each tied contestant shall be allowed two passes through the course, with both jumps being scored. Repeated ties shall be run off in the same manner until broken.
- B. Ties shall be run off in the first five places at Regionals and Nationals, and the first three places in all other tournaments.
- C. A two-way tie for second place would eliminate third place, while a three-way tie for second place would eliminate third and fourth places, etc.
- D. Ties in multi-round tournaments shall be determined as follows: Longest single jump; if a tie still exists, the next longest jump; etc

### **9.15 Damaged Equipment**

If a skier notices that his equipment is damaged after a handle throw, a pass or a jump, the event judges may grant him, upon immediate request, three minutes to repair or change the damaged equipment. The three-minute period should start upon the request being granted by the judges. If the skier is not ready to ski at the end of the three-minute period, he shall not be allowed to continue in that round.

### **9.16 Jumping Equipment and Definitions**

- A. Jump Meters: See Technical Controllers Manual
- B. Distance Derivation Devices:
  - a. All video computer measurement systems must be approved by IWWF (World Waterski Council) per IWWF 10.12.
  - b. Class E/L/R jump distance shall only be measured by a video computer measurement system per IWWF 10.12, and is also recommended for Class C.
  - c. For Class C, jump distances may be measured on a scale model manual plotting board which has been set up and verified according to guidelines described in the AWSA Technical Handbook.

d. Jump measurement system shall be checked by the Chief Judge or his designee, and must be shown to produce the listed results for all the test cases that appear in the Computer Benchmark section of the Appendix.

C. The Jump Ramp: The jump ramp shall be an inclined plane with mounted aprons set at an angle in relation to the ramp. The ramp shall meet the specifications in IWWF Rule 10.02 with exceptions for Class C as identified below:

1. Length Under Water: 50 cm (20") minimum (Safety Requirement).
2. Ramp Length and Settings: The following ratio of ramp is the height at take-off edge divided by the length out of water. The table below and the Ramp Setting Chart provide the settings.

Ramp Ratio	Minimum Length out of Water	Maximum Length out of Water	Recommended Length out of Water	Max Height (See Note)
5ft 0.235 (+0.003/-0.005)	6.50m (21'-4")	7.00m (22'-11 9/16)	6.80 to 6.90m (22'-3 3/4" to 22'-7 5/8")	1.645m (5'-4 3/4").
5.5ft 0.255 (+0.003/-0.005)	6.50m (21'-4")	7.00m (22'-11 9/16)	6.80 to 6.90m (22'-3 3/4" to 22'-7 5/8")	1.785m (5'-10 1/4")
6ft 0.266 (+0.003/-0.005)	6.75m (22'-1 3/4")	7.00m (22'-11 9/16)	6.85 to 6.95m (22'-5 11/16" to 22'-9 5/8")	1.860m (6'-1 1/4").

Note:

Recommended height setting should be adjusted according to the condition(s) and skiers. Recommendations follow:

- 0.235: Boys/Girls 2 thru 5  
Recommended height not to exceed 1.60m (5'-3").
- 0.255: Boys 4 and 5 if qualified (U17)  
Recommended height 1.7m (5'-6") with length 6.85m (22'-5 11/16"), no longer than 6.90m (22'-7 11/16") and no higher than 1.76m (5'-9 1/4").

- 0.255 All other Class C divisions

Recommended height 1.74m (5'-8 ½") with length 6.78m (22'-3"), no longer than 6.90m (22'-7 11/16") and no higher than 1.76m (5'-9 ¼")

3. The following ramp ratios shall apply: Masters Men, Open Women, Men 1, 2 and 3, jumpers will have the option of choosing either the .255 or .235 ramp; Boys 4 & 5 shall use the .235 ramp unless they can show a certified result of a jump of 38 m (125 feet) on the .235 ramp, in which case they may opt to jump on a .255 ramp; Open Men will have the option of choosing either the .266, .255 or .235 ramp; and all other divisions will be set at .235. At the option of the sponsoring club, any division may jump at a ramp ratio of less than .235.

4. Surface:

- a. Class E, L, R: The tolerance of the plane deviation is to be per IWWF Rule 10.02.

- b. Class C tolerance of the plane concave deviation is a maximum of 5cm (2"). Class F tolerance may be greater, but NOT recommended. Below is the specification for Class C:

1. The maximum concave deviation should occur in the center of the out of water surface, but no closer than 4'-11" (1.5m) from the top edge. The location of the maximum deviation will be measured from the top edge.
2. No overall convex deviation is allowed. Minor convex at bottom where the hinge is against the surface may occur or where there is a main support. The intent is that the ramp does not have a general upward bow (convex) from bottom to top.
3. The deviation from perfectly flat will be verified by two measurements:
  - Place a taut string from the lower right corner (jump course side) of the surface to the upper left corner of the surface and measure the maximum distance between the ramp surface and the string.
  - Place a taut string from the bottom center of the surface to the top center of the surface and measure the maximum distance between the ramp surface and the string. A good practical method is to use a block of the same thickness under each end of the string so that both concave and convex measurements can be recorded by subtracting the block thickness from the measurement.

- D. Buoys: Colors of buoys shall be in accordance with the Official Jump Course Diagram in the Appendix. For size specifications, see Rule 8.09. The 15MT

buoy may be sunk below the level otherwise specified for boat guide buoys, although it must still be clearly visible.

- E. Tow Lines: Tow lines used in the Jumping event must conform to Rule 8.04 and the Tow Lines Dimensions Chart in the Appendix. Tow line recoil tubes may be used at any and all tournaments at the discretion of the Chief Judge.
- F. Skier Furnished Jump Handle: The contestant may furnish his own handle, for which he is entirely responsible, with an attaching loop to attach to the tournament line, and which must comply with the handle section dimensions in the Appendix. The contestant's handle may be of any material. It is the skier's responsibility that the handle is in tolerance after skiing.
- G. Skier Furnished Jump Towline and Handle: The contestant may furnish his own jump towline and handle, for which he is entirely responsible. The contestant's towline and handle may be of any material which must comply with the dimensions for total length in the Appendix (23m +/- 30cm).

### **9.17 Tolerances**

The accuracy of all speeds shall be determined by the tables which appear in the Appendix. The measured times through the 82-meter and 41-meter segments of the timing course must fall within the tolerances listed in the appropriate column of this table, as specified in 9.10.B. If the skier chooses the faster option and then does not engage the jump switch at the base of the ramp and in the opinion of the boat judge did not cut aggressively enough to do so, or if the skier chooses the return to baseline option, then the "RTB" 41m segment slow time tolerances shown in the table shall apply.

- A. Class C & F Tournaments: The Standard Tolerance Chart in the Appendix shall be used.
- B. Record Capability Tournaments (Class E/L/R): The Record Tolerance Chart for speeds in IWWF Rule 10.05 applies.

## **RULE 10 - SLALOM**

### **10.01 General**

- A. The contestant shall follow the towboat through the entrance gate of the slalom course, pass around the outside of any or all six buoys and proceed through the far end gate which constitutes a complete pass. If the contestant has not missed any buoys or gates, the boat shall turn and enter the course from the opposite end. The skier shall continue in this manner until he falls or misses a buoy or gate.
- B. The boat shall be stopped at the end of each pass, unless the skier requests at the starting dock to continue at his own risk.
- C. Any contestant who fails to be on immediate hand and in condition to ski when the boat is ready for the contestant shall not be allowed to ski in that round of the event. However, the Chief Judge or his designee, may grant up to three additional minutes for emergencies developing or discovered just prior to the contestant's turn to ski (e.g., ripped binding). In the case where a skier has been disqualified or has scratched, a one-minute delay shall be granted to the next skier in the starting order. If more than one skier has been disqualified or has scratched, the time allotted to the next skier shall be one minute for each skier disqualified or scratched.
- D. At the discretion of the Regional Executive Vice President, all slalom passes in Class C and below tournaments may be run in the same direction if the site is not suitable for running them in opposite directions.
- E. At the recommendation of the LOC, the Chief Judge in conjunction with the Chief Driver will determine the end course "Wait Times" (sit down times). The chief officials may adjust these "Wait Times" at any time, between divisions or rounds, for considerations such as time or conditions.

### **10.02 Slalom Course**

- A. The dimensions of the official slalom course are shown in the Appendix. The specifications for the buoys in the course are in 10.16A.
- B. Slalom may be run on an extended or overlapping course setup, which provides two complete slalom courses that share some gates in common, provided that each such complete course is otherwise in tolerance according to the Official Slalom Course Diagram in the Appendix.
  - 1. In such a layout, it is recommended that the orange entrance gate buoys be used to mark the true entrances, which are inset from each end.



## **10.04 A Fall**

- A. Definition: See Rule 8.06.
- B. A fall inside or outside the course concludes the run at that point.
- C. The stopping of the boat in slalom at the end of the course will not be scored as a fall.
- D. At the LOC's option, based on site configurations, the skier may release the handle to stop at a specified drop location after a completed pass.

## **10.05 Boat Selection**

See Rules 8.02.D, 8.02.E, and 8.02.F.

## **10.06 Boat Speeds and Line Lengths**

(May be used for all Classes but certain scoring options do not follow with IWWF scoring, i.e., a skier will need to make a complete pass at maximum speed before the pass will count on the IWWF ranking list).

- A. The minimum starting speed for all divisions shall be 25 kph (15.5 mph).
  - 1. At the option of the LOC, a skier may start below the minimum speed in Class F only and the pass(es) shall not be scored at or above zero until they have reached the official minimum starting speed. (Also see Rule 3.06).
  - 2. Also, at the option of the LOC as stated in its tournament announcement, or by majority vote of the Appointed Judges, the number of passes may be limited to a specific number but not less than four.
- B. The maximum allowed boat speeds shall be as follows:
  - 1. A skier may elect to start at a speed higher than his division maximum speed, up to his respective Open Division maximum speed, and may not return to his division maximum speed on subsequent passes. Any passes skied at that higher speed shall receive credit for buoys as though they were being run at his division maximum speed.
  - 2. In Class C tournaments, the skier may opt to ski at higher maximum speeds, up to 58kph (36mph) for male divisions and 55kph (34.2) for female divisions, excluding juniors, at their discretion. In this case, the skier shall receive credit for the buoys run at the higher speed.

<b>Male Divisions</b>	<b>Maximum Speed</b>	<b>Female Divisions</b>	<b>Maximum Speed</b>
Boys 1	49k (30.4)	Girls 1	49k (30.4)
Boys 2	52k (32.3)	Girls 2	52k (32.3)
Boys 3	55k (34.2)	Girls 3	52k (32.3)
Boys 4	58k (36.0)	Girls 4	55k (34.2)
Boys 5	58k (36.0)	Girls 5	55k (34.2)
Men 1	58k (36.0)	Women 1	55k (34.2)
Men 2	58k (36.0)	Women 2	55k (34.2)
Men 3	55k (34.2)	Women 3	55k (34.2)
Men 4	55k (34.2)	Women 4	55k (34.2)
Men 5	55k (34.2)	Women 5	52k (32.3)
Men 6	55k (34.2)	Women 6	52k (32.3)
Men 7	52k (32.3)	Women 7	49k (30.4)
Men 8	52k (32.3)	Women 8	49k (30.4)
Men 9	49k (30.4)	Women 9	46k (28.6)
Men 10	49k (30.4)	Women 10	46k (28.6)
Men 11	46k (28.6)	Women 11	46k (28.6)
Open Men	58k (36.0)	Open Women	55k (34.2)
Masters Men	55k (34.2)	Masters Women	55k (34.2)

C. A skier may start his run anywhere in the matrix shown in 10.06(g) below, subject only to the maximum speeds for their division as stated in 10.06B. The age division maximum speeds shall be retained for National Records.

D. Upon completing his first pass, the skier will then receive credit for all of the initially skipped speeds and/or line length passes. However, if the first pass is not complete, then it will be scored as though it was run at the minimum speed and maximum line length.

E. After each completed pass, the skier may advance to a higher speed, and/or a shorter line, i.e., pass-to-pass movements in the matrix may only go down, and/or to the right.

F. Opting Up.

1. After completing a pass, a skier may advance two or more intervals either faster and/or shorter.

2. If the skier elects to opt up in this manner, then the skier must complete the selected pass to receive credit for the skipped pass(es). If the pass is not completed the skier will receive credit for buoys at what would have been the first immediately sequential skipped speed, or the first immediately sequential skipped line length, if the speed selected is the same.



G. Advancement and Scoring Matrix.

**AWSA Zero Based Slalom Scoring Matrix -- Buoys Earned on Completion of Cited Pass**

Boat Speed		Line Length -- AWSA Feet off Upper, Metric Length Lower											
		Long	-15	-22	-28	-32	-35	-38	-39.5	-41	-43	-44	-45
KPH	MPH	23.00	18.25	16.00	14.25	13.00	12.00	11.25	10.75	10.25	9.75	9.50	9.25
25	15.5	6	12	18	24	30	36	42	48	54	60	66	72
28	17.4	12	18	24	30	36	42	48	54	60	66	72	78
31	19.2	18	24	30	36	42	48	54	60	66	72	78	84
34	21.1	24	30	36	42	48	54	60	66	72	78	84	90
37	23.0	30	36	42	48	54	60	66	72	78	84	90	96
40	24.9	36	42	48	54	60	66	72	78	84	90	96	102
43	26.7	42	48	54	60	66	72	78	84	90	96	102	108
46	28.6	48	54	60	66	72	78	84	90	96	102	108	114
49	30.4	54	60	66	72	78	84	90	96	102	108	114	120
52	32.3	60	66	72	78	84	90	96	102	108	114	120	126
55	34.2	66	72	78	84	90	96	102	108	114	120	126	132
58	36.0	72	78	84	90	96	102	108	114	120	126	132	138

**10.07 Boat Path**

- A. The boat path is intended to be a straight line along the centerline of the course.
- B. See IWWF Rule 8.15 and Section 25 for Class L/R. Class L tolerance in IWWF Rule 8.15 also applies to Class E.
- C. Class E tournaments also see Rule 14.04B on Record forms.

**10.08 Officials and Judging Area**

- A. Event Judges:
  - 1. Each event judge shall independently determine the credit to be received by the skier in accordance with Rule 10.12, and shall communicate his results to the scorers immediately after each pass.
  - 2. In all Classes of tournaments, the event judge must continue scoring a run even though he feels the skier missed a gate.
  - 3. Only one event judge shall ride in the towboat, hereafter referred to as the boat judge.
    - a. The boat judge and scorer shall check the boat time for each pass

and identify reride situations in accordance with Rules 10.09 & 10.10.

b. There shall be two or three people in the boat.

4. There shall be two or four event judges on towers, hereafter referred to as tower judges.

B. Auxiliary Personnel:

1. Boat Timer: In the event of a speed control malfunction, a boat timer shall ride in the boat to check speeds with a stop watch (see Rule 10.09), and a backup timer is also required.

2. Video Operator: Based upon tournament classification and judging tower configuration, a video operator may ride in the boat to record passes that will aid event judges in their decisions.

C. Tower Judging Area:

1. General:

a. For Class L & R, reference the IWWF Rule 8.13 for tower judge configuration. Class L & R meets or exceeds the requirement for Class E. Reference 14.04B for Boat Video requirement for Elite Division Record Application.

b. For Classes E & C, where there is only one center judge's tower between 3 and 4 with two tower judges boat video is not required, except where a National Record in the elite division may be set per 14.04B.

c. For US National Tournament, the use of a recorded gate view, as described in 10.08C2, shall be mandatory regardless of tower placement/configuration or if using three or five judges.

d. For Class C tournaments and below, at the option of the Chief Judge, three event judges (two towers and one boat) rather than five may be used to score slalom and video gate cameras are not required.

e. For Class C tournaments and below, if no slalom judging tower is used, the judges shall be stationed with the best possible view of the course.

f. In Class F (Grass Roots) tournaments, the number of judges shall be at the option of the Chief Judge. Slalom may be judged by the boat judge alone.

2. Gate Camera specifications shall be per IWWF Rule 8.13.

In Class C tournaments and below, if no slalom towers are used, the judges shall be stationed with the best possible view of the course. Gate cameras are not required for Class C and below.

D. Boat Video: An additional option based on Configuration and Class, but required for Configuration 3, Class L/R.

1. Reference 14.04B for the boat video requirement for the Elite Division Record Application.
2. For Class E, a camera may be used in the boat to record the pass. This video may be used to resolve any issues as directed by the Chief Judge.
3. For Class L/R, reference IWWF 8.13 for requirements.

E. Judge's Scoring Errors:

1.
  - a. If a skier or skier's representative believes that there was an error in the score, he should notify the Chief Judge within 10 minutes of completing his turn and by putting up \$100.
  - b. All slalom tower configurations may use a form of video review challenge if approved by the Chief Judge and Technical controller prior to the tournament.
2. The Chief Judge and a designated review judge will review the video (boat and/or gate video). If they both agree on a score, that will be the given score. If they disagree, or agree that the video does not clearly overrule the score given by the judges, then that score will stand.
3. The \$100 will be returned only if the original score was changed.
4. If the funds are not returned to the skier, they shall be forwarded to the USA-WWF as a contribution in the skier's name.
5. If the Chief Judge and Technical Controller agree, an official webcast video may be used for reviews if declared prior to the start of the event.

## 10.09 Timing

- A. The boat speed shall be validated by timing on each pass from the speed control system (see 8.10G). In the event the speed control system fails to get an accurate time because of a malfunction or missed time, see Rule 10.10.B.3 and 10.10B4. Where the time shows that the speed is slower than allowed, a reride is mandatory; where faster, a reride is at the contestant's option if the pass was not complete.
- B. Timing Segments: Timing shall be from the entrance gate to the boat path alignment gate or exit gate following the buoy at which the last full point is scored in the pass. (Refer to applicable All Buoy Timing Charts in the Appendix) Acceptable timing methods may be magnetic point to point or calculated virtual timing provided such methods and timing components of the speed control system are tested and approved.
- C. Official times and tolerances for the various slalom speeds are listed in the Appendix. Also see Rule 10.17.

## 10.10 Rerides

- A. Unfair Conditions: See Rules 7.01, 7.02 and 7.03.
- B. Times Out of Tolerance
  - 1. Slow Time: If the time is too slow, a reride is mandatory.
    - a. Slow time pass NOT complete: At class E, L, and R events the skier may not improve his score over that obtained on the slow pass. However, if the speed is so slow that it is equal to or below the fast tolerance of the next slower pass, then the skier may improve his score on the reride.
    - b. If the slow time pass WAS complete, the skier has the option to skip to any higher speed and/or shorter line length instead of repeating the pass. If the skier exercises this option and makes a perfect pass, he receives credit for both passes. However, if the pass is missed, he will receive credit for the buoys as if it were the lower, skipped pass.
  - 2. Fast Time: If the time is fast and the skier falls or misses, the skier shall have the option of a reride but shall not be scored less than the score obtained on the pass leading to the reride.

3. Missed Segment Times: If the applicable segment time is missed, the provisions above shall be applied as though the time was slow, except that the skier may improve his score, may accept the highest score with a good applicable segment time, or receive an optional reride with a protected score equal to the highest score with a good applicable segment time.
4. Irregular Boat Speed: If the boat time is OK or fast on an incomplete pass, but the skier received an irregular or inconsistent speed as a result, the skier may be given an optional reride with a protected score. If the time was slow the score is not protected, but the skier may improve. If the time is missed see rule 10.10B3. Also see 7.01 and 8.10F.
  - a. Causes: speed control and/or towboat malfunction, towline breakage.
  - b. A time that is merely slow does not represent a speed control failure or malfunction of tournament supplied equipment. This provision is only to be applied when there is a clear irregularity in the delivered boat speed.

C. Times and/or rope length out of tolerance.

1. In the event a contestant inadvertently receives a speed FASTER, or a rope length SHORTER, than the intended pass, the skier shall be given the option of:
  - a. Receiving credit for the actual score.
  - b. Accepting credit for the originally requested speed or rope length (assuming a perfect pass).
  - c. Taking a reride with a protected score.
2. In the event a contestant inadvertently receives a speed SLOWER or a rope length LONGER than the intended pass, the skier shall be given the option of:
  - a. Opting up (see rule 10.10B1) to any pass which follows the intended pass (assuming the pass taken was perfect).
  - b. Accepting credit for the actual pass as skied.
  - c. Taking a reride.

D. Boat Path Deviates Outside the Bounds of Boat Gates: See Rule 10.07

E. Procedure for rerides:

1. Immediately following any one pass for which the timer records a speed that requires or makes optional a reride for the skier, the skier shall be notified of the facts and told he must or may repeat that pass.
2. If a reride is to be taken, the boat shall return through the course in an unscored pass, and the reride shall then be given in the original direction and the original speed/line length through the course. The boat will proceed to the proper end of the course, stop, and drop the skier into the water just as if the line were to be shortened, and then proceed.
3. If there are more than two rerides, the skier shall have the option of requesting a five-minute rest before continuing. Also see Rule 7.02.
4. a. When weather, tournament-supplied equipment, or some other reason not the fault of the skier causes a delay of more than ten minutes between slalom passes, the skier shall be allowed an unscored warm up pass, in the opposite direction of the reride, with a protected score on passes already completed, or the skier may start over at the original starting pass without a protected score. If the skier falls or misses on the unscored warm up pass, there shall be no penalty, and the skier's turn shall continue with the next pass. However, the Chief Judge, with the approval of the majority of the Appointed Judges, may deny this option if there is reason to believe that further delays will preclude finishing the tournament in a timely manner or otherwise work to the disadvantage of the remaining skiers.  
  
b. When the 2019 Nautique or newer is used in slalom, the MicroTuners and Hydrogate automatically deploy. If the incorrect line length on the display was selected but is within the matrix supplied by Nautique, there will be no reride. If a rope length is selected for which the MicroTuners are not what the Matrix recommends, a reride may be allowed if an incomplete pass.

### **10.11 Handle Throws**

- A. A contestant may refuse to enter the official slalom course on any pass by throwing the handle in the air before the entrance gate. He shall not be penalized for so doing, provided the refusal was for a reason acceptable to a majority of the event judges.
- B. The skier must be ready to ski immediately upon the boat's return. Should the skier not be ready or should the reason for the handle throw not be acceptable, he shall not be allowed to continue in that round.
- C. See Rule 10.15 regarding damaged equipment.

## 10.12 Points for Buoys

A buoy not missed is credited as described below up to the point of the first miss:

- A. 1/4 point when the skier crosses the C-D and X-Y lines in skiing position (Rule 8.07) before the buoy to be rounded; however, if the skier passes on the inside of the buoy, he shall not receive the 1/4 point.

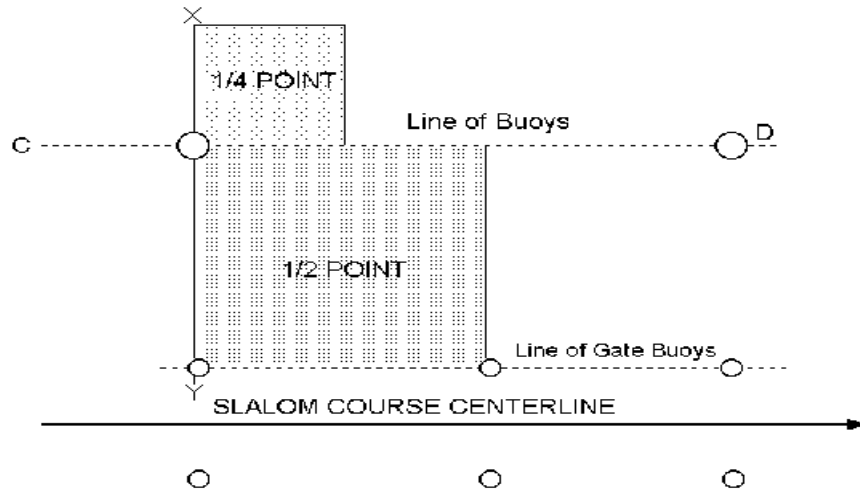

- B. 1/2 point when the skier has re-crossed the C-D line in skiing position before the level of the next buoy or end gate.
- C. 1 point when the skier has crossed the line of the gate buoys before passing the level of the next buoy with a tight line under the power of the boat.
1. The intent of the tight line is to ensure the safety of the skier and boat crew. This means that if the skier can only cross the line of the buoys with a slack line, even if he successfully manages the sudden tightening of the rope, he will not get the full point.
  2. The end gate case is different because of the spacing and thus if the skier can cross the gate line before the end gate buoy he will be awarded the full buoy.
    - a. This specifically means that the skier is permitted to have slack going through the exit gates. If the skier skis away then he may continue.
    - b. If the skier does not ski away, the turn ends and the skier scores 6 provided they crossed the line of the boat buoys before the end gate with or without a slack line.
- D. For judging purposes, the front foot of the skier shall be used to determine the point at which the skier crosses the quarter, half, and full point buoy lines (or the end gate in case of the final buoy).

### **10.13 Scoring**

- A. The scorers shall receive the judges' individual tabulations after each pass. Any disagreement shall be decided by a majority of event judges before the next pass or before the next competitor is permitted to ski.
  - 1. The first decision to be made will be if the skier has gone through the entry gate. That decision will be made by the appropriate judges as specified in Rule 10.08 for the configuration used.
  - 2. If the skier made the gate, the scorer will then award the highest score agreed upon by the judges based on their submitted scores. Thus, if the scores are 1, 1, 3.25, 3.50, 3.50, the skier's final score is 3.25.
- B. Points are earned toward placement in the event for each full, half, or quarter point scored in succession without a miss of a buoy or end gate (Rule 10.12).
- C. The contestant with the most consecutive points shall be the winner of the event. Refer to Rule 10.14 (Ties)
- D. Scoring Waived Passes:
  - 1. Miss on First Pass: The skier shall receive only the points scored without additions for the waived passes.
  - 2. Skier Has Complete Pass: Six points shall be added to the skier's score for each skipped or waived pass.
  - 3. Skier Has Complete Pass but Slow Boat Speed and Exercises Option to Advance to the Next Pass per Rule 10.10B1: If the skier makes a complete pass, he shall receive credit for both passes. If the pass is missed, the skier shall receive credit for buoys as if it were the lower, skipped pass.
- E. Scoring Rerides: The affected pass shall be re-scored in accordance with the above (Rules 10.13A, 10.13B, and 10.13C) and with Rules 10.04 and 10.12.

### **10.14 Ties**

- A. Definition: A tie shall exist when two or more skiers have the same score, greater than zero (See 10.14B1).
- B. Procedure to resolve:
  - 1. If a tie exists, there shall be a new drawing for running order. Run-offs shall start by repeating the pass before the one in which the miss occurred even when ZBS involves different line lengths and speeds. When the tie occurs at the skiers' minimum starting speed, the starting speed



will remain the same. The skier may optionally skip any pass in the run-off. (See 10.13C & 10.13D if skiers tie again)

2. If another tie results, the pass at which the original miss occurred shall be used with a new drawing for order. If a tie still exists, it will be declared a tie.
- C. Ties shall be run off for the first five places at Regionals and Nationals and the first three places in all other tournaments.
  - D. A two-way tie for second place would eliminate third place, while a three-way tie for second place would eliminate third and fourth places, etc.
  - E. Ties in multi-round tournaments shall be determined as follows: Highest single round total; if a tie still exists, the next highest single round total; etc.

### **10.15 Damaged Equipment**

- A. If a skier notices that his equipment is damaged after a handle throw, a run that leads to a reride, or a completed pass, but prior to the boat starting for the next pass, the event judges may grant him, upon immediate request, three minutes to repair or change the damaged equipment.
- B. The three-minute period should start upon the request being granted by the judges. If the skier is not ready to ski at the end of the three-minute period, he shall not be allowed to continue in that round.
- C. If this occurs in the case of a mandatory reride, the pass that brought about the reride shall be scored zero. If this occurs in the case of an optional re-ride, the skier will be credited with the score obtained in the run that brought about the reride.

### **10.16 Slalom Equipment, Specifications, Definitions:**

- A. Buoys: See Rule 8.09 for Buoy specifications and the Official Slalom Course diagram in the Appendix for buoy placements.
- B. Towlines:
  1. Tow lines used for the Slalom event must conform to Rule 8.04 and the Tow Lines Dimension Chart in the Appendix. A light line (5mm diameter), as identified below, may be used as described below, but is not acceptable in IWWF events.

- a. Standard Rope per IWWF Rule 5.09  
726 kg (1600 lbs) minimum breaking load  
(for information only, diameter is approx. 10mm/13/32")  
Used in all AWSA/IWWF Classes and divisions.
  
  - b. Optional: Two Light weight lines may be used as described below:
    - 1. 8mm (IWWF Lighter Line), 499 kg (1100 lbs.) minimum breaking load. (For information only, diameter approx. 8mm/5/16")  
May be used in AWSA Classes E/C/F in B 1-3, G 1-4, W6 and above only.  
IWWF Classes L/R in B/G 1-3 (U-14 and below) only per IWWF Rule 5.09.
  
    - 2. 5mm, 363 kg (800 lbs.) Minimum breaking load.  
Not to exceed 35 off (12m)  
(For information only, diameter approx. 5mm/3/16") May be used in AWSA Classes E/C/F in B1-2/G 1-3 only.  
Can NOT be used in IWWF Classes L/R.
2. Skier-Furnished Slalom Handle: The contestant may furnish his own handle, for which he is entirely responsible, with an attaching loop to attach to the tournament line, and which must comply with the handle section dimensions in the Appendix.
- a. The contestant's handle may be of any material.
  
  - b. For Class E, L & R tournaments personal handles shall be measured by the dock starter under the supervision of the Technical Controller (or his designee) immediately after the skier skis under a 44lb/20kg load. Should the handle be out of tolerance, the skier's score in that round will be recorded as zero.

If a RECORD is set:

- 1. Immediately after the skier skis, the handle shall be measured (preferably by loosening its connection to the rope but without disconnecting it entirely from the rope). Should the handle be out of tolerance, the skier's score in that round will be recorded as zero, and there shall be no record.
  
- 2. Rope (handle and rope) shall be measured by the TC approximately 15 minutes after the skier skis. Should the rope be out of tolerance, then it shall be retained by the TC at normal room temperature and retested after a one-hour relaxation period. If the rope remains out of tolerance after the one-hour period, the record is denied but the score stands.

- c. At the option of the Tournament Committee for Class E tournaments and below, tow lines without shortening loops may be provided and used at the request of the skier for 23-meter passes.
3. Slalom recoil/shock tube: Such a tube shall be installed on the tow rope in all sanctioned tournaments. When using camera mounts on the pylon, shock tubes are still required.
  - a. The Boys 1,2 and 3/Girls 1, 2 and 3 divisions may be exempted from this requirement.
  - b. The tube must be a minimum of 60cm and a maximum of 120cm (approximately 2 to 4 ft) in length.
4. DIFFERENT SIZE SLALOM ROPES THAT ARE ALLOWED: All slalom ropes are tournament supplied. Any or all of these ropes may be supplied. Skiers can check with the LOC before the tournament to see which ropes are available. See Rule 10.16B for slalom rope sizes that are allowed for classifications and divisions.

For Class E/L/R, organizers will supply a minimum of two slalom ropes below which meet the specifications in Rules 8.04 and 10.16B. The ropes may be used as described below:

  - a) The same brand with the same specifications;
  - b) The same brand with differing specifications;
  - c) Different brands altogether.

If different ropes specifications are used, skiers will be permitted to choose which rope to use. No reride will be granted if a skier receives the wrong rope.

When two different ropes are being used and a tie exists, skiers may continue to choose their rope.

A skier cannot provide his/her own slalom rope.

### **10.17 Boat Speed Tolerances**

- A. The accuracy of all speeds shall be determined by the tables which appear in the Appendix. The measured times through the segments of the timing course must fall within the tolerances listed in the appropriate columns of these tables.
- B. Class C and Record Capability Tournaments: The Record Tolerance ABT Chart in the Appendix shall be used for all skiers and all speeds at Class C, E, L, or R tournaments.
- C. Class F Tournaments: The Standard Tolerance ABT Chart in the Appendix may be used.

## **RULE 11 - TRICKS**

### **11.01 General**

Each contestant shall be allowed two 20-second passes through the trick course (except as provided in Rule 11.03), during which he may perform as many tricks as he can. Any contestant who fails to be on immediate hand and in condition to ski when the boat is ready for the contestant shall not be allowed to ski in that round of the event. However, the Chief Judge or his designee, may grant up to three additional minutes for emergencies developing or discovered just prior to the contestant's turn to ski (e.g., ripped binding). In the case where a skier has been disqualified or has scratched, a one-minute delay shall be granted to the next skier in the starting order. If more than one skier has been disqualified or has scratched, the time allotted to the next skier shall be one minute for each skier disqualified or scratched.

### **11.02 Trick Course**

Two buoys approximately 230 meters apart shall establish the approximate area of the beginning of the trick pass from each direction (see Official Trick Course in the attached appendix and per IWWF Rule 9.02 for Class E/L/R). The boat may pass on either side of the orange/RED entry buoy at the choice of the skier. At the Option of the LOC, at Class E & below, the boat path may be on one side only. The end of the pass shall be signified by the 20-second time interval only. Reference IWWF Rule 9.02 for Class L/R.

### **11.03 Trick Pass**

Positioning tricks at the start of a pass must be done before the entrance buoy, unless the skier declares a positional trick to the boat driver/judge prior to his run. Any trick completed before the entry buoy will be treated as a positional, out of course trick. Any trick completed after the entry buoy will be treated as an in course trick, unless the skier declares a positional trick to the boat driver/judge in advance.

- A. After passing the approximate position of the entry buoy or after completing the declared positional turn, the beginning of the trick pass shall begin:
  1. For a surface trick, at the first discernable rotation of the ski from the tracking direction (or position).
  2. For a wake trick, at the earliest of the following to occur:
    - a. At the first discernable rotation of the ski from the tracking direction (or position) as the skier approaches the wake, or;
    - b. When the ski under the binding of the leading foot leaves the water surface no longer supporting the weight of the skier, or;

c. When the binding of the leading foot crosses the crest of the wake.

3. It is the skier's responsibility to start his pass within a reasonable distance (15 meters is suggested) after passing the entry buoy so that he does not run out of lake. Re-rides will not be granted for reasons caused by a skier's late start.

B. The trick pass shall end when:

1. Twenty seconds have elapsed from the beginning of the pass, which time shall be marked by sounding a loud audible device; or

2. The skier falls in the course; or

3. Three minutes have elapsed, including any time to repair or replace equipment, from the time the skier fell; or

4. The skier falls twice while practicing.

When using Video Based Frame Counting, the last completed trick shall be defined as a skier regaining skiing position on such trick. This includes the skier's weight being supported by the ski on or before the final frame as indicated by spray under the leading binding of the ski.

#### **11.04 Falls**

Definition: See Rule 8.06.

A. For Class C, the skier is allowed one practice fall without penalty. If a second fall occurs before the start of the first pass, the skier shall not be permitted either pass. A fall due to setup/conditions (i.e., around island) is not considered a practice fall. A fall at the conclusion of the first pass after the audible device has sounded shall not be considered a fall while practicing, if it is apparent that the fall resulted from a trick the skier was attempting to perform in the first pass. If a second fall occurs before the start of the second pass, the contestant shall not be permitted the second pass.

B. The stopping of the boat at the skier's request to adjust line length or to pick up or drop a ski will not be scored as a fall.

C. If the skier is granted three minutes for equipment repair in the event of a fall, in accordance with rule 11.15, then the skier shall receive no further passes if he is not on his skis within three minutes from the time the towboat returns to pick him up.

D. A handle throw without cause, as decided by a majority of the event judges, is considered a fall while practicing.

### **11.05 Boat Selection**

The skier shall be allowed his choice of the towboat types officially used by the tournament. The use of more than one boat for the skier's two passes is prohibited.

### **11.06 Boat Speed**

The skier shall tell the boat driver what speed he desires on each pass, and/or he may use the preparation time to set the speed up to 50m before entering the course. The skier is allowed to request a speed change after the 50m point, including any time during the run itself, but by doing so must accept the speed given without the right to request a reride for incorrect speed.

The skier must be given the speed setting he asks for before starting the run. If the wrong speed setting is given, then that is a reason for a reride provided the skier does not subsequently change the speed.

### **11.07 Boat Path**

The boat shall follow, as closely as possible, the path specified by the judges for the event. Such path includes the preparation time before each pass. The second pass shall be in the opposite direction. The boat must make a reasonably straight path through the course. If the skier falls during or at the end of the first pass, he will receive a maximum of 45 seconds in which to be ready to be taken by the boat for his second pass. At the skier's option, if he did not fall in his first pass, the boat may stop between passes for a maximum of 45 seconds. ***Skiers in M/W 8 and above may also have the option to stop after the first pass even if they fall.*** In each case the time shall start when the boat gets to the skier. In each case the skier is allowed to change equipment but must be in the water ready to go within the appropriate time frame or he loses the right to his second pass. If an approved ballast system is being used, the skier may have the option to change settings +/- 50% during this time.

For Class C tournaments and below, and at the discretion of the Regional Executive Vice President, both trick passes may be run in the same direction if the site is not suitable for running them in opposite directions.

### **11.08 Officials**

- A. Shore Judges: There shall be five judges responsible (at the option of the Chief Judge, 3 may be used for Class C tournaments and below) for independently deciding the following:
1. Judgments regarding Rules 7, 11.03, 11.04, and 11.12.
  2. Deciding with respect to each trick if it was performed according to the rules for that trick.
  3. Deciding if a trick is started after the beginning or completed before the

end of the pass.

4. Deciding if a fall or handle throw has occurred. (Rules 11.04 and 11.11)
  5. Deciding if a reride is to be given when requested by a skier.
- B. When video review is available for scoring tricks as described in 11.20, the following are required:
1. 3 Shore Judges as described above (5 Recommended for major tournaments).
  2. 1 Boat Judge, or at the option of the Chief Judge, a Reg/Sr **(D3/D2)** Driver. (see 11.08C)
  3. At the option of the Chief Judge, a shore judge may be used to grant rerides for conditions not physically observable by the video judges.
  4. Video Judge (Option for Class C) (Reference IWWF 9.12 for Class E/L/R) Revised 4/5/2023
    - a. Each Judge may watch the pass at either normal speed or 80% of normal speed.
    - b. After having finished their first view and call, all Judges will have one complete review (without pauses) at normal speed or 80% of normal speed.
    - c. Additional reviews of individual tricks may be allowed by the Chief Judge or his designate, if they are required, to resolve a majority issue in the scoring of the pass.
- C. Boat Judge: An additional judge shall ride in the boat. He shall check speeds, observe the boat path and stop the boat in the event of a dangerous condition. He shall be authorized to grant rerides, at the skier's option, for deviations in boat speeds and path along with any incorrect ballast settings as governed by Rules 7.01, 11.06 and 11.07. In a Class C tournament, the Chief Judge may designate a boat driver as the boat judge.
- D. Official Timer: There shall be a timer on shore approximately in the center of the course. Alternatively, there may be a timer stationed at each end of the trick course with devices which actuate a timing device located approximately in the center of the course. Where an automatic timing device is available which can select the median of five or three separate triggering signals, the event judges may collectively serve as the official timer.
- E. Video-Based Frame-Counting Device Operators: When using this method, two judges (minimum rating of one Regular **(J3)** and one Assistant **(J4)** for Class

E or two Assistants (**J4**) for Class C) may replace the official timer and backup timer as defined above. The two judges must agree on the starting frame and shall make a determination of the last trick completed in time. If these two judges disagree, the Chief Judge (or his designee) will resolve the disagreement. The shore judges should not be permitted to observe the display of the video-based frame counting device while the timing determination is being made by the timing officials. Video judges may perform timing duties as described in Rule 11.08B4 and 11.09C.

- F. There will be a maximum of 3 persons in the boat: driver, who normally acts as boat judge, a camera operator, and the skier's quick-release operator.

### **11.09 Timing**

- A. At the start of the trick pass, the timer shall start his timing device with an audible sound that can be heard in the event judges' tower locations. At the end of 20 seconds, he shall sound his audible device, unless the skier falls within approximately the first 10 seconds. In the event the official timer or device fails to operate, the backup timer and device shall apply.
- B. An automatic timer must be used for Record Capability Tricks events. An automatic timer that is accurate to within  $\pm .10$  seconds in 20 seconds may be used in Tricks events at a Class C tournament or below. Alternatively, a video-based frame-counting device that has been approved by the Technical Committee may be used.
- C. IF the video system allows it, the timing of the trick pass can be done by the event Judges. In this case, after the conclusion of the judging procedure, the event judges will view and agree on (by majority) the beginning of the trick pass, and the last trick in time. A completed trick shall be judged to have been in time if the part of the ski under the binder is on the water in the last frame picture.
- D. In the event both timing devices should malfunction and the time is missed, refer to Rules 11.10D and 11.20C.
- E. If a skier/representative believes that there was an error in the timing of the trick pass, he may challenge it by notifying the Chief Judge as soon as is practicable and by putting up US \$100. The Chief Judge and a designated review judge will re-time the pass. If they both agree on a revision in the timing or on the original timing, then that will be where the run will end. If they disagree or agree that the video does not clearly overrule the original, then the original timing will stand. The \$100 will only be returned if the original time was changed. If the funds are not returned to the skier, they shall be forwarded to the USA-WWF as a contribution in the skier's name.



## 11.10 Rerides

- A. Unfair Conditions: See Rules 7.01, 7.02 and 7.03.
- B. Boat Speed: A reride shall be granted if the boat judge or the boat driver observes the boat speed to vary by more than  $\pm .8$  kph (.5 mph).
- C. Boat Path: A reride shall be granted if the towboat does not follow the boat path established for the tournament (Rule 11.07).
- D. Timing Devices: In the event both timing devices should malfunction and the time is missed (or in the judgment of the majority of the event judges the time was incorrect), the judges, under the supervision of the Chief Judge, will determine the time from the official video recording provided the course entry buoys appear on the recording or a majority of the judges rule that the skier was in the course at the start of the run. If neither occurs, a reride is mandatory.
- E. Procedure:
  - 1. If a reride is granted, the reride shall be taken immediately. The reride shall then be given in the original direction through the course.
  - 2. If more than one pass in any run is disallowed for any reason, the skier shall have the option of requesting a five-minute rest before completing the run. Also see Rule 7.02.
  - 3. If a skier receives less than 20 seconds, he shall be granted the option of a reride only on the pass affected. If the skier receives more than 20 seconds, a reride is mandatory.
  - 4. When weather, tournament-supplied equipment, or some other reason not the fault of the skier causes a delay of more than ten minutes between trick passes, the skier shall be allowed an unscored warm up pass, in the opposite direction of the scoring pass to be taken, with a protected score on the first pass already completed. If a video failure is discovered after completion of both of the skier's trick passes, then the skier shall be required to reride the affected pass(es), but shall have a protected score so long as video of a pass, or portion thereof, is available. If a reride is required on the first pass due to a video failure, then the skier shall have the option of repeating his second pass, but with an unprotected score. However, the Chief Judge, with the approval of the majority of the Appointed Judges, may deny this option if there is reason to believe that further delays will preclude finishing the tournament in a timely manner or otherwise work to the disadvantage of the remaining skiers.

### **11.11 Handle Throws**

A contestant may refuse to enter the official trick course on either pass by throwing the handle in the air or by being released by the quick release operator by means of a prearranged signal before passing the entry buoy. He shall not be penalized for doing so provided the refusal was for a reason acceptable to a majority of the event judges. The skier must be ready to ski immediately upon the boat's return. Should the skier not be ready, the skier will lose one pass. If the skier's refusal is accepted, the boat must repeat the regular path and once again head for the trick course. A handle throw without cause will be considered a fall while practicing. See Rule 11.15 regarding damaged equipment.

### **11.12 Trick Descriptions Credit and Point Values**

- A. A trick is any activity that occurs between two hesitations. Hesitations are defined as the complete stopping of the ski(s) and not the body motion of the skier.
- B. To receive credit for any trick, the skier must remain in or return to skiing position.
- C. Only tricks listed in the rules will be scored in a tournament.
- D. Credit may be received for performance of only one trick and the associated reverse, if any, on one ski, and one trick and the associated reverse, if any, on two skis under each number listed. If a trick skier performs two tricks under the same number, the higher scoring trick should be credited regardless of which is performed first. Tricks may be repeated, but a repeated trick scores zero unless the judges ruled that the first attempt or attempts were unsuccessful. If the original (basic) trick is not credited, then the reverse if credited actually becomes the basic trick. If this rule is violated, only the higher scoring sequence of the repeated tricks shall be scored.
- E. A wake turn is a trick performed in mid-air while crossing the crest of the wake. A wake turn not executed in mid-air and across the crest of the wake scores zero. The ski will edge towards the wake, then the push/pop comes first then the rotation, or the push/pop and rotation come at the same time. The rotation cannot come before the push/pop. An inadvertent touch of the water with the ski tip during the rotation is acceptable on tricks with 540 degrees or more of rotation. Definition of a Pre-turn: A pre-turn is a turn off of a flat ski where the push/pop comes after the rotation has started.

All wake line tricks (WL, SL and TWL) where the ski/leg does not go over the line can be credited as wake tricks if the other wake trick criteria are met.

#### **F. Reverse Turns**

1. All reverse tricks must immediately follow the original trick in the same pass. However, any 180-degree turn is allowed between two such tricks,

with the exception of any flip that incorporates a 180-degree turn.

For trick numbers 1, 2, 3, 4, 8, and 9 only, if the original trick is creditable, but a first attempt at the reverse trick is not, the skier need not repeat the original trick before making another immediate attempt or attempts at the reverse. Therefore, the following sequences are allowable:

S, RS nc, RS credit (trick number 1)

TS, RTS nc, RTS credit (trick number 2)

B, F, R nc, R nc, R credit, R credit (trick numbers 3 and 4)

TB, TF, R nc, R nc, R credit, R credit (trick numbers 8 and 9)

For all other tricks, the reverse trick must be creditable on the first attempt following the original trick. A second attempt may not be credited without performing the original trick again first. (also see 11.12D)

1. No reverse trick shall be disallowed simply because it follows an original trick that is ruled no credit or because the original trick is a repeated trick.
  2. For trick number 5a-f, reverse tricks are allowed per rule 11.12F1.
  3. For trick number 12, reverse tricks are limited to 540 degrees, but may follow a 540-degree turn or 720-degree turn.
- G. There must be no stopping in the turning of the skis in a continuous turn.
- H. Stepmover line tricks (surface and wake) are credited only when the free foot touches the ski or water, or lifted ski touches the water. The skier may not put his leg or lifted ski across or on top of the line, the handle or either arm until he begins to execute the turn. The stepover and turn actions must be simultaneous. Immediately on completion of a FB stepover turn, the skier must have at least one arm between his legs holding the handle. It is not required that the free foot or ski touch the water prior to the execution of a stepover turn. A stepover turn not performed according to the rules for a 180- or 360-degree surface turn scores zero. See 11.12E for wake tricks)
- I. Toehold stepover tricks must be a simultaneous action. The towing foot may not touch the water during execution of the stepover portion of the turn. The touching of the towing foot in the water immediately prior to or during the rotation of the ski while attempting a stepover trick will result in no credit for the trick. However, if the towing foot touches the water after all rotation has been completed, credit will be given.
- J. All Side Slides (hand held and toe) includes a 90-degree turn from skiing position and a return to skiing position in the original direction. In order for a Side Slide to be a creditable trick, the skier must hesitate before commencing the trick, turn 90 degrees to either side, stop, return to the starting position, and stop. To perform the reverse, the skier must turn 90 degrees in the opposite direction, stop, return to the starting position, and hesitate again.

- K. A Wake Stepmover 360 consists of a 180-degree stepover and a 180-degree turn combined, in either order, all done in the air off the wake in a continuous turn. A Wake Stepmover 540 consists of a 180-degree stepover and a 360-degree turn combined, in either order, or a 180-degree stepover preceded and followed by a 180-degree turn combined, all done in the air off the wake in a continuous turn. A Wake Double Stepmover 540 consists of a 180-degree stepover and a wake stepover 360 combined, in either order, all done in the air off the wake in a continuous turn. The stepover portion of the turn must conform to all of the rules governing stepovers as noted in Rule 11.12H.
- L. In ski line tricks, both feet must be on the ski and pass over the line while in midair. The feet may pass over the line at any point during the execution of the turn. The line must be out of the water during the execution of the turn. This does not include the inadvertent hitting of the rooster tail near the boat.
- M. Trick skiers may use only one line. Helper lines are prohibited.
- N. A toe turn is the execution of a trick with the skier being towed exclusively by one foot, and upon the completion of the trick, supported by one ski.
- O. Once the skier has put the toe strap on his foot, any trick performed in which the foot in the strap intentionally touches the ski during the setup or execution of the turn shall not be scored.
- P. For wake flips with body rotation, the body rotation must be done simultaneously with the flip, not before or after. Additionally, for the BFLB, the reverse must land in the opposite wrap or turn in the opposite direction. For the BFLLB, the stepover portion of the trick must be done simultaneously with the flip and body rotation.

To receive credit for any wake flip, it is required that both feet be higher than the head and in approximately the same vertical plane at some point during the execution of the trick. A front wake flip shall be defined as a forward somersault done in the air off the wake, in which the tail of the ski passes up and over the head as the head goes down and forward. The rotation must be in the direction of travel and outside of the rope. This rule applies to Front Flips and its derivatives. (ex: FFLF, FFLB, FFLBB etc.)

The reverse BFL or FFL is defined as a BFL or FFL leading with the opposite shoulder and traveling in the opposite direction (right to left vs. left to right) from the original BFL or FFL immediately preceding it.

- Q. BFL5F and BFL5B must be done hand-to-hand. The rope may not be wrapped around the body to assist the turn. This does not prohibit the simple back position wrap where the rope does not go around the body.

### **11.13 Scoring**

- A. The scorer shall receive the judges' individual tabulations and, in the event of a discrepancy, shall decide the tricks to be scored on the basis of a simple majority. If five judges are calling the event, then three judges must give credit for the trick to be scored. Where three judges are calling the event, then two judges must give credit. The official score and placement in the event shall be determined on the basis of the total points for credited tricks performed in both passes. Score values for individual tricks are shown in the Official Trick Point Value Table in the Appendix.
- B. A trick not completed before the end of the pass shall not be scored. If a contestant's pass is concluded during the execution of a multiple-turn trick, the portion of the trick, whether continuous or not, completed before the conclusion of the pass shall not be scored.
- C. A trick completed before the end of the pass shall not be scored if the skier ultimately falls as a result of that trick, even if the fall is after the conclusion of the pass.
- D. Only tricks listed in the rules will be scored in a tournament.
- E. In the case of a multiple turn trick where the judges disagree, the contestant's score shall be based on the highest number of turns credited by the majority of the event judges.
- F. In Class E, the same requirement in IWWF Rules 9.19 and 9.21 applies. (Example- Class E/L/R: number of flips scored is limited, but is not in Class C)

### **11.14 Ties**

- A. In the event of a tie, the highest scoring single pass shall determine the winner. If a tie still exists, there shall be a new drawing for order and each tying contestant shall be allowed one pass through the trick course until the tie is broken.
- B. Ties shall be run off for the first five places at Regionals and Nationals and the first three places in all other tournaments.
- C. A two-way tie for second place would eliminate third place, while a three-way tie for second place would eliminate third and fourth places.
- D. Ties in tricks in multi-round tournaments shall be determined by the highest single round. If a tie still exists, the next highest single round, etc. If the tie still exists after all rounds, then the highest single pass, the next highest single pass, etc., shall be used to determine the winner.

### **11.15 Damaged Equipment**

If a skier notices that his equipment is damaged after a handle throw, a pass that leads to a reride or a completed pass the event judges may grant him, upon immediate request, three minutes to repair or change the damaged equipment. The three-minute period should start upon the request being granted by the judges. If the skier is not ready to ski at the end of the three-minute period, he shall not be allowed to continue in that round.

### **11.16 Tricking Equipment and Definitions**

A. Trick Judging Area: An elevated observation area that provides an unobstructed view of the trick course, at least 3 meters (10') above the water shall be provided. If an observation point is located more than 30 meters (100') from the boat path, it is recommended that the tower be elevated approximately ten percent above the water (one foot in height for each ten feet back from the boat path). Alternatively, a video feed from the boat to the panel of judges may be used.

In Class C tournaments and below, the requirement that an observation point be elevated may be waived, although it is not recommended.

B. Quick-Release Operator: A skier will be allowed the option of one person of his choice, excluding the official boat judge or driver, to act as a quick-release operator. The release person may not adjust or move the rope in any way to take up slack or allow extra length once the skier begins his trick run. He must hold it in one position or release it. Using the rope to intentionally aid the skier will subject the skier to disqualification. This person will be considered a part of the skier's equipment and be subject to Rule 7.07A.

C. Trick Release: If used, the trick release shall normally be skier-supplied equipment. However, a skier may accept a tournament-supplied release mechanism. In either case, the skier is fully responsible for any release or malfunction of the device, and no request for a reride will be granted for premature or accidental release or any other type of malfunction. A rope trick release mechanism up to 1 meter (39") may be used (see Rule 11.18B).

D. Buoys: For specifications see Rule 8.09.

### **11.17 Speed Calibration** (This rule deleted)

### **11.18 Interference by the Release Operator**

A. If the skier-supplied release person interferes vocally or physically with the duties of the boat driver or the boat judge in the first pass, then the skier will receive a score of zero in that pass and not be allowed a second pass. Interference in the second pass will result in only the first pass being scored. Communications with the skier, including coaching, after a fall or in the sit down period, are allowable, provided the communication does not interfere with the

officials.

B. In the trick event, the tow rope will be attached directly to the tow pylon or supplied trick release. Manipulation of the tow rope by the release person during the performance of tricks is prohibited. This person will be considered part of the skier's equipment and subject to Rule 7.07.C.

### **11.19 Communication Between Passes**

Skiers in the Tricks event, or other persons, shall not communicate with the judges between passes for the purpose of determining whether a trick or tricks attempted in the first pass were scored.

### **11.20 Video**

The Tricks event shall be recorded at all Class E, L and R tournaments (and other tournaments whenever possible) by a video camera from the boat. It is recommended that the camera be held/mounted higher than top of windshield to provide a clear view of the ski. If more than one video camera is used, the Chief Judge and Technical Controller shall declare one as the primary camera and one as the secondary prior to the start of the event. (See Rules 11.08A, 11.08B and 11.08F)

Video from the boat shall be used for primary judging. For judging purposes and the record review process, only video from the official camera(s) may be used. The official camera(s) may be any video from the boat as determined by the Technical Controller and Chief Judge.

The video recording may also be shown as an aid to the event judges under the following circumstances:

- A. At the request of the Chief Judge, if it is not possible for the scorers to obtain a majority decision as to the trick or tricks performed.
- B. At the request of the Chief Judge, if it is not possible for the scorers to obtain a majority decision as to whether or not credit is to be given for a trick.
- C. At the request of an event judge or the Chief Scorer, in circumstances which the Chief Judge regards as exceptional, the event judges may review the video. This request should not be granted if the intention is to change a judge's decision on credit or no credit for the trick.
- D. At the request of a majority of the event judges to determine the time for the pass (see Rule 11.10D).
- E. For all trick runs over 10,000 points for men or over 7,000 points for women, any time there is a 3-2 split on the last trick in time, a designated, qualified judge shall be appointed by the Chief Judge to review the video. If the

designated person does not agree with the decision, it will then be reviewed by the Chief Judge. If both the video reviewer and the Chief Judge agree, their decision will stand; otherwise, the event judges will have to review the video.

- F. In circumstances which the Chief Judge regards as exceptional, the Chief Judge may review the video and ask the Event Judges to look at the run again so that the correct score may be established.
- G. At the request of an event judge (and approved by the Chief Judge) the video may be reviewed to establish credit or no credit of a trick or tricks.
- H. If video is reviewed by the event judges and they are unable to decide a trick, the Chief Judge or their qualified designee will review and make a final decision.



## **RULE 12 - SAFETY REQUIREMENTS**

### **12.01 General**

No skier or official shall be allowed to participate if, in the opinions of the Safety Director and Chief Judge, the individual is under the influence of alcohol, drugs, or any other mind-altering substance, or if his participation would be a danger to himself or others. During the competition, the Safety Director may at any time request that the Chief Judge halt the tournament in regard to any skier's actions or condition.

### **12.02 Safety Responsibilities**

When applying for sanctioning of a tournament, the sponsoring affiliate shall appoint a rated Safety Director. The Safety Director may appoint such assistants as appear necessary and shall be responsible for the safe condition of all equipment and facilities, and operation of the tournament as referenced in the Official Tournament Safety Manual. He shall have the authority to take whatever action is necessary, including stopping the tournament, whenever he observes a condition he believes unsafe. The Chief Judge may overrule any contemplated action or decision of the Safety Director.

### **12.03 Waiving Specified Rest Periods**

Should the Safety Director stop a tournament for any reason, specified rest periods (Rules 7.02, 9.10, 10.10, and 11.10) shall not run so long as the tournament is stopped.

### **12.04 Safety Requirements**

Skis must be safe. There must be no unnecessary sharp or abrasive (to the touch) parts or other attachments to the ski which would possibly inflict injury to the skier should he come in contact with the ski in a fall.

### **12.05 Personal Protective Equipment**

- A. Flotation Devices: Flotation devices shall be of non-inflatable design, meeting the following specifications:
1. They must be of a smooth, soft material not likely to cause injury in a fall.
  2. They must be fastened in such a manner that they are unlikely to be torn loose, so as to render them useless in a hard fall.
  3. They must float the skier.

4. They must be constructed so as to provide adequate protection from impact damage to the ribs and internal organs. (A life belt shall not be considered adequate protection in this respect.)

All contestants in Slalom and Jumping events must wear a Coast Guard-approved Type III PFD. At the skier's own personal risk, he may wear a neoprene, nylon (or similar material) covered suit or vest specifically designed by a manufacturer for that purpose. In every instance, it must be capable of floating the skier.

- B. Protective Head Gear: Use of protective head gear in the Jumping event is mandatory. Protective head gear is defined as an article of apparel whose manufacture and use is solely for the purpose of protecting the head from injury. It is recommended that such head gear be constructed of high-impact material, have a three-point chin strap suspension, be non-bucketing and be of good fit.
- C. In the trick event, the tow rope will be attached directly to the tow pylon or supplied trick release.

### **12.06 Safety Boat**

At least one (two are recommended) safety boat(s) shall be used during all events unless a majority of the Appointed Judges and the Safety Director agree that this is not necessary, in which case safety people will be positioned on the shore. The suggested positioning of the boat or safety people is:

- A. Slalom Events: Operating outside of the course between plane of Number 2 and Number 5 skier buoys.
- B. Jumping Events: Operating on the opposite side of the ramp, outside of the jump course buoys, facing the skier's anticipated point of landing.
- C. Tricks Events: Operating outside of the course buoys, facing the skier during a pass.

### **12.07 Safety Personnel**

The safety boat rider shall have a (Coast Guard approved Type III) PFD available in the boat, for immediate use and shore swimmer(s) shall wear Coast Guard-approved life jackets which are fastened at all times.

### **12.08 Safety Director's Report and Checklist**

For the Chief Judge to receive credit for the tournament, the Safety Director's Report and Safety Director's Checklist must be completed, signed and returned with the Master Scorebook, even if no injuries occurred.

## **12.09 Drivers**

No driver of a towboat or safety boat shall pick up a ski, skier, or rope from the water with the ignition on.

## **12.10 Smoking**

Smoking is not allowed at any time in any official tournament boat (either towboats or safety boats).

## **RULE 13 - OPTIONAL TOURNAMENT FORMATS**

### **13.01 Multi-Round Tournaments**

At Record Capability tournaments and below, the sponsoring club may elect, with the express approval of the Regional Executive Vice President, to hold a multi-round type tournament. Such a tournament shall conform to the following rules, in lieu of the related rules for events, overall scoring, and contestant order:

- A. The tournament may consist of either two or three rounds of competition in each event scheduled. The announcement must state the number of rounds. Tournaments shall be limited to a maximum of three rounds of any one event on days specified in Rule 1.09.  
An alternative four round format can be sanctioned if the tournament will be held over two or more days, except as provided for in 13.02A.
- B. Subsequent rounds may be cut to a specified number of competitors based on the contestants' scores in the round(s) preceding the cut. The announcement must state the number of contestants allowed in the rounds after eliminations.
- C. Each event and overall shall be scored, for purposes of placement, by totaling the scores of all rounds for that contestant as scored under the normal rules, or at the sponsor's option, any combination of rounds may be used. The announcement shall state which of these alternatives is being followed. In regard to scoring any "combination" of rounds, the sponsor can elect to use only one round. Whatever method is used for scoring must be stated in the tournament announcement.
- D. In a multi-round tournament, no skier shall ski a subsequent round of a given division's event until all previous rounds of that division's event have been completed. It is not mandatory to ski in all rounds to be considered for placement unless the tournament announcement so states.

### **13.02 Head-to-Head and Elimination Competition**

At Record Capability tournaments and below, with the express approval of the Regional Executive Vice President (cash award requires approval of the Executive Committee), Head-to-Head or Elimination Competition may be held. A preliminary contest for seeding may be held, or seeding can be based on previous

performances, Regional, National, or World Rankings.

- A. Rounds: The tournament shall consist of no more than three preliminary, non-elimination-based rounds and no more than six total rounds. Scores obtained in all rounds shall be included in the ranking list in the same manner that non-elimination-based tournaments are included (i.e. generally the best round score). (or see 1.09C)
- B. Cutting Procedure: Each elimination round shall reduce the field of competitors advancing to a subsequent round by 50% or more.
- C. Recommended Procedures:
  - 1. Pairings: The top skiers are paired high score against low score. The high score skier may choose to go out first or second at each pairing. In Slalom, all skiers must start at the same predetermined speed and line length.
  - 2. General: In each head-to-head pair in slalom, the first skier shall attempt a pass followed by the second skier in an alternating manner until a skier misses or falls. Jumping and Tricks events may be run in the same manner.
  - 3. Boats: Two alternating boats and drivers may be used in all events. The order shall be determined by the Chief Judge.
- D. Placement: Placement shall be determined by final round scores only (see Rules 9.13, 10.13, and 11.13). The contestant with the most consecutive points, longest jump or highest score in each head-to-head pair shall be the winner of that pair. The contestant winning the pairing in the final round shall be the winner of the event. The other skier in the final pair shall be considered as the second-place skier. Third and fourth place may also be determined in an additional pairing.
- E. Ties: Ties may be determined on a round-to-round basis only and run off if required under Rules 9.14, 10.14, or 11.14. In Slalom, if the skier going second fails to exceed the score of the skier who went first, the skier who went first wins the round.

### **13.03 Turn and Burn Format**

- A. DEFINITION: In Class C, unseeded tournaments and at the discretion of the LOC, a skier may elect to begin the FINAL round of a multi-round event immediately upon the completion of **the** round **before the final round** with the same boat and crew; i.e. "turn and burn (T&B)." In a sanctioned four round tournament, "turn and burn" may only be used for the final round,

(Round four on the second or final day of the tournament).

1. Can only be offered in unseeded Class C, and F tournaments. Seeded tournaments refer to those that give awards including awards for placement. In does NOT mean the arbitrary groupings - ability and otherwise - that may be used in many slalom tournaments.
2. T&B is an OPTION for the skier - must not be mandatory.
3. Rule 13.01.D does not apply when using this format.

B. BEFORE THE TOURNAMENT:

1. Use of the T&B format should be in the tournament announcement, title or comments section. Alternatively, telephone or other electronic communication should be made with the skier prior to the tournament announcing the format.
2. In planning skier groupings and official's assignments 3 minutes should be added to the time allotment for each skier that the LOC anticipates will use the format.

C. DURING THE TOURNAMENT:

1. Skier can either:
  - a. Establish intent to T&B at the starting dock OR
  - b. Signal boat crew immediately upon completion of a round using an agreed upon signal.
2. T&B must begin at the drop area near the starting dock where all previous rounds began.
3. Skier may elect to start at any speed/line length they choose - similar to a normal round.

D. OTHER CONSIDERATIONS:

1. Officials and tournament directors should be aware of the planning needed to make this format run smoothly.
2. There must be excellent communication between tower officials, scorers and boat crew during last two rounds.
3. LOCs in regions that allow regional records to be set in Class C tournaments must be sure that this format does not clash with those policies.

### **13.04 Mini Course:**

At the option of the LOC in Class C tournaments and below, skiers may choose to ski mini course buoys:

- A. Mini course buoys, preferably green in color, are to be placed by the LOC at approximately 8.5 meters from center-line of the slalom course. However, there is NO required measurement or specified tolerance. NOTE: The slalom course for the disabled is 6.4m from center-line.
- B. Each mini course buoy is scored as 1/2 point. To get credit, the skier must go through the entry gates, around the mini course buoy and then cross the boat guide line closest to the buoy. No partial credit is awarded for mini course buoys.
- C. A mixture of mini course buoys and full course buoys can be used to attain a score. The mixture must be of consecutive buoys. Once a buoy is missed (either mini and/or regular) no more buoys are counted in the scoring of that pass.
- D. Mini course scoring will only be used on the first pass in Class C.
- E. A skier must make 6 full buoys to get a second pass in Class C.

### **13.05 Other Optional Tournament Formats**

For other possible formats see [www.usawaterski.org](http://www.usawaterski.org)

## **RULE 14 - RECORDS**

### **14.01 AWSA Recognition**

The AWSA shall recognize records for slalom performances, jump distances, and trick performances for each division listed under Rule 3.02 in tournaments of Record Capability only. (Specific requirements for conducting a Record Capability tournament appear in Rule 15.) Only US Citizens, with USA-WSWS Full Active Membership are eligible to set AWSA records. For citizens of other countries (with dual citizenship) to set AWSA Record reference Rule 1.13. U.S. skiers may set AWSA records in international tournaments shown to meet the standards of a tournament of Record Capability. Run-offs of ties are used solely for determining placement; therefore, a run-off performance is not eligible for consideration as a record. The AWSA National Record Review Board will accept the IWWF result (approved/rejected) of any U.S Skier performance that meets the IWWF World Record (Open/U17/U21) requirements and has been submitted as an IWWF World Record.

An AWSA National Record may equal but shall not exceed an IWWF World Record for that division.

## **14.02 Performance Requirements**

For any division, the longest jump distance, highest slalom score, or highest trick score in a round of a tournament of Record Capability shall be considered for a record if it equals or exceeds the official record performed before that round of the tournament. A skier competing in the Open or Masters Division may have his performance recognized as a record for his respective age division, provided the performance is accomplished under conditions consistent with the requirements for that age division. If more than one performance in a round of a tournament equals or exceeds the official record performed before that round of the tournament, all such performances shall be submitted for consideration, although only the highest of those which satisfies the review requirements shall be recognized. Open Division jump records shall be listed in meters and must exceed the existing record by at least 10 centimeters. Eligible performances which equal an existing record (other than by a current holder of that record) may be recognized, whereupon that skier would become co-holder of the record. For a National Record, the performance must have occurred at a speed no greater than the division's maximum speed. (also 10.06D)

Whenever a new age division is created, or a change is made in the age ranges for an existing division, or a change is made in the performance conditions for an event for an age division, a benchmark score shall be established for that event, unless that benchmark would be lower than the existing record. This benchmark shall be established jointly by the Skier's Qualification and Technical Committees.

When a benchmark score is used to establish a basis for setting records, it shall not be considered as the event record. Only scores that equal or exceed the benchmark shall be considered for a record.

## **14.03 Site Specifications**

Specifications of equipment, courses, measuring devices and methods shall be set in accordance with the Rule Book and shall be recorded on AWSA Record Forms, to be completed and certified by the Chief Judge and other required officials. Additional requirements specific to Record Capability tournaments (beyond the normal requirements listed throughout this Rule Book) are listed in Rule 15.06.

## **14.04 Record Forms**

Record forms shall be devised in accordance with these rules by the Technical Committee approved by the Board of Directors. All requirements for the record submission and approval process will be set forth in the official application form. For World Records, Reference IWWF Rule Book.

- A. For a National Tricks record to be considered, the official video must be reviewed by the judges. Subsequent to the scoring of an event and the existence of a tentative record, the judges for the event shall review the video to determine the scoring of the record on the basis of the video. Any changes in the scoring resulting from this review shall not change the results of the

tournament itself (although the provisions of Rule 11.20 may otherwise result in official scoring changes). The video and the original judges scoring sheets shall accompany the record application. The Record Review Board (RRB) (9 members) will review the video in real time to determine the results, the Technical Chairman or his designee to verify timing.

- B. For a National Slalom record to be considered, EC video/EC data (BPMS) of the boat path are required (Reference IWWF Rule 8.15.). The EC video/EC Data (BPMS) shall accompany the record application. In addition, for Elite Division National Record in OM and OW, video from the boat for the last two passes shall be submitted.

For National Slalom records the final two passes of boat path BPMS Data will be examined by the tournament Chief Judge and Chief TC to verify boat path is within specification per IWWF Rule 8.15 (preliminary approval). If EC video is used, the EC video will be examined by the Technical Chairman or his designee to verify that the boat path is within the deviation specified in IWWF Rule 8.15 and 25.0.

- C. For a National Jump record the Chief Judge and Chief TC shall review the captured jump to verify setup (grid) and distance (preliminary approval). The completed application shall be submitted to TC Chairman. The setup and jump capture files that are appropriate from the system being used should be saved for one year but are not required to be submitted.

#### **14.05 Application Procedure**

- A. It shall be the skier's responsibility to promptly notify the Chief Judge, or other event judge, if he believes his performance may qualify as a record.
- B. It shall be the Technical Controller's responsibility to complete the record application form, with assistance from the Chief Scorer and Chief Judge and other event or appointed officials, as may be required by the Record Form. The completed Record Form and other required materials, as specified in the Record Form, shall be sent by the Technical Controller to the Chairman of the Technical Committee within 15 days of the date of the performance. In addition, the Technical Controller of the tournament shall send notification of the performance to the Chairman of the Technical Committee within 7 days of the performance. After review, the Chairman shall forward recommendations, to the AWSA President for final approval.



## **RULE 15 - RECORD CAPABILITY TOURNAMENTS**

### **15.01 Tournaments at Which AWSA Records May Be Set**

AWSA records may be set at World Championships, National Championships, Record Capability Regional Championships, and other tournaments meeting the standards for Record Capability. There are three classifications of Record Capability tournaments, whose applicability and requirements are summarized in the chart that appears in the Appendix. Class L and R tournaments must meet or exceed the standards of the IWWF Rule Book, and must be sanctioned by the Pan American Region of the IWWF, as well as by USA Water Ski.

- A. National Championships: The National Championships must meet the qualifications of a tournament with Record Capability, and it shall be the responsibility of the Chief Judge and other Appointed Judges to determine that it does so qualify.
- B. Regional Championships: The Regional Championships are encouraged to meet the qualifications of Record Capability. It shall be the responsibility of the Regional Council to determine if it wishes to impose these standards on the Regional Tournament and, if imposed, it shall be the responsibility of the Chief Judge and other Appointed Judges to determine that it does so qualify.
- C. Tournaments with Record Capability: Tournaments with Record Capability shall be specifically sanctioned tournaments meeting standards as detailed below and summarized in the Appendix.
- D. A tournament sanctioned at one of the three levels of Record Capability may conduct individual events at a lower sanction classification than that of the tournament as a whole. In such cases, the applicable classification code must be indicated in the official scorebook for each skier performance listed.

### **15.02 Sanction and General Tournament Organization**

- A. The sanction application for a tournament with Record Capability (Class E or L) must be submitted directly to USA-WSWS Headquarters no later than seven days prior to the scheduled start of the tournament. Record Capability Class L & R tournaments must also be sanctioned by the Pan American Region of the IWWF.
- B. In order to produce a Record Capability tournament, a tournament shall have at least one USA-WSWS affiliated club as one of the sponsors.
- C. Divisions and events to be scheduled shall be at the option of the tournament sponsors and may include any or all of those included in Rule 3.02.
- D. Exceptions to the rules allowed as under Rule 1.11 are permitted and will be approved in the manner specified in the rules.

- E. Tournaments may have multiple rounds as permitted by Rule 13.
- F. Tournament site hosts planning on using the IWWF L & R formats for the benefit of their skiers should prepare their sanction application, tournament announcement, and registration procedures according to IWWF and AWSA stipulations that include, but are not limited to, the following:
  - 1. Sanction must be submitted such that the notification of the tournament appears on the IWWF calendar for all Class R Record Capability events 15 days prior to the tournament.
  - 2. The maximum number of rounds, which can count for the IWWF rankings list or records, is limited to four (in each of slalom, trick and jump) at any one competition – meaning consecutive days at the same site.
  - 3. For L & R homologation purposes, a tournament or tournaments with an allowed maximum of four rounds must be followed by three whole days before the next L & R tournament can start at the same site code.
  - 4. At USA-WSWS/AWSA sanctioned tournaments, rounds are limited to three per sanction per day. The four round format must be sanctioned and held over two or more days.
  - 5. Where L & R rounds are not specified in advance through sanctioning, registration or scoring in a multi-round tournament, IWWF will select the first four rounds skied in the tournament or tournaments for its ranking list.
  - 6. Additionally, skiers should be aware of how their performances determine a ranking on the IWWF World Ranking list.
    - a. Ranking is based on the average of each skiers' two best scores from two separate tournaments and two separate sites.
    - b. Only one score in each event is considered from each tournament.

### **15.03 Certification of Competition Courses**

- A. The Technical Committee shall devise and publish standards for the certification of competition courses. Such standards shall require that all slalom and jump course buoys and the jump ramp and meter station pivot centers be located by appropriate survey methods. The inter-relationships among these objects shall be derived therefrom, and must be within the location tolerances shown in the Official Slalom and Jump Course Diagrams in the Appendix.

- B. The competition slalom and jump courses required for the events scheduled for the tournament must be certified in advance of the tournament by either one of the following two procedures:
1. The slalom course and the jump course shall be surveyed by either a licensed surveyor, acting as such, or by a person independent of the tournament sponsors who satisfies the Chairman of the Technical Committee as to his competence prior to the survey, no more than 90 but no less than 30 days prior to the tournament. The survey and supporting detail shall be forwarded to the Appointed Technical Controller for the tournament at least one week prior to the tournament.
  2. Alternatively, the Appointed Technical Controller may certify the courses by his own survey prior to the tournament, and shall attach that survey and its computer analysis showing the actual buoy locations to the Technical Controller's Report from the tournament, along with any adjustments which were made.

#### **15.04 Technical Controller**

- A. Each tournament with Record Capability shall require a rated Technical Controller, ***who shall be considered the Chief Technical Controller.***
- B. It shall be the responsibility of the Technical Controller to determine, by methods he believes to be required under the circumstances, that the courses continue to be certified prior to the start of competition. The Technical Controller shall continue to be responsible for the certified condition of the competition courses throughout the tournament and must sign a statement at the conclusion of the tournament that, in his opinion, the courses were entitled to certification throughout the tournament.
- C. Standards devised by the Technical Committee for the position of Technical Controller, along with a handbook of instructions for his guidance, may be considered a part of this Rule Book.

#### **15.05 Qualifications of Officials**

- A. The Chief Judge shall be a Senior **(J2)** Judge, and may serve as an event judge. The other Appointed Judges shall be either Senior **(J2)** or Regular **(J3)** Judges. The Chief Boat Driver shall be a Senior **(D2)** Driver. The Chief Scorer shall be a Senior **(S2)** Scorer. All chief officials (Chief Judge, Chief Driver, Chief Scorer, Chief Technical Controller and Chief Safety Director) shall be separate individuals.
- B. Throughout these sections where designations of officials' classifications are used, officials with equivalent or higher certified ratings by a region or federation of the IWWF as determined by the Rules, Judges and Scorers, and Drivers Committees may be used. (See Rule 6.10.)

- C. All positions described in the rules as “judges” shall be filled by Senior **(J2)** or Regular **(J3)** Judges. In Class E Jumping events, one of the two shore judges may be an Assistant **(J4)** Judge. In Class E Slalom events, an Assistant **(J4)** Judge may replace one of the two slalom tower judges in each tower when 5 judges are being used. In class E trick events, an Assistant **(J4)** Judge or a Regular **(D3)** or Senior **(D2)** Driver may serve as a boat judge. All boat drivers shall be Senior **(D2)** or Regular **(D3)** Drivers. All scorers shall be Senior **(S2)** or Regular **(S3)** Scorers. In Class E Slalom and Jumping events, event scorers may be Assistant **(S4)** Scorers. For Ranking List (Class L) tournaments, the majority of the event judges (3 of 5 in Slalom, 3 of 5 or 3 if video available in Tricks, and 2 of 3 in Jumping) must be Senior **(J2)** Judges. For Class R tournaments, which may qualify possible world records, all of the event judges in Slalom (5), Tricks (5 or 3 if video available), and Jumping (3) must be Senior **(J2)** Judges.
- D. The following minimum qualifications shall be required of other officials in the Slalom event:
- Backup Timer: Assistant **(J4)** Judge. Regular **(D3)** and Senior **(D2)** Drivers may be considered Assistant **(J4)** Judges for purposes of this requirement only.
- E. The following minimum qualifications shall be required of other officials in the Jumping event: See Tournament Classification Requirements of officials needed.
- F. The following minimum qualifications shall be required of other Officials in the Tricks event.
1. Trick Timer: Regular **(J3)** Judge
  2. Backup Timer: Assistant **(J4)** Judge
- G. Official’s Conflict of Interest: Conflicts of interest, as defined by the following, shall not be permitted in Record Capability or Cash Prize tournaments.
1. An official for an event shall have no conflict of interest with respect to any skier competing in that event. For this purpose, “official” shall include boat drivers, event judges, scorers and all secondary positions.
  2. At least one-half of the Appointed Judges shall have no conflict of interest with any skier competing in the event. If a conflict of interest exists, the appointed official so affected shall not rule.
  3. The appointed officials to the Team Trials must have no conflict of interest with any skier competing in the Trials.
- H. A conflict of interest shall be regarded as existing if the official is:

1. A member of the immediate family of a contestant, to include lineal descendants and ancestors, brothers, sisters, and spouses of the contestant or any of the above family members.
  2. In a position which may give the appearance of a lack of independence. These conflicts shall be determined by the Chief Judge with respect to event officials and by the Appointed Judges with respect to the Chief Judge and other appointed officials.
- I. Record Capability tournaments shall require a minimum of five Appointed Judges in addition to the Chief Judge.

### **15.06 Technical Requirements**

Reference IWWF Rule 25 (Homologation Guidelines).

Reference IWWF Rule 8.15 for Slalom EC and Boat Path Monitoring System (BPMS)

The video/data file shall be uploaded to the AWSA website (Technical Controller Resources-EC Video) as soon as possible (within seven days is expected) after the competition. Alternatively, the video file can be loaded to a USB thumb drive and forwarded to a designated Regional representative who will upload the file to the AWSA website. The Regional Council may cancel results that do not conform to Rules 1.12, 10.07 and 15.06. In addition, the scorebook and tournament results may be withheld from posting until such time as the video file is uploaded to the website. If the EC Data file is electronically uploaded to WSTIMS from BPMS, the EC Video does not have to be loaded on the AWSA website.

## **RULE 16 - CASH PRIZE TOURNAMENTS**

### **16.01 General**

- A. Any and all divisions may be scheduled.
- B. A notice similar in content to the following should be printed on the entry form: "USA-WSWS hereby notifies all officials, water skiers and their guardians that participation as a contestant or official in a water ski show, exhibition, or tournament where awards of money or products are given may adversely affect their amateur standing in any or all sports."
- C. Organizers should be aware that it may be required that cash prizes be paid directly to the President of the skier's IWWF region or to the skier's national federation. Organizers must agree that upon request of any competitor or national federation this condition will be honored.
- D. All Chief officials (Chief Judge, Chief Driver, Chief Scorer, Chief Technical Controller, and Chief Safety Director) shall be separate individuals.
- E. Any AWSA Club organizing a tournament with a cash prize may petition the Executive Committee for permission to conduct the tournament under rules exceptions. This petition, along with the entire rules exception proposal, must be

submitted to the Executive Committee at least 21 days before the tournament, and must be acted upon by the Executive Committee within 7 days. Upon written approval the rules exceptions must be included in the tournament announcement, and referenced in mailings to all participants. The AWSA sanction fee will be established by the Executive Committee on an individual basis.

# Appendix

## Rules Interpretations

### Team Qualifications

Each region will determine the teams that compete at the Regional Championship. The top 2 teams from each region will go on to Nationals to compete for the National Team Title. The team championship is NOT a separate event; rather points are accumulated while the team skiers compete in their individual divisions/events.

Each region has a commissioner and each team will have a captain that selects the skiers on the team.

Each team shall be comprised of 5 men, 5 women, and 5 juniors from the same state/area across Slalom, Trick and Jump. All three events are included in the scoring. The members of the teams do not need to be qualified for Regionals, and they do not need to be qualified for Nationals.

The top 4 scores for each event (Slalom, Trick, Jump) for each group (Men, Women, Juniors) will be used for determining the Team Scores.

The scores will be generated through a placement point system based on NOPS. The top 4 scores for each team in each event would be accumulated to become the team score.

Substitutions between Regional Championships and National Championships are allowed at the discretion of the Regional Commissioner. Any substitute on a team must be from the same area/state and must have skied in the Regional Championships. For further details, refer to the team skiing details on [www.usawaterski.org](http://www.usawaterski.org).

### 2021 MasterCraft Weight System:

- Weight bags must be approved by the boat owner before using in their boat.
- Weight bags must be placed in the rear compartment trays as designated by MasterCraft.
- No weight bag changes will be allowed between a skier's first & second pass.
- Weight bags can be taken in/out between skiers to any of the approved configurations (No weight, 100 lbs., or 200 lbs.).
- No additional ballast is allowed.
- Tournament supplied weight in 8.02(B)(2) may be used for balancing the boat.

## [2025 IWWF/AWSA Rules Differences](#)

These are the most significant differences between the current IWWF and AWSA rules as they apply to the running of the actual events of Slalom, Tricks, and Jumping, as opposed to the administration of a tournament. Refer to AWSA Rule 1.01 for the use of AWSA and IWWF rules in Class L and R tournaments. These differences should not have any changes that effect the criteria in performance when skiing class E/L/R.

### A. **General:**

1. **Number of rounds and site limitations** (IWWF Rule 24/AWSA 1.02/1.09): AWSA allows 3 rounds per tournament per day with no limitations for sites or four rounds over two or more days. IWWF allows no more than four rounds per tournament and limits the sites to a maximum of four rounds with three days between tournaments.
2. **Unfair Conditions** (IWWF Rule 12/AWSA 7.01): AWSA Rules protect scores on an optional reride in the case of a malfunction of tournament-supplied equipment. IWWF Rules also protects, but with some restrictions. ***All events are allowed an unscored warm up pass between passes if there is a delay of 10 minutes or more. See also AWSA 10.10E4a.***

### B. **Slalom:**

1. **Rope Length/Speed** (IWWF Rule 8.01/AWSA Rule 10.06): AWSA allows the skier the option to surpass maximum speed for the division up to his respective Open Division maximum speed (In Class C tournaments). IWWF only begins scoring a skier's pass at 18.25M and does not allow scores for speeds above division maximum. Long line is allowed but just not counted.
2. **Handle Throws & Damaged Equipment** (IWWF 8.04/AWSA 10.11 & 10.15): AWSA Rules allow handle throws and requests for damaged equipment time-outs between passes. IWWF Rules allow a handle throw between the starting dock and the entry gate on the first pass. There are still stipulations once entering the course for damaged equipment time-outs on passes leading to a re-ride.
3. **Slow Time and Scoring** (IWWF 8.05/AWSA 10.10B1): At class C and below, AWSA allows an improvement in score on a slow time, and matches IWWF for Class E, IWWF allows improvement if the speed is so slow that it is equal to or below the fast tolerance of the next slower pass.
4. **Delays over 10 minutes** (IWWF 12.02/AWSA 10.10E4) Both state that if there is a delay of 10 minutes or more the skier may take an unscored up slalom pass. AWSA also lets the slalom skier start over with an



unprotected score. (See Rule 10.10E4 for time constraint options)

### C. Tricks:

1. **Practice Falls** (IWWF 9.05/AWSA 11.04B): Under IWWF Rules, no practice falls are allowed. The handle throw rule is the same. Practice falls are only allowed in Class C.
2. **11,000 Point Runs** (IWWF Rule 24) Any trick score over 11,000 points that is submitted to the Ranking List must be either a) performed in a "Record Capability" competition or b) performed in a "Ranking List" competition and be ratified by a three-judge panel appointed by the World Waterski Council.
3. **Six Flips** (IWWF 9.21g/AWSA – Not Applicable): IWWF limits the number of scored flips to six and AWSA does not in Class C. A skier may attempt more than six flips under IWWF but only the highest scoring six will be scored.
4. **Rerides** (IWWF Rule 12/AWSA 11.10) In some circumstances AWSA allows the skier to reride both passes when the first pass is affected. IWWF only allows rerides on the pass or passes affected. (See Rule 11.10 for time constraint options)

### E. Jumping:

1. **41meter segment Timing** (IWWF 10.06/AWSA 9.09): AWSA requires timing of the 41m segment in all instances. IWWF only requires that the 41m segment speed does not exceed the division maximum when using their optional (fast 41m segment) method in cases where the speed is below the division maximum. IWWF requires three-segment timing of 52m – 82m – 41m **for certain divisions and distances**, while AWSA requires reporting 3 segment jump times, although using two segment timing of 82m and 41m as controlling.
2. **Jump Distances and Outcomes** (IWWF 10.12/AWSA 9.03): IWWF requires the judge offer the skier a reride in the event the distance is not communicated or is miss-communicated to the skier. The reride may or may not be protected as determined by the judges. AWSA requires that the outcome of each jump, including any reride situations, be communicated to the skier, but does not require the judge to offer a reride if there is a failure in this procedure.
3. **Shore Officials (IWWF 10.12/AWSA 9.08): IWWF requires three judges for event but they can be on shore and/or measurement judges with a view of the jump course. AWSA Shore judges are not required, but can be appointed by Chief Judge.**

## Officials Development Program Disciplinary Procedures

*(Judges • Scorers • Drivers • Safety Directors • Technical Controllers)*

With each step, written approval of two-thirds of the Appointed Judges is required to take action against an official, and this approval must be recorded and included in the report to the appropriate entity as specified below.

### **First Offense to be but Not Limited To:**

- On-site notification and warning by the Chief Judge with written report of action to committee chair

The record of this offense will be removed from the official's file in one year from the date of infraction provided no further offenses occur.

### **Second Offense to be but Not Limited To:**

- Letter of reprimand from the entire committee
- Not officiate at the immediate next Regionals or Nationals, or both, after the date of the letter of reprimand, with written report of action to Sport Division President

Providing no further offenses occur, and without removing the record of this offense from the official's file, the time limit on this offense for further discipline will end two years from the date of infraction.

### **Third Offense to be but Not Limited To:**

- Letter from Sports Division President
- Downgrade mandatory with written report of action to Sport Division Board of Directors

Providing no further offenses occur, and without removing the record of this offense from the official's file, the time limit on this offense for further discipline will end three years from the date of infraction and the official may start work from the beginning on the rating lost.

### **Fourth Offense to be but Not Limited To:**

- Board of Directors to vote on complete loss of Officials rating.

After three years from the date of infraction, the official may start over again with the application process at the Assistant rating level.

All disciplinary procedures and actions must comply with the bylaw articles regarding ineligibility of participation, grievance, and due process. These procedures are not intended for the occasional honest mistake, only for those habitually breaking the rules.

The following are examples of violations, but are not all-inclusive:

- All Officials:**
1. not following the rules in order to enhance skier performance or site reputation by:
    - abusing any tolerance (Rule 1.12, etc.)
    - allowing abuse of any tolerance without reporting it or taking corrective action, if appropriate;
  2. not following the rules after having been notified of the problem;
  3. not following the rules tournament after tournament;
  4. Engaging in verbal or physical abuse of other officials or tournament personnel.

- Judges:**
1. manipulating the timing in tricks to give the skier more or less than 20 seconds
  2. knowing that the speed deviation was more than ½ mph and not granting a reride

- Scorers:**
1. intentionally giving a skier or group of skiers a better or worse score in any event or overall
  2. manipulating the points and credits in scoring tricks to produce more or less points for a skier or group of skiers

- Drivers:**
- Driving to enhance skier performance with:
- consistently slow times during a Slalom event with one or a group of skiers
  - a boat path consistently favoring or disfavoring one or a group of skiers
  - consistently fast times during a Jump event with one or a group of skiers

- Safety Directors:**
- Not following the rules as written in the official AWSA Tournament Safety Manual by:
- not checking skier equipment, the jump ramp or the starting dock
  - not using safety boat and personnel as prescribed

- Tech. Controllers:**
- Setting up the ski site in violation of the rules to enhance skier performance by:
- setting slalom courses too narrow
  - allowing the use of excessively long slalom towropes
  - allowing timing systems to be operated without prior checking
  - filling out record application forms incorrectly
  - setting up the ramp incorrectly

## Tow Line Dimensions

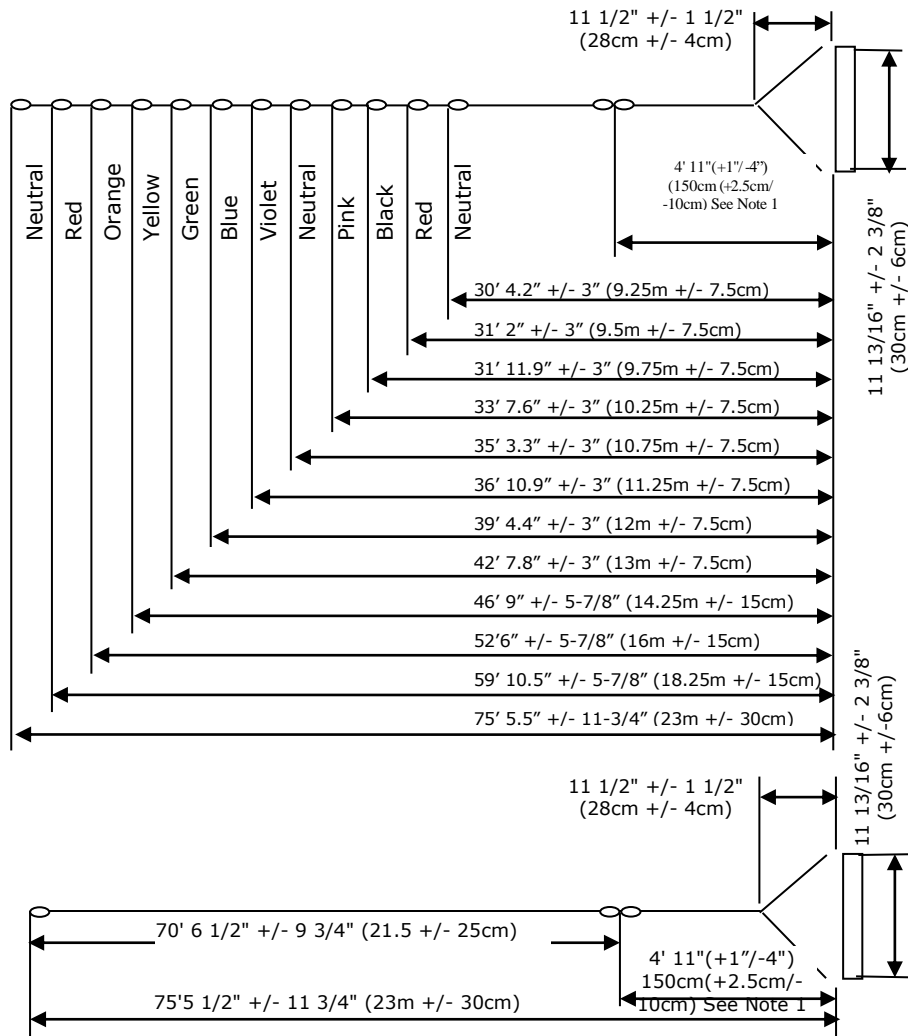

**\*Note:**

- 1) For tournament-supplied handle sections, the bridle length should be 150cm (-2.5cm)((4'11") (- 1"/0")) inside handle to inside loop with 20 kg (44lb) load.
- 2) For skier-supplied handles in the Slalom and Jumping event, the bridle length may be 150cm (+2.5cm/-10cm) ((4'11")( +1"- 4")) inside handle to inside loop with 20kg (44lbs).
- 3) The maximum bridle length of all SLALOM handles after skiing is 152.5cm (5'- 0") with 20kg (44lb) load.
- 4) All measurements are from inside the handle to inside of loop.
- 5) The loops/segments shall be color coded to help differentiate between them. The colors should be clearly visible and clearly distinguishable as shown.

## Official Slalom Course

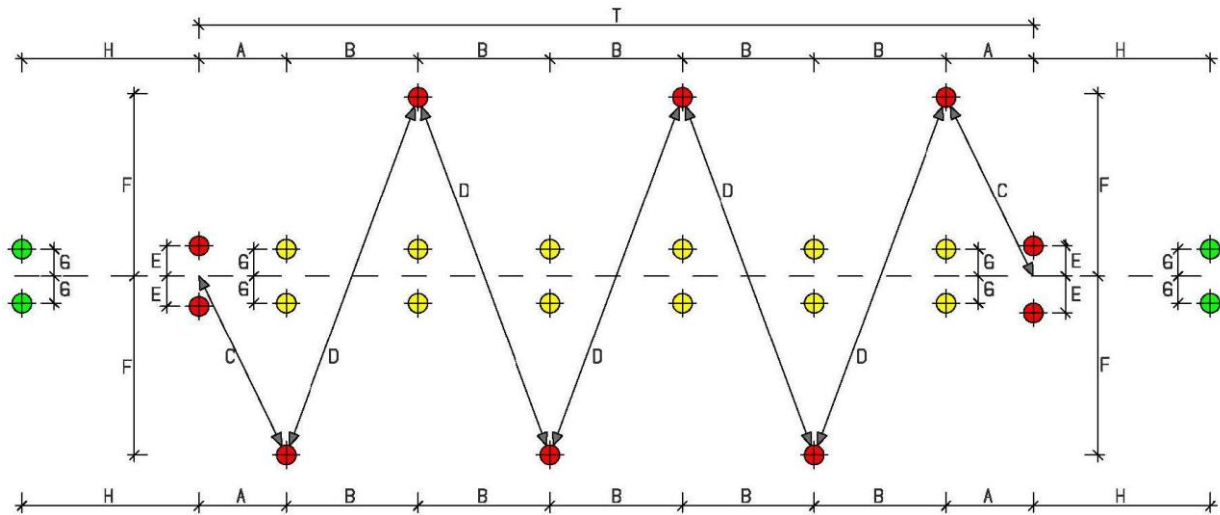

Dim	Metric			English					
	Actual	Minimum	Maximum	Actual		Minimum		Maximum	
<b>OA</b>	259m	258.353m	259.648m	849'	8 <sup>7</sup> / <sub>8</sub> "	847'	7 <sup>3</sup> / <sub>8</sub> "	851'	10 <sup>3</sup> / <sub>8</sub> "
<b>A</b>	27m	26.865m	27.135m	88'	7"	88'	1 <sup>5</sup> / <sub>8</sub> "	89'	1/4"
<b>B</b>	41m	40.795m	41.205m	134'	6 <sup>1</sup> / <sub>8</sub> "	133'	10 <sup>1</sup> / <sub>8</sub> "	135'	2 <sup>1</sup> / <sub>4</sub> "
<b>C</b>	29.347m	29.2m	29.494m	96'	3 <sup>3</sup> / <sub>8</sub> "	95'	9 <sup>5</sup> / <sub>8</sub> "	96'	9 <sup>1</sup> / <sub>8</sub> "
<b>D</b>	47.011m	46.776m	47.246m	154'	2 <sup>3</sup> / <sub>4</sub> "	153'	5 <sup>3</sup> / <sub>8</sub> "	155'	1/8"
<b>E</b>	1.25m	1.188m	1.313m	4'	1 <sup>1</sup> / <sub>4</sub> "	3'	10 <sup>3</sup> / <sub>4</sub> "	4'	3 <sup>3</sup> / <sub>4</sub> "
<b>F</b>	11.5m	11.385m	11.616m	37'	8 <sup>3</sup> / <sub>4</sub> "	37'	4 <sup>1</sup> / <sub>4</sub> "	38'	1 <sup>3</sup> / <sub>8</sub> "
<b>G</b>	1.15m	1.035m	1.265m	3'	9 <sup>1</sup> / <sub>4</sub> "	3'	4 <sup>3</sup> / <sub>4</sub> "	4'	1 <sup>3</sup> / <sub>4</sub> "
<b>H</b>	55m	54.725m	55.275m	180'	5 <sup>3</sup> / <sub>8</sub> "	179'	6 <sup>1</sup> / <sub>2</sub> "	181'	4 <sup>1</sup> / <sub>4</sub> "
<b>Tolerances (±)</b>									
				1/4% on 259m		5% on E			
				1/2% on A,B,C,D,H		10% on G			
				1% on F					

All Record Capability tournaments (E/L/R) including Regionals and Nationals shall include green boat path alignment gates (PG1-PG4). Their use is recommended at all other events.

Gates and turn buoys should be orange (recommended) or red in color.

Interior boat guides are to be yellow.

## Tow-Pylon Specifications Diagram

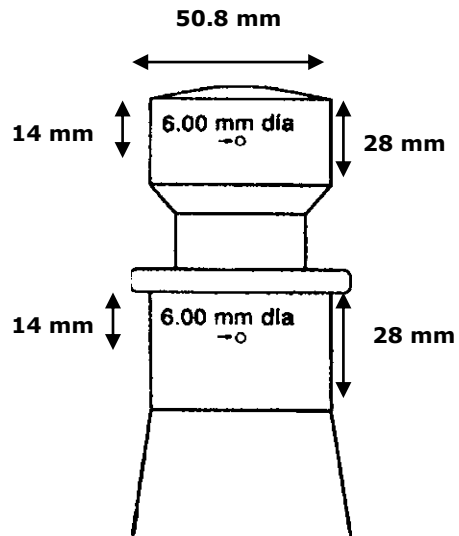

## Handle Measuring

Block edge furthest from the attaching loop is the official measurement point for ALL handles, both curved and straight.

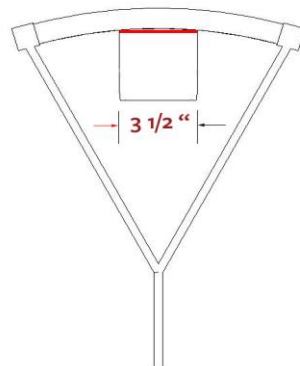

# Official Jump Course Diagram

## Official Jump Course

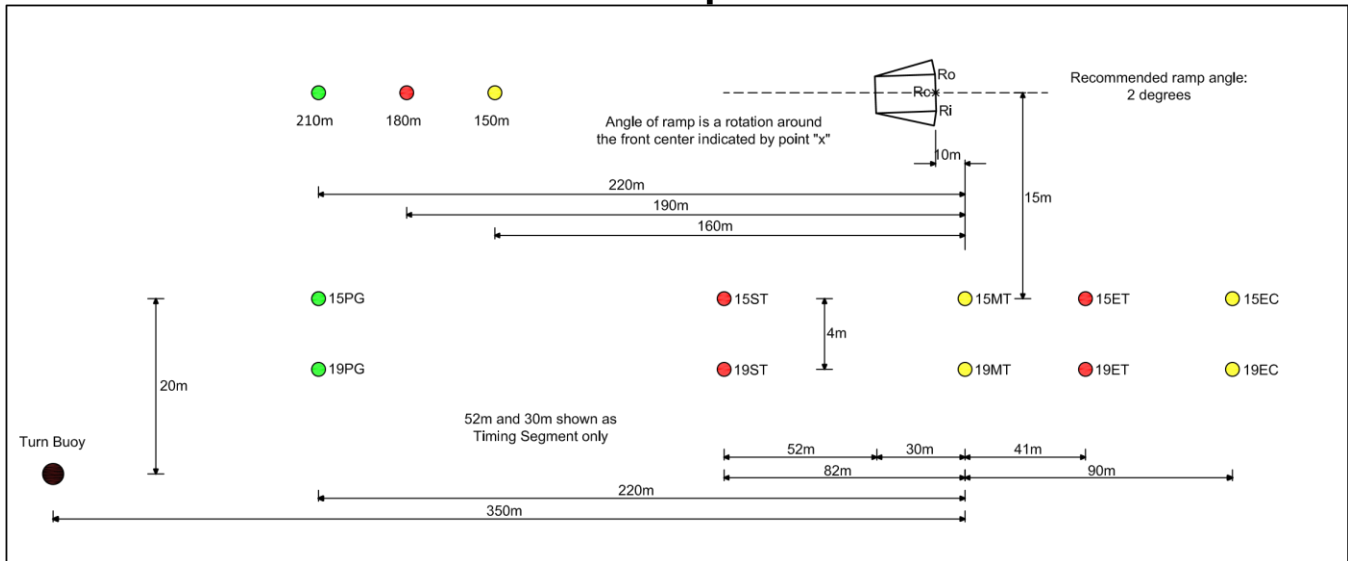

The ramp must be parallel to the jump course and slightly open.

The tolerance for standard jumping is between +1.00° and +2.50° open.

The tolerance for ski flying is between +5.00° and +7.00° open.

Open means that the low end of the ramp is turned toward the jump course.

Any marker buoys used for video distance measurement or spectator reference buoys must be a minimum of 8m from the ramp centerline for safety purposes so that they will not interfere with the skier while landing.

### JUMP COURSE DIMENSIONS AND TOLERANCES

Buoy	Color	Length from Y Axis	Tolerance	Width from X Axis	Tolerance
15PG	Green or Yellow	220m (721.8ft)	+/- 30m (1ft)	0m	+/- 10cm*(3.9in)
19PG	Green or Yellow	220m (721.8ft)	+/- 30m (1ft)	4m (13.1ft)	+/- 10cm*(3.9in)
210m	Green	220m (721.8ft)	+/- 2m (6.6ft)	15m (49.2ft)	+/- 0.5m (1.6ft)
180m	Red	190m (623.4ft)	+/- 2m (6.6ft)	15m (49.2ft)	+/- 0.5m (1.6ft)
150m	Yellow	160m (524.9)	+/- 2m (6.6ft)	15m (49.2ft)	+/- 0.5m (1.6ft)
15ST	Red	82m (269ft)	+/- 40cm (1.3ft)	0m	NA
19ST	Red	82m (269ft)	+/- 40cm (1.3ft)	4m (13.1ft)	+/- 10cm*(3.9in)
15MT	Yellow	0m	N/A	0m	N/A
19MT	Yellow	0m	+/- 20cm (0.7ft)	4m (13.1ft)	+/- 10cm*(3.9in)
15ET	Red	41m (134.5ft)	+/- 20cm (0.7ft)	0m	+/- 10cm*(3.9in)
19ET	Red	41m (134.5ft)	+/- 20cm (0.7ft)	4m (13.1ft)	+/- 10cm*(3.9in)
15EC	Yellow	90m (295.3ft)	+5m(16.4ft)/-10m(32.8ft)	0m	+/- 10cm*(3.9in)
19EC	Yellow	90m (295.3ft)	+5m(16.4ft)/-10m(32.8ft)	4m (13.1ft)	+/- 10cm*(3.9in)
Ramp R		10m (32.8ft)	+/- 20cm (0.7ft)	15m (49.2ft)	+/- 15cm(5.9in)

The X AXIS is a straight line that runs through the 15ST and 15MT buoys. All width dimensions are from the X AXIS. The Y AXIS is a perpendicular line to the Course X Axis passing through the 15MT buoy (0,0). All length dimensions are from the Y AXIS.

It is recommended that all course buoys to be within +/- 5 cm vs +/- 10 cm to ensure course is visually straight.

For Class L/R Pre-Gate boat guide buoys are required unless the Chief Judge with the concurrence of the Chief Technical Controller determines that pre-gate buoys are not feasible, in which case, the Technical Controller shall note such in the homologation dossier.

Placement of the Pre-Gate Buoys should be taken into consideration and not interfere with the skier's counter cut. An optional turn buoy is recommended at approximately 350m from the Y Axis and 20m from the X Axis.

# Ramp Setting Chart

**Scale: one small division= 1/4 inch**

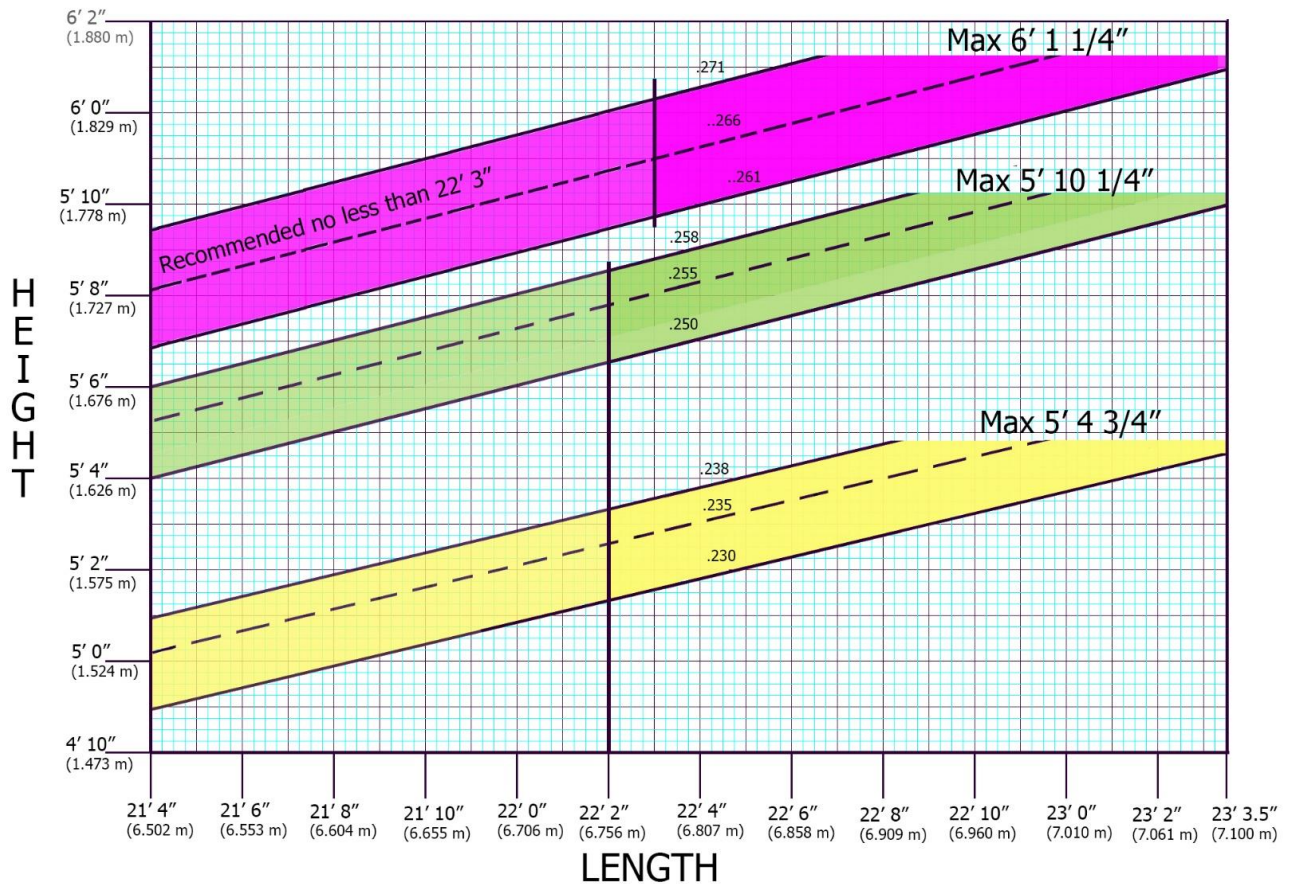

Metric measurements in ( )

**Instructions:** Calculate the ramp angle ratio for any particular setting by taking the Height at top edge dividing it by the Length out of water. The calculated ratio must be within the specified tolerance as indicated **in Section 9.16/below** and as highlighted in the area above. The dotted line is most desirable (0.235/0.255/0.266). The graph is only a guide. Length under water must be a minimum of 50 cm (20").

Ramp Ratio	Minimum Length out of Water	Maximum Length out of Water	Recommended Length out of Water	Max Height (See 9.16 for recommended)
5ft 0.235 (+0.003/-0.005)	6.50m (21'-4")	7.00m (22'-11 9/16)	6.80 to 6.90m (22'-3 3/4" to 22'-7 5/8")	1.645m (5'-4 3/4").
5.5ft 0.255 (+0.003/-0.005)	6.50m (21'-4")	7.00m (22'-11 9/16)	6.80 to 6.90m (22'-3 3/4" to 22'-7 5/8")	1.785m (5'-10 1/4")
6ft 0.266 (+0.003/-0.005)	6.75m (22'-1 3/4")	7.00m (22'-11 9/16)	6.85 to 6.95m (22'-5 11/6" to 22'-9 5/8")	1.860m (6'-1 1/4").



## Official Trick Course

The following diagram shows the placement of an optional turn buoy and an optional 50 m pre-start buoy (*green*) as well as the official trick course (*orange/red*). It is highly recommended that the optional buoys be used.

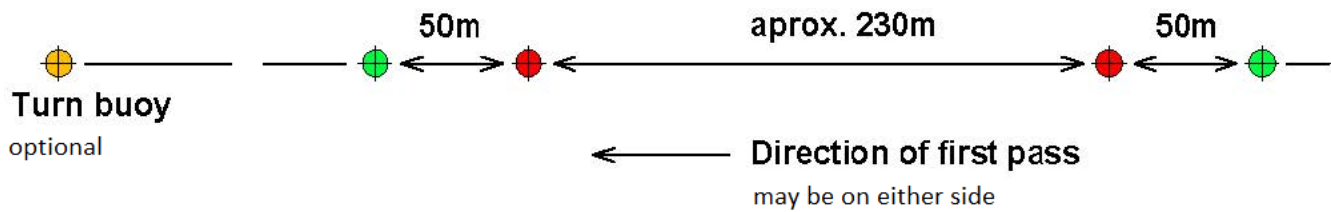

## Trick Descriptions and Point Values

Category	Description	Surface Tricks				Wake Tricks			
		Trick No.	Trick Code	2 Skis	1 Ski	Trick No.	Trick Code	2 Skis	1 Ski
Spins	Sideslide	1	S	20*	40*				
	180° FB	3	B	30*	60*	14	WB	50*	80*
	180° BF	4	F	30*	60*	15	WF	50*	80*
	360° FF	5a	O	40*	90*	16	WO	110*	150*
	360° BB	5b	BB	40*	90*	17	WBB	110*	150*
	540° FB	5c	5B	50*	110*	18	W5B	310*	310*
	540° BF	5d	5F	50*	110*	19	W5F	310*	310*
	720° FF	5e	7F	60*	130*	20	W7F	800*	800*
	720° BB	5f	7B	60*	130*	21	W7B	480*	480*
	900° FB					22	W9B	850*	850*
900° BF						W9F	850*	850*	
Line Turns	Stepover 180° FB	6	LB	70*	110	23	WLB	110*	160
	Stepover 180° BF	7	LF	70*	110	24	WLF	110*	160
	Stepover 360° FF					25	WLO	200*	260*
	Stepover 360° BB					26	WLBB	200*	260*
	Stepover 540° FB					27	WL5B	300*	420*
	Double Stepover 540° FB						WL5LB		500*
	Stepover 720° FF					27A	WL7F	700*	700*
	Stepover 900° FB					27B	WL9B	800*	800*
	Stepover 540° BF					28	WL5F	300*	420*
	Double Stepover 540° BF						WL5LF		500*
	Stepover 720° BB						WL7B	550*	550*
	Stepover 900° BF					28A	WL9F	800*	800*
Toe Spins	Toe Sideslide	2	TS		130*				
	Toe 180° FB	8	TB		100*	29	TWB		150*
	Toe 180° BF	9	TF		100*	30	TWF		150*
	Toe 360° FF	10	TO		200*	31	TWO		300*
	Toe 360° BB	11	TBB		200*	32	TWBB		330*
	Toe 540° FB	12	T5B		350*	33	TW5B		500*
	Toe 720° FF		T7F		450	35	TW7F		650*
	Toe 540° BF	13	T5F		350	34	TW5F		500
Toe 720° BB					36	TW7B		650	
Toe Steps	Toe Stepover 180° FB					37	TWLB		320
	Toe Stepover 180° BF					38	TWLF		380
	Toe Stepover 360° FF					39	TWLO		480*
	Toe Stepover 360° BB					40	TWLBB		480*
	Toe Stepover 540° FB					41	TWL5B		600*
	Toe Stepover 540° BF					42	TWL5F		700
	Toe Stepover 720° FF					42a	TWL7F		800
Flips	Back Flip					52	BFL	500*	500*
	Double Back Flip					51	DBFL	1,000	1,000
	Back Flip 180° FB					53	BFLB	750*	750*
	Back Flip 180° BF					54	BFLF	550	550*
	Back Flip 360° FF					56	BFLO	800	800*
	Back Flip 360° BB					55	BFLBB	800	800*
	Back Flip 540° FB					57	BFL5B**		900*
	Back Flip 540° BF					58	BFL5F**		850*
	Back Flip Line Back					64	BFLLB	800*	800*
	Back Flip Ski Line 360° BB					66	BFLSLBB	900	900
	<b>Wake Flip Ski Line 180 FB</b>					<b>65</b>	<b>BFLSLB</b>		<b>850</b>
	<b>Wake Flip Ski Line 360 FF</b>					<b>67</b>	<b>BFLSLO</b>		<b>900</b>
	Front Flip					59	FFL	800*	800*
	Front Flip 180° FB					60	FFLB	850	850*
	Front Flip 180° BF					61	FFLF	850	850
	Front Flip 360° BB					62	FFLBB	900	900
	Front Flip 540* BF					63	FFL5F	950	950
	<b>Front Flip Ski Line 540 BF</b>					<b>69</b>	<b>FFLSL5F</b>		<b>950</b>
Wake Flip Ski Line 540 B-F					68	BFLSL5F	950	950	
Ski Lines	Ski Line 180° FB					43	SLB		350*
	Ski Line 180° BF					44	SLF		400*
	Ski Line 360° FF					45	SLO		400*
	Ski Line 360° BB					46	SLBB		450*
	Ski Line 540° FB					47	SL5B		550*
	Ski Line 540° BF					48	SL5F		550*
	Ski Line 720° BB					49	SL7B		750*
Ski Line 720° FF					50	SL7F		800*	

\* Denotes tricks with allowable reverses. Reverses are the same value as the *original* trick.

\*\* See IWWF Trick Table for description.

## Speed Control Parameter Adjustment Chart for Jump

### JUMP (revised Jan 2020)

<b>ZERO OFF PARAMETER</b>	<b><u>Who Determines</u></b>	<b><u>When</u></b>	
<b>TOURNAMENT MODE</b>	<i>Driver/Judge</i>	<i>Before event</i>	<i>TOURNAMENT MODE ONLY</i>
<b>BOAT SPEED</b>	<i>Skier</i>	<i>Before each pass</i>	<i>Set Speed in MPH/KPH</i>
<b>JUMP LETTER</b>	<i>Driver / Judge</i>  <i>With input from skier</i>	<i>Before each jump</i>  <i>Boat crew may adjust as necessary including for the first jump</i>	<i>Skier may adjust initial setting +/- 4 letters. Adjust as necessary. Use Jump Letter Chart as an alternative to select initial jump letter</i>
<b>FAST or RTB</b> (Return to Baseline)	<i>Skier</i>	<i>Before each skier based on type of 41-meter segment pull requested</i>	<i>Use screen to turn "RTB" either ON or OFF. With "RTB" ON setting the system will return to baseline speed</i>
<b>POWER FACTOR</b>	<i>Driver / Judge</i>  <i>With input from skier</i>	<i>5.3/5.7-liter engine - start with 6 or 7</i> <i>6.0/6.2-liter engine - start with 4 or 5</i>  <i>Boat crew may adjust as necessary</i>	<i>Range 0 to 15 - Raises or lowers the base speed. A lower number result in boat entering the course slower. At 3 or below there is no additional decrease in baseline (adjustments are then made to the ramp rate of the letter)</i>
<b>41 METER SEGMENT ADDER</b>  (Raises the boat speed in the 41 Meter segment - adds to the target speed)	<i>Driver/Judge</i>	<i>Boat crew may adjust as necessary</i>  <i>Start at 0</i>	<i>ADD - Range = 0 to 9 Start at 0</i>  <i>Adjust as needed for actual times.</i>  <i>This number follows "Power Factor"</i> <i>Example: 6/0</i> <i>(6 is the Power Factor and 0 is the "add")</i>
<b>COUNTER CUT TIME</b>  (Not typically adjusted)	<i>Driver</i>	<i>Before event</i>  <i>May be adjusted for strong head or tail wind to control speed during counter cut</i>	<i>Recommended:</i> <i>Head Wind 180</i> <i>Tail Wind 190</i> <i>¾ Cut 170</i> <i>160</i>
<b>GPS MAPPING</b>	<i>Driver &amp; Judge</i>	<i>Before event and as needed if off more than 2.5 meters</i>	<i>Map course when pylon is aligned with the start of the timing buoys</i>

## Speed Control Parameter Adjustment Chart for Slalom & Tricks

### SLALOM (revised Jan 2020)

<b>ZERO OFF PARAMETER</b>	<b><u>Who Determines</u></b>	<b><u>When</u></b>	
<b>TOURNAMENT MODE</b>	<i>Driver/Judge</i>	<i>Before event</i>	<i>TOURNAMENT MODE ONLY</i>
<b>BOAT SPEED</b>	<i>Skier</i>	<i>Before each pass</i>	<i>Speed in MPH/KPH</i>
<b>A1, A2, A3 B1, B2, B3 C1, C2, C3</b>	<i>Skier  Default is B2 unless skier asks for other setting</i>	<i>Before each pass</i>	<i>A = Slowest engine response B = Moderate engine response C = Fastest engine response  1 = Softest feel behind the boat 2 = Moderate feel behind the boat 3 = Firmest feel behind the boat</i>
<b>"+" SETTING</b>	<i>Skier Default is OFF</i>	<i>Before each pass</i>	<i>With "+" ON – Engine will respond quicker.</i>
<b>GPS MAPPING</b>	<i>Driver &amp; Judge</i>	<i>Before event and as necessary if off more than 2.5 meters</i>	<i>Map course when GPS Puck is aligned with the start of timing buoys</i>

### **TRICKS**

<b>ZERO OFF PARAMETER</b>	<b><u>Who Determines</u></b>	<b><u>When</u></b>	
<b>BOAT SPEED</b>	<i>Skier</i>	<i>Before each pass</i>	<i>Speed in MPH/KPH</i>
<b>A1, A2, A3 B1, B2, B3 C1, C2, C3</b>	<i>Skier  Default is B2 unless skier asks for other setting</i>	<i>Before each pass</i>	<i>A = Slowest engine response B = Moderate engine response C = Fastest engine response  1 = Softest feel behind the boat 2 = Moderate feel behind the boat 3 = Firmest feel behind the boat</i>
<b>"+" SETTING</b>	<i>Skier Default is OFF</i>	<i>Before each pass</i>	<i>With "+" ON – Engine will respond quicker</i>

**NOTE:** Updated speed control parameters may be posted on the USA-WSWS website, accompanied by a revision date, and will supersede the speed control parameters printed in the AWSA Rule Book. No changes shall be made between July 1 and the conclusion of Nationals.

# **Allowable Boat Adjustments**

## **Nautique Hydrogate – 2018 & Earlier**

The Nautique Hydrogate can be set in one of two positions, slalom or tricks/jump (may not be set in between modes).

- Tricks: The default position is the trick mode. The skier has the option of using the slalom mode. It is the skier's responsibility to inform the boat crew when choosing the slalom option. The skier may choose to change the setting between passes.
- Jump: The default position is the jump mode. The skier has the option of using the slalom mode. It is the skier's responsibility to inform the boat crew of slalom option prior to leaving the dock. In Class C tournaments only, the skier may choose to change the setting between jumps.
- Slalom: The gate will remain in the slalom mode.

## **Nautique Hydrogate & MicroTuners – 2019 & Later**

The Nautique Hydrogate has 11 settings (Zero to Ten – inclusive).

- Slalom: The gate will remain in the slalom mode. Microtuners - There will be NO RE-RIDES for a setting different than requested, as long as the adjustment for the line length is within the Matrix provided by the company. If a rope length is selected that changes the MicroTuner setting (for example the proper rope length should have had the MicroTuners deployed and the chosen length did not deploy them), then a reride will be allowed. If a complete pass was made, there will be no reride.
- Tricks: The Trick Hydrogate will be 0 to 10. The default setting is Trick mode (10). The Hydrogate may be adjusted to a setting from 0 to 10 of Slalom (0), Middle 1 to 9 or Trick mode (10). The skier may choose to change the setting between passes.
- Jump: The Jump Hydrogate will be 0 to 10. The default setting is Jump mode (10). The Hydrogate may be adjusted to a setting of Slalom (0), Middle 1 to 9 or Jump mode 10. It is the skier's responsibility to inform the boat crew his Hydrogate setting prior to leaving the dock. It will remain in that position for his/her turn.

## **Ski Nautique Ballast System – Tricks Only**

If equipped, the ballast system starting level may be chosen by the skier (0%, 25%, 50%, 75%, or 100%). The skier may select +/- 50% for his second pass based on his first pass selection. The LOC along with the CJ may set a maximum upper ballast level. If so, the skier may not exceed that limit when selecting a second pass change.

Drivers should check to ensure that the ballast system is empty for slalom or jump events as there are situations where water may still be in the tanks.

## **MasterCraft Ballast/ Weight System – Tricks Only**

Tricks Only, the ProStar is approved in Tricks: 1) with a weight system; and 2) without a weight system. If the boat is used with the ballast/weight system, it must be configured as it was tested and approved.

2021 & Later – If weighted, two options: 1) 200 pounds total, using two sets of weight bags each totaling 100lbs installed in the two rear compartment trays; or 2) 100 pounds total, using two sets of weight bags each totaling 50lbs installed in the two rear compartment trays. (See Rules Interpretations)

2020 & Earlier – If weighted, the configuration must include a full ballast / fat sack in the bilge; inside the front floor compartment (150lbs). In addition, 150lbs total using two sets of weight bags each totaling 75lbs installed in the two rear compartment trays).

Rear storage compartment trays are located inside the top loading access doors at the back of the boat.

The ProStar is not approved with any other configuration, in other words, a user cannot simply put weight on the boat floor.

## AWSA Jumping Event Timing Tolerance Table

**Class E/L/R Jumping Event Timing Tolerance Table** Revised 1/28/23

Boat Speed		52M Segment(1 <sup>st</sup> ) (ST to NT)		82M Segment (2 <sup>nd</sup> ) (ST to MT)				41M Segment (3 <sup>rd</sup> ) (MT to ET)			
		Fast	Slow	Balk	Fast	Ideal	Slow	Fast	Ideal	Slow	RTB Slow
<b>57</b>	<b>35.4</b>	3.25	3.37	5.06	5.11	<b>5.18</b>	5.25	2.36	<b>2.40</b>	2.46	2.66
<b>54</b>	<b>33.6</b>	3.43	3.56	5.34	5.39	<b>5.47</b>	5.55	2.54	<b>2.59</b>	2.66	2.81
<b>51</b>	<b>31.7</b>	3.63	3.78	5.65	5.70	<b>5.79</b>	5.88	2.68	<b>2.73</b>	2.81	2.98
<b>48</b>	<b>29.8</b>	3.86	3.98	6.00	6.05	<b>6.15</b>	6.25	2.84	<b>2.89</b>	2.98	3.17
<b>45</b>	<b>28.0</b>	4.11	4.25	6.40	6.45	<b>6.56</b>	6.68	3.01	<b>3.08</b>	3.17	3.39
<b>42</b>	<b>26.1</b>			6.85	6.90	<b>7.03</b>	7.17	3.21	<b>3.28</b>	3.39	3.64
<b>39</b>	<b>24.2</b>			7.37	7.42	<b>7.57</b>	7.73	3.43	<b>3.51</b>	3.64	3.94
		Per IWWF Class L/R For Class E - Reference only		- 0.5 sec	+/-0.8Kph (+/-0.50Mph)			+1/-1.5Kph (+0.62Mph/-0.93Mph)			-1.5 Kph

**Class C/F Jumping Event Timing Tolerance Table**

Boat Speed		52M Segment(1 <sup>st</sup> ) (ST to NT)	82M Segment (2 <sup>nd</sup> ) (ST to MT)				41M Segment (3 <sup>rd</sup> ) (MT to ET)			
		Expected Range	Balk	Fast	Ideal	Slow	Fast	Ideal	Slow	RTB Slow
<b>57</b>	<b>35.4</b>	3.22 to 3.43	5.02	5.07	<b>5.18</b>	5.29	2.36	<b>2.40</b>	2.48	2.68
<b>54</b>	<b>33.6</b>	3.41 to 3.69	5.30	5.35	<b>5.47</b>	5.59	2.54	<b>2.59</b>	2.68	2.84
<b>51</b>	<b>31.7</b>	3.59 to 4.12	5.60	5.65	<b>5.79</b>	5.93	2.68	<b>2.73</b>	2.84	3.01
<b>48</b>	<b>29.8</b>	3.80 to 4.26	5.95	6.00	<b>6.15</b>	6.31	2.84	<b>2.89</b>	3.01	3.21
<b>45</b>	<b>28.0</b>	3.99 to 4.40	6.34	6.39	<b>6.56</b>	6.74	3.01	<b>3.08</b>	3.21	3.43
<b>42</b>	<b>26.1</b>	4.32 to 4.92	6.78	6.83	<b>7.03</b>	7.24	3.21	<b>3.28</b>	3.43	3.69
<b>39</b>	<b>24.2</b>	4.70 to 5.16	7.29	7.34	<b>7.57</b>	7.81	3.43	<b>3.51</b>	3.69	3.99
		Not a tolerance. For reference only.	- 0.5 sec	+/- 1.21 Kph (+/-0.75Mph)			+1 /-2.0Kph (+0.62/ -1.24 Mph)			-2 Kph

- NOTE 1:** 52M Segment Time (1<sup>st</sup>)- Reference IWWF for when this segment time/tolerance applies. When 52m Segment applies, shall be recorded. Not required for Class E/C/F, reference only.
- NOTE 2:** On balk or refuses the ramp, the maximum speed tolerance allowable for 82M Segment Time (2<sup>nd</sup>) shall be increased by 0.5 seconds. The 41M Segment (3<sup>rd</sup>) is not used.
- NOTE 3:** At the skier option, the speed control mode may be set to Return to Baseline (RTB), or if the pull was not sufficiently aggressive to engage the jump switch, RTB speed/time to be used. Meaning the speed control just returns to the base speed setting for the 41M Segment (3<sup>rd</sup>). Reference IWWF for RTB 41M Segment (3<sup>rd</sup>) actual/ideal times.
- NOTE 4:** When the speed is below the maximum for the division, the 41M Segment (3<sup>rd</sup>) will not be used with the exception that it may not exceed the maximum speed for the event division.



## Slalom Timing Chart - Record Tolerance ABT

*(Required in Class C. See IWWF Rules for Class E/ L or R Events)*

BOAT SPEED		Score:	0-0.5	1-1.5	2-2.5	3-3.5	4-4.5	5-5.5	All 6
KPH	MPH	Display	0	1	2	3	4	5	6
58	36.0	Fast	1.64	4.15	6.67	9.20	11.73	14.25	15.92
		<b>Ideal</b>	<b>1.68</b>	<b>4.22</b>	<b>6.77</b>	<b>9.31</b>	<b>11.86</b>	<b>14.40</b>	<b>16.08</b>
		Slow	1.71	4.28	6.84	9.41	11.97	14.53	16.22
55	34.2	Fast	1.73	4.37	7.03	9.69	12.35	15.02	16.78
		<b>Ideal</b>	<b>1.77</b>	<b>4.45</b>	<b>7.13</b>	<b>9.82</b>	<b>12.50</b>	<b>15.19</b>	<b>16.95</b>
		Slow	1.80	4.51	7.23	9.93	12.64	15.34	17.12
52	32.3	Fast	1.83	4.62	7.43	10.24	13.05	15.87	17.72
		<b>Ideal</b>	<b>1.87</b>	<b>4.71</b>	<b>7.55</b>	<b>10.38</b>	<b>13.22</b>	<b>16.06</b>	<b>17.93</b>
		Slow	1.91	4.78	7.65	10.52	13.39	16.25	18.13
49	30.4	Fast	1.94	4.90	7.87	10.85	13.83	16.81	18.78
		<b>Ideal</b>	<b>1.98</b>	<b>5.00</b>	<b>8.01</b>	<b>11.02</b>	<b>14.03</b>	<b>17.04</b>	<b>19.03</b>
		Slow	2.03	5.08	8.13	11.18	14.22	17.27	19.27
46	28.6	Fast	2.06	5.21	8.37	11.54	14.71	17.88	19.98
		<b>Ideal</b>	<b>2.11</b>	<b>5.32</b>	<b>8.53</b>	<b>11.74</b>	<b>14.95</b>	<b>18.16</b>	<b>20.27</b>
		Slow	2.16	5.42	8.68	11.93	15.18	18.42	20.56
43	26.7	Fast	2.20	5.56	8.94	12.33	15.71	19.10	21.34
		<b>Ideal</b>	<b>2.26</b>	<b>5.69</b>	<b>9.13</b>	<b>12.56</b>	<b>15.99</b>	<b>19.42</b>	<b>21.68</b>
		Slow	2.32	5.81	9.30	12.78	16.27	19.75	22.03
40	24.9	Fast	2.36	5.97	9.60	13.23	16.86	20.50	22.89
		<b>Ideal</b>	<b>2.43</b>	<b>6.12</b>	<b>9.81</b>	<b>13.50</b>	<b>17.19</b>	<b>20.88</b>	<b>23.31</b>
		Slow	2.50	6.26	10.02	13.78	17.53	21.27	23.74
37	23.0	Fast	2.54	6.44	10.35	14.27	18.19	22.11	24.70
		<b>Ideal</b>	<b>2.63</b>	<b>6.62</b>	<b>10.61</b>	<b>14.59</b>	<b>18.58</b>	<b>22.57</b>	<b>25.20</b>
		Slow	2.71	6.79	10.86	14.93	18.99	23.06	25.73
34	21.1	Fast	2.76	6.99	11.24	15.49	19.74	23.99	26.81
		<b>Ideal</b>	<b>2.86</b>	<b>7.20</b>	<b>11.54</b>	<b>15.88</b>	<b>20.22</b>	<b>24.56</b>	<b>27.42</b>
		Slow	2.95	7.41	11.85	16.29	20.73	25.16	28.08
31	19.3	Fast	3.02	7.65	12.29	16.93	21.58	26.24	29.31
		<b>Ideal</b>	<b>3.14</b>	<b>7.90</b>	<b>12.66</b>	<b>17.42</b>	<b>22.18</b>	<b>26.94</b>	<b>30.08</b>
		Slow	3.25	8.15	13.05	17.93	22.82	27.70	30.90
28	17.4	Fast	3.33	8.43	13.55	18.68	23.81	28.94	32.33
		<b>Ideal</b>	<b>3.47</b>	<b>8.74</b>	<b>14.01</b>	<b>19.29</b>	<b>24.56</b>	<b>29.83</b>	<b>33.30</b>
		Slow	3.61	9.07	14.51	19.94	25.37	30.80	34.37
25	15.5	Fast	3.71	9.40	15.11	20.83	26.54	32.26	36.04
		<b>Ideal</b>	<b>3.89</b>	<b>9.79</b>	<b>15.70</b>	<b>21.60</b>	<b>27.50</b>	<b>33.41</b>	<b>37.30</b>
		Slow	4.07	10.21	16.34	22.46	28.58	34.68	38.70

## Slalom Timing Chart - Standard Tolerance ABT

(For use in Class F events)

BOAT SPEED		Score:	0-0.5	1-1.5	2-2.5	3-3.5	4-4.5	5-5.5	All 6
KPH	MPH	Display	0	1	2	3	4	5	6
58	36.0	Fast	1.63	4.14	6.65	9.17	11.69	14.21	15.87
		Ideal	1.68	4.22	6.77	9.31	11.86	14.40	16.08
		Slow	1.72	4.29	6.87	9.44	12.01	14.58	16.27
55	34.2	Fast	1.72	4.36	7.00	9.65	12.30	14.96	16.71
		Ideal	1.77	4.45	7.13	9.82	12.50	15.19	16.95
		Slow	1.82	4.53	7.25	9.97	12.69	15.40	17.19
52	32.3	Fast	1.82	4.60	7.40	10.19	12.99	15.79	17.65
		Ideal	1.87	4.71	7.55	10.38	13.22	16.06	17.93
		Slow	1.92	4.80	7.69	10.57	13.45	16.32	18.21
49	30.4	Fast	1.92	4.87	7.83	10.80	13.76	16.73	18.69
		Ideal	1.98	5.00	8.01	11.02	14.03	17.04	19.03
		Slow	2.05	5.11	8.18	11.24	14.30	17.36	19.37
46	28.6	Fast	2.05	5.18	8.33	11.47	14.63	17.78	19.86
		Ideal	2.11	5.32	8.53	11.74	14.95	18.16	20.27
		Slow	2.18	5.46	8.73	12.00	15.27	18.54	20.68
43	26.7	Fast	2.18	5.53	8.88	12.24	15.61	18.98	21.20
		Ideal	2.26	5.69	9.13	12.56	15.99	19.42	21.68
		Slow	2.34	5.85	9.37	12.87	16.38	19.89	22.18
40	24.9	Fast	2.34	5.92	9.52	13.13	16.73	20.34	22.72
		Ideal	2.43	6.12	9.81	13.50	17.19	20.88	23.31
		Slow	2.52	6.31	10.10	13.89	17.67	21.44	23.93
37	23.0	Fast	2.52	6.38	10.26	14.14	18.03	21.92	24.49
		Ideal	2.63	6.62	10.61	14.59	18.58	22.57	25.20
		Slow	2.74	6.85	10.96	15.07	19.17	23.26	25.96
34	21.1	Fast	2.74	6.92	11.13	15.33	19.55	23.76	26.54
		Ideal	2.86	7.20	11.54	15.88	20.22	24.56	27.42
		Slow	2.99	7.49	11.98	16.47	20.95	25.43	28.37
31	19.3	Fast	2.99	7.56	12.14	16.74	21.34	25.94	28.97
		Ideal	3.14	7.90	12.66	17.42	22.18	26.94	30.08
		Slow	3.29	8.25	13.21	18.16	23.10	28.04	31.29
28	17.4	Fast	3.29	8.32	13.37	18.43	23.49	28.56	31.91
		Ideal	3.47	8.74	14.01	19.29	24.56	29.83	33.30
		Slow	3.67	9.20	14.72	20.23	25.74	31.25	34.86
25	15.5	Fast	3.67	9.26	14.87	20.50	26.13	31.77	35.49
		Ideal	3.89	9.79	15.70	21.60	27.50	33.41	37.30
		Slow	4.14	10.39	16.62	22.84	29.06	35.27	39.36



## **AWSA National Championships Event Classification**

As Revised and Approved by the AWSA Board of Directors, January, 2024

Divisions	Slalom	Trick	Jump
Age Divisions/MM/MW	E/L*	E/L*	E/L*
G5/B5/M1/W1**	**	**	**
OM/OW	R	R	R
**Skiers must request Class R for an IWWF World Record in U17 or U21 divisions before the National Tournament begins.			
*Class L <i>At the option of the skier</i>			

Skiers would default to Class E and can request L or R depending on their age division or ability.

Only skiers with a valid IWWF license may request L or R.

Skiers should check in at registration before their event starts to confirm their class or they will remain in Class E.

The reason for the extra line for G/B 5 and W/M 1 is to not penalize any of our AWSA skiers who could set an U17 or U21 World Record if they have to ski Class L only.

There are a few differences in the rules, but the skiers should make themselves aware of them. The officials will be staffed as if the event is an L or R unless it is apparent that the whole event can be run as a Class E.

## Rules Jurisdiction Chart

<b>Rule Number</b>	<b>Rule Description</b>	<b>Jurisdiction</b>	<b>Coordinating Committee</b>
1	General	Rules	
1.14	Tournament Sanction Review	Rules	Technical
2	Tournament Events, etc	Rules	
3	Division Competition Rankings	Rules	Skiers Qualification
4	Tournament Qualifications	Rules	Skiers Qualification
5	Overall & Team Competition	Rules	Skiers Qualification
6	Officials	Rules	
6.01.A.B.C.F&.G	National Tournament Officials	Judges & Scorers	
6.01.D & .E	National Tournament Drivers	Boat Drivers	
6.01.H	National Tournament Safety Directors	Safety	
6.01.I	National Tournament Technical Controller	Technical	
6.02.A.B.C&.E	Regional Tournament Officials	Judges & Scorers	
6.02.D	Regional Tournament Drivers	Boat Drivers	
6.02.F	Regional Tournament Safety Directors	Safety	
6.02.G	Regional Tournament Technical Controller	Technical	
6.03.A.B.D.E.F	Regional Tournament Officials	Judges & Scorers	
6.03.C	Regional Tournament Drivers	Boat Drivers	
6.03.G	Regional Tournament Safety Directors	Safety	
6.03.H	Regional Tournament Technical Controller	Technical	
6.10, 6.11 & 6.13	Judges and Emeritus	Judges & Scorers	
7	Rerides, Protests & Disqualification	Rules	
8	Equipment & Definitions		
8.01	Competition Area	Technical	
8.02	Boats	Rules	Tow Boat
8.03	Skis	Technical	
8.04	Tow Lines	Technical	
8.05	Boat Speeds	Rules	Technical
8.06	A Fall	Rules	
8.07	Skiing Position	Rules	
8.08	The Wake	Rules	
8.09	Buoys	Technical	
8.10	Speed Control	Rules	Technical/Towboat
9	Jumping	Rules	
9.09.B & .C	Timing	Rules	Technical
9.12	Distance Measurement	Technical	
9.16	Jumping Equipment and Definitions	Technical	
9.17	Tolerances	Technical	Rules
10	Slalom	Rules	Technical
10.02	Slalom Course	Technical	

<b>Rule Number</b>	<b>Rule Description</b>	<b>Jurisdiction</b>	<b>Coordinating Committee</b>
10.06.C	Rope Lengths/Tolerances	Technical	Rules
10.09.B	Timing	Rules	Technical
10.16	Slalom Equipment and Definitions	Technical	
10.17	Tolerances	Technical	Rules
11	Tricks	Rules	Technical
11.02	Trick Course	Technical	
11.09.B	Timing	Rules	Technical
11.17	Speed Calibration	Technical	
12	Safety Requirements	Safety	
13	Optional Tournament Formats	Rules	
14	Records	Technical	
14.01	AWSA Recognition	Technical	
14.02	Performance Requirements	Rules	
15	Record Capability Tournaments	Rules	
15.03	Certification of Competition Courses	Technical	
15.04	Technical Controller	Technical	
15.06	Technical Requirements	Technical	
16	Cash Prize Tournaments	AWSA Executive Committee & AWSA Board	
Appendix	Rules Interpretations	Rules	
Appendix	Optional 2-Segment Timing Rules	Rules	
Appendix	IWWF/AWSA Rule Differences	Rules	
Appendix	Official Development Program	All Officials Committees	
Appendix	Tow Line Dimensions	Technical	
Appendix	Official Slalom Course Diagram	Technical	
Appendix	Slalom Scoring	Rules	
Appendix	Tow-pylon Specifications Diagram	Technical	
Appendix	Off Jump Course Diagram	Technical	
Appendix	Ramp Setting Chart	Technical	
Appendix	Computer BMK Meters	Technical	
Appendix	Computer BMK Calculations	Technical	
Appendix	Official Trick Course	Technical	
Appendix	Trick Speed Calibration Times	Technical	
Appendix	Trick Description & Point Values	Rules	
Appendix	Tournament Classification Requirements	AWSA & IWWF	
Appendix	Speed Control Parameter Adjustment Chart	Rules	Towboat
Appendix	Jump Timing Tables	Technical	
Appendix	Slalom Timing Tables	Technical	
Appendix	Nationals Event Classifications	AWSA Board	Rules
Appendix	Rules Jurisdiction Chart	AWSA Board	Rules

This table is designed to indicate which committee is responsible for a particular rule. In cases where a specific rule number within the broader rule number is listed, the committee with jurisdiction is responsible for the specific rule number, not the committee with the broader responsibility. In cases where a coordinating committee is listed, it will provide support and guidance to the primary committee on the portion of that particular rule.

## Tournament Classification Requirements

Tournament Classification	Regular Local Class C	National Entry Class E	Ranking List Class L	World Record Class R
<b>Applicability</b>				
<b>AWSA National Records</b>	No	Yes*	Yes	Yes
<b>IWWF Ranking List</b>	No	No	Yes	Yes
<b>World Records</b>	No	No	No	Yes
<b>General Requirements</b>				
Chief Officials				
Judge	Reg or Sr( <b>J3</b> or <b>J2</b> )	Sr. ( <b>J2</b> )	Sr.( <b>J2</b> ) (W)	Sr.( <b>J2</b> ) (W)
Scorer	Reg or Sr( <b>S3</b> or <b>S2</b> )	Sr. ( <b>S2</b> )	Sr. ( <b>S2</b> )	Sr. ( <b>S2</b> )
Driver	Reg or Sr( <b>D3</b> or <b>D2</b> )	Sr. ( <b>D2</b> )	Sr. ( <b>D2</b> )	Sr. ( <b>D2</b> )
Safety Director	State	State	State	State
Technical Controller	No	Reg( <b>H3</b> ), Sr( <b>H2</b> ),Amb	Sr( <b>H2</b> ) or Amb (W)	Sr ( <b>H2</b> )or Amb (W)
Appointed Judges	CJ plus 2 Appt.	5 not including CJ	5 (A), not including CJ;	5 (A), not including CJ; <b>Min 3 (J2)</b>
Conflict of Interest Rule	No	Yes	Yes (W)	Yes (W)
Site Certification	Measured	Survey	Survey (W)	Survey (W)
Judges Towers	3 m high, both sides recommended.	3 m/44 <sup>0</sup> both sides	3 m/44 <sup>0</sup> both sides, perfect sight (W)	3 m/44 <sup>0</sup> both sides, perfect sight (W)
Speed Control	Yes	Yes	Yes	Yes
<b>Slalom Requirements</b>				
End course video/BPMS	No	Yes	Yes (P)	Yes (W)
Buoys	Per Rulebook	Per Rulebook	Measured per Rulebook (W)	Measured per Rulebook (W)
Event Judges	5 (or 3) Asst. ( <b>J4</b> ) <i>min</i>	E** 5 total, min 1 R/S ( <b>J3/J2</b> ) each tower and towboat	3 Sr ( <b>J2</b> )/2 Reg ( <b>J3</b> ) min (W)	5 Sr. ( <b>J2</b> ) (W)
EJ's with gate video	3 Asst ( <b>J4</b> ) <i>min</i>	3 Sr.( <b>J2</b> ) or Reg.( <b>J3</b> )	2 Sr( <b>J2</b> )/1 Reg ( <b>J3</b> ) (W)	3 Sr.( <b>J2</b> ) min (W)
Boat Video	Optional	Optional (Note 1)	Optional (W)	Required (W)
Gate Video	Optional	Optional	Optional (W)	Required (W)
<b>Tricks Requirements</b>				
Video	Recommended	Required from boat	Required from boat (W)	Required from boat (W)
Event Judges	5 (or 3) Asst( <b>J4</b> ) or up.	5 Reg.( <b>J3</b> ) or <b>higher</b>	3 Sr( <b>J2</b> )/2 Reg ( <b>J3</b> ) min.(W)	5 Sr. ( <b>J2</b> )(W)
EJ's w/immediate video	Same	3 Reg ( <b>J3</b> ) or Sr ( <b>J3</b> )	2 Sr( <b>J2</b> )/1 Reg ( <b>J3</b> ) (W)	3 Sr.( <b>J2</b> ) (W)
Boat Judge	Asst.( <b>J4</b> ) or up, or Asst ( <b>D4</b> ) with CJ approval	Reg ( <b>D3</b> ) or Sr.( <b>D2</b> ) Driver	Reg ( <b>D3</b> ) or Sr.( <b>D2</b> ) Driver	Sr.( <b>D2</b> ) Driver
Trick Timing Devices	Manual	Automatic	Video timing	Video timing
Timer	Asst ( <b>J4</b> ). recom.	Reg ( <b>J3</b> )or Sr.( <b>J2</b> )	Reg ( <b>J3</b> ) or Sr. ( <b>J2</b> )(W)	Reg( <b>J3</b> ) Sr.( <b>J2</b> ) (W)
<b>Jumping Requirements</b>				
Video	Not Required	Not Required	Required (W)	Required (W)
Distance Calc. Method	M/B or Comp.	M/B or Computer	Computer (W)	Computer (W)
Event Judges	1 asst ( <b>J4</b> ) boat	3 Reg( <b>J3</b> ) or Sr.( <b>J2</b> ); 1 shore may be Asst.( <b>J4</b> )	2 Sr.( <b>J2</b> )/1 Reg( <b>J3</b> ). min (W)	3 Sr.( <b>J2</b> ) (W)
Video Judges	2 Asst ( <b>J4</b> ) or higher when used	2 Reg( <b>J3</b> ) or Sr( <b>J2</b> ).; 1 may be Asst.( <b>J4</b> )	1 Sr( <b>J2</b> )/1 Reg.( <b>J3</b> ) (W)	2 Sr.( <b>J2</b> ) (W)
Meter Readers	2 (or 1) Asst ( <b>J4</b> ) <i>min</i> recom.	2 each with 1 Reg( <b>J3</b> ). or Sr.( <b>J2</b> )	Not Applicable	Not Applicable

Notes: (W) as required by IWWF World Rules.

(P) as required by IWWF Pan-American Region Rules.

(A) as required by AWSA Rules, which are more requiring than the associated Pan-American or World Rules (if any).

\* See Rule 1.02B1

E\*\* In Class E Slalom events, an Assistant Judge may replace one of the two slalom tower judges in each tower when 5 judges are being used. (Does not pertain to Regional and National tournaments)

Note1: Boat Video required for the last 2 passes for Elite National Records (OM, OW, MM, and MW)

