

## **Cadet Single Division Athletes**

Female -33kg	Jessica Miciano-Mayo
Male -37kg	Joshua Lepe
Male -49kg	Diego Najera
Male -61kg	Arthur Abrahamyan
Male -65kg	Dharshan Sharma
Male +65kg	Marcus Lam

## Cadet Female -29kg

### Elimination Round

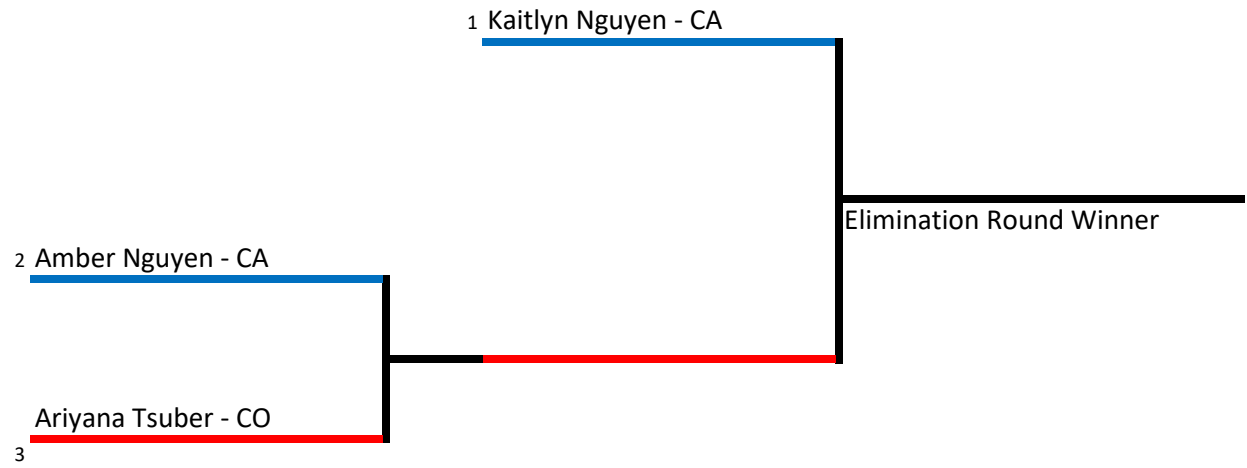

### Final Round

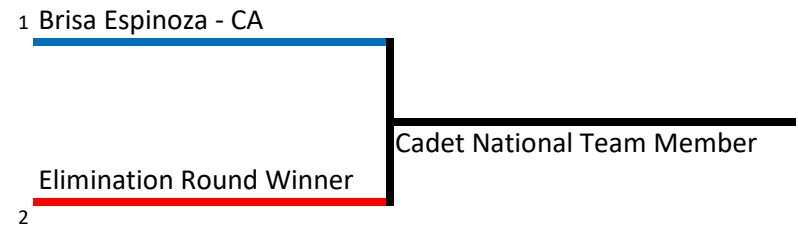

# Cadet Female -37kg

## Elimination Round

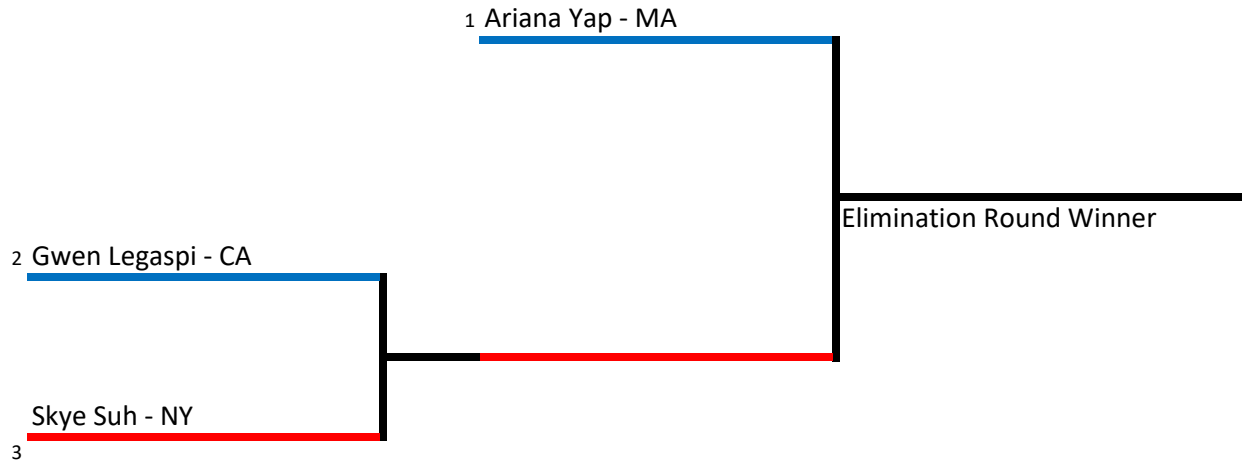

## Final Round

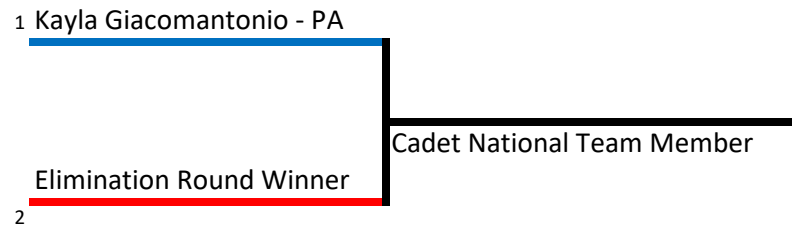

## Cadet Female -41kg

### Elimination Round

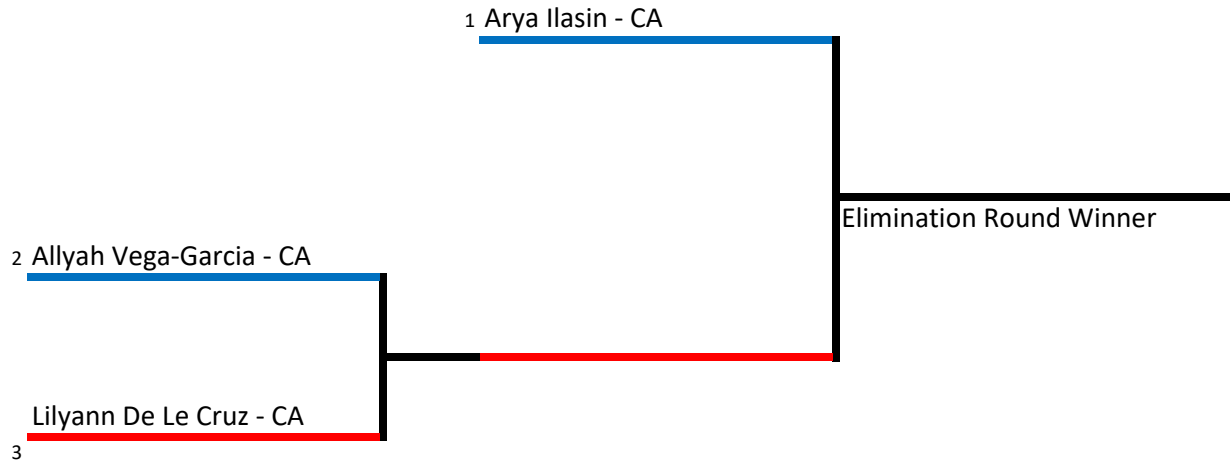

### Final Round

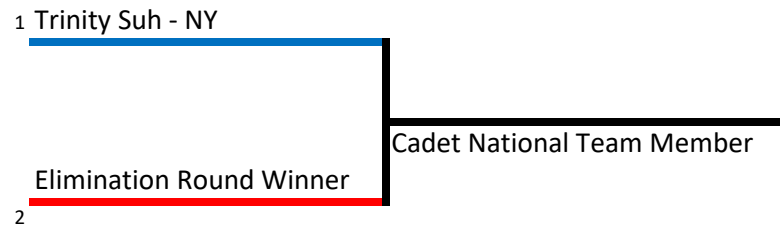

## Cadet Female -44kg

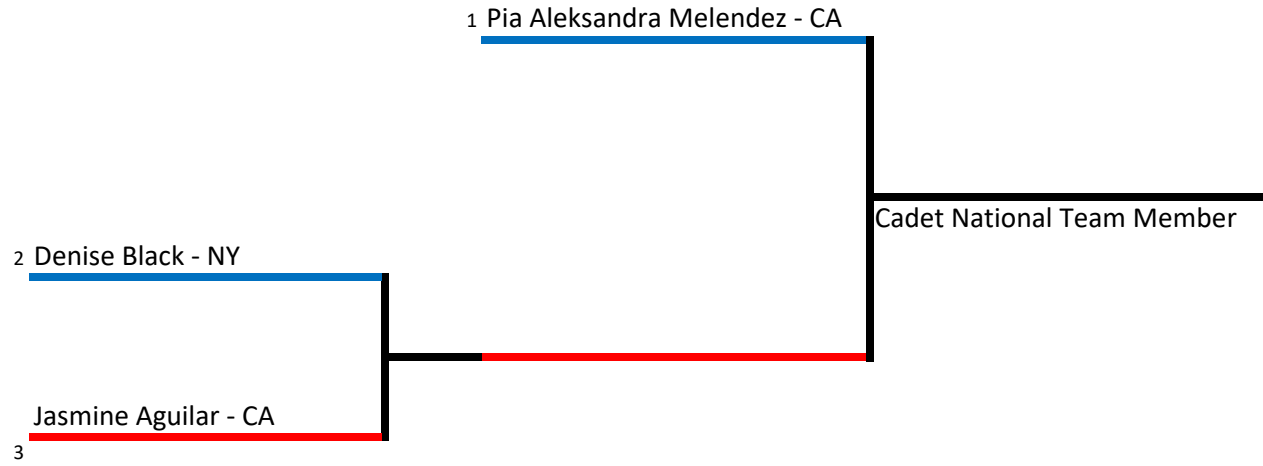

# Cadet Female -47kg

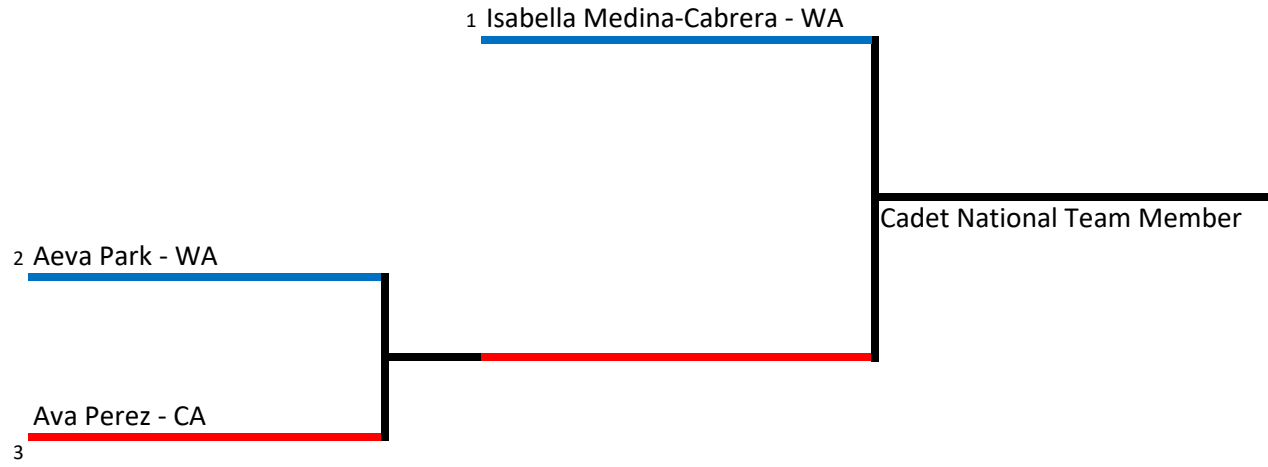

# Cadet Female -51kg

## Elimination Round

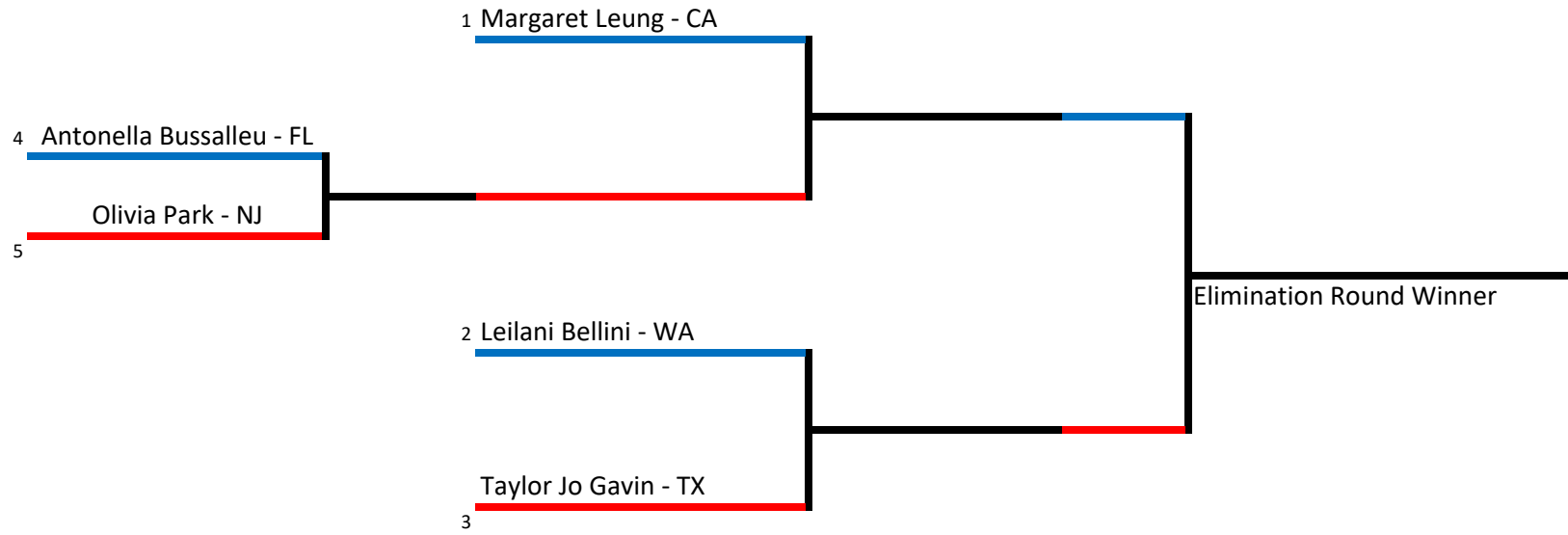

## Final Round

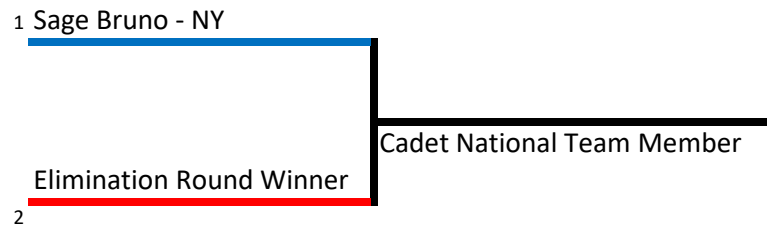

## Cadet Female -55kg

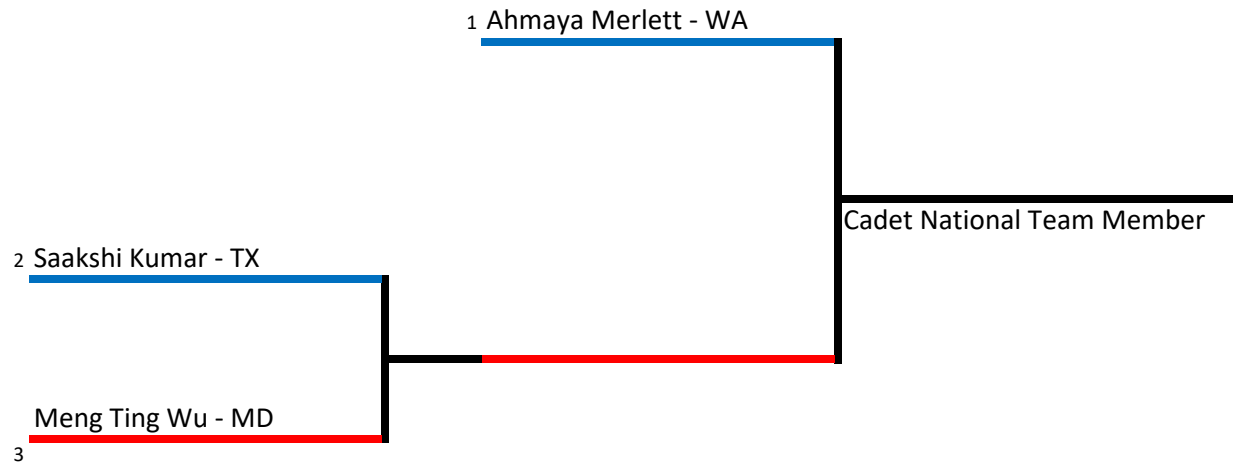



## Cadet Female -59kg

Halleli Kofron

Sofia Palmer

Cadet National Team Member



# Cadet Male -33kg

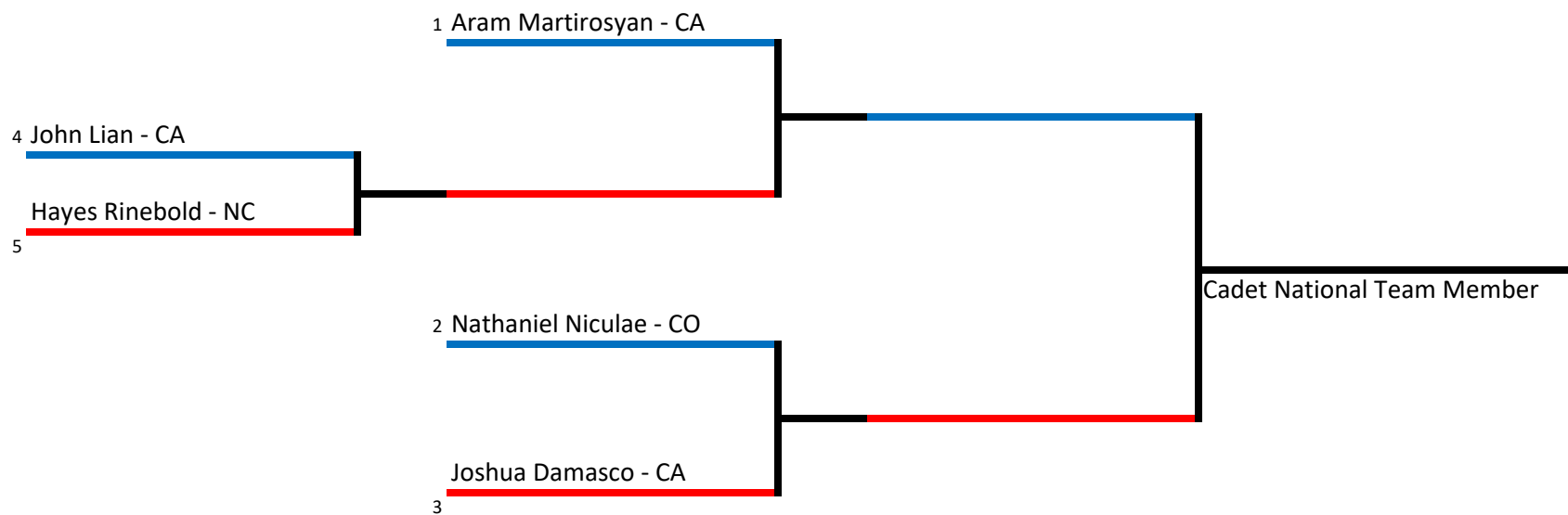

# Cadet Male -41kg

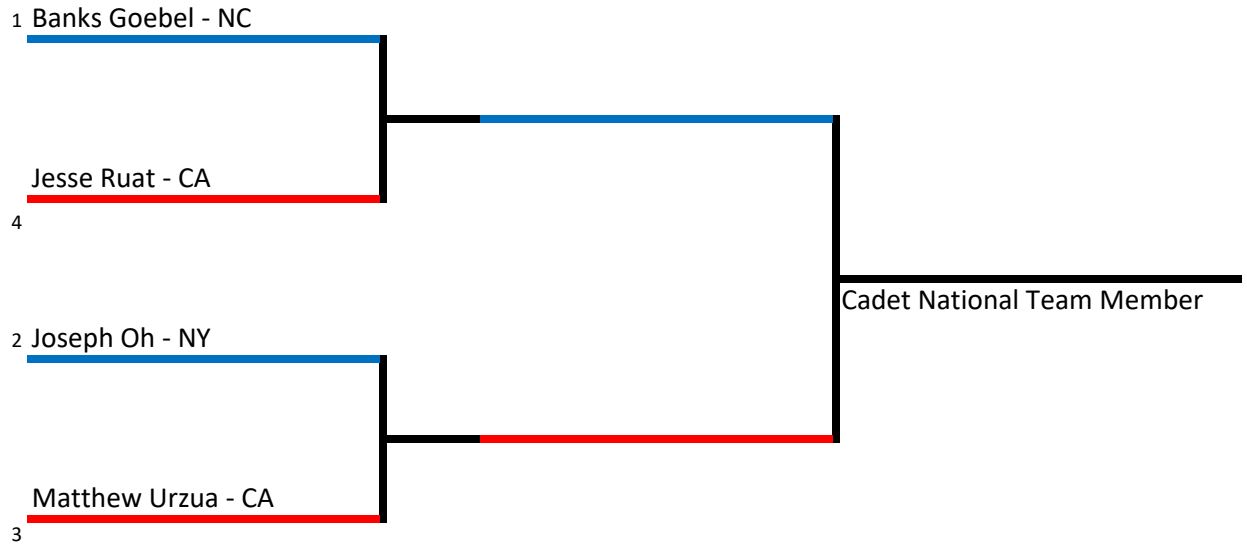

# Cadet Male -45kg

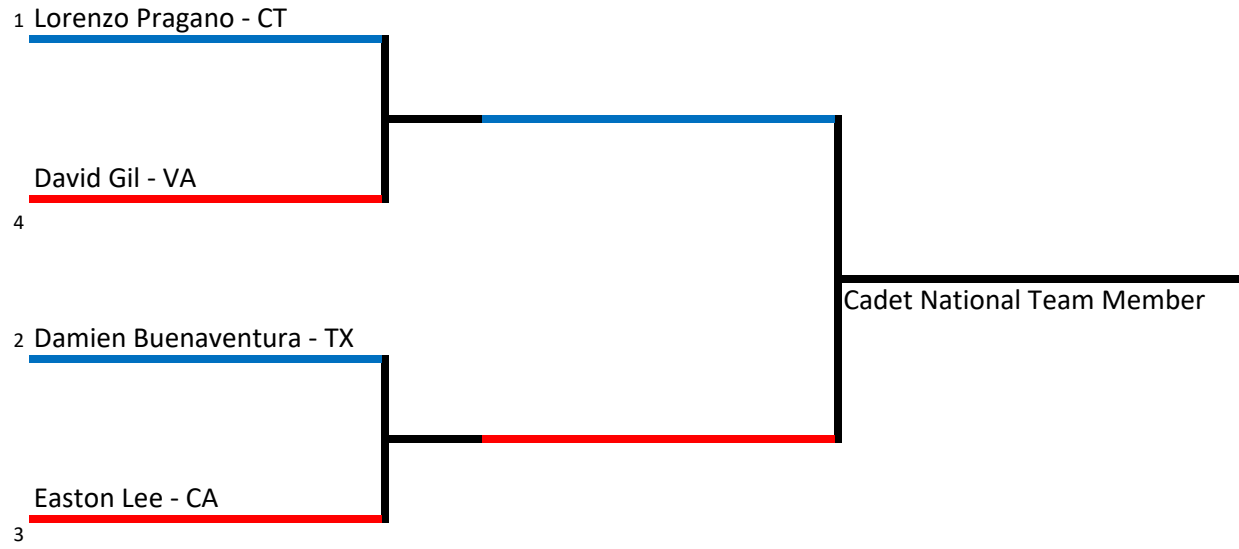

# Cadet Male -53kg

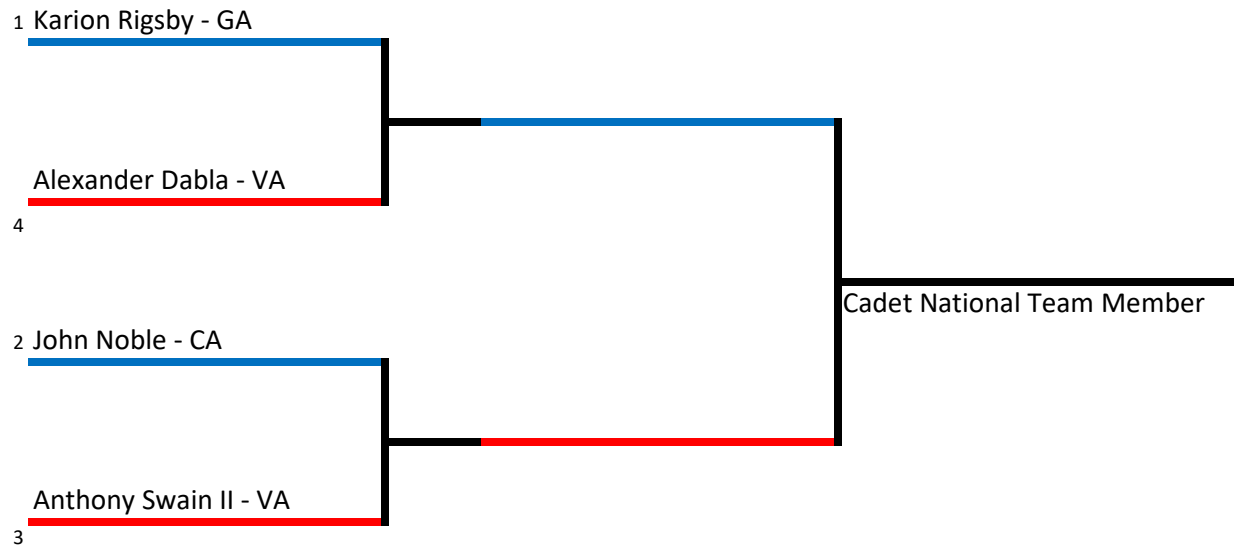

# Cadet Male -57kg

