

Adjustable Base
setup guide
Foldable Base

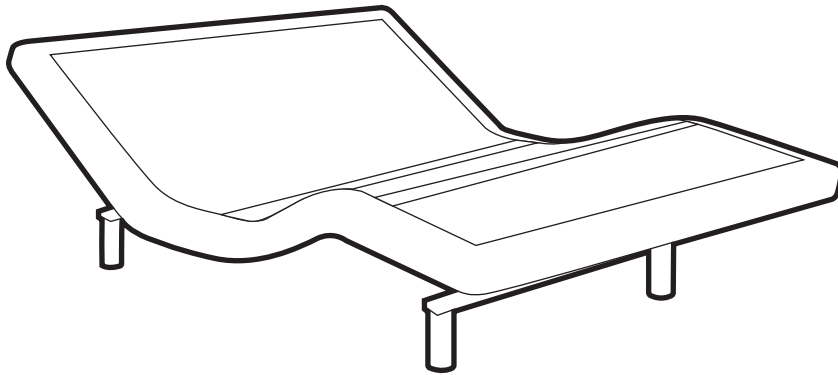

Leggett & Platt[®]
ADJUSTABLE BEDS

CUSTOMER SERVICE toll free: (800) 888-3078

291-0081-B EDR15759 7/20

© 2020 Leggett & Platt, Inc. Adjustable Bed Group

SETUP

READ ALL INSTRUCTIONS BEFORE USING.



NOTE

ALLOW FOR ENOUGH SPACE TO UNFOLD
BASE IN SETUP AREA.



WARNING

DO NOT DROP!



ADJUSTABLE BASE IS HEAVY.
DUE TO RISK OF INJURY, TWO ADULTS
ARE REQUIRED TO HANDLE AND MOVE
ADJUSTABLE BASE.

STEP 1

Open the shipping carton. Carefully, lift adjustable base out of shipping carton and place on clean surface.

STEP 2

Unfold base (FIGURE 1). Remove hardware box, leg box, and protective plastic.



WARNING

PINCH POINT WARNING!

KEEP HANDS AND FINGERS CLEAR WHEN
UNFOLDING BASE.

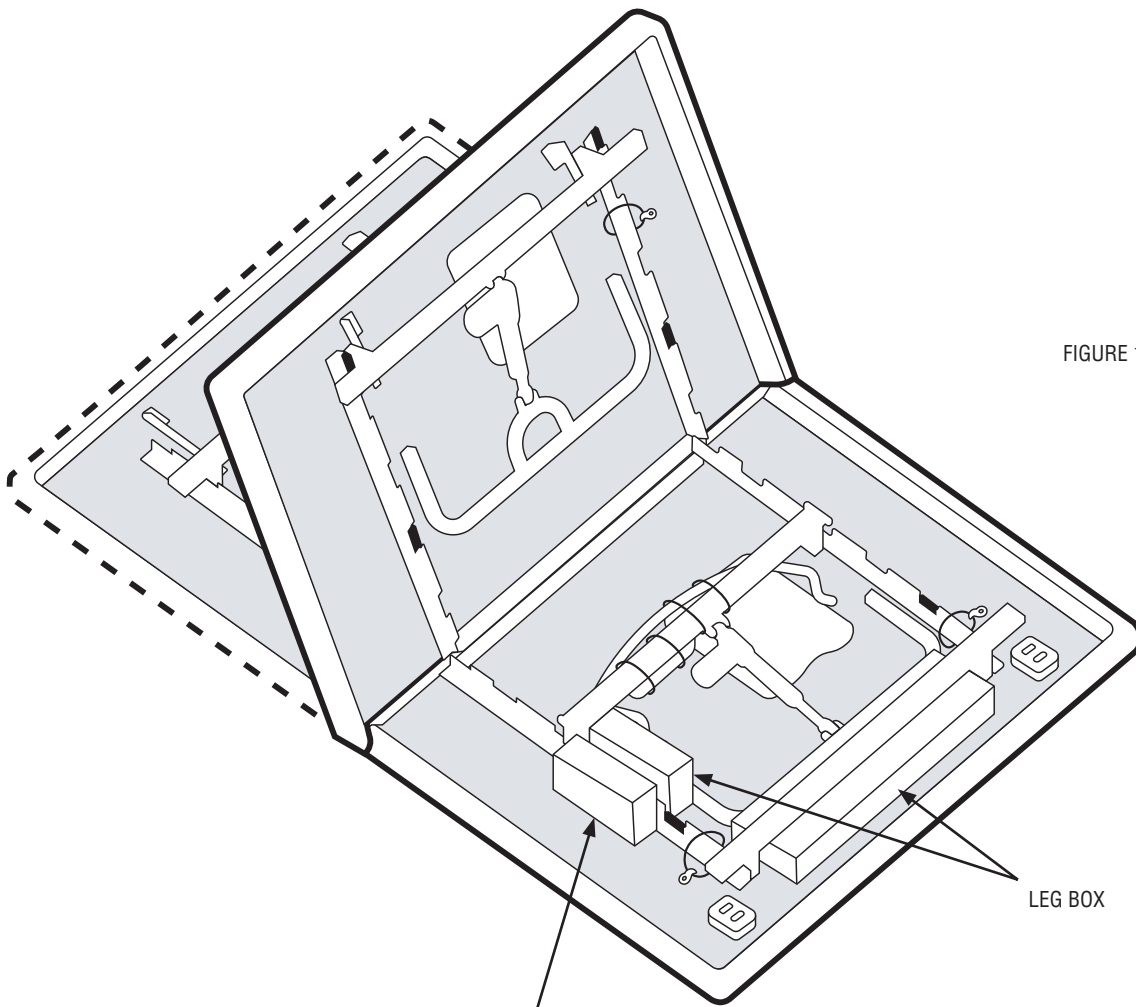

FIGURE 1

HARDWARE BOX

LEG BOX

SETUP

STEP 3

Remove and dispose of plastic spacers from base frame (FIGURE 2).

 **WARNING**
CHILDREN / PET CHOKING HAZARD!
REMOVE PLASTIC SPACERS FROM BASE FRAME.

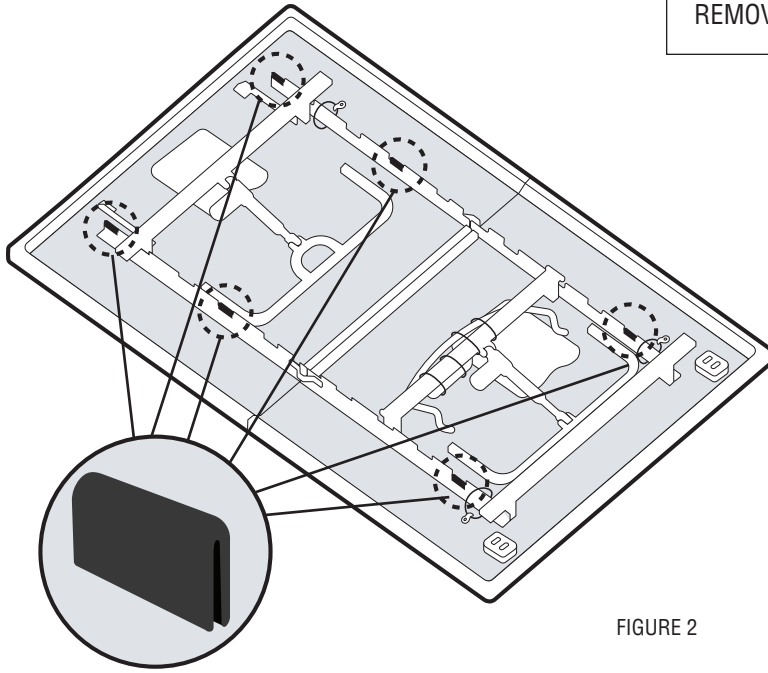



FIGURE 2

STEP 4

Cut all orange zip-ties (FIGURE 3). Set mattress retainer (see FIGURE 3) aside.

 **CAUTION**
BE CAREFUL USING SHARP INSTRUMENTS. INJURY IS POSSIBLE IF TOOLS ARE NOT USED PROPERLY.

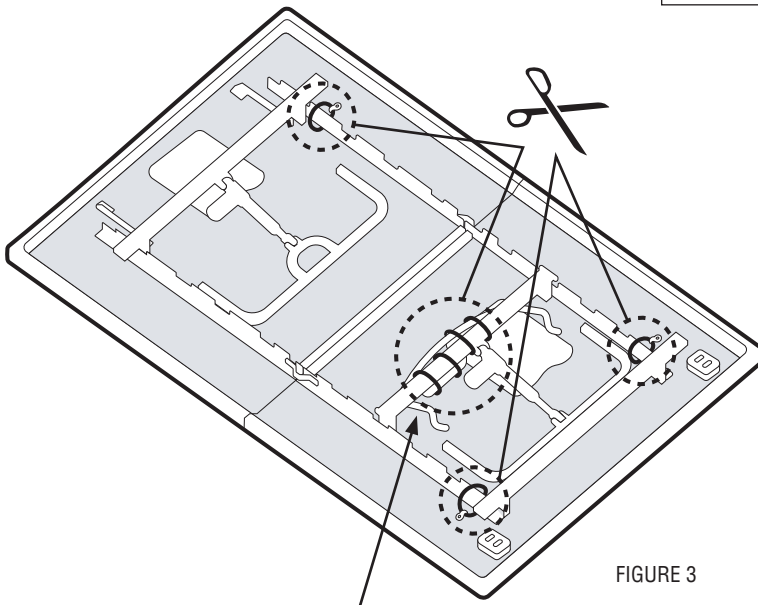

FIGURE 3

MATTRESS RETAINER -
SECURED BY (2) ZIP-TIES

SETUP

STEP 5

Verify contents; inspect for damage.

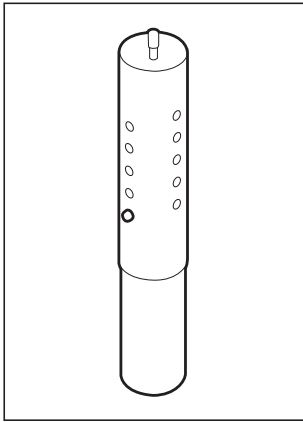

x6 - Legs (leg type may vary)

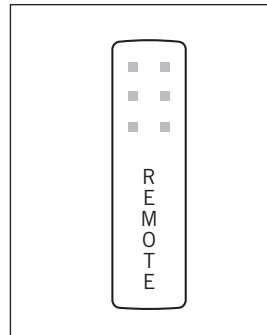

x1 - Remote Control
(Varies according to base type. Image may not match actual remote control.)

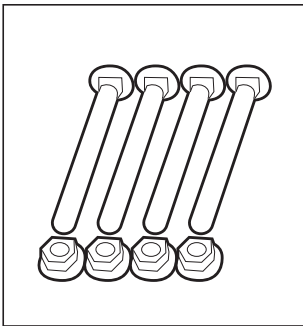

x4 - 3-Inch Carriage Bolts and Nuts

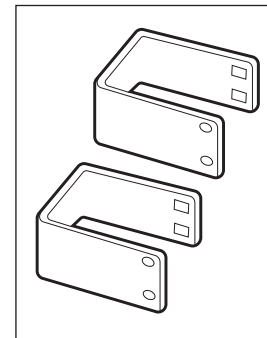

x2 - Center Support Brackets

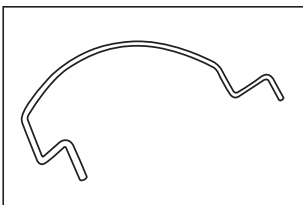

x1 - Mattress Retainer

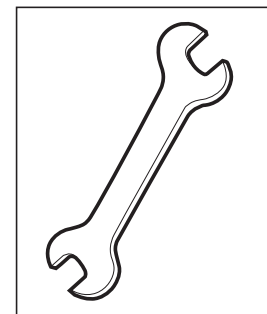

x1 - WRENCH

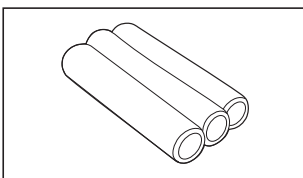

AAA Batteries*
(quantity & type varies according to base type)

*Remote Control may have integral battery - no battery install required

SETUP

STEP 6

- A. Place a center support bracket over the mounting points on each side of base.
- B. Insert carriage bolts through the square holes in the center support bracket.
- Install nuts on carriage bolts (FIGURE 4). **HAND TIGHTEN.**
- C. After all hardware is installed, tighten all nuts using provided wrench.

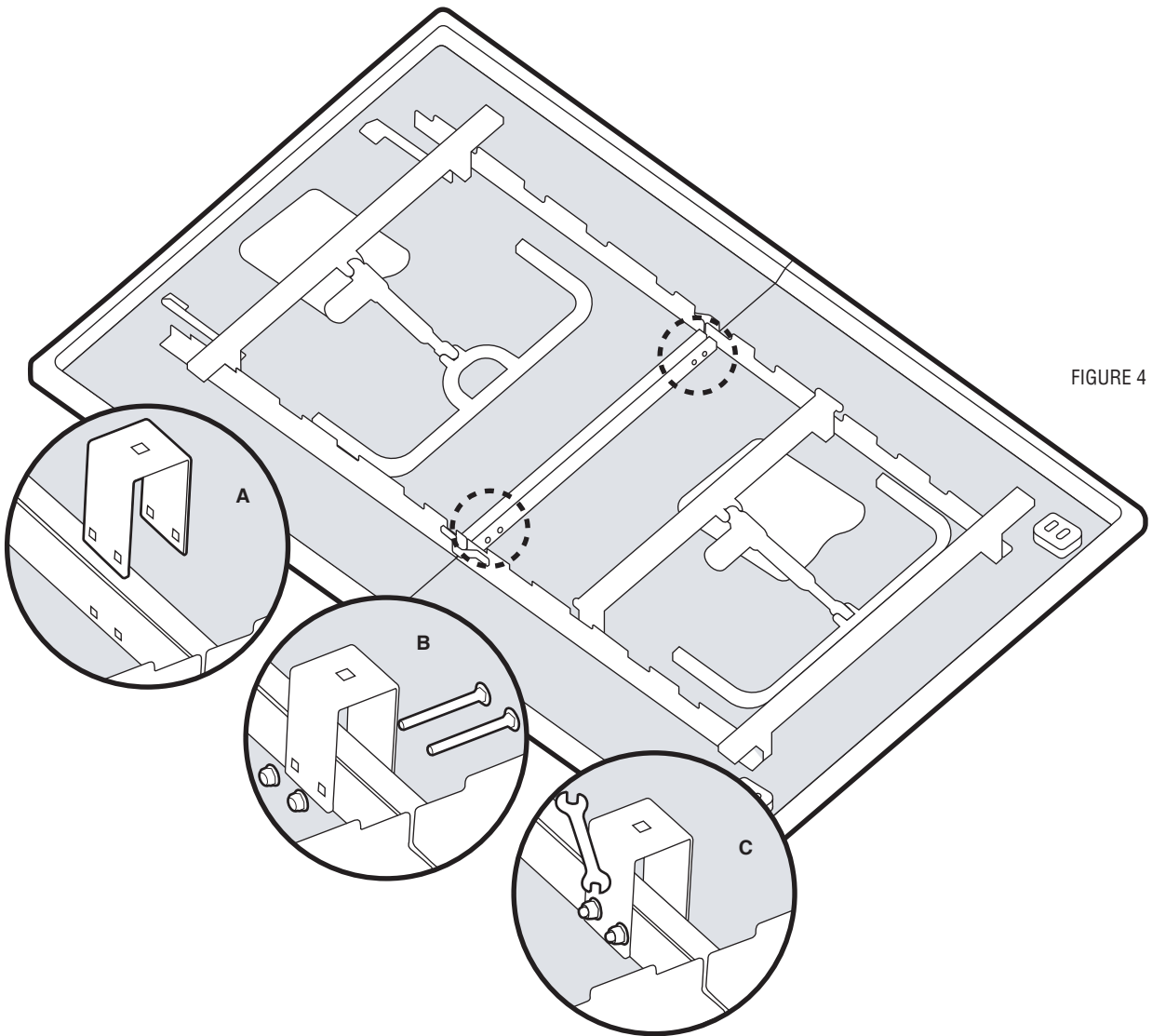
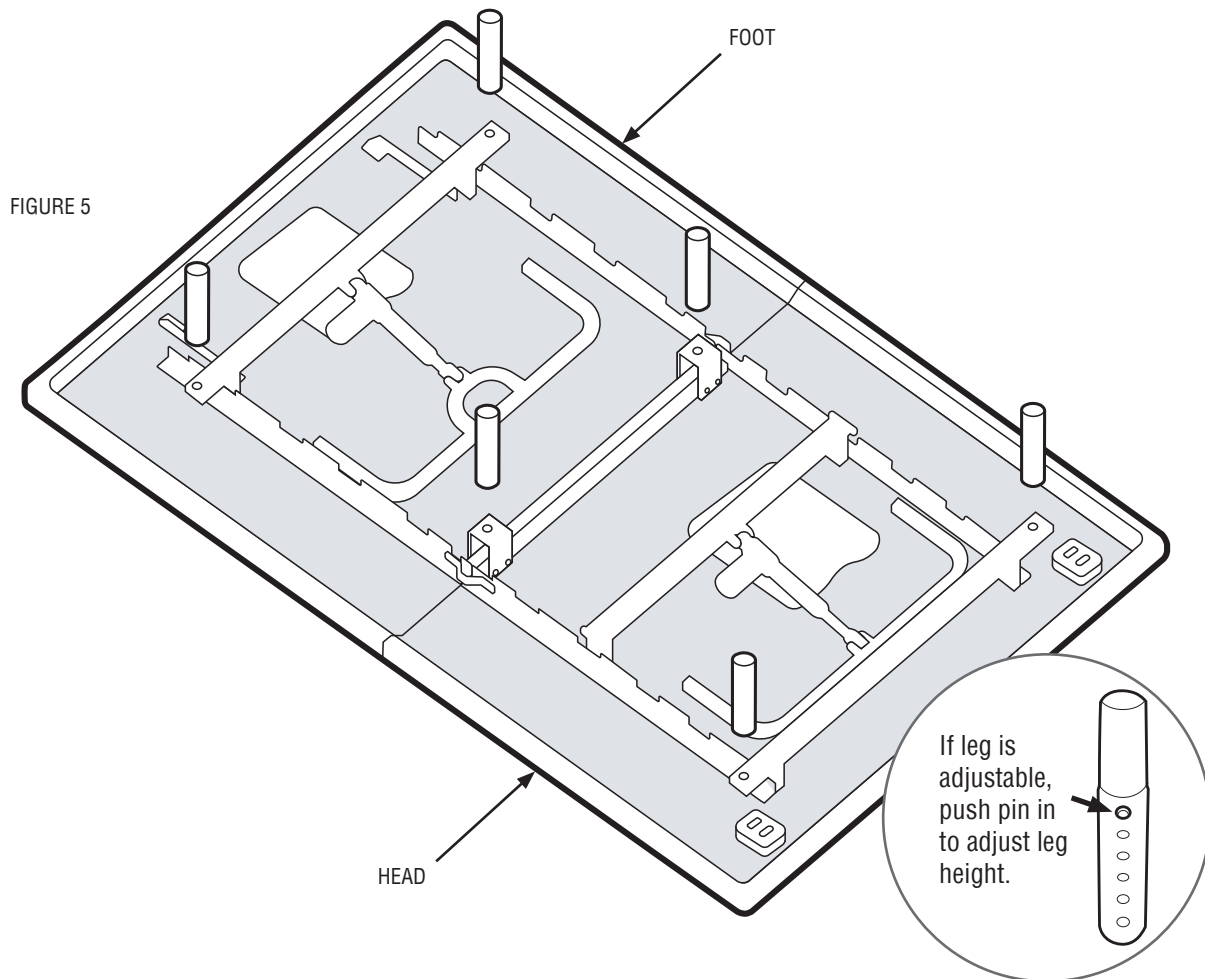

FIGURE 4

SETUP

STEP 7

Screw all legs into the threaded inserts (FIGURE 5). HAND TIGHTEN.



STEP 8

Extend power cord out head end of base. Remove protective covering from power cord plug.

STEP 9

Rotate base over onto its legs.

 **CAUTION**
HANDLE BASE BY FRAME ONLY. DO NOT
GRAB FABRIC.

 **WARNING**
DUE TO RISK OF INJURY, TWO ADULTS
ARE REQUIRED TO HANDLE AND MOVE
ADJUSTABLE BASE.

SETUP

STEP 10

Install batteries in remote control, if applicable.

Plug power cord into power outlet. *Note: An electrical surge protection device is recommended (not included).*

Operate remote control to test base functions.
See Remote Control User Guide for programming instructions (FIGURE 6).

STEP 11

Lower base to flat position.

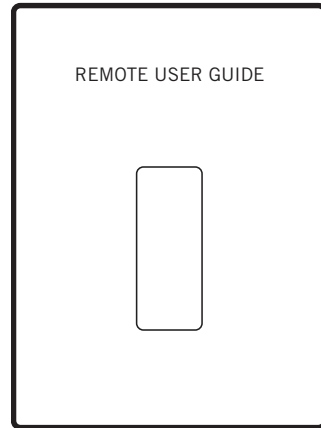

FIGURE 6

STEP 12a (OPTIONAL)

Your base may be equipped with a Micro-Hook™ system to hold the mattress in place (FIGURE 7), but a wire mattress retainer can still be used.

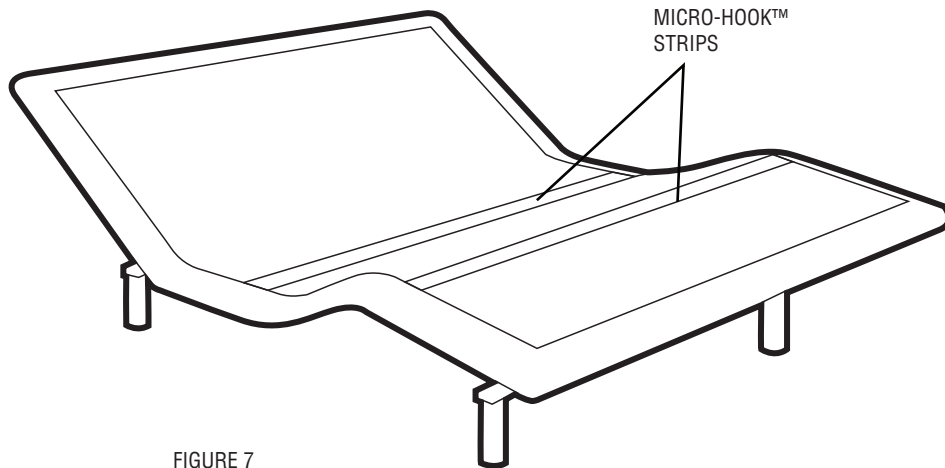

FIGURE 7

SETUP

STEP 12b (OPTIONAL)

Insert the mattress retainer into the holes at the foot end of the base (FIGURE 8).

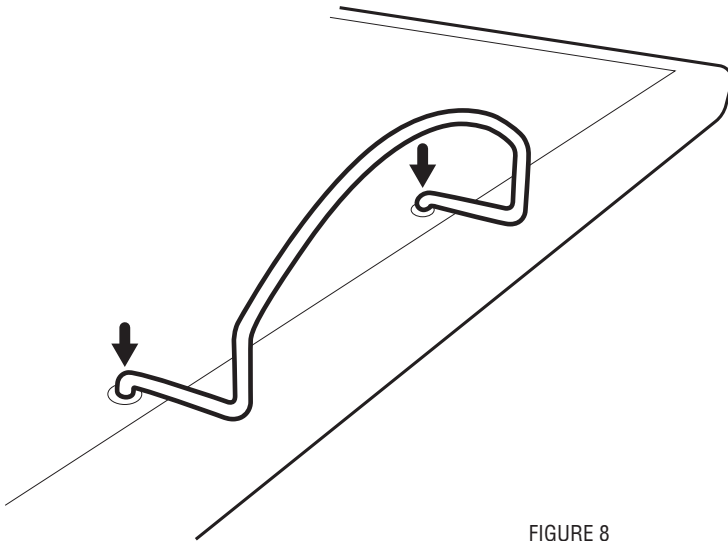

FIGURE 8

STEP 13

Place mattress on base to complete assembly.

USB PORTS

Your base is equipped with USB ports on each side of the base (at the head end). These USB ports are for charging low-voltage devices such as cell phones and tablets directly from the base.

USB ports are for charging convenience only. Remove USB charging cord and/or power cord from USB charging station before entering or exiting base. If an extended charging period is needed, it is recommended to use the wall outlet.



WARNING

USE THE DEVICE MANUFACTURER RECOMMENDED CHARGING CABLE TO CHARGE THE DEVICE. USING UNAPPROVED CHARGING CABLES IS A FIRE HAZARD.