



Smith & Wesson®

Safety & Instruction Manual For Smith & Wesson® CSX™ Pistols



CSX™



**Read the instructions and
warnings in this manual
CAREFULLY BEFORE
using this firearm.**

2100 Roosevelt Avenue • Springfield, MA 01104
1-800-331-0852 • Fax: 413-747-3317
www.smith-wesson.com

Copyright © 2021 Smith & Wesson Inc. All rights reserved.



WARNING:



READ THESE INSTRUCTIONS AND WARNINGS CAREFULLY. BE SURE YOU UNDERSTAND THESE INSTRUCTIONS AND WARNINGS BEFORE USING THIS FIREARM. FAILURE TO READ THESE INSTRUCTIONS AND TO FOLLOW THESE WARNINGS MAY RESULT IN SERIOUS INJURY OR DEATH TO YOU AND OTHERS AND DAMAGE TO PROPERTY.

THIS SAFETY & INSTRUCTION MANUAL SHOULD ALWAYS ACCOMPANY THIS FIREARM AND BE TRANSFERRED WITH IT UPON CHANGE OF OWNERSHIP OR WHEN PRESENTED TO ANOTHER PERSON. A COPY OF THE SAFETY AND INSTRUCTION MANUAL IS AVAILABLE FREE VIA DOWNLOAD AT www.smith-wesson.com OR, UPON REQUEST FROM:

**SMITH & WESSON®
CUSTOMER SUPPORT CENTER
2100 ROOSEVELT AVENUE
SPRINGFIELD, MA 01104
TEL.: 1-800-331-0852, ext. 4125
E-mail: qa@smith-wesson.com**

TABLE OF CONTENTS

YOUR SAFETY RESPONSIBILITIES	3-6
SAFE STORAGE AND TRANSPORTATION.....	7-8
AMMUNITION.....	9-11
MODEL AND FEATURES IDENTIFICATION	12
INSPECTING YOUR PISTOL	13-17
MANUAL THUMB SAFETY	18
LOADED CHAMBER INDICATOR	19
PREPARATION FOR FIRING.....	19-20
LOADING.....	20-22
FIRING	23-24
DECOCKING	24-26
HANGFIRES AND MISFIRES.....	27-29
CLEARING A MISFEED/JAMS	29-30
DRY-FIRING	30
MODES OF CARRY / HANDLING	31
UNLOADING	32-33
FIELD STRIPPING/DISASSEMBLY	33-36
LUBRICATION	36
ASSEMBLY	37-39
INTERCHANGEABLE PALMSWELL GRIP INSERTS	39-40
REVERSIBLE MAGAZINE RELEASE	40-41
MAGAZINE	42-43
SIGHT ADJUSTMENT.....	44
CLEANING AND MAINTENANCE	44-46
LIMITED WARRANTY	47-48
CONTACT AND SHIPPING INFORMATION	49-50
BATTERY WARNINGS.....	51
CUSTOM SERVICE.....	53
PATENT INFORMATION.....	54
INTERNATIONAL WARRANTY CENTERS.....	55

YOUR SAFETY RESPONSIBILITIES

SAFETY IS YOUR NUMBER ONE RESPONSIBILITY!

- At home, in the field, at the range, or anywhere, the first concern of every firearm owner should be safety. Apply the following safety rules in every situation, with any kind of firearm. If you feel uncertain about any operational aspects of your firearm, please contact Smith & Wesson at 1-800-331-0852, ext. 4125 before proceeding with its operation.
- If you are unfamiliar with firearms you should seek formal training before using your pistol.



WARNING: YOU MUST FOLLOW ALL OF THESE SAFETY RULES TO ENSURE THE SAFE USE OF YOUR FIREARM. THE FAILURE TO FOLLOW THE INSTRUCTIONS AND WARNINGS IN THIS MANUAL COULD CAUSE SERIOUS PERSONAL INJURY OR DEATH TO YOU OR OTHERS AND DAMAGE TO PROPERTY.

- As a firearm owner, you accept a demanding responsibility. How seriously you take this responsibility can be the difference between life and death. There is no excuse for careless or abusive handling of your firearm. At all times handle your firearm with intense respect for its power and potential danger.

YOUR SAFETY RESPONSIBILITIES CONTINUED

- **ALWAYS KEEP YOUR FIREARM POINTED IN A SAFE DIRECTION.** Never point a firearm at anyone or anything you do not intend to shoot whether or not it is loaded. This is particularly important when loading, unloading, or field stripping the gun. ALWAYS control the direction of the firearm.
- **ALWAYS TREAT EVERY FIREARM AS IF IT IS LOADED AND WILL FIRE.** Do not take anyone's word that the firearm is unloaded – always check for yourself. Never pass your firearm to another person until the cylinder or action is open and you visually check that it is unloaded. Keep your firearm unloaded and safely stored when not in use.
- **NEVER PLACE YOUR FINGER INSIDE THE TRIGGER GUARD OR ON THE TRIGGER UNLESS YOU INTEND TO FIRE.** Ensure that other objects do not touch the trigger.
- **ALWAYS BE SURE OF YOUR TARGET AND WHAT IS BEYOND IT.** Always be sure of where the bullet will strike and shoot only where there is a safe backstop free of obstructions, water or other surfaces which can cause ricochets. Be sure your bullet will stop behind your target. Bullets can glance off many surfaces like rocks or the surface of water and travel in unpredictable directions with considerable velocity. Do not fire randomly into the sky.
- **NEVER CROSS OBSTACLES SUCH AS FENCES OR STREAMS WITH A LOADED FIREARM.** Always make certain your firearm is unloaded before crossing a fence, climbing a tree, jumping a ditch or negotiating other obstacles.
- **SAFE GUN HANDLING IS YOUR PERSONAL RESPONSIBILITY AT ALL TIMES.** Firearms are dangerous and can cause serious injury or death if they are misused or used inappropriately. Safety must be the prime consideration of any one who owns or handles firearms. Accidents are the result of violating the rules of safe gun handling and common sense. Firearm safety training is available. Contact your firearms dealer, law enforcement agency, local sportsman's club, etc. for availability.
- **YOU ARE RESPONSIBLE FOR THE FIREARM AT ALL TIMES.** In owning a firearm, you must undertake the full-time responsibility for your firearm's safety and security. You must protect yourself and all others against injury or death from misuse of the firearm 24 hours a day.
- **FIREARM SECURITY IS YOUR RESPONSIBILITY.** You must secure firearms safely from children and/or unauthorized users. Your firearm should always be kept unloaded and locked when not in use. A lock has been provided for this purpose. Never assume that the use of this lock is sufficient to safely secure your firearm. You must always evaluate your personal situation and employ the security systems that meet your needs and prevent children and unauthorized users from gaining access to your firearm.

YOUR SAFETY RESPONSIBILITIES CONTINUED

- **APPROPRIATE USE FOR YOUR FIREARM MEANS USING YOUR FIREARM FOR LEGAL PURPOSES.** For example - target shooting, hunting and lawful resistance of deadly criminal force. It is your responsibility to ensure that you are in compliance with all applicable laws and ordinances regarding the use of your firearm.
- **NEVER RELY ON MECHANICAL FEATURES ALONE.** Only your safe gun-handling habits will ensure the safe use of your firearm. This is your responsibility.
- **ALWAYS SAFELY STORE AND SECURE YOUR FIREARM.** Safe and secure storage of your firearm is one of your most important responsibilities. It is a full-time responsibility. You must always secure your firearm and ammunition separately so that they are not accessible to children and/or other unauthorized persons.
- **NEVER KEEP AMMUNITION IN THE SAME LOCATION AS THE FIREARM.** Store each in a separate and secure place.
- **ALWAYS WEAR EYE PROTECTION THAT IS SPECIFIED FOR USE WITH FIREARMS** every time you handle your firearm for cleaning and maintenance.
- **ALWAYS WEAR EYE AND HEARING PROTECTION THAT ARE SPECIFIED FOR USE WITH FIREARMS** every time you discharge your firearm. Make sure others in the vicinity of where you will be shooting do so as well.
- **NEVER USE ALCOHOL OR DRUGS BEFORE OR WHILE SHOOTING.** Do not use your firearm if you are on any medication which impairs, even slightly, your mental or physical ability.
- **ALWAYS HAVE ADEQUATE VENTILATION.** Discharging firearms in poorly ventilated areas, cleaning firearms, or handling ammunition may result in exposure to lead and other substances known to cause birth defects, reproductive harm, and other serious physical injury. Review the warnings and labels for all ammunition and cleaning products carefully. Wash hands thoroughly after exposure.
- **BEFORE HANDLING ANY FIREARM, UNDERSTAND ITS OPERATION.** Not all firearms are the same. Familiarize yourself with the mechanical features of any firearm you intend to use. If you feel uncertain about any operational aspects of your firearm, please contact Smith & Wesson® at 1-800-331-0852, ext. 4125 before proceeding with its operation.
- **NEVER ALLOW A FIREARM TO BE USED BY INDIVIDUALS WHO DO NOT UNDERSTAND ITS SAFE OPERATION OR HAVE NOT READ THESE FIREARM SAFETY RULES.**

YOUR SAFETY RESPONSIBILITIES CONTINUED

- **ALWAYS USE THE CORRECT AMMUNITION FOR YOUR PARTICULAR FIREARM** as indicated by the marking on the firearm. Never use non-standard, damaged, corroded or reloaded, (handloaded) ammunition which has not been subjected to internal ballistic pressure testing.
- **BEWARE OF BARREL BORE OBSTRUCTIONS.** Be sure the barrel bore is clear of obstructions before shooting. Mud, water, snow or other objects may inadvertently lodge in the barrel bore. A small obstruction can cause a dangerous increase in pressure and may damage your gun and cause injury to yourself and others.
- **BE SURE ALL ACCESSORIES, SUCH AS HOLSTERS, GRIPS, SLINGS, SCOPES AND OTHER ACCESSORIES ARE COMPATIBLE** with the firearm and that the accessories do not interfere with safe operation. It is your responsibility to understand and follow all of the instructions in this manual, as well as those which may be supplied with your ammunition and any accessory.
- **NEVER DISASSEMBLE YOUR FIREARM** beyond the field stripping procedure outlined in this manual. Improper disassembly or reassembly of your firearm may be dangerous and can lead to serious injury or death.
- **NEVER MANIPULATE, ADJUST OR CHANGE ANY OF THE INTERNAL COMPONENTS OF YOUR FIREARM UNLESS SPECIFICALLY INSTRUCTED TO DO SO IN THIS MANUAL.** Improper manipulation of any other internal component may affect the safety and reliability of your firearm and may cause serious injury or death.
- **NEVER ALLOW ANY ALTERATION OR REPLACEMENT OF PARTS IN YOUR SMITH & WESSON® FIREARM UNLESS PERFORMED BY A QUALIFIED GUNSMITH** using genuine Smith & Wesson® parts. If you do otherwise, improper functioning of your firearm may occur and serious injury or death and damage to property may result.



WARNING: SAFE USE OF A FIREARM IS YOUR PERSONAL RESPONSIBILITY AND THE FAILURE TO FOLLOW ALL OF THESE BASIC SAFETY RULES MAY RESULT IN SEVERE PERSONAL INJURY OR DEATH TO YOU OR OTHERS AND DAMAGE TO PROPERTY. YOU ARE THE MOST IMPORTANT SAFETY DEVICE WHEN IT COMES TO THE USE OF YOUR FIREARM AND SMITH & WESSON WILL NOT BE RESPONSIBLE FOR ANY PERSONAL INJURY, DEATH OR PROPERTY DAMAGE THAT RESULTS FROM: (1) THE CRIMINAL OR NEGLIGENT USE OF THIS FIREARM; (2) A DISREGARD OF THESE SAFETY INSTRUCTIONS AND WARNINGS; (3) IMPROPER OR CARELESS HANDLING OF THIS FIREARM; (4) THE USE OF NON-STANDARD, DEFECTIVE OR IMPROPER AMMUNITION OR; (5) IMPROPER OR NEGLIGENT MODIFICATIONS OR REPAIRS TO THE FIREARM.

SAFE STORAGE AND TRANSPORTATION



WARNING: ALWAYS POINT THE MUZZLE IN A SAFE DIRECTION.



WARNING: FIREARMS ARE DANGEROUS WHEN USED AND STORED IMPROPERLY. THEY POSE A RISK OF SERIOUS OR FATAL INJURIES. FIREARMS CAN BE ESPECIALLY DANGEROUS TO CHILDREN WHEN THEY ARE STORED IN AN IRRESPONSIBLE AND UNSAFE MANNER. FOR YOUR SAFETY AND THE SAFETY OF OTHERS, IT IS IMPERATIVE THAT YOU KEEP YOUR FIREARM LOCKED AND UNLOADED IN A SECURE PLACE. THE AMMUNITION SHOULD BE STORED IN A SEPARATE, SECURE LOCATION WHEN IT IS NOT IN USE. SAFE AND SECURE STORAGE OF YOUR FIREARM IS ONE OF THE MOST IMPORTANT RULES OF FIREARM SAFETY. YOUR FAILURE TO FOLLOW THESE RULES MAY RESULT IN SERIOUS INJURY OR DEATH TO YOU OR OTHERS.

- **ALWAYS SECURE YOUR FIREARM IN A MANNER THAT WILL PREVENT UNAUTHORIZED ACCESS.** Whenever your firearm is not in use, keep it unloaded and locked. Your safety and the safety of others requires that you always secure and store your firearm in a manner that will prevent unauthorized access. Never leave a firearm unattended unless it is locked, unloaded and secured.
- **ALWAYS USE THE LOCK PROVIDED BY SMITH & WESSON® TO SECURE YOUR FIREARM.** Please read and follow the instructions packaged separately for the use of this lock. A lock, when properly used, can be an effective tool in preventing unauthorized access to your firearm. There are other alternative locks and safe storage containers available in the marketplace which may also be appropriate for your particular needs. Consult your local gun shop, hardware store, or local police department for guidance on the variety of other safe storage devices or practices which may be appropriate for your particular needs. By purchasing this firearm you have accepted the responsibility of safely securing the firearm at all times and preventing its unauthorized use. Never assume that the use of this lock alone is sufficient to safely secure your firearm. It is your personal responsibility to select and use whatever measures or practices that will enable you to be absolutely certain that your firearm is secure at all times.



WARNING: NEVER LOCK A LOADED FIREARM AND NEVER LOAD A LOCKED FIREARM!

- **ALWAYS STORE YOUR FIREARM AND AMMUNITION SEPARATELY** so that they are not accessible to children or other unauthorized persons. Safe and secure storage of your firearm and ammunition are your responsibility. It is a full-time responsibility.

SAFE STORAGE AND TRANSPORTATION CONTINUED

- **NEVER ASSUME THAT A “HIDING” PLACE IS A SECURE STORAGE METHOD.** Others may be aware of your storage location or come upon it by chance. It is your personal responsibility to use common sense when storing your firearm and ammunition and to always make sure they are not accessible to children or other unauthorized persons.
- **NEVER TRANSPORT A LOADED FIREARM.** When transporting your firearm, be sure it is unloaded and locked. Safe and secure transportation of your firearm is your responsibility.
- **ALWAYS FOLLOW THE LAW!** Many jurisdictions have laws that make it a crime to keep a firearm unlocked and in an area accessible to children or others. Keeping a firearm locked and unloaded when not in use is not only common sense safety practice... IT IS THE LAW. You must be familiar with all local, state, and federal laws regarding the safe storage and transportation of your firearm. Failure to know and follow the law may result in unauthorized access or use of your firearm by another. Obey all laws relating to the storage and transportation of firearms. Your local police department or gun shop can furnish you with available information on storing and/or transporting a firearm safely and legally.
- **YOUR FIREARM IS YOUR RESPONSIBILITY.** You must prevent your firearm from being stolen or from being used by untrained or unqualified individuals. Keep it locked, unloaded and secured when not in use.

AMMUNITION



WARNING: NEVER USE AMMUNITION NOT SPECIFICALLY DESIGNATED FOR USE IN YOUR FIREARM. FAILURE TO USE THE CORRECT TYPE OR CALIBER OF AMMUNITION MAY CAUSE THE FIREARM TO JAM, FAIL TO FIRE OR EVEN GENERATE EXCESSIVE PRESSURE WHICH CAN DAMAGE OR EVEN RUPTURE YOUR FIREARM, CAUSING PERSONAL INJURY, DEATH OR PROPERTY DAMAGE.

- Locate the cartridge designation marked on the firearm. This information indicates the correct ammunition that must be used in this firearm (FIGURE 1).
- You are responsible for selecting ammunition that meets industry standards and is appropriate in type and caliber for this firearm.

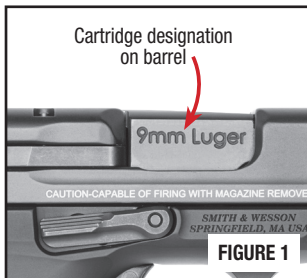

- Never use a cartridge not specifically designated for use in your firearm. The wrong type of ammunition may exceed the capability of your firearm and may damage or even rupture your firearm.
- Never mix ammunition.



WARNING: IN SOME CASES, A ROUND OF AMMUNITION NOT SPECIFIED ON YOUR FIREARM AND NOT LISTED AS ALTERNATE AMMUNITION IN THIS MANUAL, MAY FIT INTO THE CHAMBER. FIRING THIS AMMUNITION MAY CAUSE A RUPTURE RESULTING IN DAMAGE TO THE FIREARM AND PERSONAL INJURY OR DEATH TO THE SHOOTER OR BYSTANDERS. FOR MORE INFORMATION REGARDING UNSAFE CALIBER COMBINATIONS, REFER TO THE FOLLOWING URL: [HTTPS://SAAMI.ORG/TECHNICAL-INFORMATION/UNSAFE-FIREARM-AMMUNITION-COMBINATIONS/](https://saami.org/technical-information/unsafe-firearm-ammunition-combinations/)



WARNING: ALWAYS INSPECT YOUR AMMUNITION BEFORE USING IT. NEVER USE DIRTY, CORRODED OR DAMAGED AMMUNITION. A BORE OBSTRUCTION OR BURST CARTRIDGE MAY RESULT, CAUSING DAMAGE TO THE FIREARM AND PERSONAL INJURY OR DEATH TO THE SHOOTER OR BYSTANDERS.



WARNING: DISCHARGING FIREARMS IN POORLY VENTILATED AREAS, CLEANING FIREARMS, OR HANDLING AMMUNITION MAY RESULT IN EXPOSURE TO LEAD AND OTHER SUBSTANCES KNOWN TO CAUSE BIRTH DEFECTS, REPRODUCTIVE HARM, AND OTHER SERIOUS PHYSICAL INJURY. HAVE ADEQUATE VENTILATION AT ALL TIMES. WASH HANDS THOROUGHLY AFTER EXPOSURE.

AMMUNITION CONTINUED

- Use only commercially manufactured ammunition with internal ballistic pressures which are in strict accordance with the specifications of the Sporting Arms and Ammunition Manufacturers' Institute (SAAMI). If you are uncertain, contact your ammunition supplier for verification.



WARNING: NEVER USE NON-STANDARD, RELOADED OR "HAND-LOADED" AMMUNITION WHICH HAS NOT BEEN SUBJECTED TO INTERNAL BALLISTIC PRESSURE TESTING. RELOADED OR HAND-LOADED AMMUNITION, MAY HAVE MANY MANUFACTURING AND QUALITY VARIABLES (SUCH AS THE TYPE AND AMOUNT OF GUN POWDER). CARTRIDGE CASES THAT HAVE BEEN RELOADED AND FIRED MULTIPLE TIMES MAY SUFFER PHYSICAL DAMAGE WHICH COULD SIGNIFICANTLY IMPACT OR REDUCE THE INTEGRITY OF THE CARTRIDGE, POSSIBLY RESULTING IN BULLET SETBACK OR UNSEATING. CASE FAILURE AND INJURY TO THE SHOOTER OR BYSTANDERS AND DAMAGE TO THE FIREARM MAY RESULT WHEN SUCH A ROUND IS FIRED. ANY AMMUNITION THAT IS IMPROPERLY MANUFACTURED OR RELOADED, EVEN IN THE SLIGHTEST DEGREE, MAY FAIL TO FIRE OR MAY GENERATE EXCESSIVE INTERNAL PRESSURES WHICH CAN DAMAGE OR EVEN RUPTURE THE FIREARM, CAUSING PERSONAL INJURY OR DEATH TO THE SHOOTER OR THOSE IN THE IMMEDIATE VICINITY.

- A firearm and ammunition are a system and must work together. There are different types of ammunition for different types of firearms. Your firearm has been designed for ammunition of a specific type and a specific gauge or caliber. It is important to select the proper ammunition for your firearm.
- Different combinations of bullet velocity, bullet weight and firearm weight can have major impact on felt recoil; high felt recoil can be uncomfortable to some shooters.

For example:

- Firearm Weight: lower firearm weight increases felt recoil.
- Bullet Weight: higher bullet weight increases felt recoil.
- Bullet Velocity: higher bullet velocity increases felt recoil.

To acclimate yourself to higher levels of felt recoil, consider the following:

- Use a firm two-hand hold on the grip when firing.
- Always start your shooting experience with the lowest bullet velocity and lowest bullet weight available for your firearm.
- Ask your firearm dealer to suggest the lowest power, lowest velocity, lightest bullet weight for your firearm.

AMMUNITION CONTINUED



WARNING: NEVER USE AMMUNITION OF THE INCORRECT GAUGE OR CALIBER. USING AMMUNITION OF THE INCORRECT GAUGE OR CALIBER MAY CAUSE DAMAGE TO YOUR FIREARM AND POSSIBLE SERIOUS INJURY TO YOU AND TO OTHERS.



WARNING: NEVER USE CARTRIDGES OTHER THAN THOSE DESIGNATED BY THE MARKING ON THE FIREARM. DOING SO CAN RESULT IN DANGEROUSLY HIGH PRESSURES THAT MAY DAMAGE THE FIREARM AND POSSIBLY CAUSE SERIOUS INJURY TO YOURSELF AND OTHERS.



WARNING: DEATH, SERIOUS INJURY AND/OR PROPERTY DAMAGE CAN RESULT FROM THE USE OF INCORRECT AMMUNITION OR BORE OBSTRUCTIONS. NEVER USE RELOADED AMMUNITION THAT HAS NOT BEEN SUBJECTED TO INTERNAL BALLISTIC PRESSURE TESTING.

- “Plus-P” (+P) ammunition generates pressures in excess of the pressures associated with standard ammunition. Such pressures may affect the wear characteristics and may result in the need for more frequent service.
- “Plus-P-Plus” (+P+) ammunition must not be used in Smith & Wesson firearms. This marking on the ammunition designates that it exceeds established industry standards, but the designation does not represent defined pressure limits and therefore such ammunition may vary significantly as to the pressures generated and could be DANGEROUS.

Marking on Firearm	Ammunition Type		
	Standard	+P	+P+
380 AUTO	OK	NO	NO
9mm	OK	OK	NO
9x21mm	OK	NO	NO
38 Super	OK	OK	NO
357 SIG	OK	NO	NO
40 S&W	OK	NO	NO
45 AUTO	OK	OK	NO

- Some brands of ammunition may cause difficulty in extracting spent cartridge cases from the chamber. If this situation occurs, thoroughly clean the chamber with solvent. If this condition persists, we recommend changing to another brand of ammunition.

MODEL AND FEATURES IDENTIFICATION



FIGURE 2



FIGURE 3

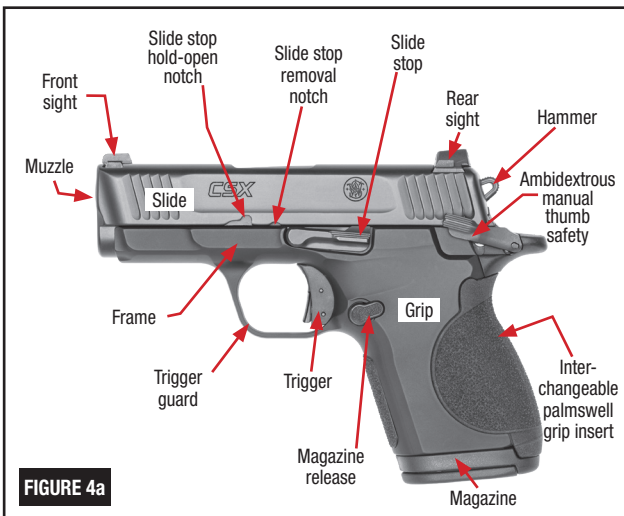

FIGURE 4a

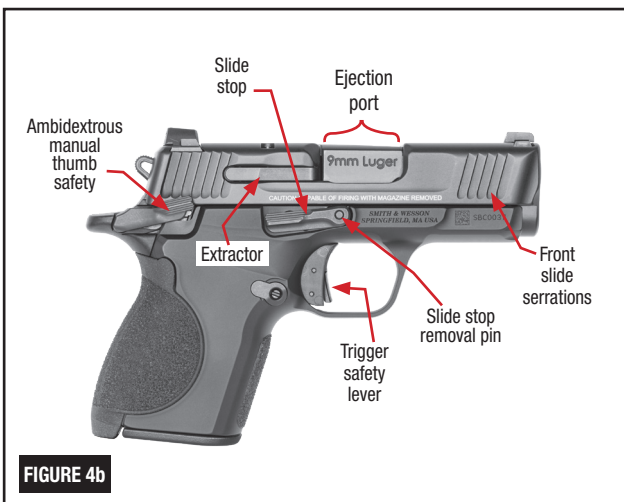

FIGURE 4b

INSPECTING YOUR PISTOL



WARNING: ALWAYS KEEP THE MUZZLE POINTED IN A SAFE DIRECTION.



WARNING: ALWAYS ENSURE THAT THE FIREARM IS UNLOADED BEFORE INSPECTING, DISASSEMBLING, ASSEMBLING OR CLEANING IT.



WARNING: NEVER RELY ON MECHANICAL FEATURES ALONE. ONLY YOUR SAFE FIREARM HANDLING WILL ENSURE THE SAFE USE OF YOUR FIREARM. THIS IS YOUR RESPONSIBILITY.

- When you inspect your pistol, you should first check for yourself to ensure that it is unloaded. Never take anyone's word for it.

- As shipped from the factory, an empty chamber flag is used to indicate that no round of ammunition is present in the chamber (FIGURE 5).

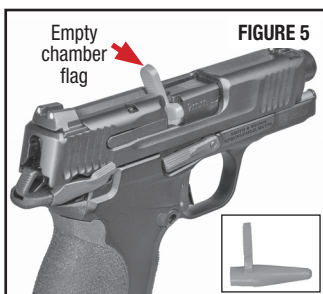

- Grasp the pistol with your finger off the trigger and outside the trigger guard, point the muzzle in a safe direction, push the manual thumb safety fully up into the SAFE position (FIGURE 6).



- Press the magazine release and remove the magazine from the pistol (FIGURE 7).



WARNING: REMOVING THE MAGAZINE FROM THE SMITH & WESSON® CSX™ PISTOL DOES NOT UNLOAD THE CHAMBER. THE PISTOL CAN FIRE WITH THE MAGAZINE REMOVED, IF A ROUND HAS BEEN CHAMBERED AND THE SAFETY IS PLACED IN THE FIRE POSITION AND THE TRIGGER IS THEN PULLED TO THE REAR.

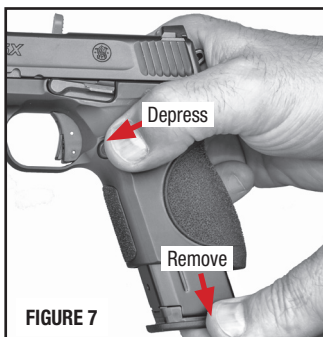

INSPECTING YOUR PISTOL CONTINUED

- Keep the pistol pointed in a safe direction, grasp the slide from the rear with the thumb and fingers as shown and briskly draw the slide fully rearward. With the slide held fully rearward, lock the slide in the open position by pressing upward on the slide stop and then allowing the slide to move slightly forward to engage the slide stop (FIGURE 8).



- Remove the empty chamber flag from the pistol (FIGURE 9).

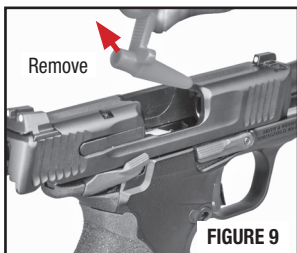

- Check the barrel chamber and verify that the pistol is unloaded (FIGURE 10).

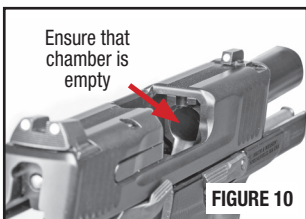

- Check the magazine well to verify that the pistol is unloaded (FIGURE 11).



- Check the bore for any obstructions and remove any obstructions that are found.

- If the Empty Chamber Flag is not visible when you handle the pistol, treat the pistol as if a round has been loaded into the chamber. With the pistol pointing in a safe direction, push the manual thumb safety up into the SAFE position (FIGURE 12).

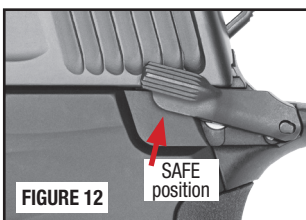

- Depress the magazine release and remove the magazine from the pistol (FIGURE 13).

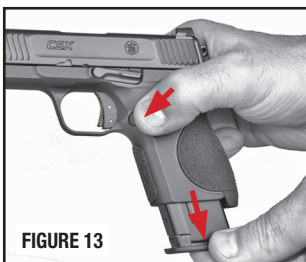

WARNING: REMOVING THE MAGAZINE FROM THE SMITH & WESSON® CSX™ PISTOL DOES NOT UNLOAD THE CHAMBER. THE PISTOL CAN FIRE WITH THE MAGAZINE REMOVED, IF A ROUND HAS BEEN CHAMBERED AND THE SAFETY IS PLACED IN THE FIRE POSITION AND THE TRIGGER IS THEN PULLED TO THE REAR.

INSPECTING YOUR PISTOL CONTINUED

- Grasp the slide from the rear with the thumb and fingers and briskly draw the slide fully rearward in order to extract any cartridge from the chamber and clear it from the pistol (FIGURE 14). Do not obstruct the ejection port because doing so can interfere with ejection of a cartridge from the pistol.

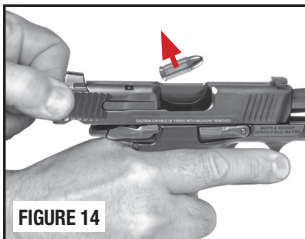

- With the slide held fully rearward, lock the slide in the open position by pressing upward on the slide stop and then allowing the slide to move slightly forward to engage the slide stop (FIGURE 15).



- Ensure that the chamber is empty and that no magazine is present in the pistol. Draw the slide slightly rearward to unlock the slide stop and lower the slide to the closed position.



- Move the manual safety lever fully down to the FIRE position (FIGURE 16).

- With your thumb firmly on the hammer, pull the trigger to the rear and hold it while lowering the hammer (FIGURE 17) to the forward “at rest” position and then release the trigger.



INSPECTING YOUR PISTOL CONTINUED

- There are three hammer positions your Smith & Wesson® CSX™ pistol can be in: **AT REST**, **HALF-COCK** and **COCKED** (FIGURES 18, 19 and 20).
- Keep your finger off the trigger when cocking the hammer and after initial release when you are lowering the hammer.

- **AT REST** (Fully forward) position is when the face of the hammer is resting on the firing pin. The firing pin is not in contact with the cartridge's primer, however.

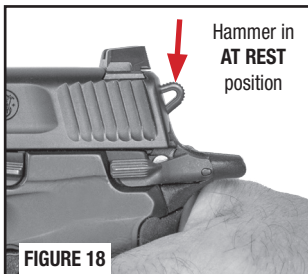

- **HALF-COCK** (Central) position of the hammer functions as a passive safety. It will prevent the hammer from falling fully forward unintentionally when cocking or decocking the hammer. When decocking, the trigger should be pulled only long enough to disengage the hammer from the cocked position and then the trigger is immediately released. When cocking, if the hammer slips off the shooter's thumb, the half-cock notch stops the hammer before it contacts the firing pin.

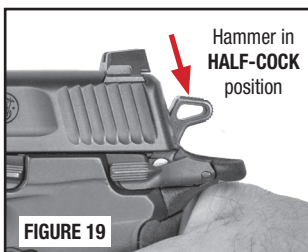

- **COCKED** (Fully rearward) position is when the hammer is pulled to the second "click" point. This is the position from which the pistol will discharge the round in the chamber when the manual safety lever is placed down in the FIRE position and the trigger is then pulled.

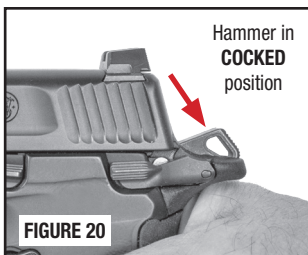

- The manual thumb safety lever can be moved into the SAFE or FIRE position regardless of the position of the hammer.

INSPECTING YOUR PISTOL CONTINUED

- With the slide locked open, examine the breech face to ensure that the firing pin is not protruding (FIGURE 21).
- If the firing pin is protruding (FIGURE 22), do not attempt to load or fire the firearm. Bring the pistol to a gunsmith qualified to perform service on Smith & Wesson® firearms.
- Unload the magazine by holding it with the bullet end of the cartridge pointing away from you and others and pressing each cartridge forward and out of the magazine (FIGURE 23).
- Before using your firearm for the first time, it should be cleaned.
- You must follow these procedures every time a firearm leaves your hand, is cleaned, is handed to you or to another person, is transported, or is stored.

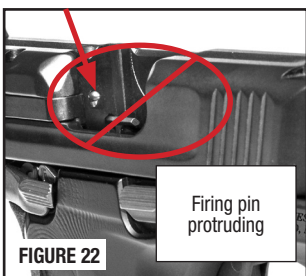
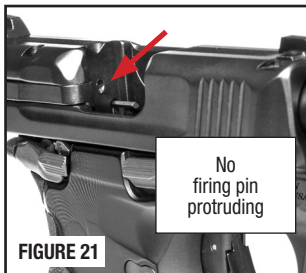

MANUAL THUMB SAFETY



WARNING: NEVER RELY ON MECHANICAL FEATURES ALONE. ONLY YOUR SAFE GUN HANDLING WILL ENSURE THE SAFE USE OF YOUR FIREARM. THIS IS YOUR RESPONSIBILITY.



WARNING: IT IS YOUR RESPONSIBILITY TO CONTINUOUSLY EXAMINE YOUR PERSONAL SITUATION TO PROVIDE A SUFFICIENT LEVEL OF SAFETY.

- Your Smith & Wesson® CSX™ pistol is equipped with an ambidextrous manual thumb safety lever (FIGURE 24). The lever functions the same from left and right sides of the pistol.
- The manual thumb safety prevents the trigger from moving rearward when the thumb safety lever is fully up in the “SAFE” position.
- Push the thumb safety lever fully upward to put it in “SAFE” position.
- Lower the thumb safety lever fully to put it in the “FIRE” position, allowing the pistol to be discharged when the trigger is then pulled to the rear.
- The slide can still be opened and closed regardless of the position of the safety lever.
- The magazine can be removed and installed in the pistol regardless of the position of the safety lever.
- The pistol can be loaded and unloaded regardless of the position of the safety lever.

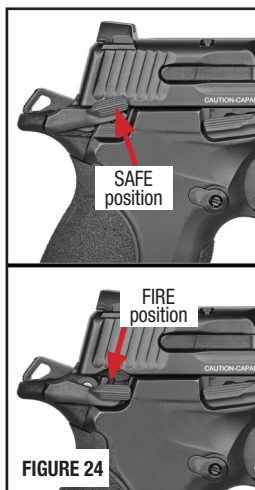

LOADED CHAMBER INDICATOR



WARNING: NEVER RELY UPON THE LOADED CHAMBER INDICATOR ALONE TO VERIFY THE PRESENCE OR ABSENCE OF A ROUND IN THE CHAMBER. THE SUREST METHOD TO DETERMINE THE PRESENCE OR ABSENCE OF A ROUND IN THE CHAMBER IS TO VISUALLY CHECK THE CHAMBER OF YOUR FIREARM BY REMOVING THE MAGAZINE AND PULLING AND LOCKING THE SLIDE IN THE OPEN POSITION.



WARNING: ALWAYS TREAT EVERY FIREARM AS IF IT IS LOADED AND WILL FIRE IF THE TRIGGER IS PULLED. A LOADED CHAMBER INDICATOR MAY HELP DETERMINE WHETHER THE CHAMBER IS LOADED OR UNLOADED. THE AMOUNT OF LIGHT, CLEANLINESS OF THE PISTOL, COLOR OF THE AMMUNITION AND OTHER FACTORS MAY LIMIT THE EFFECTIVENESS OF THE LOADED CHAMBER INDICATOR.

- This indicator can be observed by looking at the top of the slide/ejection port, (FIGURE 25) noting an opening at the rear of the barrel hood. By looking into this opening, while keeping the pistol pointed in a safe direction, you can observe whether or not a round is in the firearm's chamber. If a round is in the chamber, you should be able to see the actual cartridge rim through this opening.



PREPARATION FOR FIRING



WARNING: THE SMITH & WESSON® CSX™ PISTOL CAN BE FIRED WHEN THE MAGAZINE IS REMOVED FROM THE PISTOL. KEEP YOUR FINGER OFF THE TRIGGER AND OUTSIDE OF THE TRIGGER GUARD UNTIL YOU HAVE MADE THE COMMITMENT TO FIRE.



WARNING: FAILURE TO FOLLOW THESE FIREARM SAFETY REQUIREMENTS WILL CAUSE SERIOUS PERSONAL INJURY OR DEATH TO YOU OR OTHERS.

- **ALWAYS TREAT ALL FIREARMS AS IF THEY ARE LOADED.**
- **ALWAYS BE SURE THAT THE CHAMBER IS CLEAR OF A CARTRIDGE, THE MAGAZINE IS REMOVED OR UNLOADED, AND THAT THE FIREARM IS POINTING IN A SAFE DIRECTION.**
- **ALWAYS WEAR ADEQUATE AND PROPER HEARING PROTECTION SPECIFIED FOR FIREARM USE** to prevent permanent damage to your hearing. Make sure others who are nearby are wearing hearing protection as well.

PREPARATION FOR FIRING CONTINUED

- **ALWAYS KEEP FINGERS AND OTHER BODY PARTS AWAY FROM THE MUZZLE AND AWAY FROM THE PISTOL SLIDE, EJECTION PORT AND ANY BARREL PORTS OR COMPENSATORS ON THE FIREARM WHEN FIRING.** Failure to do so creates a risk of personal injury from bullets, hot gases from burning powder and/or debris spitting.
- **ALWAYS WEAR SAFETY GLASSES SPECIFIED FOR USE WITH FIRE-ARMS** whether indoors or out. Safety glasses should protect your eyes from the firing flash and particles associated with the discharge of ammunition. Failure to do so creates a risk of personal injury from particle or debris spitting or a ricochet.
- **ALWAYS BE ALERT AND ALWAYS FOLLOW THE SAFETY INSTRUCTIONS OF THE RANGE OFFICER.** Never shoot if you are tired, cold or impaired in any way.
- **THE SHOOTER (AND ALL OTHERS IN THE SHOOTING AREA) MUST ALWAYS BE IN A POSITION THAT IS OUT OF THE LINE OF FIRE** and not within an area where they may be struck by a ricochet or particles spitting from a firearm, or by ejected cases.
- **ALWAYS BE AWARE OF OTHER PEOPLE** so that persons do not accidentally walk into the line of fire.
- **NEVER FIRE RANDOMLY INTO THE SKY.** Always select a place to shoot that has a safe backstop.
- **NEVER SHOOT AT SURFACES THAT MAY CAUSE A RICOCHET.** Always select a place to shoot that has a safe backstop, is free from obstructions and has no surfaces which may cause a ricochet.
- **NEVER USE ALCOHOL OR DRUGS BEFORE OR WHILE SHOOTING OR HANDLING ANY FIREARM.**

LOADING



WARNING: ALWAYS KEEP THE MUZZLE OF THE FIREARM POINTED IN A SAFE DIRECTION.

NOTE: PRIOR TO CYCLING THE SLIDE, THE MANUAL THUMB SAFETY SHOULD BE PLACED UP IN THE SAFE POSITION. THE PROCESS OF CHAMBERING A ROUND BY CYCLING THE SLIDE WILL COCK THE HAMMER AND PREPARE THE PISTOL FOR FIRING.

- Do not load the pistol until you have read and fully understand this manual.

LOADING CONTINUED

- Do not load the pistol until you are ready to use it. Keep your finger off the trigger and outside the trigger guard until you are ready to fire.
- Never load your pistol until you are sure of your target, what is beyond it and are fully prepared to fire.
- Smith & Wesson® has provided you with a magazine designed to operate in your specific model of pistol. While your magazine may be able to be inserted into another model pistol, it will only function properly in the specific model for which it was designed. Do not interchange magazines from one model pistol to another model pistol.
- Follow instructions in this manual and any other specific instructions which may be marked onto, or accompany, a magazine. Failure to use the particular type of Smith & Wesson® magazine specified for your model and caliber of pistol may result in a malfunction.

- Load the magazine by pressing a cartridge head (rear of cartridge) downward on the forward portion of the magazine follower (or downward on the case of the previously loaded cartridge) and sliding the cartridge fully under the lips of the magazine until the cartridge head is against the rear wall of the magazine (FIGURE 26). Repeat this procedure for the number of cartridges you wish to load, up to the magazine capacity. Do not attempt to load your magazine with more than the specified number of cartridges because doing so can cause a feeding failure.

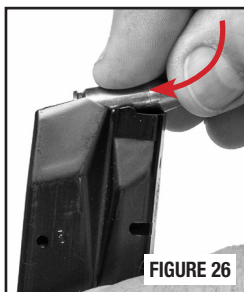

- Inspect your pistol as previously described in the “Inspecting Your Pistol” section. Hold the pistol in one hand with the muzzle pointing in a safe direction and with your finger off the trigger and outside the trigger guard. Insert the loaded magazine into the magazine well (opening) of the pistol until it is locked in place.



WARNING: DO NOT USE EXCESSIVE UPWARD FORCE WHEN INSERTING A LOADED MAGAZINE INTO THE PISTOL. EXCESSIVE UPWARD FORCE COULD CAUSE THE SLIDE TO MOVE FORWARD, CHAMBERING A ROUND AND MAKING THE PISTOL READY TO FIRE.

NOTE: After inserting a magazine, always test to make sure it is locked in place by applying some removal pressure to the exposed portion of the magazine floor plate.

LOADING CONTINUED



WARNING: VERIFY THAT THE FIRING PIN IS NOT PROTRUDING FROM THE BREECH FACE. IF THE FIRING PIN IS PROTRUDING, DO NOT ATTEMPT TO LOAD OR FIRE THE FIREARM. BRING THE PISTOL TO A GUNSMITH QUALIFIED TO PERFORM SERVICE ON SMITH & WESSON® FIREARMS.

- Pull the slide to the rear and release it, allowing it to carry fully forward. This strips a cartridge from the magazine and seats it in the chamber of the barrel.



WARNING: IF THE CARTRIDGE FAILS TO STRIP FROM THE MAGAZINE OR FULLY SEAT INTO THE CHAMBER, IMMEDIATELY STOP THE LOADING PROCESS. REMOVE THE MAGAZINE, LOCK THE SLIDE OPEN AND VERIFY THAT THE CHAMBER IS EMPTY. REFER TO THE “INSPECTING YOUR PISTOL” SECTION OF THIS MANUAL.



WARNING: ALWAYS LOAD A ROUND INTO THE CHAMBER BY FEEDING IT FROM THE MAGAZINE. FAILURE TO FOLLOW THIS WARNING CAN RESULT IN SEVERE INJURY OR DEATH TO YOU OR OTHERS. NEVER ATTEMPT TO LOAD THE PISTOL BY INSERTING A ROUND INTO THE OPEN EJECTION PORT.

CAUTION: The pistol can now be fired by lowering the manual safety to the FIRE position and then pulling the trigger to the rear.

- If you wish to restore the magazine in your pistol to its full capacity, press the magazine release and remove the magazine from the pistol. Remember that there is a round in the chamber; therefore, the safety lever should be placed up in the SAFE position and the firearm should be holstered or safely secured during this process without touching the trigger. Load one cartridge into the magazine to replace the one which was chambered when the slide moved forward and closed.



WARNING: THIS SMITH & WESSON® CSX™ PISTOL CAN BE FIRED WHEN THE MAGAZINE IS REMOVED FROM THE PISTOL. KEEP YOUR FINGER OFF THE TRIGGER AND OUTSIDE OF THE TRIGGER GUARD UNTIL YOU HAVE MADE THE COMMITMENT TO FIRE.

- Reinsert the loaded magazine into the magazine well of the pistol until it is locked in place. To make sure that the magazine is again fully and securely inserted, apply some removal pressure to the exposed portion of the magazine floor plate.
- Your pistol and its magazine are now fully loaded and will fire when the manual safety is down in the FIRE position and the trigger is pulled. Keep your pistol pointed in a safe direction and keep your finger or any other object off the trigger and outside the trigger guard until you have made the commitment to fire the handgun.
- Never leave a loaded firearm out of your direct control.

FIRING



WARNING: ALWAYS KEEP THE MUZZLE POINTED IN A SAFE DIRECTION.



WARNING: UPON FIRING THE PISTOL OR RELEASING THE SLIDE FROM THE SLIDE STOP, THE SLIDE MOVES REARWARD OR FORWARD WITH SIGNIFICANT FORCE AND SPEED. TO AVOID INJURY, BE SURE NO PART OF YOUR BODY IS IN THE PATH OF THE SLIDE'S TRAVEL (FIGURE 27).

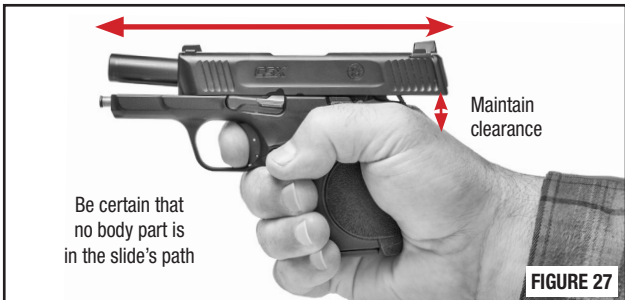

WARNING: WEAR EYE AND HEARING PROTECTION SPECIFIED FOR FIREARM USE EVERY TIME YOU DISCHARGE YOUR FIREARM. MAKE SURE OTHERS IN THE VICINITY OF WHERE YOU WILL BE SHOOTING DO SO AS WELL.

- It has come to our attention that some users of Smith & Wesson® handguns may stage the trigger in anticipation of firing a shot. Staging is the act of pulling the trigger rearward toward – stopping just short of – the point where the handgun fires. Such manipulation of the trigger can reduce the user's control of the handgun and can result in an unintentional discharge. Furthermore if the user decides not to fire, release of the trigger from a position close to the firing point in the staging process could result in an unintentional discharge.



WARNING: "STAGING" THE TRIGGER VIOLATES A BASIC RULE OF FIREARM SAFETY WHICH WARNS YOU TO KEEP YOUR FINGER OUT OF THE TRIGGER GUARD UNTIL YOU HAVE MADE THE COMMITMENT TO FIRE. "STAGING" CREATES A SERIOUS RISK OF PERSONAL INJURY OR DEATH TO THE SHOOTER OR BYSTANDERS AND DAMAGE TO PROPERTY SINCE IT MAY LEAD TO AN UNINTENTIONAL DISCHARGE.

- Keep the muzzle pointed in a safe direction and your finger outside the trigger guard until you are ready to fire.
- While holding the grip firmly, push the manual safety lever fully down into the FIRE position (FIGURE 28).



FIRING CONTINUED

- Pull the trigger fully to the rear. As the trigger is drawn fully to the rear, the hammer is released from the cocked position, striking the firing pin which in turn strikes the primer and discharges the round in the chamber.
- Upon firing, the slide moves rearward thereby extracting and ejecting the spent cartridge case through the ejection port (FIGURE 29). The slide then returns forward, feeding the next cartridge from the magazine into the barrel chamber.

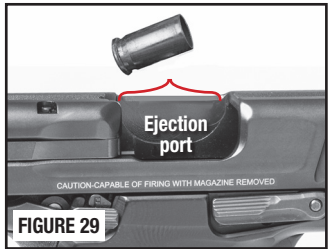

- After firing a shot, you must allow the trigger to move fully forward to reset the mechanism before you can fire the next shot. Failure to let the trigger move fully forward will prevent the lockwork from cycling and will prevent you from being able to fire the next shot.
- Keep your finger off the trigger and outside the trigger guard until you are ready to fire again.
- This sequence can be repeated until the last round in the pistol has been fired, at which time the magazine follower exerts upward pressure on the slide stop, causing the slide stop to engage the slide and to hold it in the open position.

DECOCKING THE SMITH & WESSON® CSX™ PISTOL

NOTE: PRIOR TO CYCLING THE SLIDE, THE MANUAL THUMB SAFETY SHOULD BE PLACED UP IN THE SAFE POSITION. THE PROCESS OF CHAMBERING A ROUND BY CYCLING THE SLIDE WILL COCK THE HAMMER AND PREPARE IT FOR FIRING.



WARNING: ALWAYS KEEP THE MUZZLE POINTED IN A SAFE DIRECTION.



WARNING: DO NOT LOAD THE SMITH & WESSON® CSX™ PISTOL UNTIL YOU ARE READY TO USE IT. UNLOAD THE PISTOL IMMEDIATELY WHEN IT IS NOT IN USE OR PRIOR TO CLEANING AND STORAGE.



WARNING: SAFE GUN HANDLING SKILLS ARE A MUST, THE USER SHOULD NEVER RELY SOLELY ON ANY MECHANICAL SAFETY DEVICES WHEN HANDLING THE SMITH & WESSON® CSX™ PISTOL.

DECOCKING THE S&W® CSX™ PISTOL CONTINUED



WARNING: NEVER DECOCK THE HAMMER OF THE SMITH & WESSON® CSX™ PISTOL WHEN THE CHAMBER IS LOADED. FAILURE TO UNLOAD THE CHAMBER FIRST COULD RESULT IN THE PISTOL FIRING UNINTENTIONALLY IF THE HAMMER SLIPS FORWARD DURING DECOCKING WHILE THE TRIGGER IS BEING HELD.

- The hammer of your Smith & Wesson® CSX™ pistol is cocked after a round has been chambered (or when firing a string of shots) and then the user decides not to fire the handgun again at this time, there are several courses of action that may be taken:

FIRST OPTION: Restore to ready condition.

- Point the muzzle in a safe direction and remove your finger from the trigger and keep it outside of the trigger guard.
- Place the manual safety lever fully up in the “SAFE” position (FIGURE 30).
- Press the magazine release and remove the magazine from the pistol (FIGURE 31).

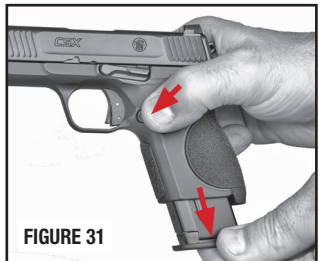
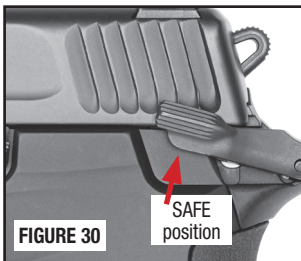

WARNING: REMOVING THE MAGAZINE FROM THE SMITH & WESSON® CSX™ PISTOL DOES NOT UNLOAD CHAMBER. THE PISTOL CAN FIRE WITH THE MAGAZINE REMOVED, IF A ROUND HAS BEEN CHAMBERED AND THE SAFETY IS PLACED IN THE FIRE POSITION AND THE TRIGGER IS THEN PULLED TO THE REAR.

- Secure the pistol in a holster or other controlled location.
- Reload the magazine and then return the loaded magazine to the pistol.
- Return the pistol to your holster or other controlled storage.

SECOND OPTION: Unload and decock. If you are done firing and want to unload the pistol, you must follow these instructions to unload and decock the pistol:

- Point the muzzle in a safe direction and remove your finger from the trigger and keep it outside of the trigger guard.

DECOCKING THE S&W® CSX™ PISTOL CONTINUED

- Place the manual safety lever fully up in the “SAFE” position (FIGURE 32).
- Press the magazine release and remove the magazine from the pistol (FIGURE 33).

WARNING: REMOVING THE MAGAZINE FROM THE SMITH & WESSON® CSX™ PISTOL DOES NOT UNLOAD CHAMBER. THE PISTOL CAN FIRE WITH THE MAGAZINE REMOVED, IF A ROUND HAS BEEN CHAMBERED AND THE SAFETY IS PLACED IN THE FIRE POSITION AND THE TRIGGER IS THEN PULLED TO THE REAR.

- Grasp the slide and pull it briskly to the rear to eject any chambered round (FIGURE 34). Do not block the ejection port as that may interfere with complete ejection of the chambered round.

- With the slide held open, verify that the chamber and magazine well are free of any cartridges.

- Allow the slide to move fully forward to the closed position.

- Move the manual safety lever fully down to the FIRE position (FIGURE 35).

- With your thumb firmly on the hammer, pull the trigger to the rear and hold it while lowering the hammer (FIGURE 36) to the forward “at rest” position and then release the trigger.

- Move the manual safety lever fully up to the SAFE position (FIGURE 37).

- Return the pistol to your holster or other controlled storage.

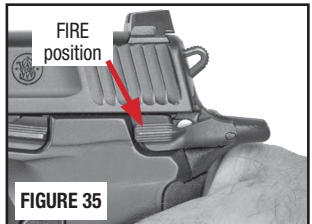
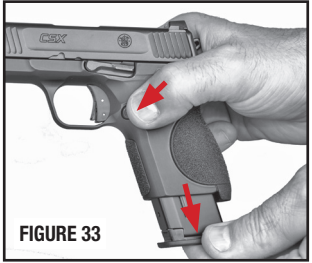
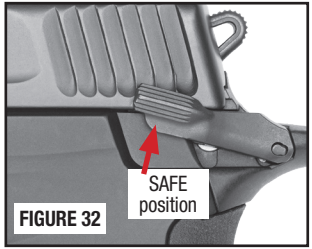

HANGFIRES AND MISFIRES



WARNING: ALWAYS KEEP THE MUZZLE POINTED IN A SAFE DIRECTION.



WARNING: WEAR EYE AND HEARING PROTECTION SPECIFIED FOR USE WITH FIREARMS WHEN FIRING AND CLEARING MISFIRES OR MISFEEDS.



WARNING: KEEP YOUR FACE A SAFE DISTANCE FROM THE EJECTION PORT WHEN CLEARING A CARTRIDGE. IF A CARTRIDGE IGNITES WHILE BEING CLEARED FROM THE FIREARM, DEATH OR SERIOUS INJURY MAY RESULT.



WARNING: IF YOUR FIREARM GIVES ANY INDICATION THAT IT IS NOT PERFORMING PROPERLY OR THE OPERATION OF YOUR FIREARM HAS CHANGED “THE WAY IT FEELS OR SOUNDS”, STOP FIRING. MAKE SURE THE FIREARM IS POINTED IN A SAFE DIRECTION, UNLOAD THE FIREARM AND HAVE IT INSPECTED AND TEST FIRED BY A GUNSMITH QUALIFIED TO PERFORM SERVICES ON SMITH & WESSON® FIREARMS.

NOTE: In the case of either a hangfire or misfire, keep the muzzle pointed in a safe direction and keep your finger off the trigger. Wait 60 seconds, then push the manual thumb safety fully up into the SAFE position (FIGURE 38).

- Press the magazine release and remove the magazine from the pistol (FIGURE 39).
- Clear the unfired cartridge from the chamber (FIGURE 40).

A HANGFIRE is described as a noticeable delay between the hammer impacting the firing pin and the actual discharge of the firearm. This “hangfire” is generally caused by defective or damaged ammunition.

- With the firearm pointed in a safe direction, the magazine should be removed and the firearm should be unloaded. The remainder of similar ammunition should be inspected to determine if it has been contaminated or damaged and dealt with accordingly.

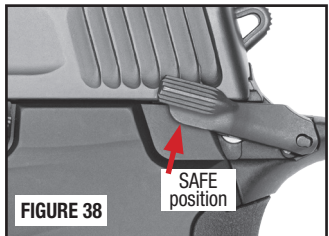

FIGURE 38



FIGURE 39

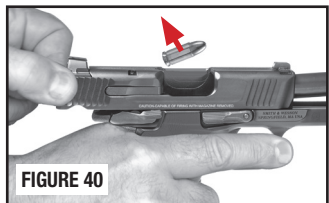

FIGURE 40

HANGFIRES AND MISFIRES CONTINUED

A **MISFIRE** is the failure of the chambered cartridge to fire at all after the trigger has been pulled. This is generally caused by defective or damaged ammunition or a dirty or fouled firearm.

- A light primer strike caused by a dirty or fouled firearm can lead to misfires. If a light indent on the primer of a misfire is noted, unload the firearm and clean it as instructed in the Cleaning and Maintenance section of this manual. If the cartridge does not go off, the “dud” cartridge needs to be removed from the firearm.

- Press the magazine release button and remove the magazine from the firearm (FIGURE 41).



- Pull the slide all the way back to eject the suspect cartridge from the pistol (FIGURE 42).

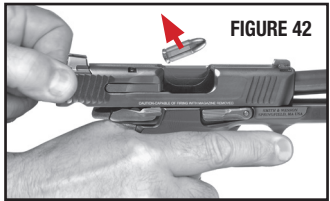

- Press up on the slide stop and let the slide move forward against the slide stop to lock the slide open (FIGURE 43).



- Move the manual safety lever up into the SAFE position (FIGURE 44).

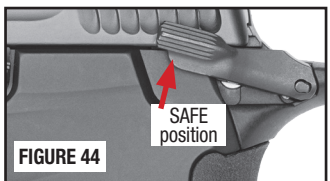

- Visually check the chamber (FIGURE 45a) to be certain that no cartridges are present in the pistol.

- Visually check the magazine well (FIGURE 45b) to be certain that no cartridges are present in the pistol.

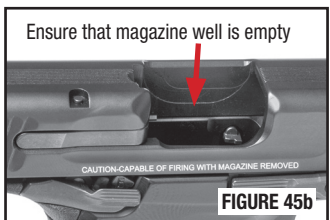
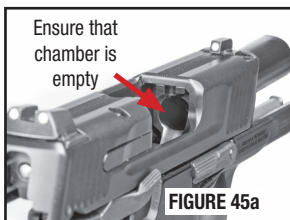

- The firearm should be inspected and cleaned before returning it to use.

HANGFIRES AND MISFIRES CONTINUED

- Any ammunition should be removed from the magazine (FIGURE 27) and inspected.
- Dispose of defective cartridge(s) in a method specifically approved for live round disposal.



WARNING: THE SMITH & WESSON CSX™ PISTOL CAN BE FIRED WHEN THE MAGAZINE IS REMOVED FROM THE PISTOL. KEEP YOUR FINGER OFF THE TRIGGER AND OUTSIDE OF THE TRIGGER GUARD UNTIL YOU HAVE MADE THE COMMITMENT TO FIRE.

CLEARING A MISFEED/JAM

NOTE: Any autoloading firearm may, on occasion, fail to feed a cartridge properly from the magazine and into the chamber. If this should occur:

WARNING: KEEP YOUR FACE A SAFE DISTANCE FROM THE EJECTION PORT WHEN CLEARING A MISFEED/JAMMED CARTRIDGE. A CARTRIDGE MAY IGNITE IF THE PRIMER OF THE CARTRIDGE IS STRUCK WITH SUFFICIENT FORCE. IF A CARTRIDGE IGNITES WHILE BEING CLEARED FROM THE FIREARM, DEATH OR SERIOUS INJURY MAY RESULT.

TO CLEAR A MISFEED (“JAM”)

- Make certain that the muzzle is pointed in a safe direction.
- Press the manual safety lever fully up into the SAFE position (FIGURE 47).
- Press the magazine release and remove the magazine (FIGURE 48).
- Pull the slide fully rearward and engage the slide stop (FIGURE 49) to lock the slide open.

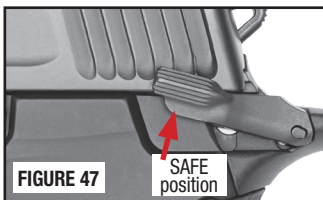

CLEARING A MISFEED/JAM CONTINUED

NOTE: Drawing the slide fully to the rear should allow clearance for the jammed cartridge to fall free and clear of the firearm (FIGURE 50).

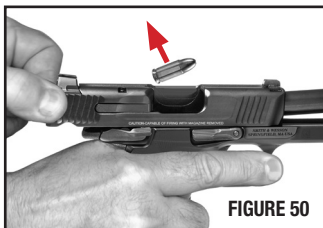

FIGURE 50

- It may be necessary to manually remove a jammed cartridge. When attempting to clear a jam manually, use only wood 'tools', such as a pointed dowel or a pencil, and use extreme care to avoid striking the primer of the cartridge.



FIGURE 51

- Visually check to make sure all cartridges have been removed from the firearm (FIGURES 51 and 52).

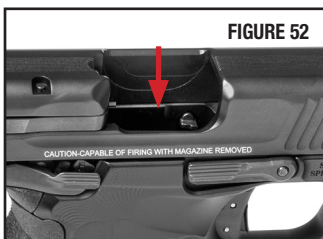

FIGURE 52

- Once the misfed cartridge is cleared, proceed to load the firearm as instructed in the Loading Section of this manual.

- Dispose of defective cartridge(s) in a method specifically approved for live round disposal.

DRY-FIRING THE SMITH & WESSON® CSX™ PISTOL



WARNING: ALWAYS KEEP THE MUZZLE OF YOUR FIREARM POINTED IN A SAFE DIRECTION.

- In order to become familiar with your Smith & Wesson® CSX™ pistol, you may want to dry-fire it. Going through the steps (with an unloaded Smith & Wesson CSX pistol) of cocking the hammer, aiming the pistol (in a safe direction) and then pulling the trigger is known as "dry-firing." Before dry-firing the pistol, with the pistol pointing in a safe direction be certain that both the chamber and magazine are empty. The Smith & Wesson CSX pistol can be dry-fired without damage to the firing pin or other parts. We recommend the use of "snap caps" when dry-firing.

MODES OF CARRY / HANDLING

SMITH & WESSON® CSX™ PISTOL



WARNING: ALWAYS KEEP THE MUZZLE OF YOUR FIREARM POINTED IN A SAFE DIRECTION.



WARNING: IF YOU ARE UNFAMILIAR WITH FIREARMS YOU SHOULD SEEK FORMAL TRAINING BEFORE USING YOUR SMITH & WESSON® CSX™ PISTOL.

- **FIRST MODE** - Magazine empty, chamber empty, manual thumb safety up in SAFE position, hammer down in AT REST position. No firing is possible without loading chamber and/or magazine.

This mode works best for storage, transporting, cleaning, maintenance and dry-fire practice.

- **SECOND MODE** - Loaded magazine in pistol, chamber empty, manual thumb safety down in FIRE position, hammer down in AT REST position. The pistol can be fired by drawing it from a holster or controlled storage, cycling the slide to chamber a round and cock the hammer, aiming and then pulling the trigger.

This mode works for carrying the pistol in a holster or controlled storage ready for use with minimal preparation.

- **THIRD MODE** - Loaded magazine in pistol, chamber loaded, manual thumb safety up in SAFE position, hammer in COCKED position. The pistol can be fired by drawing it from a holster or controlled storage, manual safety lever lowered to FIRE position, aiming and then pulling the trigger.

This mode works for carrying the pistol in a holster or controlled storage when immediate use is demanded with no advance warning.

NOTE: IF THE USER CHOOSES TO CARRY THE PISTOL IN THE CHAMBER LOADED AND HAMMER COCKED CONDITION, THE MANUAL SAFETY LEVER **MUST** BE UP IN THE SAFE POSITION EXCEPT WHEN IN THE PROCESS OF FIRING. NEVER CARRY THE PISTOL IN THE HALF-COCK OR AT-REST POSITION WITH A LOADED CHAMBER.

UNLOADING



WARNING: ALWAYS KEEP YOUR PISTOL POINTED IN A SAFE DIRECTION. ALWAYS KEEP YOUR FINGER OFF THE TRIGGER AND OUTSIDE THE TRIGGER GUARD WHEN UNLOADING.

- Point the muzzle in a safe direction. Make sure your finger is off the trigger and out of the trigger guard.
- Press the manual safety lever fully up into the SAFE position (FIGURE 53).
- Press the magazine release and remove the magazine (FIGURE 54).



WARNING: REMOVING THE MAGAZINE FROM THE SMITH & WESSON® CSX™ PISTOL DOES NOT UNLOAD THE CHAMBER. THE PISTOL CAN FIRE WITH THE MAGAZINE REMOVED, IF A ROUND HAS BEEN CHAMBERED AND THE SAFETY IS PLACED IN THE FIRE POSITION AND THE TRIGGER IS THEN PULLED TO THE REAR.

- Keep the muzzle still pointed in a safe direction, and keep your finger off the trigger and outside the trigger guard, grasp the serrated sides of the slide from the rear with the thumb and fingers and briskly draw the slide fully rearward in order to extract any cartridge from the barrel chamber and clear it from the pistol (FIGURE 55).

NOTE: Do not obstruct the ejection port because doing so can interfere with ejection of a cartridge (FIGURE 55).

- Lock the slide in the open position by allowing the slide to move slightly forward from the rearmost position while pressing upward on the slide stop (FIGURE 56).
- Visually check the barrel chamber to make sure that it is empty (FIG 57).

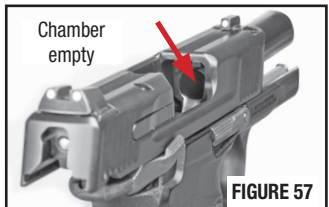
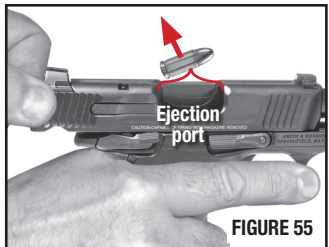

UNLOADING CONTINUED

- Look down through the magazine well. Verify that no ammunition remains in the pistol (FIGURE 58).
- Unload the magazine by holding it with the bullet end of the cartridge pointing away from you and pressing each cartridge forward and out of the magazine (FIGURE 59).

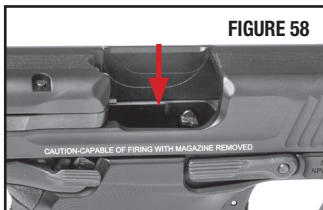

FIELD STRIPPING/DISASSEMBLY



WARNING: ALWAYS KEEP THE MUZZLE POINTED IN A SAFE DIRECTION.



WARNING: ALWAYS ENSURE THAT THE FIREARM IS UNLOADED BEFORE INSPECTING, DISASSEMBLING OR ASSEMBLING.



WARNING: ALWAYS FOLLOW THE FIELD STRIPPING INSTRUCTIONS EXACTLY. NEVER DO ANYTHING BEYOND WHAT YOU ARE SPECIFICALLY INSTRUCTED TO DO IN THIS MANUAL.

NEVER ALTER OR MODIFY THE PARTS IN YOUR PISTOL.



WARNING: WEAR SAFETY GLASSES EVERY TIME YOU ASSEMBLE OR DISASSEMBLE YOUR FIREARM.

- Keep the pistol pointed in a safe direction.
- Make sure your fingers are off the trigger and outside of the trigger guard.
- Press the manual safety lever fully up into the SAFE position (FIGURE 60).

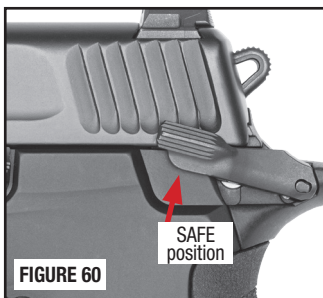

FIELD STRIPPING / DISASSEMBLY CONTINUED

- Press the magazine release, and remove the magazine from the pistol (FIGURE 61).



FIGURE 61

- With the barrel still pointing in a safe direction, and with your finger off the trigger and outside the trigger guard, grasp the serrated sides of the slide from the rear with the thumb and fingers (FIGURE 62) while holding the firearm in an upright position, briskly draw the slide fully rearward in order to extract any cartridge from the barrel chamber and clear it from the pistol.

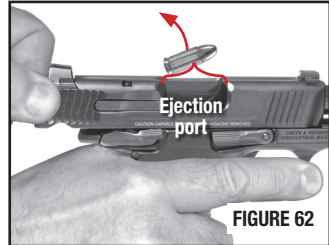

FIGURE 62

- Pull the slide fully to the rear, press upward on the slide stop while letting the slide move slightly forward thereby locking the slide open (FIGURE 63).

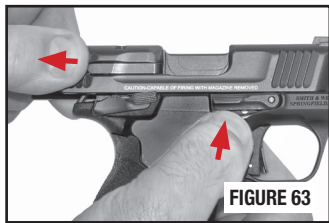

FIGURE 63

- Let the slide close and then draw it back about 1/4 inch and



FIGURE 64a

hold it there as shown with the takedown notch aligned with the "hump" on the takedown pin (FIGURES 64a and 64b).

- FIGURES 65 and 66 show the takedown pin details.

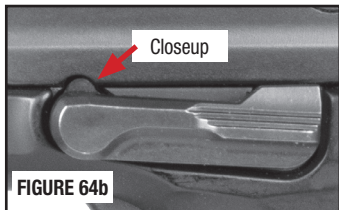

FIGURE 64b

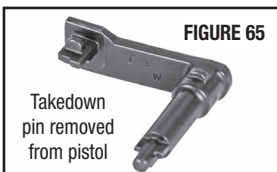

FIGURE 65

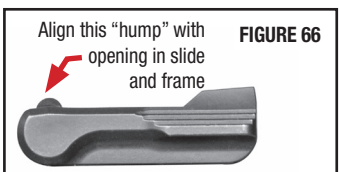

FIGURE 66

FIELD STRIPPING / DISASSEMBLY CONTINUED

- From the opposite side of the pistol, use a small drift or punch to press the takedown pin out of the pistol to the left (FIGURES 67 and 68).



- Grasp the slide from the top as shown and remove the slide from the frame by pulling it forward while being careful to retain the recoil spring and guide rod assembly (FIGURE 69).

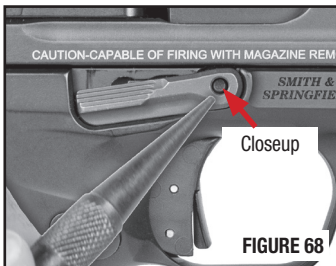

- Remove the recoil spring from the slide assembly (FIGURE 70).

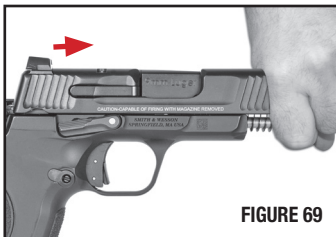

- Remove the barrel from the slide assembly (FIGURE 71).



WARNING: DO NOT ALTER, MODIFY OR REPLACE ANY OF THE PARTS IN YOUR PISTOL UNLESS THIS WORK IS PERFORMED BY A QUALIFIED GUNSMITH USING GENUINE SMITH & WESSON PARTS. IF YOU DO OTHERWISE, IMPROPER FUNCTIONING MAY OCCUR AND SERIOUS INJURY MAY RESULT.

WARNING: NEVER DISASSEMBLE YOUR HANDGUN BEYOND THE FIELD STRIPPING PROCESS OUTLINED IN THIS MANUAL. NEVER MANIPULATE ANY INTERNAL COMPONENTS BEYOND WHAT YOU ARE SPECIFICALLY INSTRUCTED TO DO IN THIS MANUAL AS IT MAY NEGATIVELY AFFECT THE RELIABILITY, FUNCTIONING AND SAFETY OF YOUR HANDGUN.

FIELD STRIPPING / DISASSEMBLY CONTINUED

- FIGURE 72 shows the parts that you will have after field stripping the Smith & Wesson® CSX™ pistol.

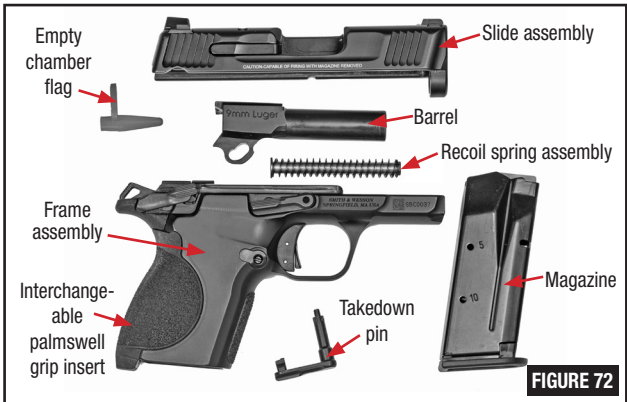

LUBRICATION

- There are eight (8) lubrication points where a single drop of firearm lubricant should be applied. This will ensure proper lubrication. Care should be taken not to over-lubricate. Excess lubricant can collect quantities of unburned powder and carbon residue, which could interfere with proper functioning of the pistol (FIGURES 73 and 74).

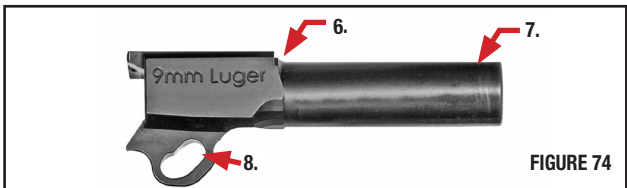
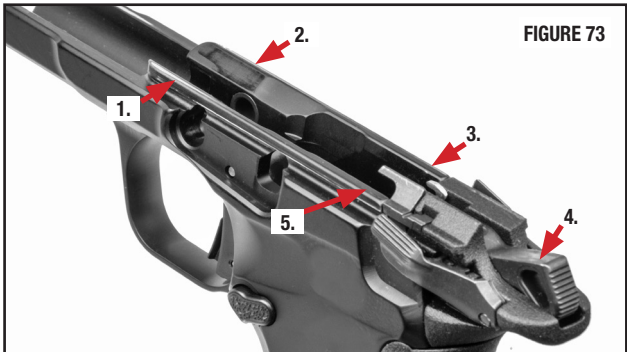

ASSEMBLY



WARNING: ALWAYS FOLLOW THE FIELD STRIPPING AND ASSEMBLY INSTRUCTIONS EXACTLY. NEVER DO ANYTHING BEYOND WHAT YOU ARE SPECIFICALLY INSTRUCTED TO DO IN THIS MANUAL. NEVER ALTER OR MODIFY THE PARTS IN YOUR PISTOL.



WARNING: WEAR SAFETY GLASSES EVERY TIME YOU ASSEMBLE OR DISASSEMBLE YOUR FIREARM.

- Replace the barrel in the slide so the muzzle is flush with the end of the slide and the barrel lug is turned up away from the ejection port (FIGURE 75).



- Insert the protruding button (smaller end FIGURE 76) of the recoil spring guide assembly into the slide guide housing as shown (FIGURE 77). The rear of the spring assembly goes against the barrel lug.

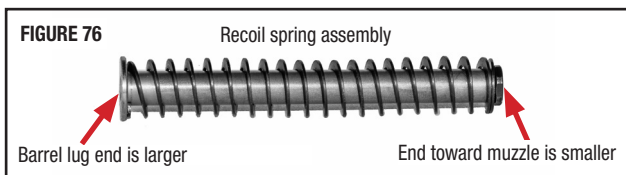

- Make sure the recoil spring assembly is properly centered as shown (FIGURES 78 and 79).

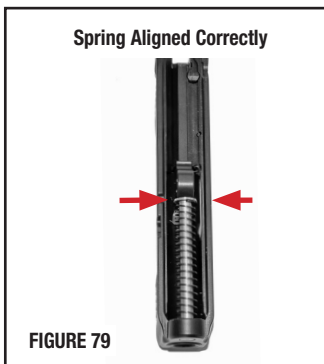

ASSEMBLY CONTINUED

- Holding the slide with barrel and recoil spring firmly in one hand, push the slide onto the frame rails (FIGURE 80).
- Grasp the slide with the takedown notch aligned as shown (FIGURE 81).



- While holding the takedown notch aligned, push the takedown pin into place until it “clicks” (FIGURE 82).



- Allow the slide to move fully forward to the closed position.
- Place the manual thumb safety down into the FIRE position (FIGURE 83).



ASSEMBLY CONTINUED

- With your thumb firmly on the hammer, pull the trigger to the rear and hold it while lowering the hammer (FIGURE 84) to the forward “at rest” position and then release the trigger.

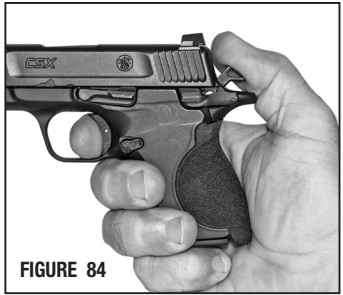

- Replace the empty magazine into the pistol.

- Check for proper functioning by drawing the slide fully rearward - at which point the slide stop should move up and hold the slide open.

INTERCHANGEABLE PALMSWELL GRIP INSERT



WARNING: ALWAYS KEEP THE MUZZLE POINTED IN A SAFE DIRECTION.



WARNING: MAKE CERTAIN THAT THE FIREARM IS UNLOADED BEFORE CHANGING THE INTERCHANGEABLE PALMSWELL GRIP INSERTS.

- Locate the grip tool that shipped in the box with the pistol (FIGURE 85).

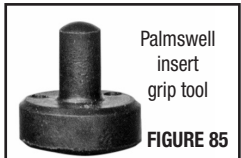

- Follow the decocking procedure to place the hammer down in the AT REST position before proceeding.



- Insert the grip tool into the hole at the bottom of the grip and press the lock down while pushing back at the same time to release the grip insert from the frame (FIGURE 86 and 87).



INTERCHANGEABLE PALMSWELL GRIP INSERT CONT'D

- Remove the interchangeable palmswell grip insert from the frame by tipping it away from the frame (FIGURE 88).

NOTE: When installing any palmswell grip insert, it may be necessary to press the detent/plunger slightly with a blunt tool to allow the grip insert to move into place (FIGURE 89).

CAUTION: Some solvents may cause damage to the interchangeable palmswell insert material. See the “Cleaning and Maintenance” section of this manual for more information.

NOTE: The pistol comes with interchangeable palmswell grip inserts in Compact and Large sizes (FIGURE 90).

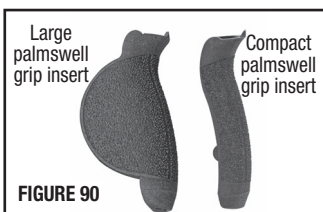
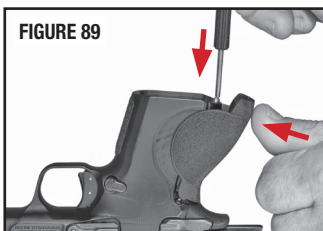
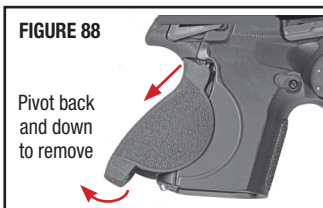

REVERSIBLE MAGAZINE RELEASE

NOTE: The Smith & Wesson® CSX™ pistol comes with (2) magazine release buttons that allow either right or left side operation. To reverse the magazine release operation, follow these instructions:



WARNING: ENSURE THAT YOUR FIREARM IS UNLOADED BEFORE BEGINNING TO DISASSEMBLE IT.



WARNING: WEAR SAFETY GLASSES EVERY TIME YOU DISASSEMBLE OR ASSEMBLE YOUR FIREARM AND WHEN YOU CONDUCT CLEANING, MAINTENANCE OR ADJUSTMENT.

- FIGURE 91 shows the magazine release plunger's location with a small screwdriver engaged in the slot.
- FIGURES 92 and 93 on the next page show the magazine release removed from the pistol for clarity. The catches are contoured to match the shape of the frame when installed.

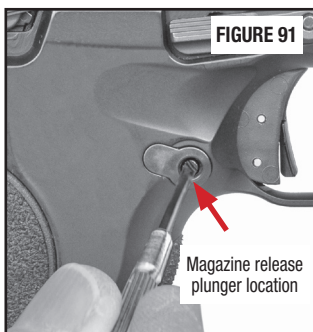

REVERSIBLE MAGAZINE RELEASE CONTINUED

- Press the magazine release and remove the magazine from the pistol.
- When installing the magazine release, the textured side (FIGURE 92b) should be on the side of the pistol that you want to push on to release the magazine from the pistol.
- When switching sides of operation of the magazine release, the textured side must be inserted into the frame opening first.

NOTE: The plunger/spring of the magazine release only needs to be pushed in slightly (using a small screwdriver) in order to turn it - for either unlocking it - or locking it back into the frame.

- Follow the guidelines in (FIGURES 94a and 94b) to remove and install the magazine release. $\frac{1}{4}$ turn is all that is required, in either direction, to unlock and lock the part into the frame.
- Once the magazine release is installed, insert an unloaded magazine into the pistol and check the magazine release for proper function.

NOTE: If the magazine release plunger is pressed too hard or turned too far, it may become disassembled. Reassemble the parts before inserting the magazine release back into the pistol (FIGURE 95). A pair of needle nose pliers may help with this task.



FIGURE 92



FIGURE 93

Right Side Push Magazine Release

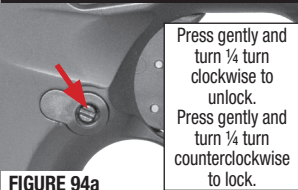

FIGURE 94a

Left Side Push Magazine Release

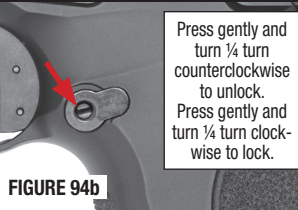

FIGURE 94b

1



2



3

Align parts and compress plunger on spring until slotted plunger end enters hole at right.



4

FIGURE 95



MAGAZINE



WARNING: WEAR SAFETY GLASSES EVERY TIME YOU DISASSEMBLE OR ASSEMBLE YOUR MAGAZINE.



WARNING: THE MAGAZINE SPRING IS UNDER PRESSURE IN THE ASSEMBLED MAGAZINE. WHEN DISASSEMBLING OR ASSEMBLING THE MAGAZINE, CONTROL THE SPRING AND OTHER PARTS OF THE MAGAZINE SO THEY DO NOT FLY OUT AND CAUSE INJURY.

- There are 10 and 12 round magazines available that fit the Smith & Wesson® CSX™ pistol. (FIGURE 96).

MAGAZINE DISASSEMBLY

- Using a small tool like a drift or punch, depress floor plate catch through the hole in the floor plate (FIGURE 97).

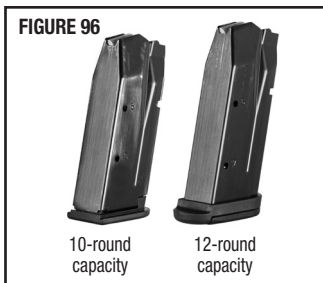

- Slide floor plate forward off of the tube while holding floor plate catch in the tube (FIGURES 98 and 99) against spring pressure.



- Remove floor plate catch and spring and follower out through bottom of tube (FIGURE 100).



- Turn the tube right side up and remove spring and follower through bottom of the tube.

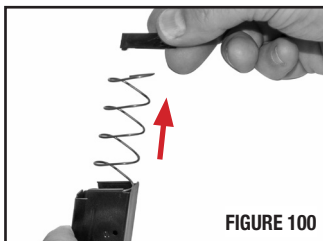
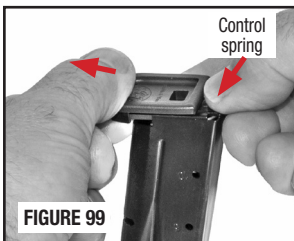

MAGAZINE CONTINUED

- FIGURES 101a and 101b show the parts of the magazines.

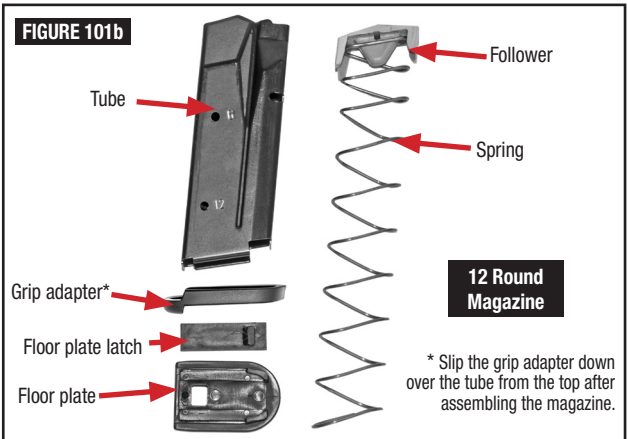
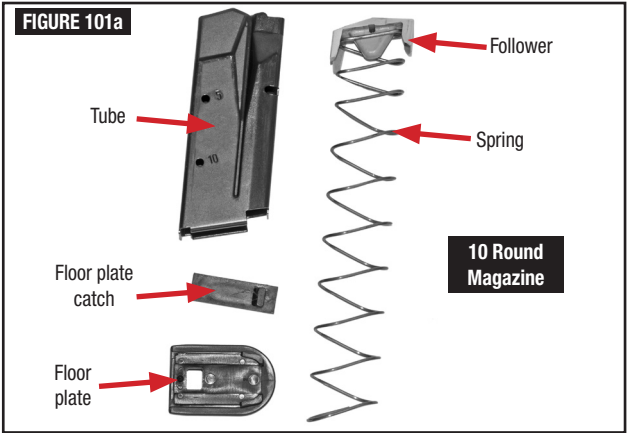

MAGAZINE ASSEMBLY

- Install magazine spring and follower and floor plate catch front to back into the tube in exactly the same orientation as they were in when they were first removed during disassembly.
- Holding floor plate catch in the tube, slide the floor plate onto the tube's base so that the projection of the floor plate catch engages the floor plate. Verify that the floor plate is locked in place by exerting some pressure on the floor plate - as if trying to slide it off the tube.
- After starting the floor plate onto the lips of the magazine tube, it may be necessary to depress the floor plate catch slightly with a dull tool to allow the floor plate to pass over the raised area (FIGURE 102).

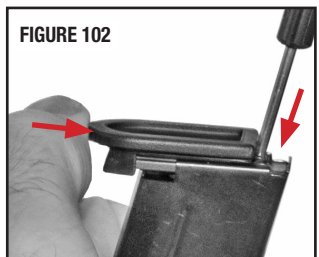

SIGHT ADJUSTMENT



WARNING: ENSURE YOUR FIREARM IS UNLOADED BEFORE ADJUSTING YOUR SIGHTS. AT ALL TIMES FOLLOW THE BASIC FIREARMS SAFETY RULES IN THE SECTION ENTITLED “YOUR SAFETY RESPONSIBILITIES”.

- Loosen the rear sight set screw (FIGURE 103) prior to moving the rear sight. Tighten the set screw after the sight has been adjusted to the desired position.
- The rear sight is adjustable for windage only. To adjust, move the rear sight in the direction you wish the group to move on the target. For example, if the group should move to the right, move the rear sight to the right. Use a brass or plastic drift or punch to prevent marring the rear sight.

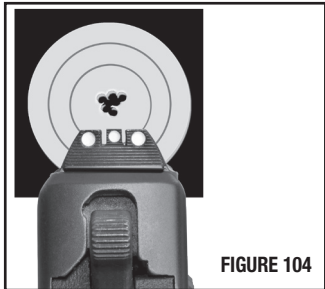
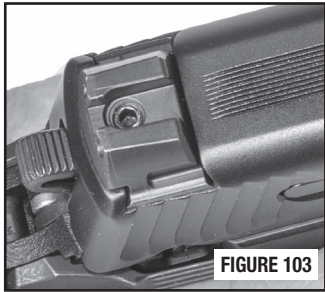

CLEANING AND MAINTENANCE



WARNING: ENSURE THAT YOUR FIREARM IS UNLOADED BEFORE BEGINNING TO CLEAN IT. (SEE “INSPECTING YOUR FIREARM” SECTION). ALWAYS FOLLOW THE RULES OF SAFE GUN HANDLING.



WARNING: WEAR SAFETY GLASSES EVERY TIME YOU ASSEMBLE OR DISASSEMBLE YOUR FIREARM AND ATTEMPT CLEANING OR MAINTENANCE.

- Before using your firearm for the first time, it should be cleaned.
- Your firearm was treated at the factory with either a preservative or oil to protect it against corrosion during shipping and storage.
- Preservative and oil should be wiped from the bore, chamber and exposed areas using a clean swab or patch before using the firearm.

CAUTION: Never disassemble your firearm beyond the instructions in the Field Stripping and Inspection sections of this manual.

CLEANING AND MAINTENANCE CONTINUED

- Purchase cleaning supplies from your firearms dealer that are specifically designated for your type and caliber of firearm. Many suppliers offer these in kit form for your convenience.
- Follow the instructions provided with your cleaning supplies.

NOTE: A basic firearm cleaning kit should include: a brass bore brush and a cleaning jag of appropriate size for the bore being cleaned, high-quality gun cleaning solvent and gun oil/lubricant, cotton cleaning patches and a cleaning rod that is long enough to push the brush and jag completely through the barrel.

- Remove excessive firing residue from the bore and chamber using a properly fitted brass brush dipped in gun cleaning solvent. Finish the bore cleaning process by running a dry cotton cloth patch through the bore to remove residue and solvent.
- Clean the exterior of the firearm using a non-abrasive cleaning cloth.
- After cleaning, lightly coat the metal parts, internal and external with a high quality gun oil. Refer to the “Lubrication” section in this manual for instructions on lubricating the firearm.
- Whenever your firearm has been exposed to sand, dust, extreme humidity, water or other adverse conditions, it must be cleaned and lubricated.



WARNING: ALWAYS HAVE ADEQUATE VENTILATION. CLEANING FIREARMS IN POORLY VENTILATED AREAS, DISCHARGING FIREARMS, OR HANDLING AMMUNITION MAY RESULT IN EXPOSURE TO LEAD AND OTHER SUBSTANCES KNOWN TO CAUSE BIRTH DEFECTS, REPRODUCTIVE HARM, AND OTHER SERIOUS PHYSICAL INJURY. WASH HANDS THOROUGHLY AFTER EXPOSURE.

CAUTION: Always follow the instructions provided with your gun cleaner and gun lubricant.

CAUTION: Some cleaners can cause damage to your firearms. You should avoid prolonged solvent immersion and prolonged ultrasonic cleaning of your firearm. Choice of solvent should be restricted to those products specifically developed for firearms maintenance. Damage to a firearm's finish may occur if these cautions are ignored. Ammoniated solvents or other strong alkaline solvents, should not be used on any Smith & Wesson firearm.

- Cleaning is essential to ensure the proper functioning of your firearm.

CLEANING AND MAINTENANCE CONTINUED

- Your firearm is a precision instrument. To ensure reliable function it is necessary to follow a routine maintenance procedure. After firing your firearm, be sure to unload it following the procedure outlined in the section entitled “Inspecting Your Firearm” before performing any cleaning or maintenance procedure.
- Remove any gun cleaning solution, oil and fingerprints from the outside surfaces of the firearm. (Finger moisture, if left, could start a corrosion process).



WARNING: NEVER MANIPULATE, ADJUST OR CHANGE ANY OF THE INTERNAL COMPONENTS OF YOUR FIREARM UNLESS SPECIFICALLY DIRECTED TO DO SO IN THIS MANUAL. IMPROPER MANIPULATION OF ANY INTERNAL COMPONENT MAY AFFECT THE SAFETY AND RELIABILITY OF YOUR FIREARM AND MAY CAUSE SERIOUS INJURY OR DEATH.



WARNING: ANY MAINTENANCE OR SERVICE NOT SPECIFIED IN THIS MANUAL MUST BE PERFORMED BY A QUALIFIED GUNSMITH USING GENUINE SMITH & WESSON® PARTS. IF YOU DO OTHERWISE, IMPROPER FUNCTIONING OF YOUR FIREARM MAY OCCUR AND SERIOUS INJURY OR DEATH MAY RESULT.

- If your firearm will be used in a cold climate, be sure to use an oil of an appropriate weight so that it will not congeal in cold temperatures, causing the interaction of important parts to be slowed or halted.

MAINTENANCE BEFORE STORAGE

- When storing, do not encase your firearm in anything that will attract or hold moisture, for example, leather or heavy cloth. Also, do not store guns with a plug inserted in the barrel for this can be a contributing factor to moisture accumulation. If your firearm is to be stored for an extended period, the bore, chambers and internal working mechanism should be oiled with a high quality lubricating oil or preservative intended for firearms. The external working mechanisms and barrel should be coated with an anti-rust oil. Before using your firearm again, be sure to clean it. Every time you clean your firearm, check it for signs of wear. If wear is noted, do not use the firearm. Return it to Smith & Wesson for service or have it checked by a qualified gunsmith.

LIMITED WARRANTY

For Owners Within The United States.

This warranty is granted by Smith & Wesson Inc. This warranty is effective from the date of purchase and applies to the original owner of any firearm. With respect to such firearms, this warranty supersedes any and all other warranties.

Smith & Wesson® firearms are warranted to be free from defects in material and workmanship. Any such defects of which Smith & Wesson® receives written notice within one year from the date of purchase by the original owner, will be remedied by Smith & Wesson without charge within a reasonable time after such notification and delivery of the firearm as provided below.

In the event of an emergency (repairs needed by law enforcement, an upcoming match or hunting trip), call 1-800-331-0852, ext. 4125 and ask for 911 Priority Repair Service. This allows you to speak with a Smith & Wesson® representative. Immediately upon receipt, your firearm will be assigned to a gunsmith. After the work is completed, we will return your Smith & Wesson firearm via overnight delivery.

To submit a warranty claim please see the “Contact and Shipping Information” below for details. In addition to the requested information, please include a copy of the bill of sale in the owner’s name, or a copy of the ATF Form 4473 indicating date of purchase. It is always important that the owner comply with all applicable federal, state and local laws and regulations.

Warranty claims should state the model and serial number of the firearm concerned and the description of the difficulty experienced. It is recommended that shipments be insured by the owner, since Smith & Wesson® will accept no responsibility for loss or damage in transit. Transportation and insurance charges for return to owner will be paid by Smith & Wesson® if the claim is covered by the warranty.

UNDER NO CIRCUMSTANCES SHALL SMITH & WESSON BE RESPONSIBLE FOR INCIDENTAL OR CONSEQUENTIAL DAMAGES WITH RESPECT TO ECONOMIC LOSS, INJURY, DEATH OR PROPERTY DAMAGE, WHETHER AS A RESULT OF BREACH OF THIS WARRANTY, NEGLIGENCE OR OTHERWISE.

Some states do not allow the exclusion or limitation of incidental or consequential damages, so the above limitation or exclusion may not apply to you.

LIMITED WARRANTY CONTINUED

Smith & Wesson® will not be responsible for:

- Defects or malfunctions resulting from careless handling, unauthorized adjustments or modifications made or attempted by anyone other than a qualified gunsmith following Smith & Wesson authorized procedures, or failure to follow the disassembly instructions in the Smith & Wesson manual.
- Use of defective or improper ammunition, corrosion, neglect, abuse, ordinary wear and tear, or unreasonable use.
- Criminal misuse, negligence or use under the influence of drugs or alcohol.

Smith & Wesson's Lifetime Service Policy begins after the warranty period has expired. Smith & Wesson® will repair, without charge, for the lifetime of the original owner, any Smith & Wesson® handgun purchased on or after February 1, 1989, and any M&P® series rifle that is found to have a defect in material or workmanship. Eligibility for this Lifetime Service Policy requires returning the printed Product Registration Card within 30 days of purchase or registering the purchase online within 30 days of purchase at www.smith-wesson.com. The Lifetime Service Policy covers functional defects; it does not include the firearm's finish, grips, magazines or sights. The Lifetime Service Policy is in addition to and not an extension of the Smith & Wesson® Warranty.

This warranty gives you specific legal rights. You may also have other rights that vary from state to state.

NOTE: All liability is excluded in the event that the instructions in the Smith & Wesson® Safety & Instruction manual are not observed.

CONTACT AND SHIPPING INFORMATION

For Owners Within The United States.

NOTE: A Return Merchandise Authorization (**RMA**) is the first step in the process of returning a product in order to receive a repair, replacement or refund. Please contact Smith & Wesson's Customer Service Dept. (via e-mail: qa@smith-wesson.com or by phone at 1-800-331-0852 ext. 4125) to obtain authorization to return your firearm so we can process it quickly and efficiently. The **RMA** number that is supplied by Smith & Wesson® must be displayed on the outside of the returned product's packaging; returns without an **RMA** number will be routed differently which will result in delayed processing.

The Return Merchandise Authorization (**RMA**) process allows Smith & Wesson® an opportunity to try to diagnose and correct a customer's concerns with the product (such as ammunition problems) before it is returned. Accordingly, please contact us before returning your Smith & Wesson firearm.

CONTACT CUSTOMER SERVICE

Tel: 1-800-331-0852 ext. 4125

E-mail: qa@smith-wesson.com

RETURNS - FOR SERVICE ALL SMITH & WESSON FIREARMS

Smith & Wesson
2100 Roosevelt Avenue
Springfield, MA 01104

Should your Smith & Wesson® firearm require service, it should be returned to the Smith & Wesson factory.

- Call or e-mail the Customer Service Dept. for authorization and shipping instructions.
- Ensure that the firearm is unloaded.
- Do not attempt to ship a firearm via US Postal Service; only federally licensed dealers may ship a firearm by US Postal Service.
- **DO NOT SHIP ANY AMMUNITION.**
- Enclose a letter which includes your full name and address (no P.O. Boxes, please), daytime telephone number, e-mail address, the serial number of the firearm, and details of the problem experienced (stating the brand and type of ammunition used when the problem occurred) or work desired.

CONTACT AND SHIPPING CONTINUED

- Record the serial number before shipping, in case you wish to check on the repair status of your firearm.
- Please remove all custom parts and accessories, such as stocks, special sights and scopes, or holsters from your firearm before returning.
- Place the firearm in its original case or in a similarly secure container and pack it securely.
- The package must NOT bear any markings which indicate the identity of the contents.
- It is most important that you comply with federal, state, and local laws and regulations. The following guidelines are meant to help, but you must seek assistance from the appropriate authorities if necessary.
- If your firearm must be replaced, it may be necessary to ship the replacement to a dealer rather than directly to you. You will be requested to furnish a signed FFL (Federal Firearms License) from your dealer in such an instance.
- Warranty repair work will begin upon receipt and examination of the firearm. In the case of repairs or work not covered by the warranty, a quotation covering the cost of the work plus round trip transportation charges will be sent to you. Repairs or modification will be scheduled upon receipt of payment.
- A parts list can be obtained by contacting the Smith & Wesson® Customer Service Department.



WARNING: YOU MAY PURCHASE ACCESSORIES FOR YOUR SMITH & WESSON® FIREARM. YOU MUST HAVE SOME OF THESE PARTS INSTALLED BY A GUNSMITH QUALIFIED TO PERFORM SERVICE ON SMITH & WESSON FIREARMS. YOU MUST NEVER ATTEMPT TO MODIFY YOUR FIREARM OR INSTALL REPLACEMENT PARTS IN YOUR FIREARM. ALWAYS USE A QUALIFIED SMITH & WESSON GUNSMITH EVEN IF THE REPAIR SEEMS SIMPLE.

BATTERY WARNINGS



WARNING: IF A BATTERY OPERATED ACCESSORY OR ATTACHMENT (I.E. LASER, OPTICAL SIGHT OR FLASHLIGHT, ETC.) IS SUPPLIED OR USED WITH THIS FIREARM, THE FOLLOWING WARNINGS AND INSTRUCTIONS MUST BE ADHERED TO.



WARNING: KEEP BATTERIES AWAY FROM CHILDREN. THERE IS A CHEMICAL BURN HAZARD ASSOCIATED WITH BATTERIES.



WARNING: IF A NEW OR USED LITHIUM BUTTON/COIN CELL BATTERY IS SWALLOWED OR ENTERS THE BODY, IT CAN CAUSE SEVERE INTERNAL BURNS AND CAN LEAD TO DEATH IN AS LITTLE AS 2 HOURS. ALWAYS COMPLETELY SECURE THE BATTERY COMPARTMENT. IF THE BATTERY COMPARTMENT DOES NOT CLOSE SECURELY, STOP USING THE PRODUCT, REMOVE THE BATTERIES, AND KEEP IT AWAY FROM CHILDREN. IF YOU THINK BATTERIES MIGHT HAVE BEEN SWALLOWED OR PLACED INSIDE ANY PART OF THE BODY, SEEK IMMEDIATE MEDICAL ATTENTION.

- When used correctly, batteries provide a safe and dependable source of portable power. However, misuse or abuse may result in leakage, fire, or explosion.
- Batteries can explode or leak and cause burns if installed backwards, disassembled, charged, or exposed to water, fire or high temperature.
- Always take care to install your batteries correctly observing the “+” and “-” marks on the battery and the device.
- Always replace the whole set of batteries at one time, taking care not to mix old and new batteries, or batteries of different types.
- Store unused batteries in their original packaging and away from metal objects that may short-circuit them.
- Remove discharged batteries from equipment promptly to avoid possible damage from leakage.
- Never dispose of batteries in fire. Failure to observe this precaution may result in an explosion.
- The batteries are supplied in a charged state and are not designed for recharging. Recharging may cause leakage, fire, or explosion.
- The batteries should be disposed of properly, including keeping them away from children.
- Dispose of used batteries immediately. Even used batteries may cause injury.

This handgun is not equipped with a device that fully blocks use by unauthorized users. More than 200,000 firearms like this one are stolen from their owners every year in the United States. In addition, there are more than a thousand suicides each year by younger children and teenagers who get access to firearms. Hundreds more die from accidental discharge. It is likely that many more children sustain serious wounds or inflict such wounds accidentally on others. In order to limit the chance of such misuse, it is imperative that you keep this firearm locked in a secure place and take other steps necessary to limit the possibility of theft or accident. Failure to take reasonable preventative steps may result in innocent lives being lost, and in some circumstances may result in your liability for these deaths.

The certification below is required only for handguns sold in the United States with a barrel length shorter than 3”.

Smith & Wesson Inc. hereby certifies average accuracy test results for all new handguns with a barrel shorter than 3” as follows:

**7 yards
1.7”**

**14 yards
3.9”**

**21 yards
6.3”**

This certification is based on tests conducted by Smith & Wesson Inc. using a fixed handgun rest and firing ammunition manufactured by a member of the Shooting Arms and Ammunition Manufacturers Institute (SAAMI) as defined in ANSI/SAAMI Z299.3-1993.

This certification represents actual tests based on several handguns, selected at random. Your particular handgun may have accuracy better than the results stated in this certification.

CUSTOM SERVICE

- We understand that Smith & Wesson gun owners may want to enhance their guns with custom gunsmithing, refinishing or accessories. Our gunsmiths offer specialized services and exclusive products to enhance your shooting experience.
- Accessories for your Smith & Wesson® firearm are available from your local Smith & Wesson Stocking Dealer, or directly from Smith & Wesson.
- Contact the Customer Service Department at 1-800-331-0852, ext. 4125 for information about these services.

When ordering directly from the factory, please provide the following information:

- Model Number
- Dash Number (if applicable)
- Serial Number
- Approximate date of purchase
- Your Complete Return Address
- VISA/Discover/MasterCard Number and Expiration Date
- For Foreign Orders Only, Fax Number or E-mail Address

PATENT INFORMATION

- This product may be covered by one or more patents.
Visit www.smith-wesson.com for virtual patent information.

INTERNATIONAL WARRANTY CENTERS

For Owners Outside The United States.

NOTE: Addresses and contact information for International Warranty Centers is available on the Smith & Wesson® website at www.smith-wesson.com or by calling Customer Service toll-free at 1-800-331-0852 ext 4125.



Smith & Wesson®

EMPOWERING AMERICANS™



3014738

Smith & Wesson®

2100 Roosevelt Avenue • Springfield, MA 01104

www.smith-wesson.com

p/n 3014738

REV: SMITH & WESSON_CSX_PISTOL_102621