

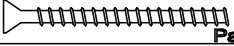



ESM 218

PARA PEDIDOS DE ASSISTÊNCIA TÉCNICA, INFORMAR O CÓDIGO E A COR DA PEÇA

LISTA DE PEÇAS / LISTA DE PIEZAS/ LIST OF PIECES

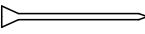
PEÇAS / PIEZAS / PIECES	Dimensões / Dimensiones / Dimensions	Código/code	QTD.
Base/teto/ Base sup/ inf/ Upper/bottom base	① 600 x 295 x 15	60382	02
Lat dir/esq/ Lat derecha/izquierda/ Right/left side	② 340 x 295 x 15	49692	08
Prateleira / Repisa / Shelf	③ 600 x 295 x 15	60383	03
Pilastra / Pilastra / Pilaster	④ 340 X 100 X 15	60381	04

FERRAGENS / Herrajes / Hardware	DIMENSÕES / Dimensiones / Dimensions	QTD.
①  Parafuso estrutural	5 x 50	48
②  Sapata deslizador	—	10
③  Pregos	10 x 10	10
④  Chave Z allen	—	01

MONTAGEM / MONTAJE / ASSEMBLY

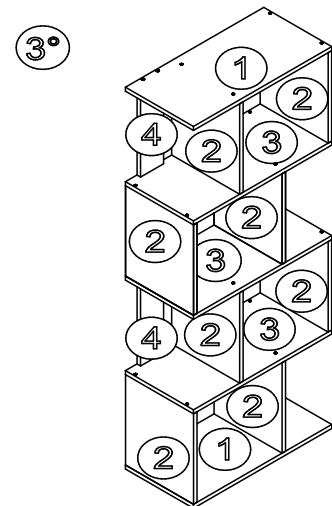
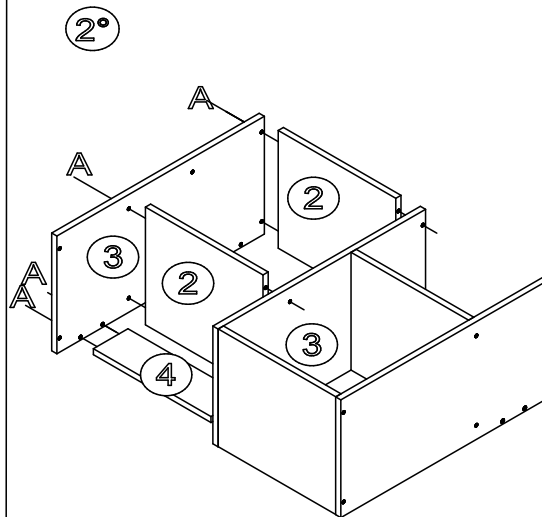
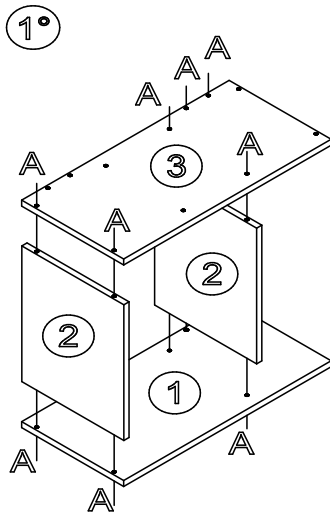

Opção de montagem / Opción de montaje / Mounting option

