

PRINT PALS

Templates

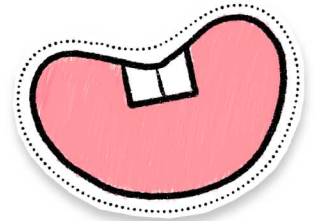

Created by

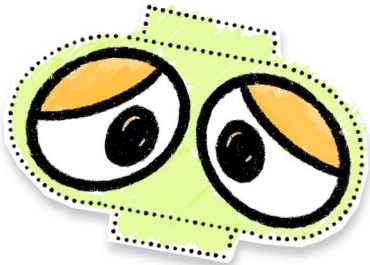
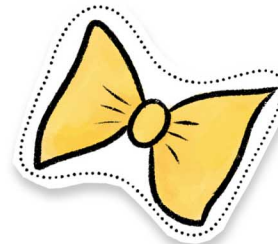

Moving-Mouth Puppet Head

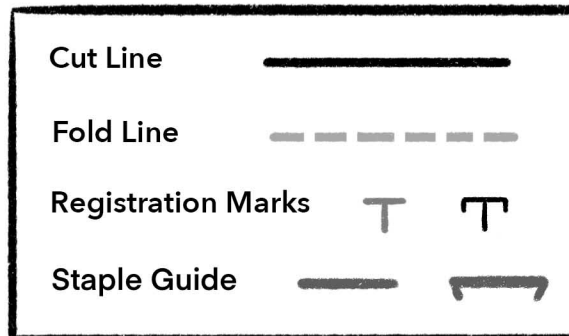
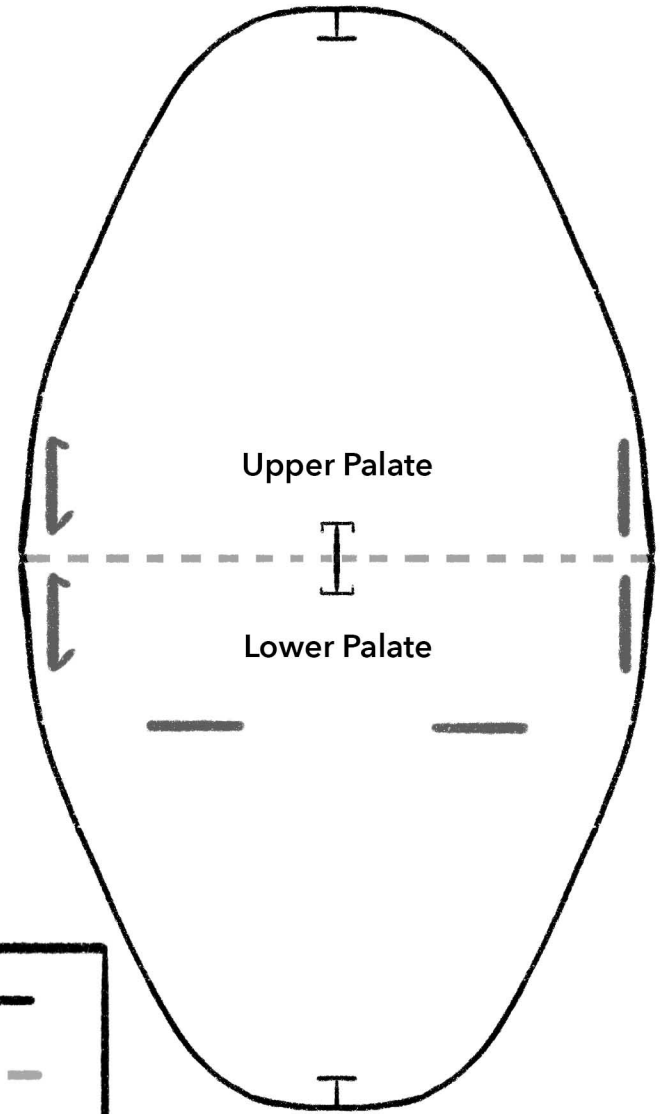
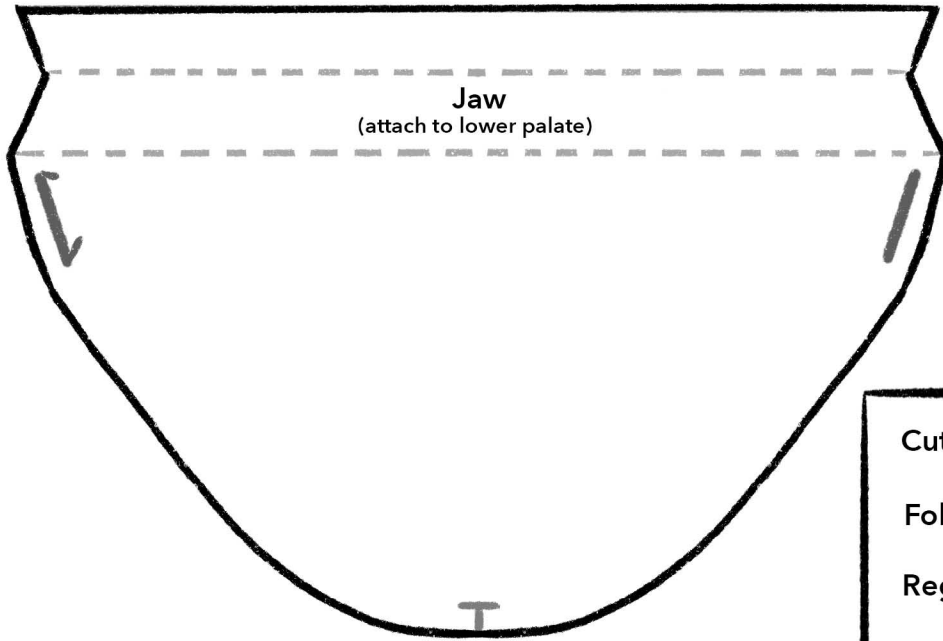
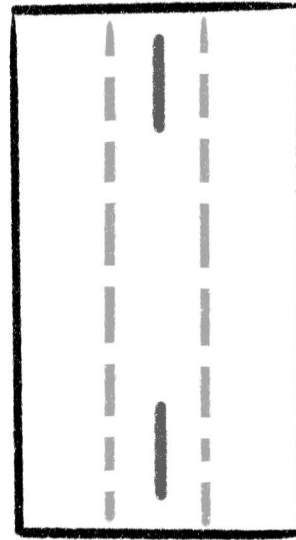
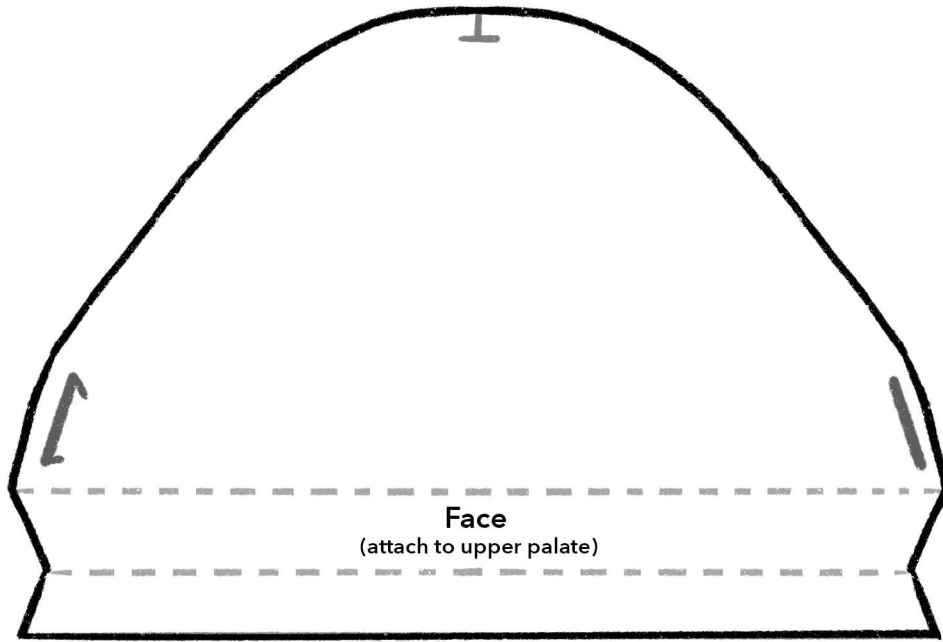

Glove Puppet Head

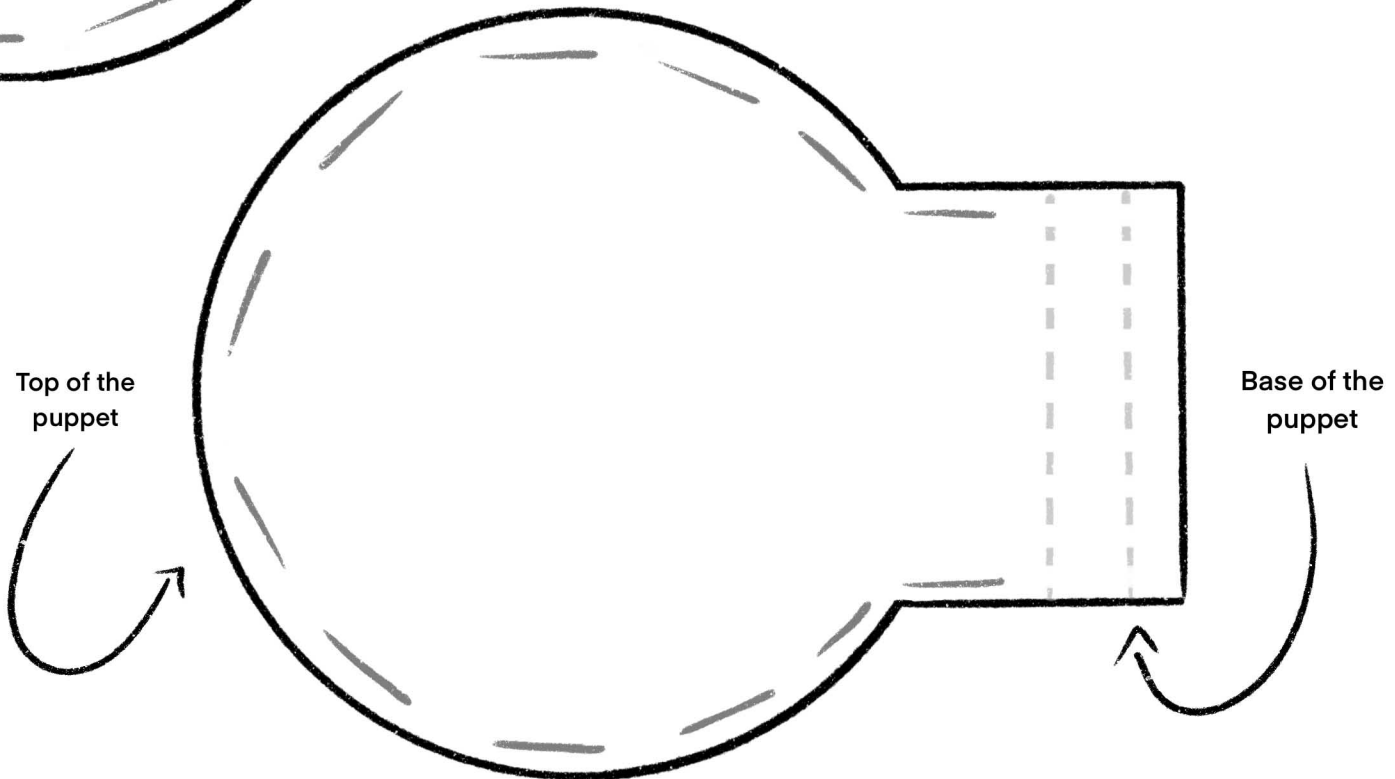
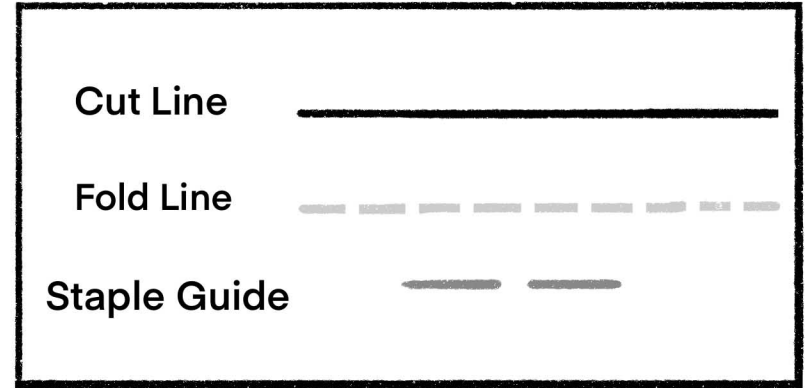
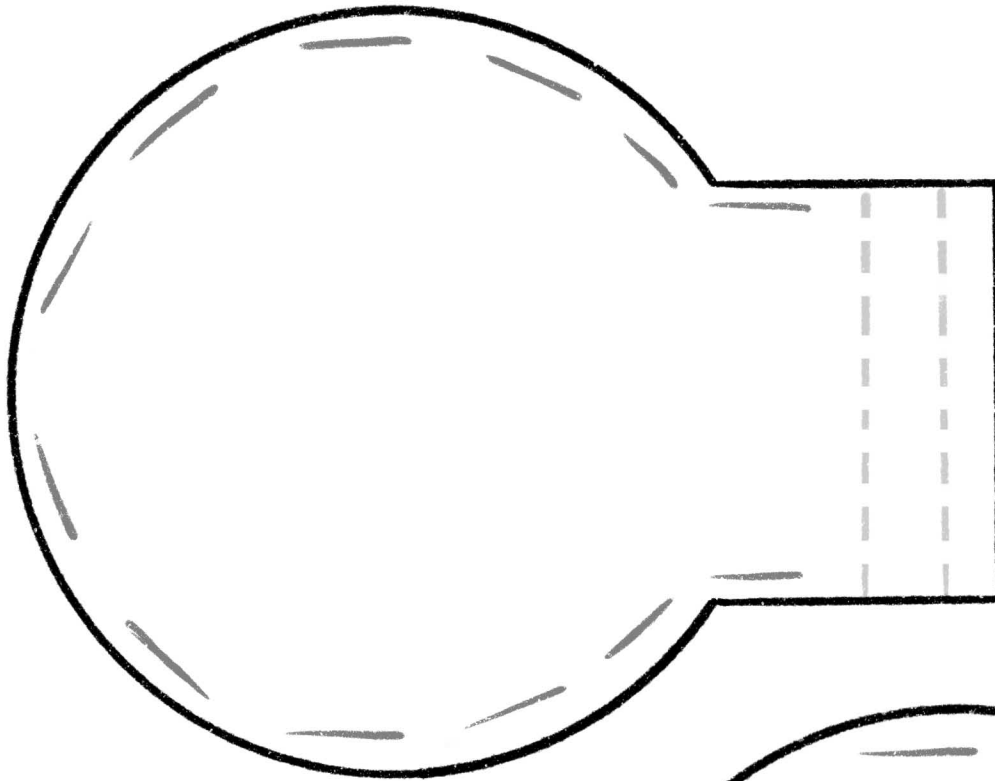

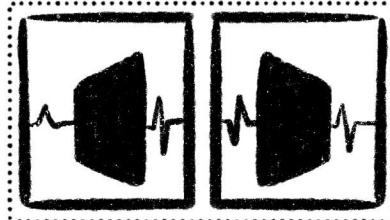
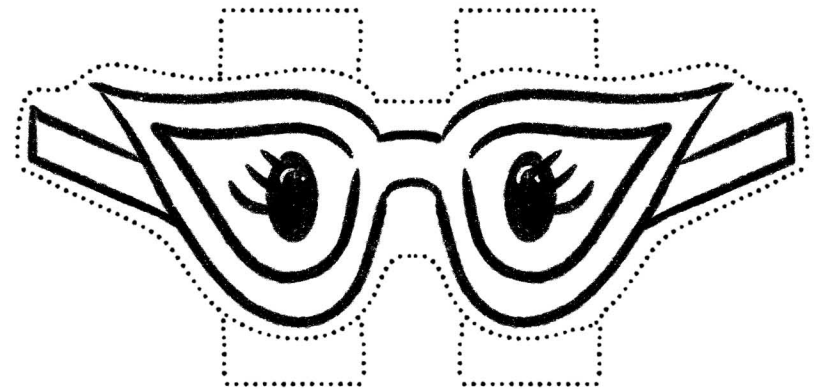
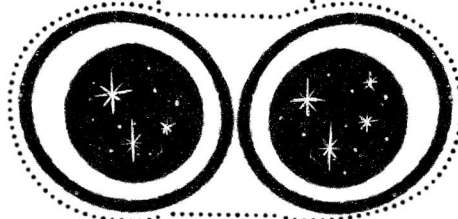
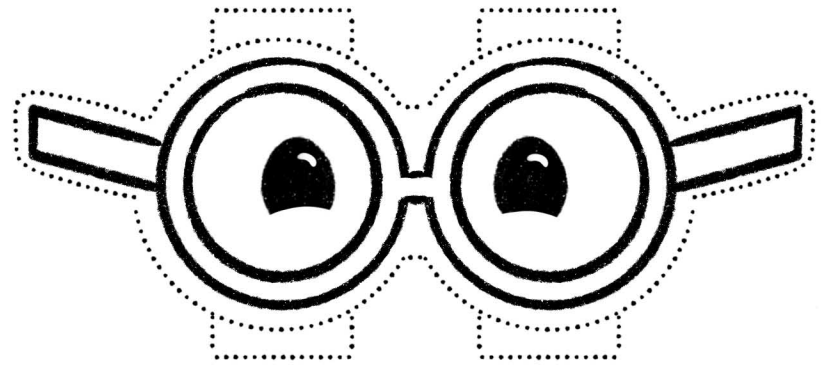
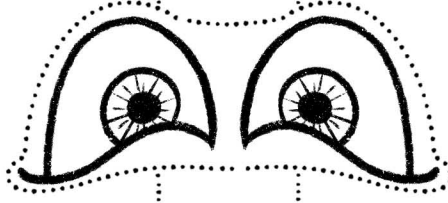
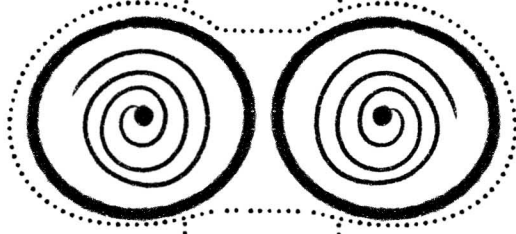
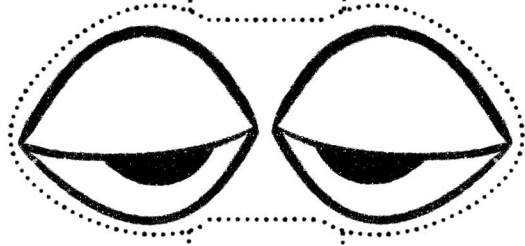
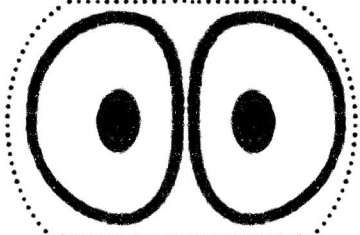
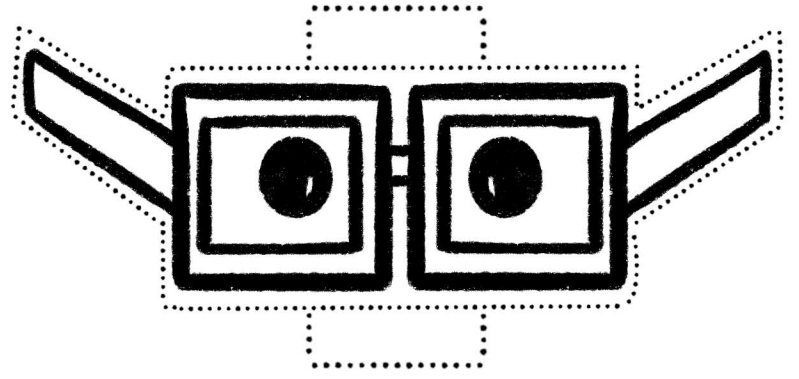
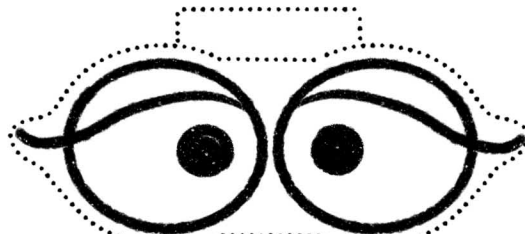
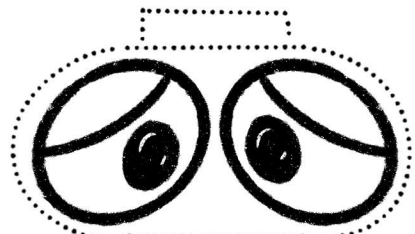

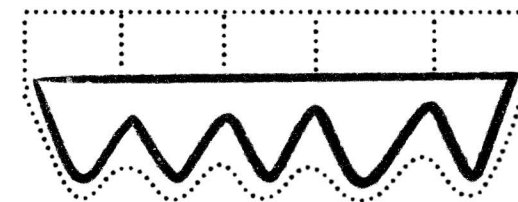
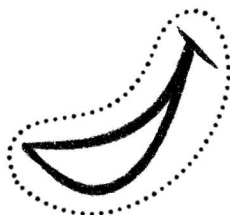
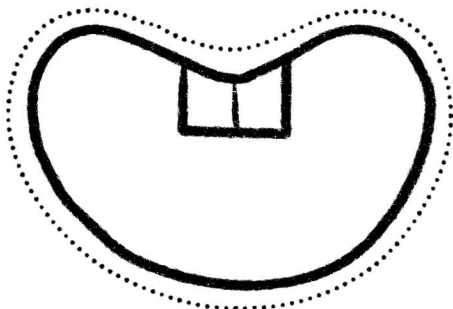
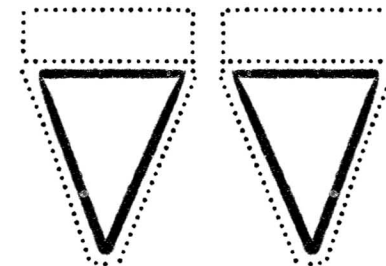
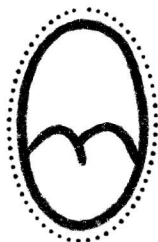
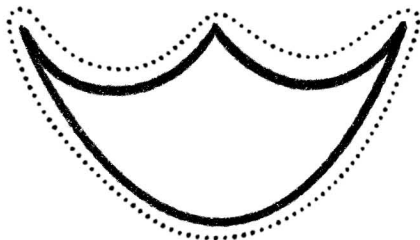
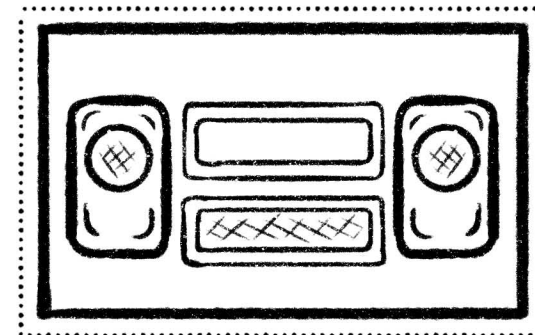
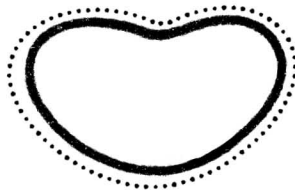
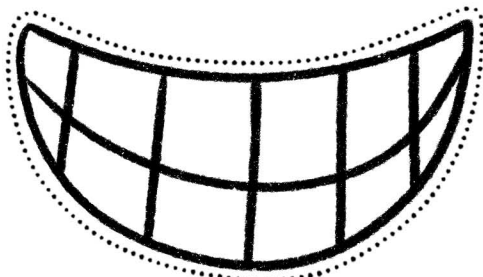

For moving-mouth puppet, use tabs and cut slits in the tabs to help the teeth curve inside the mouth

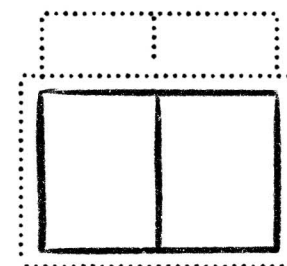
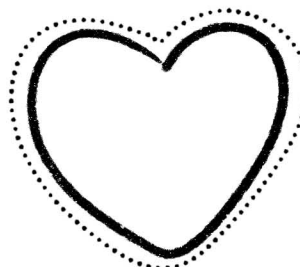
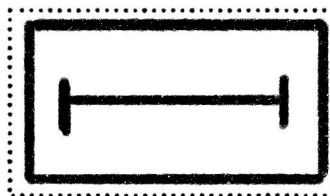
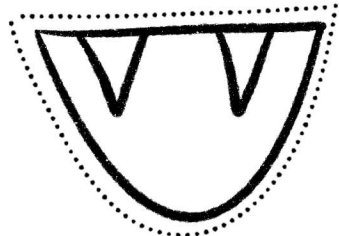

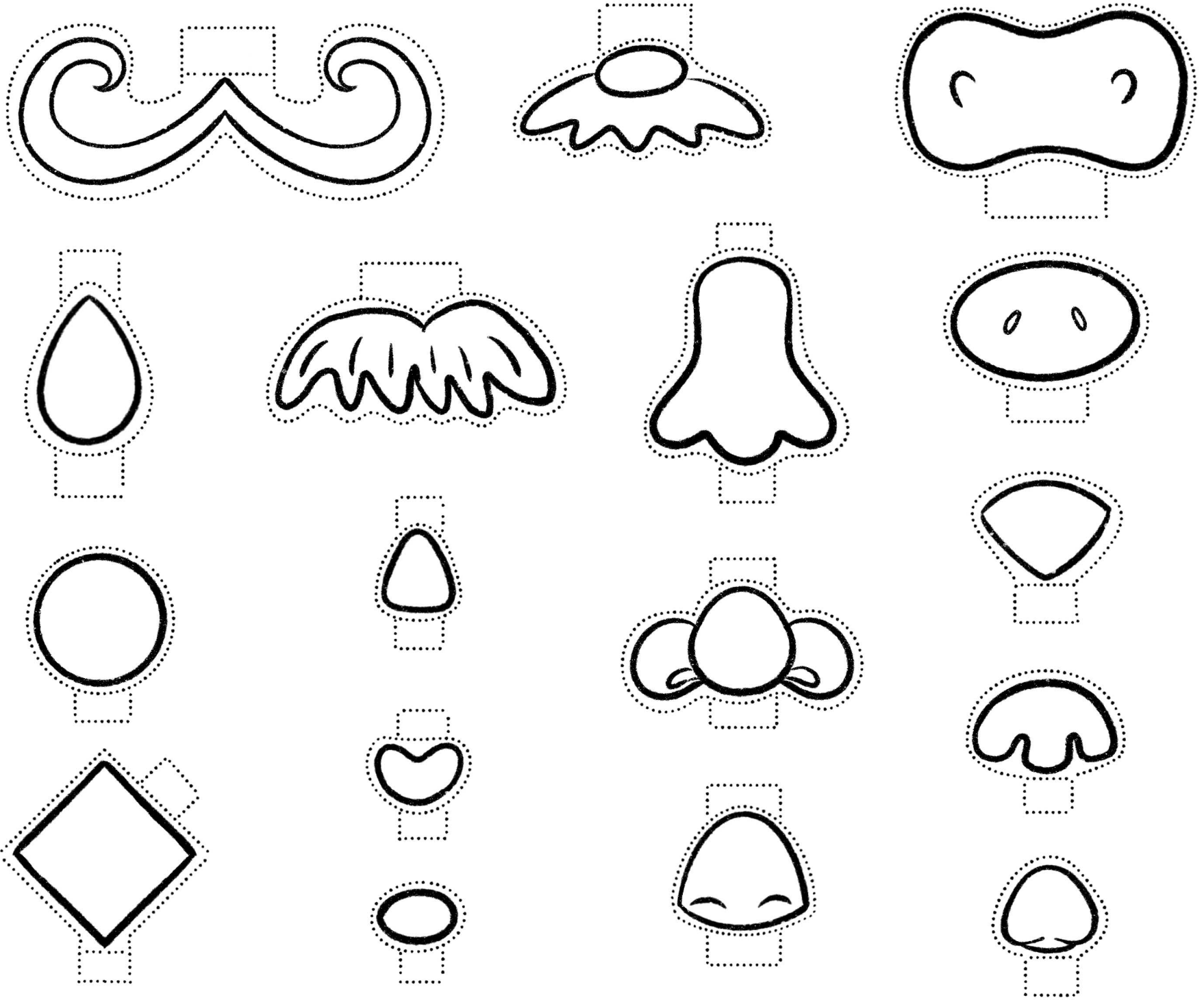

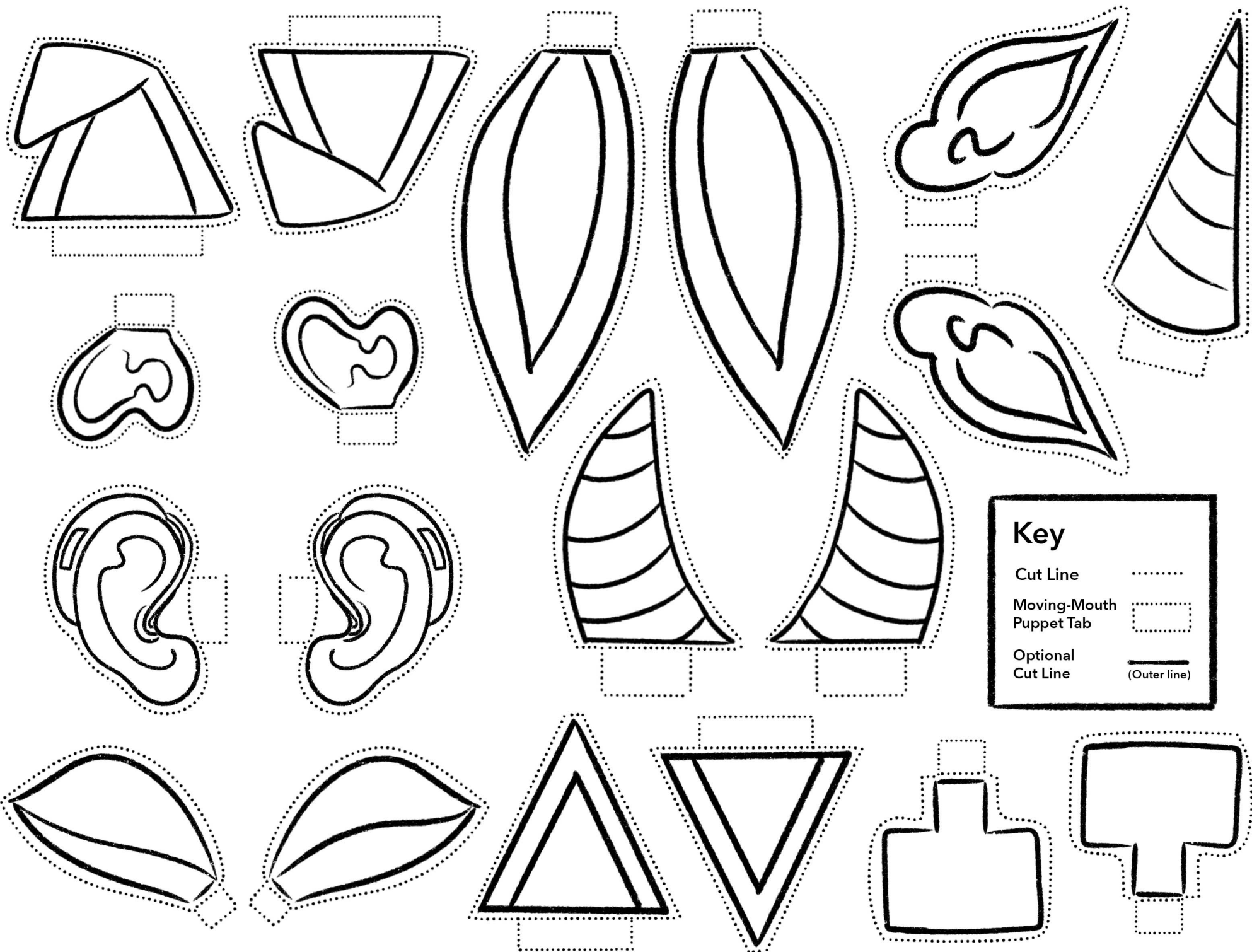

Key

- Cut Line - - - - -
- Moving-Mouth Puppet Tab □
- Optional Cut Line — (Outer line)

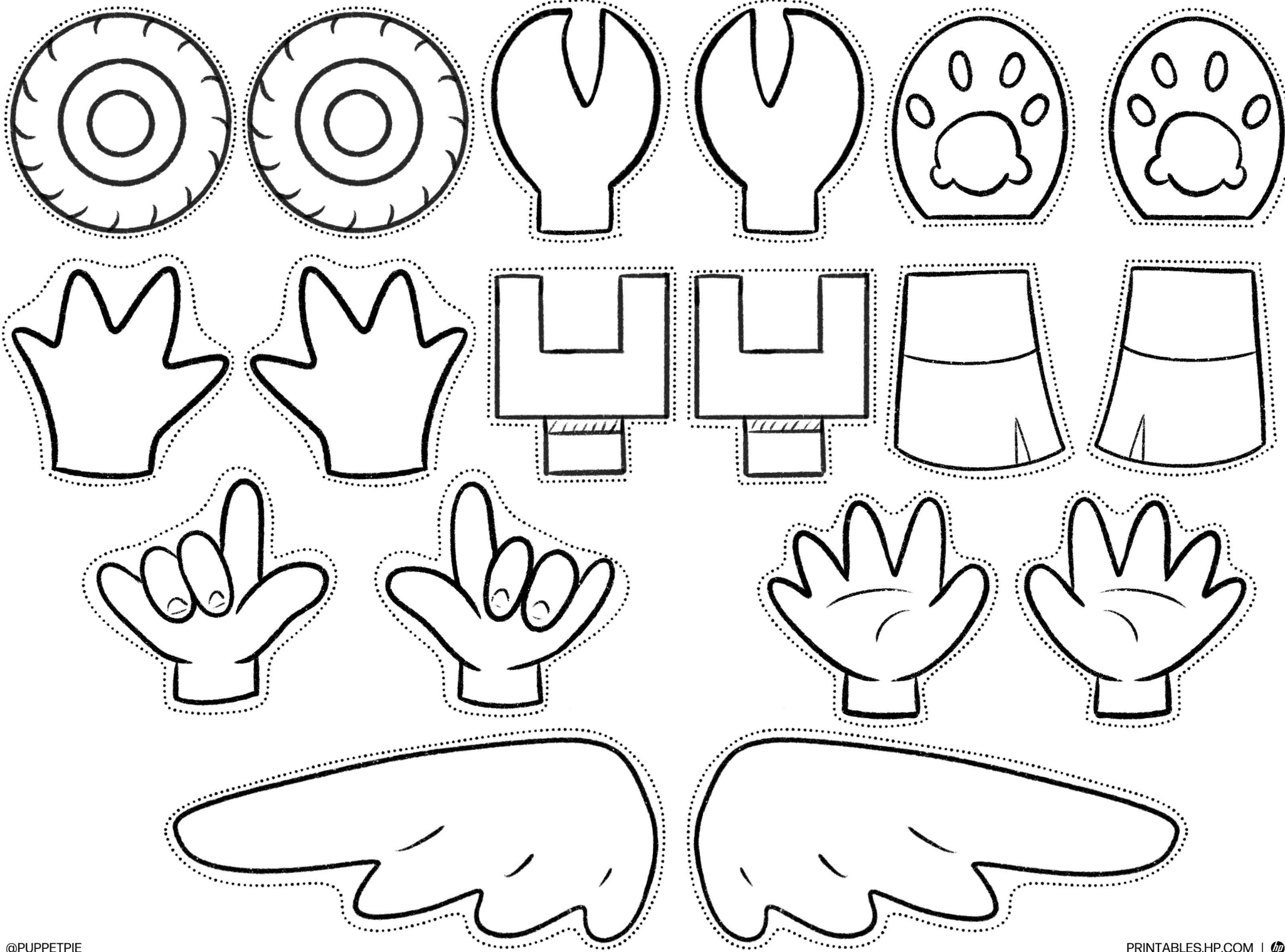

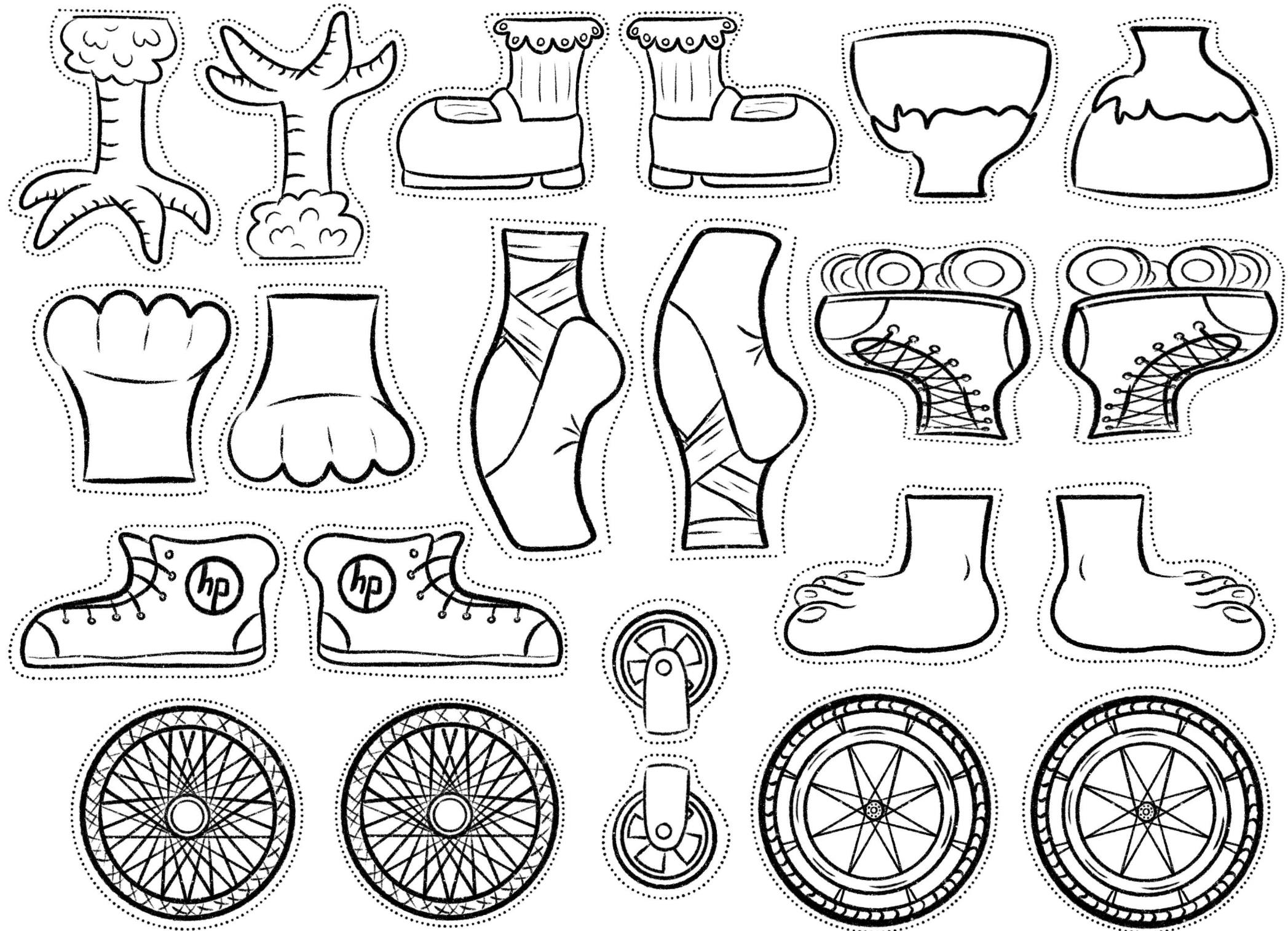

Puppet Bodies

Key

Cut Line 

Fold Line 

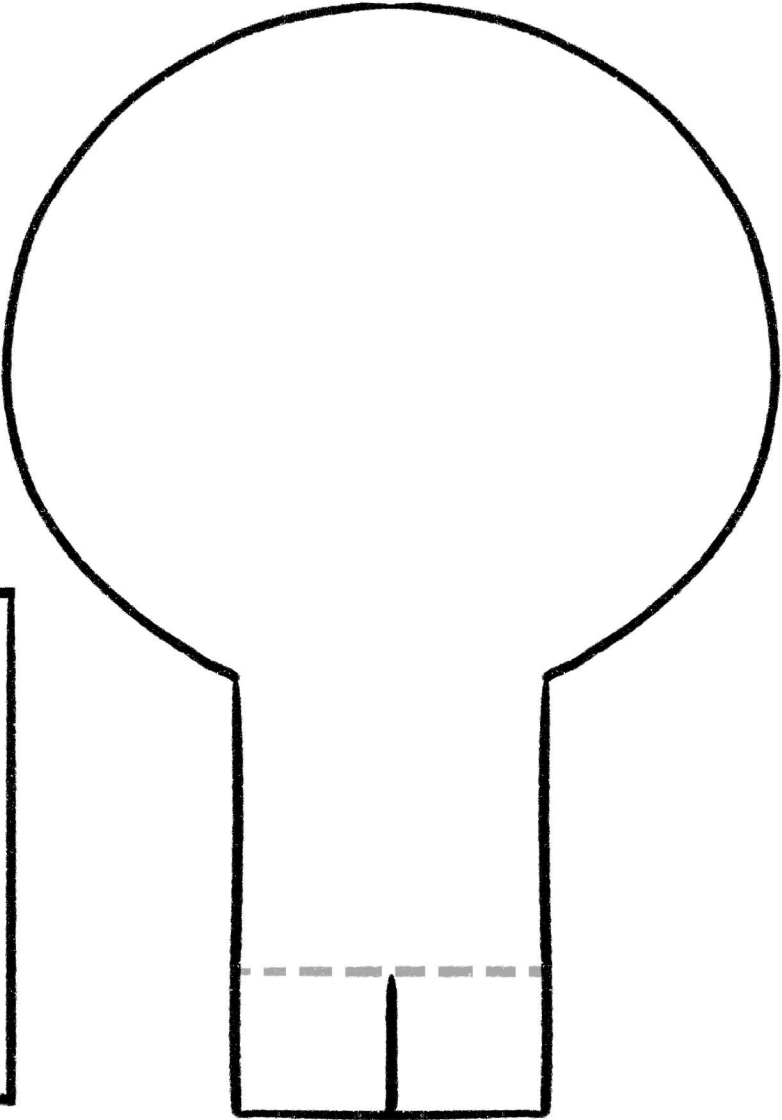
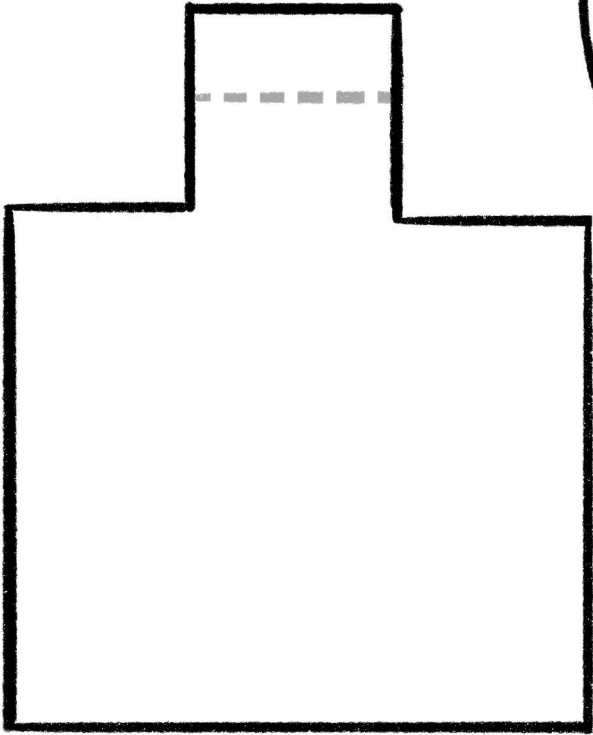
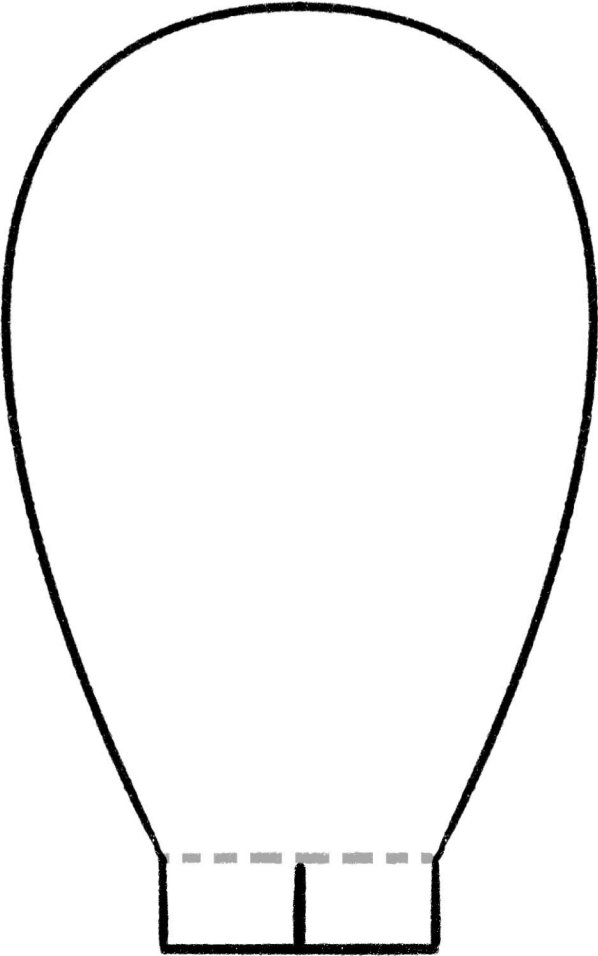

Arms, legs, or whatever
you'd like them to be

