

**MEGA**

**Barbie**



**HPN78**

**CONVERTIBLE & ICE CREAM STAND  
DÉCAPOTABLE ET STAND DE GLACES**

CONVERTIBLE Y PUESTO DE HELADOS / CONVERSÍVEL E QUIOSQUE DE GELADOS  
CABRIO & EISSTAND / КАБРИОЛЕТ И КИОСК С МОРОЖЕНЫМ



**Build  
Construisez**  
Construye | Constrói  
Bauen | Стройте



**Share | Partagez**  
Comparte | Partilha  
Teilen | Делитесь

Devices not included | Appareils non inclus | Dispositivos no incluido  
Dispositivos não incluídos | Geräte nicht enthalten | Устройства не входят в комплект

**Play as you build!  
Jouez en construisant !**

Juega mientras construyes!  
Construção e brincadeira simultâneas!  
Gleichzeitig bauen und spielen!  
Строй и играй!



[megaunboxed.com](http://megaunboxed.com)

**CHOOSE WHAT YOU  
WANT TO BUILD FIRST!  
CHOISISSEZ CE QUE VOUS  
VOULEZ CONSTRUIRE EN PREMIER!**

¡ELIGE QUÉ QUIERES CONSTRUIR PRIMERO! - ESCOLHA O QUE VOCÊ QUER CONSTRUIR PRIMEIRO! KINDER  
KÖNNEN AUSSUCHEN, WAS SIE ZUERST BAUEN WOLLEN! - ВЫБЕРИ, ЧТО ТЫ ХОЧЕШЬ СОБРАТЬ СНАЧАЛА!



# BUILD & CUSTOMIZE YOUR BARBIE® MICRO-DOLLS! ASSEMBLEZ ET PERSONNALISEZ VOS MINI-POUPÉES BARBIE!

¡CREA Y PERSONALIZA TU MICROMUÑECA BARBIE! • CONSTRÓI E PERSONALIZA AS TUAS MICROBONECAS BARBIE!  
DIE BARBIE MIKROPUPPEN LASSEN SICH ZUSAMMENBAUEN UND NEU GESTALTEN!  
СОБИРАЙТЕ И УКРАШАЙТЕ МИКРОКУКОЛ БАРБИ!

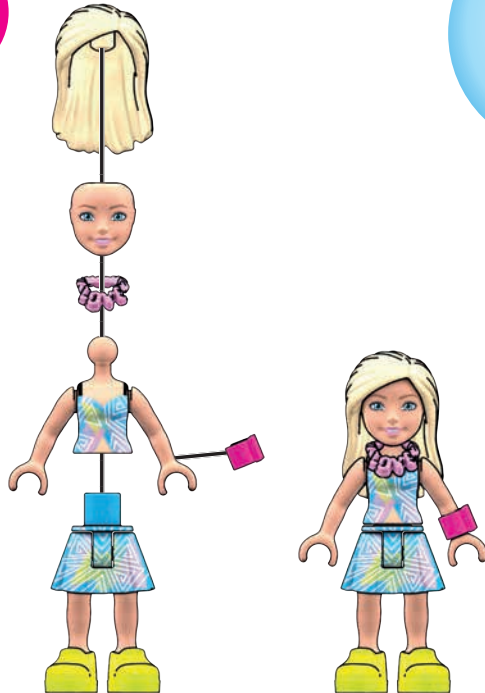

# LET'S BUILD THE ICE CREAM STAND!

## CONSTRUISONS LE STAND DE GLACES !

¡VAMOS A CONSTRUIR EL PUESTO DE HELADOS!

VAMOS CONSTRUIR O QUIOSQUE DE GELADOS!

EINEN EISSTAND BAUEN!

ПОСТРОИМ КИОСК С МОРОЖЕНЫМ!



1

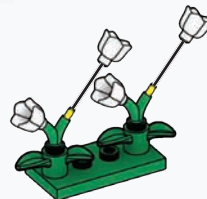
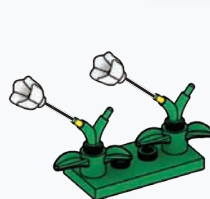
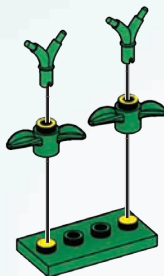

2  
3

2

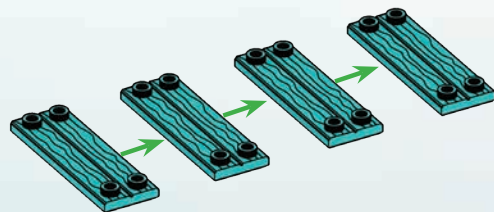
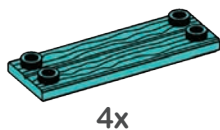

3

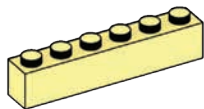

1x

4

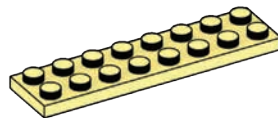

1x

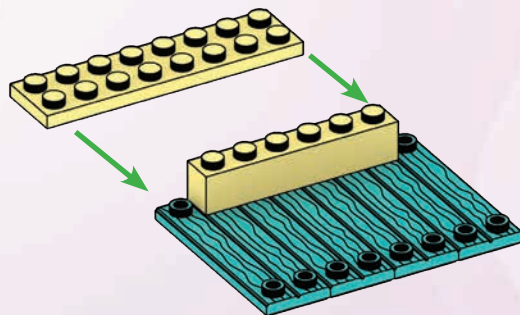
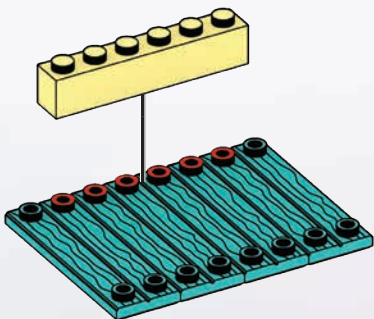

5



2x

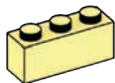

2x

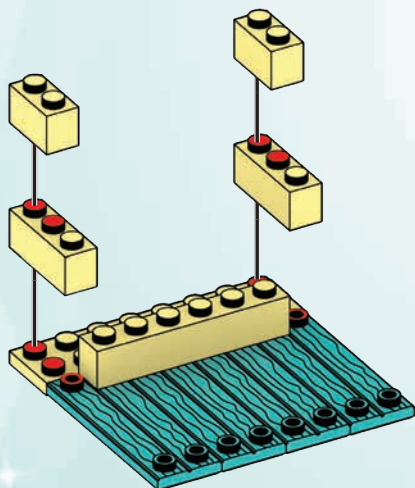

6



1x

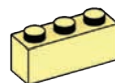

2x

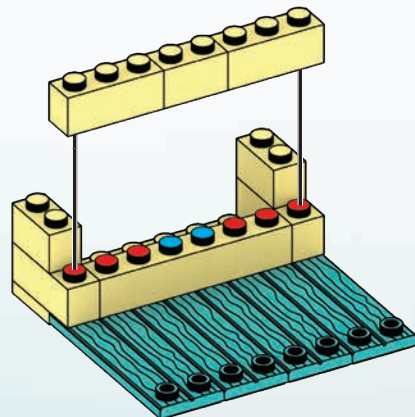

7



1x

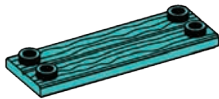

1x

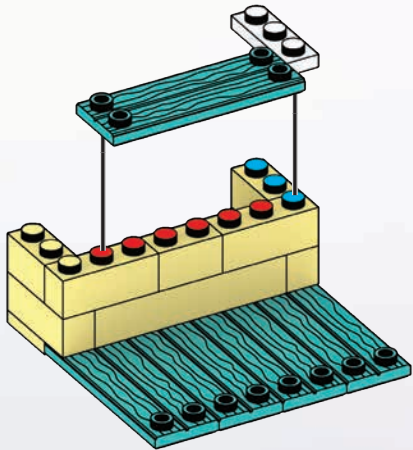

8



1x



1x



1x

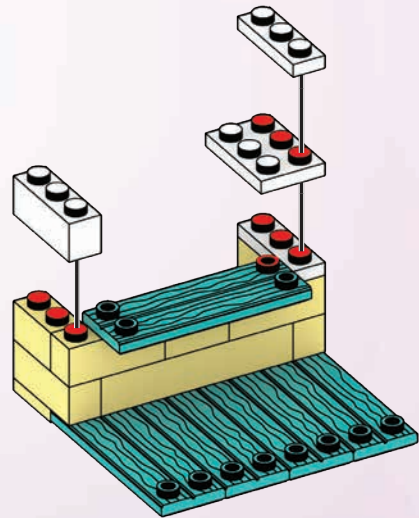

9

- 2x
- 2x
- 2x
- 2x
- 1x
- 1x

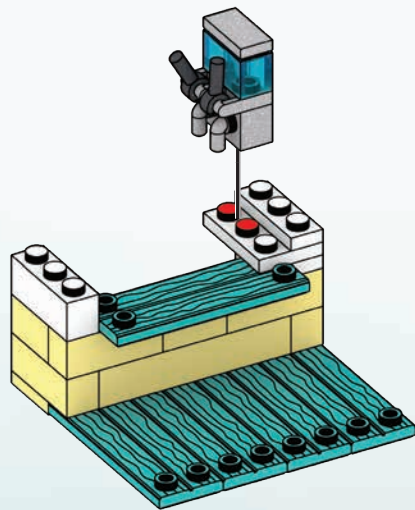
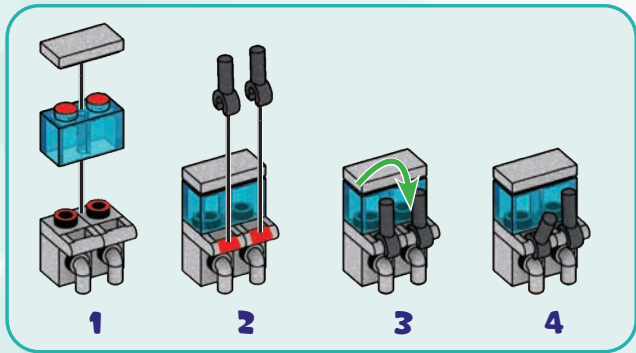
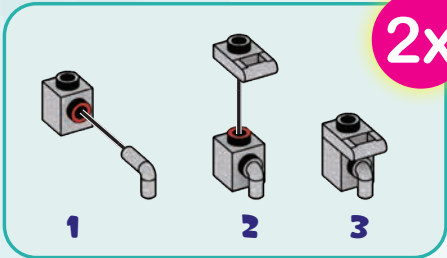



10



1x

11



1x



1x



1x

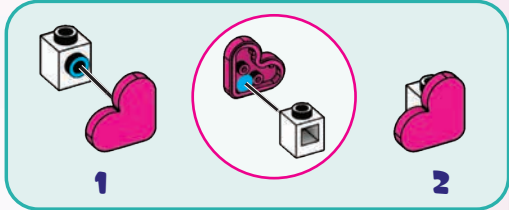

1

2

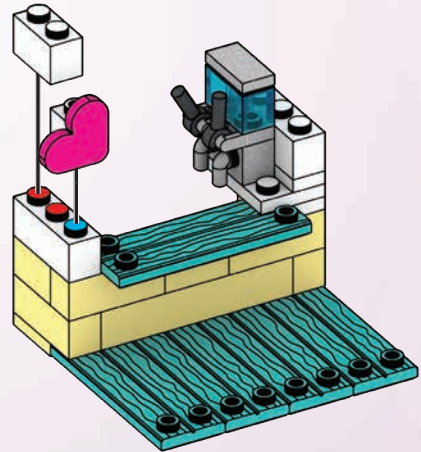
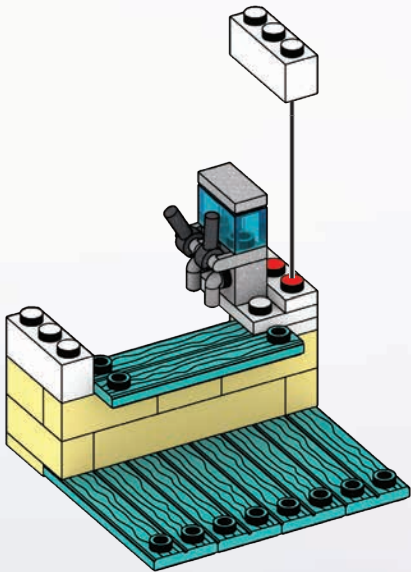

12



1x



1x



1x

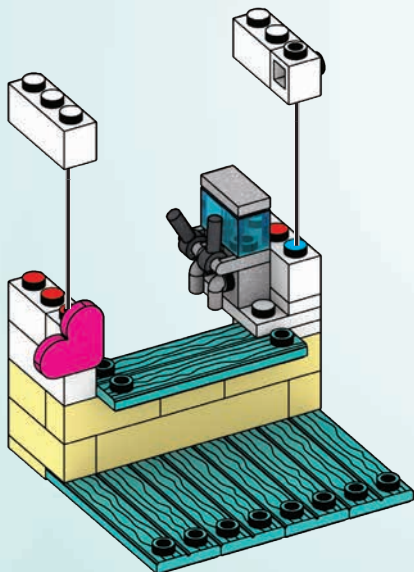

13



2x

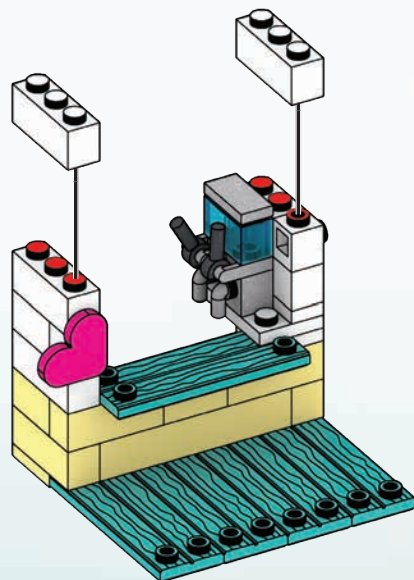

14



2x

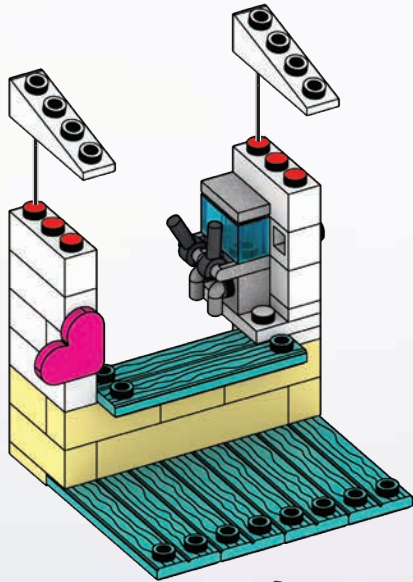

1

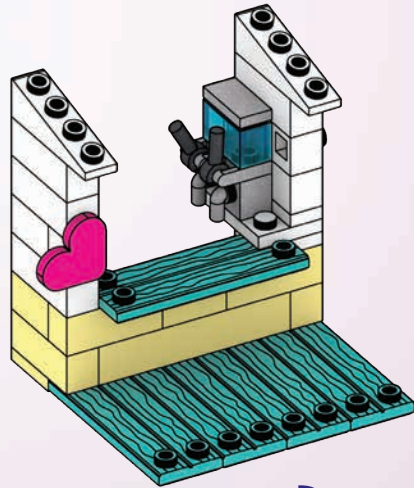

2

15



2x

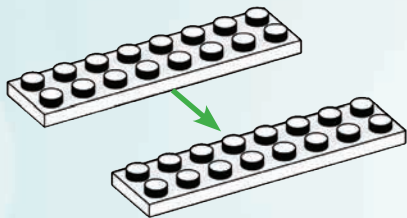

16



3x

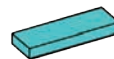

3x

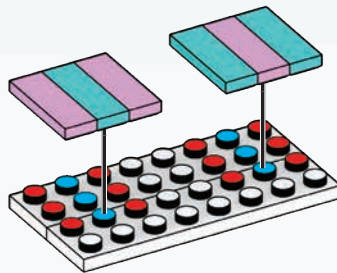

17



1x



1x



1x

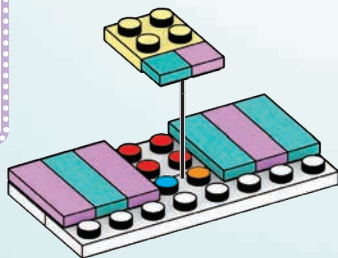

18



4x



4x

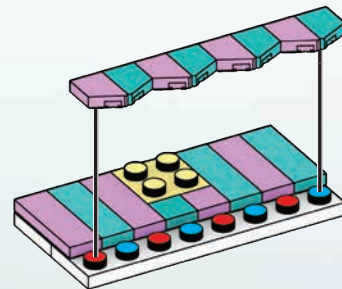

19



1x

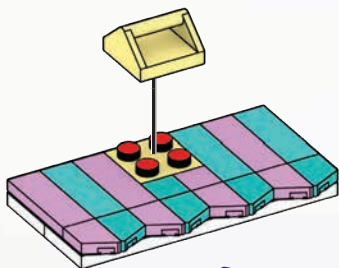

1

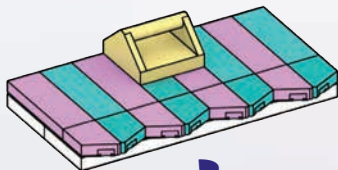

2

20

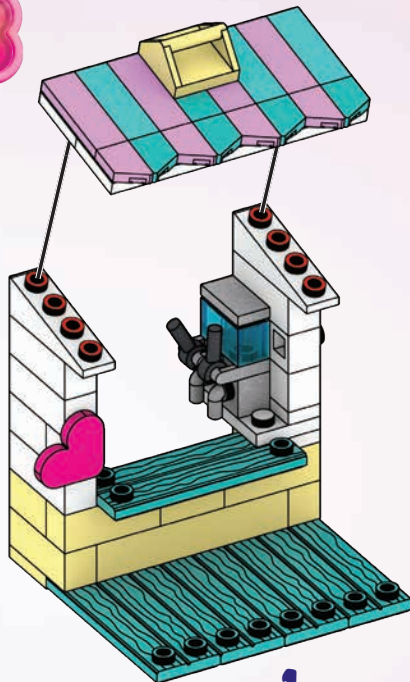

1

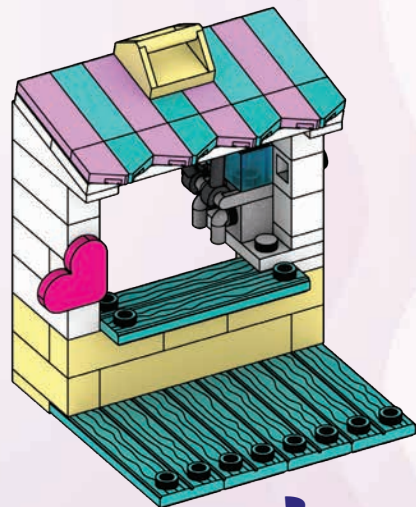

2

21



1x



1x



1x



1x

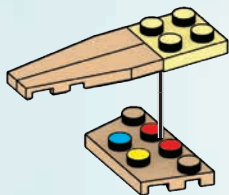

22



1x



1x

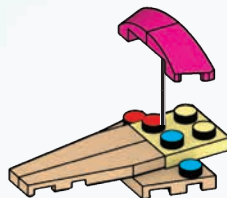

23



2x

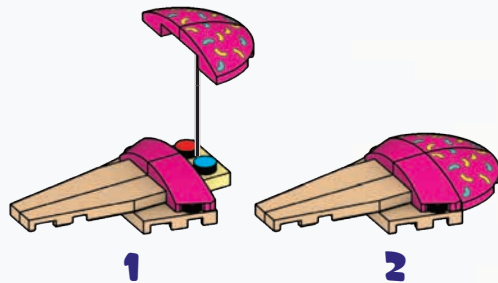

24



1x



1x



1



2



3

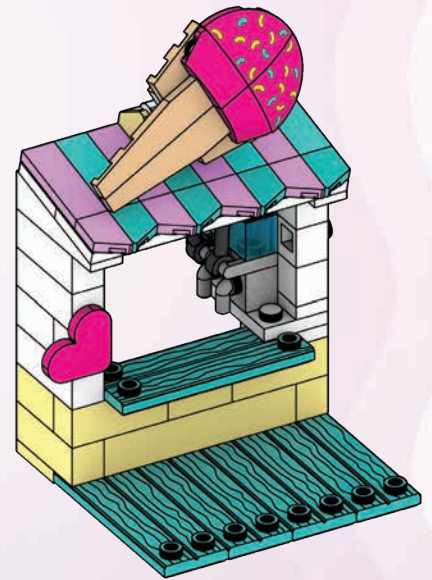
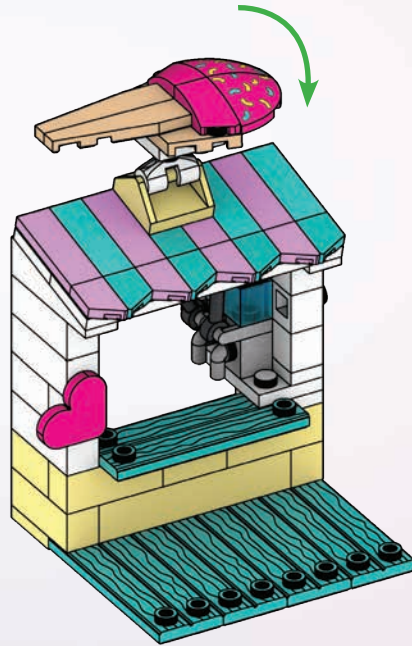
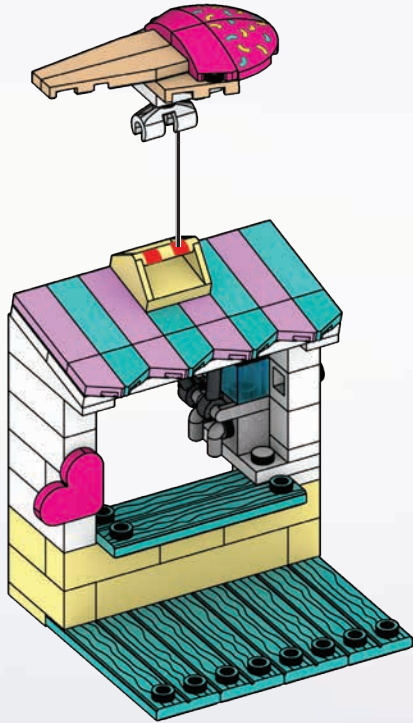

26



1x



2x

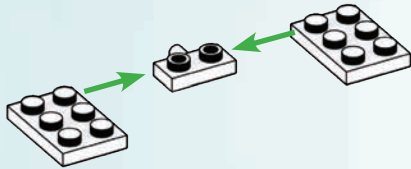

27



1x

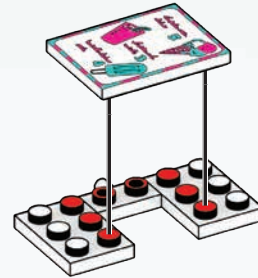

28



3x



3x

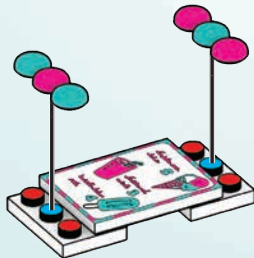

1



2



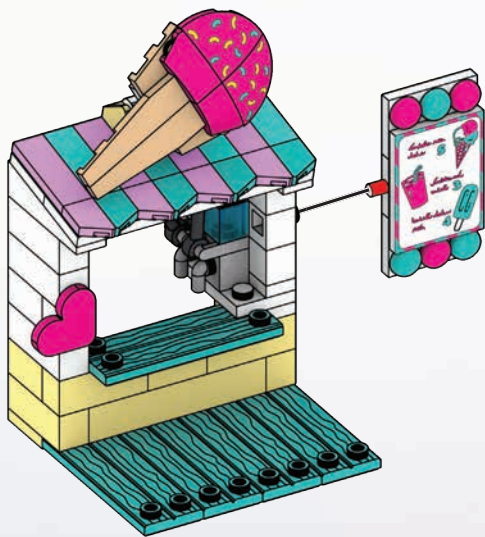

1

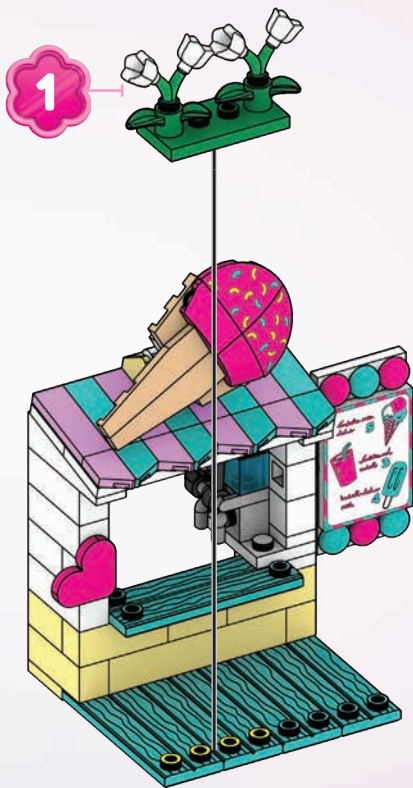

2

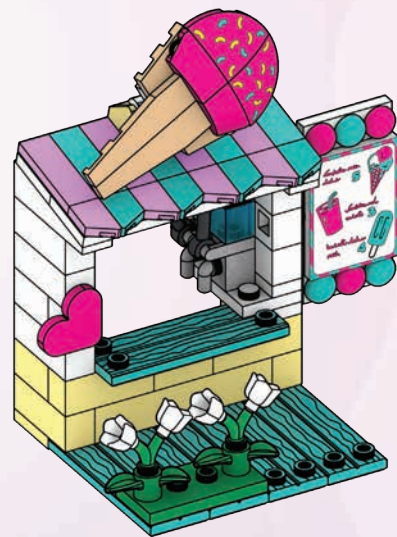

3

30



1x



2x



1x



1x



1x



1

2

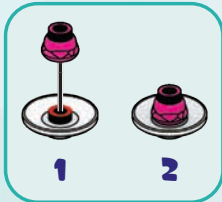

1

2

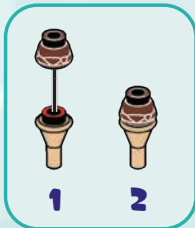

1

2

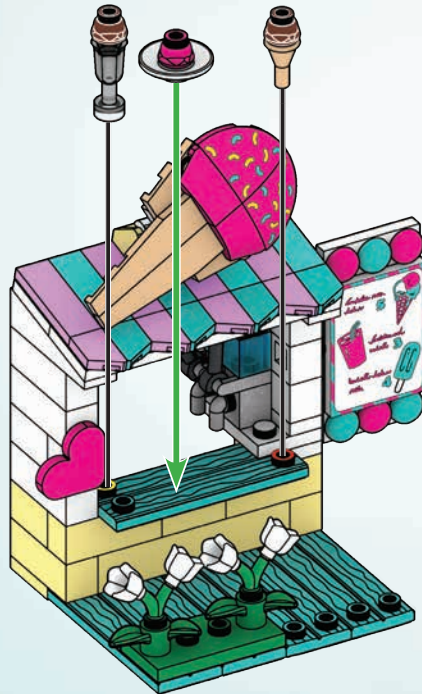

1

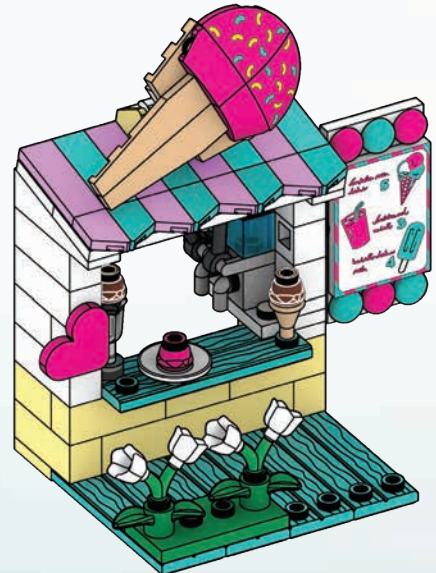

2

**LET'S BUILD THE  
BOARDWALK!**

**CONSTRUISONS LA  
PROMENADE !**

**¡VAMOS A CONSTRUIR  
EL PASEO MARÍTIMO!**

**VAMOS CONSTRUIR O CALÇADÃO!**

**EINE PROMENADE BAUEN!**

**ДАВАЙТЕ ПОСТРОИМ  
ДОЩАТЫЙ НАСТИЛ**

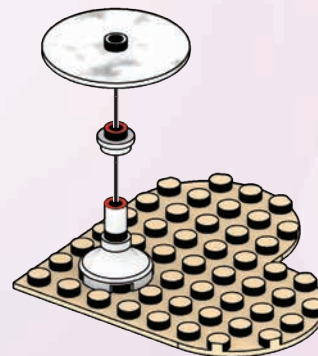
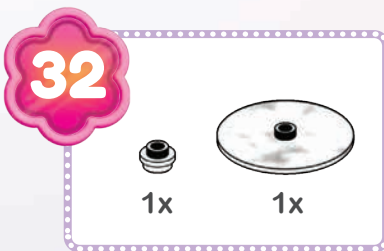
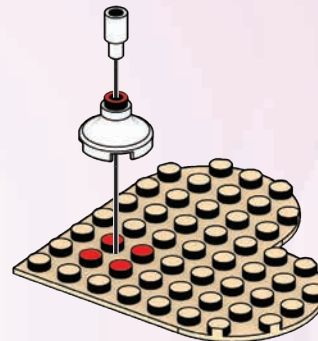
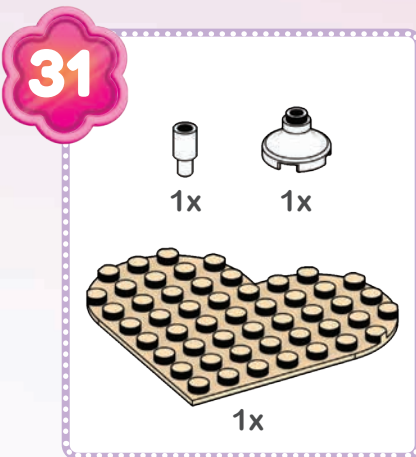

33



1x



1x

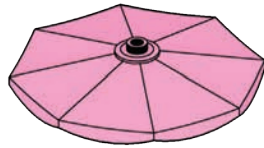

1x

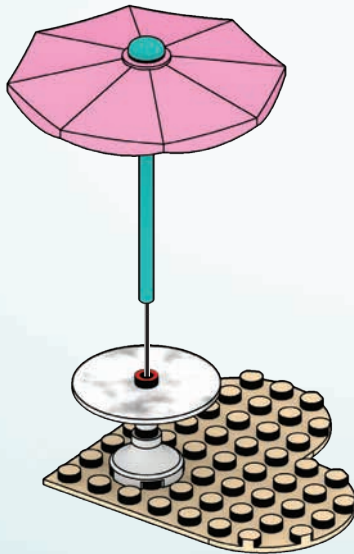
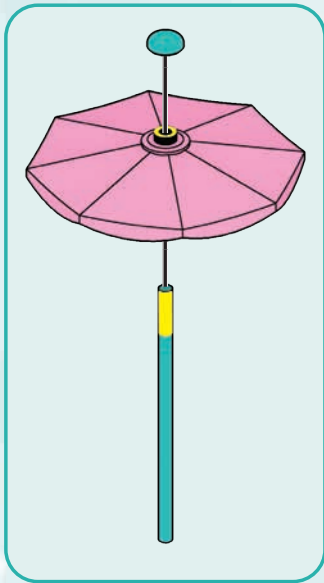

1



2

34



2x



2x



2x

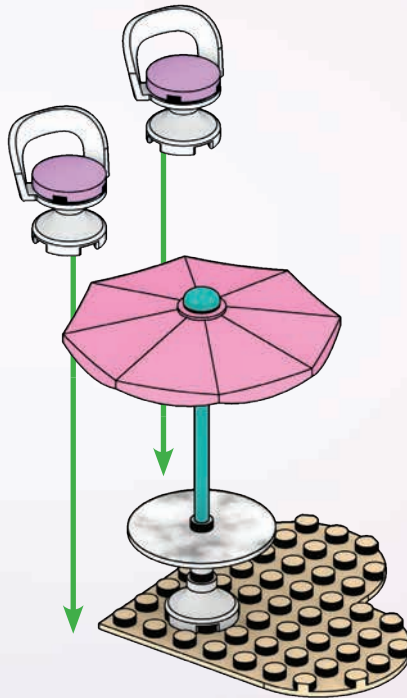
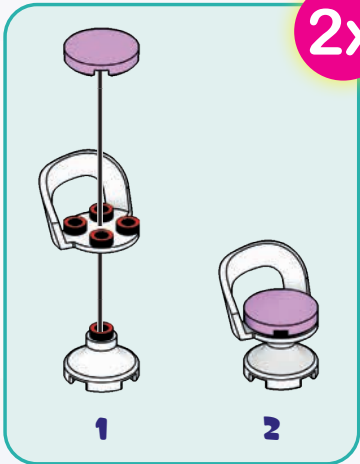





1



2

# 35

- 1x 
- 1x 
- 1x 
- 1x 
- 1x 

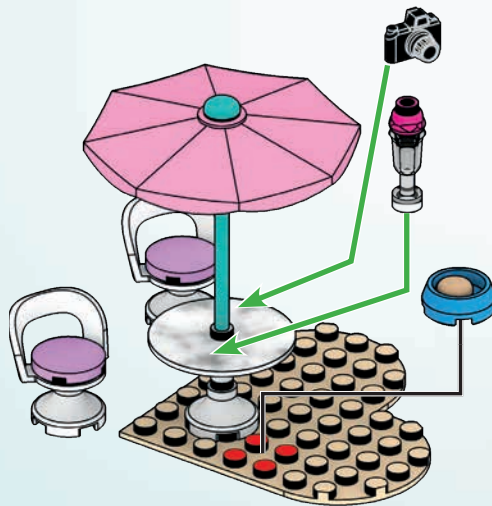
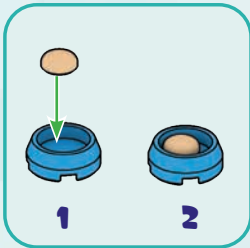
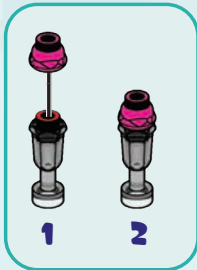



**LET'S PLAY!**  
**AMUSONS-NOUS!**  
¡AJUGAR! • A BRINCAR!  
LASS UNS SPIELEN! • НАЧИНАЕМ ИГРУ!

**LET'S BUILD THE  
CONVERTIBLE!**

**CONSTRUISONS LE  
CABRIOLET !**

**¡CONSTRUYAMOS  
EL CONVERTIBLE!**

**CONSTRUAMOS O CONVERSÍVEL!**

**EIN CABRIO BAUEN!**

**СОБЕРИ КАБРИОЛЕТ!**

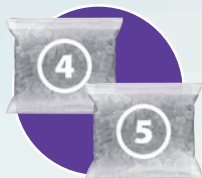

**36**



2x



2x

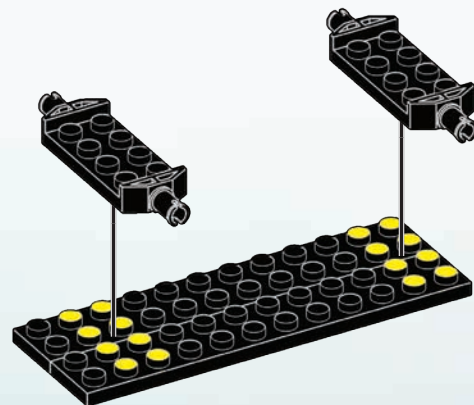



37

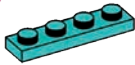

1x



1x



1x

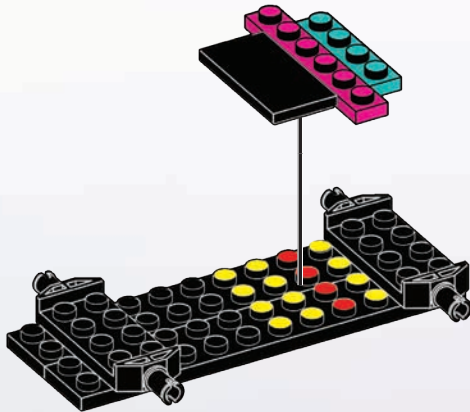

38



2x



1x

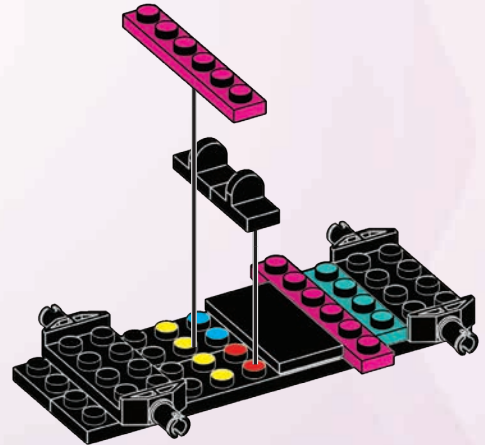

39



2x

40



2x



2x

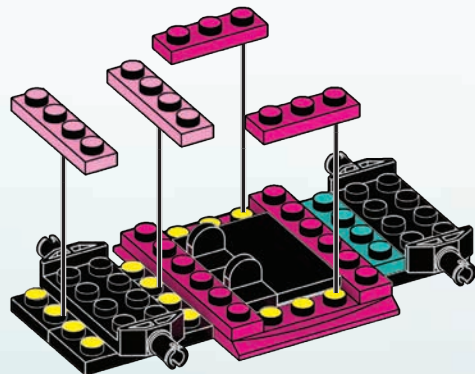
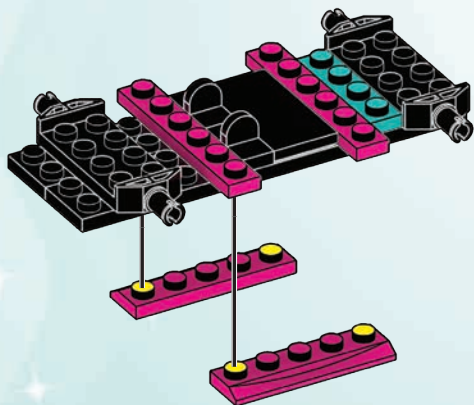

41



1x

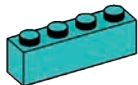

1x



1x

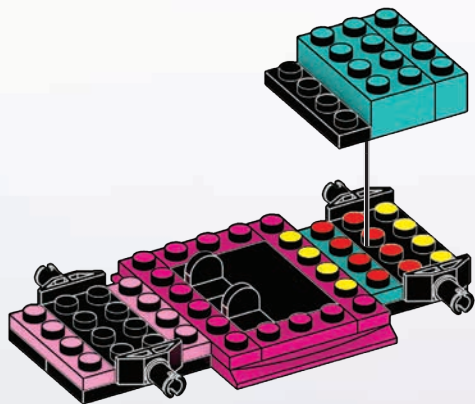

42



2x

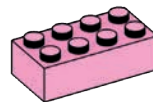

2x

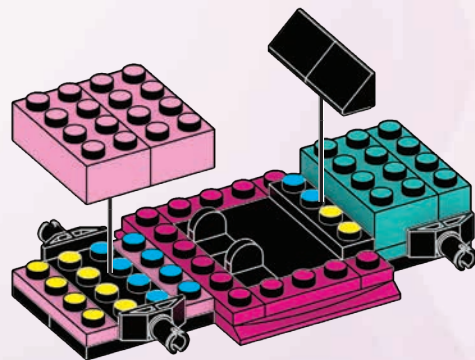

43



2x



1x



2x

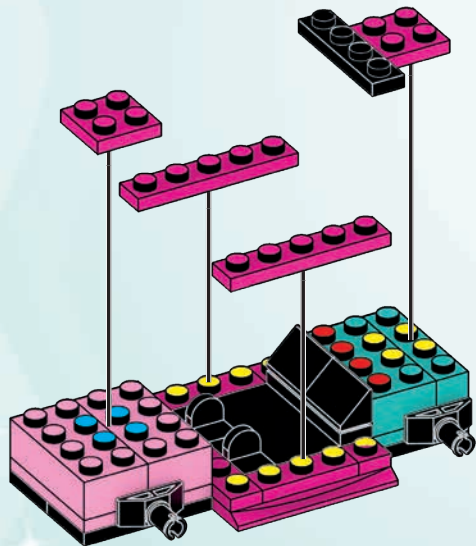

44



4x



45



1x

46



4x



1x



1x

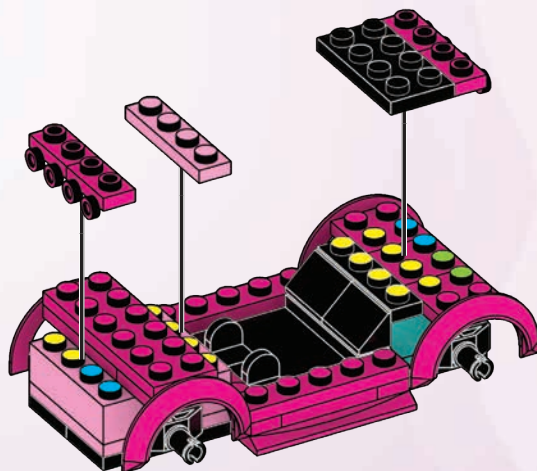
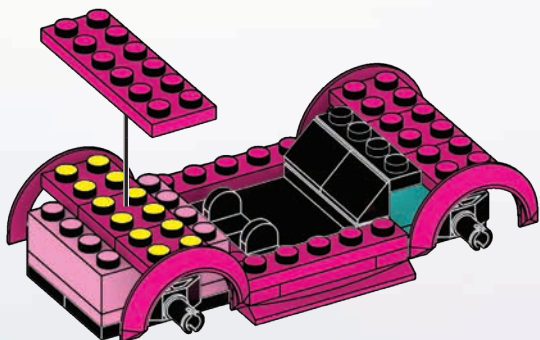

47

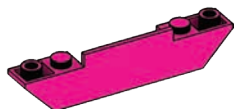

2x

48



2x

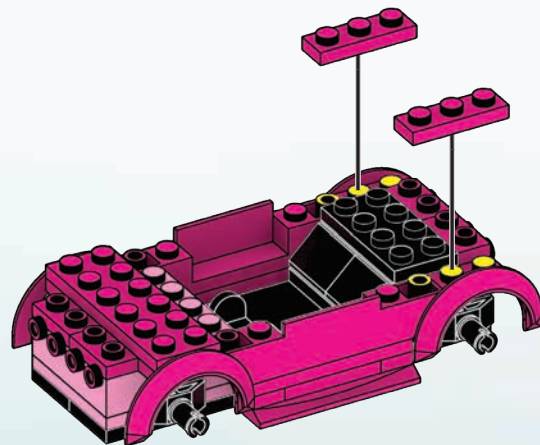
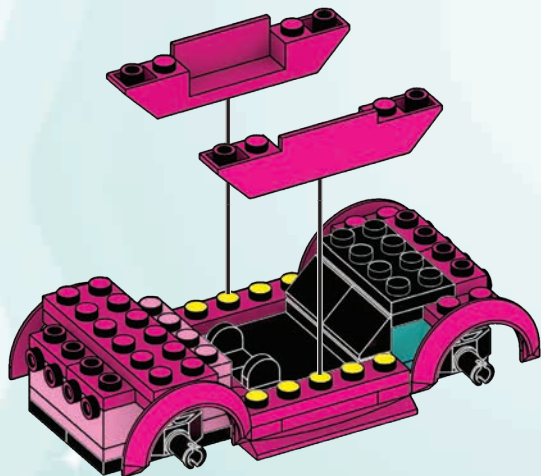

49



2x



1x



1x



1x

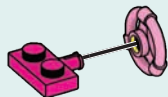

1



2

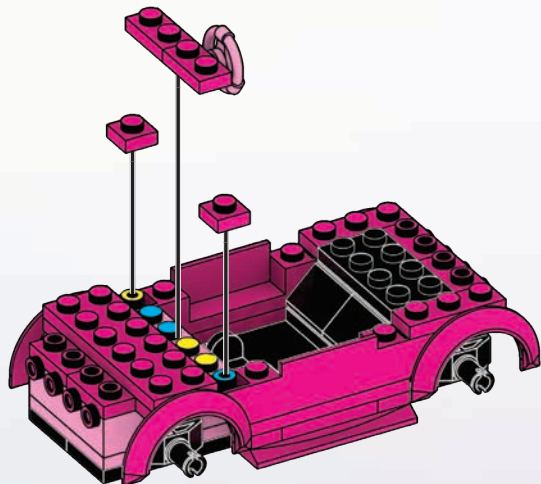

50



1x



1x



2x



1x

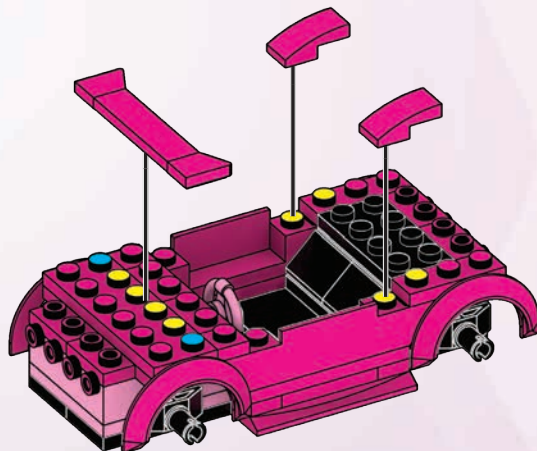

51



2x



1x



1x



1x

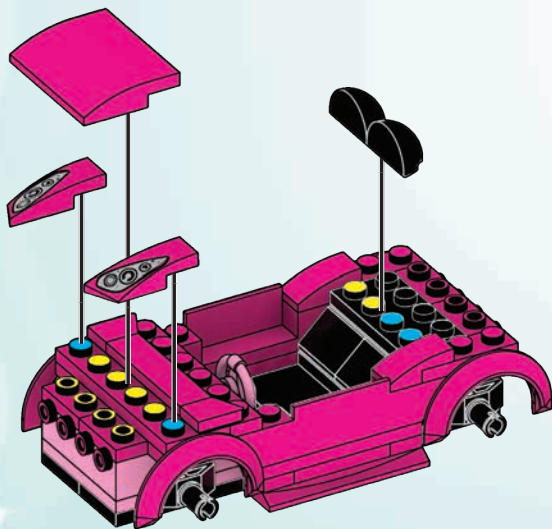

1

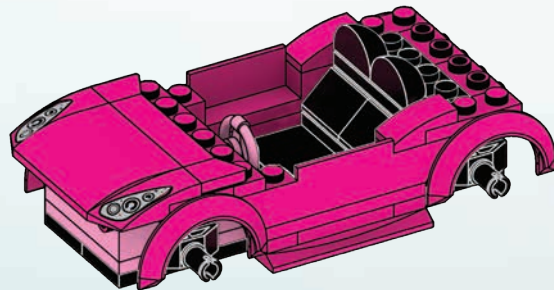

2



52



2x



1x

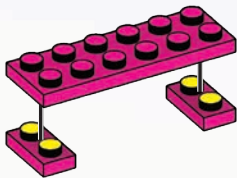

54



1x



1x



1x



53



2x



1x



55



1x



1x



1x



1

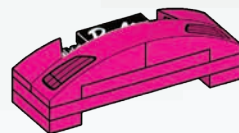

2

56

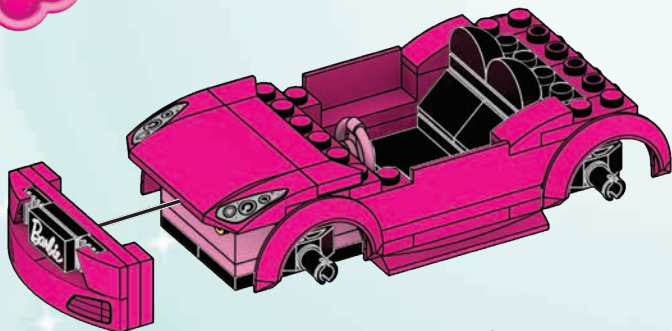

1

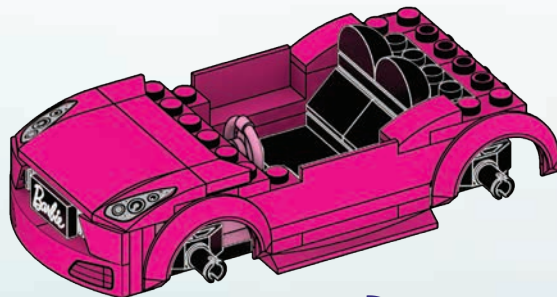

2

57

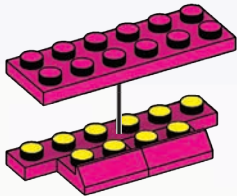
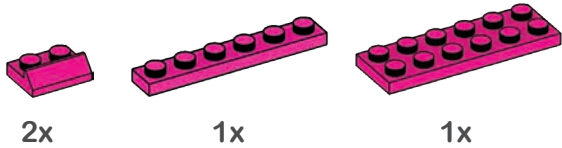

58

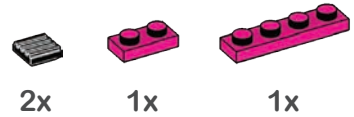

59

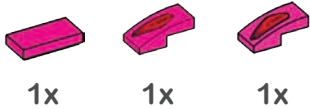

60

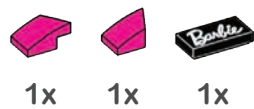

1



2

61

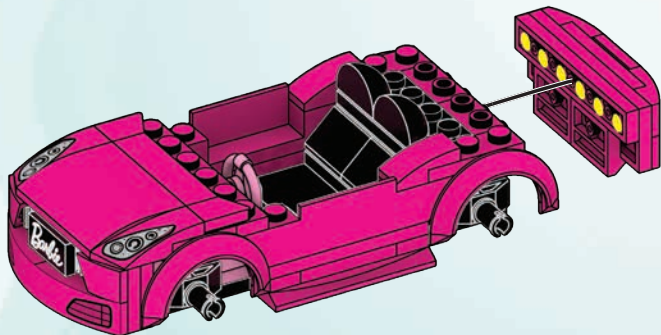

62



3x

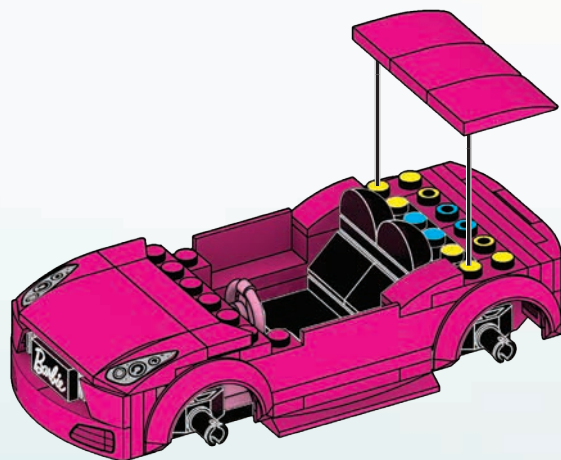

63



2x

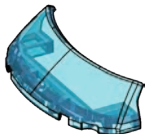

1x



64



1x



1x

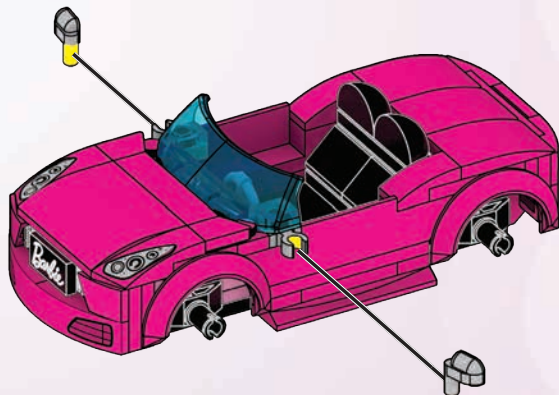

65



4x

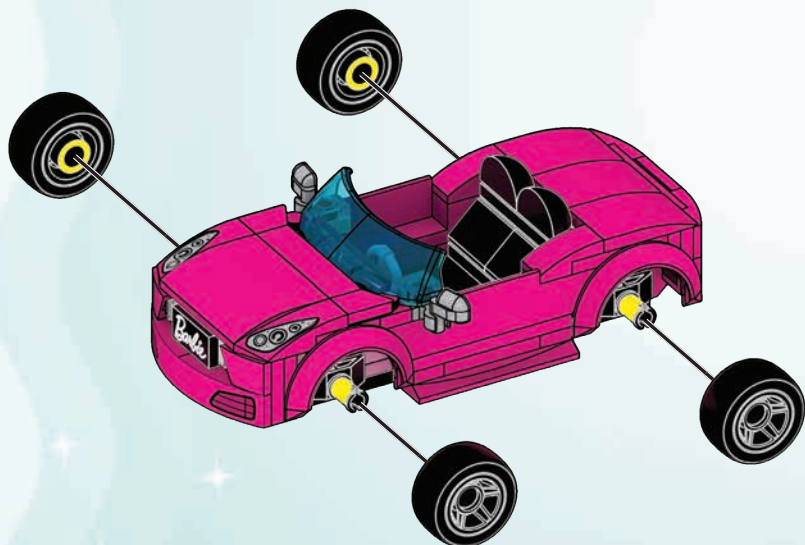

1

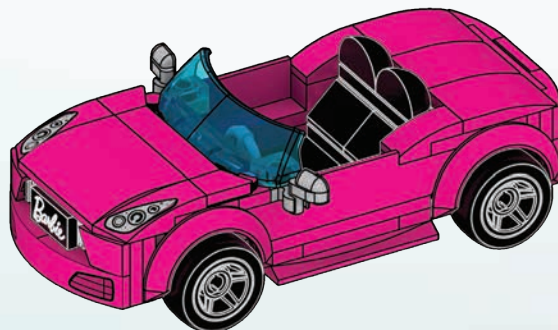

2

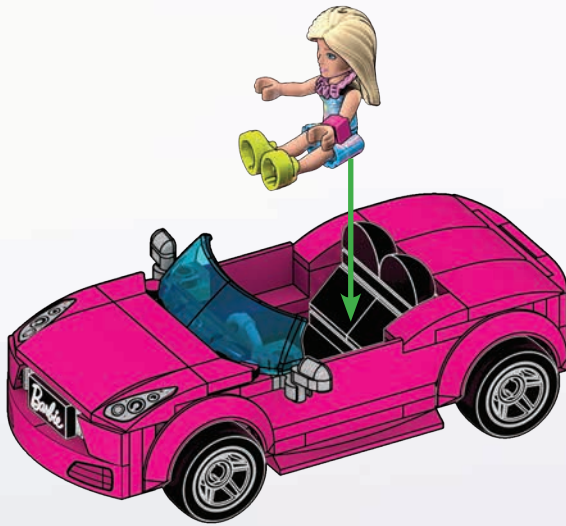

1



2



LET'S PLAY!  
AMUSONS-NOUS!

¡AJUGAR! • A BRINCAR!  
LASS UNS SPIELEN! • НАЧИНАЕМ ИГРУ!

Convertible & Ice Cream Stand • Décapotable et Stand de glaces

Convertible y puesto de helados • Conversível e Quiosque de Gelados • Cabrio e Chiosco dei Gelati • Cabrio & Eisstand  
Kabriolet i stoisko z lodami • Cabriolet en IJskraam • Кабриолет и киоск с мороженым • Κάμπριο & Μαγαζάκι με Παγωτά • Dondurma Standı  
Cabrio és fagyizó • Cabriolet och glasstånd • Cabriolet og isbod • سيارة مكشوفة وستاند الأيس كريم



1x  
AM74397E



4x  
AM74299CV



1x  
AM75332AMR



4x  
AM74300ASY



4x  
AM75332CV



2x  
AM18591APG



3x  
AM75332ATC



2x  
AM03328ATC



1x  
AM18560E



1x  
AM74299ATC



2x  
AM73014DH



1x  
AM74300ATC



2x  
AM73014ATC



4x  
AM72953E



1x  
AM07223ASY



1x  
AM74401APG



1x  
AM07223CV



1x  
AM74400APG



4x  
AM79666F



2x  
AM19617MM



2x  
AM19392APG



2x  
AM76054APG



1x  
AM72922F



2x  
AM07629APG



2x  
AM07629E



2x  
AM78722BMG



1x  
AM73012AMR



2x  
AM73039AGY



1x  
AM81383ASX



2x  
AM81545ATC



2x  
AM81546ATC



1x  
AM18260E



1x  
AM74414E



1x  
AM22501APG



1x  
AM22501ATC



2x  
AS-HPN78-02



1x  
AM09393F



4x  
AM09393ATC



1x  
AM18221ATC



1x  
AM79563E



2x  
AM81861F



4x  
AM76467ATC



2x  
AM09835ATC



2x  
AM78726BMG



1x  
AM73980ATC



1x  
AM74427ATC



1x  
AM74426ATC



2x  
AM78486ATC



1x  
AS-HPN78-07



1x  
AS-HPN78-08



2x  
AM03019F



2x  
AM17835F



1x  
AM72972GX



3x  
AM72908E



3x  
AM09013CS



2x  
AM09013E



1x  
AM09013AAV



1x  
AM16967CS



2x  
AM02215ASY



2x  
AM03773CS



1x  
AM01146E



2x  
AM03773ATC



2x  
AS-HPN78-09



1x  
AS-HPN78-04



1x  
AS-HPN78-03



4x  
AM01314ATC



2x  
AM01314E



3x  
AM80966ASY



3x  
AM80966CV



4x  
AM16384CS



5x  
AM16384E



3x  
AM03772E



4x  
AS-HPN78-01



1x  
AS-HPN78-05



1x  
AS-HPN78-06



3x  
AM81604ATC



2x  
AM09593ATC



1x  
AM09838ATC



3x  
AM09593ASX

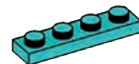

1x  
AM09593CV



2x  
AM09593F



1x  
AM76451AMR



1x  
AM76452AMR



1x  
AM01087CV



1x  
AM09493F

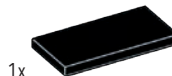

1x  
AM77463F

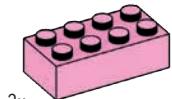

2x  
AM09033ASX



1x  
AM09033CV



1x  
AM74416AMR



1x  
AM01531BMG



2x  
AM77199E

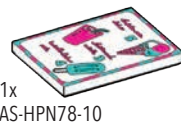

1x  
AS-HPN78-10



1x  
AM72904AKQ



4x  
AM17390ATC



1x  
AM72412ATC



2x  
AM07475ATC



2x  
AM81703ATC

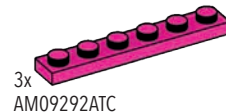

3x  
AM09292ATC



2x  
AM81091F

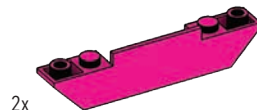

2x  
AM81549ATC



3x  
AM01480ATC

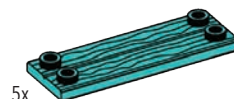

5x  
AM79449CV

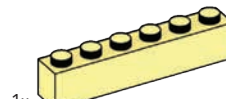

1x  
AM01313CS

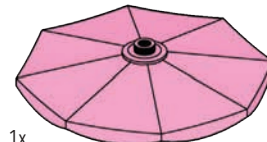

1x  
AM72903ASX



1x  
AM18259CV

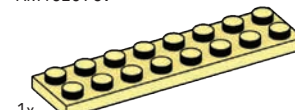

1x  
AM08483CS



2x  
AM08483E



1x  
AM81104BTN



2x  
AM01172F



1x

FIG-HPN78-A



1x

FIG-HPN78-B

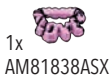

1x

AM81838ASX



1x

AM81839ATC



1x

AM81872E



1x

AM81873AMP



1x

FIG-HPN78-C



2x

AM72909E

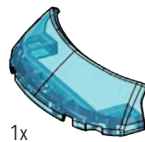

1x

AM81863AAV

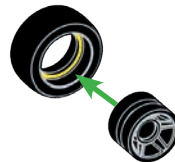
**Missing pieces?  
Pièces manquantes?**¿Partes faltantes? • Perdeu peças?  
Fehlende Teile? • Не хватает деталей?[support.megabrands.com](http://support.megabrands.com)

Mattel Europa B.V., Gondel 1, 1186 MJ Amstelveen, Nederland. Mattel U.K. Limited, The Porter Building, 1 Brunel Way, Slough SL1 1FQ, UK. Mattel France, Parc de la Cerisaie, 1/3/5 allée des Fleurs, 94260 Fresnes Cedex. N° Cristal 0969 36 99 99 (Numéro non surtaxé) ou www.lesjouetsmattel.fr Mattel Belgium, Trade Mart, Atomiumsquare, Bogota 202 - B 275, 1020 Brussels. Gratis nummer België: 0800 - 16 936 - Gratis nummer Luxemburg: 800 - 22 784 - Gratis nummer Nederland: 0800 - 262 88 35. Deutschland - Mattel GmbH, Solmsstraße 83, D-60486 Frankfurt am Main. Schweiz: Mattel AG, Kirchstrasse 24, CH-3097 Liebefeld. Österreich: Mattel Ges.m.b.H., Campus 21, Liebermannstraße A01 404, A- 2345 Brunn/Gebirge. Mattel Italy Srl, Via Turati 4, 20121 Milano, Italy. Servizio assistenza clienti: Customersrv.italia@mattel.com - Numero verde 800 11 37 11. Mattel España, S.A, Aribau 200 pl. 9, 08036 Barcelona. cservice.spain@mattel.com Tel.: +34 933 06 79 00 http://www.service.mattel.com/es. Mattel East Asia Ltd., Room 503-09, North Tower, World Finance Centre, Harbour City, Tsimshatsui, HK, China. Tel.: (852) 3185-6500. Diiport &

Diedarkan Oleh: Mattel Continental Asia Sdn Bhd. Level 19, Tower 3, Avenue 7, No. 8 Jalan Kerinci, Bangsar South, 59200 Kuala Lumpur, Malaysia. Mattel South Africa (PTY) LTD, Office 102 I3, 30 Melrose Boulevard, Johannesburg 2196. Dystrybutor: Mattel Poland Sp. z o.o., Warsaw Trade Tower 34 p., ul. Chłodna 51, 00-867 Warszawa. Mattel Australia Pty. Ltd., 658 Church St., Richmond, Victoria, 3121. Consumer Advisory Service - 1300 135 312. Mattel AEBE, Eбвoпoу Maxapиoу 1, Kтpиo K-2, TK 17561, Πoλιaίo Φaλnpo. Mattel Oyuncakçılık Tic. Ltd. Şti. Eçerenköy Mah., Umut Sokak No: 10 - 12, Quick Tower kat:2 İçkapı no:15 Ataşehir 34752, İstanbul, Türkiye. Tel: 0216 570 75 00. Импортёр/Уполномоченная организация: ООО "МАТТЕЛ" Российская Федерация, 105120 Москва, 2-й Сыромятнинский переулок 1; +7 495 287 79 39. Mattel Czech Republic s.r.o., The Forum, Václavské nám. 19, 11000 Praha 1. Mattel, 333 Continental Boulevard, El Segundo, CA 90245, USA. Consumer Services: 1-800-465-MEGA (6342). Mattel Canada Inc., Mississauga, Ontario L5R 3W2. Consumer Services: You may call us free at/ Composez sans frais le 1-800-524-8697. Importado y distribuido por Mattel de México, S.A. de CV., Miguel de Cervantes Saavedra No. 193, Pisos 10 y 11, Col. Granada, Alcaldía Miguel Hidalgo, C.P. 11520, México, Ciudad de México. R.F.C. MME-920701-NB3. Tels: 59-05-51-00 Ext. 5206 ó 01-800-463-59-89. Mattel Chile, S.A., Avenida Américo Vespuccio 501-B, Quilicura, Santiago. Tel: 1230-020-6213. Servicio al consumidor Venezuela: Tel: 0-800-100-9123. Mattel Argentina, S.A., Av. Libertador 1000, Piso 11 - Oficinas 109 y 111, Vicente López - Prov. Buenos Aires. Tels: 0800-666-3373. Mattel Colombia, S.A., Calle 123#47-07 P5, Bogotá. Tel: 01-800-710-2069. Mattel Perú, S.A., Av. Juan de Arona # 151, Centro Empresarial Juan de Arona, Torre C, Piso 7, Oficina 704, San Isidro, Lima 27, Perú. RUC: 20425853865. Reg. Importador: 02350-12-JUE-DIGESA. Tel: 0800-54744. E-mail Latinoamérica: servicio.clientes@mattel.com. Mattel do Brasil Ltda. - CNPJ: 54.558.002/0001-20 - Rua Verbo Divino, 1488 - 2ª. Andar - 04719-904 - Chácara Santo Antônio - São Paulo - SP - Brasil. Serviço de Atendimento ao Consumidor: fone 0800 575 0780. E-mail: sac.matteldobrazil@mattel.com

**⚠ WARNING: Small parts, ADVERTENCIA: PELIGRO DE ATRAGANTAMIENTO. Juguete no recomendado para menores de 3 años, porque contiene piezas pequeñas que podrían provocar asfixia en caso de ser ingeridas o inhaladas por el/la niño/a, AVVERTENZA: Piccole parti, ACHTUNG: Kleine Teile, OSTRZEŻENIE: Małe części, WAARSCHUWING: Kleine onderdelen, ПРЕДУПРЕЖДЕНИЕ: Мелкие детали, ADVARSEL: Små dele, WARNING: Små delar, ADVARSEL: Små deler, VAROITUS: Pieniä osia, ΠΡΟΕΙΔΟΠΟΙΗΣΗ: Μικρά κομμάτια, UYARI: Küçük parçalar, UPOZORNĚNÍ: Malé části, UPOZORNENIE: Malé časti, FIGYELMEZTETÉS: Kis alkatrészek.**

**ATTENTION : PETITS ÉLÉMENTS.****ATENÇÃO!****NÃO INDICADO / NÃO RECOMENDÁVEL PARA CRIANÇAS MENORES DE 3 (TRÊS) ANOS POR CONTER PARTE(S) PEQUENA(S) QUE PODE(M) SER ENGOLIDA(S) OU ASPIRADA(S) PODENDO PROVOCAR ASFIXIA.**

警告: のどにつまる危険 小さな部品が含まれています 3歳以下の子供には与えないで下さい。

**警告! 不适合3岁以下儿童使用。内含小零件。**

تحذير: قطع صغيرة.

P D781,964, D797,203

# DISCOVER A WORLD OF UNLIMITED STORYTELLING WITH BARBIE® BUILDING SETS

## DÉCOUVREZ UN MONDE DE POSSIBILITÉS INFINIES AVEC LES COFFRETS DE CONSTRUCTION BARBIE



DESCUBRE UN MUNDO DE AVENTURAS SIN FIN CON LOS CONJUNTOS DE CONSTRUCCIÓN DE BARBIE  
DESCOBRER UM MUNDO DE HISTÓRIAS ILIMITADAS COM OS CONJUNTOS DE CONSTRUÇÃO DA BARBIE  
MIT DEN BARBIE BAUSET EINE WELT VOLLER UNBEGRENZTEM SPIELSPAZ ENTDECKEN  
ОТКРОЙТЕ ДЛЯ СЕБЯ МИР БЕЗГРАНИЧНЫХ ИСТОРИЙ ВМЕСТЕ С НАБОРАМИ КОНСТРУКТОРА БАРБИ

BARBIE® and associated trademarks and trade dress are owned by, and used under license from Mattel.  
©2022 Mattel.

©2022 MEGA Brands &™ MEGA Brands.  
Printed in China / Imprimé en Chine AD-HPN78-01A

Mattel Canada Inc. Mississauga, Ontario L5R 3W2.  
MADE IN CHINA. FABRIQUÉ EN CHINE. FABRICADO NA CHINA. HECHO EN CHINA.  
ИЗГОТОВЛЕНО В КИТАЕ. ÇIN'DE ÜRETİLMİŞTİR. صنع في الصين



HPN78



HPN79



HPN80

Set(s) sold separately and subject to availability. / Ensemble(s) vendu(s) séparément. Certains produits peuvent ne pas être commercialisés. / Se vende(n) por separado y está(n) sujeto(s) a disponibilidad. / Conjunto(s) vendido(s) en separado e sujeito(s) à disponibilidade. / Set in vendita separatamente, secondo disponibilità. / Das/Die Set(s) sind separat erhältlich. / Zestaw(y) sprzedawany(e) oddzielnie w zależności od dostępności. / Set(s) apart verkrijgbaar en afhankelijk van beschikbaarheid. / Набор(-ы) продаются отдельно, при наличии. / Sæt sælges separat og så længe lager haves. / Seten säljs separat så länge lagret räcker. / Settet/settene selges separat så langt lageret rekker. / Pakkaus/pakkaukset myydään erikseen, saatavuus voi vaihdella. / Το(α) σετ πωλούνται ξεχωριστά και ανάλογα με τη διαθεσιμότητα. / Setler ayrı olarak satılır ve stoklarla sınırlıdır. / Set (sety) se prodává (prodávají) samostatně dle aktuální nabídky. / Súprava/-y sa predáva(jú) samostatne a podľa dostupnosti. / A készlet(ek) külön kapható(k), az elérhetőség változhat. / セット商品は別売りになります。在庫状況は別途ご確認をお願いします。  
تباع المجموعة أو المجموعات على حدة وتخضع لتوافرها.  
每套单独发售，按供货情况决定。

