

MEGA

POKÉMON



HNT95

**MAGIKARP EVOLUTION SET
COFFRET ÉVOLUTION MAGICARPE**

CONJUNTO DE EVOLUCIÓN DE MAGIKARP / CONJUNTO DE EVOLUÇÃO DO MAGIKARP
KARPADOR EVOLUTIONSSET / НАБОР "ЭВОЛЮЦИЯ MAGIKARP"



Build Construisez

Construye
Constrói
Bauen
Стройте



Share Partagez

Comparte | Partilha
Teilen | Делитесь

Device not included | Appareil non inclus
Dispositivo no incluído | Dispositivo não incluído
Gerät nicht enthalten | Устройство не входит в комплект



megaunboxed.com



1

1x 1x 1x 1x

2

1x 1x 2x

1

2

3

1x 1x 2x

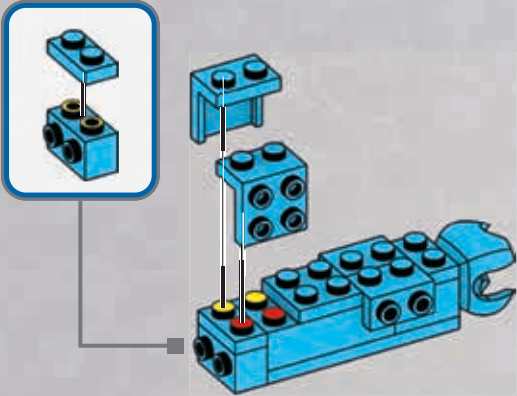

4

1x 1x

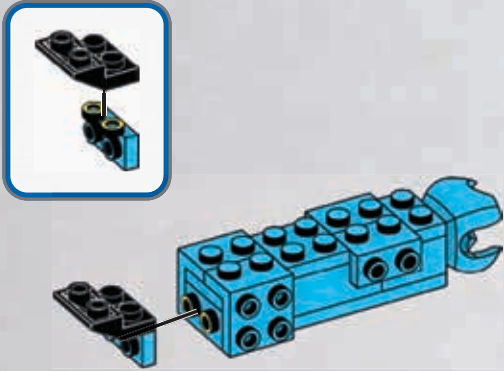

5

2x

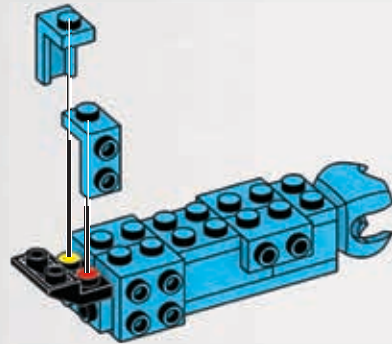

6

4x

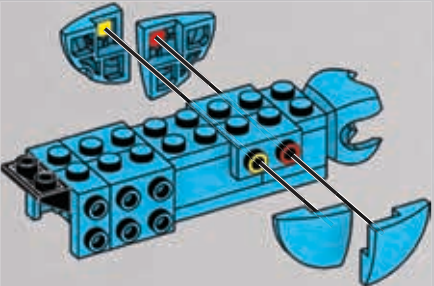

7

1x 2x

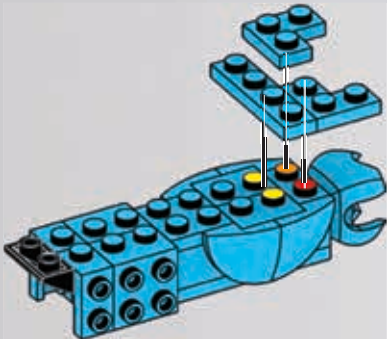

8

2x

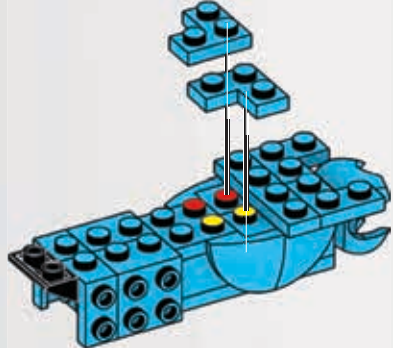

9

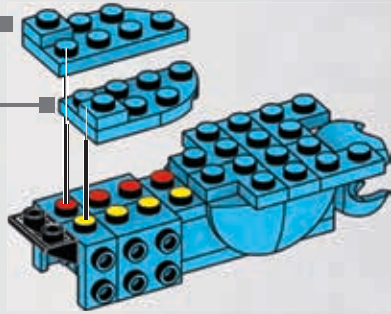
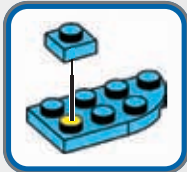
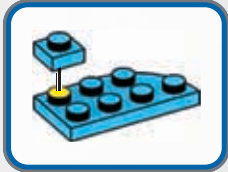

10

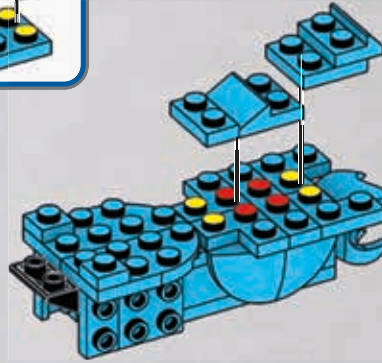
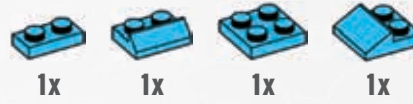

11

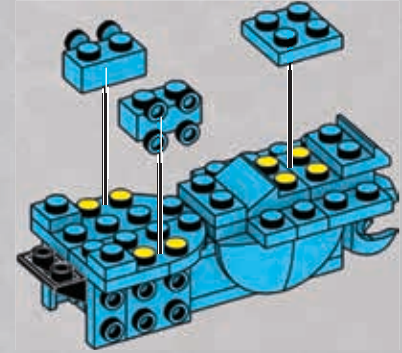
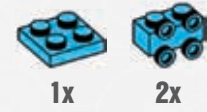

12

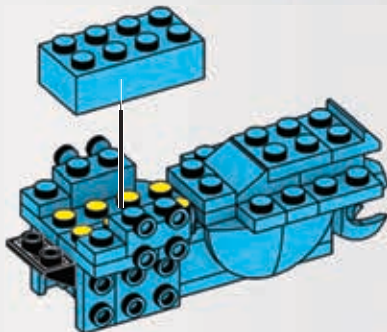
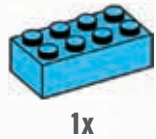

13

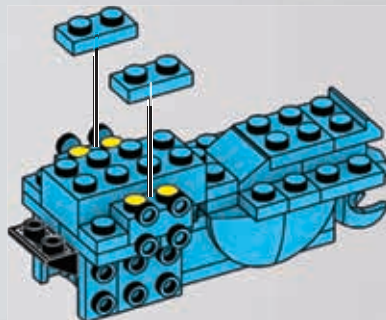

14

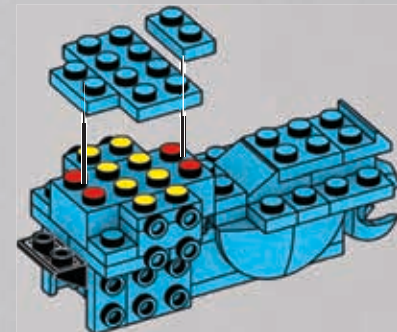

15



1x



1x

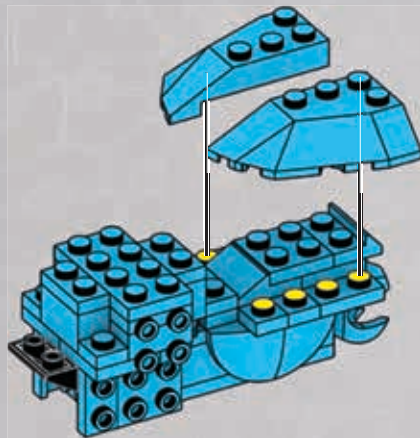

16



1x



1x

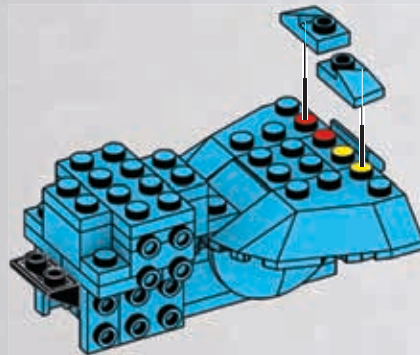

17



1x



1x

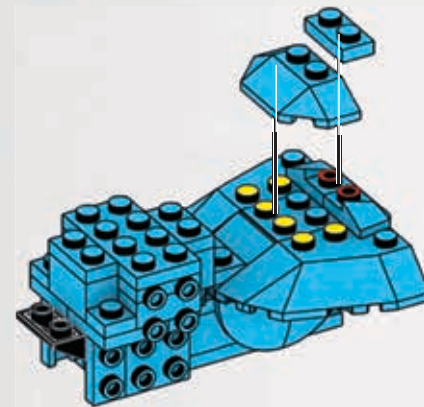

18



2x

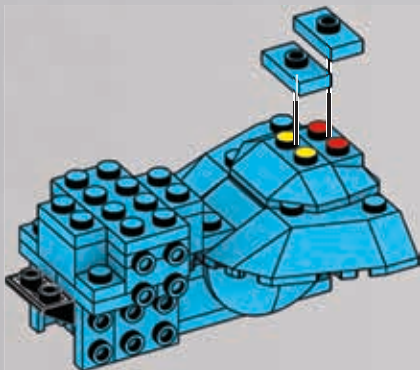

19



1x



1x



2x



1x



1



2



3

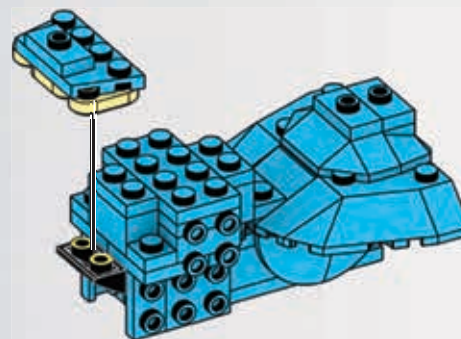

20

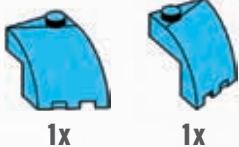

1x

1x

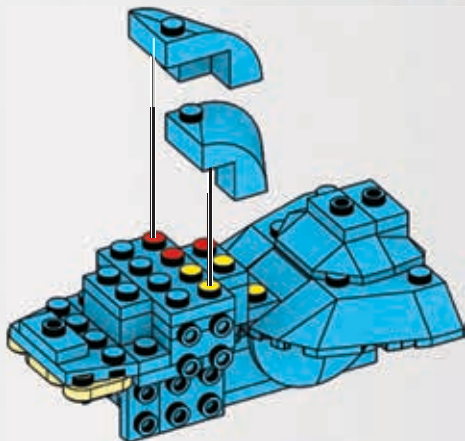

21



1x

1x

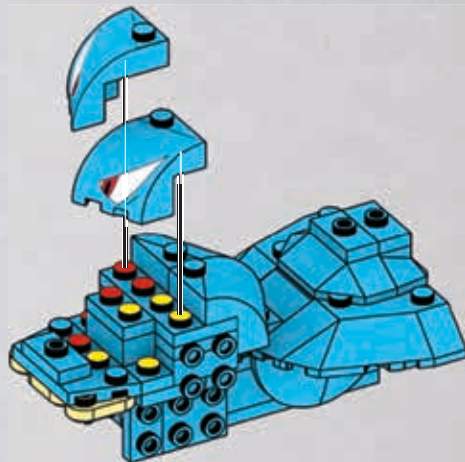

1

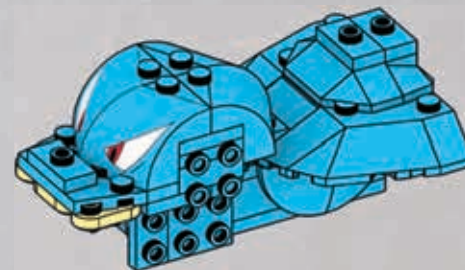

2

22



1x

2x

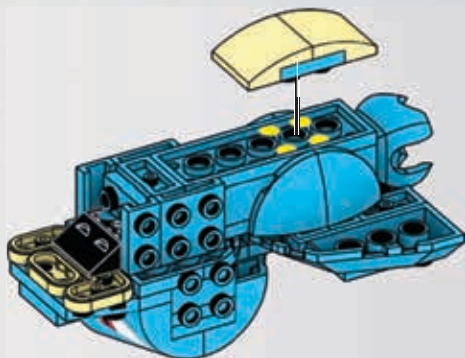
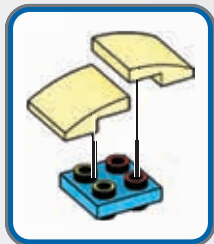

23



2x

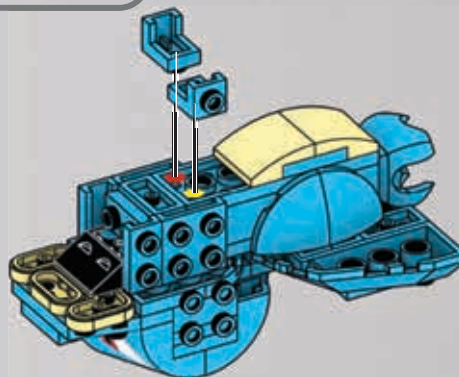

24

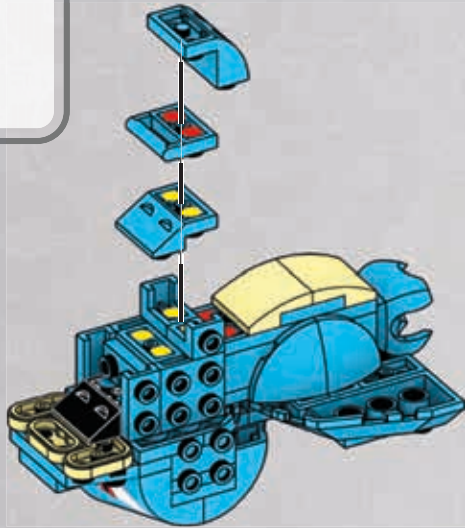
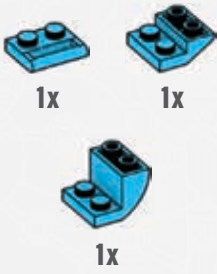

25

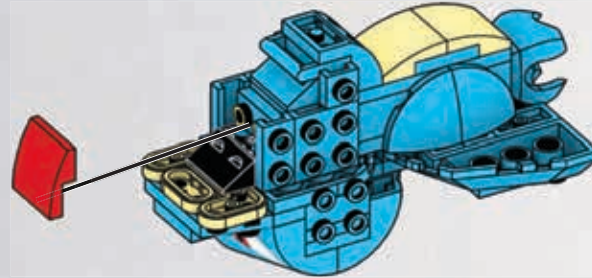

26

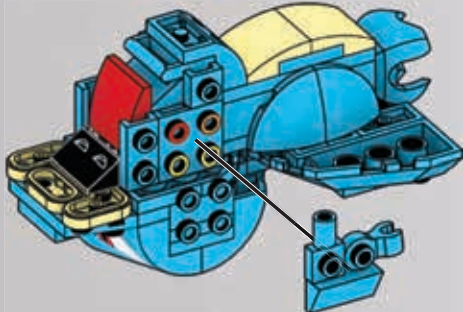
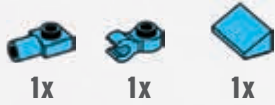

27

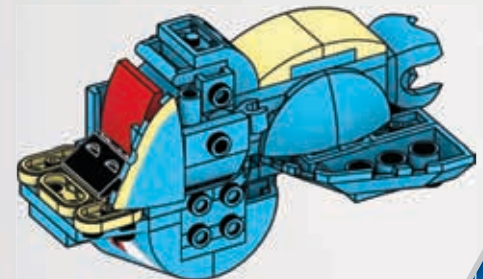
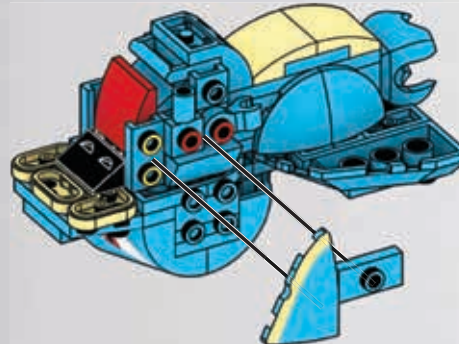

1

2



28

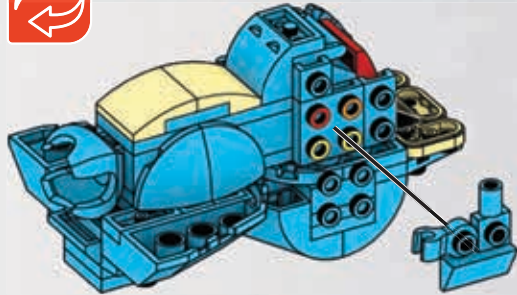
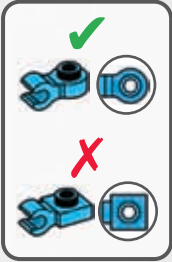
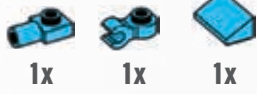

29

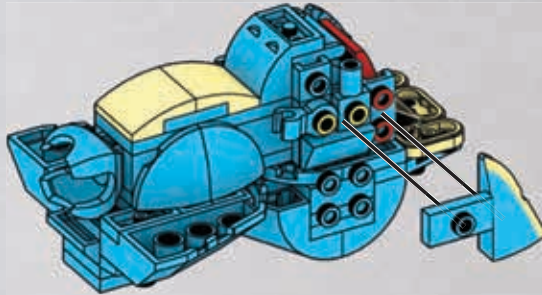

1

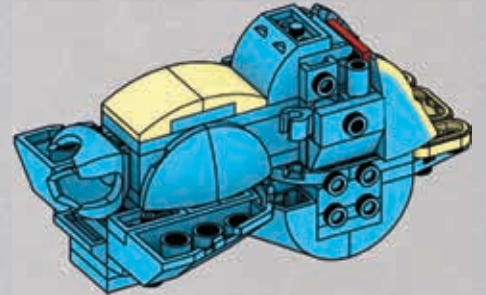

2

30

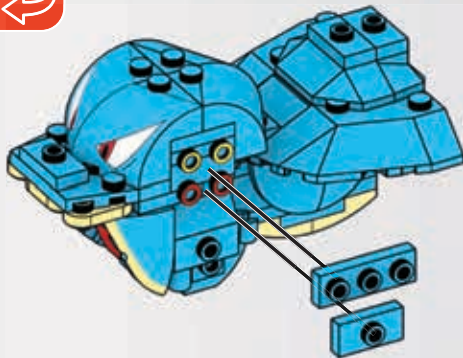

31

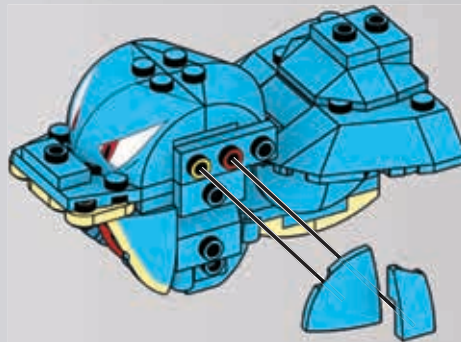

1

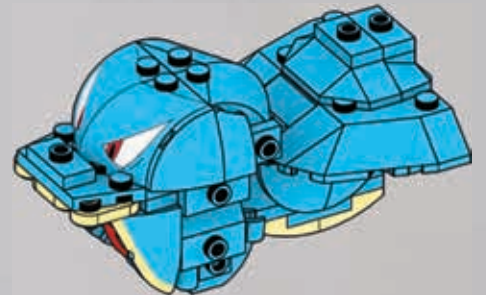

2

32

1x 1x

33

1x 1x

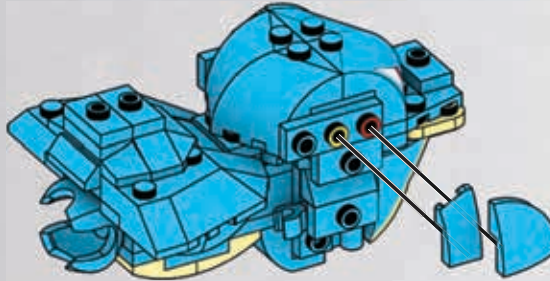
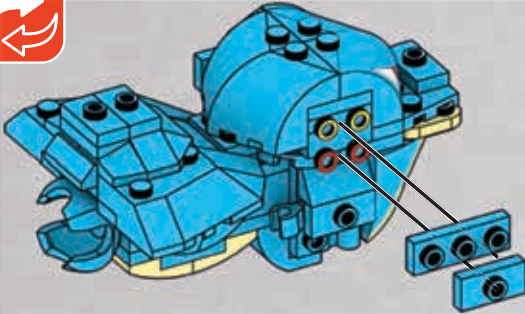

1

2

34

1x 1x

35

2x

3

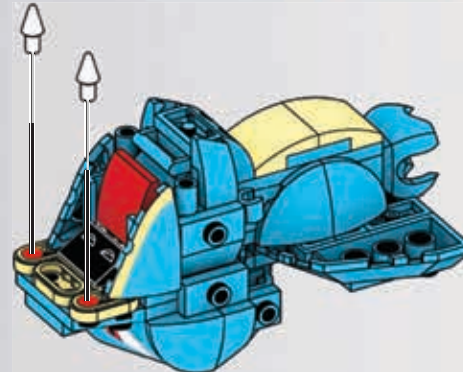
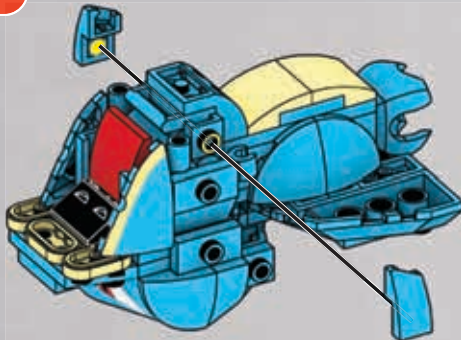

36

2x

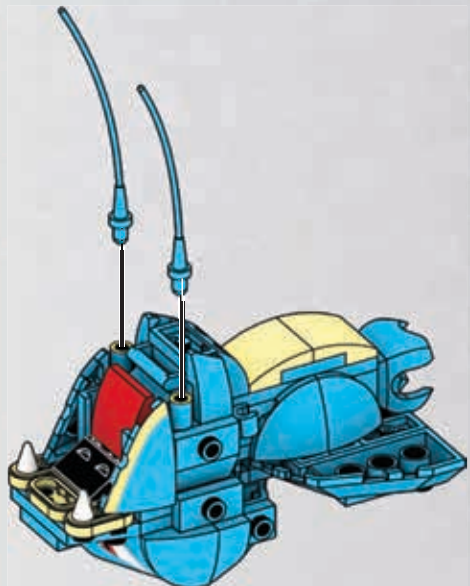

37

2x 1x 1x 1x 2x

1

2

3

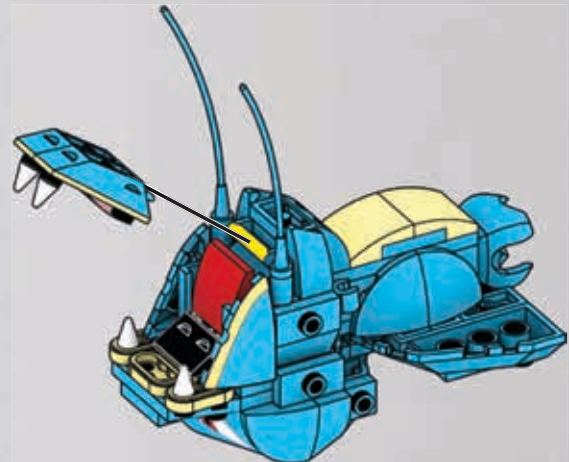

1

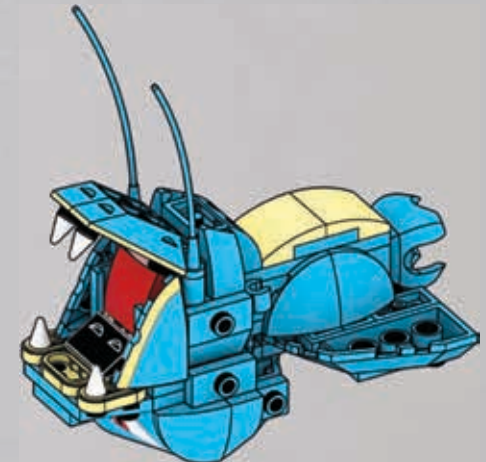

2



38

1x  1x  1x  

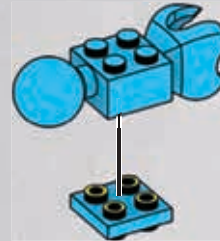
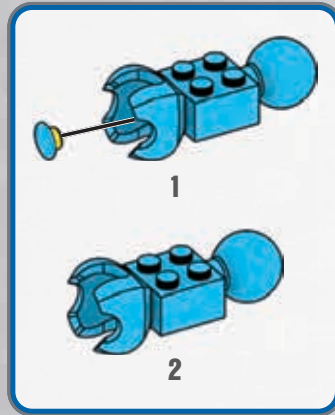

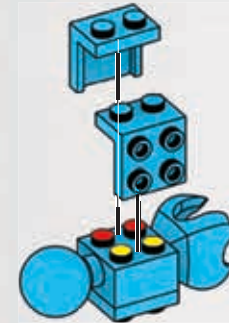

39

2x 



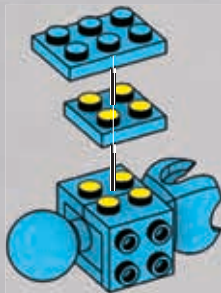

40

1x  1x 





41

2x  1x 



42

1x  2x 

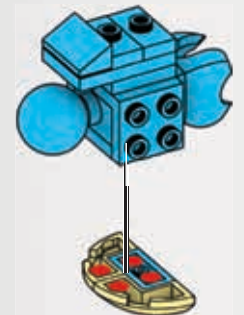
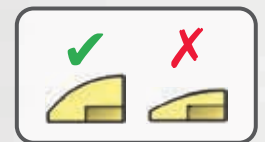
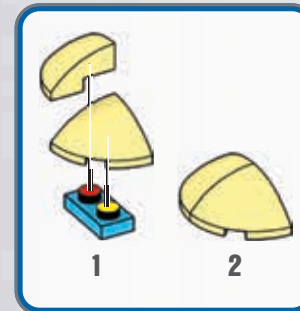

43



2x

2x



x2

1

2

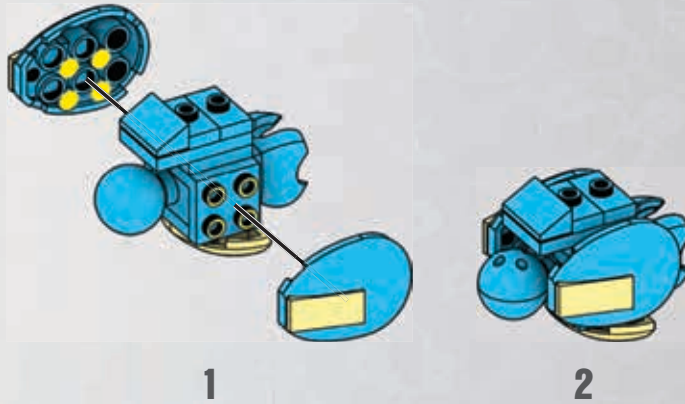

1

2

44

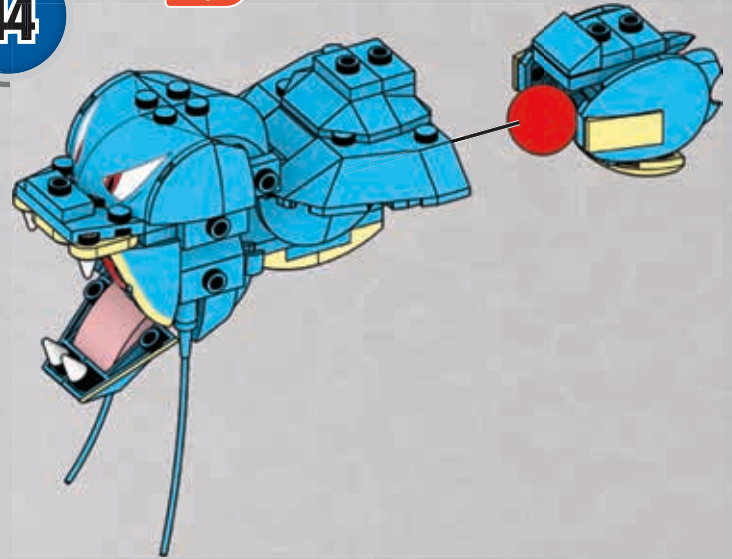

45



3x

1x

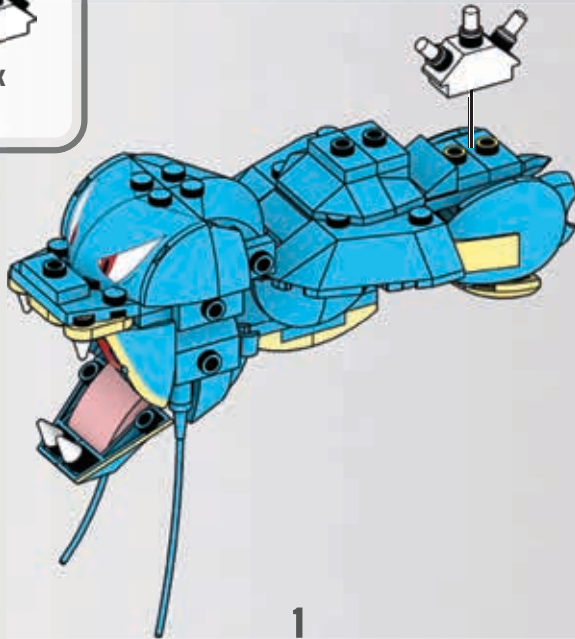
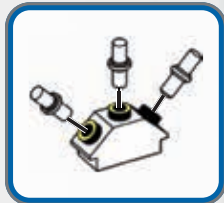

1

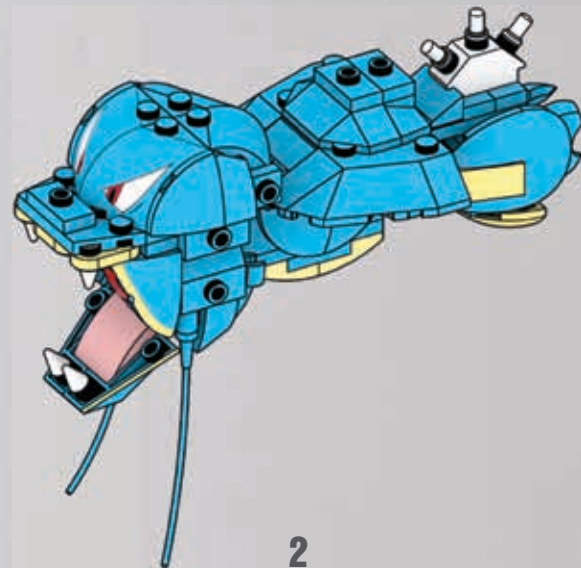

2

46 → 50
x3

46

1x 1x 1x

47

2x

48

2x 1x

1

2

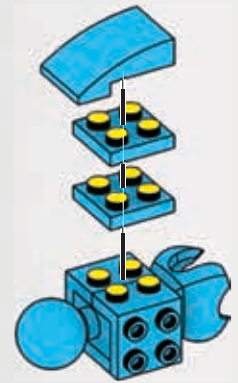
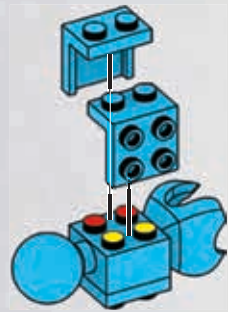

49

1x 2x 2x

✓ X

✓ X

50

2x 2x

1

2

x2

1

2

3

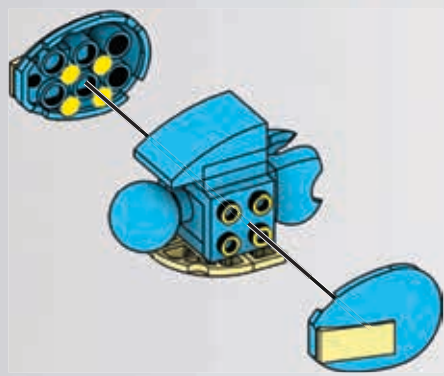
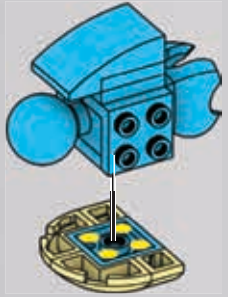

1

2

51

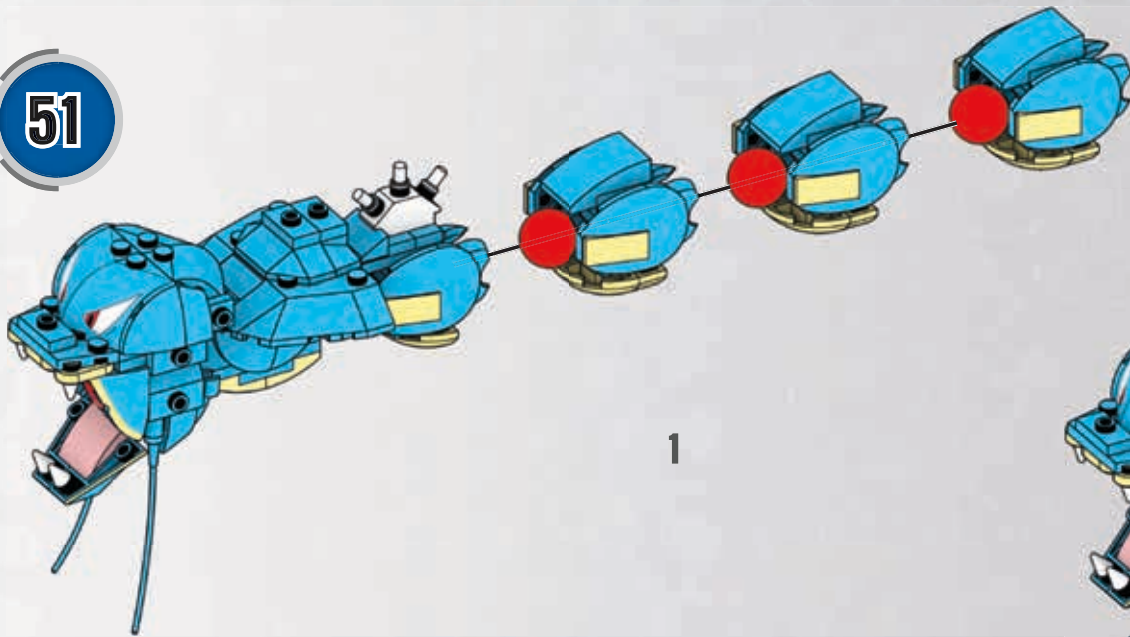

1

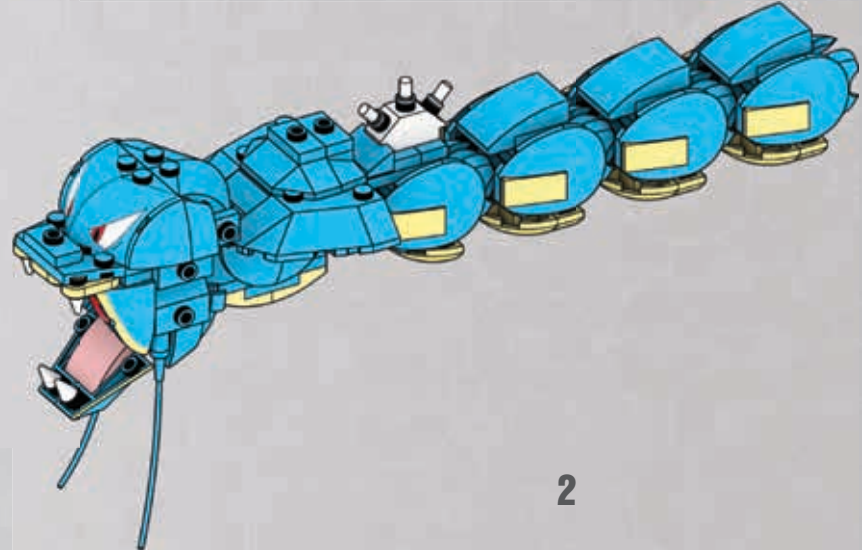

2

52



53



54

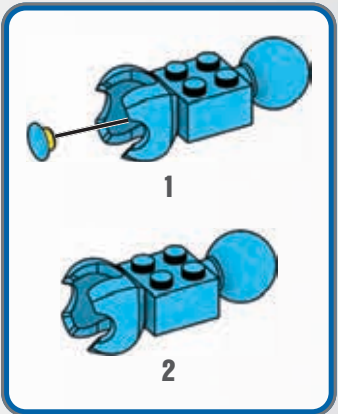

1

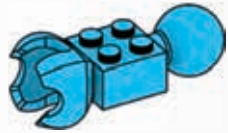

2

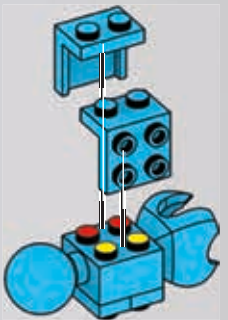
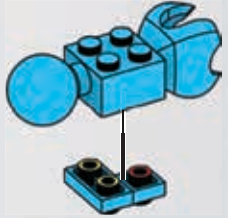

1

2

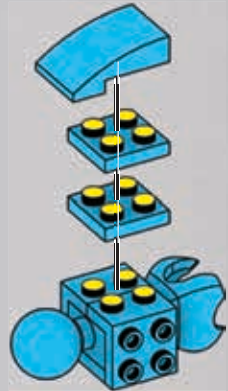

1

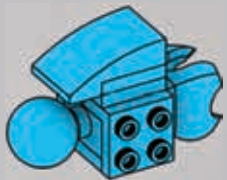

2

56

1x

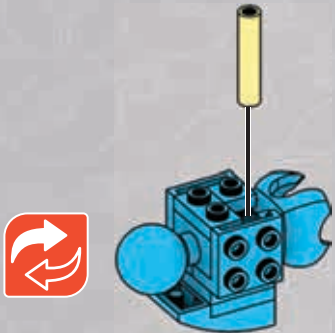
57

1x 1x 2x



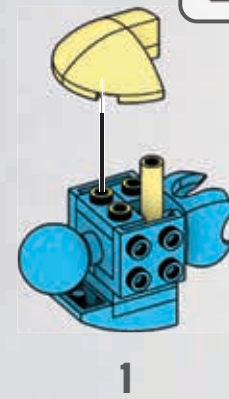
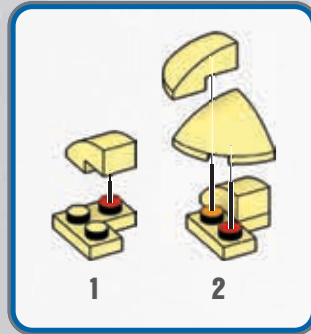
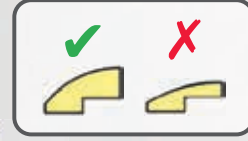
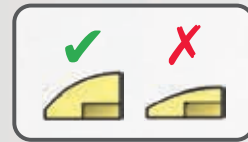

55

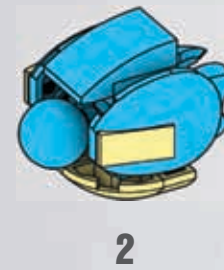
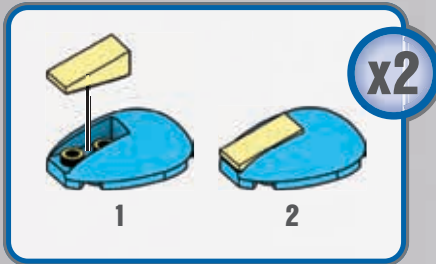
2x 2x

58

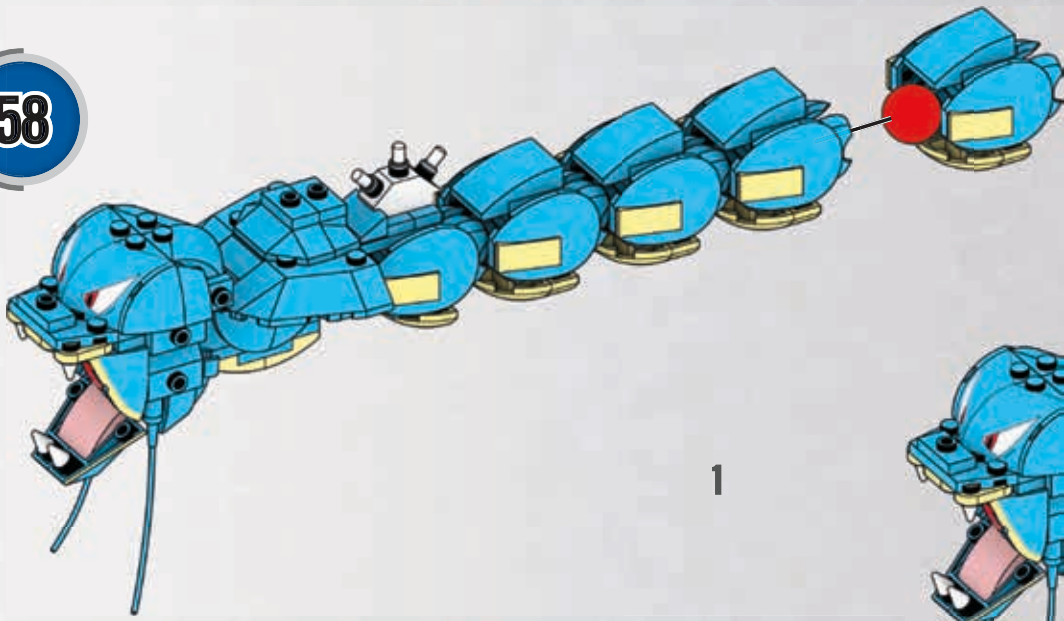

1

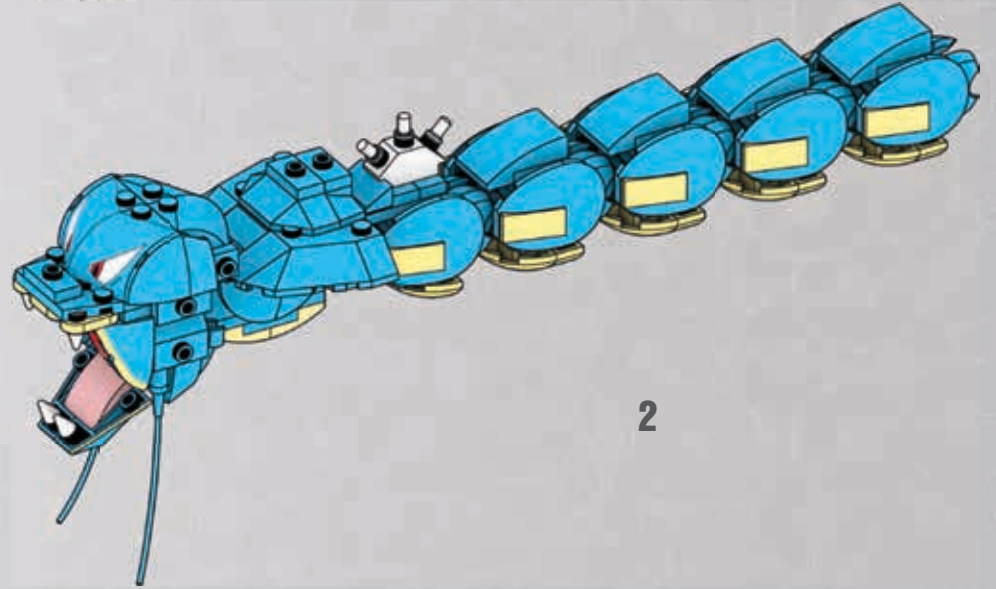

2

59

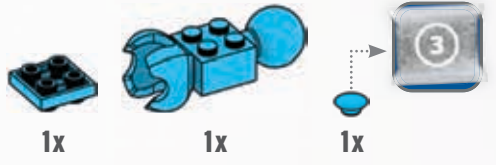

1x

1x

1x

60



2x

61



2x

1x

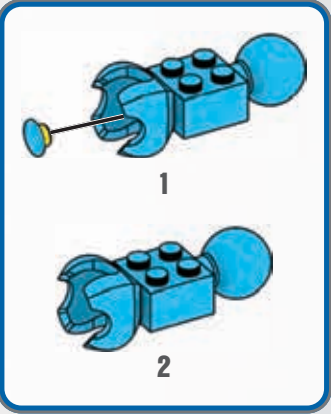

1



2

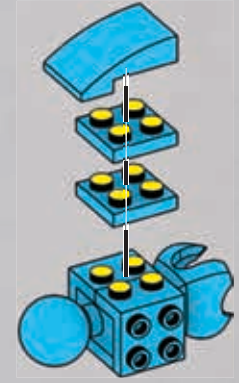
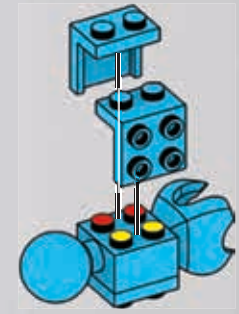

62

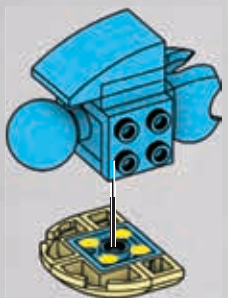
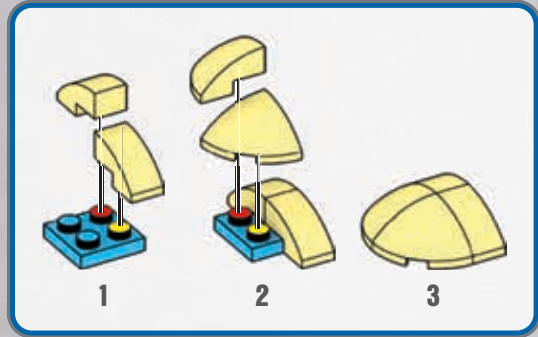
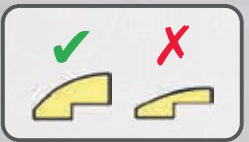
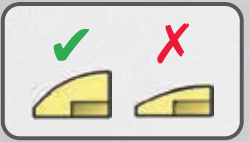

63

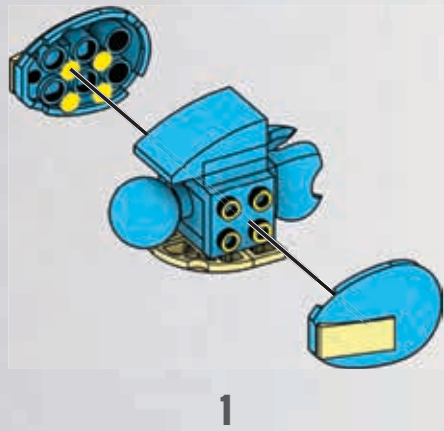
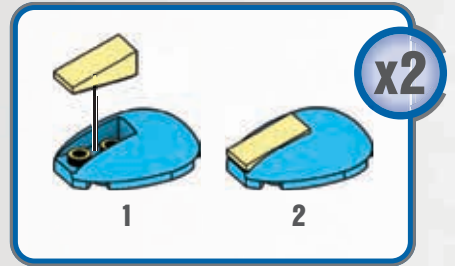

64

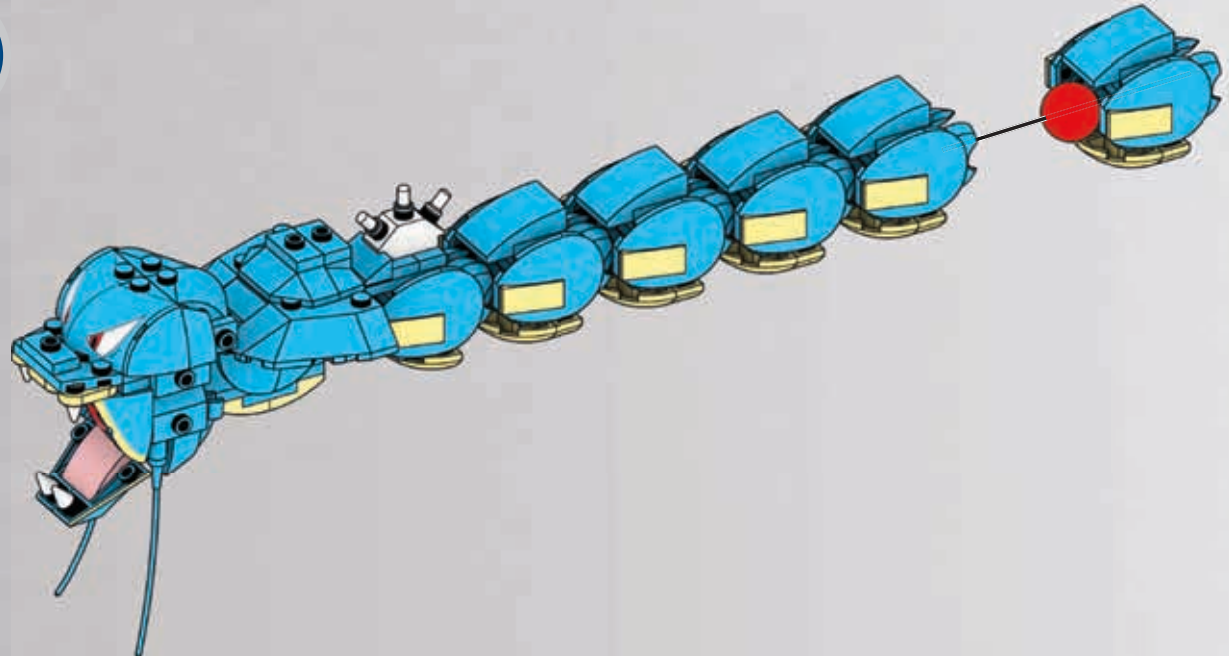

65

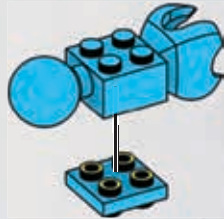
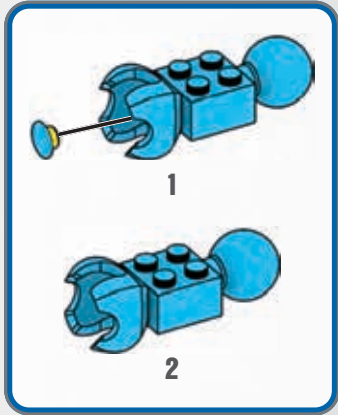
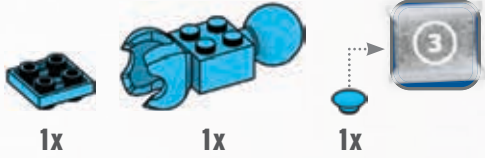

66

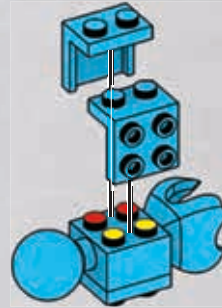

67

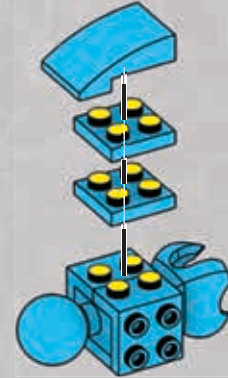

68

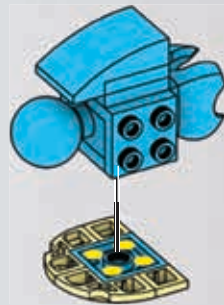
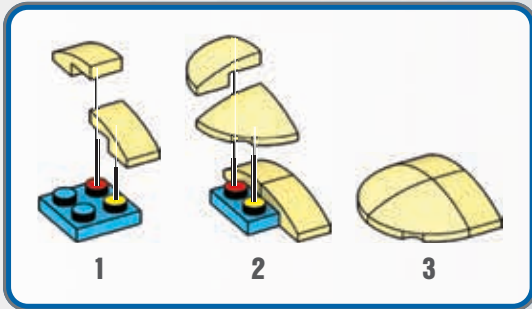
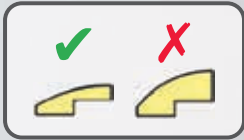
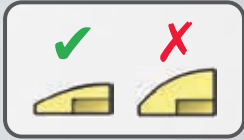

69

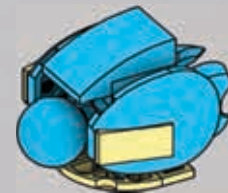
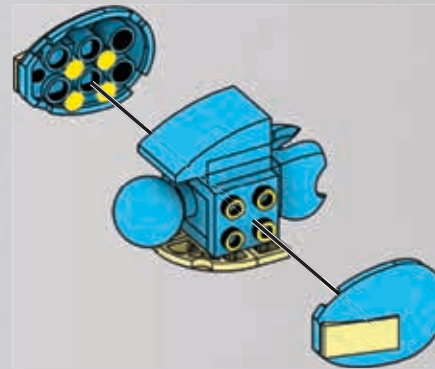
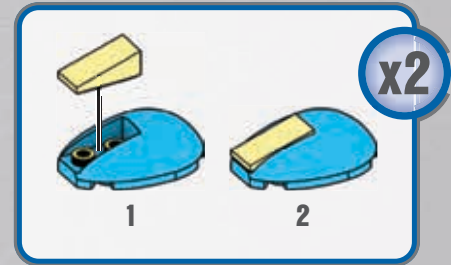
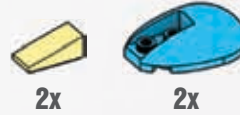

1

2

70

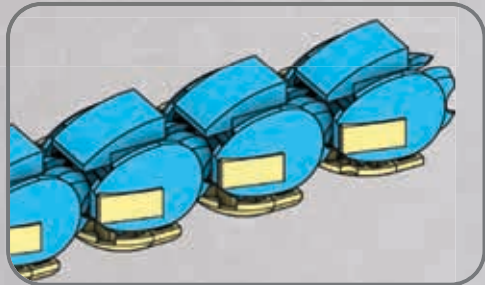
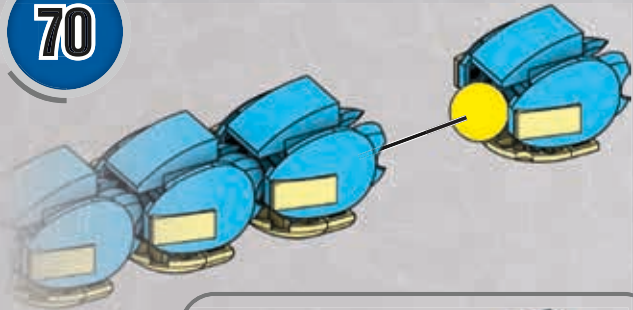

71

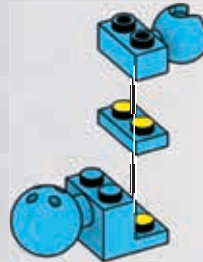

72

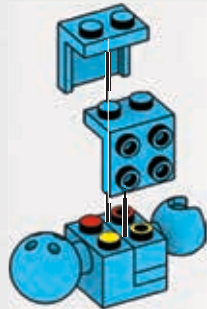

73

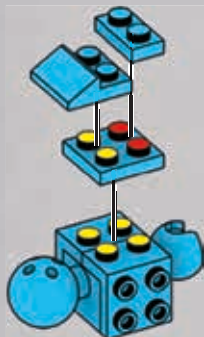

74

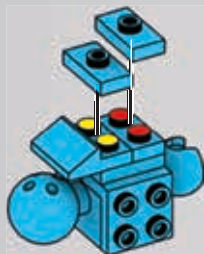

75

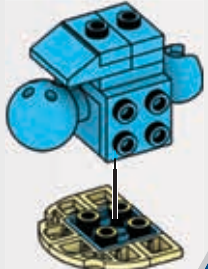
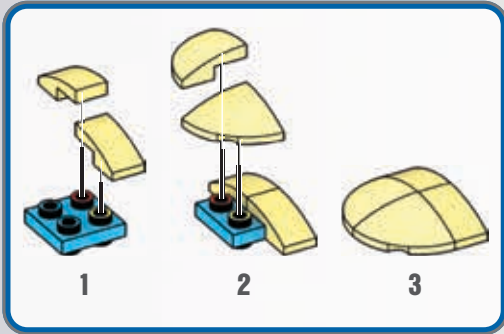

76



2x

2x

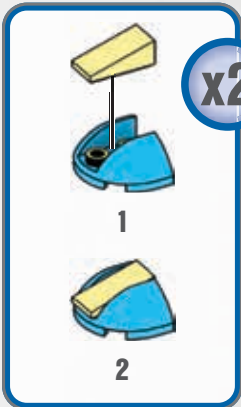

x2

1

2

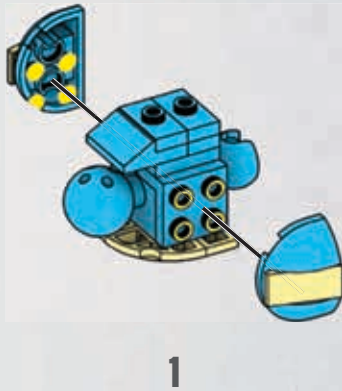

1



2

77

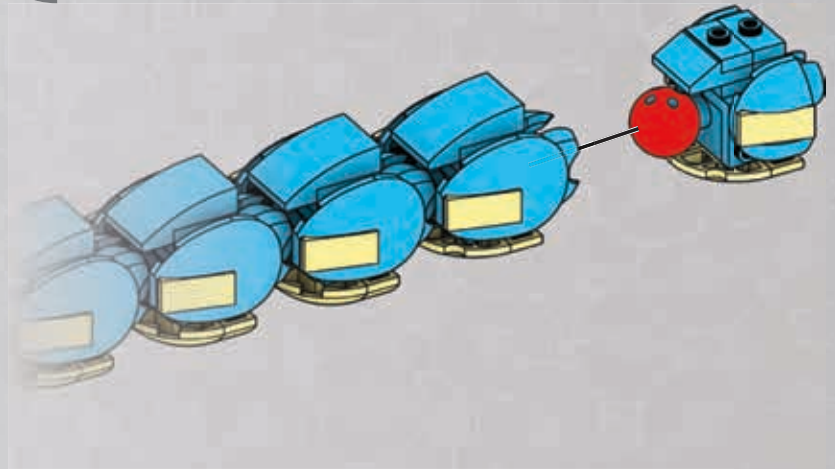

78

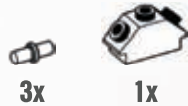

3x

1x

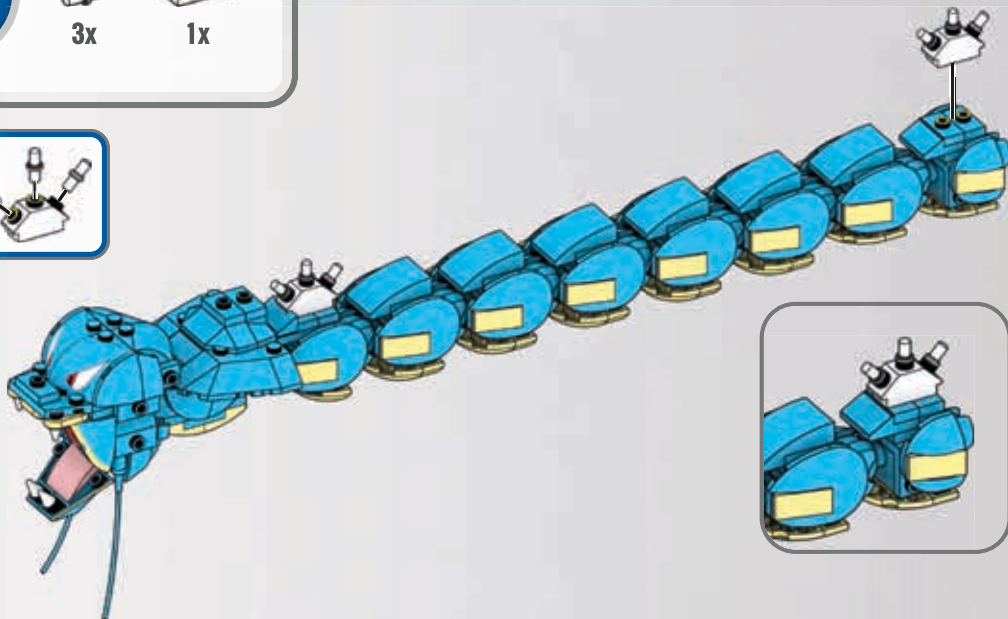

79

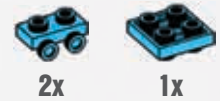

2x

1x

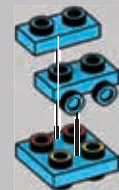

80

1x 1x

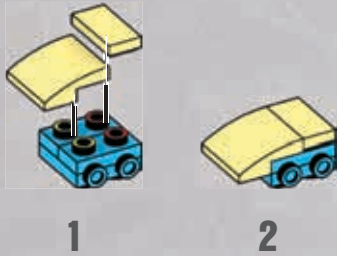

81

1x 1x

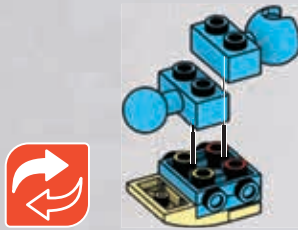

82

2x 1x 1x

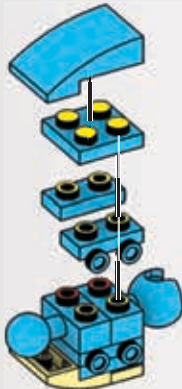

83

2x 2x

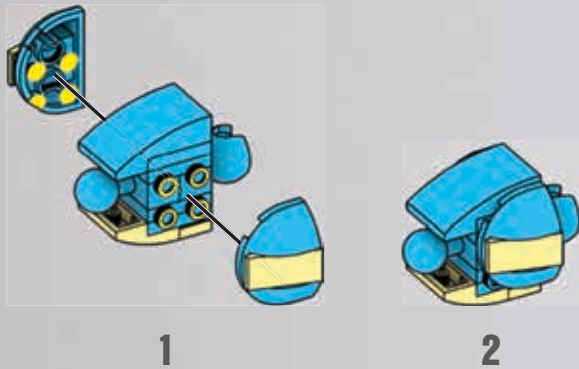
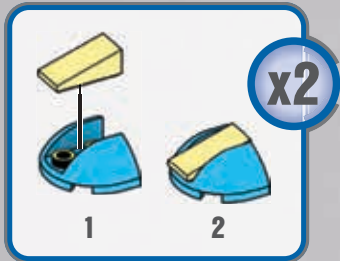

84

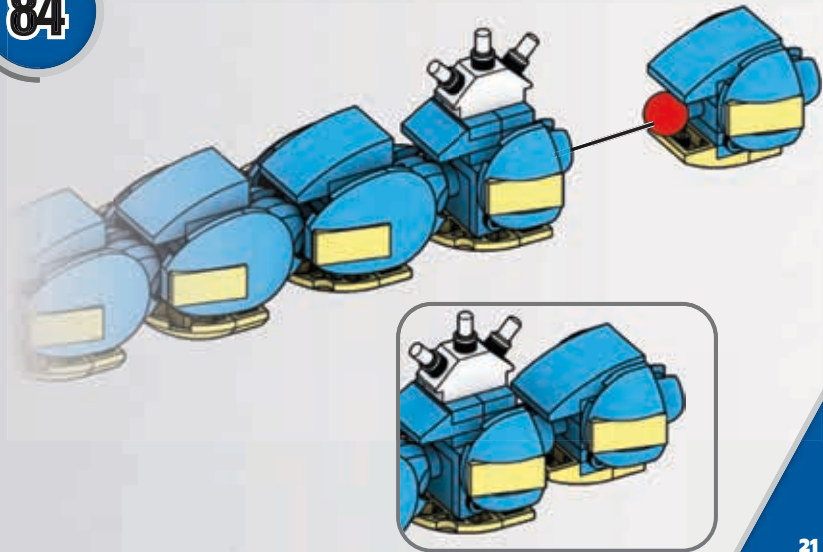

85

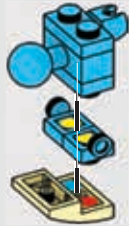
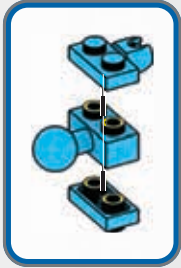
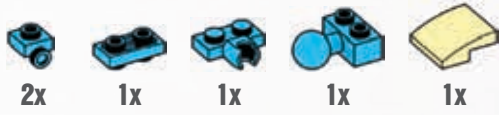

86

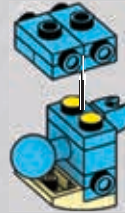
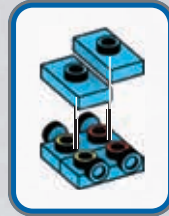
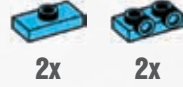

87

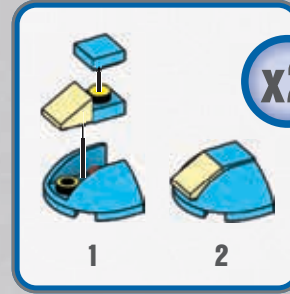
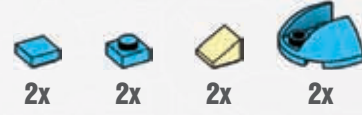

x2

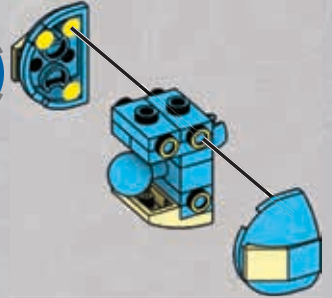

88

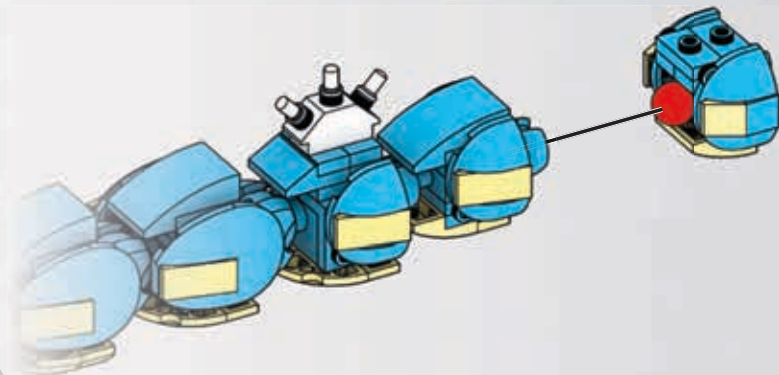

89

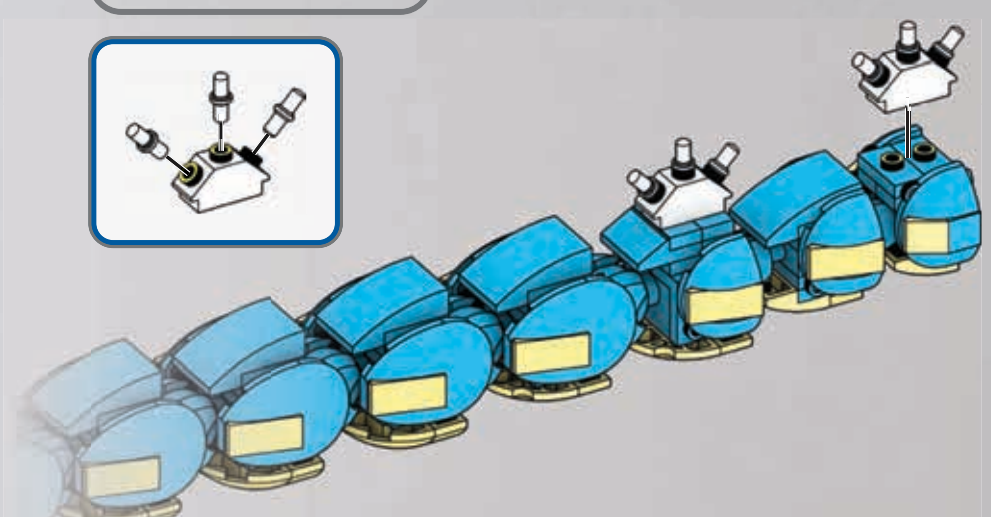
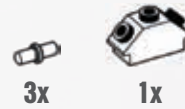

90

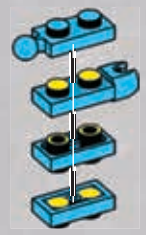

91

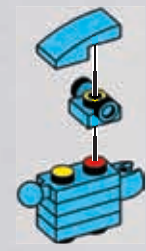
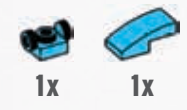

92

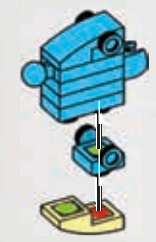
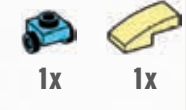

93

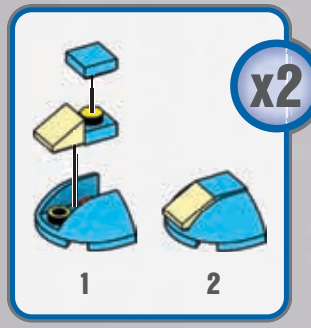
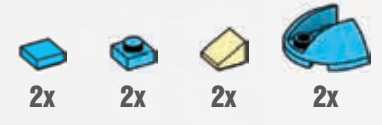

x2

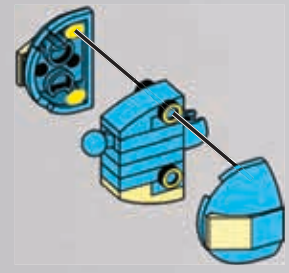

1



2

94

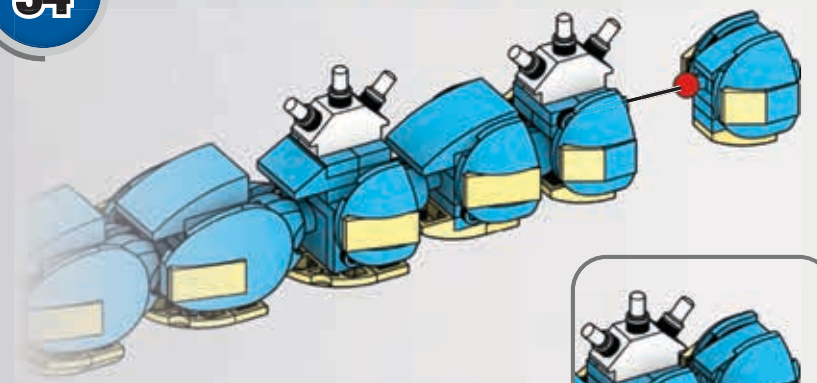

95

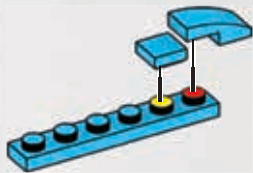

96

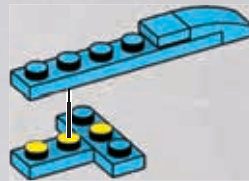

97

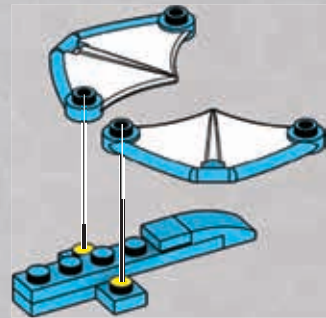
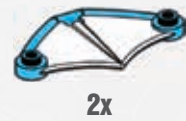

98

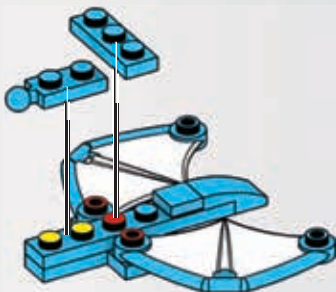

99

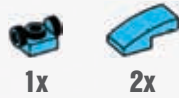

100

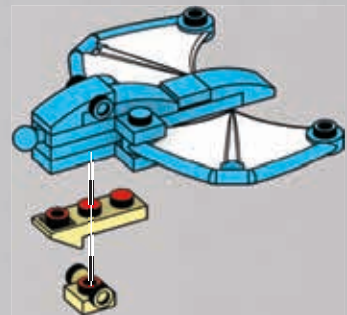
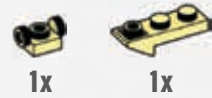

101

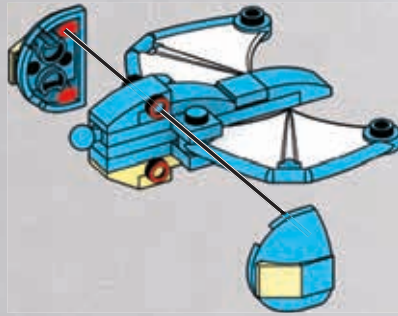
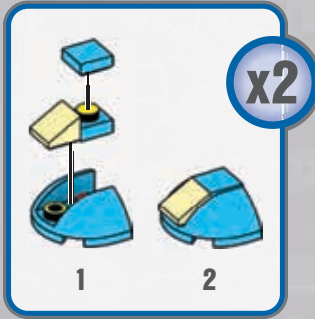
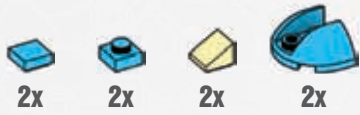

102

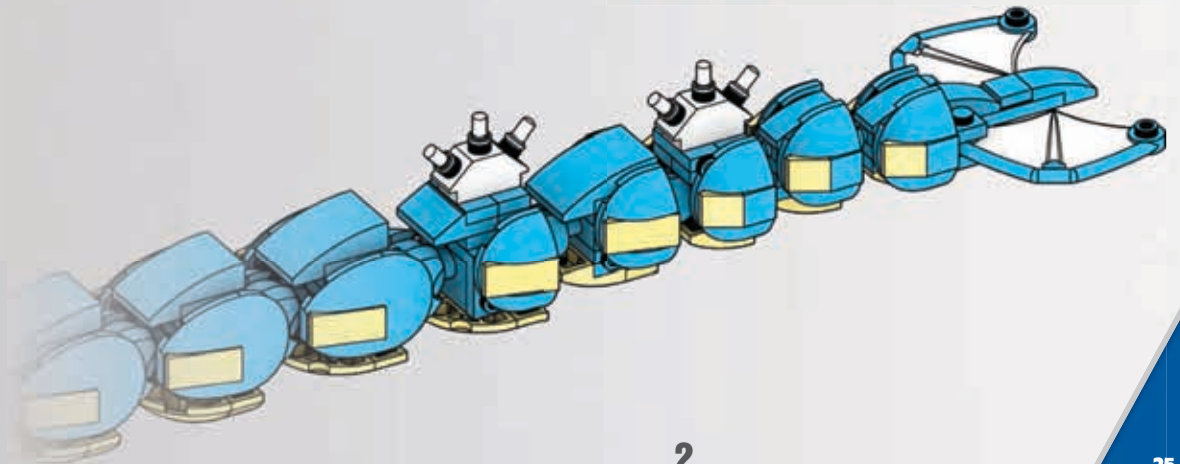
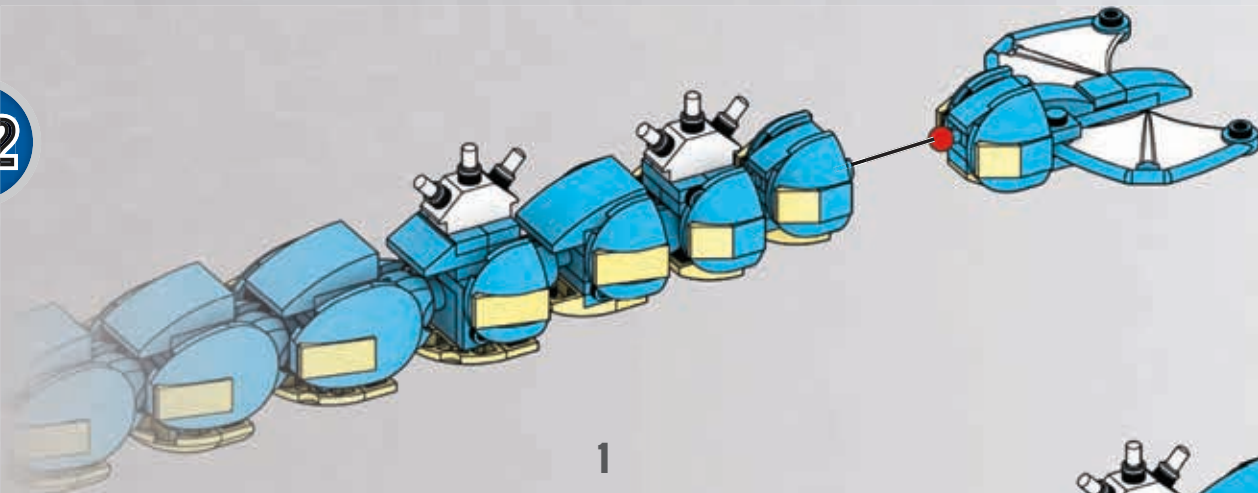

103

3x

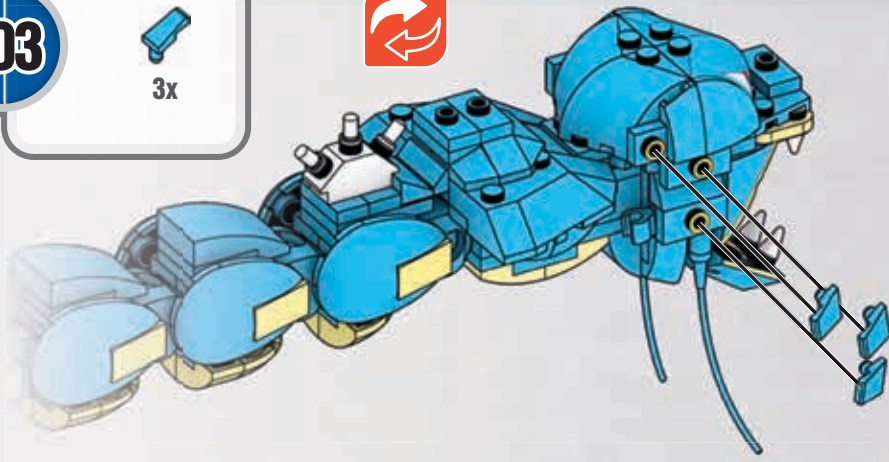

1

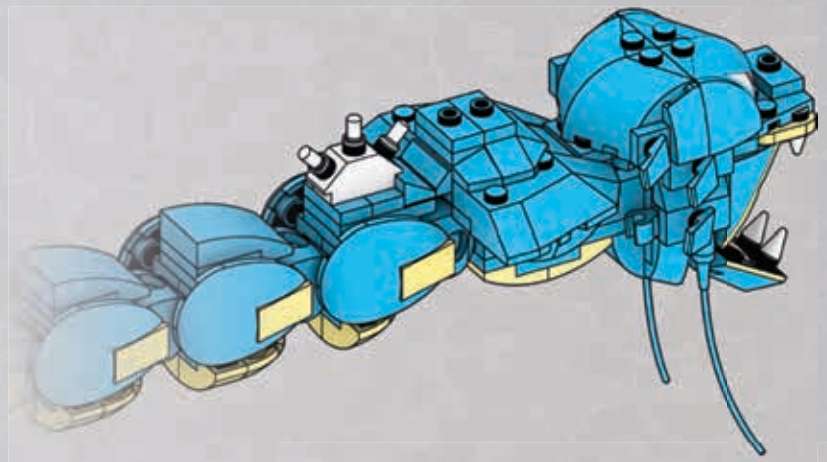

2

104

3x

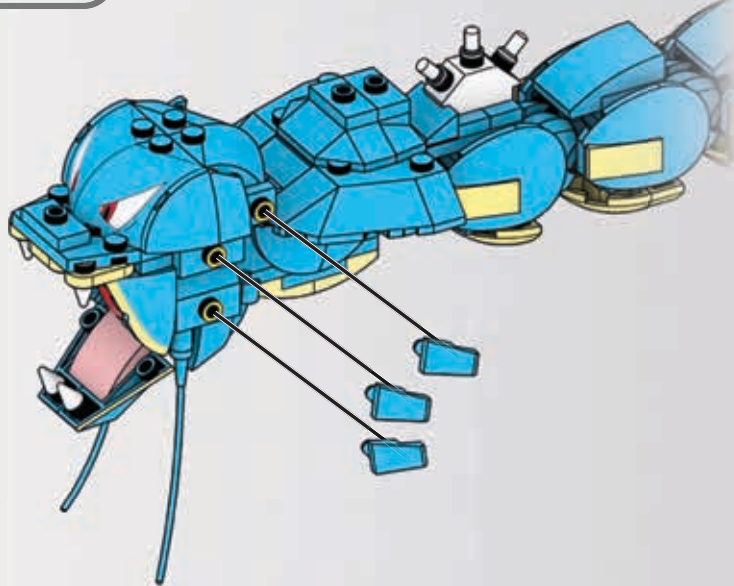

1

105

1x

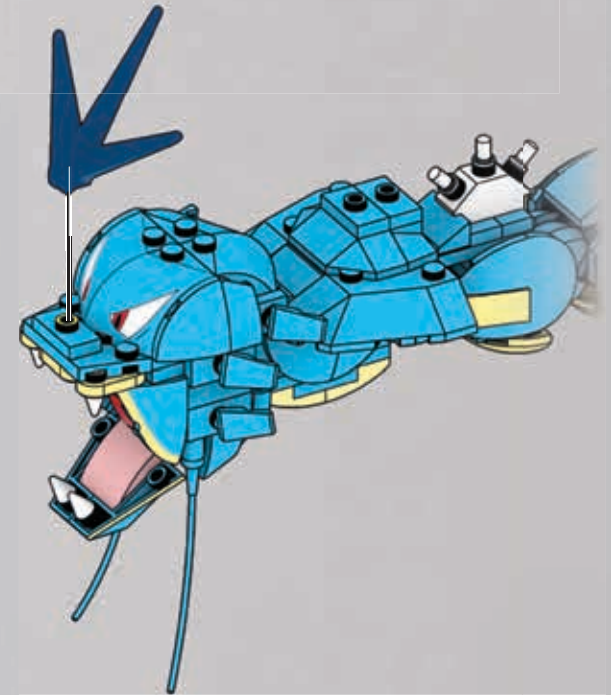

106



1x



1x

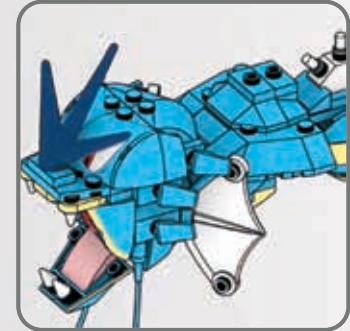
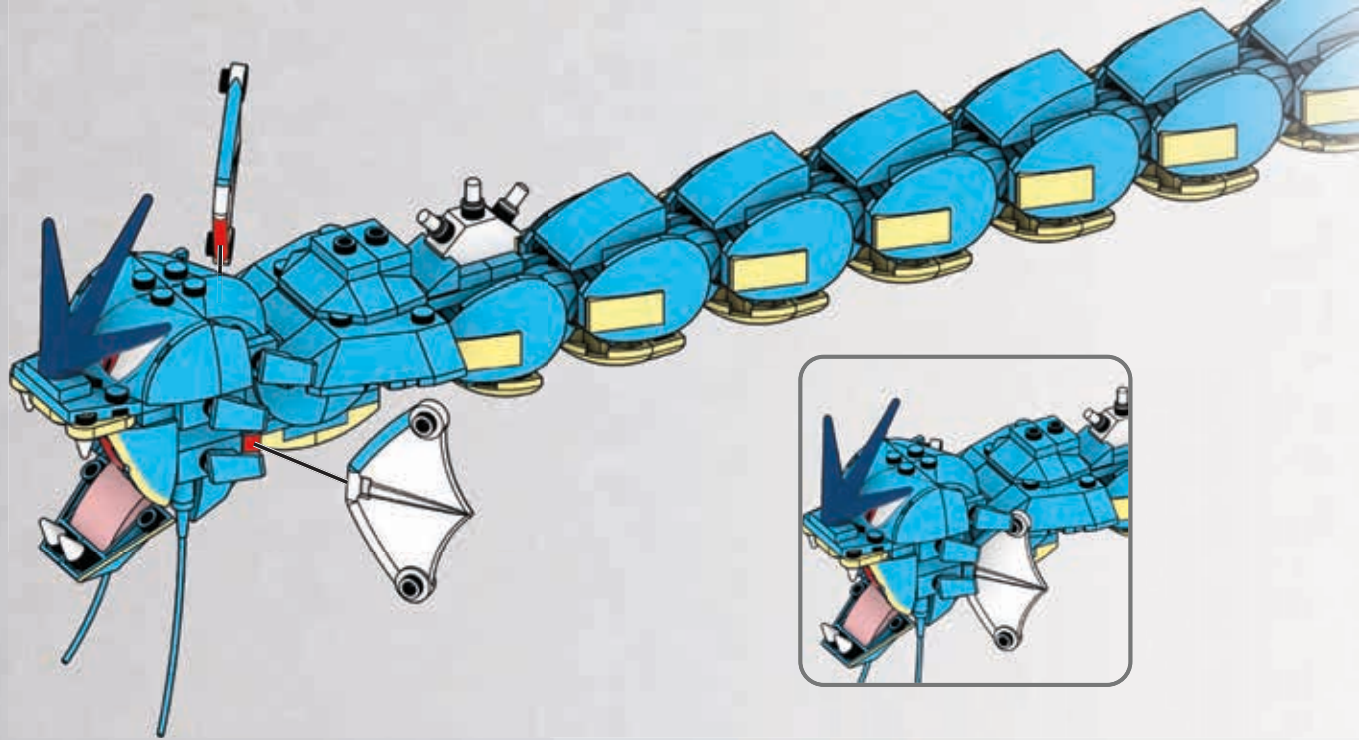

107



1x



108



2x

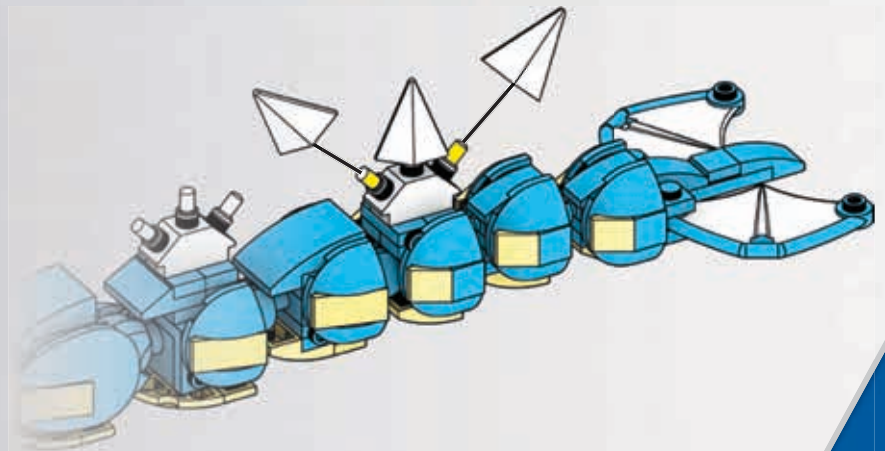
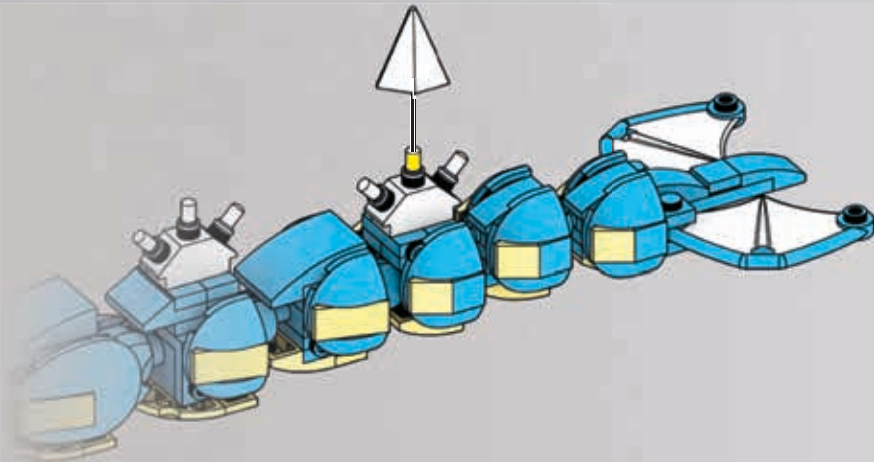

109

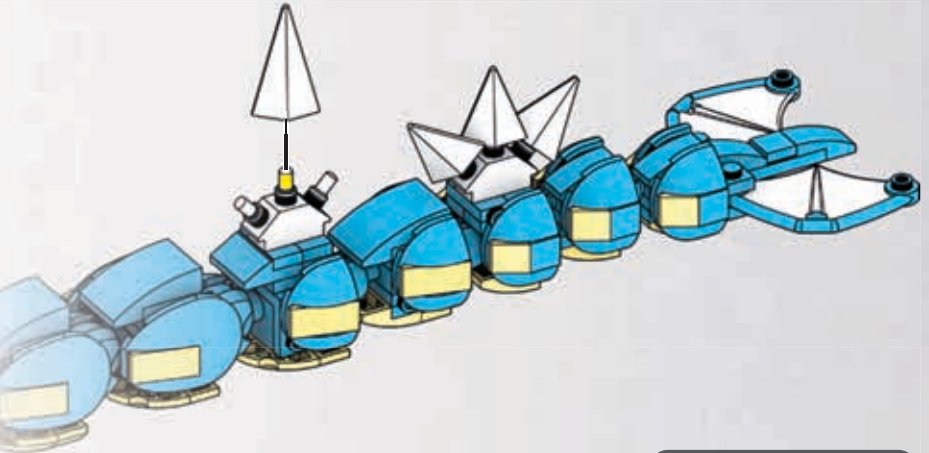
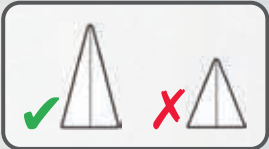

110

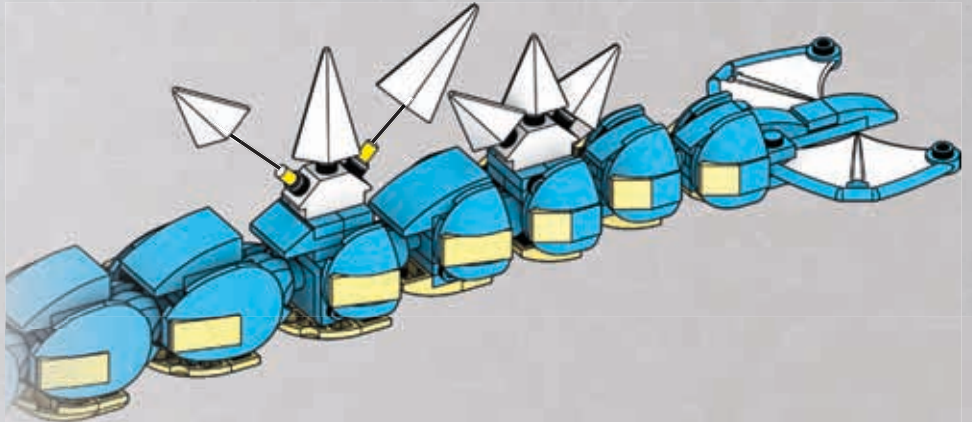
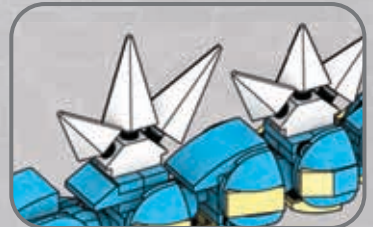

111

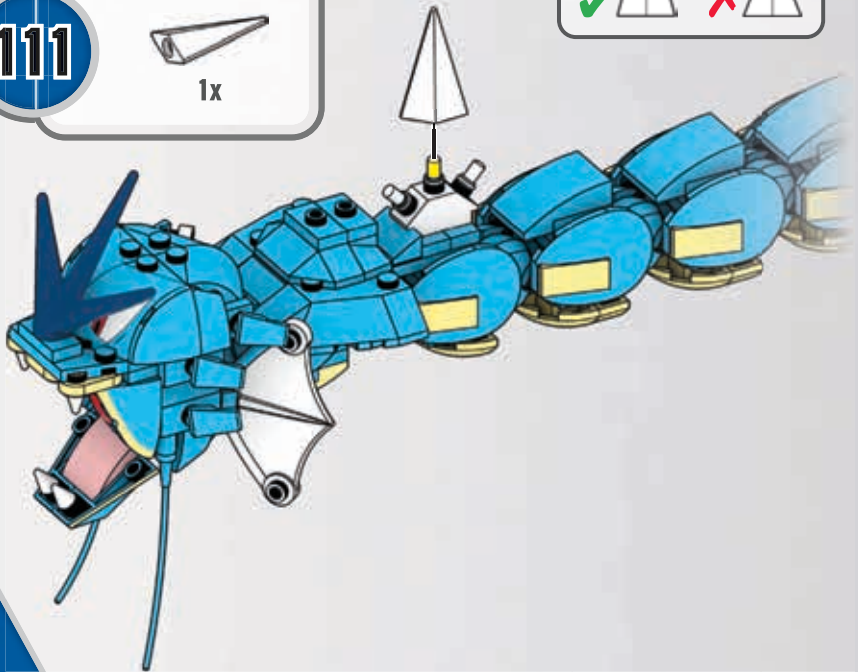
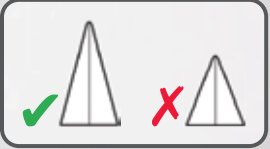

112

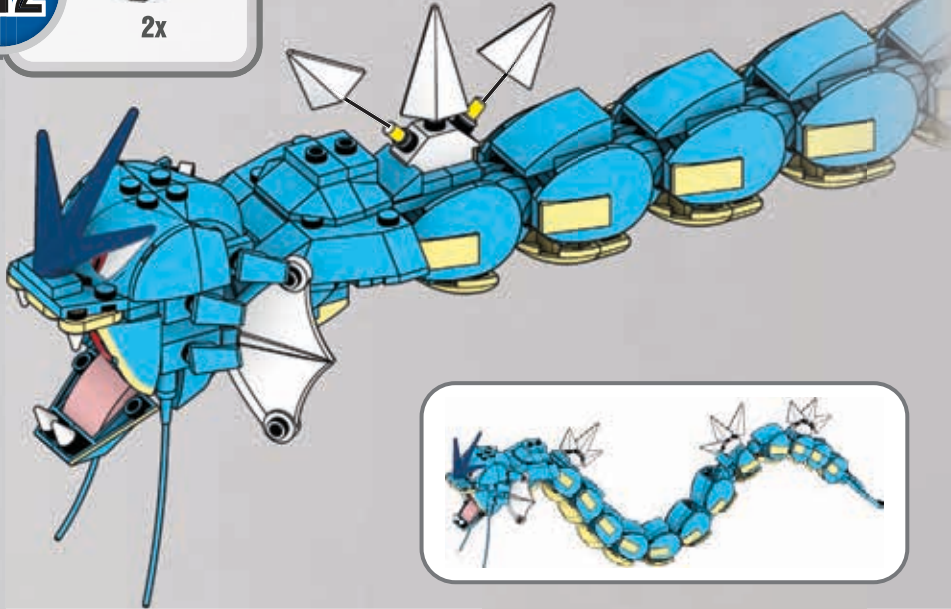
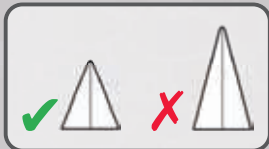

113

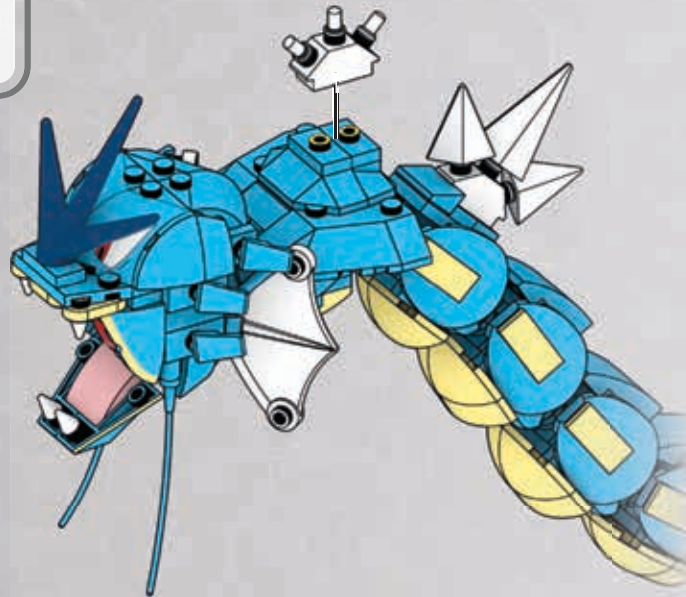

114

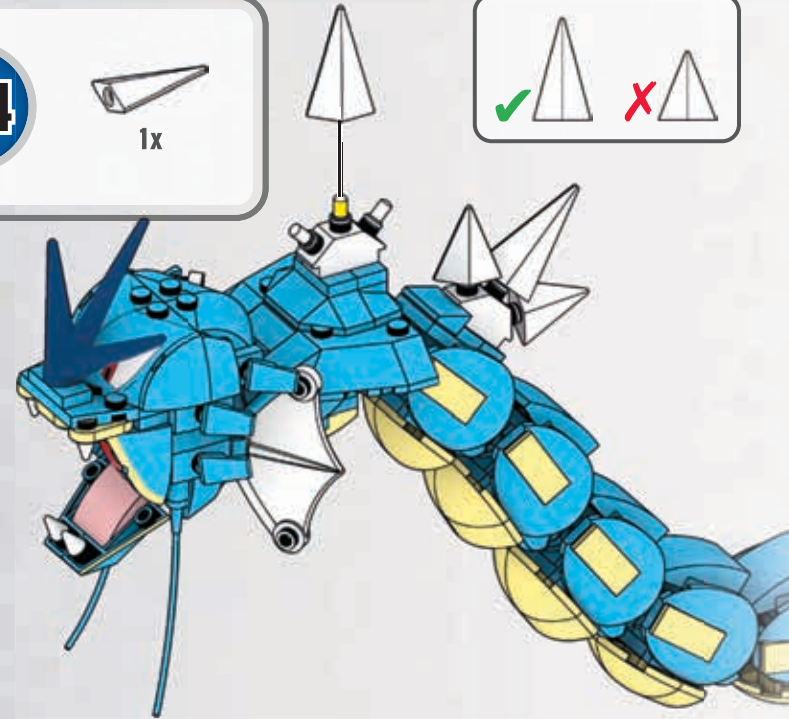
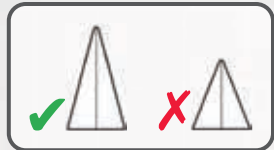

115

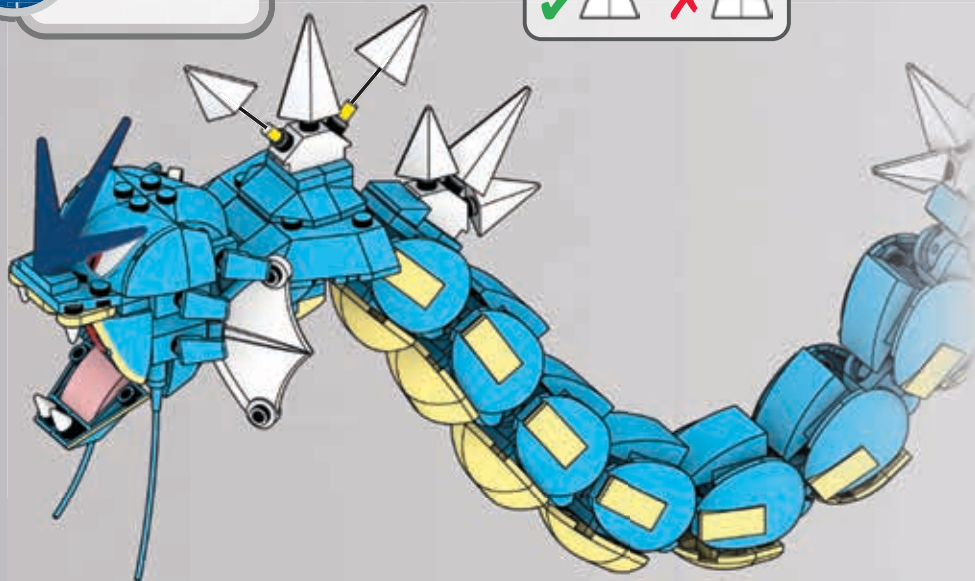



116

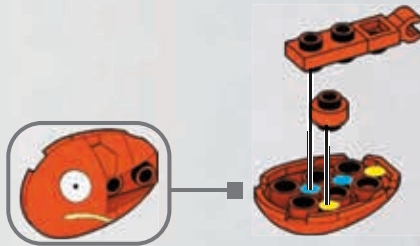
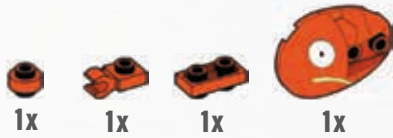

117

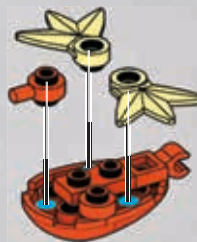
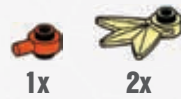

118



119



120

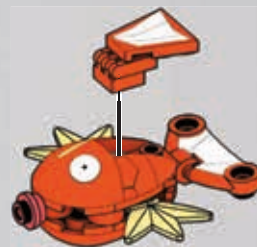
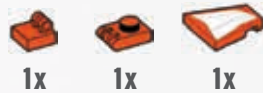

1



2

121

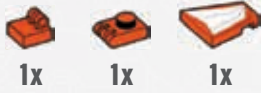

1x

1x

1x

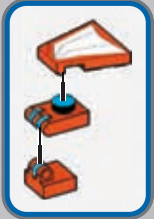

1



2



122



2x

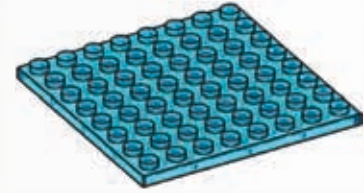

2x

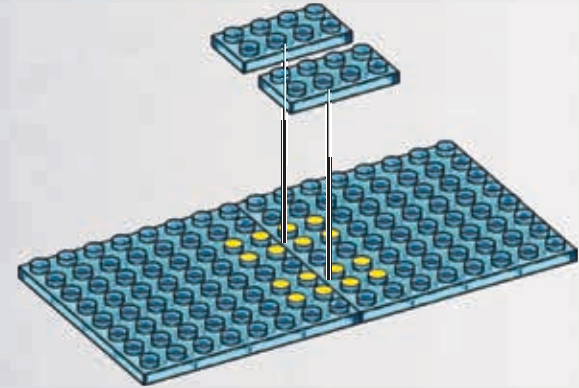

123



1x

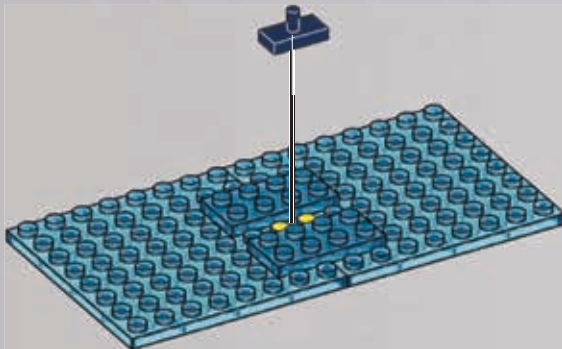

124



2x

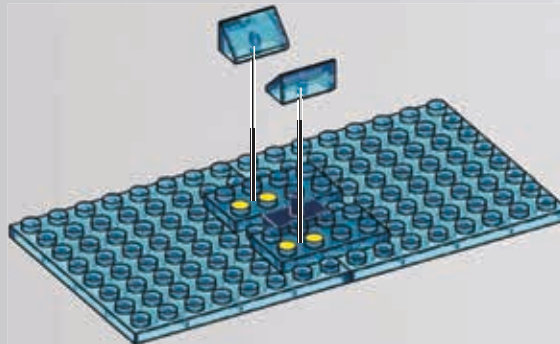

125



1x



2x

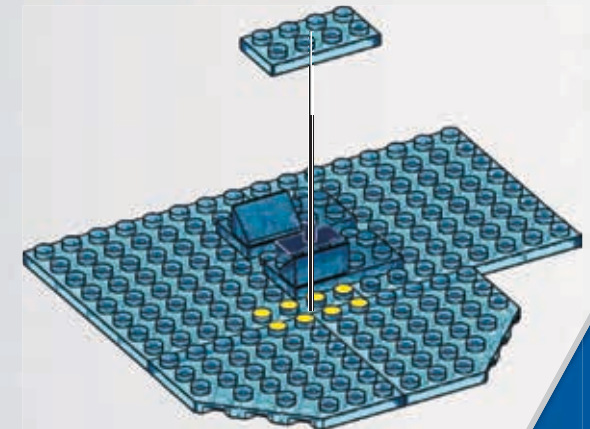

126

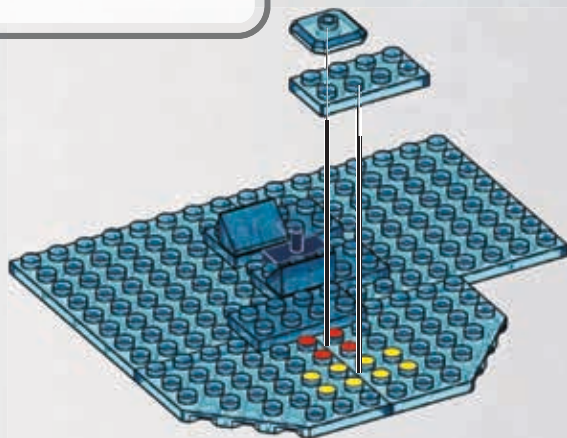
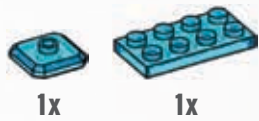

127

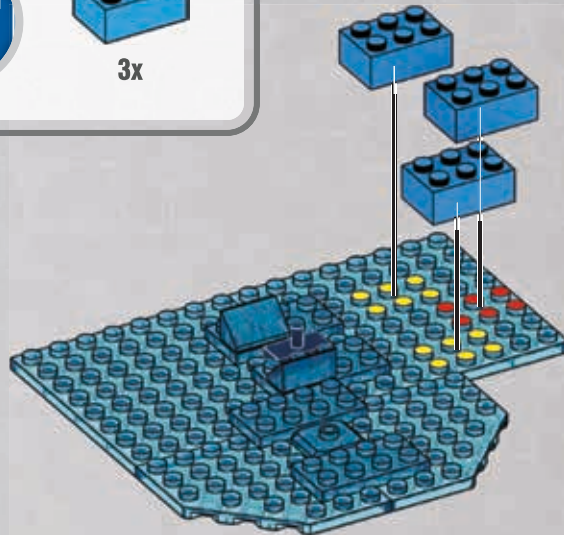

128

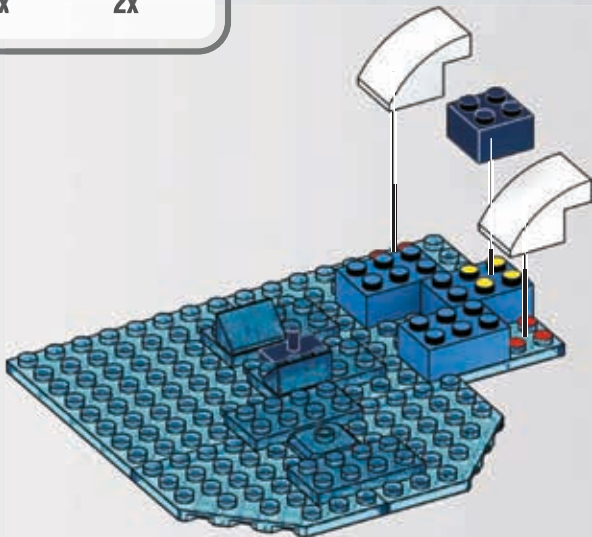
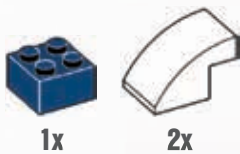

129

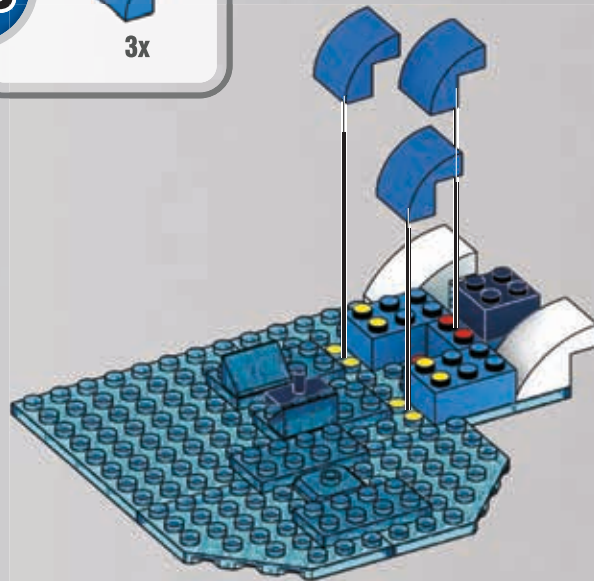

130



2x

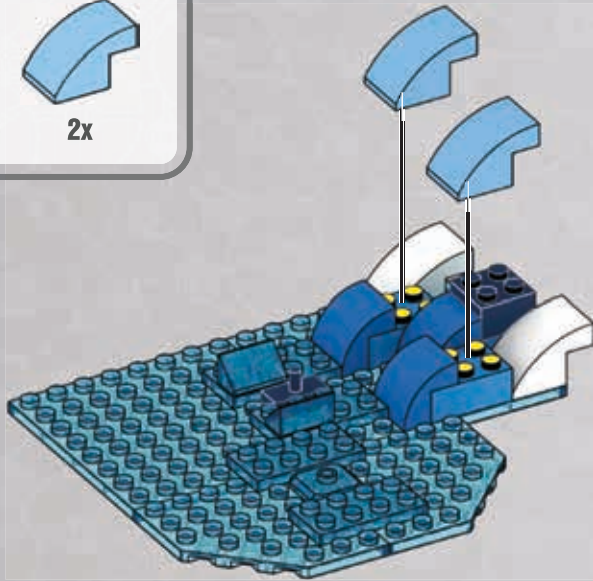

131



1x

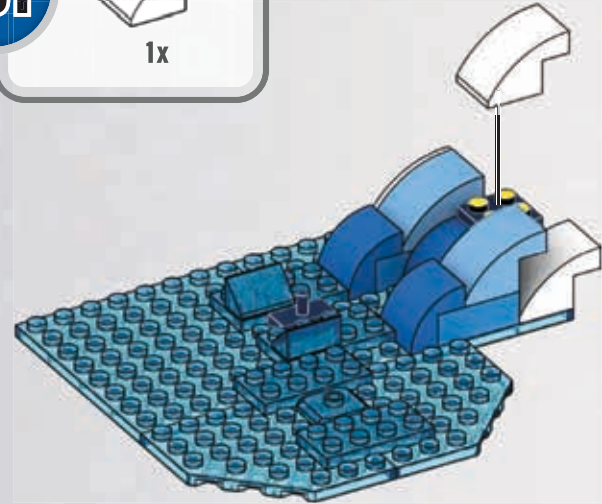

132



1x



1x

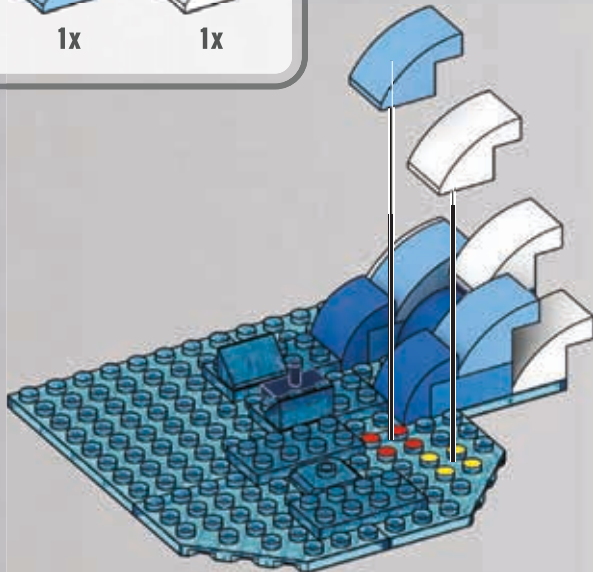

133



3x

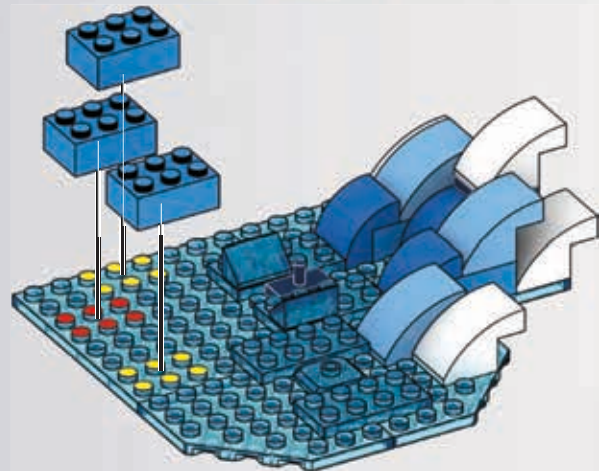

134

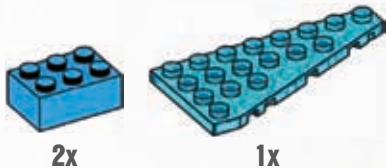

2x

1x

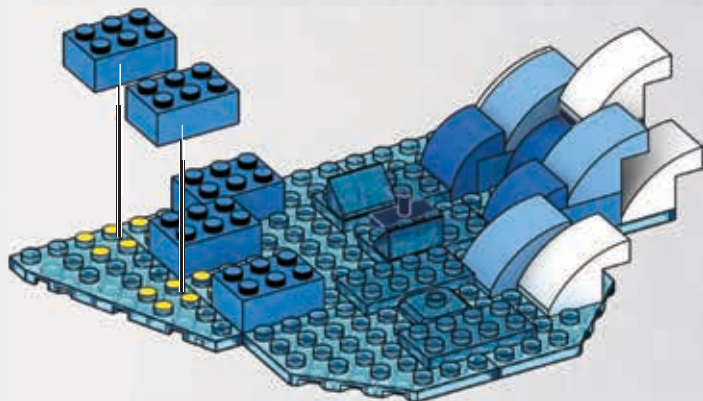

135



3x

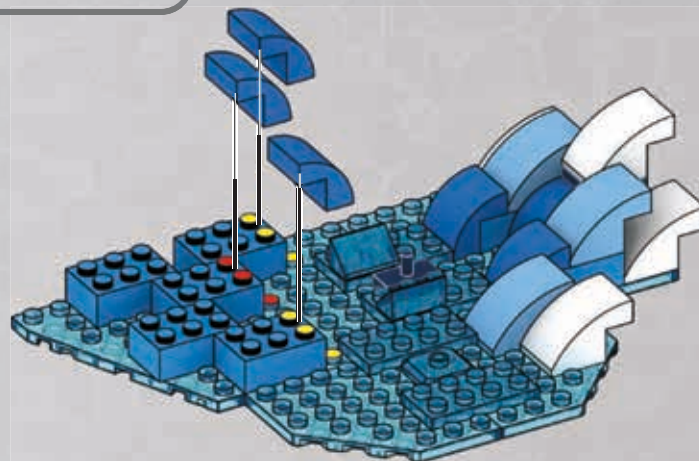

136



2x

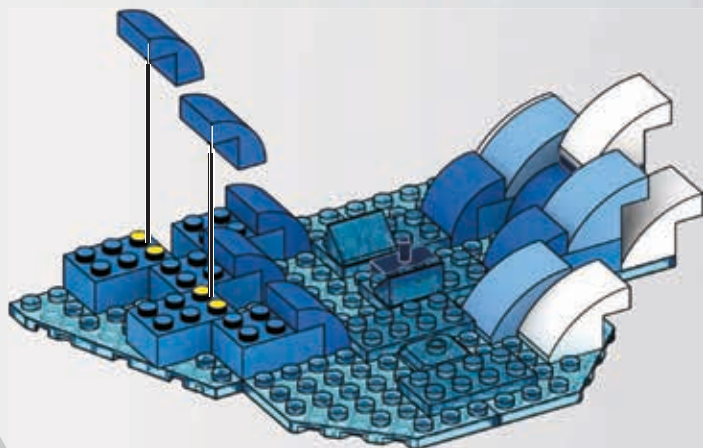

137

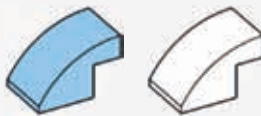

1x

1x

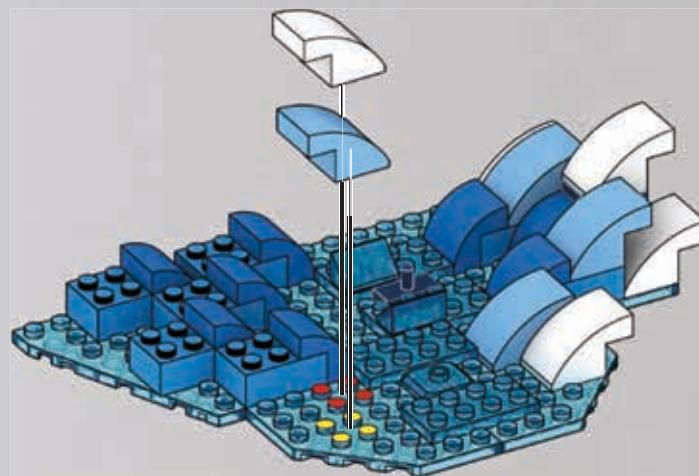

138



1x



1x

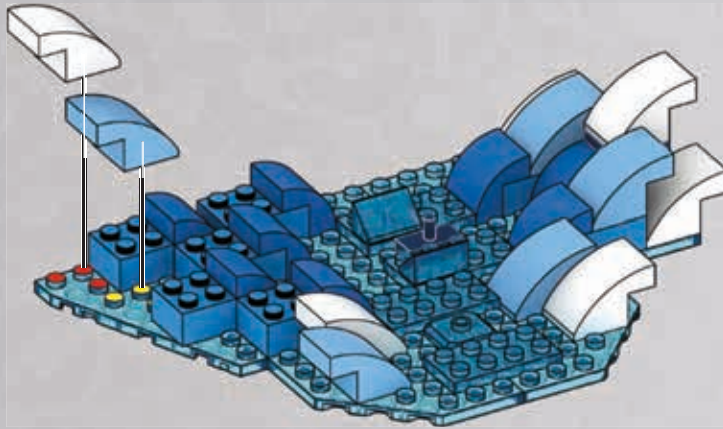

139



2x

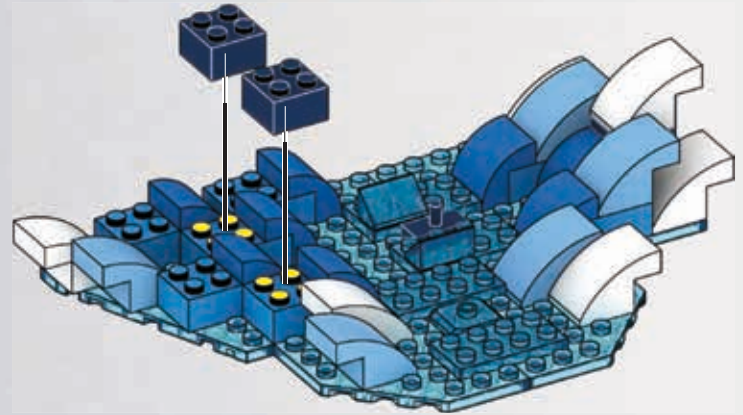

140



3x

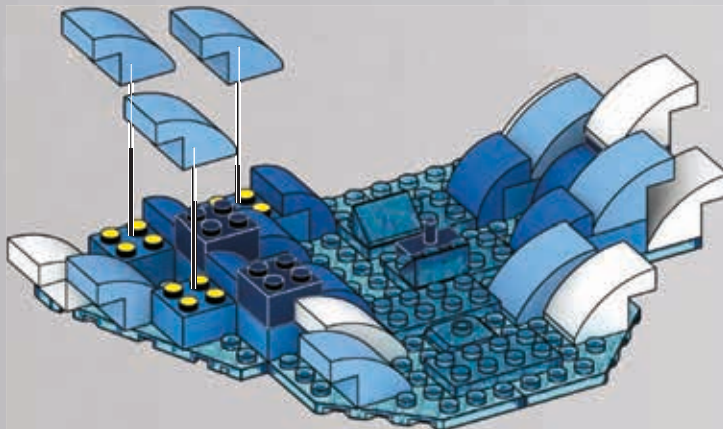

141



2x

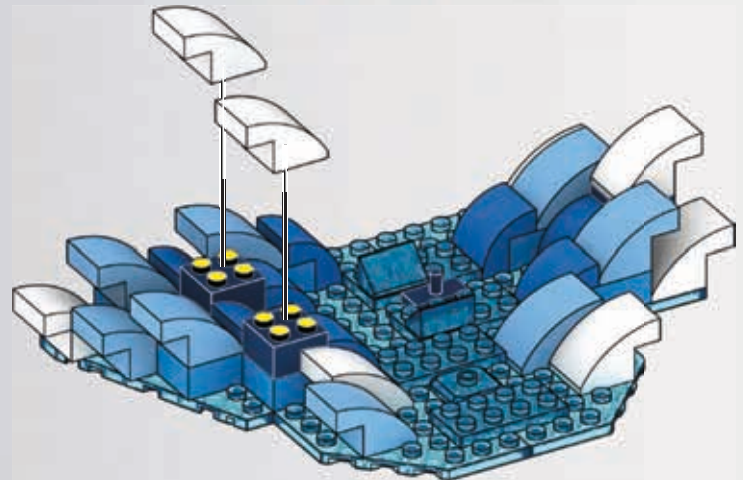

142

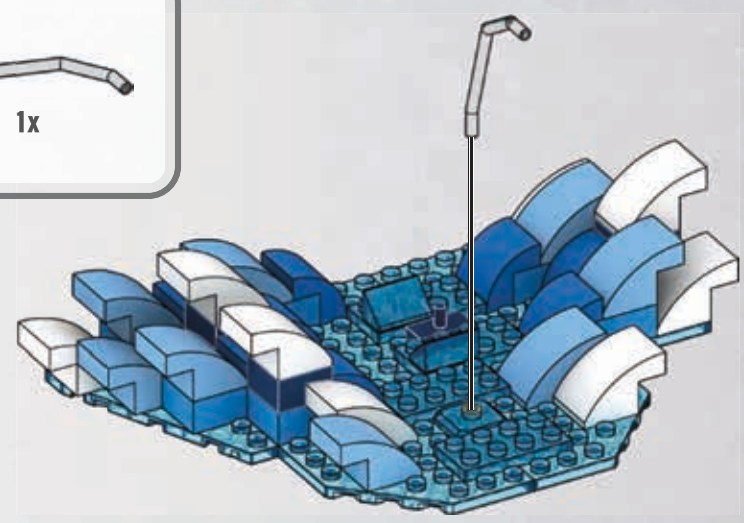
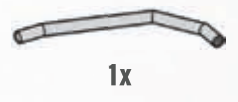

1

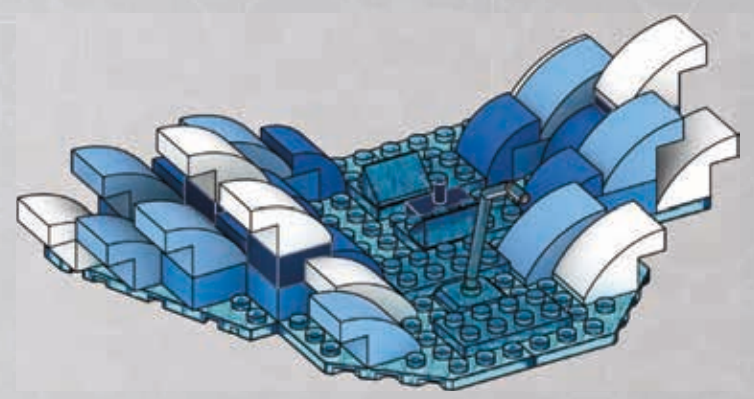

2

143

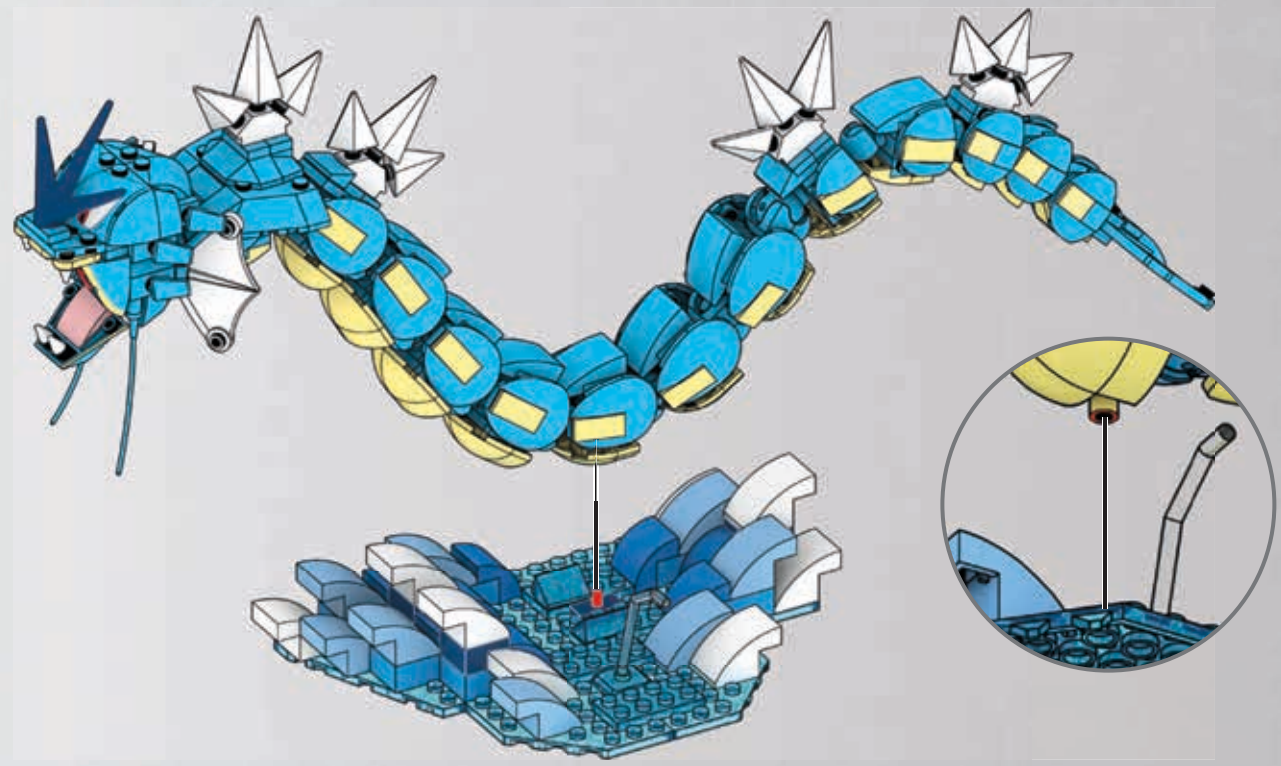

144

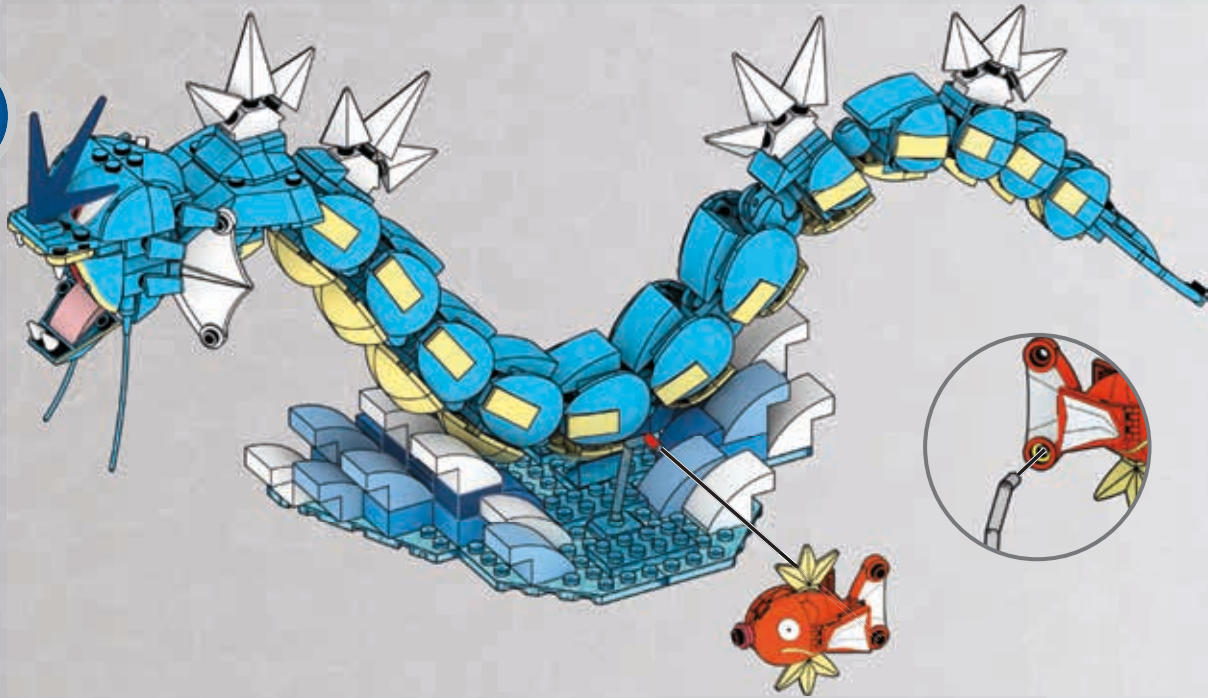

1

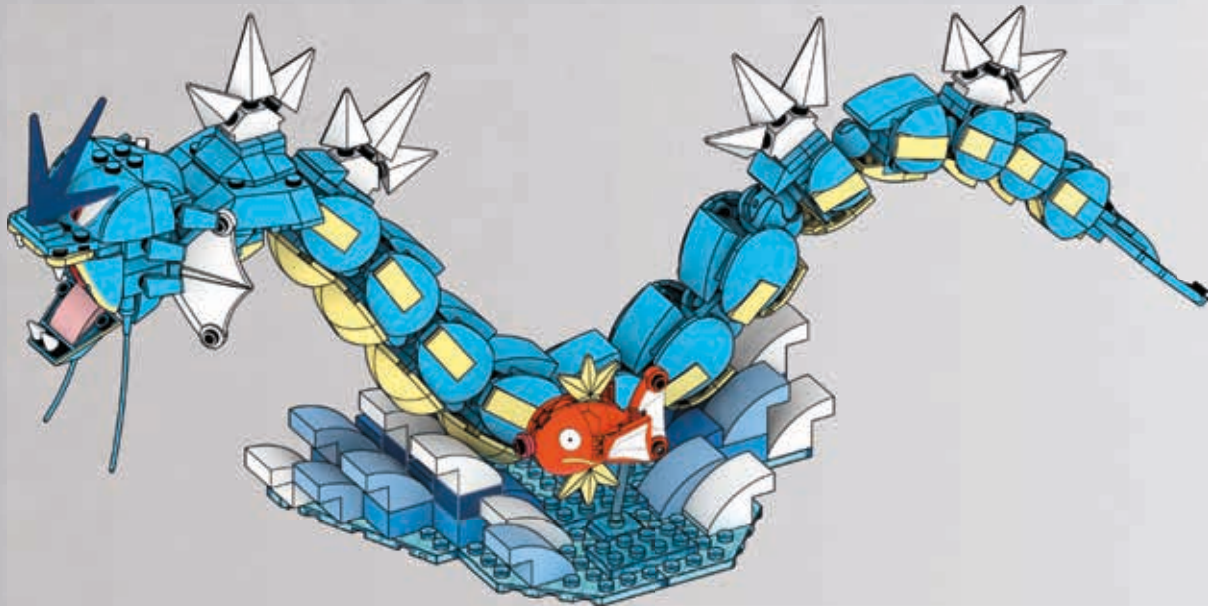

2

POSE THEM! POSITIONNABLES !

¡PÓSALOS! / FAÇA POSES!
ZUM POSIEREN! / МЕНЯЙ ПОЗЫ!



8x
AM80524GD



1x
AM18560RQ



1x
AM76558MCX



7x
AM07223GD



8x
AM03328GD



1x
AM81529GD



2x
AM09104MCX



6x
AM17127CS



12x
AM17003E



4x
AM80181E



1x
AM80010MCX



2x
AM76029GD



1x
AM74415MCX



2x
AM74415GD



2x
AM77574GD



1x
AM78273GD



2x
AM09105MCX



2x
AM80120GD



1x
AM80120CS



2x
AM04428GD



6x
AM18240GD



2x
AM17201GD



1x
AM80174CS



2x
AM76058GD



1x
AM72494GD



1x
AM72495GD



1x
AM22501CS



13x
AM07590GD



13x
AM09393GD



1x
AM16680MCX



3x
AM16680GD



3x
AM79070GD



4x
AM76467GD



3x
AM18549GD



2x
AM03019AAV



2x
AM74427GD



2x
AM74426GD



18x
AM17128CS



1x
AM17070MD



1x
AM78277GD



5x
AM78486CS



4x
AM78486GD



9x
AM17788CS



2x
AM16972CS



4x
AM15484GD



1x
AM15484CS



1x
AM09835GD



1x
AM72000GD



1x
AS-HNT95-12



1x
AS-HNT95-13



1x
AM73009AAV



23x
AM03773GD



9x
AM01146GD



2x
AM18014GD



1x
AM18223GD



1x
AM18223F



2x
AM81353GD



1x
AM17502GD



4x
AM74060E



1x
AM74106AMC



1x
AM74106NU



4x
AM74106CS



2x
AM78189GD



6x
AM76525GD



4x
AM76525CS



12x
AM80799CS



3x
AM09023MD



2x
AM79227GD



2x
AM79796GD



2x
AM78276GD



1x
AM72233CS



1x
AM19326CS



1x
AM80765GD



2x
AM72600GD



2x
AM01314GD



8x
AM80763E



2x
AM78382CS



1x
AS-HNT95-05



1x
AS-HNT95-06



1x
AM08482GD



10x
AM79574GD



1x
AS-HNT95-04



1x
AS-HNT95-03



1x
AS-HNT95-14



4x
AM80764E



18x
AM09106GD



1x
AM03772GD



1x
AM09593GD



1x
AM74416GD



1x
AM18736GD



7x
AM17021GD



8x
AM03873GX



1x
AM03324GD



1x
AM03323GD



1x
AM09493GD



4x
AM09493AAV



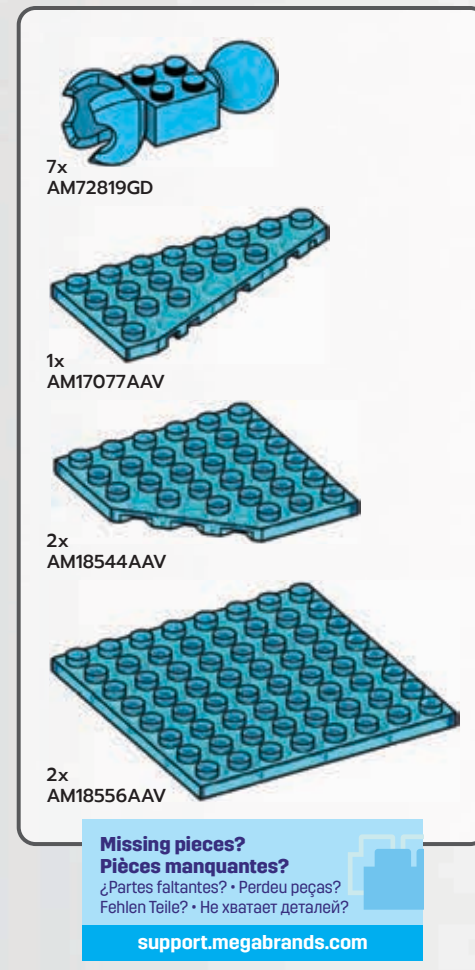
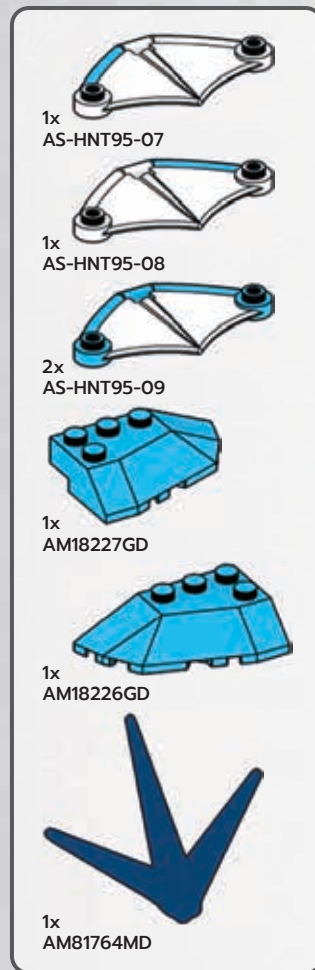
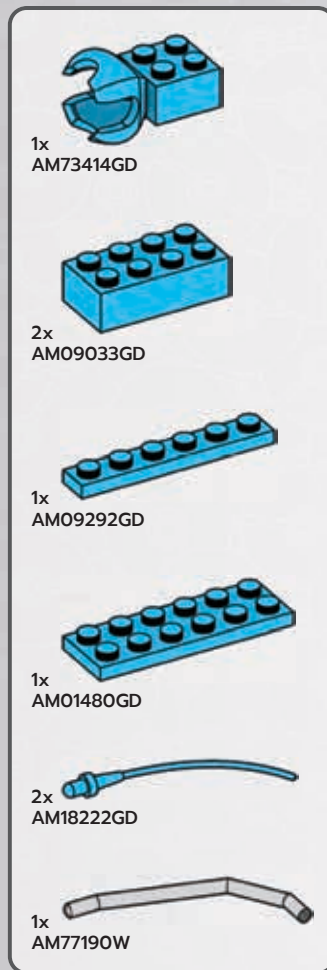
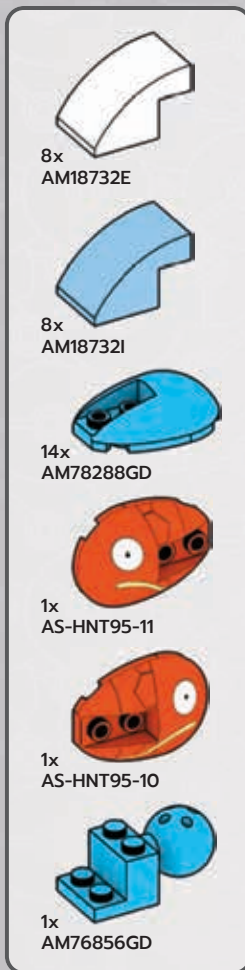

**Missing pieces?
Pièces manquantes?
¿Partes faltantes? • Perdeu peças?
Fehlen Teile? • Не хватает деталей?**

support.megabrand.com

WARNING:
CHOKING HAZARD – Small parts.
Not for children under 3 years.

ATTENTION:
DANGER D'ÉTOUFFEMENT –
PETITS ÉLÉMENTS. NE
CONVIENT PAS AUX ENFANTS
DE MOINS DE 36 MOIS.

ATENÇÃO: NÃO INDICADO / NÃO RECOMENDÁVEL PARA CRIANÇAS MENORES DE 3 (TRÊS) ANOS POR CONTER PARTE(S) PEQUENA(S) QUE PODE(M) SER ENGOLIDA(S) OU ASPIRADA(S) PODENDO PROVOCAR ASFIXIA.

WARNING: Small parts, **ATTENTION :** PETITS ÉLÉMENTS, **ACHTUNG:** Kleine Teile, **AVVERTENZA:** Piccole parti, **WAARSCHUWING:** Kleine onderdelen, **ADVERTENCIA:** PELIGRO DE ATRAGANTAMIENTO. Juguetes no recomendado para menores de 3 años, porque contiene piezas pequeñas que podrían provocar asfixia en caso de ser ingeridas o inhaladas por el/la niño/a, **WARNING:** Små delar, **VAROITUS:** Pieniä osia, **ADVARSEL:** Små dele, **ADVARSEL:** Små deler, **OSTRZEŻENIE:** Małe części, **UPOZORNĚNÍ:** Malé části, **UPOZORNENIE:** Malé části, **FIGYELMEZTETÉS:** Kis alkatrészek, **ПРЕДУПРЕЖДЕНИЕ:** Мелкие детали, **ΠΡΟΕΙΔΟΠΟΙΗΣΗ:** Μικρά κομμάτια, **UYARI:** Küçük parçalar.



تحذير: قطع صغيرة.
الذي يتوافق مع الخطر. **警告:** 不适合3岁以下儿童使用。内含小零件。

Mattel Europa B.V., Gondel 1, 1186 MJ Amstelveen, Nederland. Mattel U.K. Limited, The Porter Building, 1 Brunel Way, Slough SL1 1FQ, UK. Mattel France, Parc de la Cerisaie, 1/3/5 allée des Fleurs, 94260 Fresnes Cedex. N° Cristal 0969 36 99 99 (Numéro non surtaxé) ou www.lesjouetsmattel.fr Mattel Belgium, Trade Mart, Atomiumsquare, Bogota 202 – B 275, 1020 Brussels. Gratis nummer België: 0800 – 16 936 - Gratis nummer Luxembourg: 800 - 22 784 -Gratis nummer Nederland: 0800 - 262 88 35. Deutschland : Mattel GmbH, Solmsstraße 83, D-60486 Frankfurt am Main. Schweiz: Mattel AG, Kirchstrasse 24, CH-3097 Liebefeld. Österreich: Mattel Ges.m.b.H., Campus 21, Liebermannstraße 401 404, A- 2345 Brunn/Gebirge. Mattel Italy Srl, Via Turati 4, 20121 Milano, Italy. Servizio assistenza clienti: Customersrv.italia@mattel.com - Numero verde 800 11 37 11. Mattel España, S.A. Arriba 200 pl. 9, 08036 Barcelona. cservice. spain@mattel.com Tel: +34 933 06 79 00 http://www.service.mattel.com/es. Hong Kong: Kids Kingdom Limited, Room 1908-9, Gala Place, 56 Dundas Street, Mongkok, Kowloon, Hong Kong. Customer Care line: +8522782-0766. Taiwan: Chickabiddy Company Limited, 5/F, No. 186, Section 4, Nanjing East Road, Taipei 10595, Taiwan. Customer Care line: (02)2578-1188. Mainland China: Mattel Barbie (Shanghai) Trading Co., Ltd. Units 4701-4711, 47F, 2 Grand Gateway, 3 Hong Qiao Road, Shanghai, 200030, P.R.C. Customer Care line: 400-819-8658. Diimport & Diedarkan Oleh: Mattel Continental Asia Sdn Bhd. Level 19, Tower 3, Avenue 7, No. 8 Jalan Kerinchi, Bangsar South, 59200 Kuala Lumpur, Malaysia. Mattel South Africa (PTY) LTD, Office 102/3, 30 Melrose Boulevard, Johannesburg 2196. Dystrybutor: Mattel Poland Sp. z o.o., Warsaw Trade Tower 34 p., ul. Chłodna 51, 00-867 Warszawa. Mattel Australia Pty. Ltd., 658 Church St, Richmond, Victoria, 3121. Consumer Advisory Service - 1300 135 312. Mattel AEBE, Εβδόμενου Μακροίου 1, Κτήριο Κ-2, ΤΚ 17561, Πολυάτο Φάληρο. Mattel Оуаnсакçılık Tic. Ltd. Şti. İğcerenköy Mah., Umut Sokak No: 10 - 12, Quick Tower kat:2 İçkapı no:15 Ataşehir 34752, İstanbul, Türkiye. Tel: 0216 570 75 00. Импортёр/Уполномоченная организация: ООО "МАТТЕЛ" Российская Федерация, 105120 Москва, 2-й Сыромятинский переулок, 1; +7 495 287 79 39. Mattel Czech Republic s.r.o., The Forum, Václavské nám. 19, 11000 Praha 1. Mattel, 333 Continental Boulevard, El Segundo, CA 90245, USA. Consumer Services: 1-800-465-MEGA (6342). Mattel Canada Inc., Mississauga, Ontario L5R 3W2. Consumer Services: You may call us free at /Composez sans frais le 1-800-524-8697. Importado y distribuido por Mattel de México, S.A. de C.V., Miguel de Cervantes Saavedra No. 193, Pisos 10 y 11, Col. Granada, Alcatdia Miguel Hidalgo, CP. 11520, México, Ciudad de México. R.F.C. MME-920701-NB3. Tels: 59-05-51-00 Ext. 5206 ó 01-800-463-59-89. Mattel Chile, S.A., Avenida Américo Vespucio 501-B, Quilicura, Santiago. Tel: 1230-020-6213. Servicio al consumidor Venezuela: Tel: 0-800-100-9123. Mattel Argentina, S.A., Av. Libertador 1000, Piso 11 – Oficinas 109 y 111, Vicente López – Prov. Buenos Aires. Tel: 0800-666-3373. Mattel Colombia, S.A., Calle 123#7-07 P5, Bogotá. Tel: 01800-710-2069. Mattel Perú, S.A., Av. Juan de Arona # 151, Centro Empresarial Juan de Arona, Torre C, Piso 7, Oficina 704, San Isidro, Lima 27, Perú. RUC: 20425853865. Reg. Importador: 02350-12-JUE-DIGESA. Tel: 0800-54744. E-mail Latinoamérica: servicio.clientes@mattel.com. Mattel do Brasil Ltda. - CNPJ: 54.558.002/0001-20 - Rua Verbo Divino, 1488 - 2º. Andar - 04719-904 - Chácara Santo Antônio - São Paulo - SP - Brasil. Serviço de Atendimento ao Consumidor: fone 0800 575 0780. E-mail: sac.mattel@brasil.mattel.com

Magikarp Evolution Set / Coffret Évolution Magikarpe / Karpador Evolutionssset / Set Evoluzione di Magikarp / Evoluteset Magikarp / Conjunto de Evolución de Magikarp
onjunto de Evolução do Magikarp / Magikarp-utvecklingsset / Magikarp-udviklingsset / Ewolucja Magikarpa Zestaw / Magikarp átalakulási készlet / Набор "Эволюция Magikarp"
Magikarp Evolution Set / Magikarp Dönüşüm Seti / Magikarp Evolution Set المجموعة التحول

©2022 Pokémon. ©1995–2022 Nintendo / Creatures Inc. / GAME FREAK inc. TM, ®, and character names are trademarks of Nintendo.

©2022 Pokémon. ©1995–2022 Nintendo/Creatures Inc./GAME FREAK inc. TM, ® et les noms des personnages sont des marques de Nintendo.



POKÉMON



HKT23



HDH93



HFG06

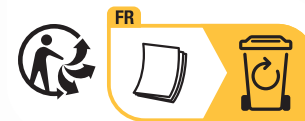

Set(s) sold separately and subject to availability. / Ensemble(s) vendu(s) séparément. Certains produits peuvent ne pas être commercialisés.

Se vende(n) por separado y está(n) sujeto(s) a disponibilidad. / Conjunto(s) vendido(s) em separado e sujeito(s) à disponibilidade. / Set in vendita separatamente, secondo disponibilità. / Set/Die Set(s) sind separat erhältlich. / Zestaw(y) sprzedawany(e) oddzielnie w zależności od dostępności. / Set(s) apart verkrijgbaar en afhankelijk van beschikbaarheid. / Набор(-ы) продаются отдельно, при наличии. / Sæt sælges separat og så længe lager haves. / Seten säljs separat så länge lagret räcker. / Settet/settene selges separat så langt lageret rekker. / Pakkaus/pakkaukset myydään erikseen, saatavuus voi vaihdella. / Το(α) σετ πωλούνται ξεχωριστά και ανάλογα με τη διαθεσιμότητα. / Setler ayrı olarak satılır ve stoklarla sınırlıdır. / Set (sety) se prodává (prodávají) samostatně dle aktuální nabídky. / Súprava/-y sa predáva(jú) samostatne a podľa dostupnosti. / A készlet(ek) külön kapható(k), az elérhetőség változhat. / セット商品は別売りになります。在庫状況は別途ご確認お願いします。 / تباع المجموعة أو المجموعات على حدة وتخضع لتوافرها. / 每套单独发售，按供货情况决定。

