

MEGA™

POKÉMON™



HNT96

**JUMBO BULBASAUUR
BULBIZARRE GÉANT**

BULBASAUUR JUMBO / BULBASAUUR GIGANTE
JUMBO BISASAM / БОЛЬШОЙ BULBASAUUR



Build Construisez

Construye
Constrói
Bauen
Стройте

Share Partagez

Comparte | Partilha
Teilen | Делитесь

Device not included | Appareil non inclus
Dispositivo no incluído. | Dispositivo não incluído
Gerät nicht enthalten | Устройство не входит в комплект



megaunboxed.com

2

BUILDING TOOL OUTIL DE CONSTRUCTION

HERRAMIENTA DE CONSTRUCCIÓN
BAUWERKZEUG
FERRAMENTA DE MONTAGEM
ИНСТРУМЕНТ ДЛЯ
КОНСТРУИРОВАНИЯ

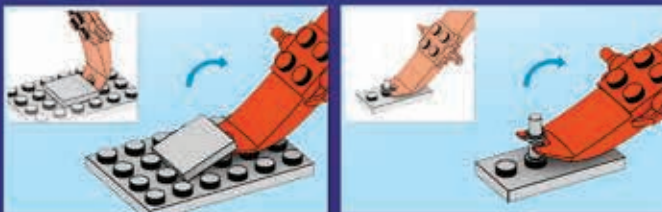

3



1 2

1 → 2

23



3 4 5 6

3 → 6

48



7 8 9

7 → 9

68



10 11

10 → 11

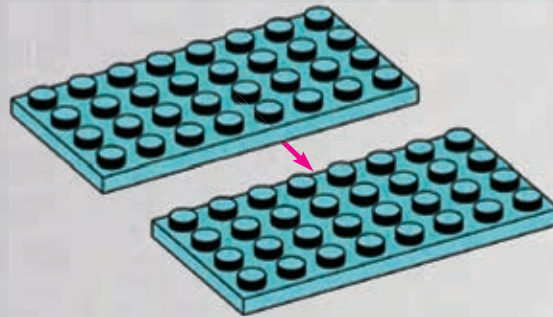
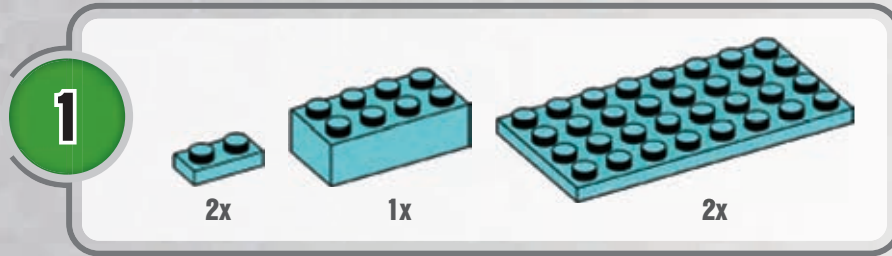

1

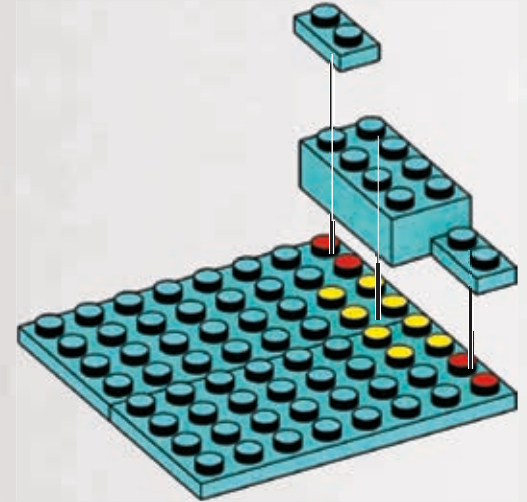

2

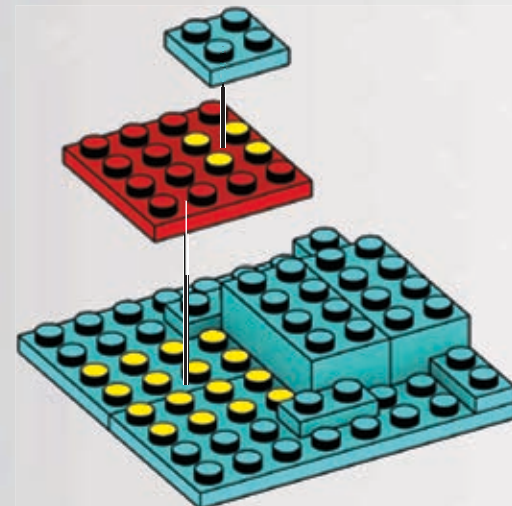
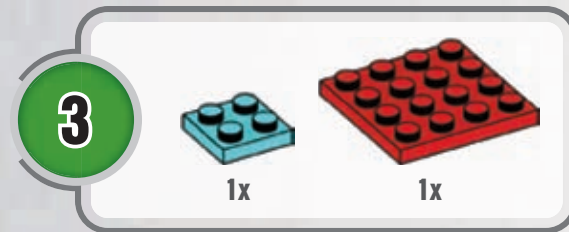
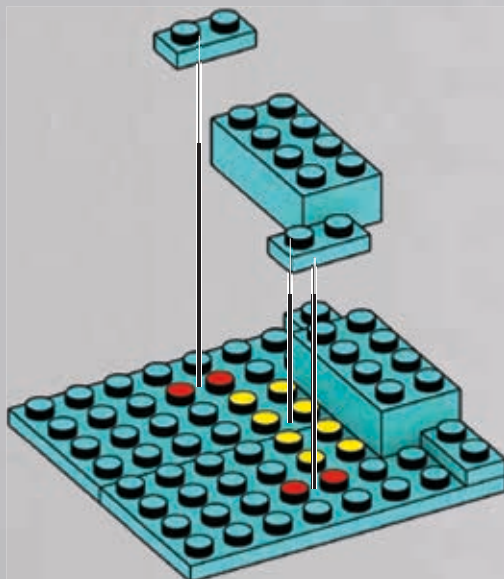
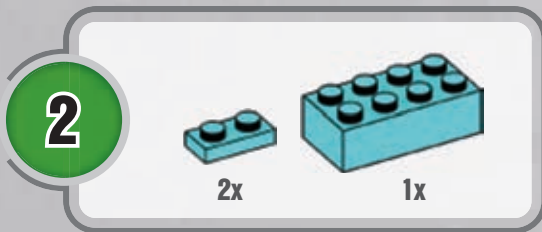

4



2x



2x

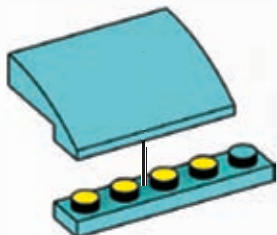

1



2

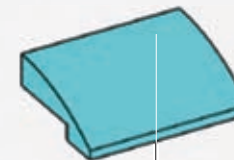
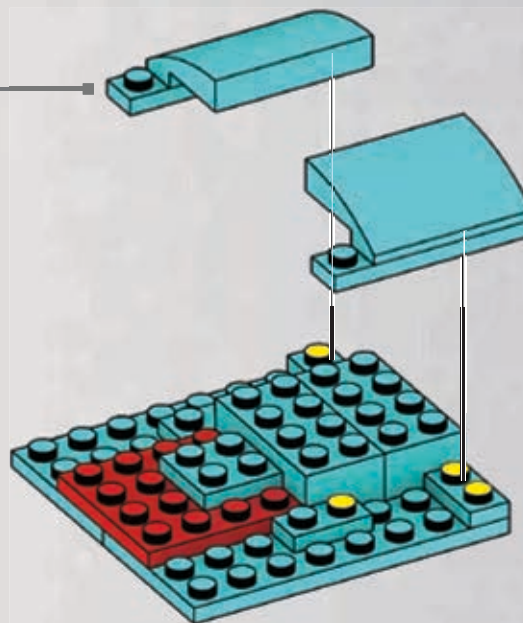

1

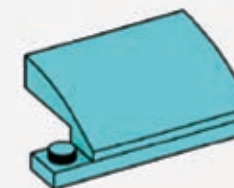

2

5



2x



2x



1x



1x

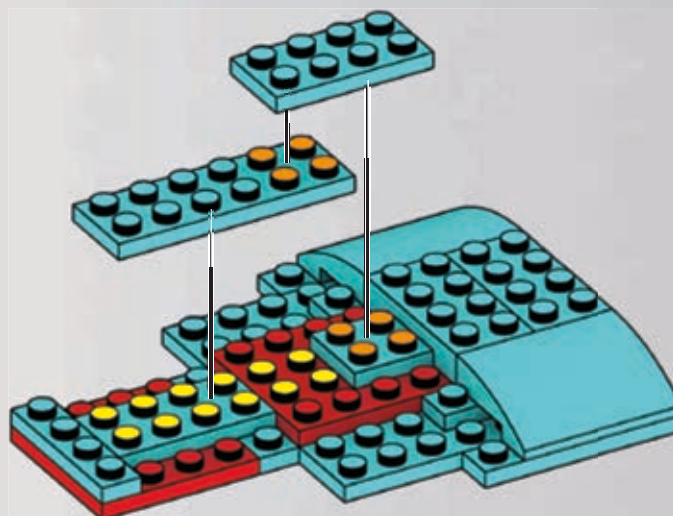
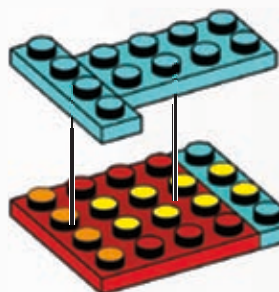

6



4x

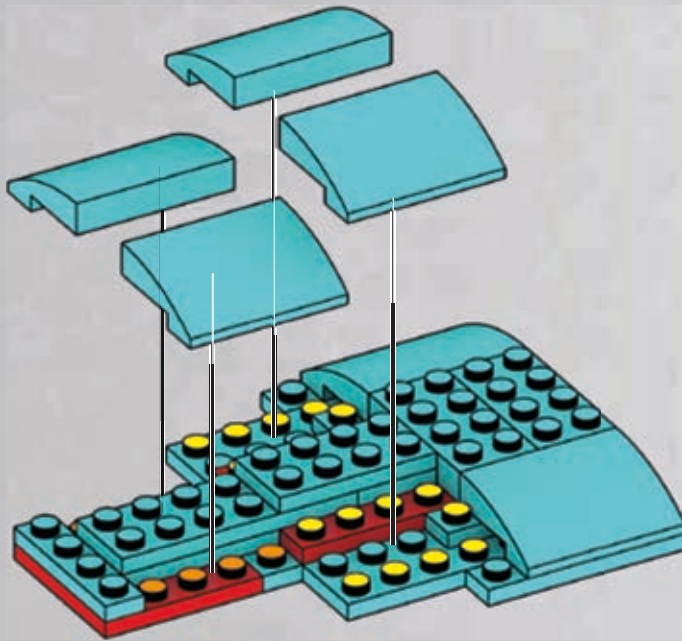

1

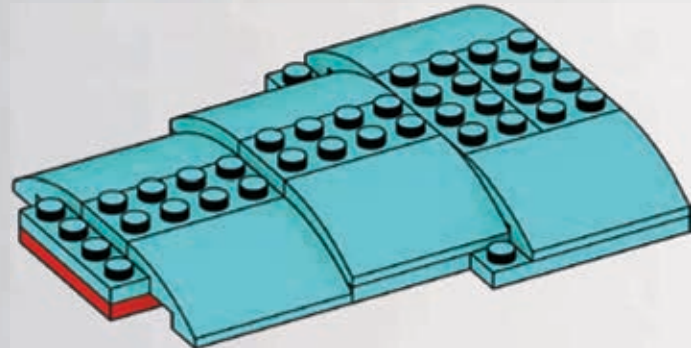

2

7

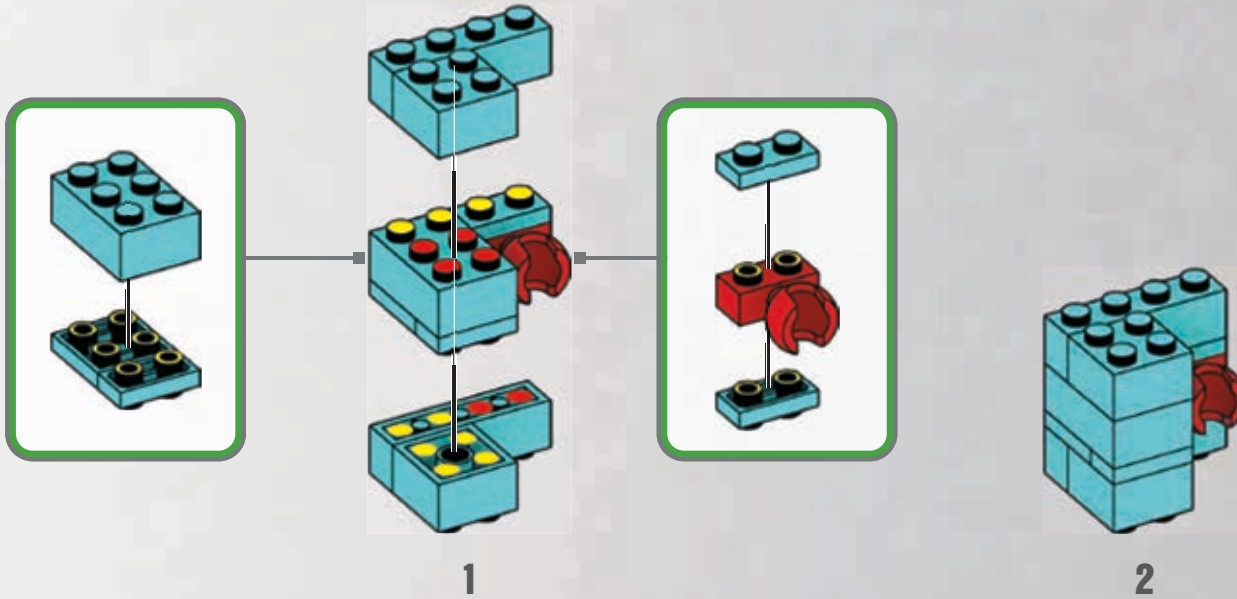
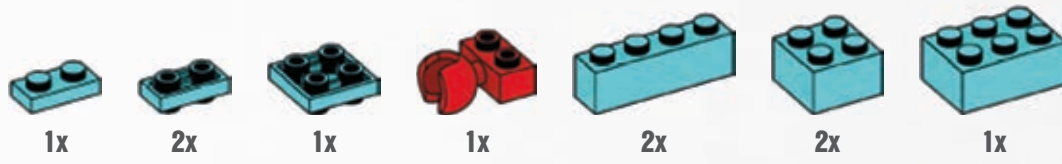

8

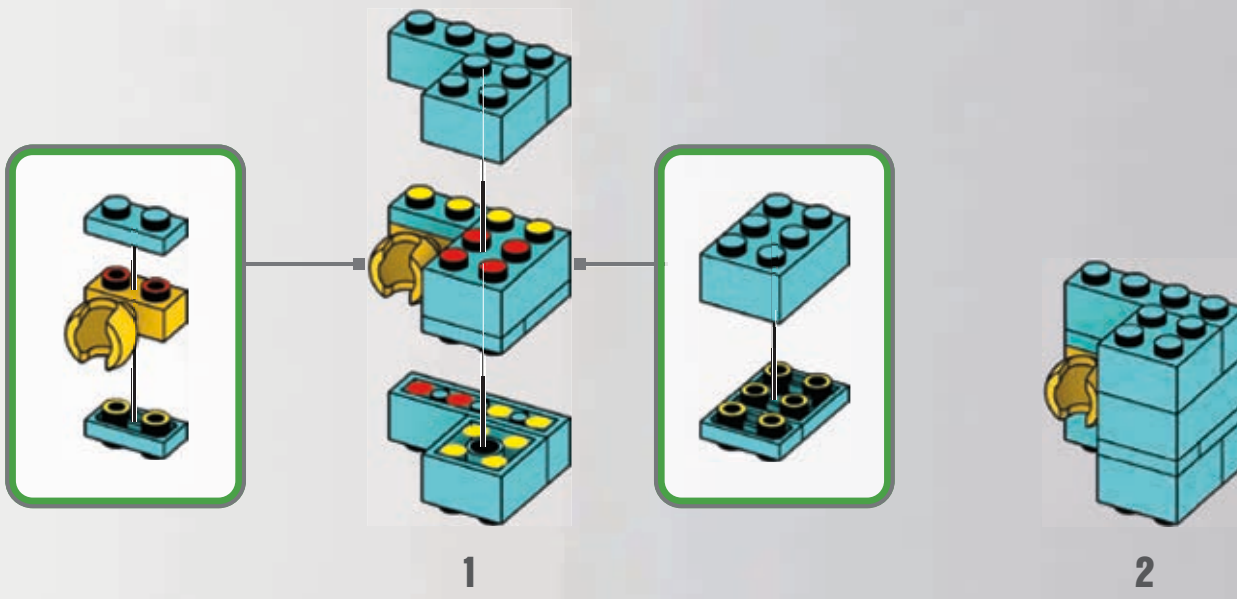

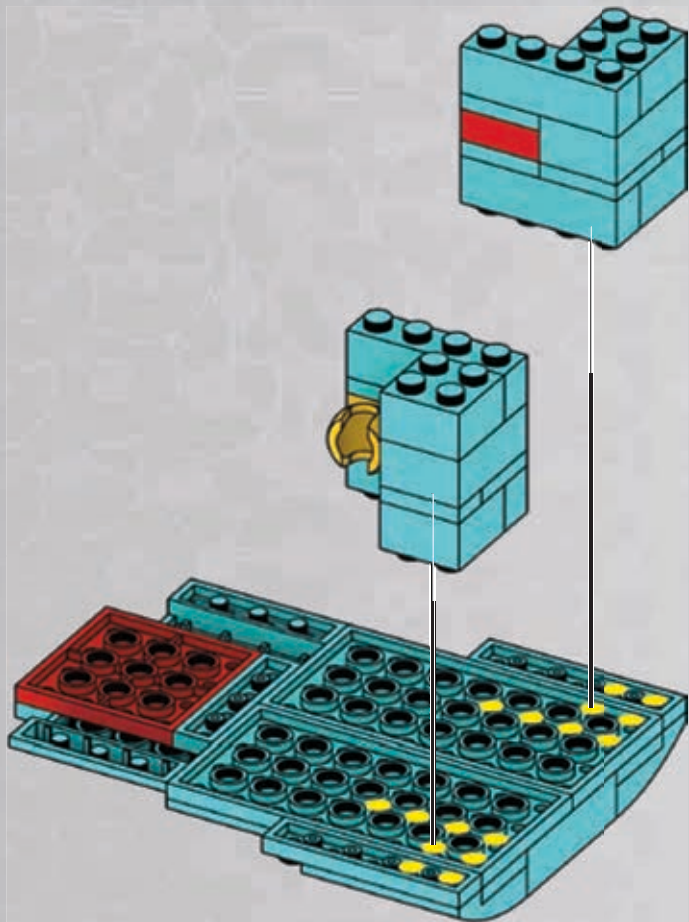

1

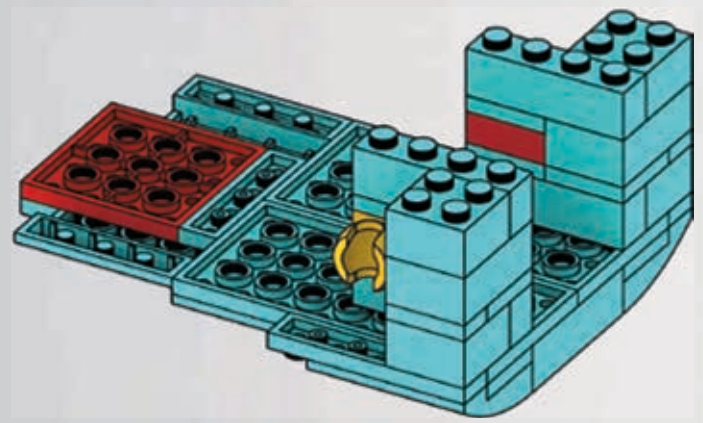

2

10



1x

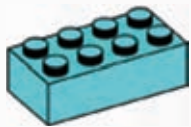

1x



1x

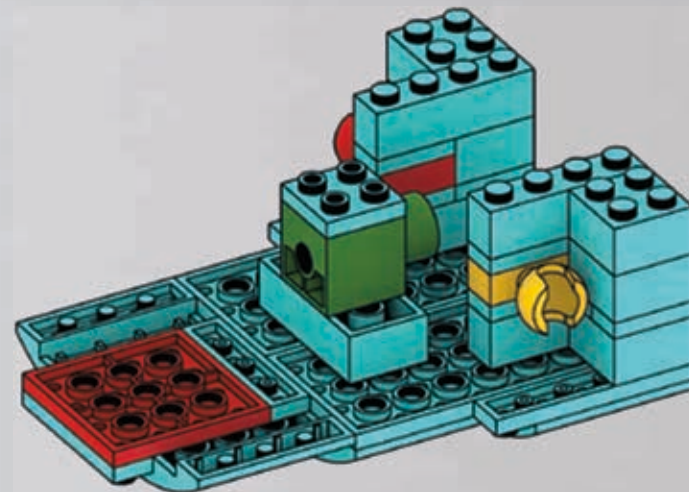
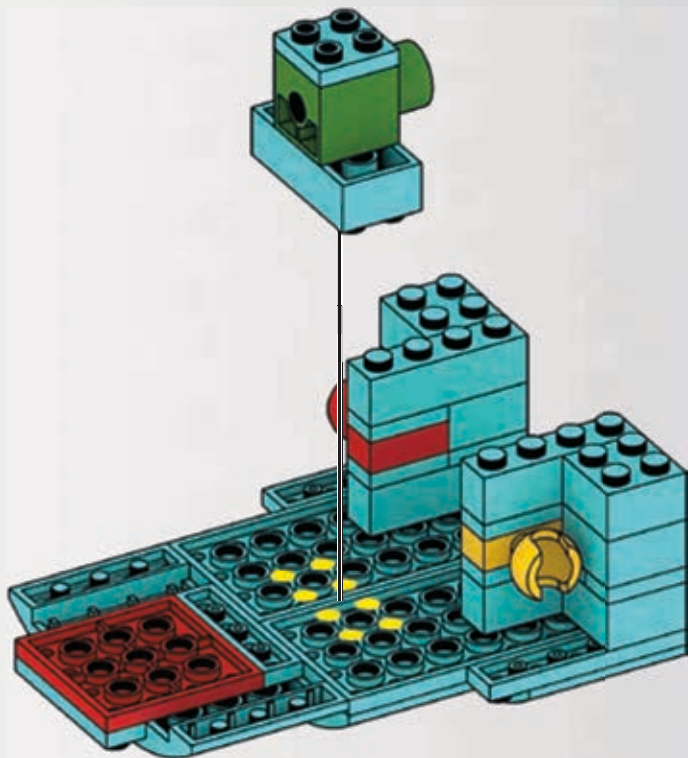
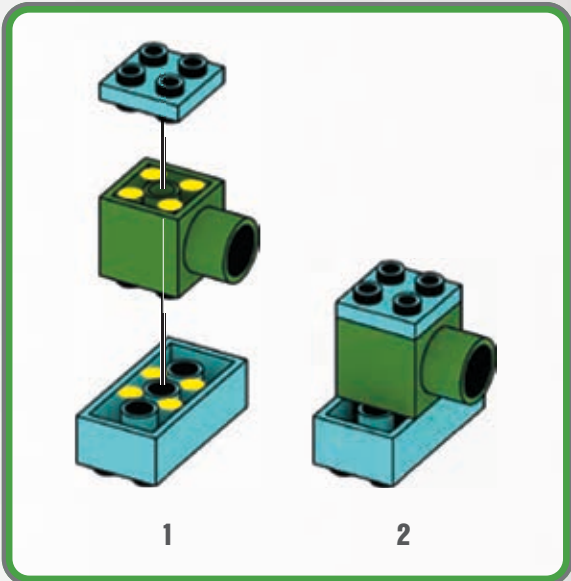

11

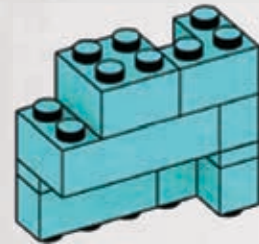
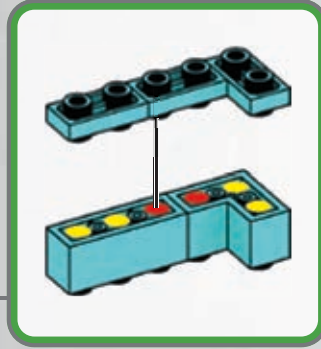
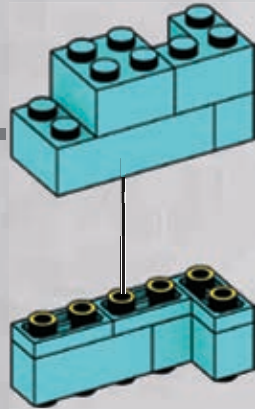
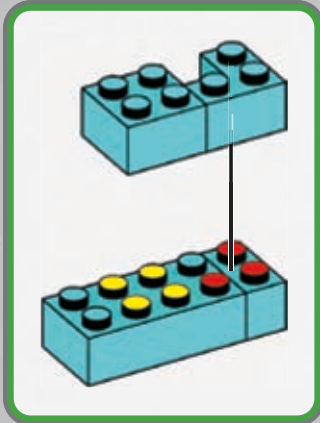
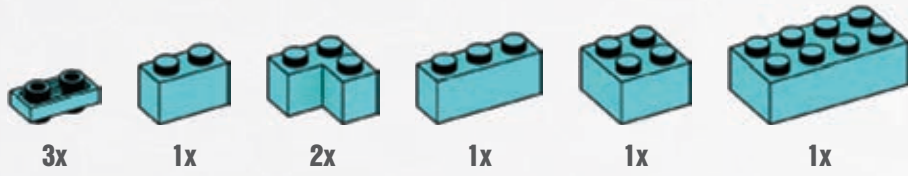

1

2

12

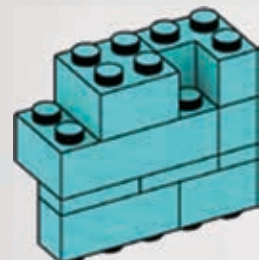
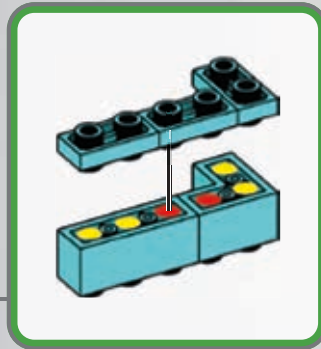
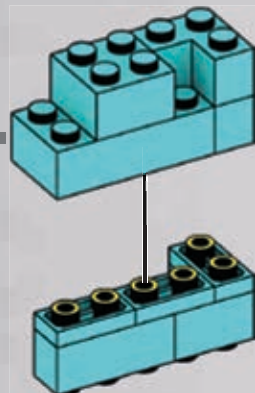
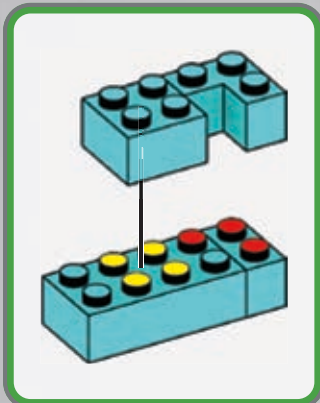
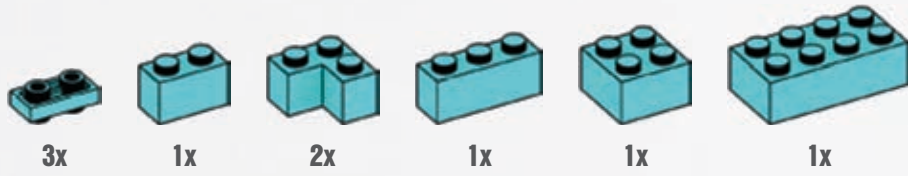

1

2

13

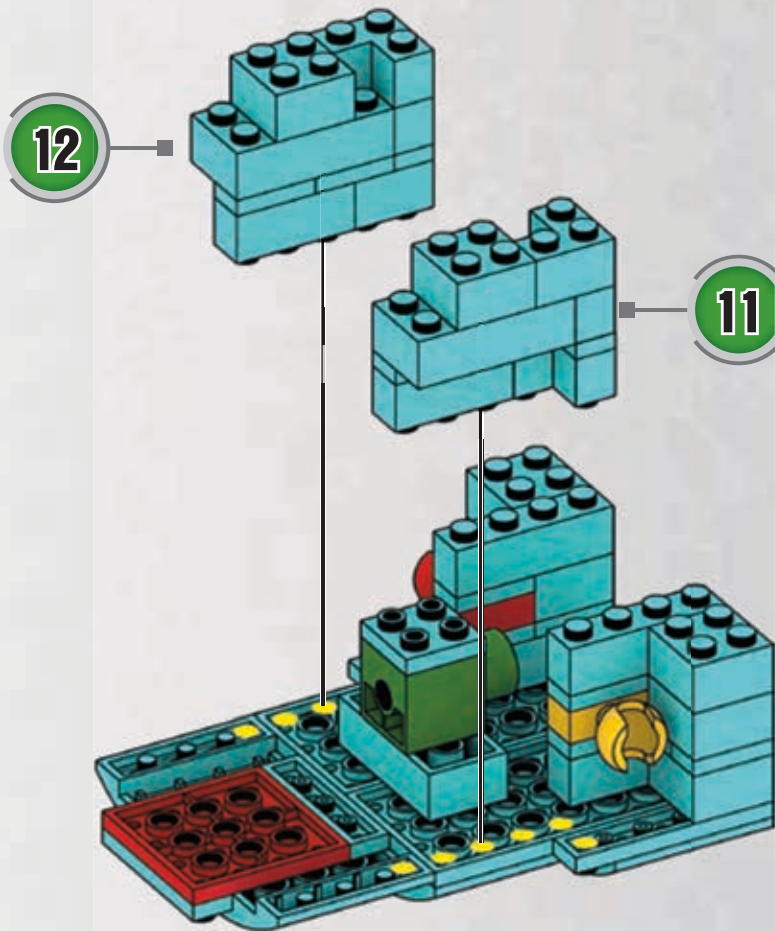

14

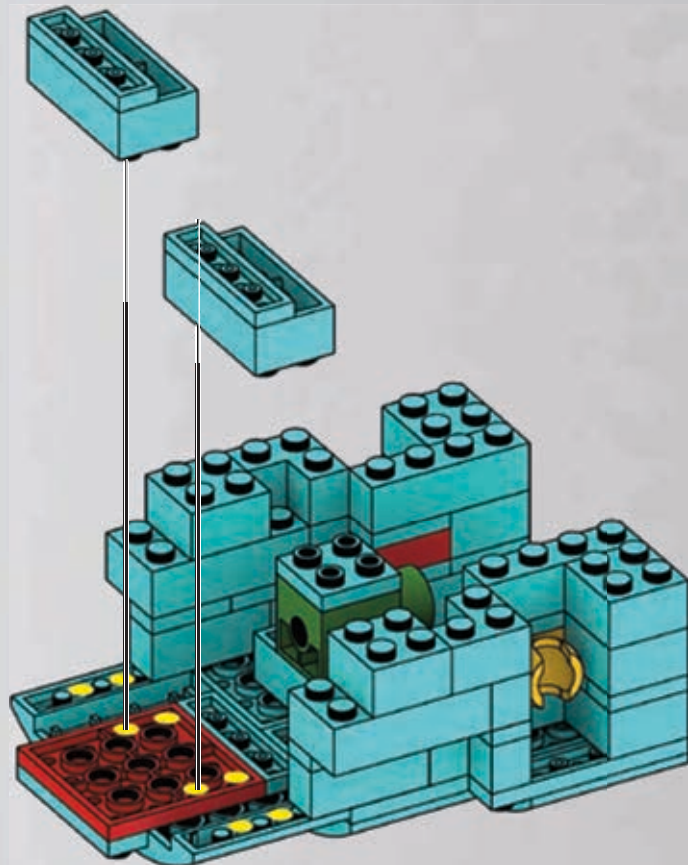
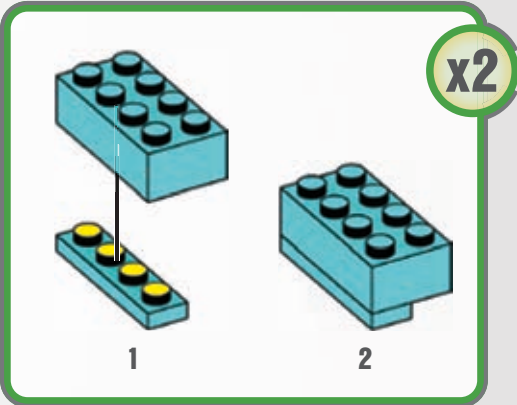
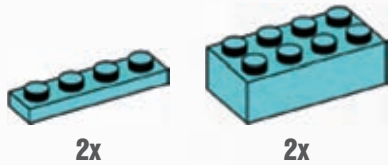

15



2x



2x

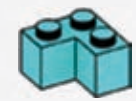

2x

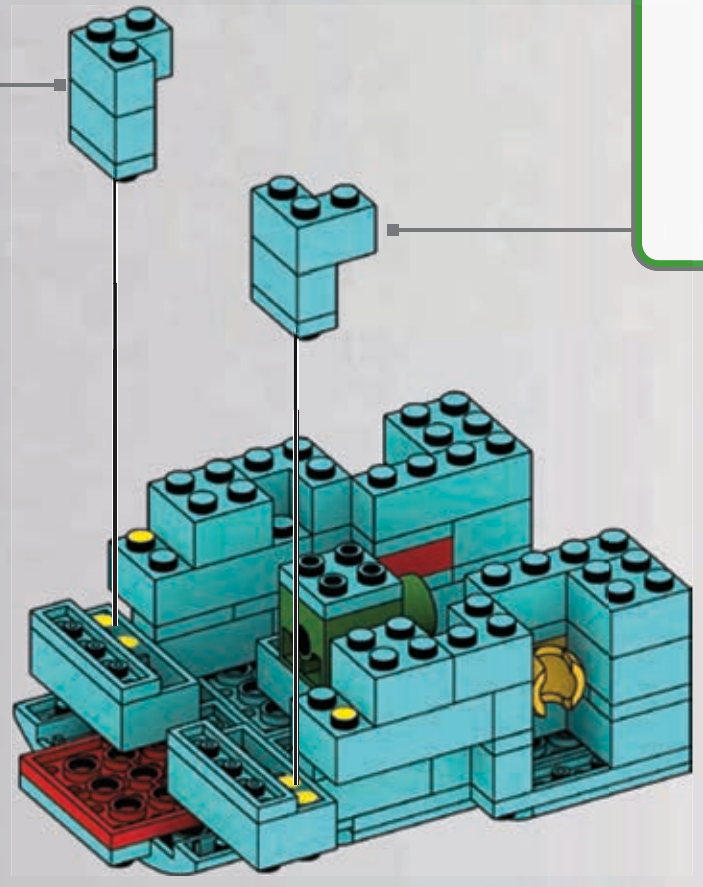
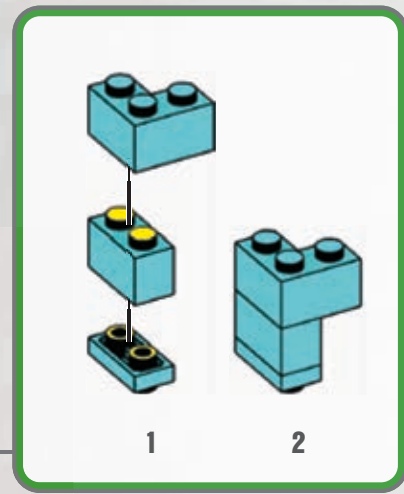
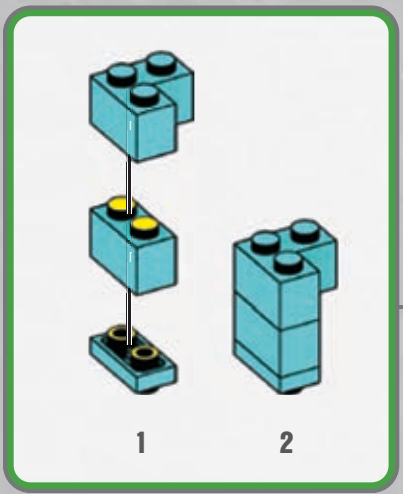

16

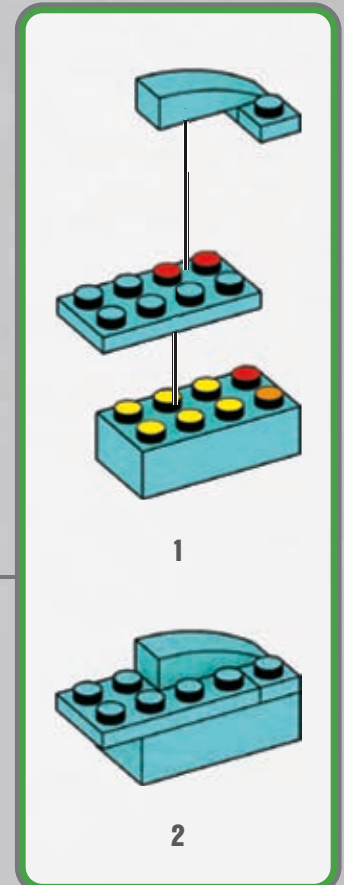
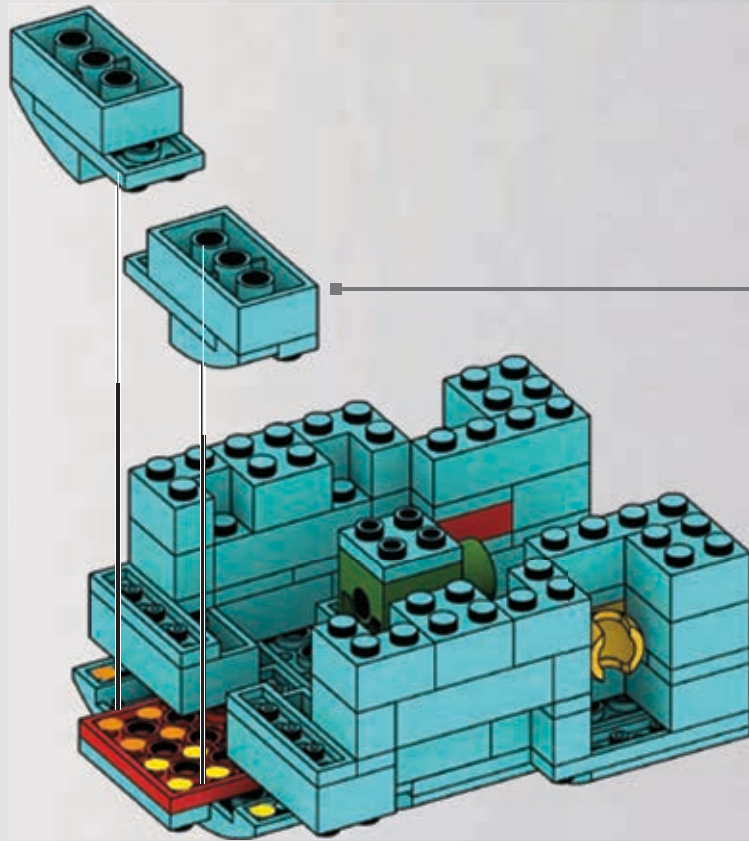
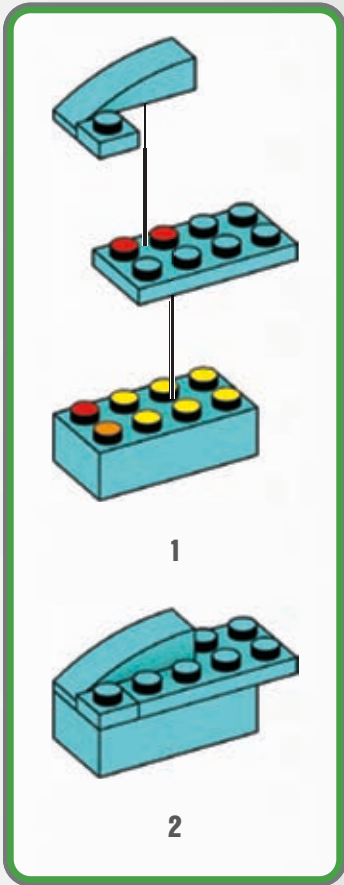
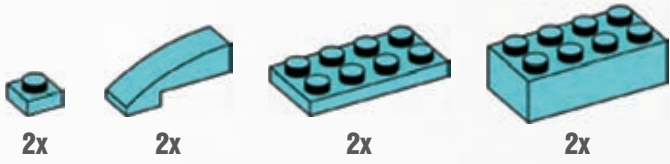

17



2x



4x

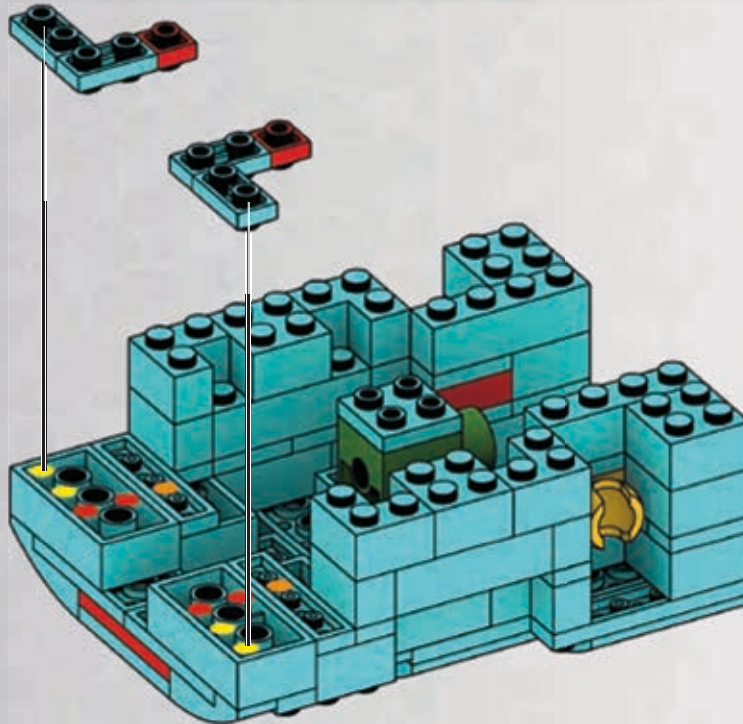

18



2x



1x



1x

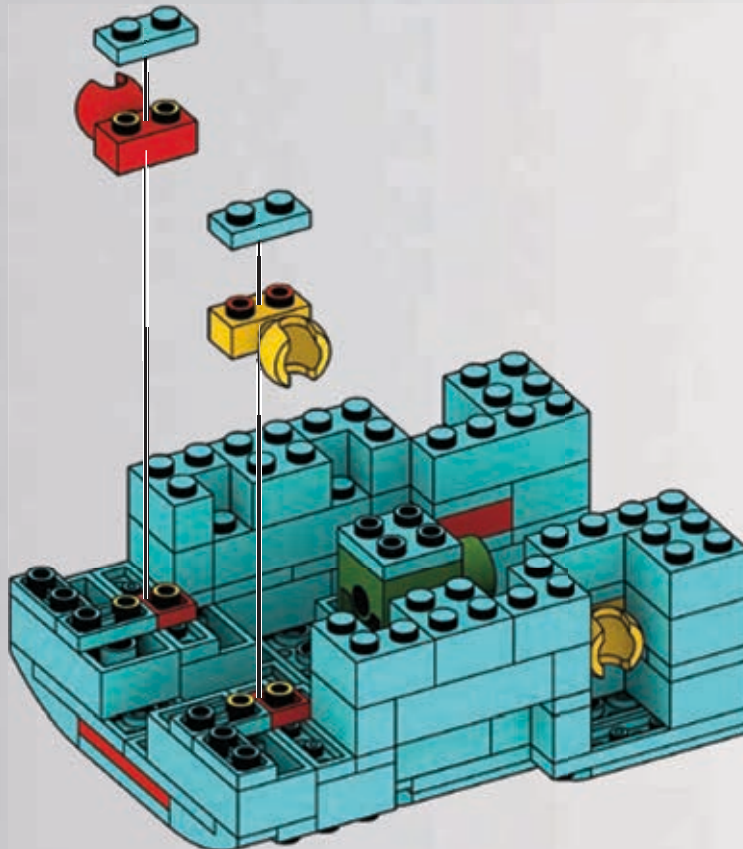

19

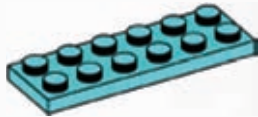

1x

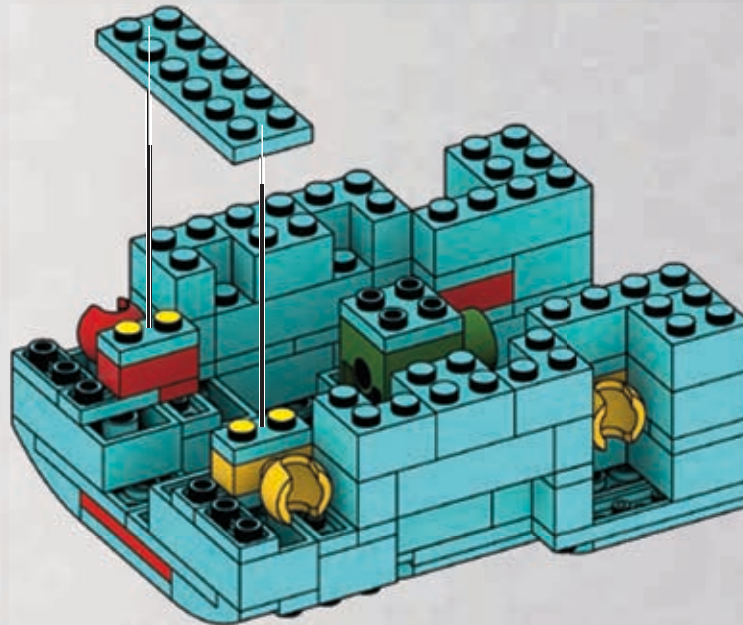

20



2x



1x

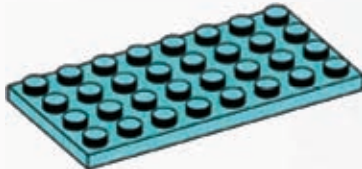

1x

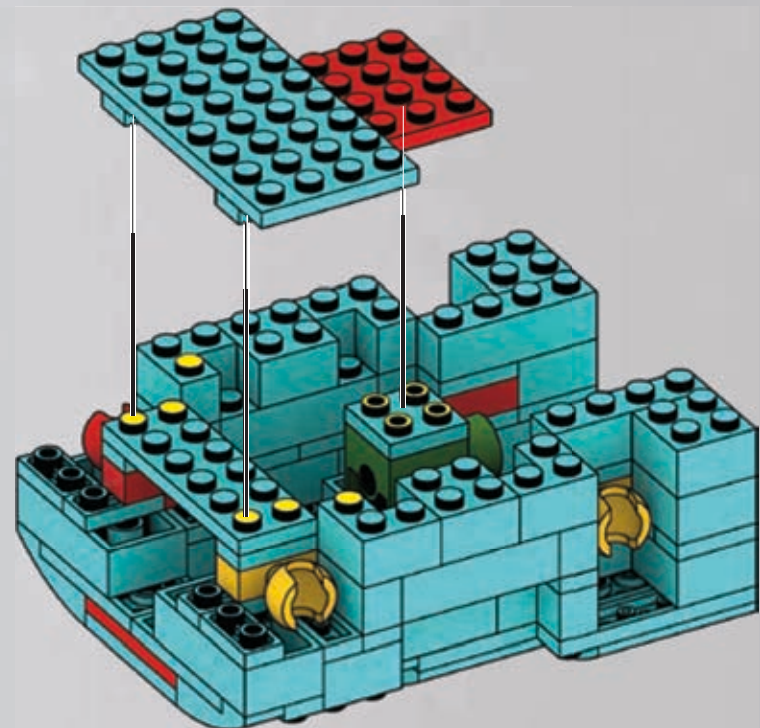
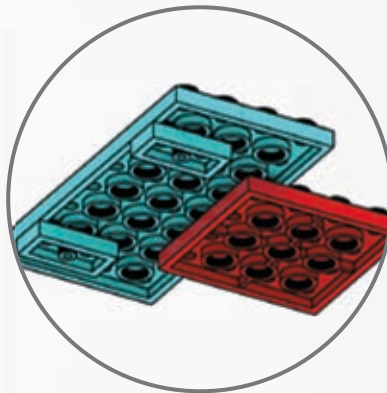
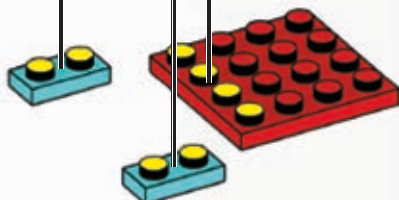
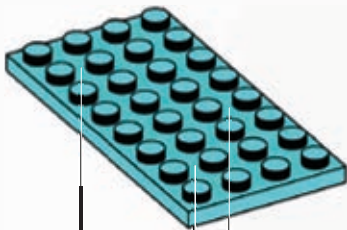

21

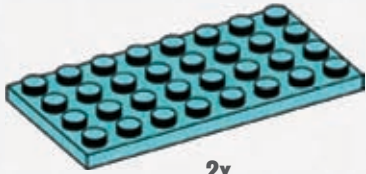

2x

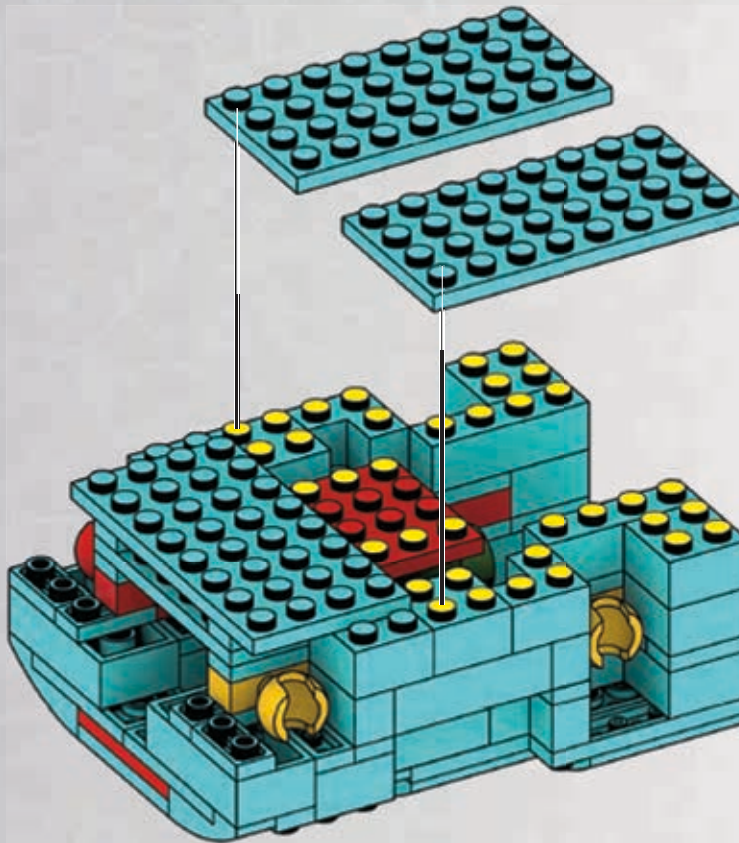

22

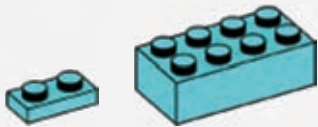

2x

2x

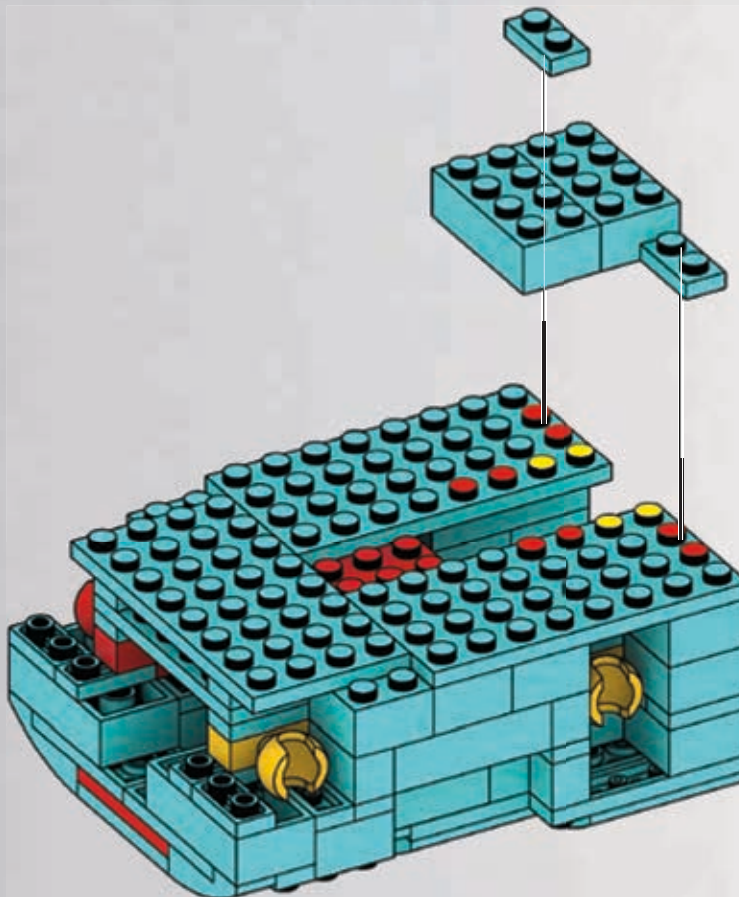

23

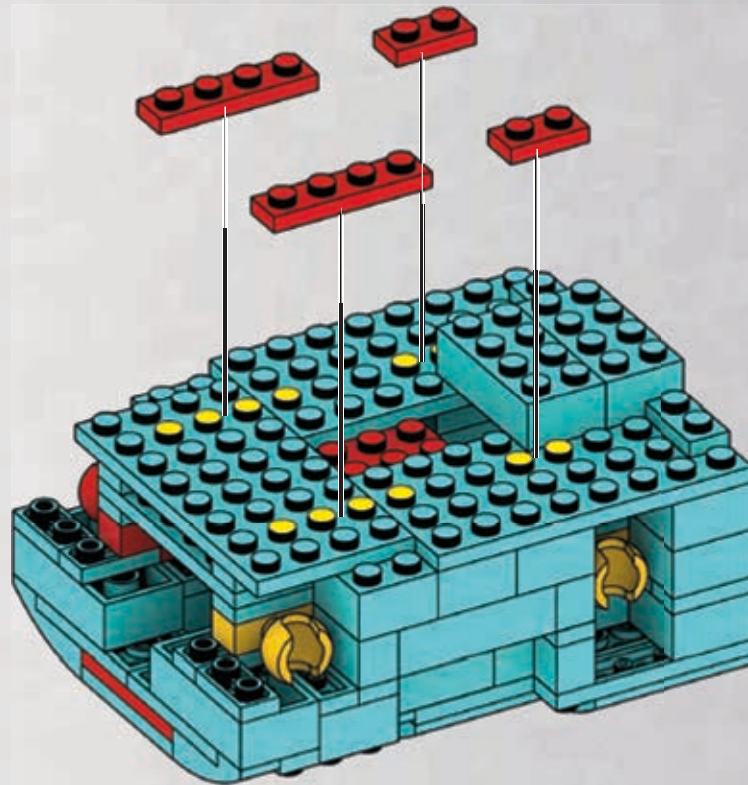
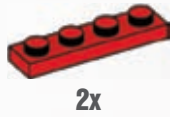

24

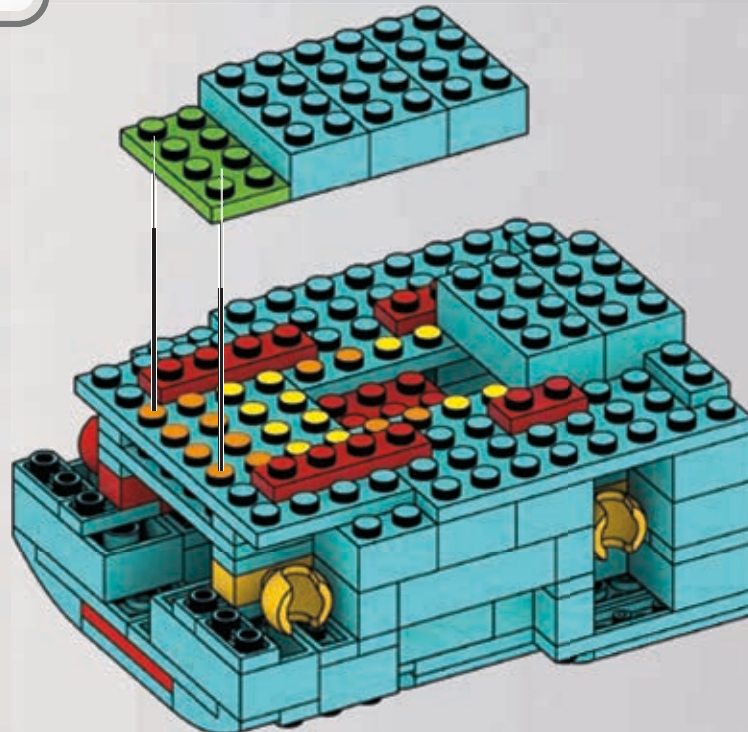
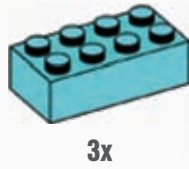
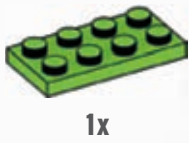

25



3x

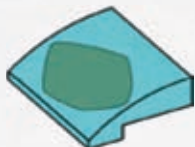

1x

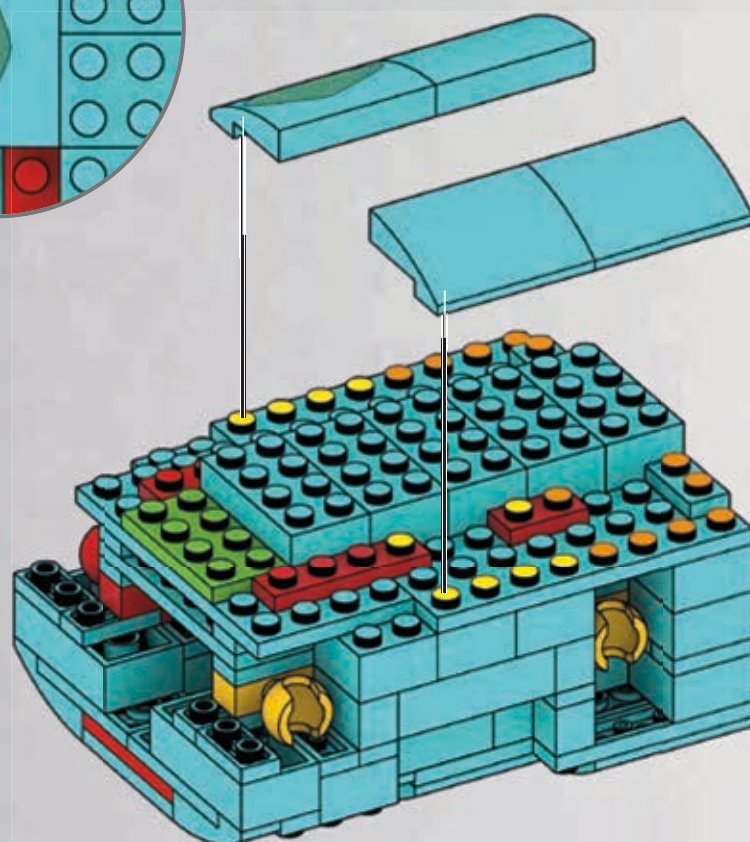
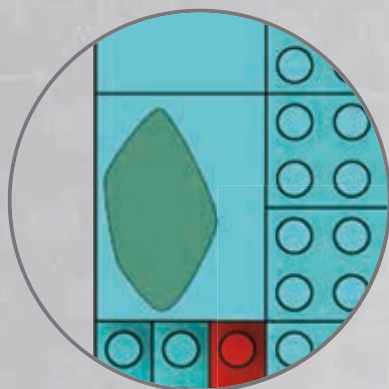

26



2x



1x



1x

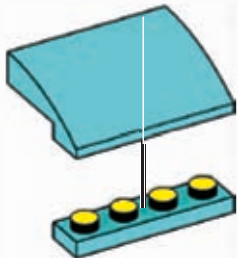

1

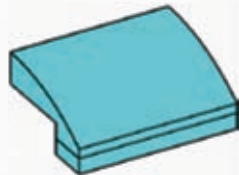

2

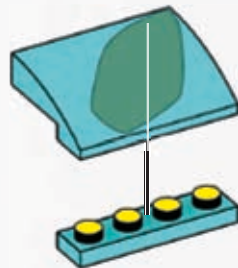

1

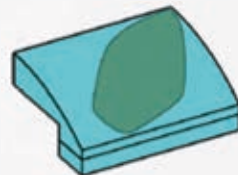

2

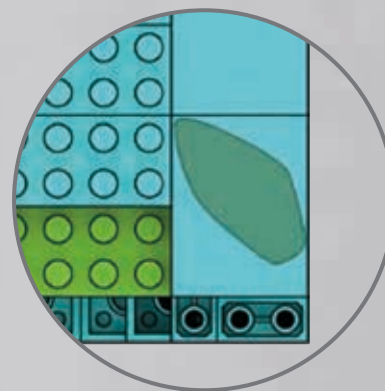
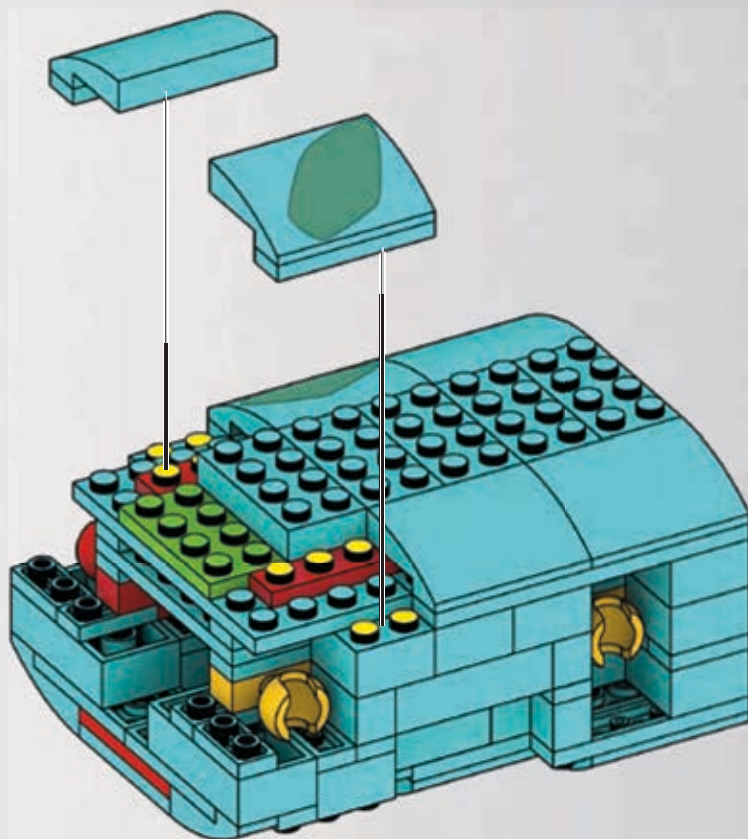

27



2x

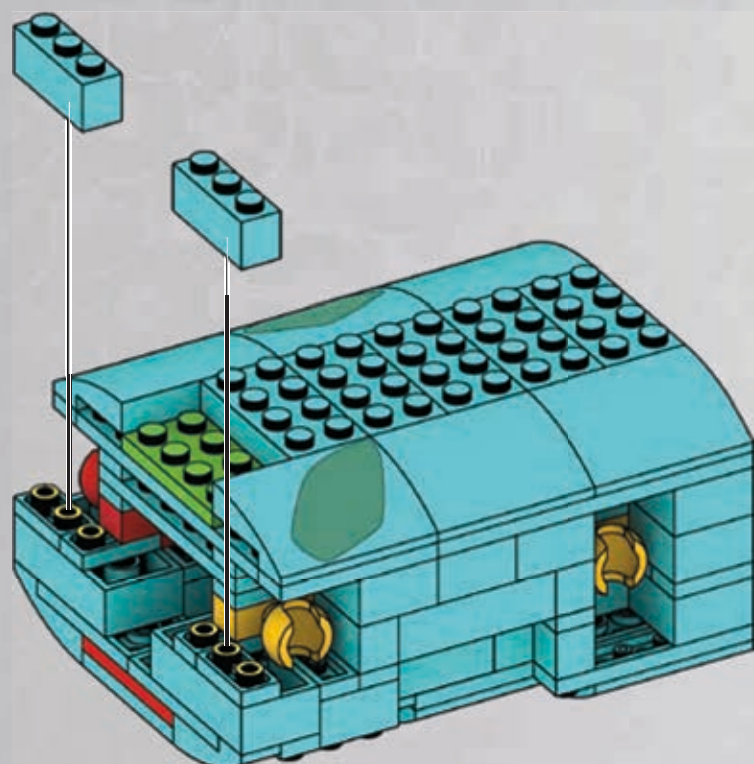

1

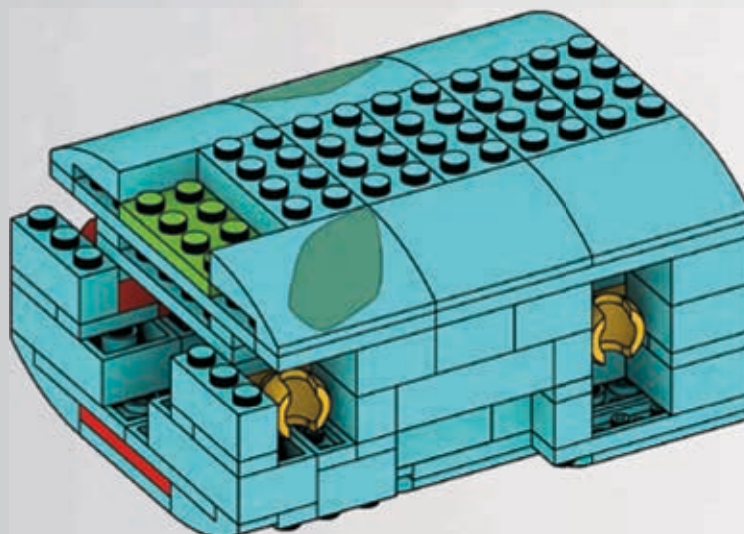

2

28

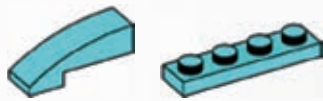

2x

3x

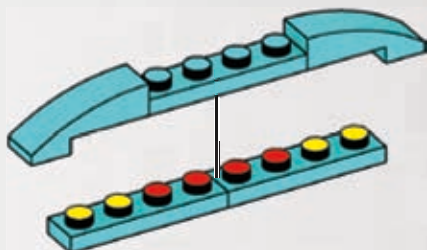

29



2x

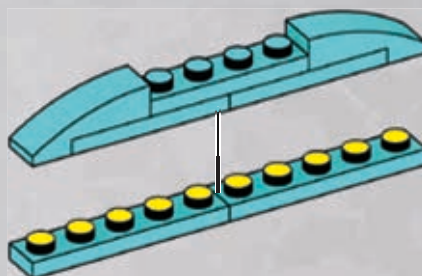

30



2x

2x

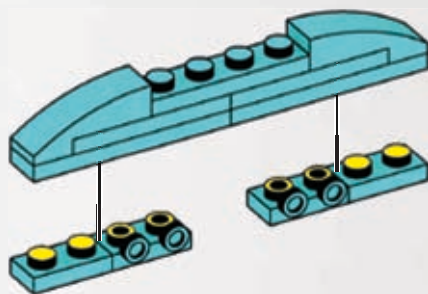

1

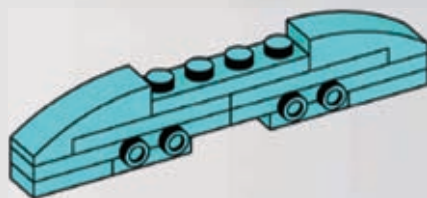

2

31

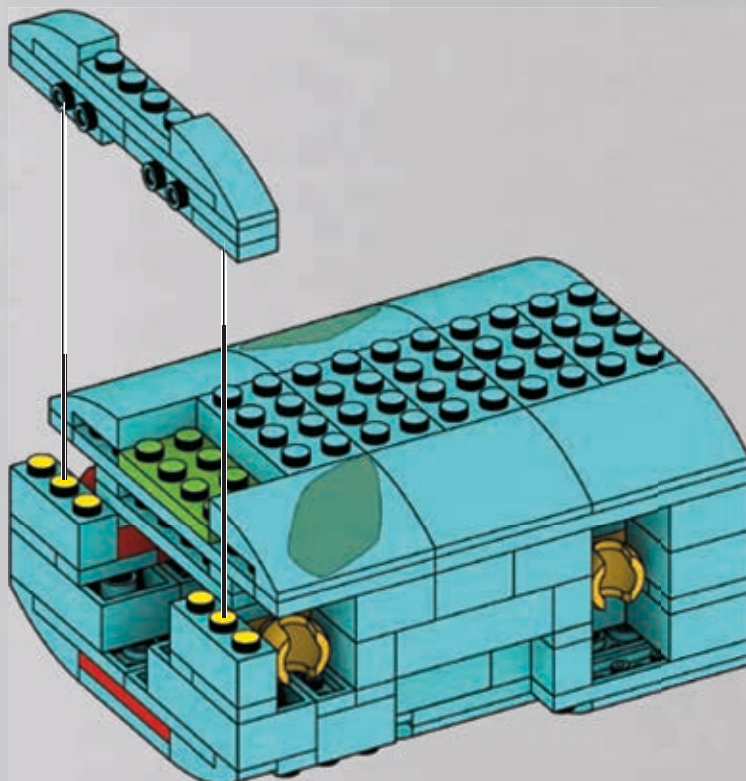

32



2x



1x

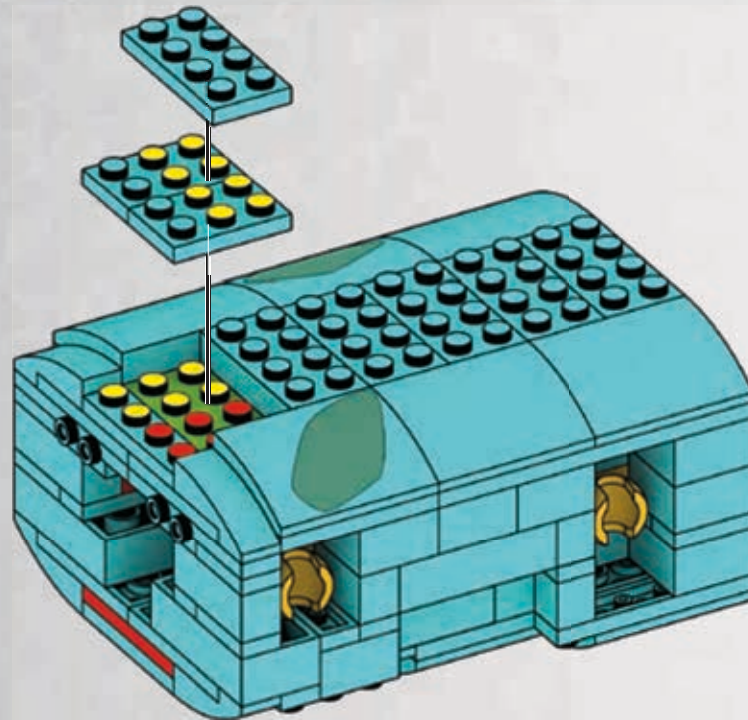

33



2x



1x

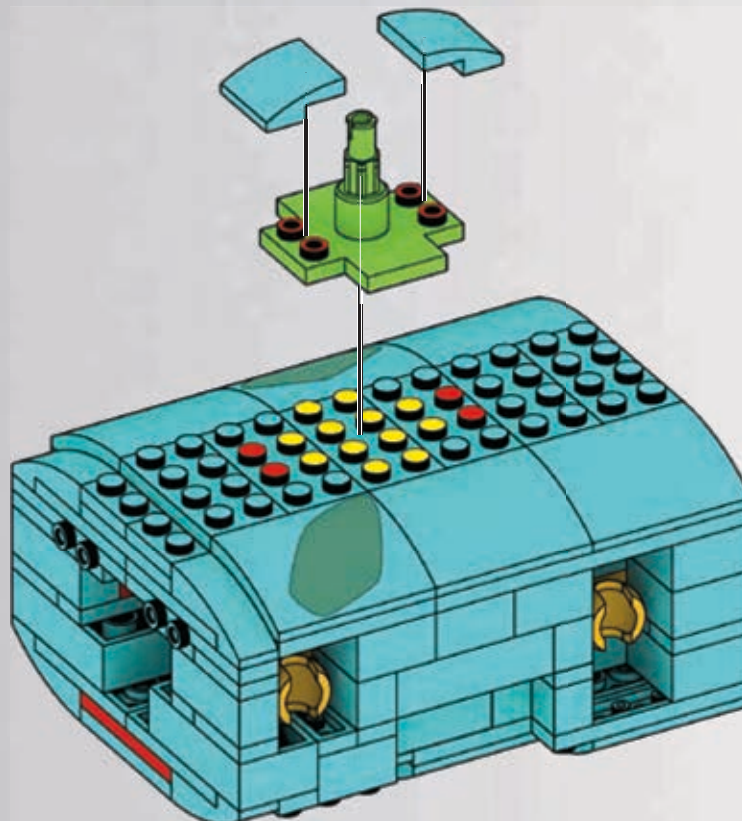

34



2x



1x

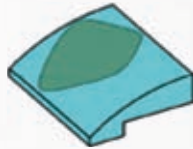

1x

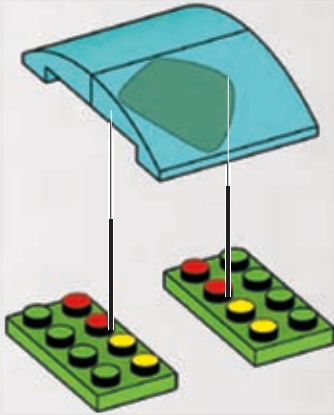

35



4x

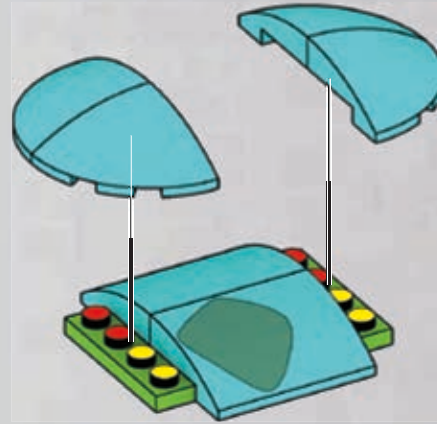

1

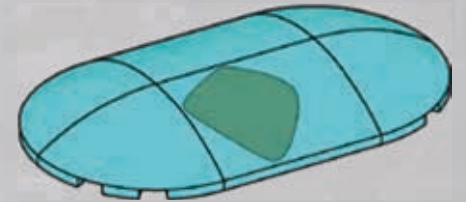

2

36

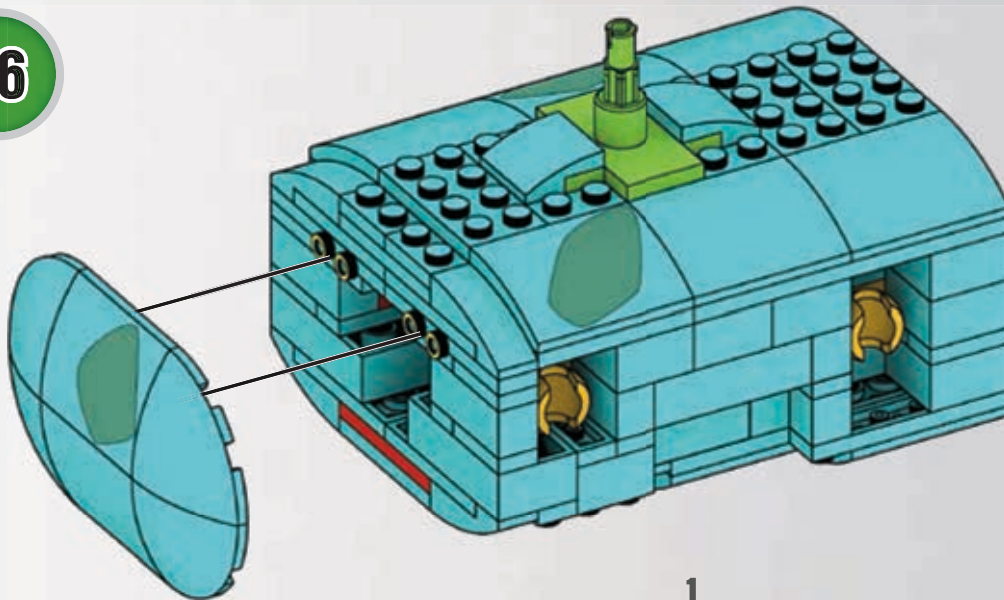

1

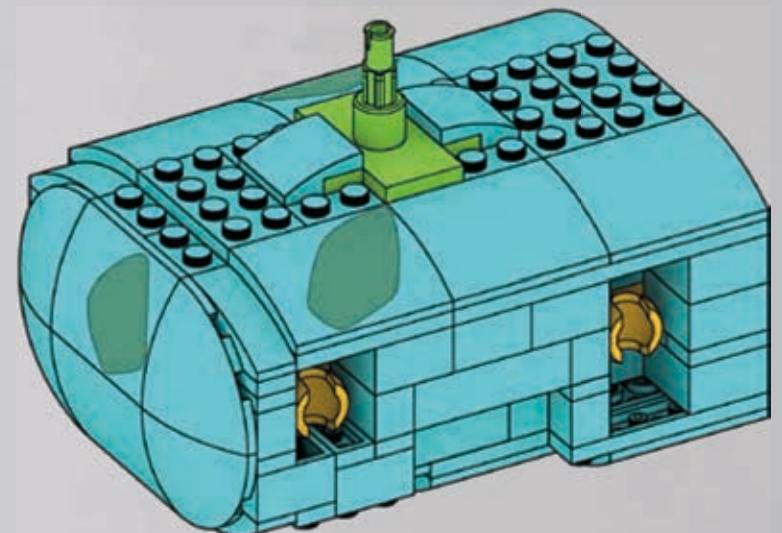
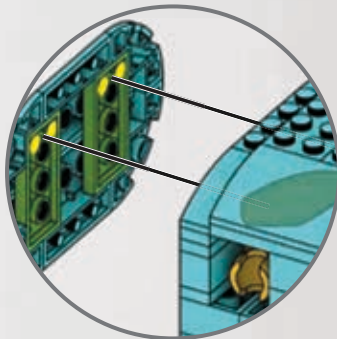

2



37

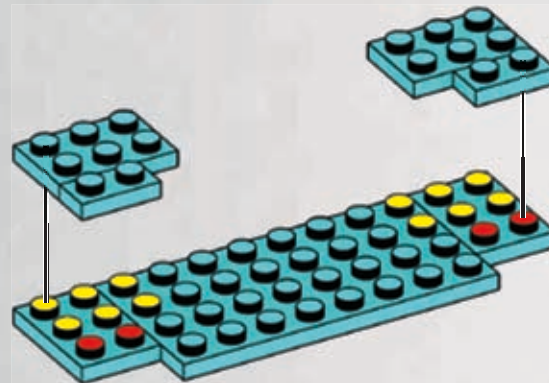
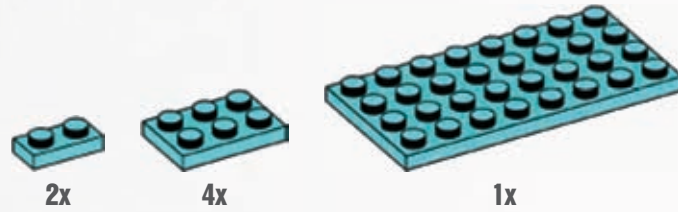

38

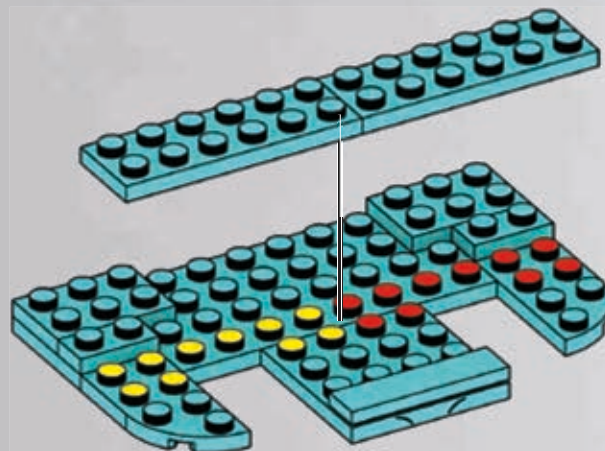
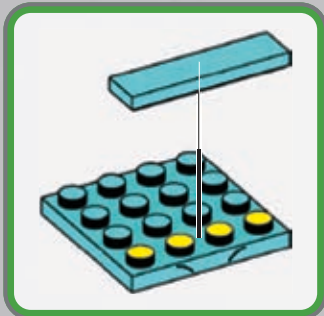

1

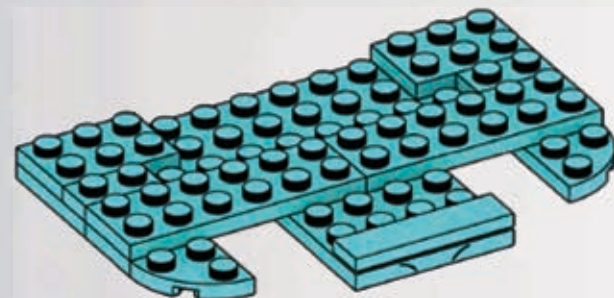

2

39

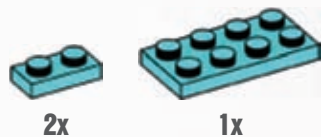

2x

1x

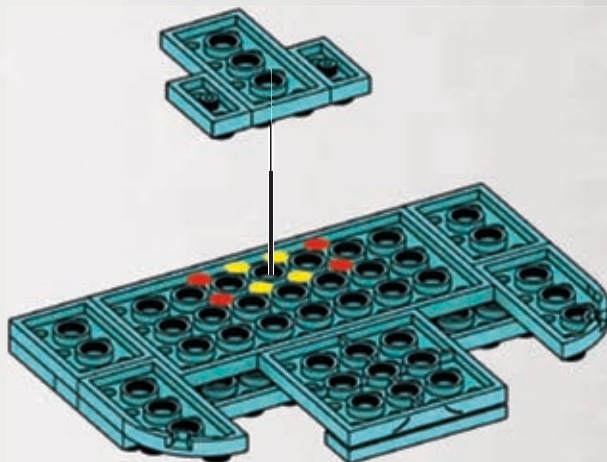

40



2x

1x

1x

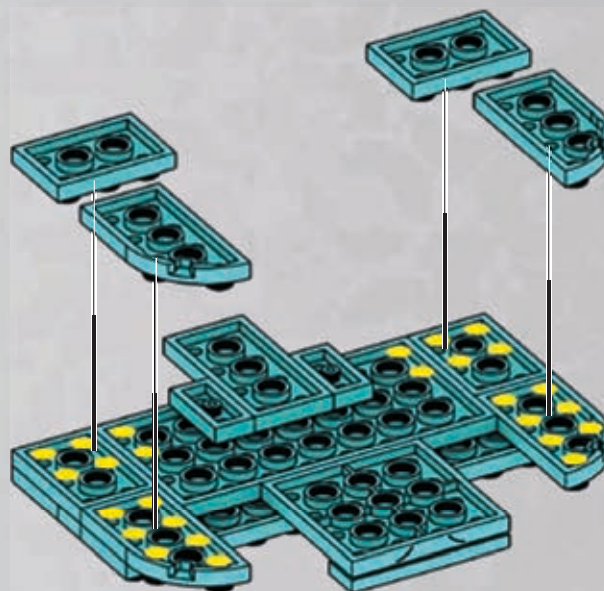

41

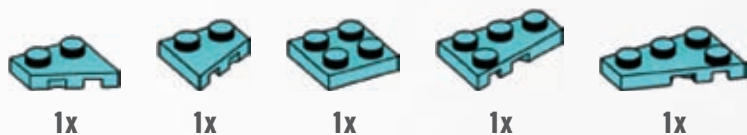

1x

1x

1x

1x

1x

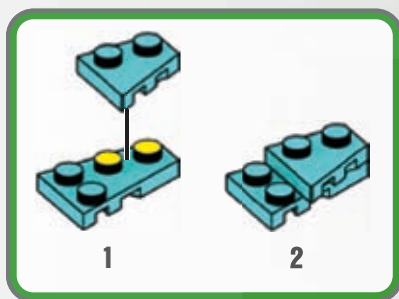

1

2

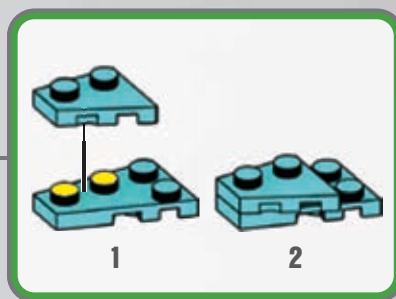

1

2

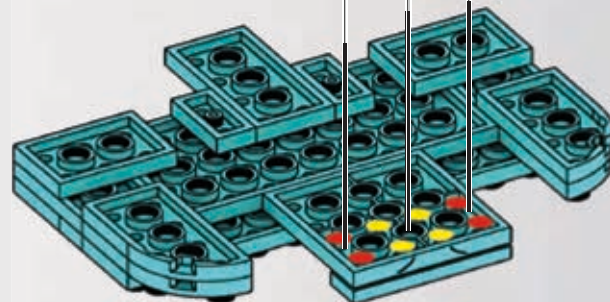

1

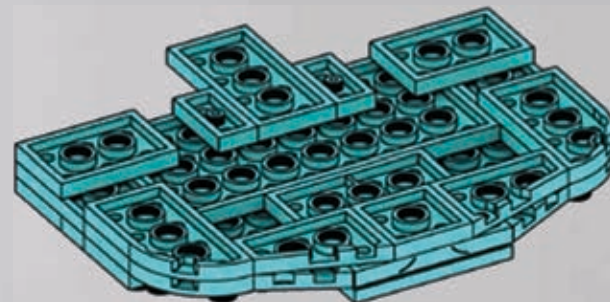

2

42

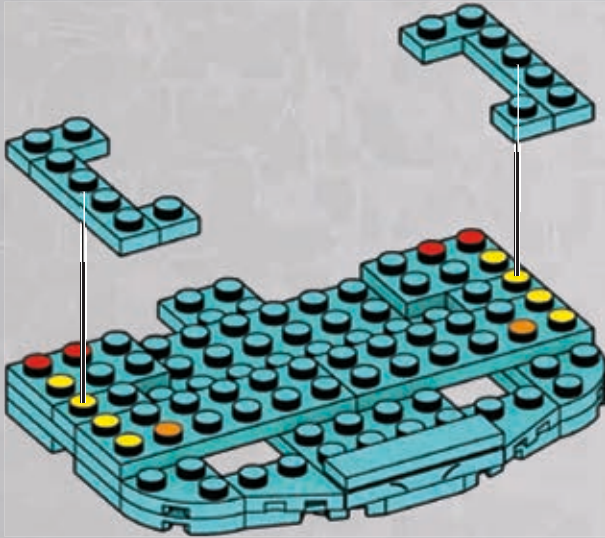

43

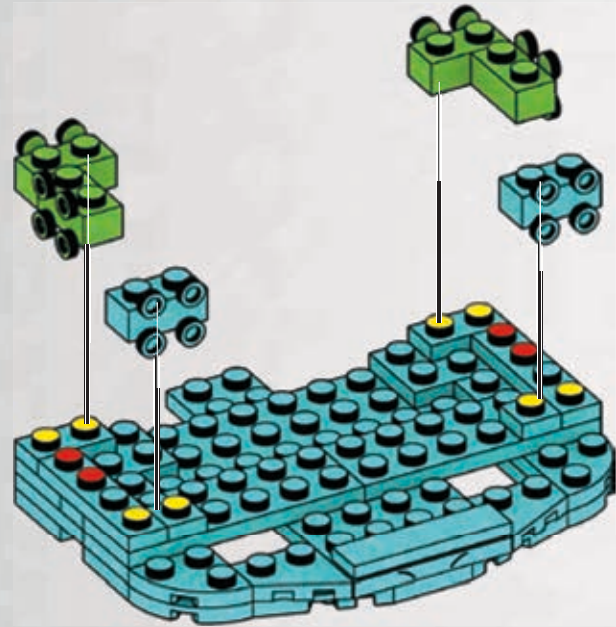
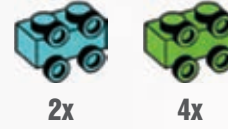

44

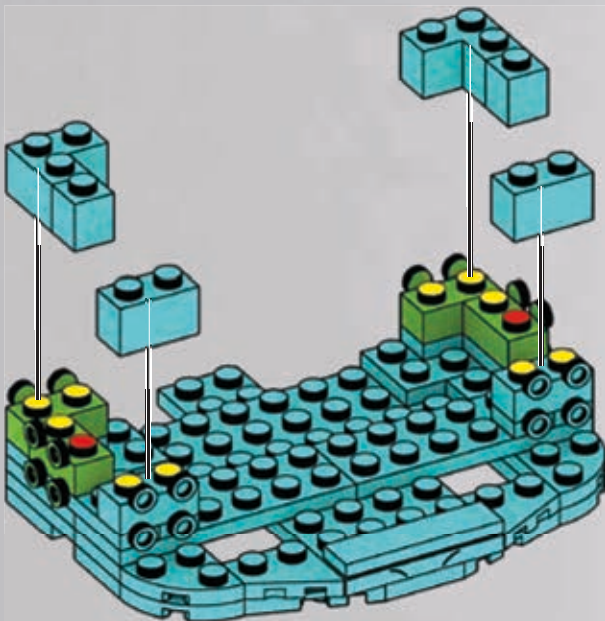

45

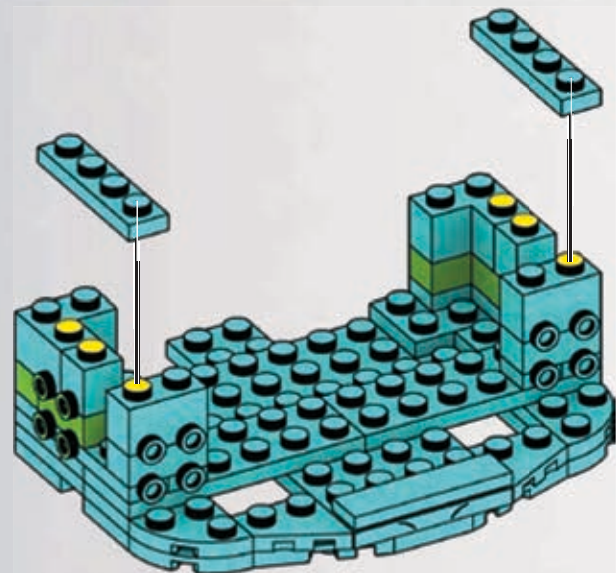
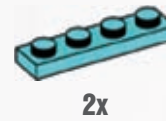

46

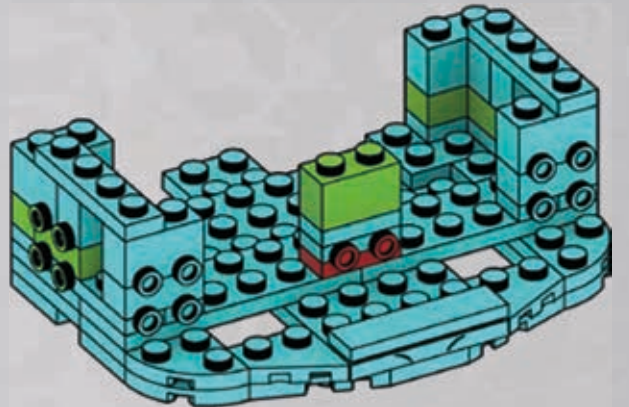
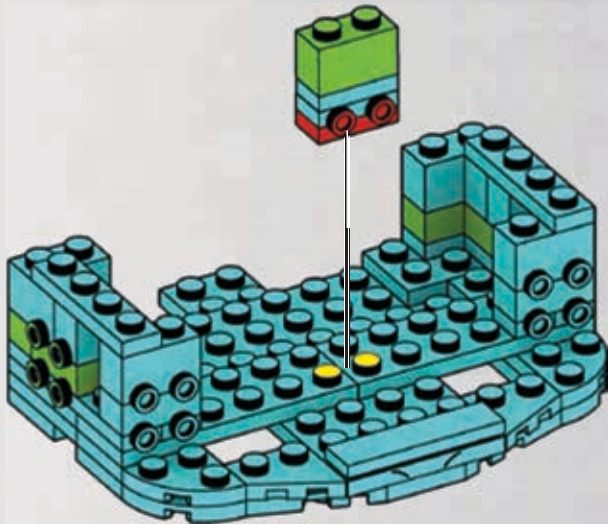
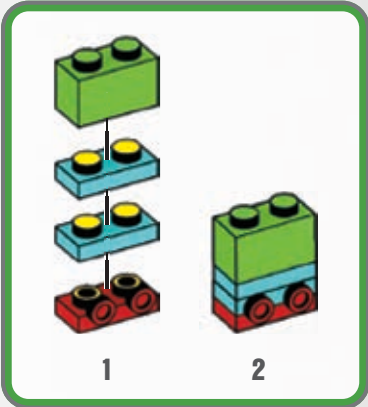

47

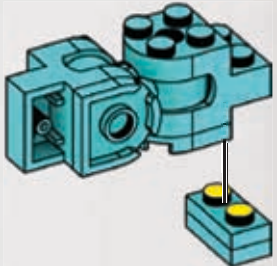
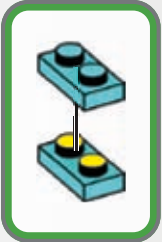
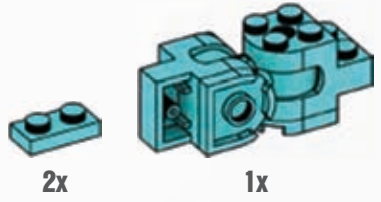

48

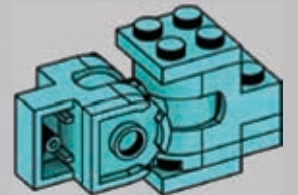
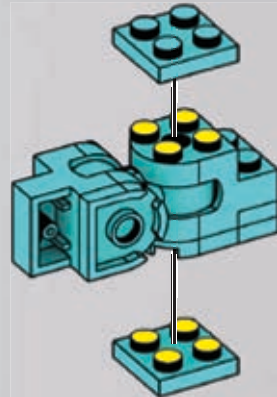

49



2x



1x

50



1x

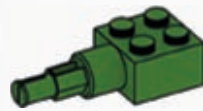

1x

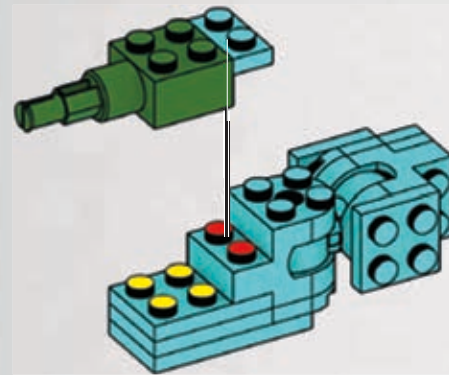
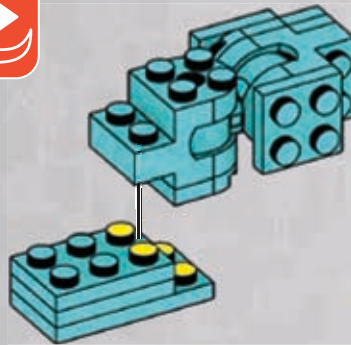
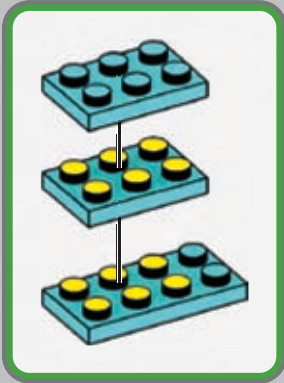

51



1x



1x

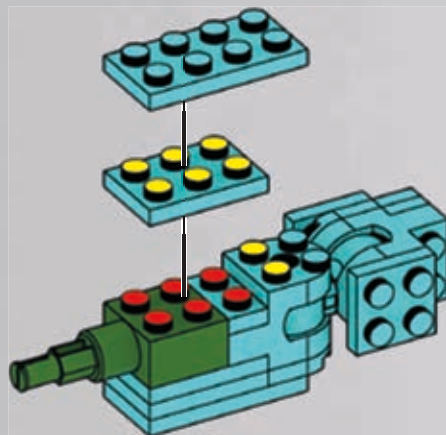

1

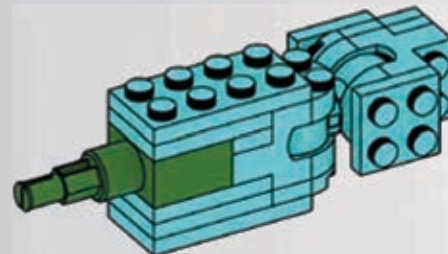

2

52

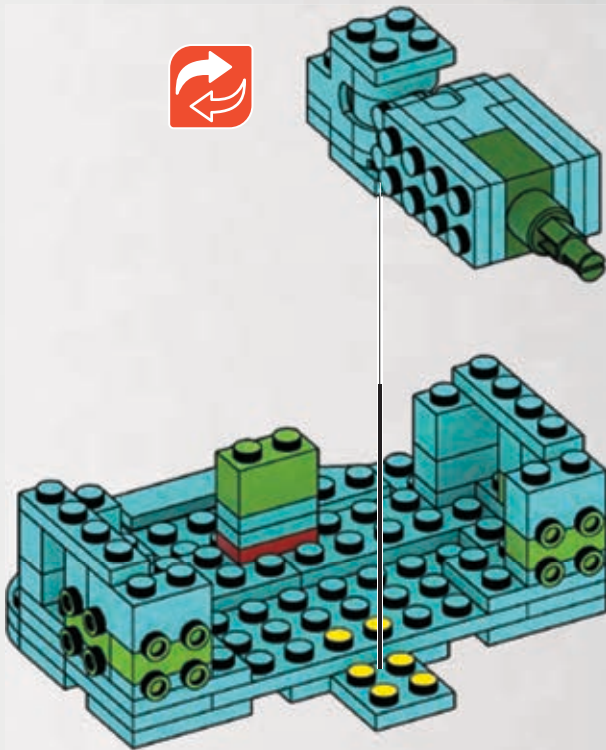

1

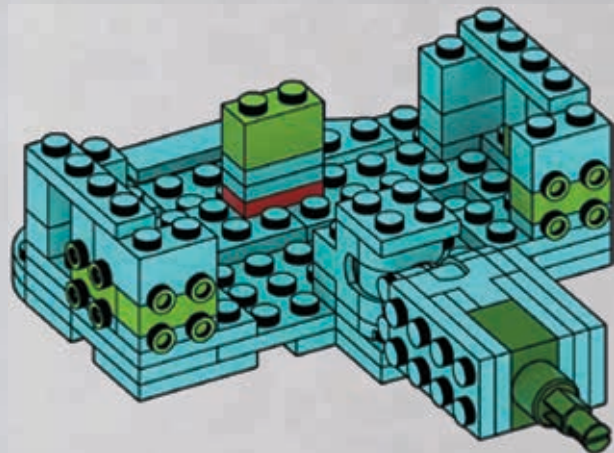

2

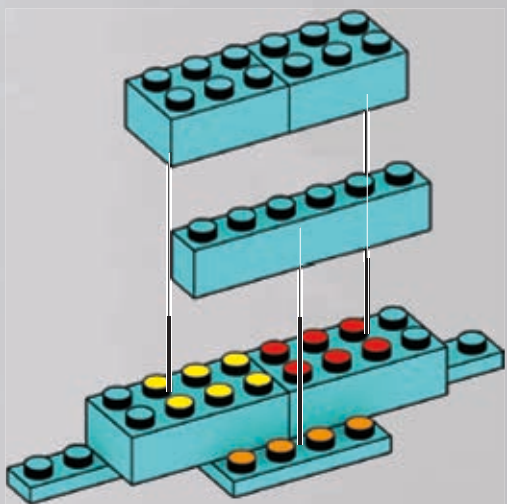
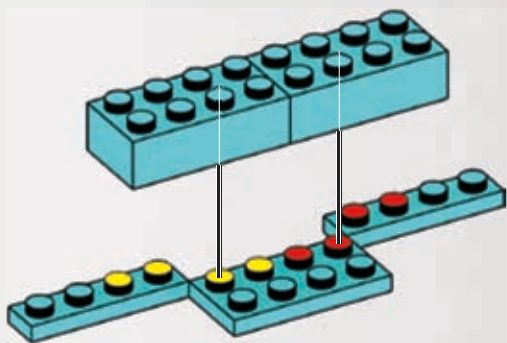
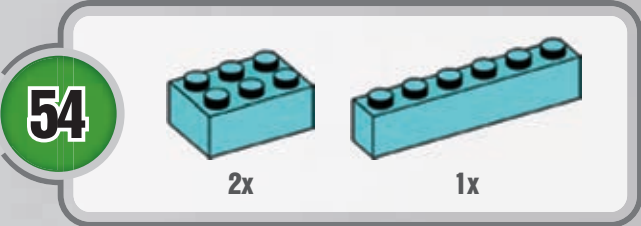
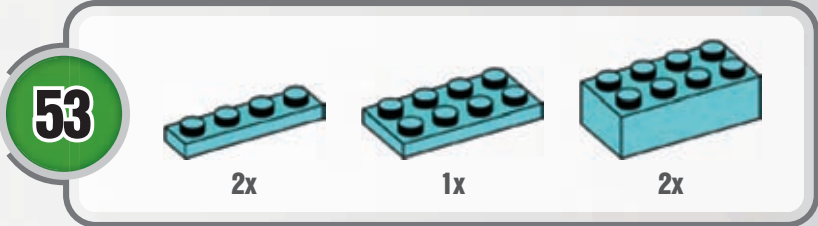

55



3x

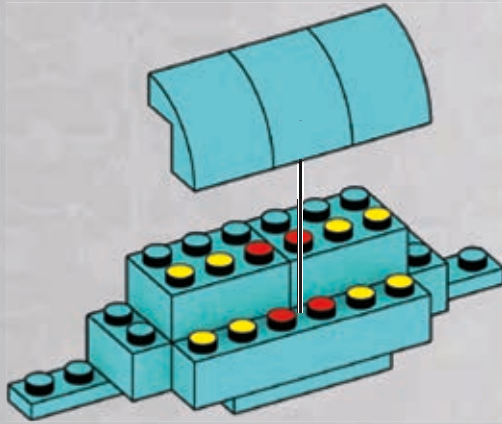

1

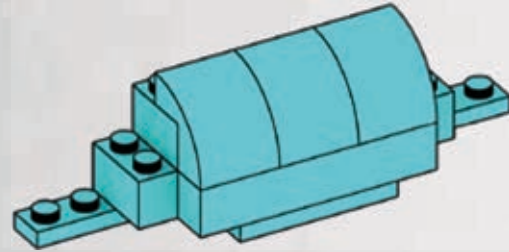

2

56

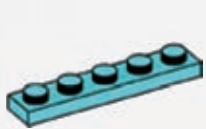

2x



2x

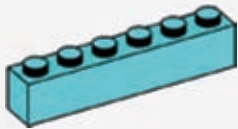

1x

57



2x

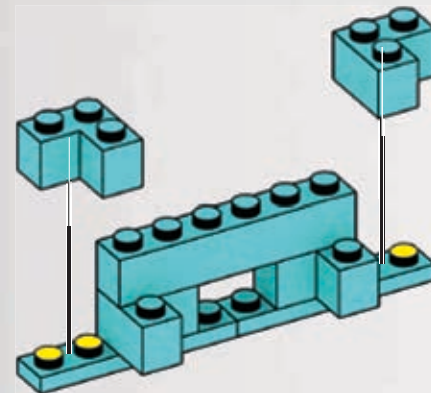
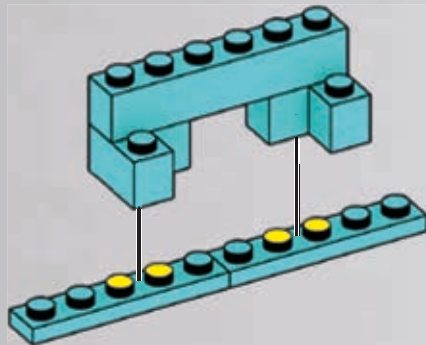
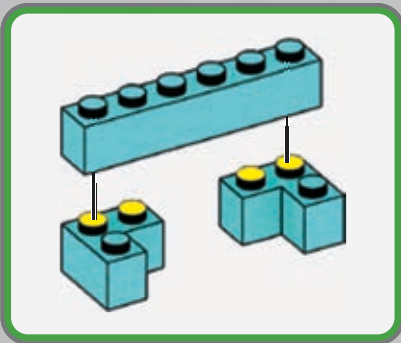

58



2x

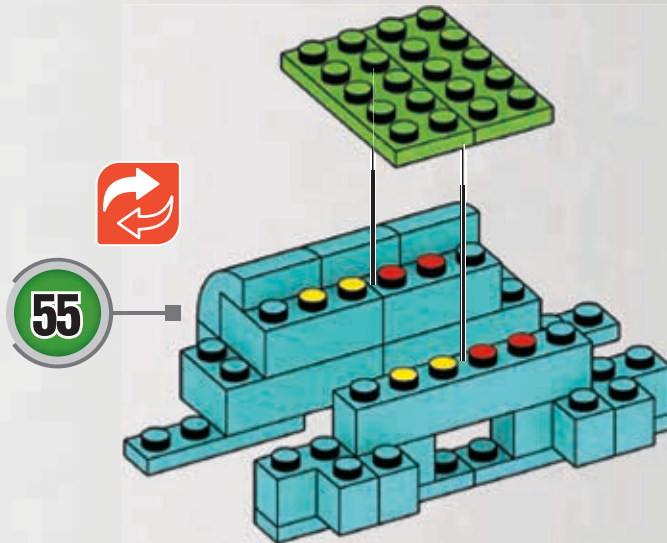

59



2x



2x



2x



4x

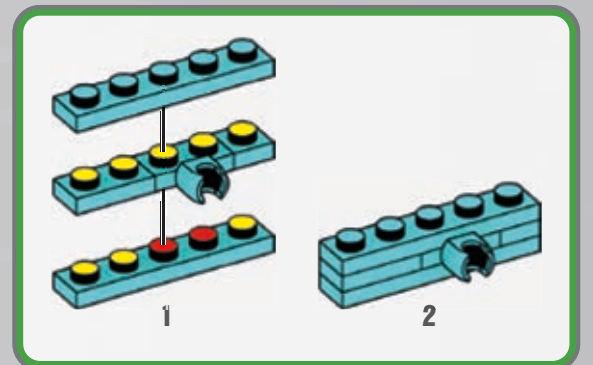
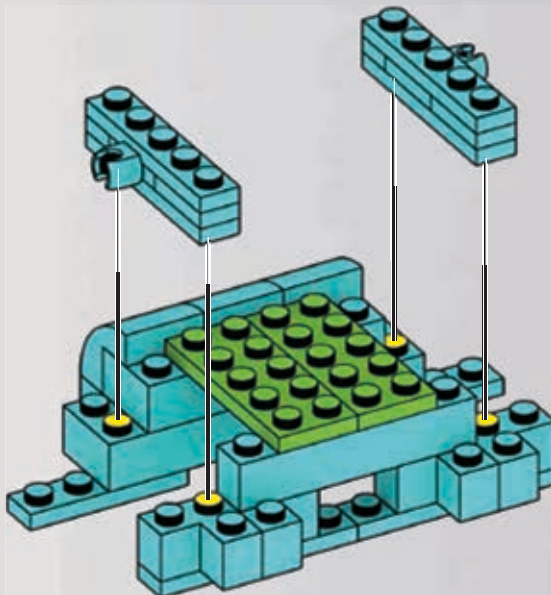
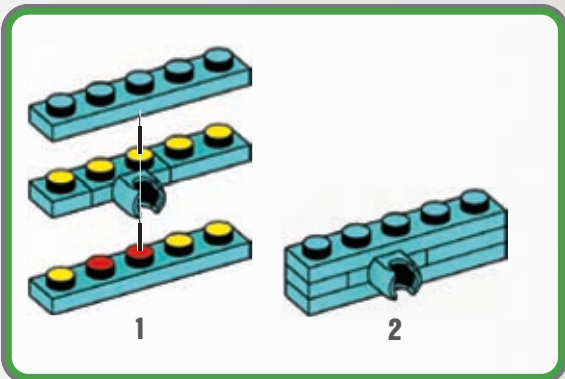

60



2x



2x

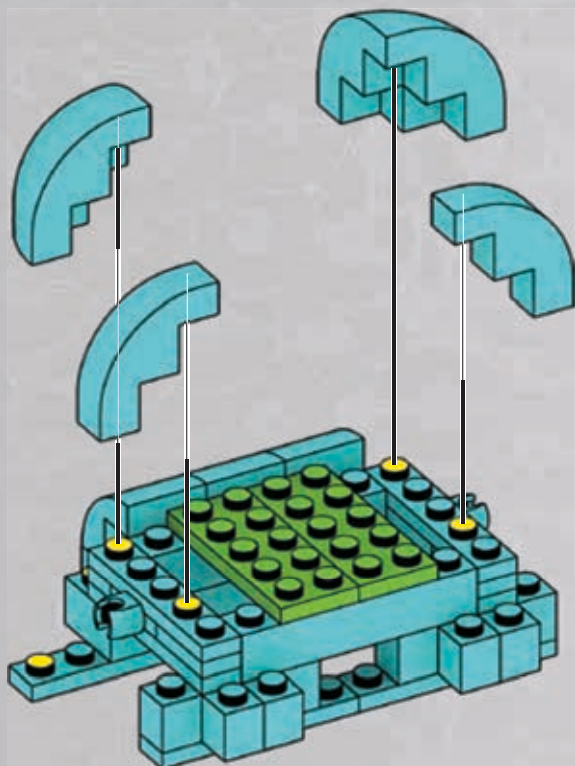

61



2x



2x

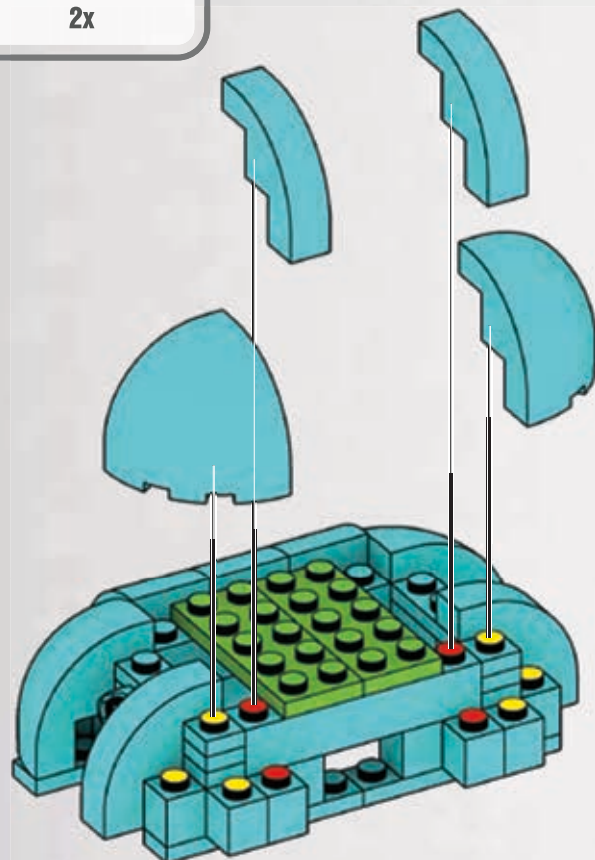

62



2x



3x

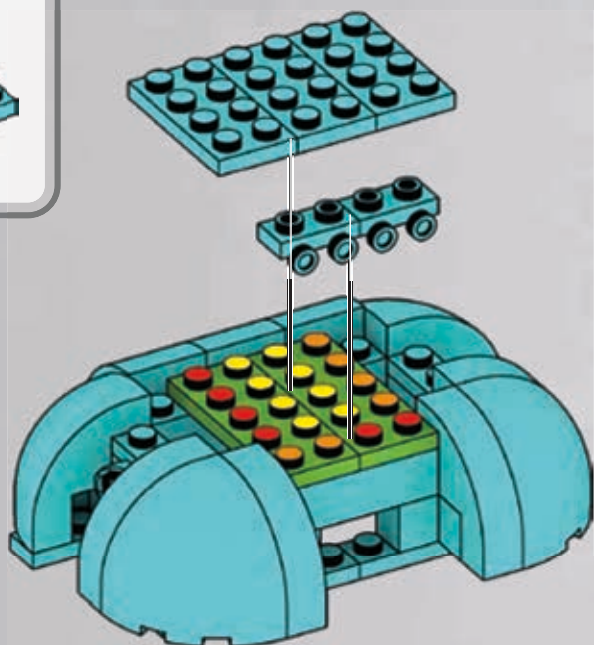

63



2x

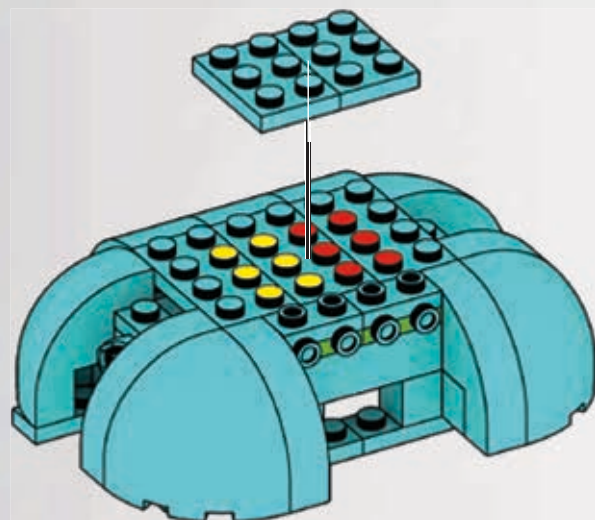

64



1x



2x

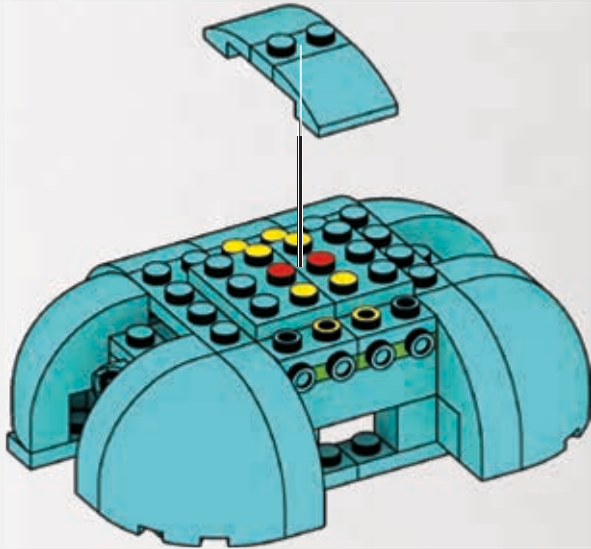

65



2x



4x

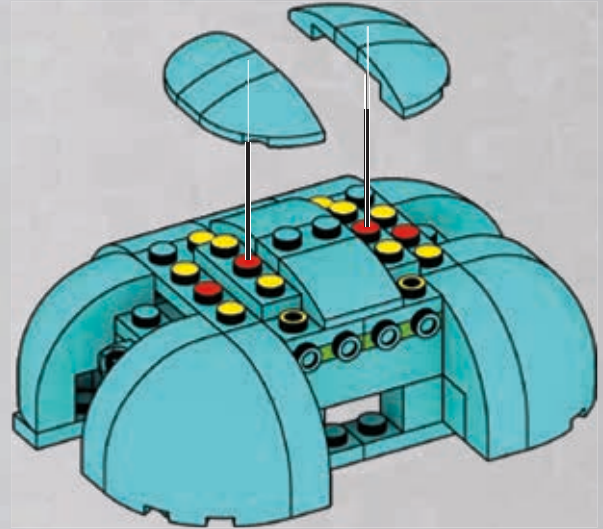

66

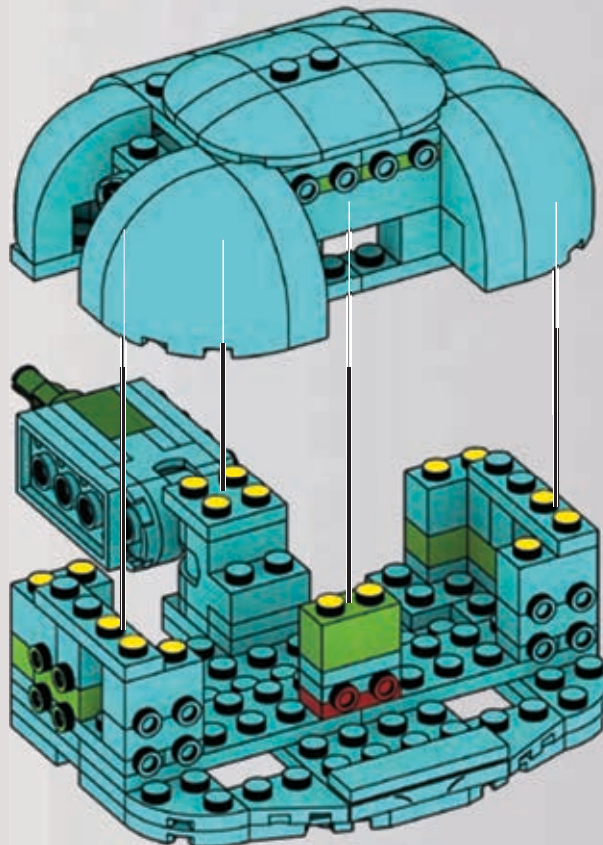

67

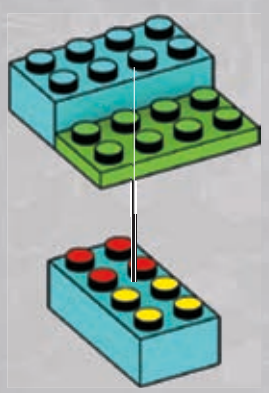
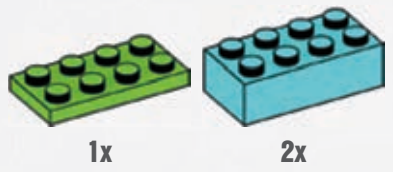

68

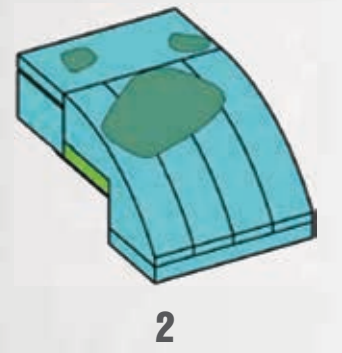
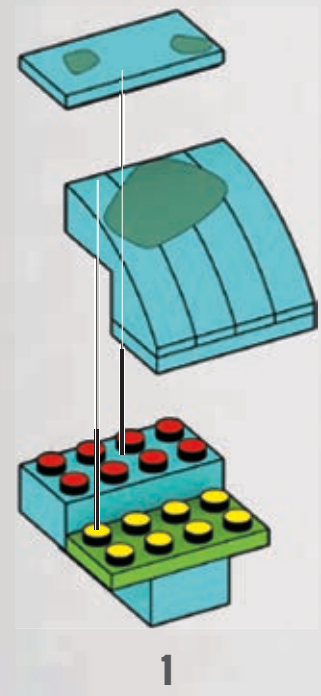
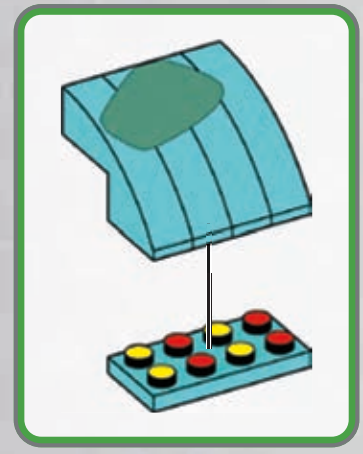
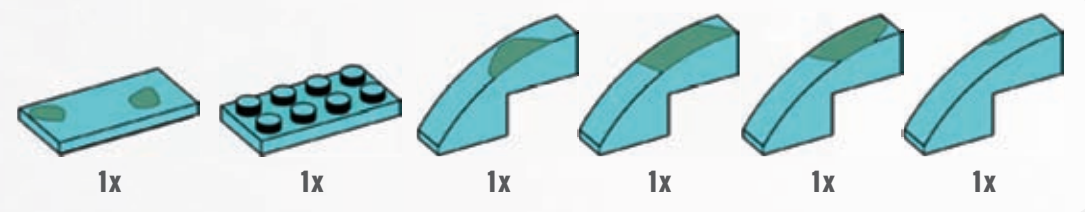

69

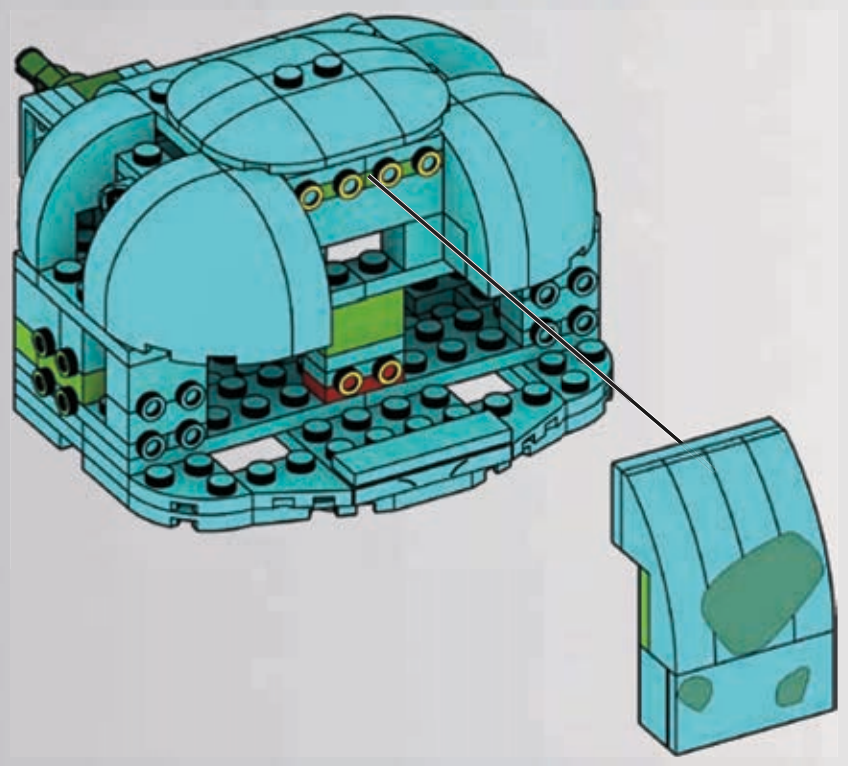

70



2x



1x



1x



1x



1x



1x



1x

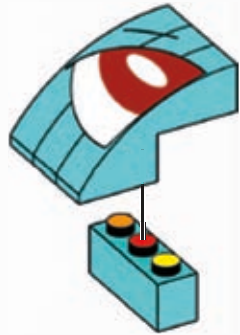

1



2

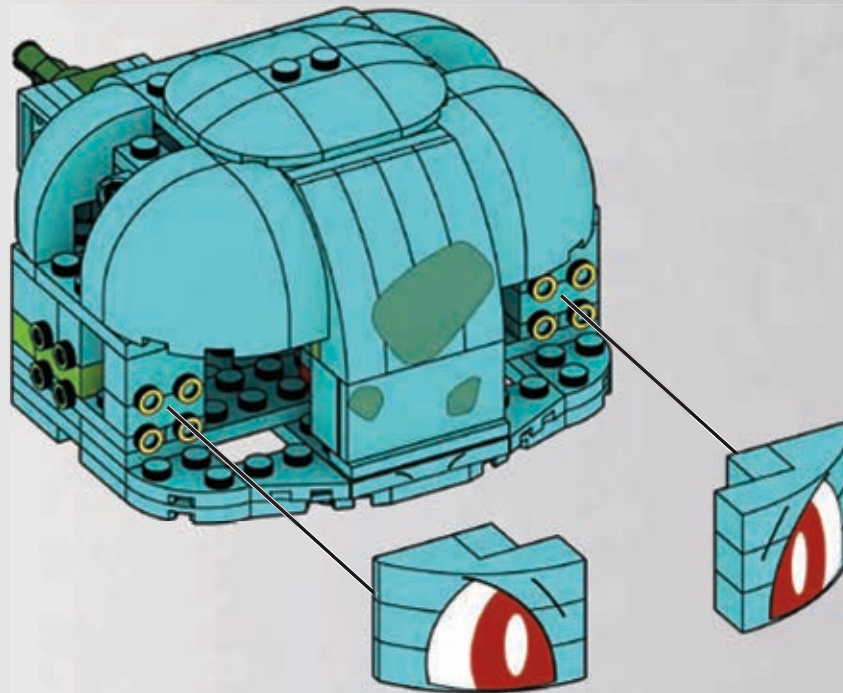

1

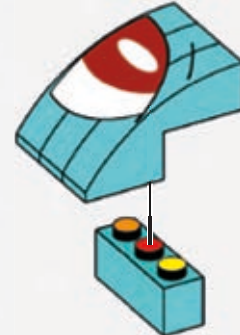

1



2

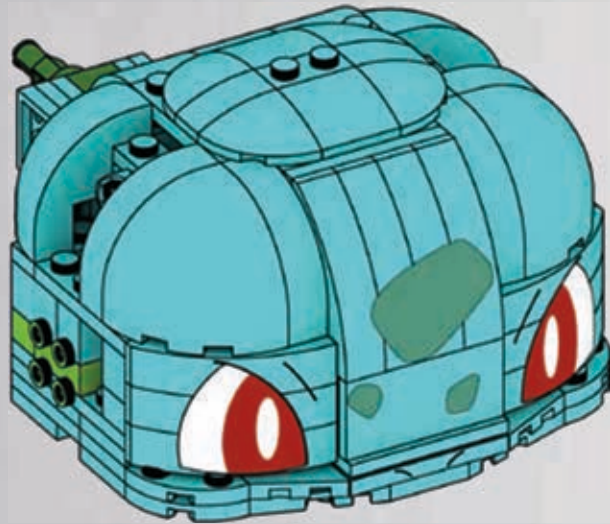
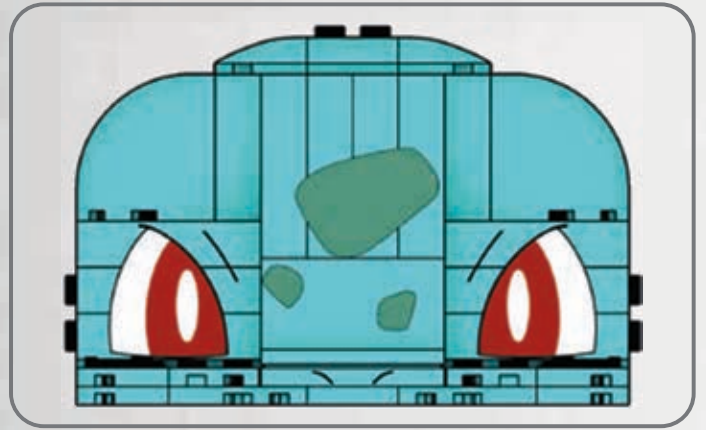

2



71



2x



2x



2x



2x



4x

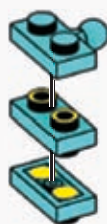

1

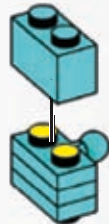

2

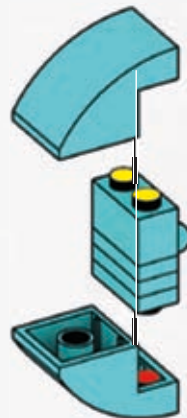

3

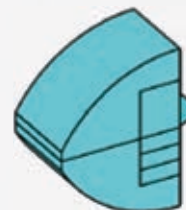

4

x2

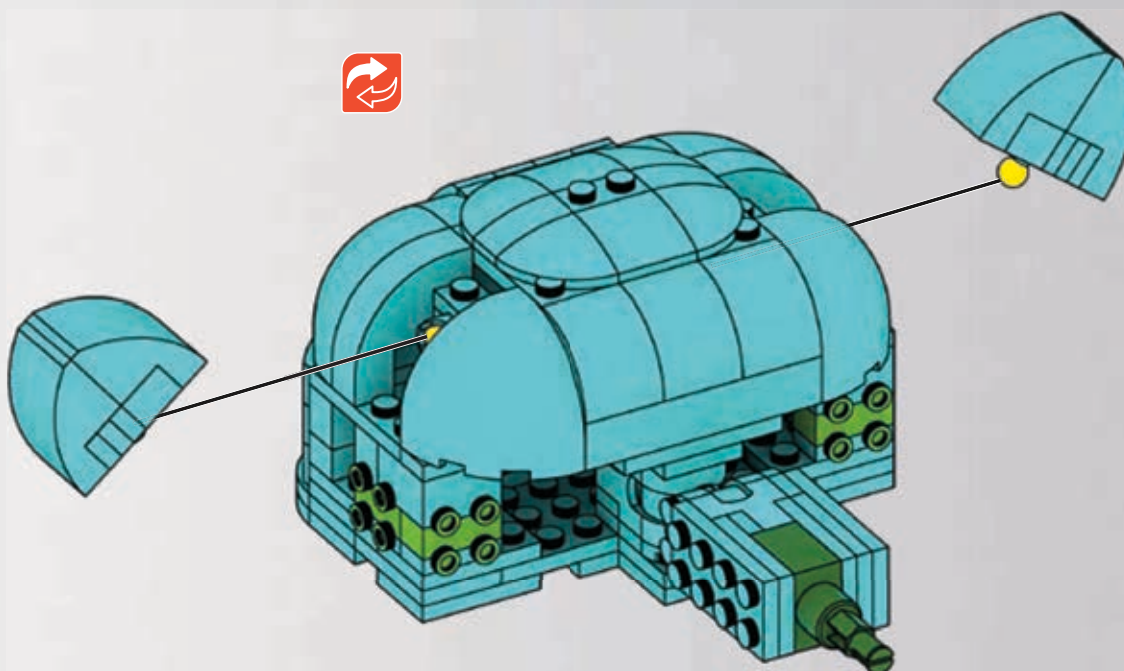

72

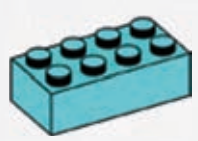

2x



4x

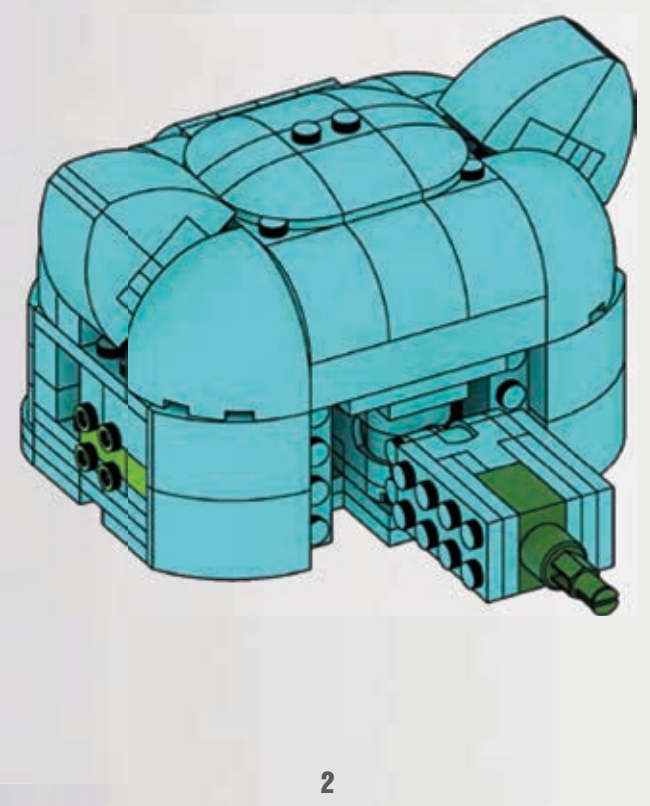
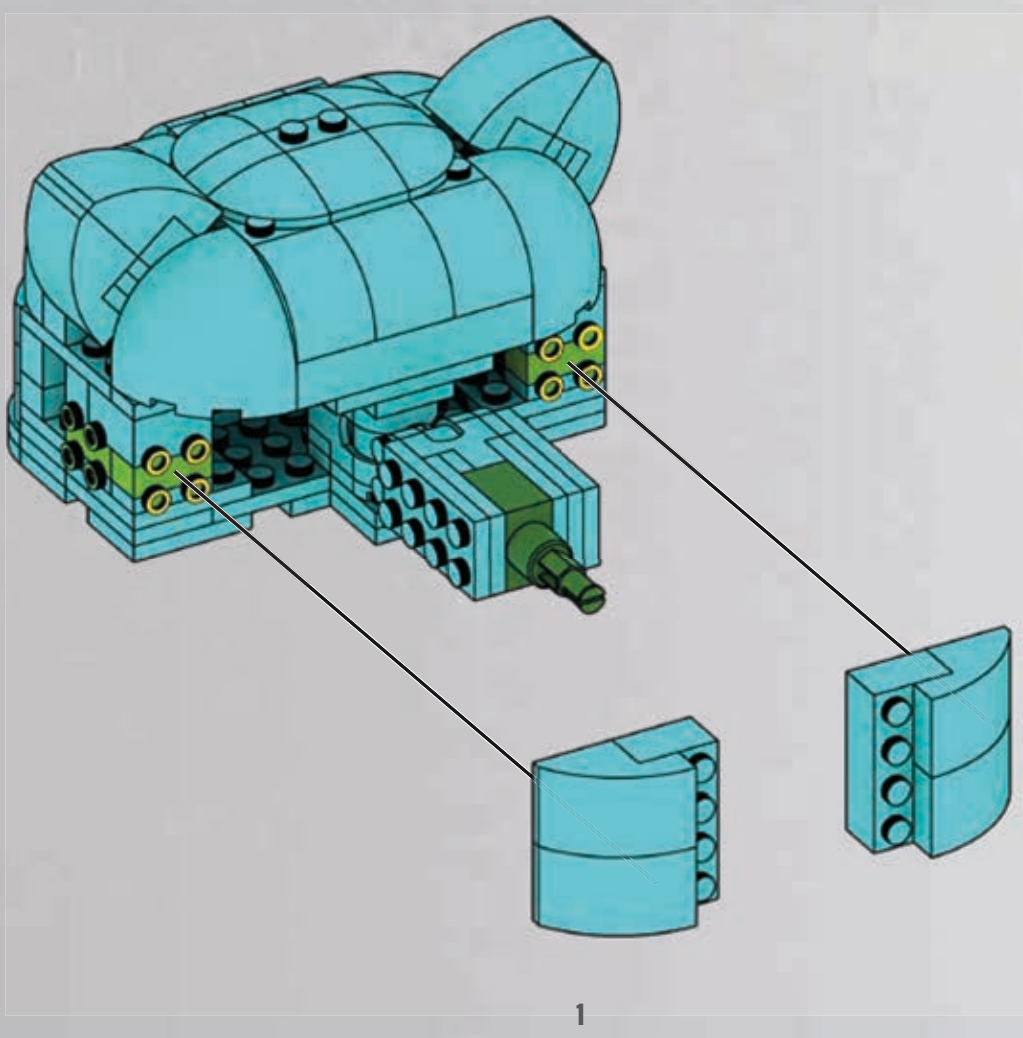
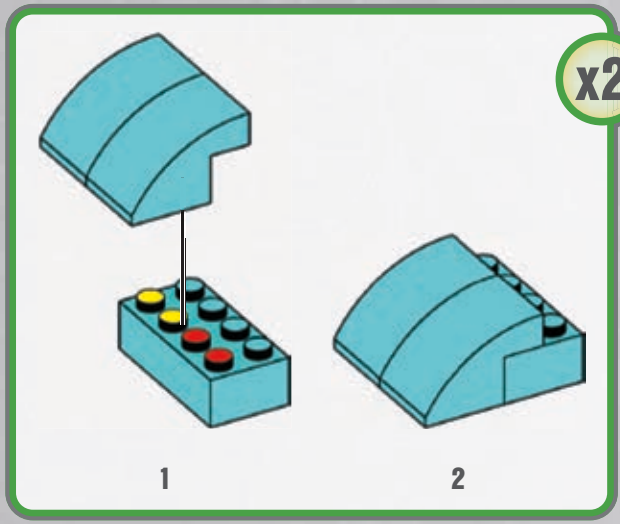

73

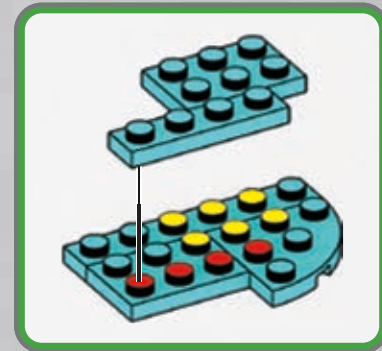
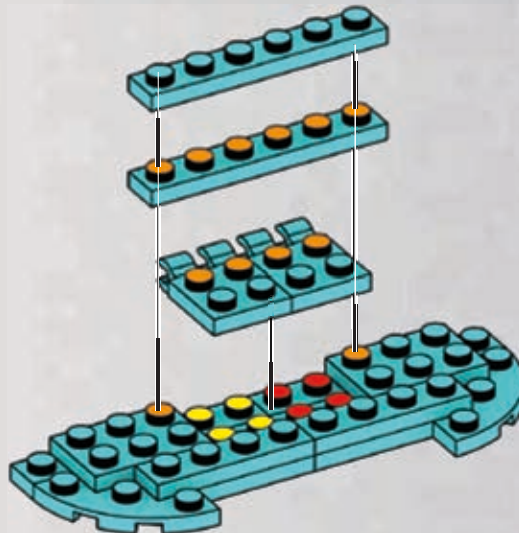
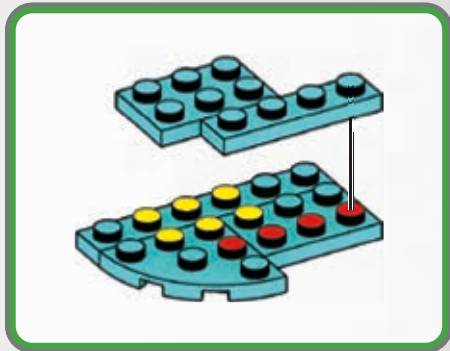
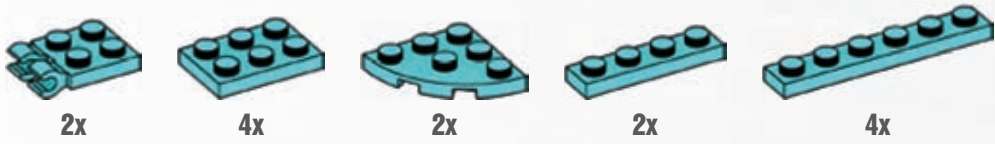

74

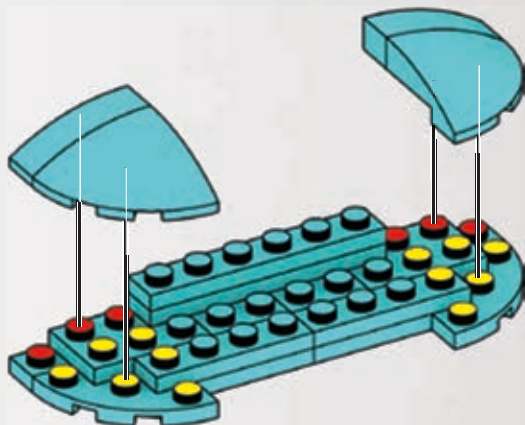
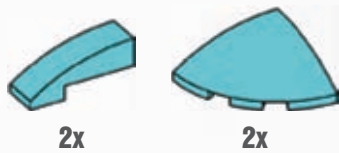

75

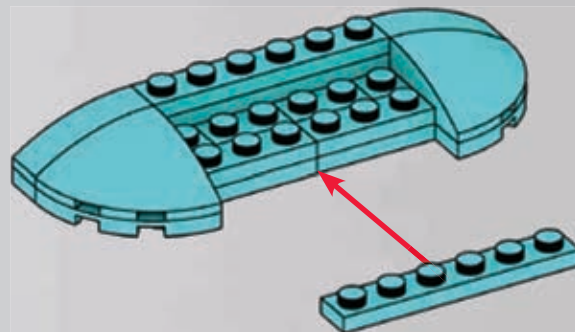
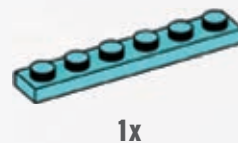

76



2x

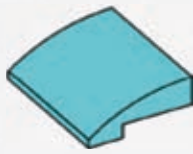

1x

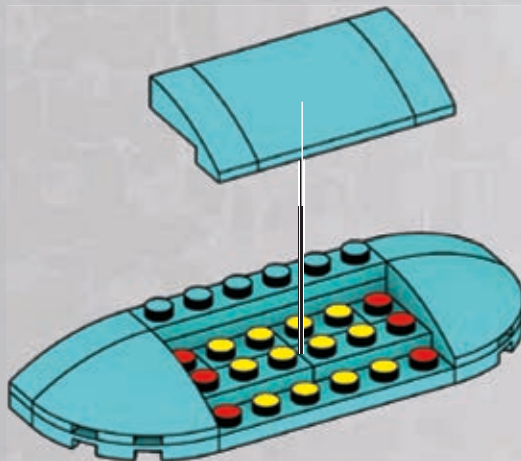

1

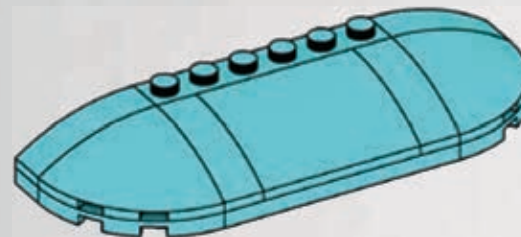

2

77



2x



2x

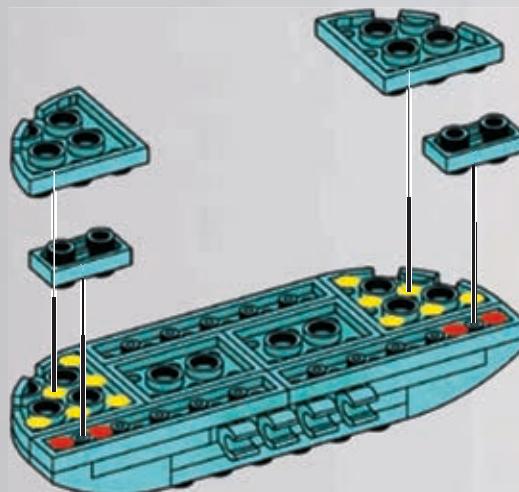

78



3x

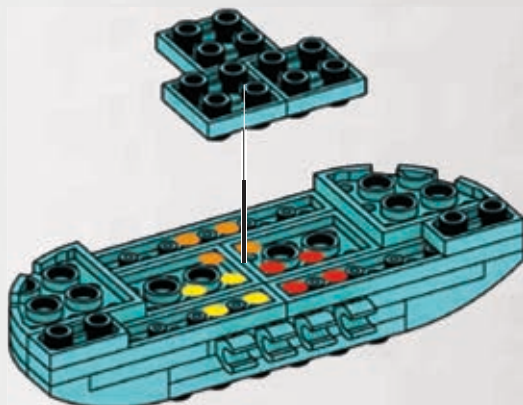

1

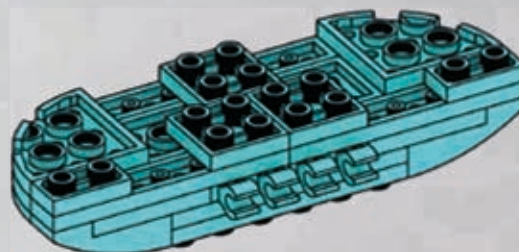

2

79

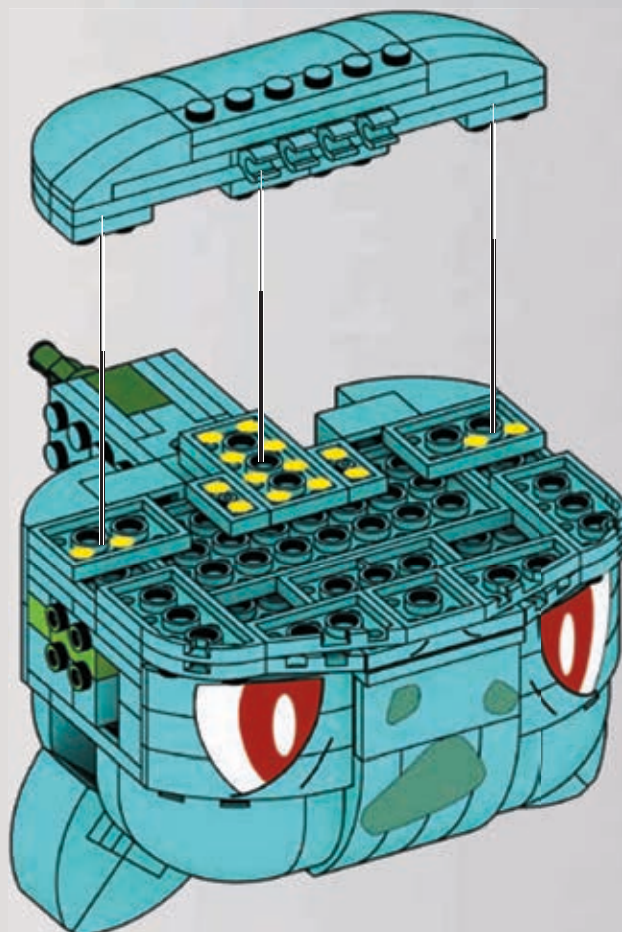

80



2x



2x



2x

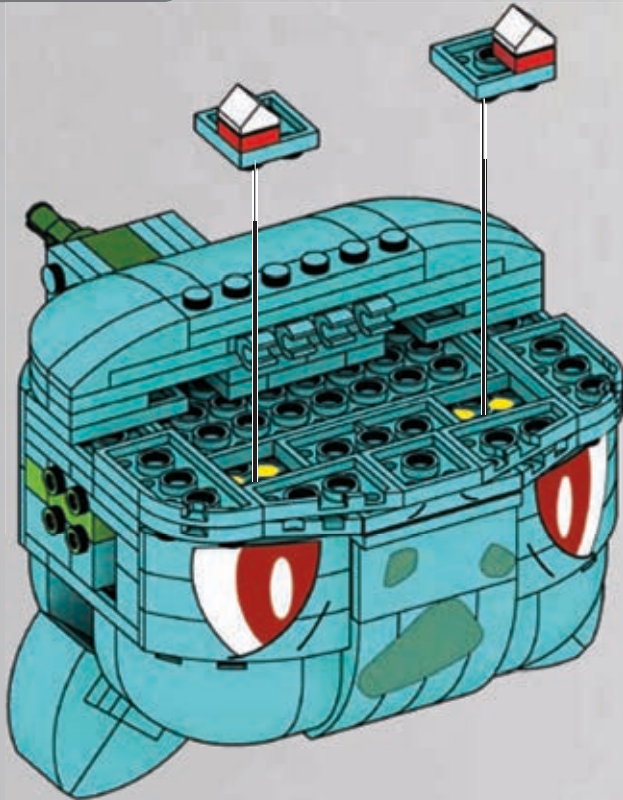
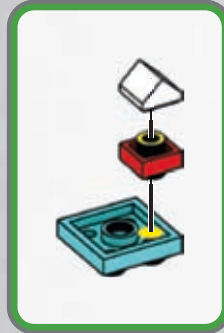
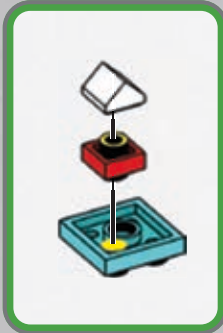

1

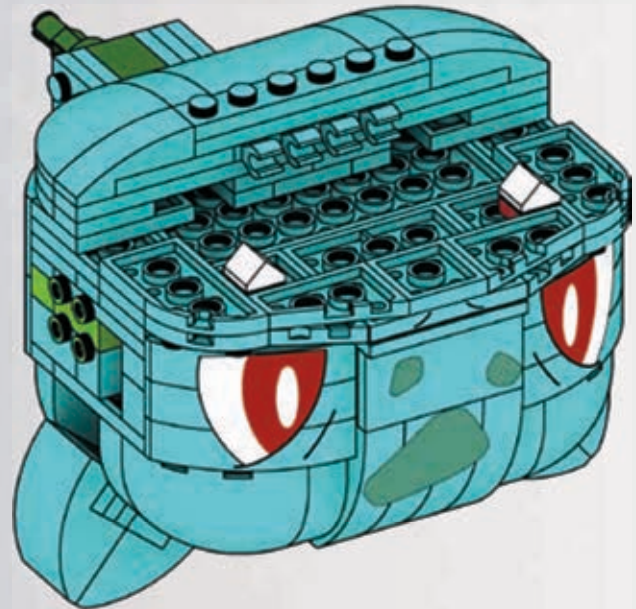

2

81

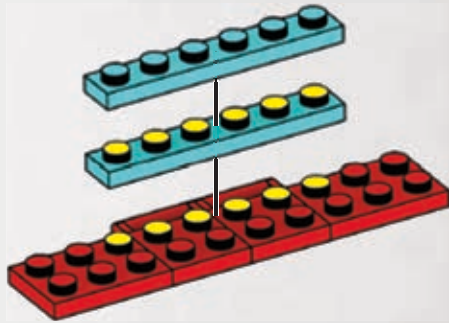

82

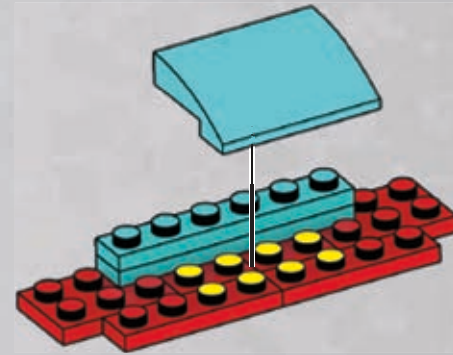
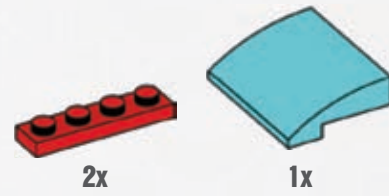

83

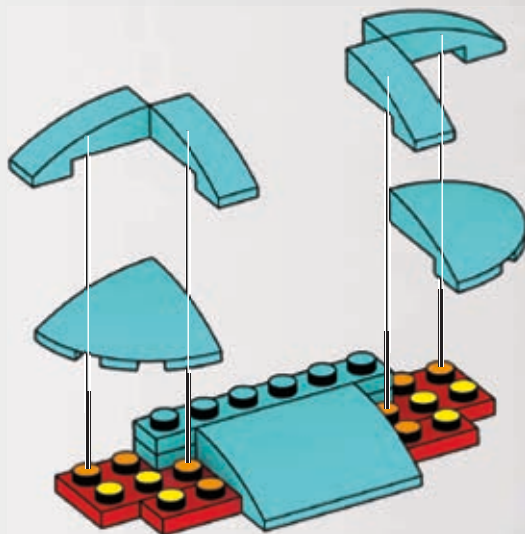
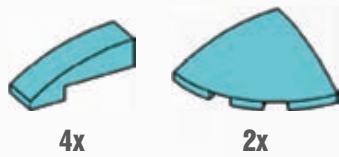

1

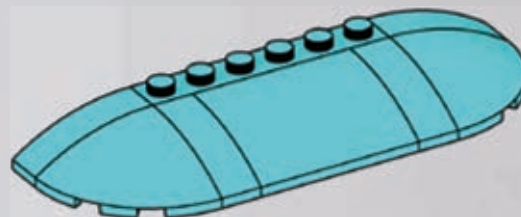

2

84

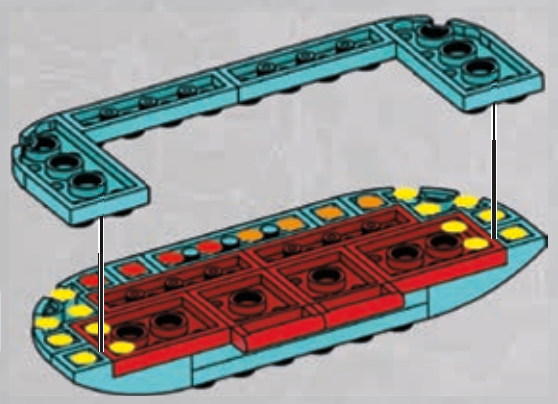

85

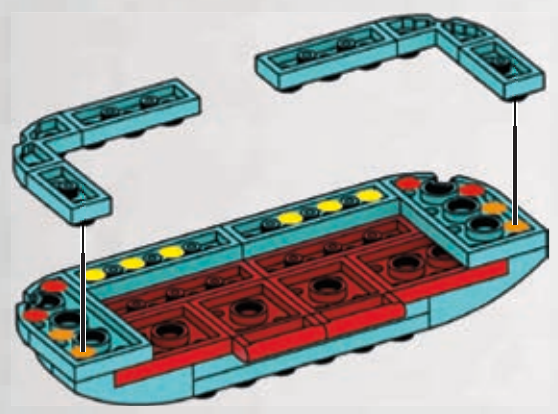

86

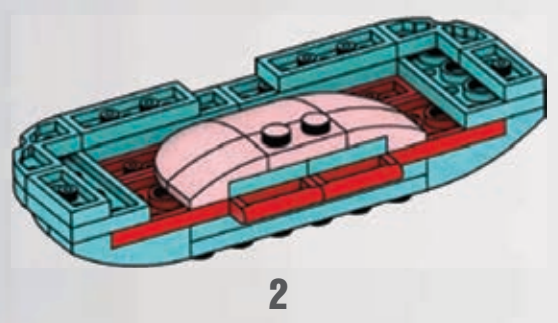
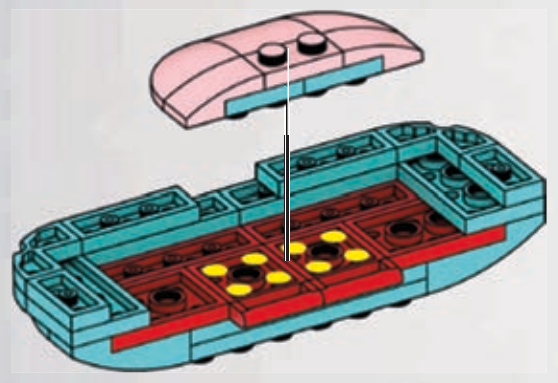
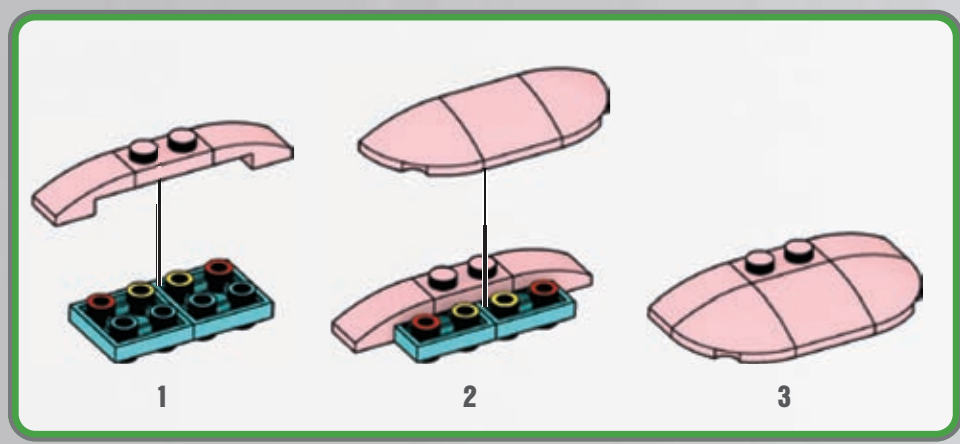
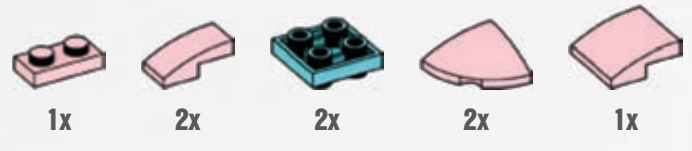

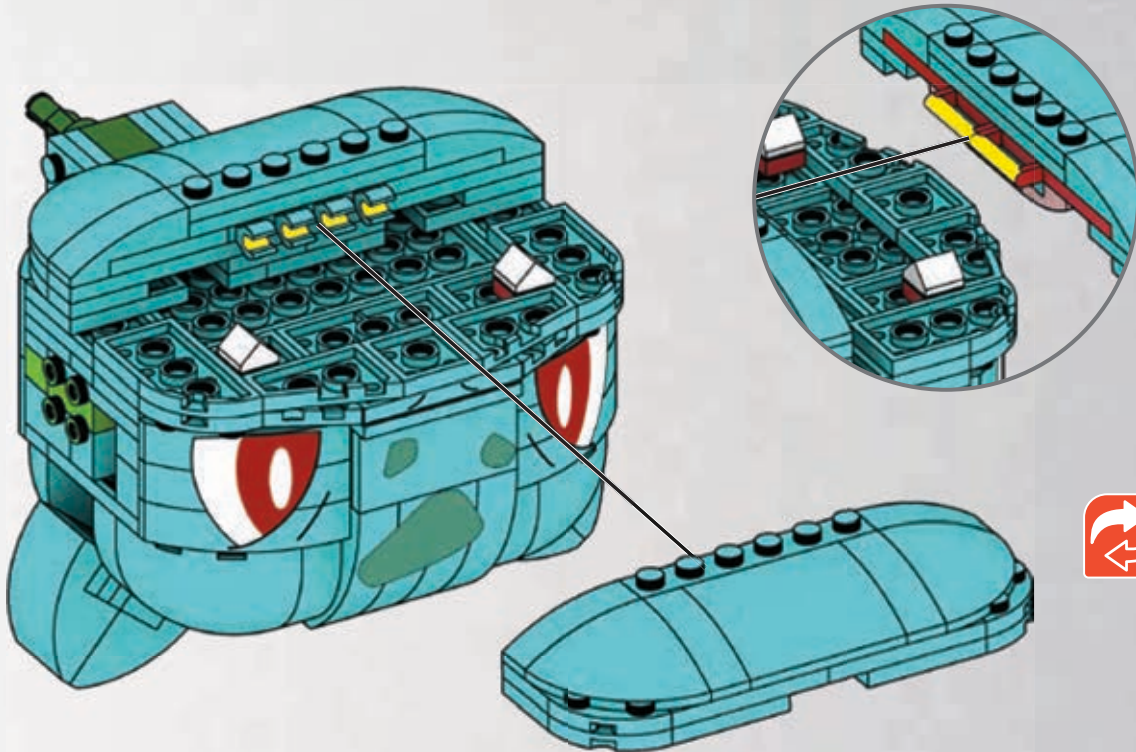

1

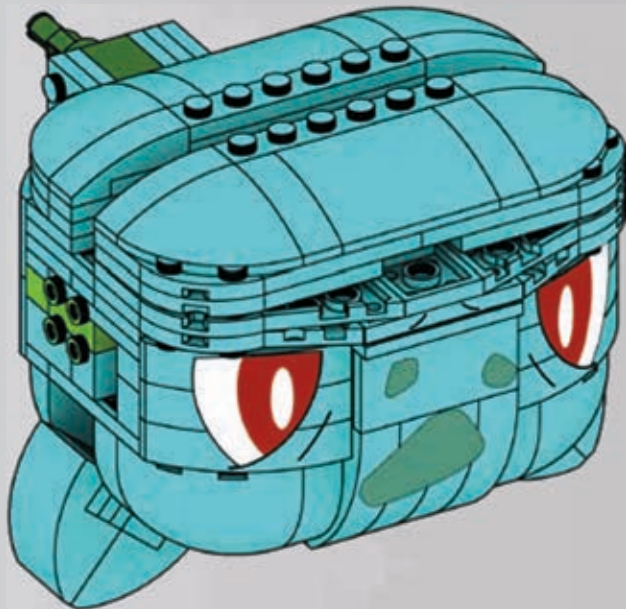

2

88

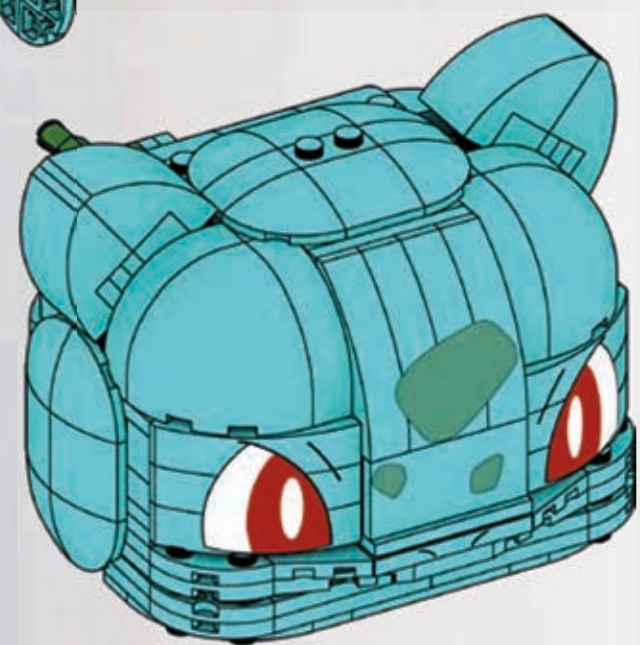
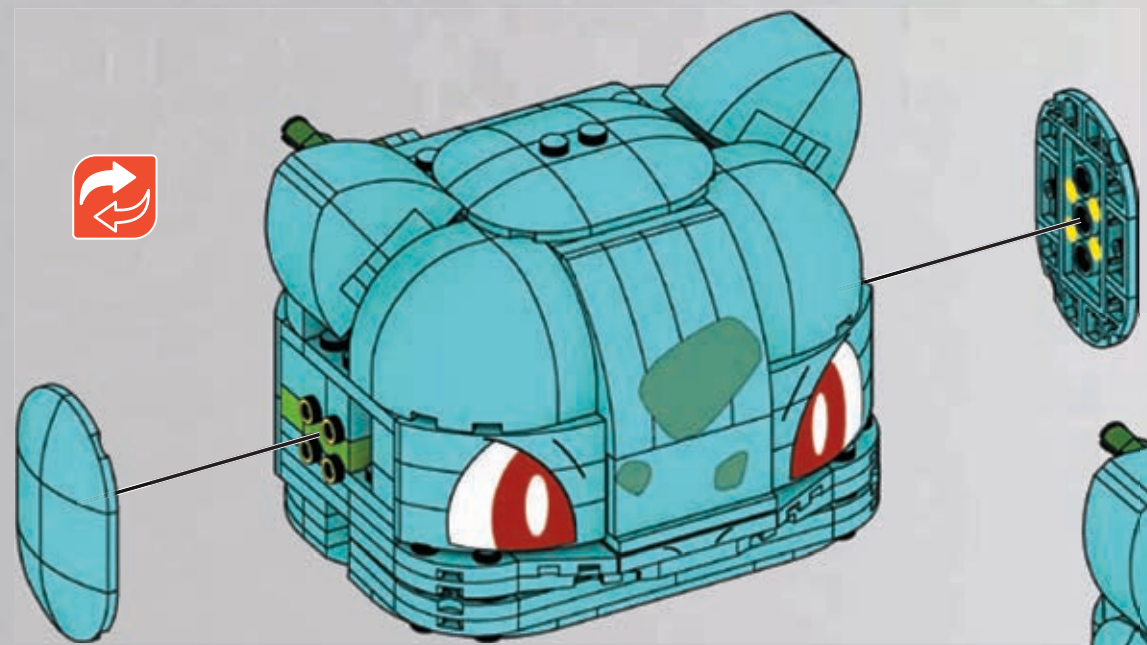
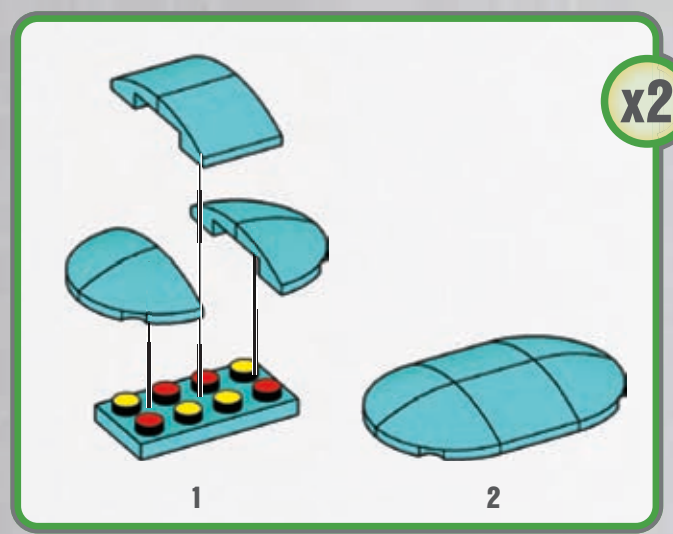
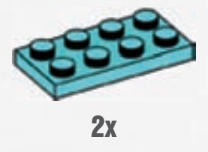
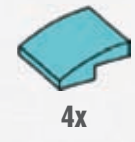

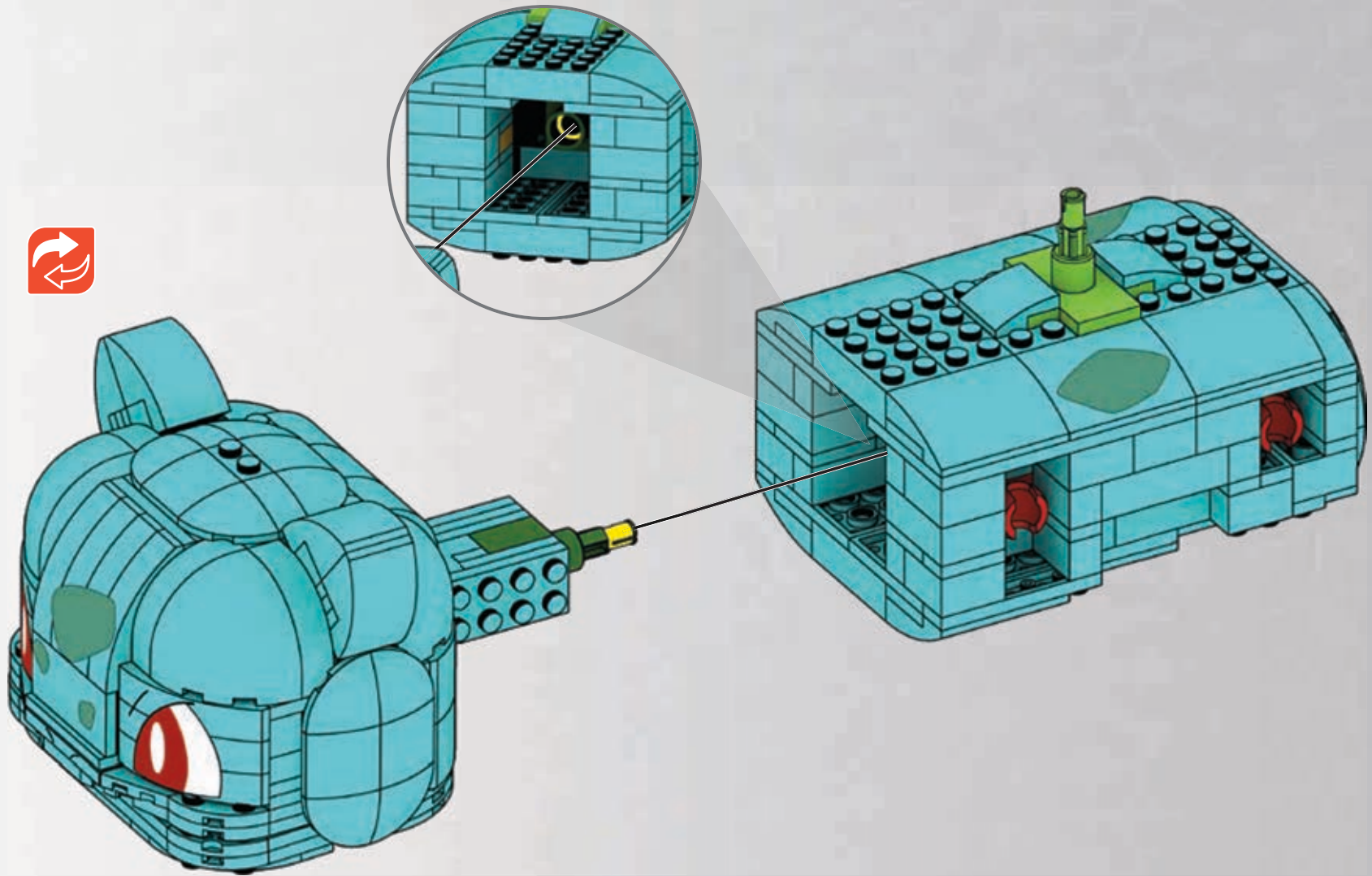

1

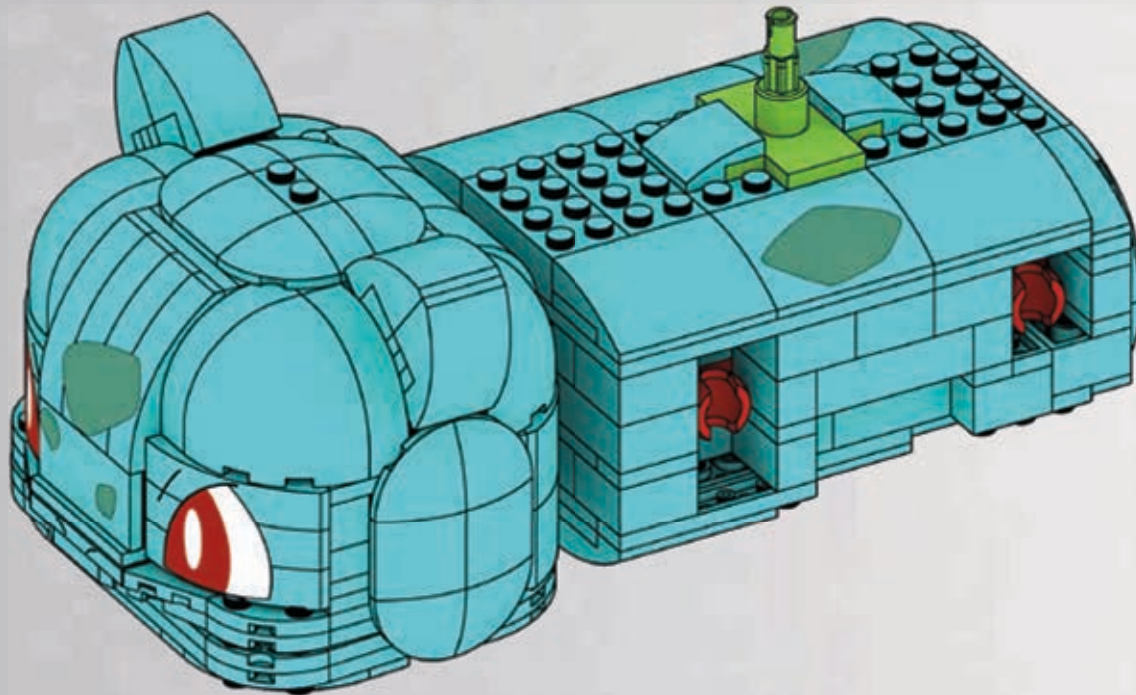

2

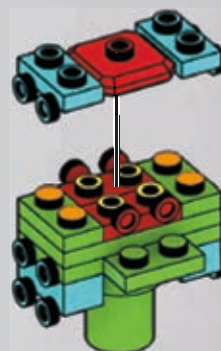
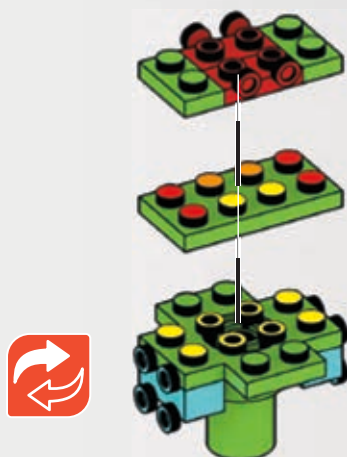
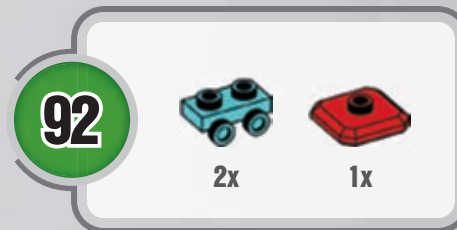
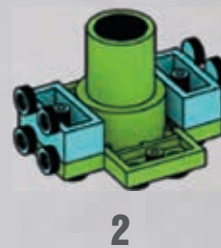
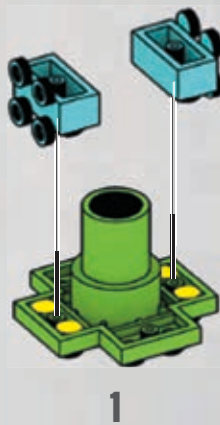
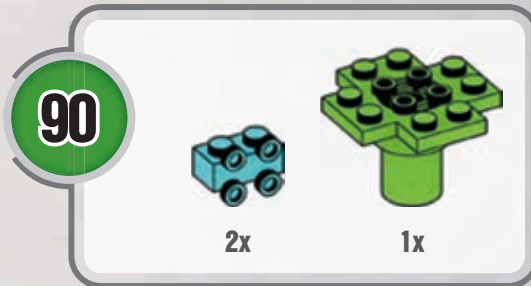

93

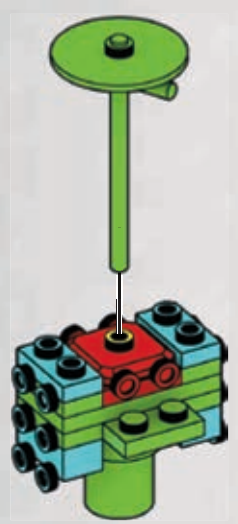
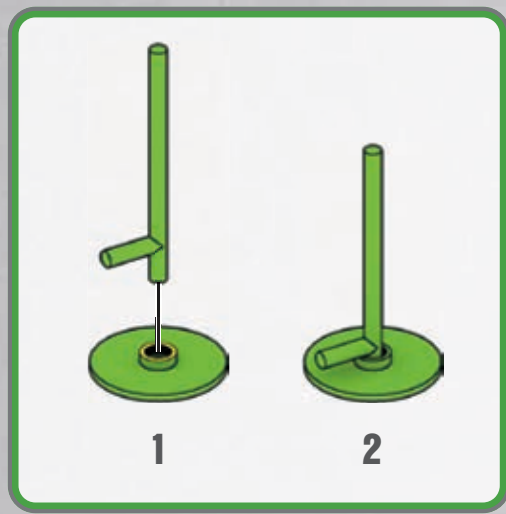
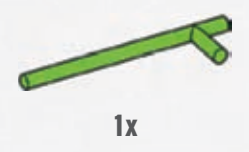

94

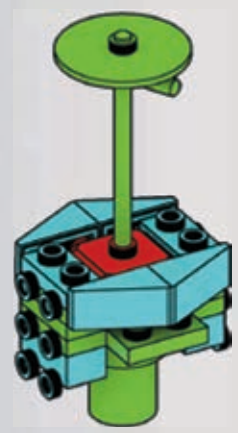
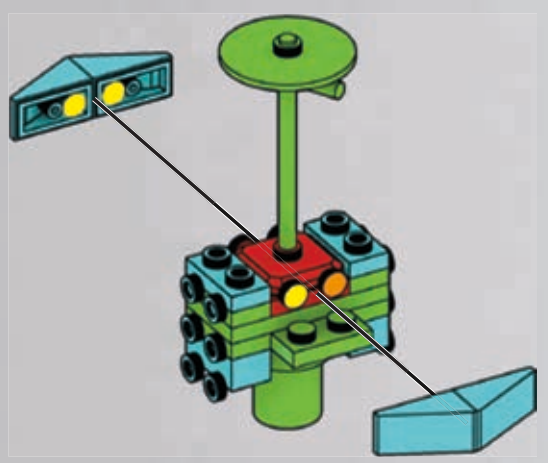

95



1x



1x

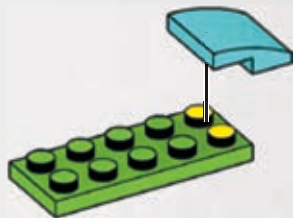

96



4x



1x

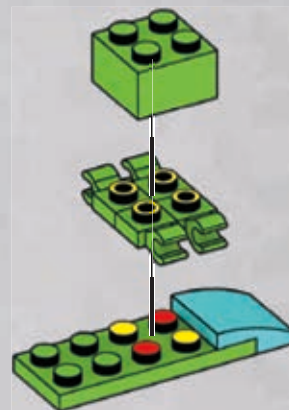

97



2x



1x

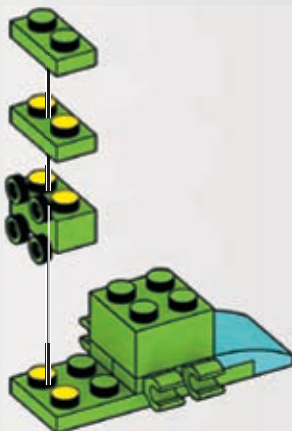

98



1x



1x

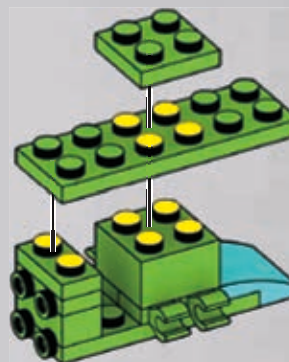

99

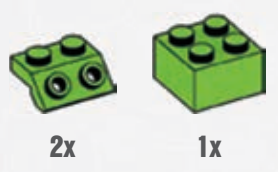

2x 1x

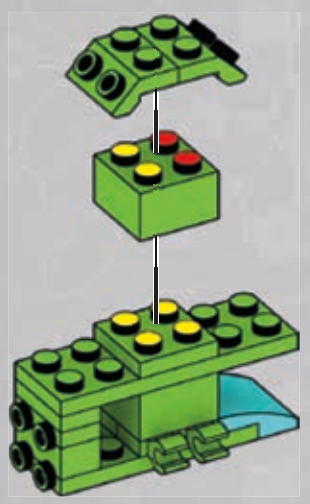

1

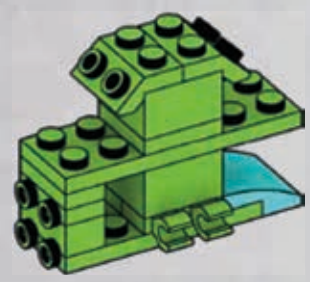

2

100



1x 1x

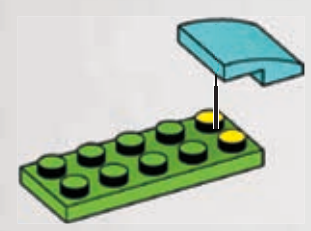

101

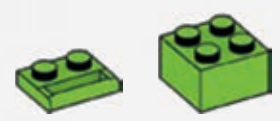

2x 1x

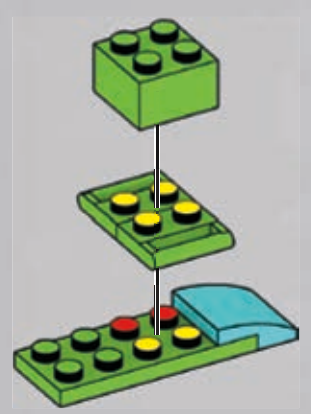

102



2x 1x

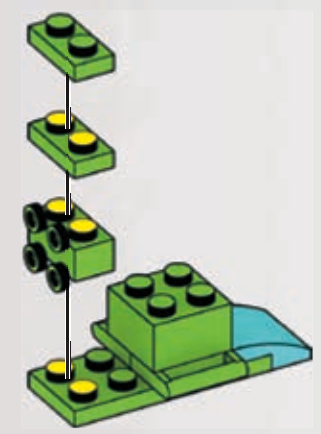

103



1x

1x

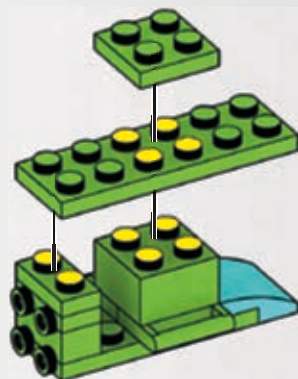

104

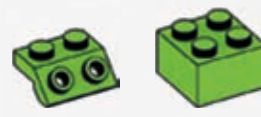

2x

1x

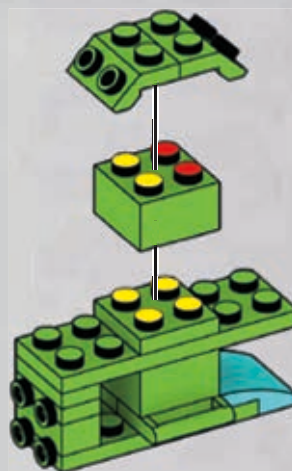

1

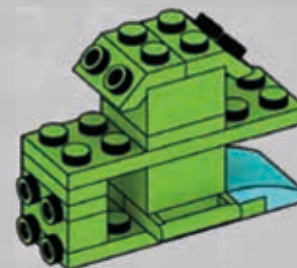

2

105

99

104

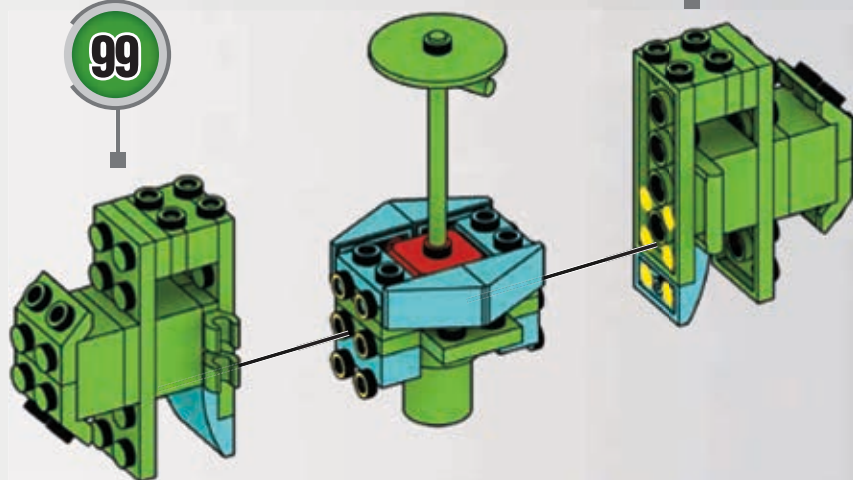

1

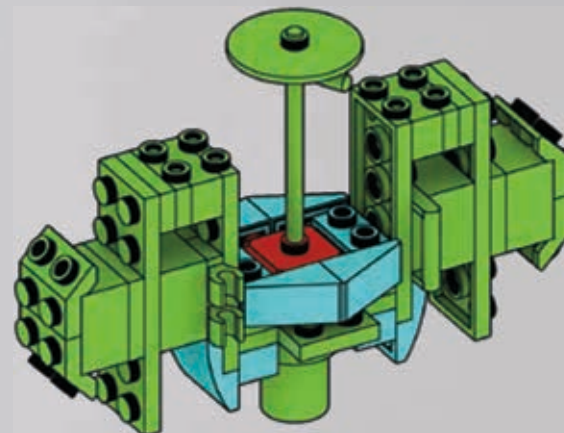

2

106 → 113
x2

106

4x 1x 1x

107

2x 1x

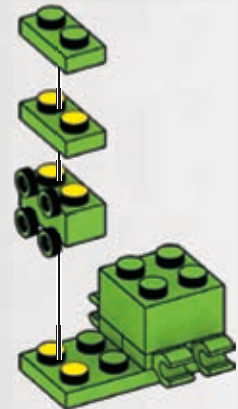
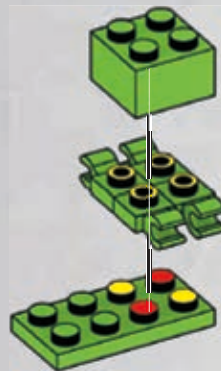

108

1x 1x

109

2x 1x

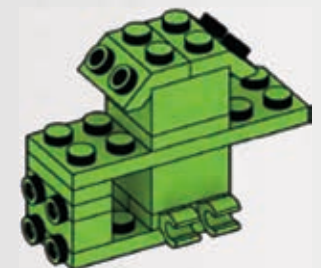
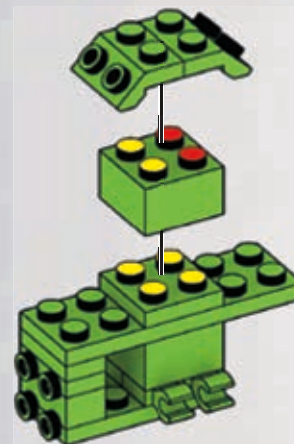
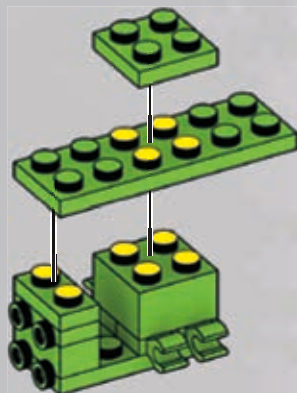

1

2

110

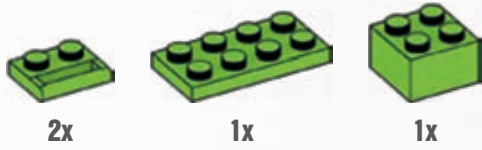

2x

1x

1x

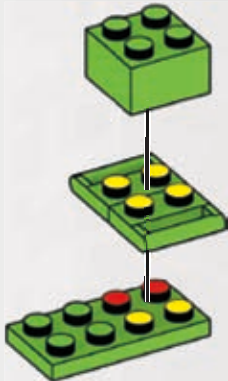

111



2x

1x

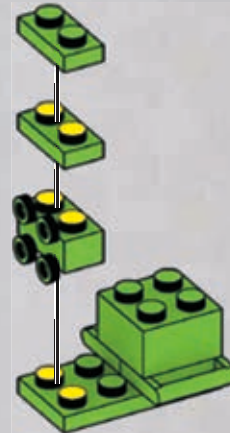

112



1x

1x

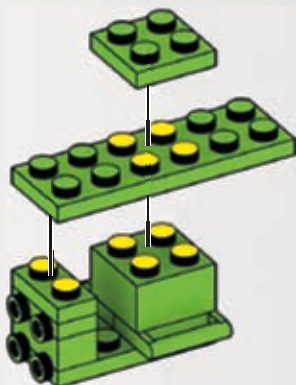

113



2x

1x

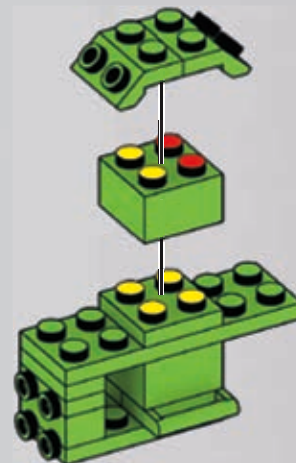

1

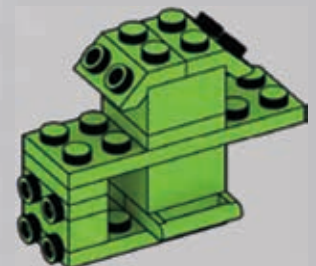

2

114

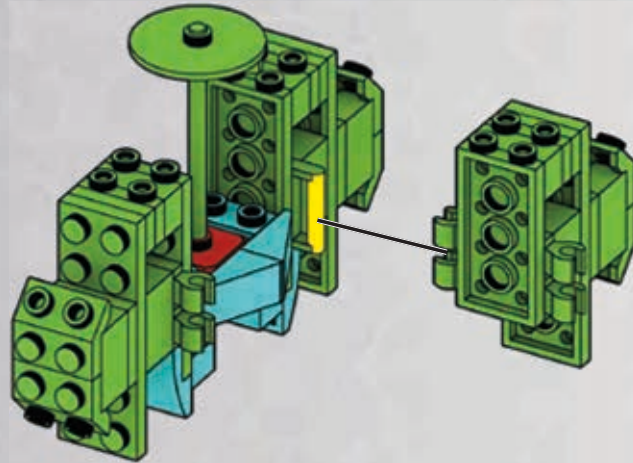

109

115

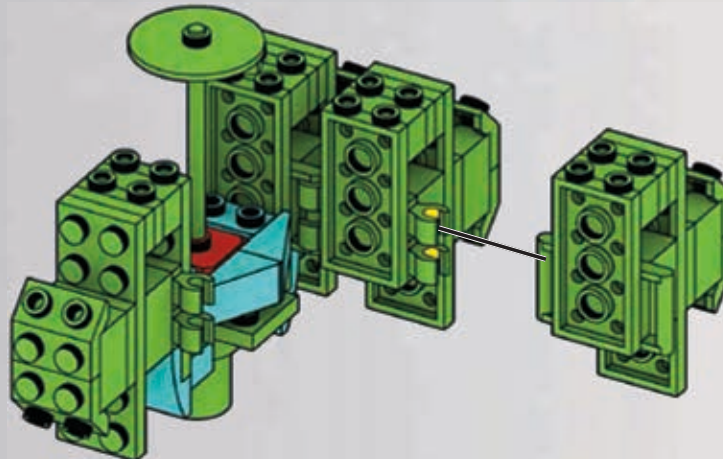

113

116

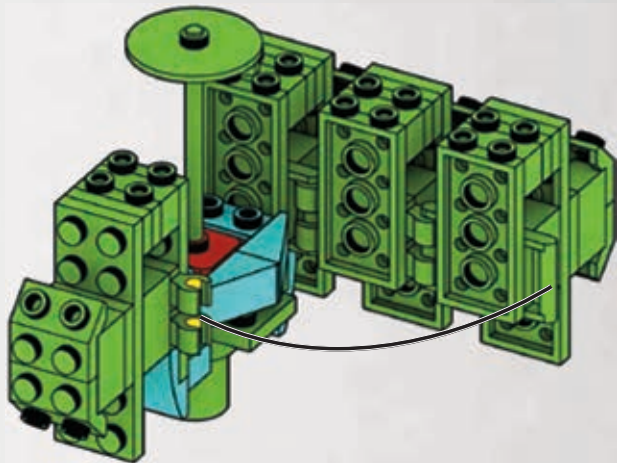

1

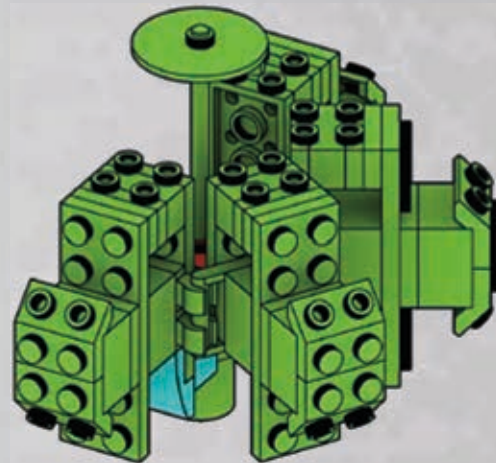

2

117

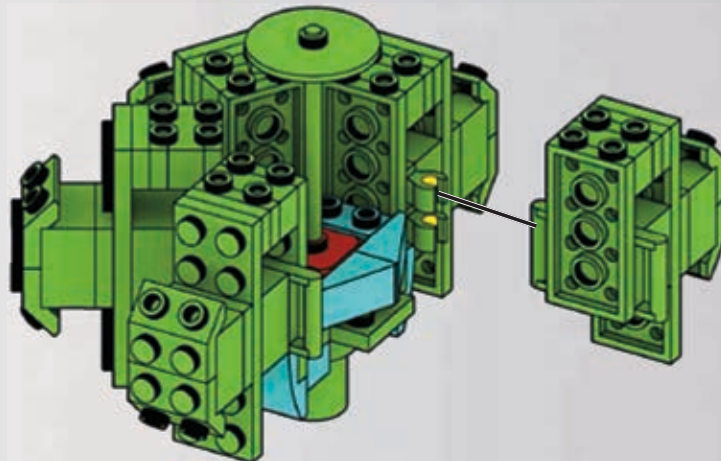

113

118

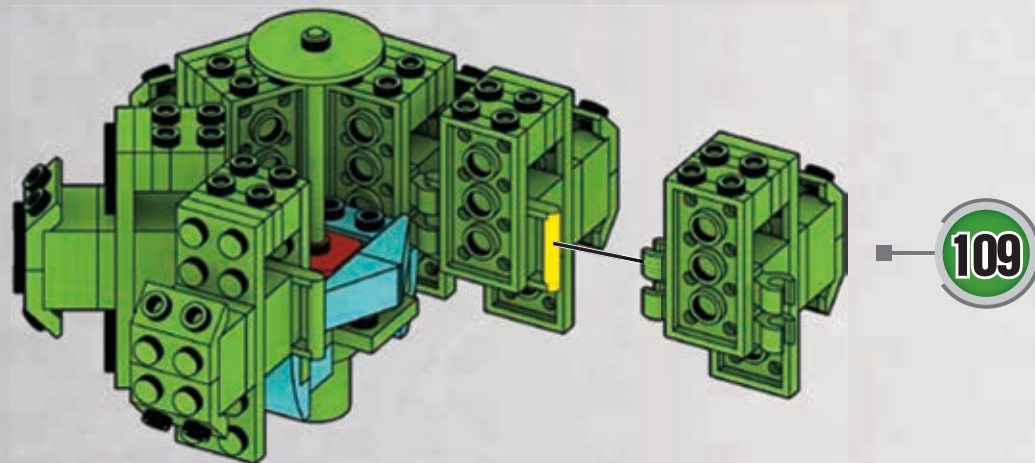

119

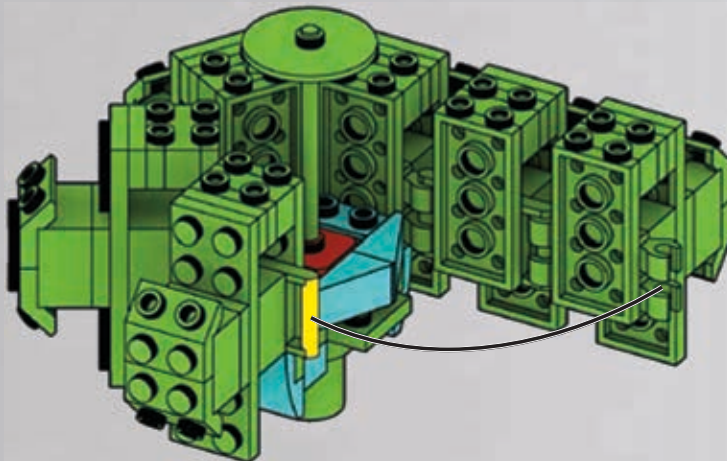

1

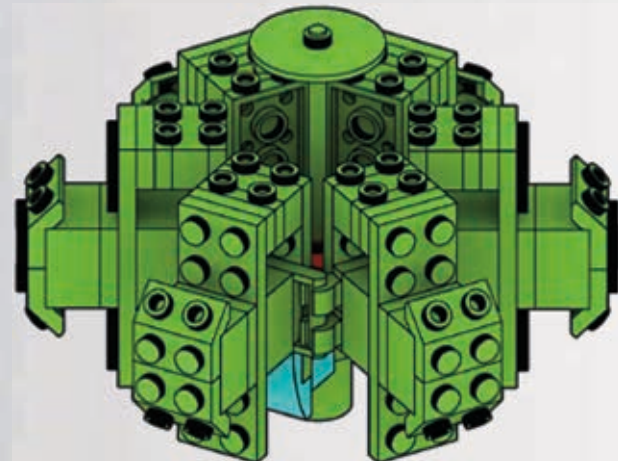

2

120



6x

3x

6x

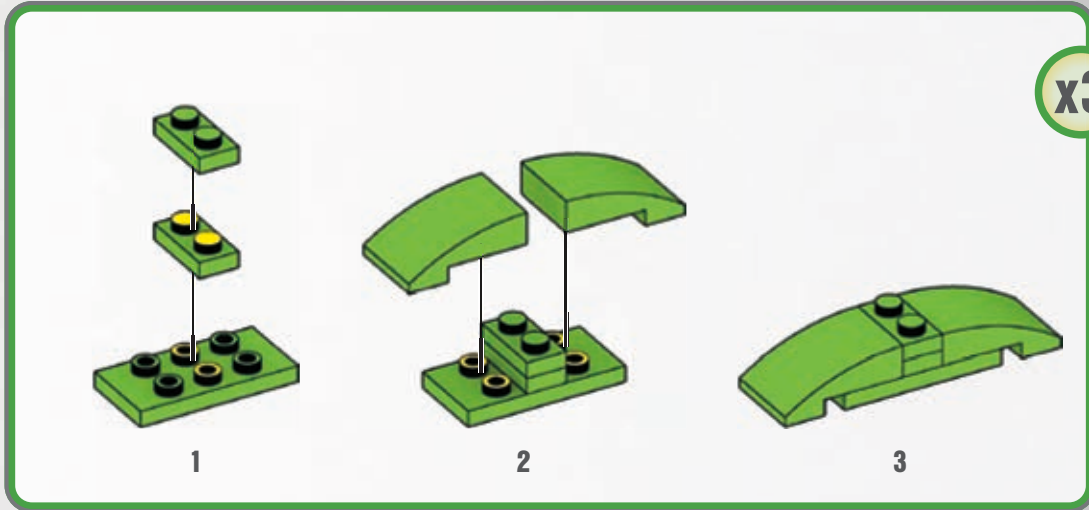

x3

1

2

3

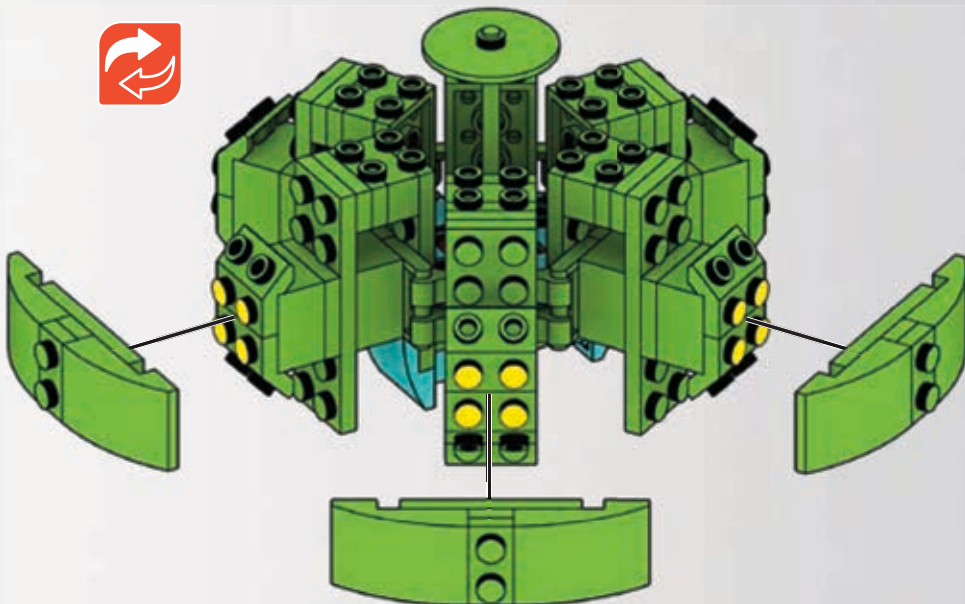

1

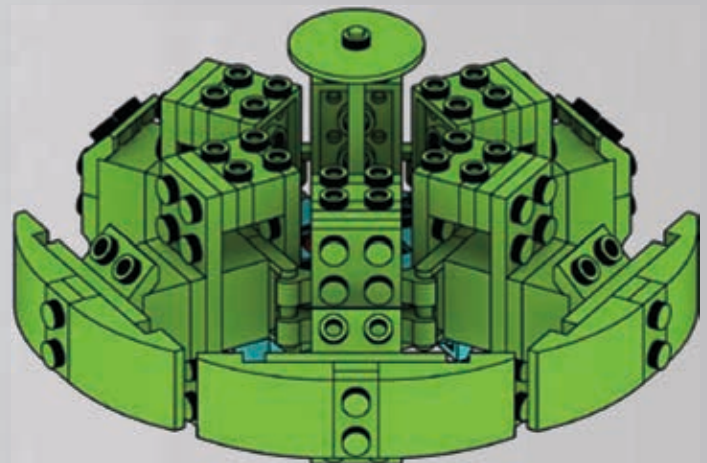

2

121



6x

3x

6x

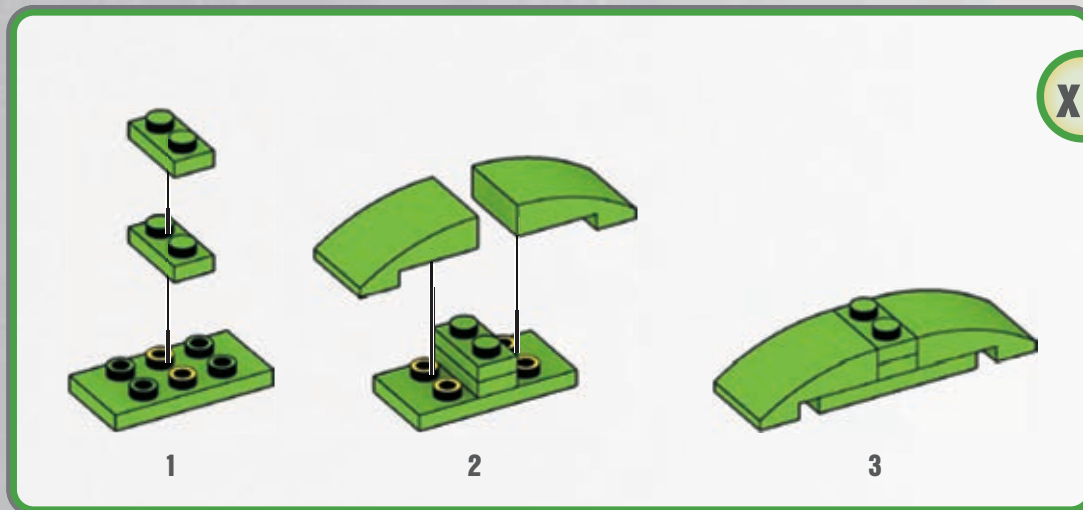

x3

1

2

3

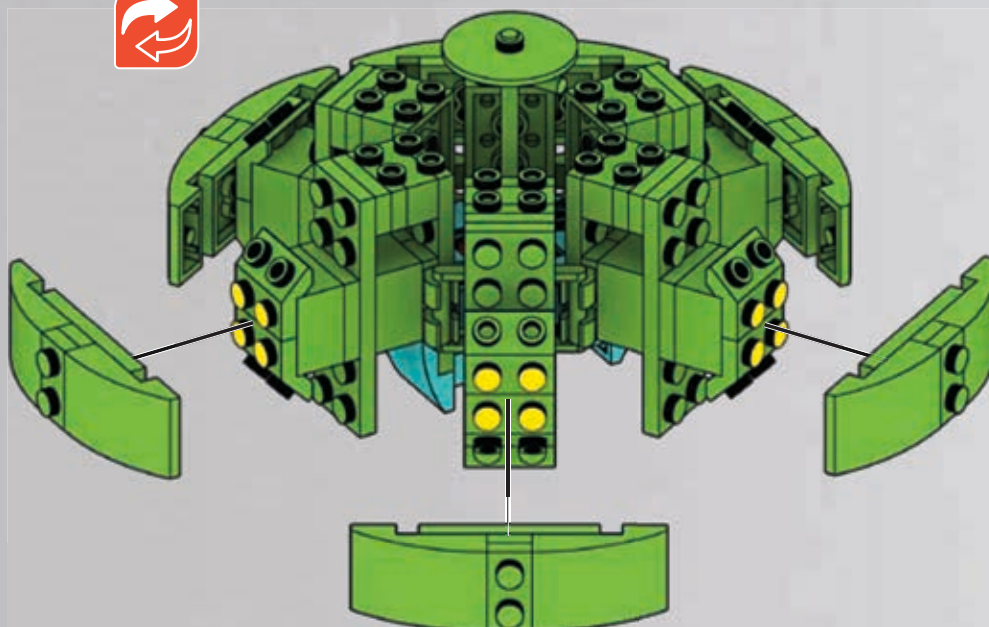

1

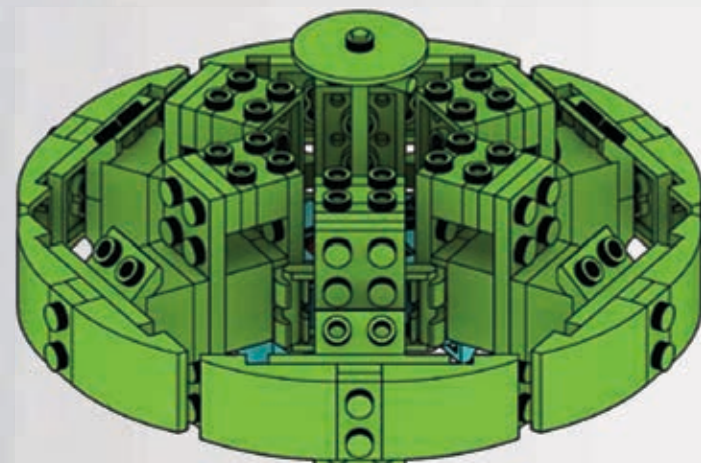

2



122

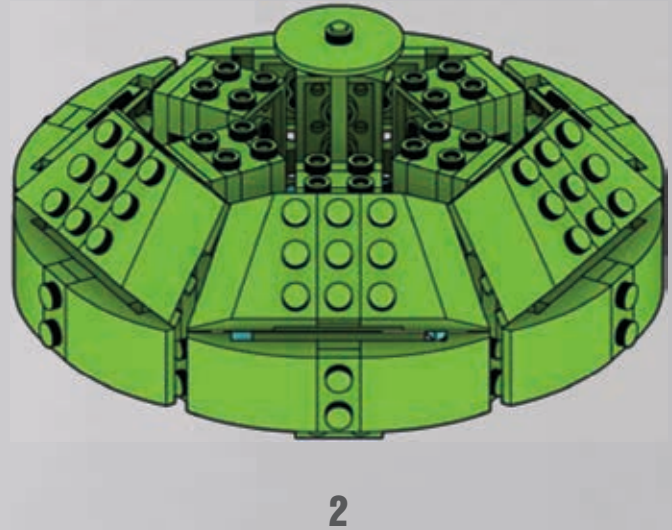
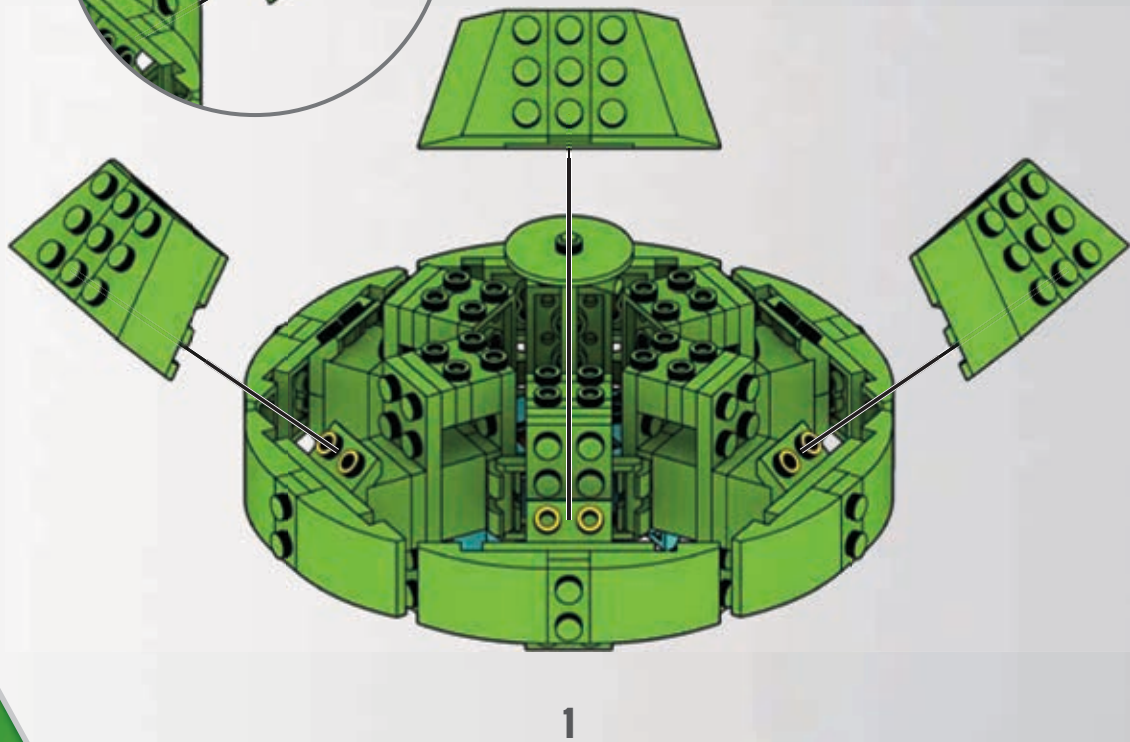
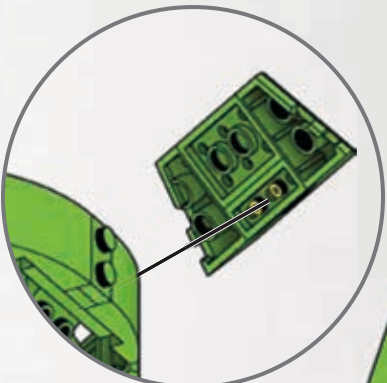
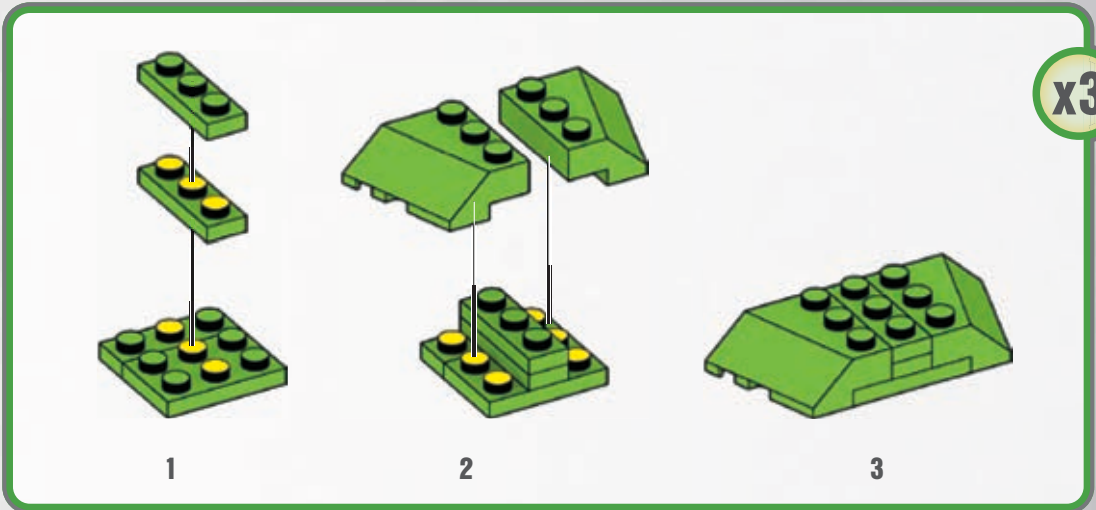
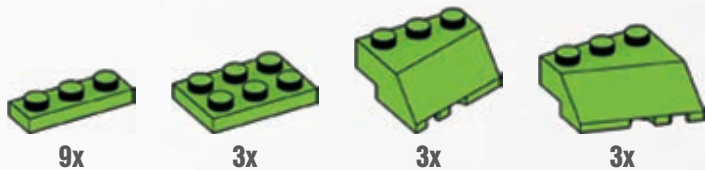

123

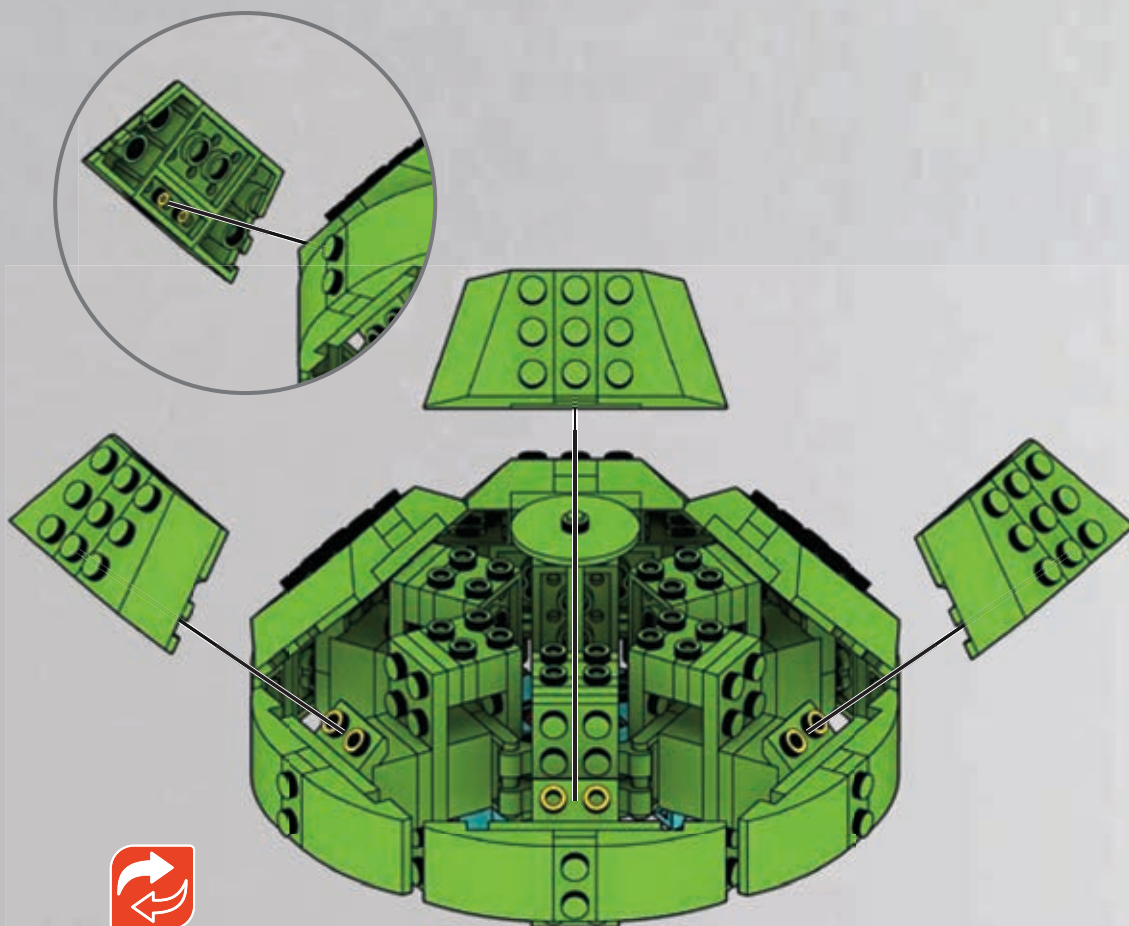
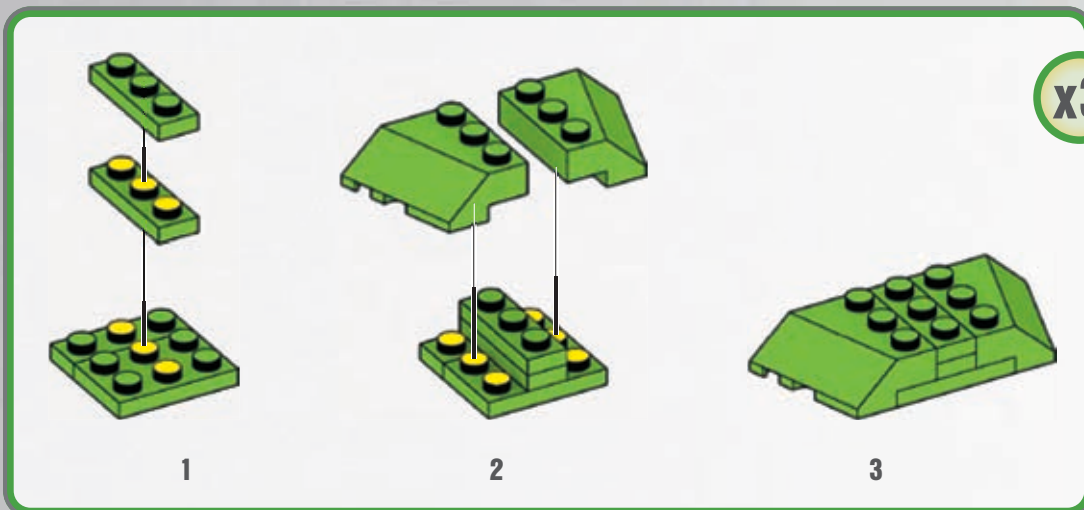
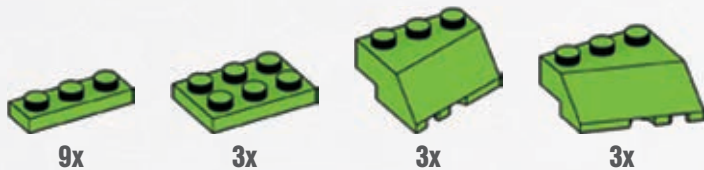

1

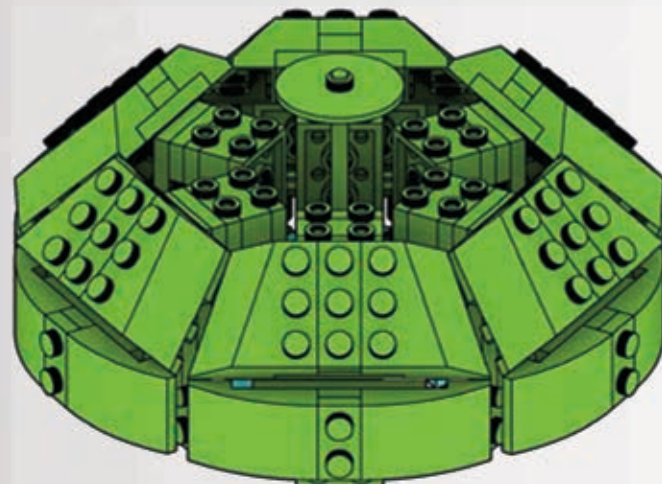

2

124

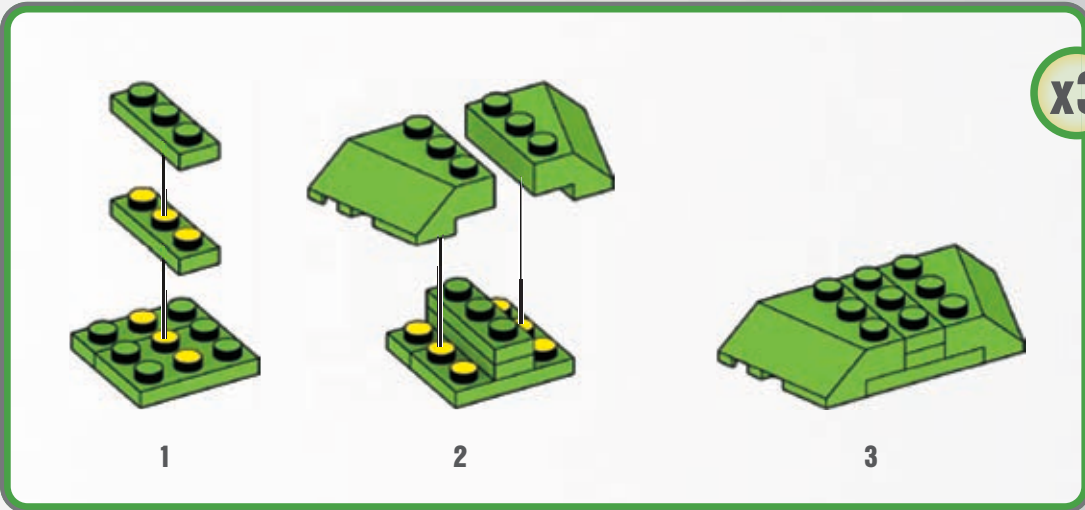
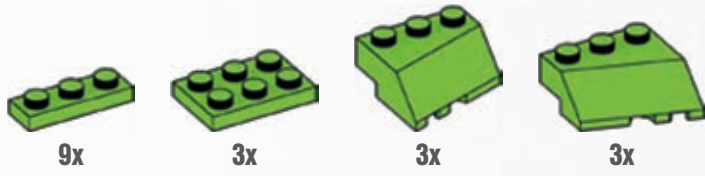

x3

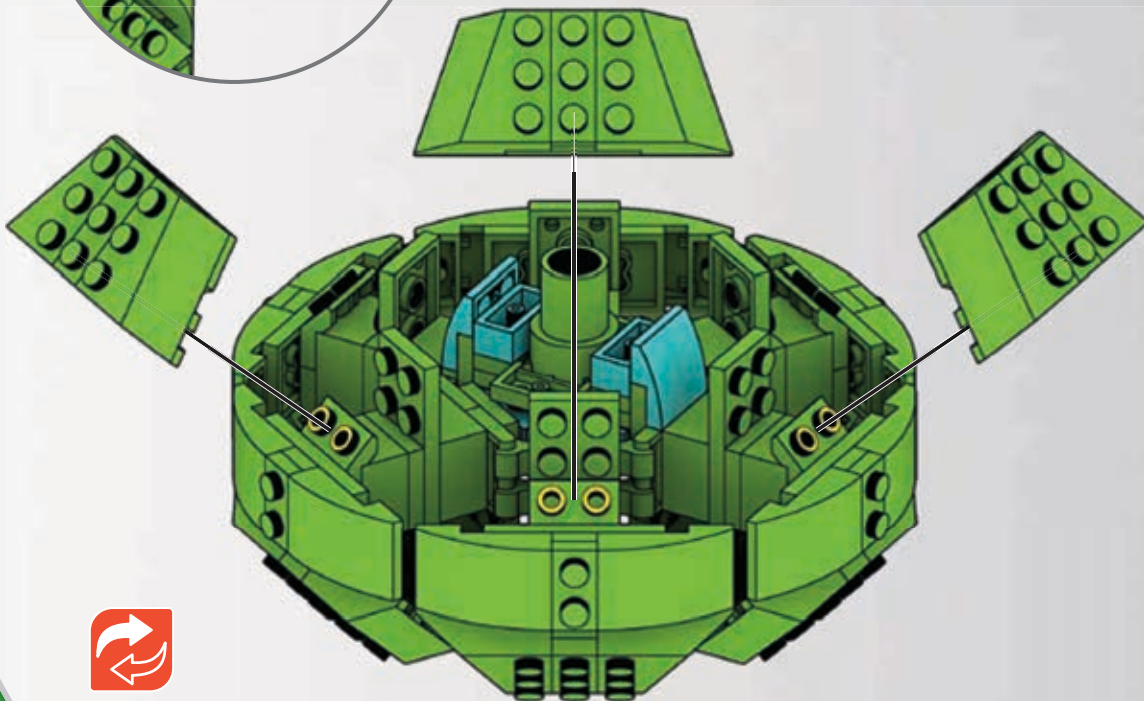
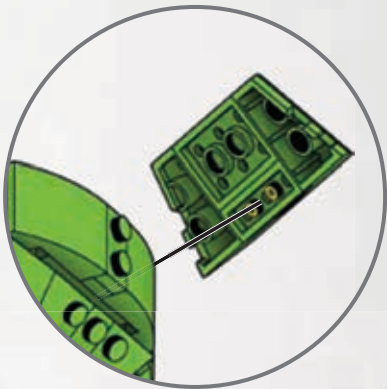

1

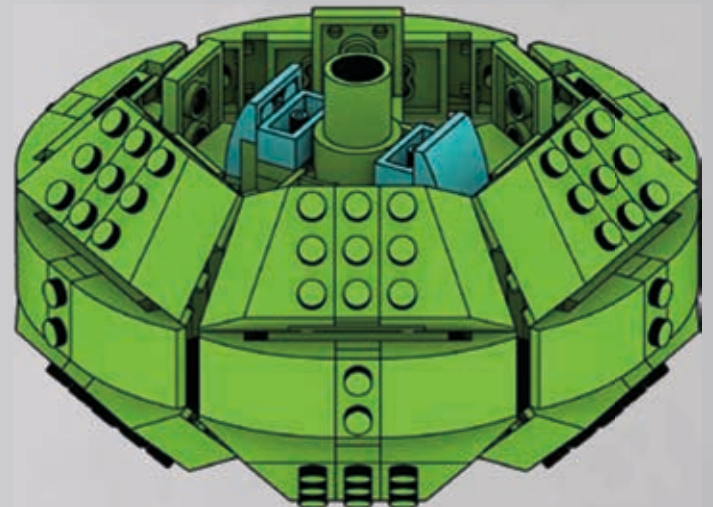

2

125

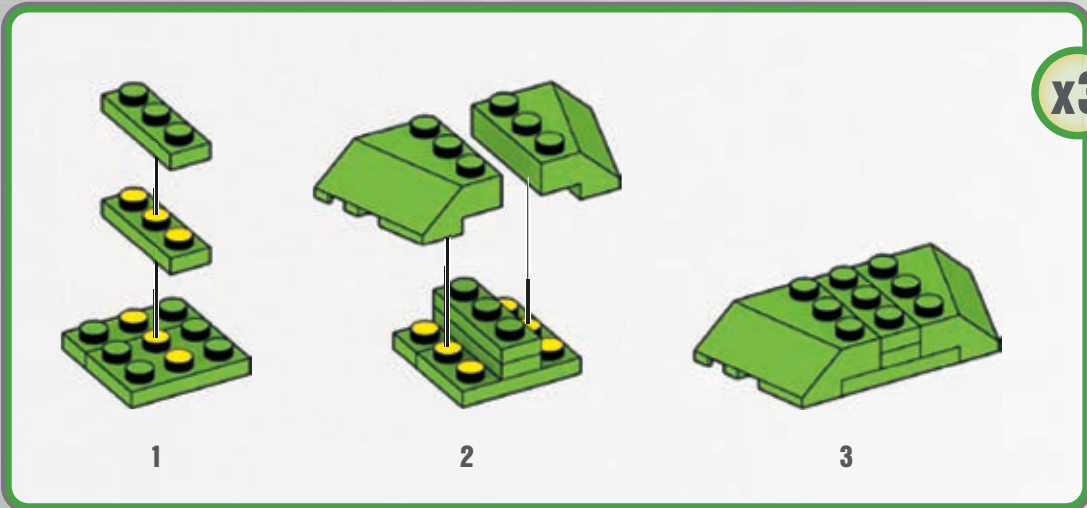
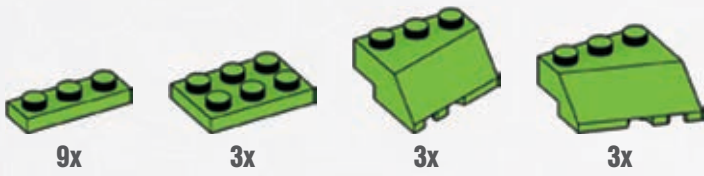

x3

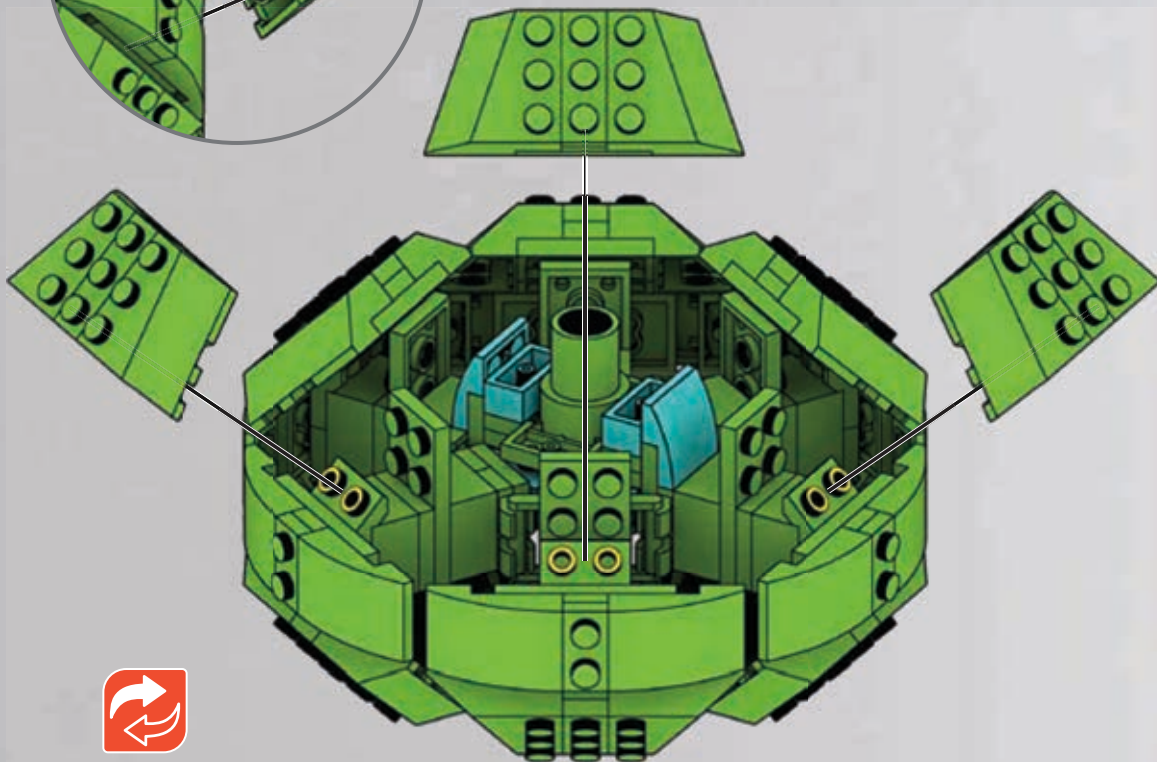
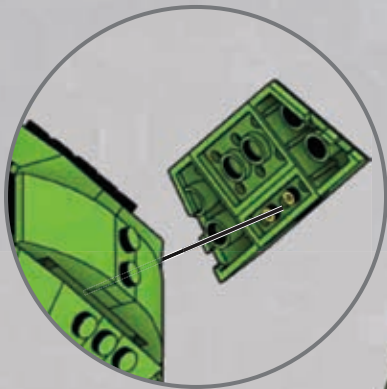

1

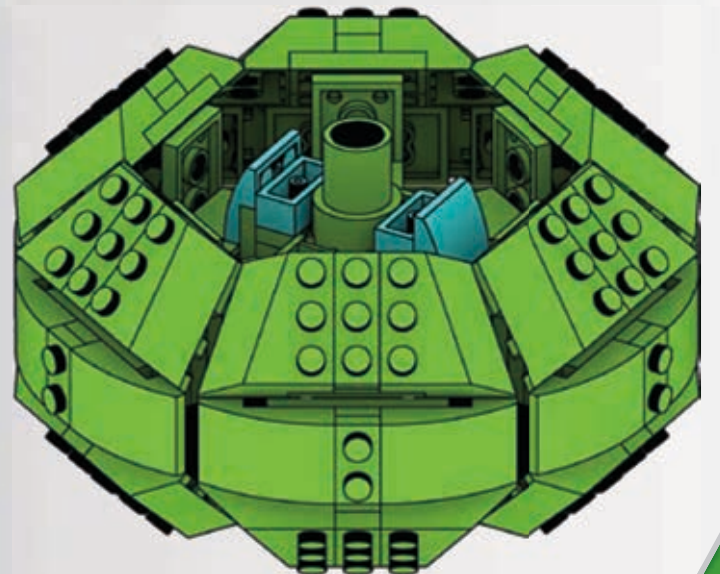

2

126

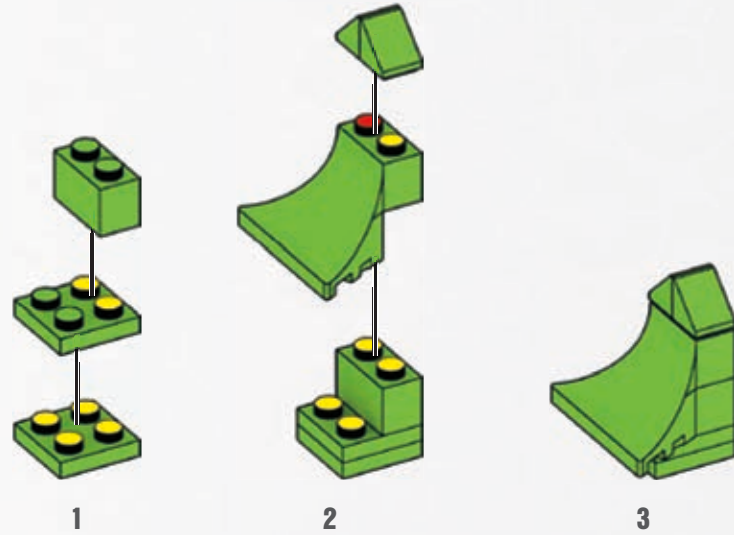
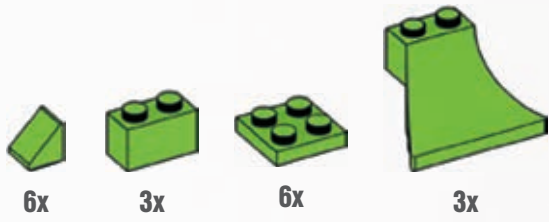

x3

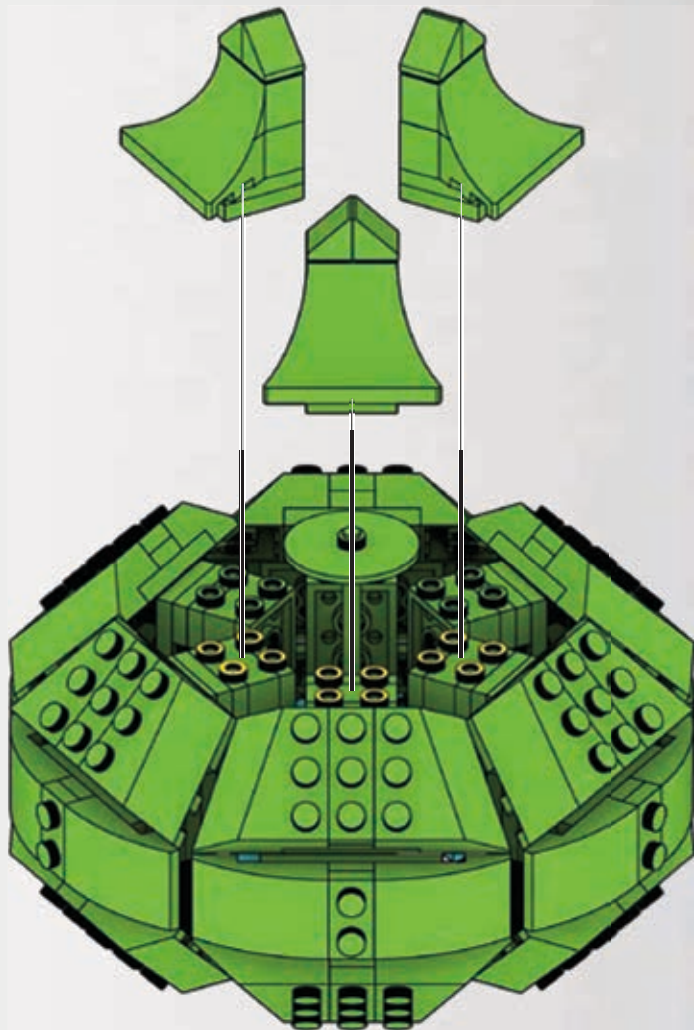

1

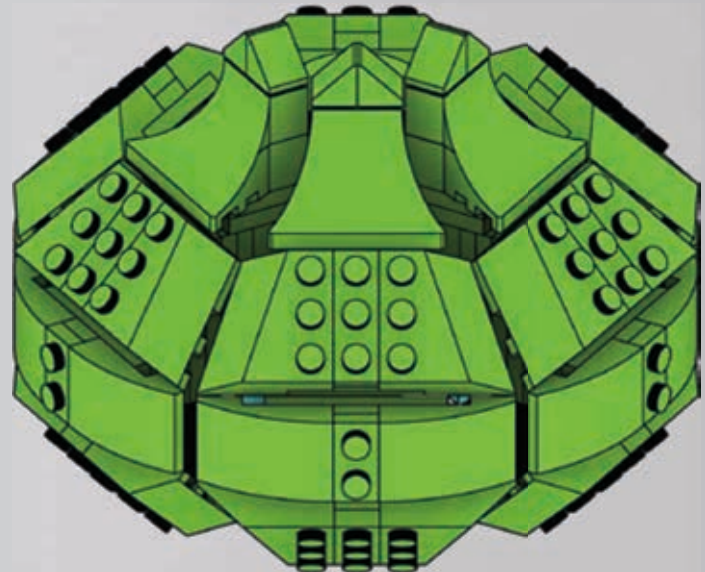

2



127

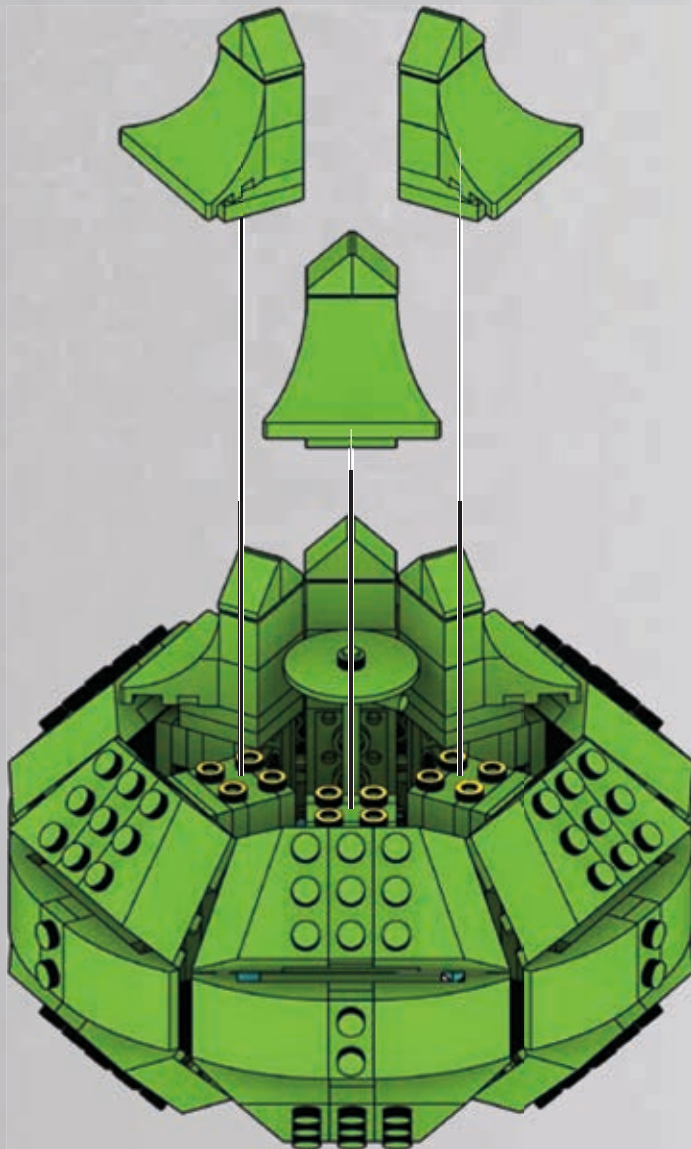
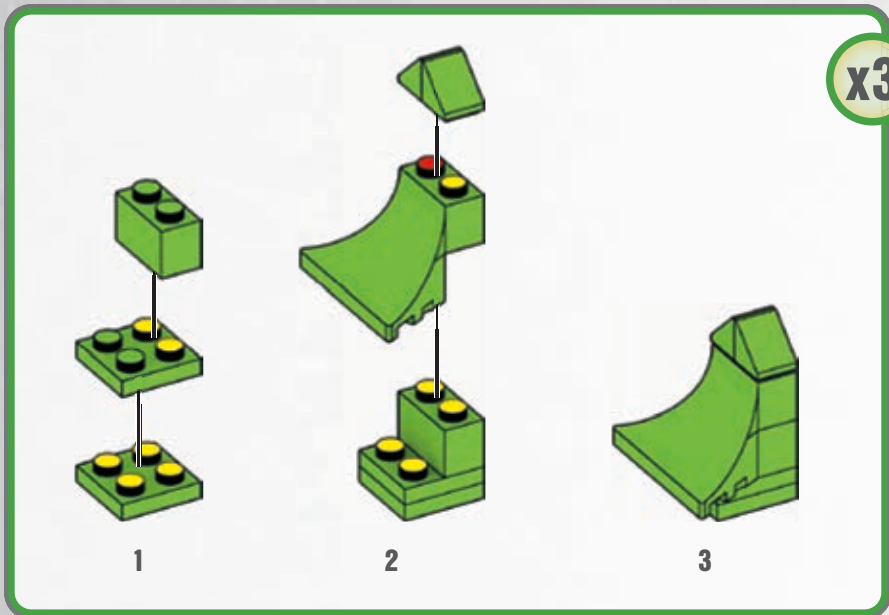
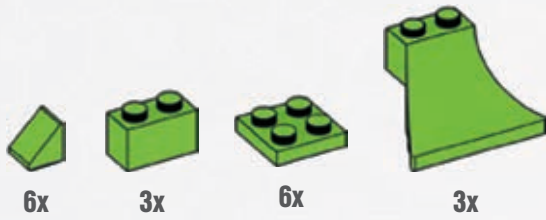

1

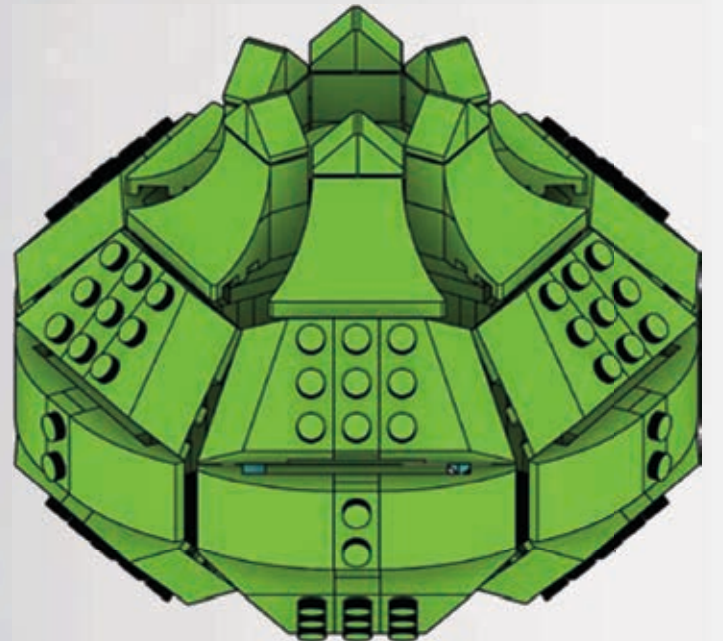

2

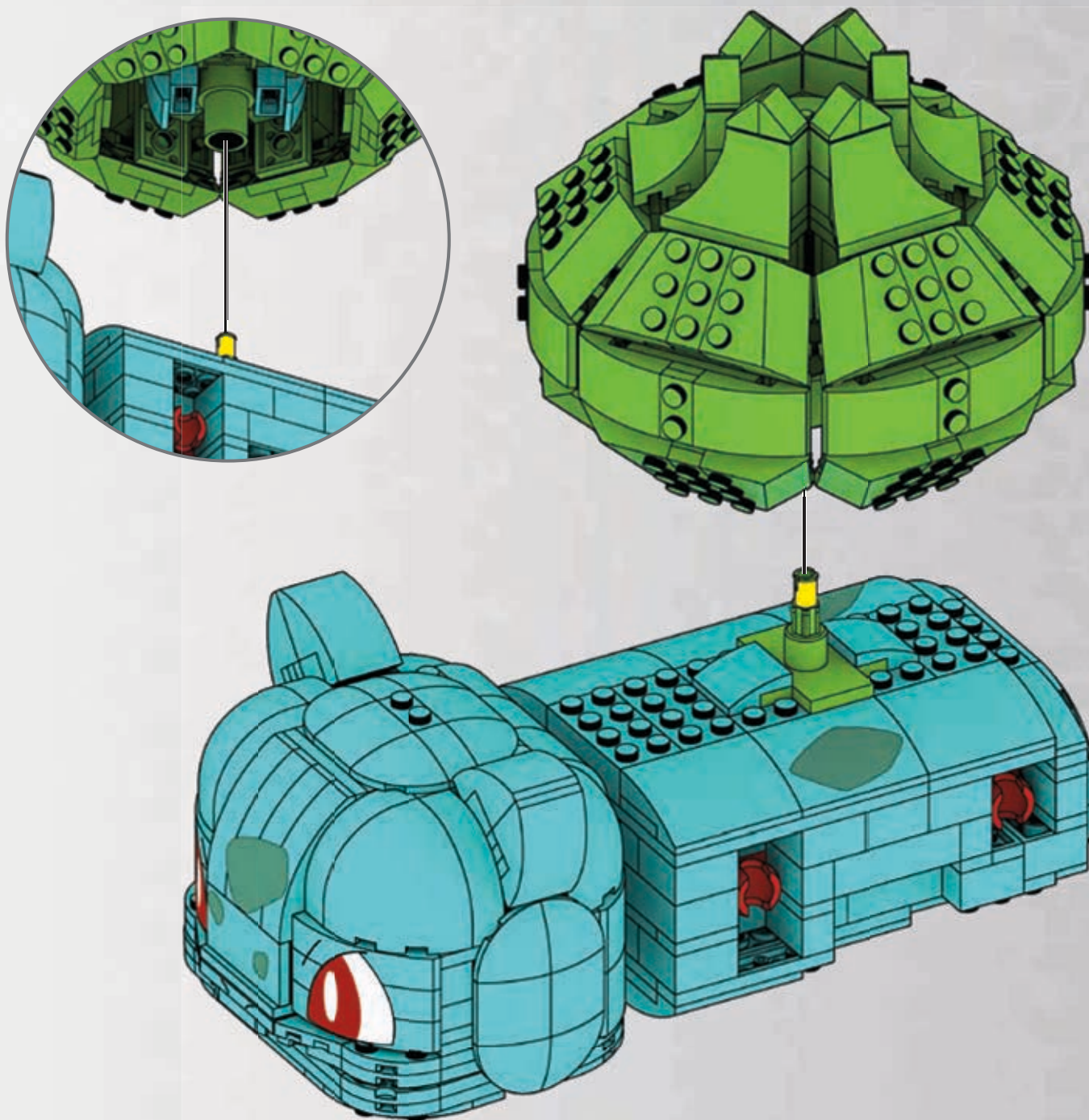

1

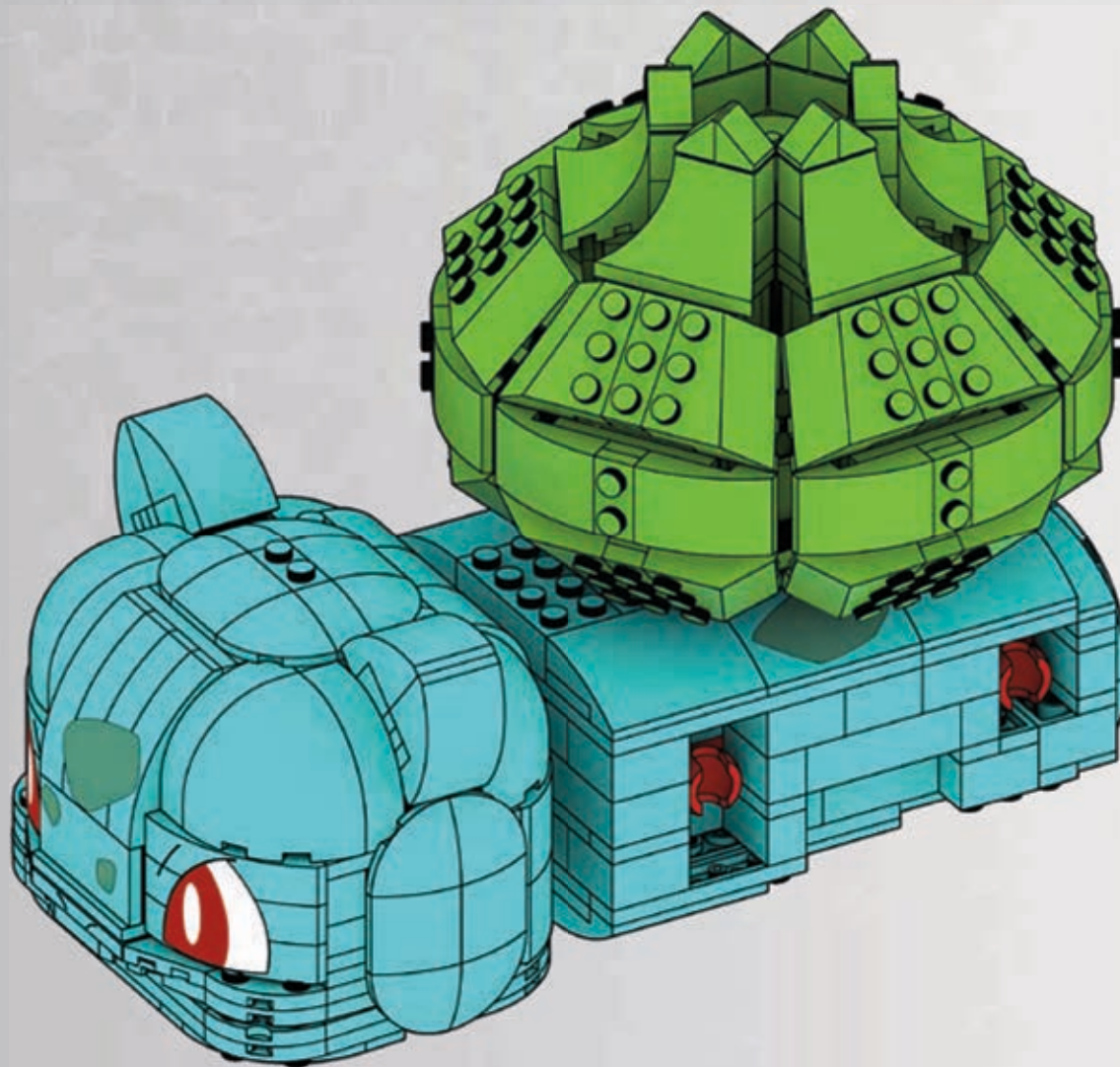

2



129



1x



2x



1x

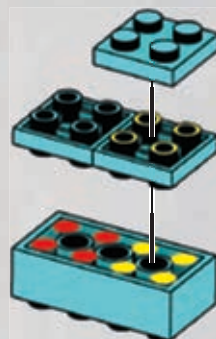

130



2x



2x

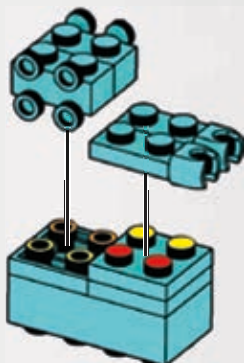

131



1x



1x



1x

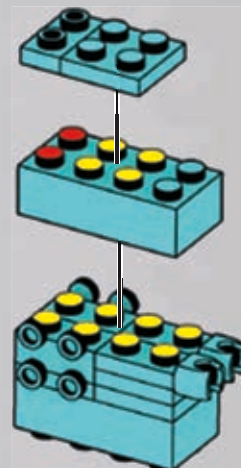
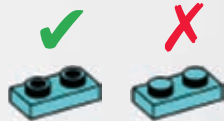

132



1x

1x

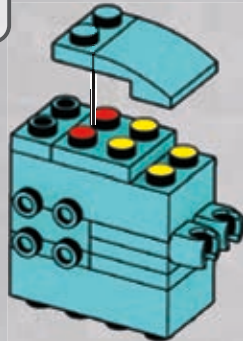

133



1x

3x

1x

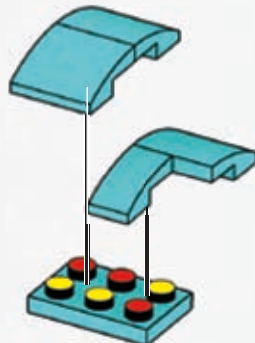

1

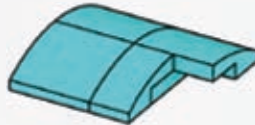

2

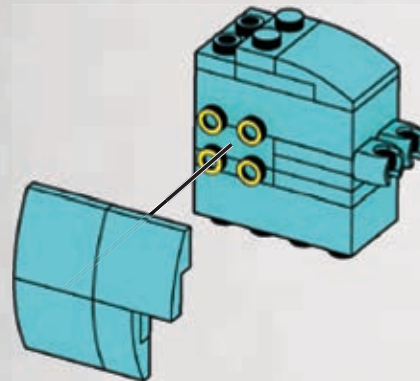

1

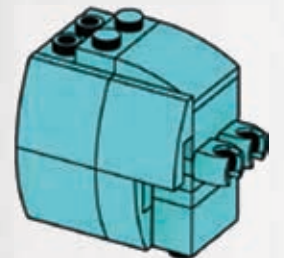

2

134



3x

1x

1x

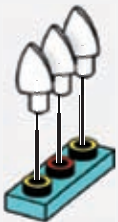

1



2

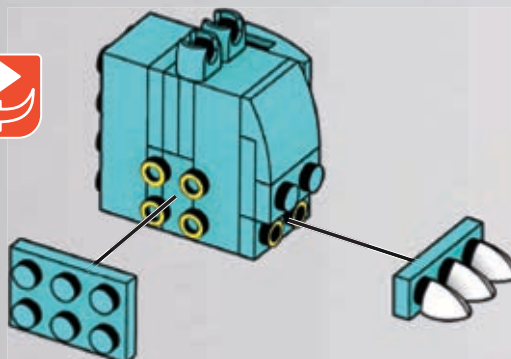
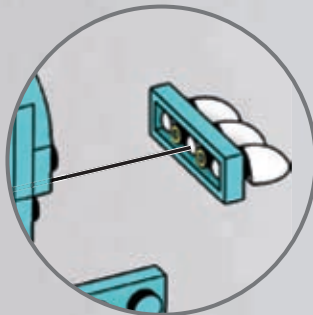

1

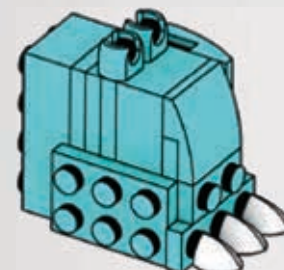

2

135



1x



1x



1x



1x

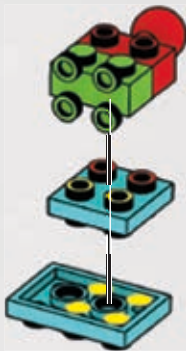

136



1x



1x



1x

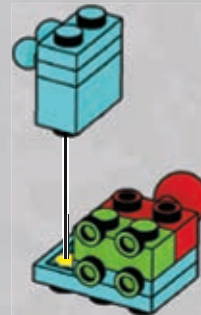
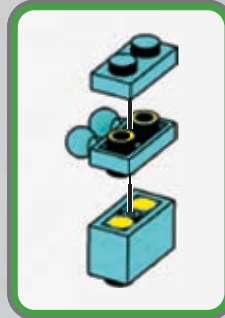
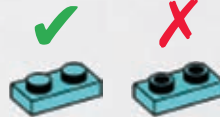

137



1x

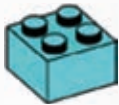

1x

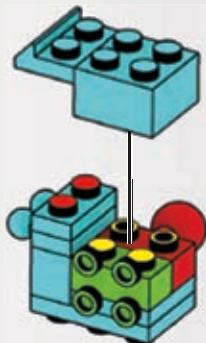

138



1x



1x

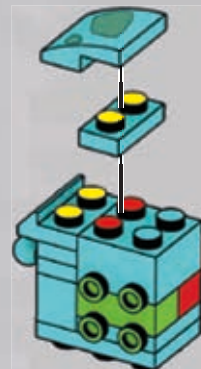

139



1x



1x

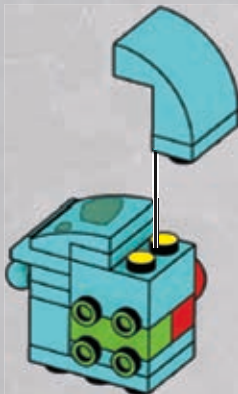
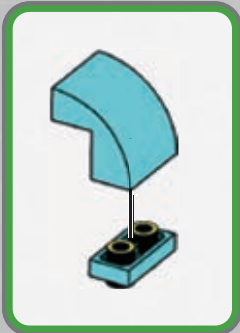

1



2

140



1x



1x



1x

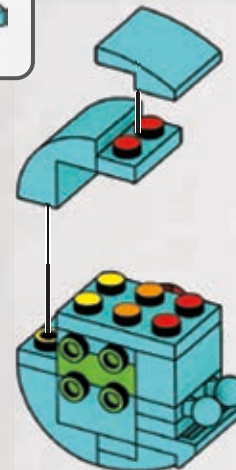
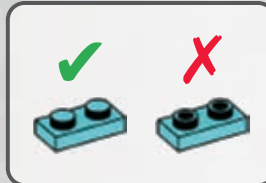

1

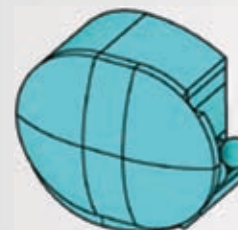

2

141



2x



4x



1x

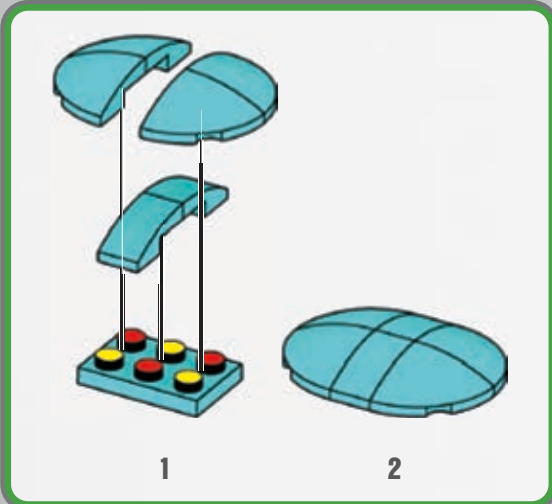
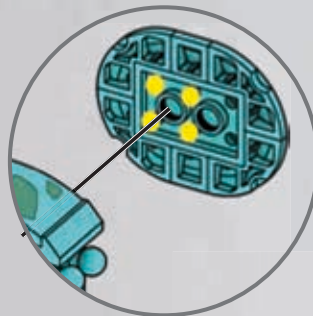

1

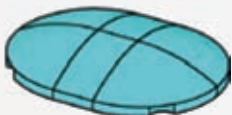

2

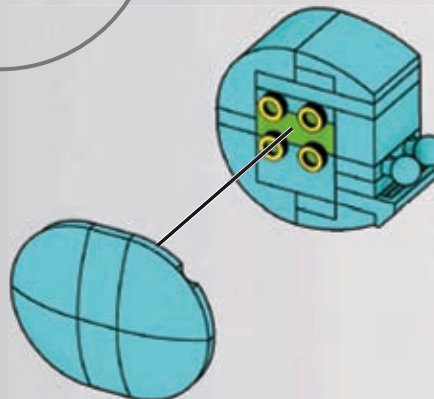

1

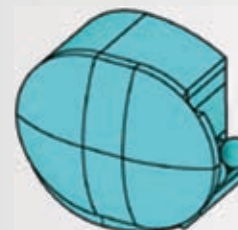

2

142

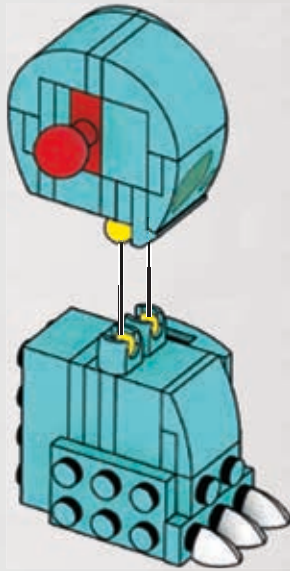

1

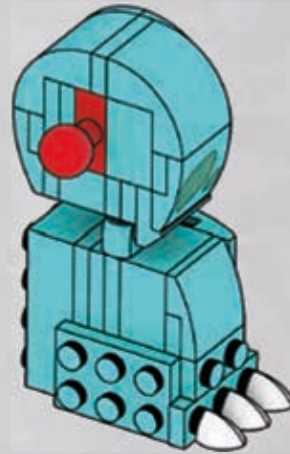

2

143

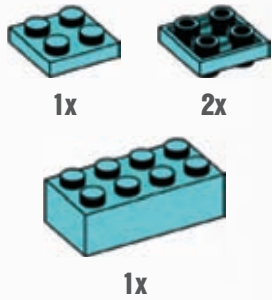

144



145

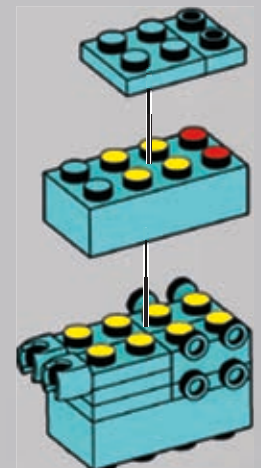
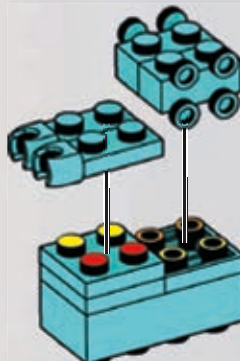
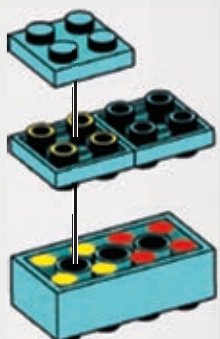
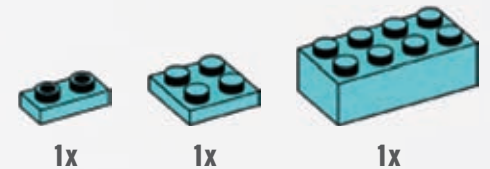

146



1x

1x

147



1x

3x

1x

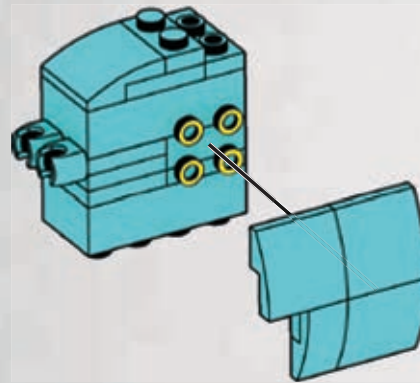
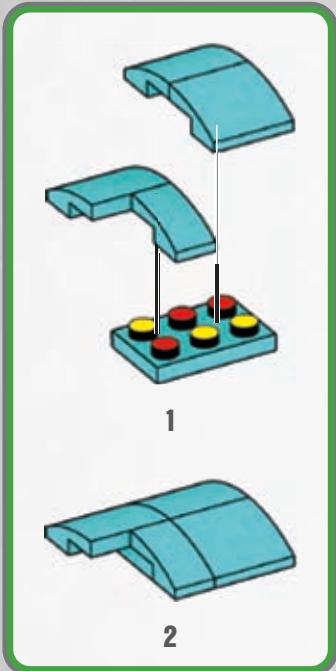
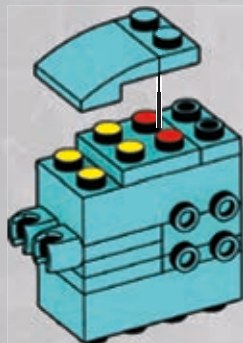
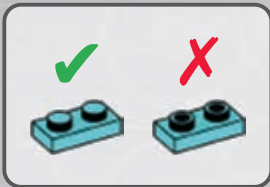

1

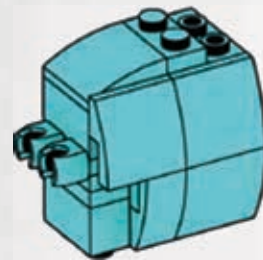

2

148



3x

1x

1x

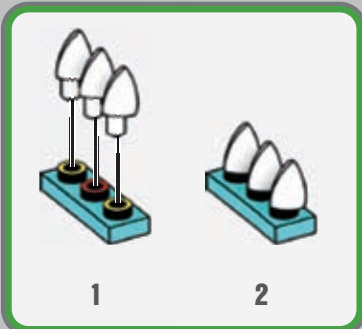
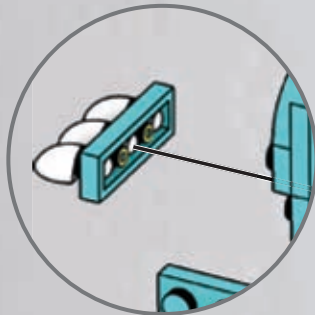

1

2

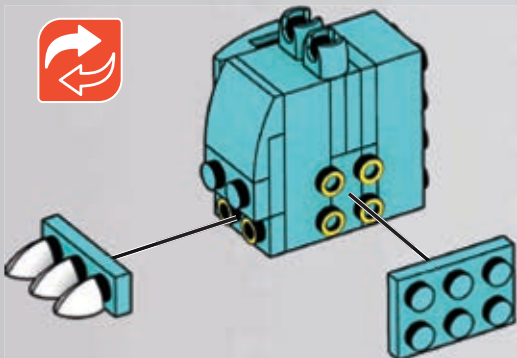

1

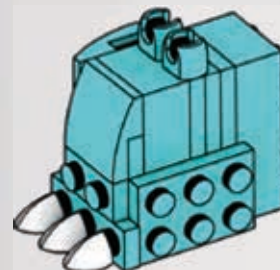

2

149



1x



1x



1x



1x

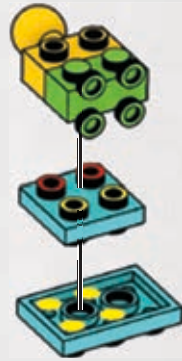

150



1x



1x



1x

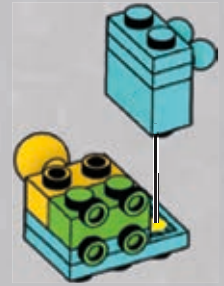
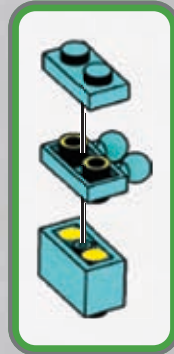
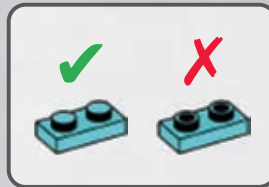

151



1x

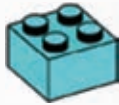

1x

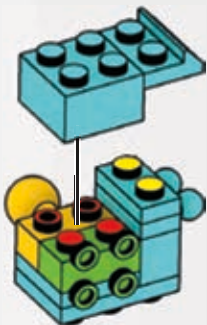

152



1x



1x

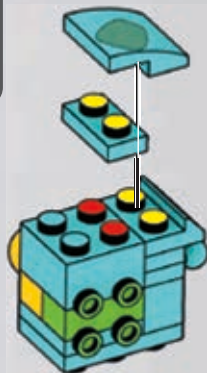
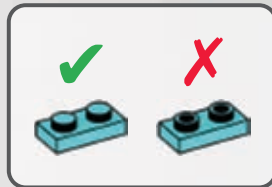

153



1x



1x

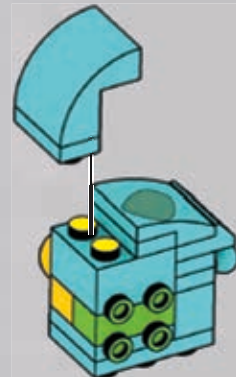

1

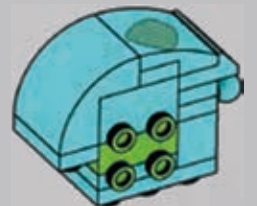

2

154

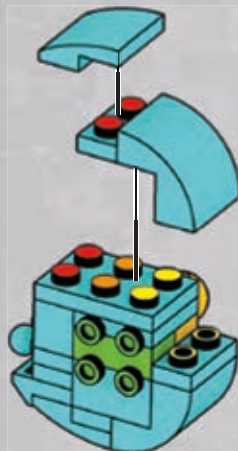
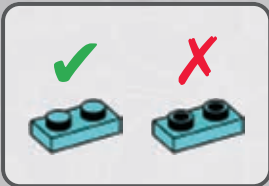
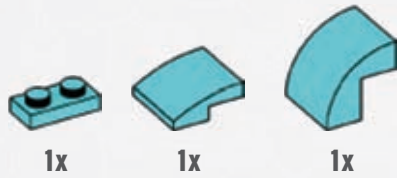

155

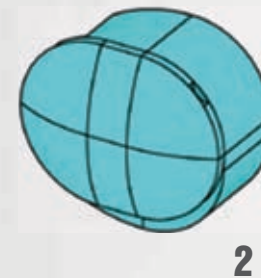
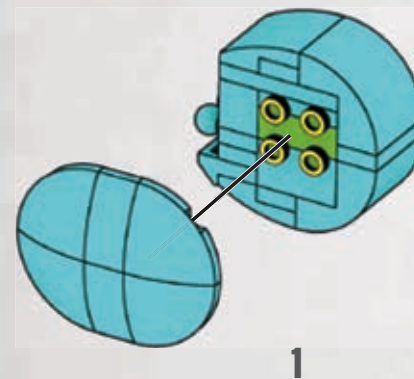
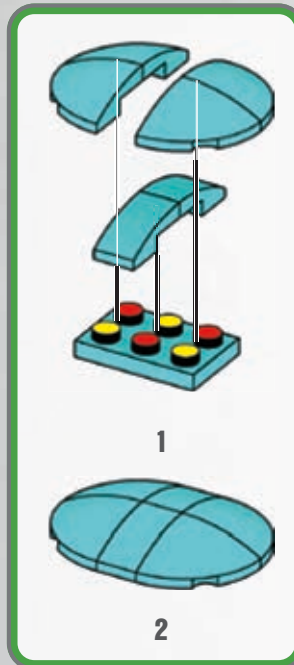
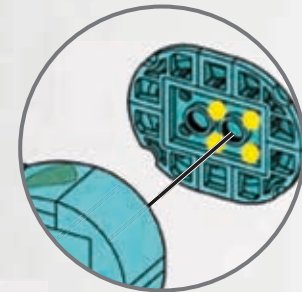
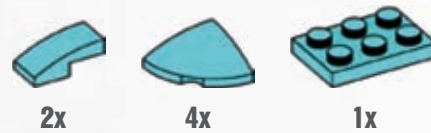

156

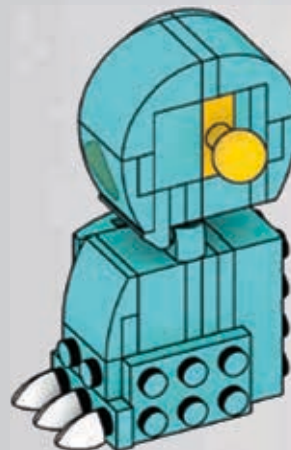
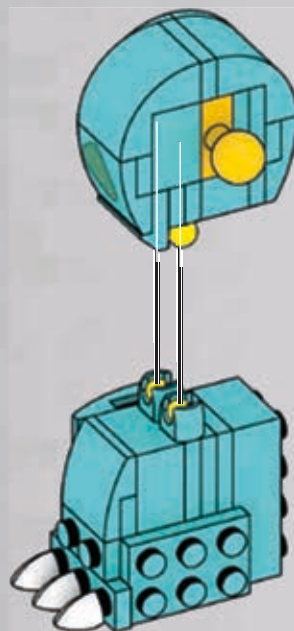

157

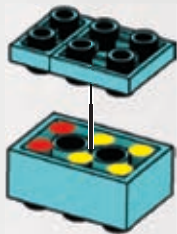

158

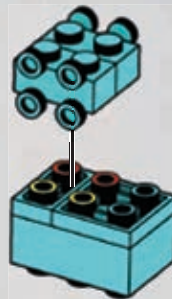

159

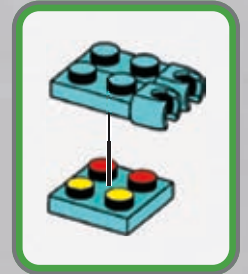
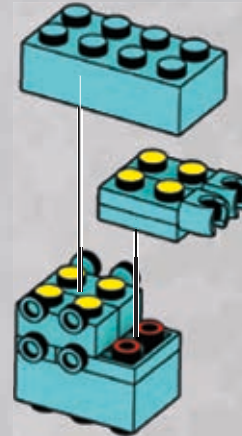
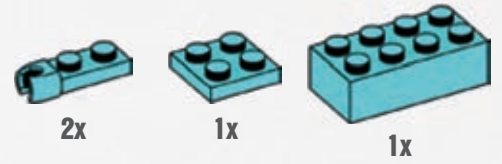

160

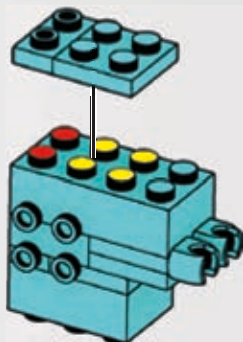
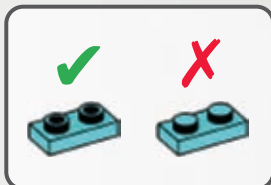
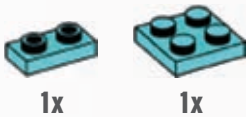

161

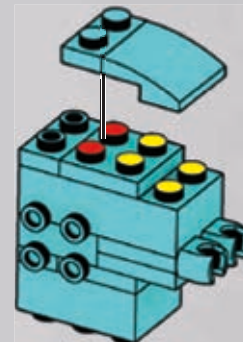
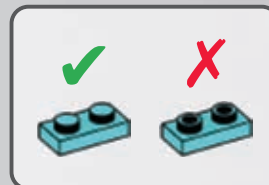

162



1x

3x

1x

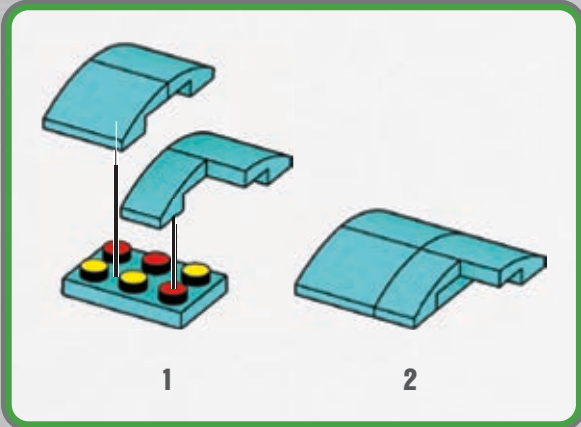

1

2

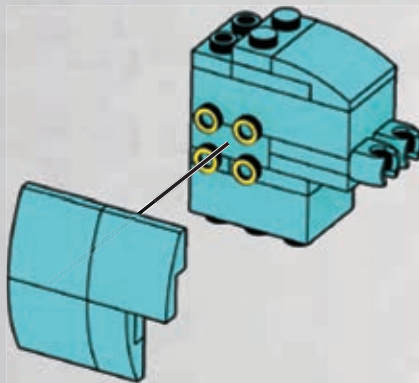

1

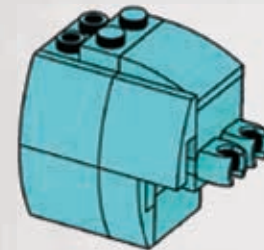

2

163



3x

1x

1x

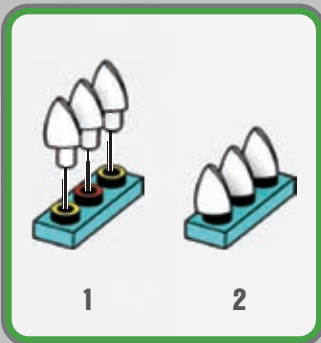

1

2

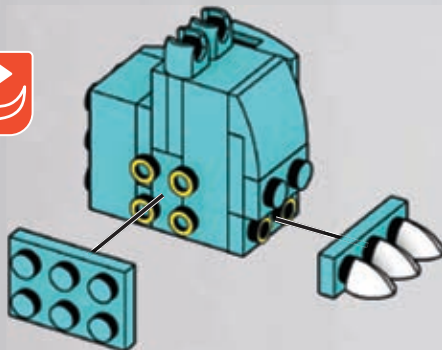
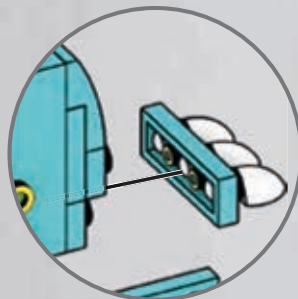

1

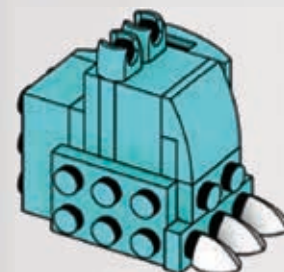

2

164



1x



2x



1x

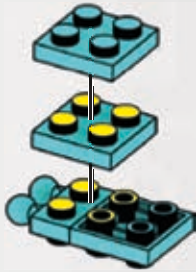

165



1x



1x

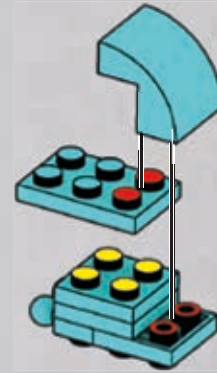

166



1x



1x

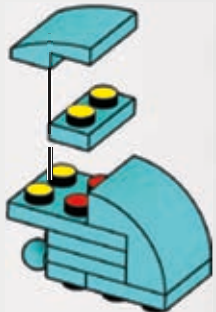
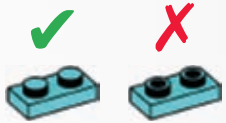

1



2

167



1x



1x



1x

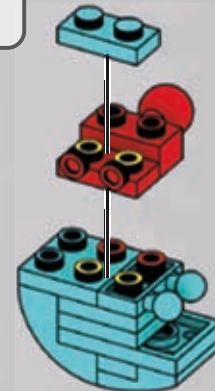
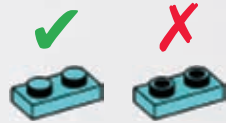

168

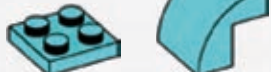

1x

1x

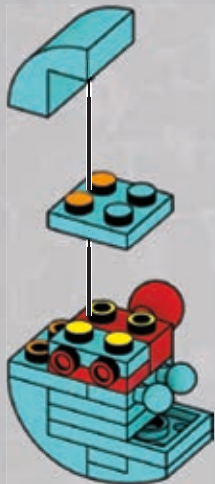

169



1x

1x

3x

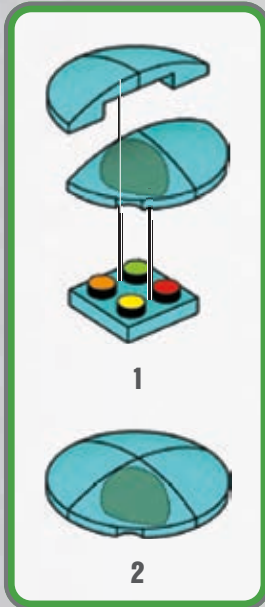

1

2

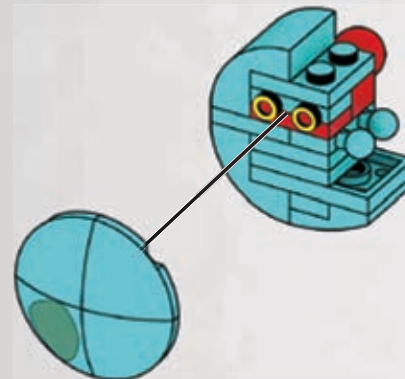

1

2

170

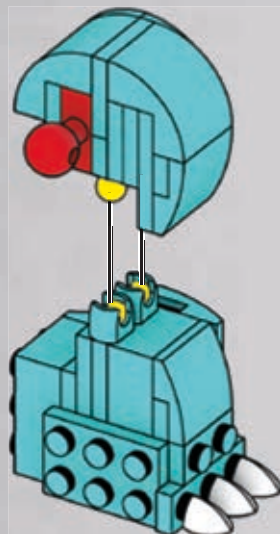

1

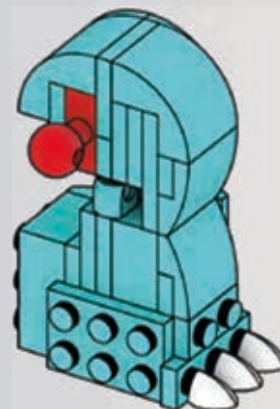

2

171

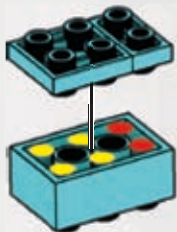
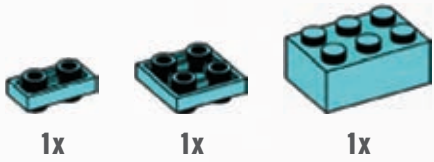

172

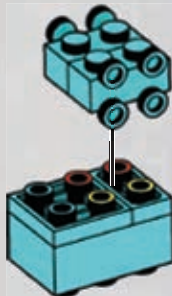

173

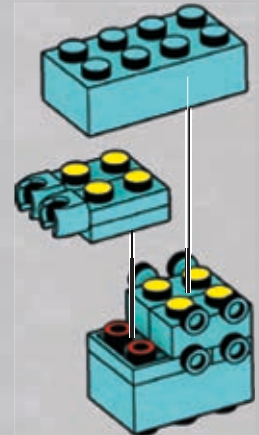
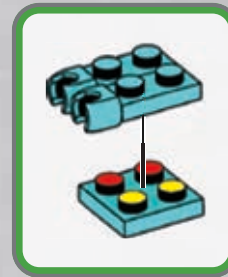
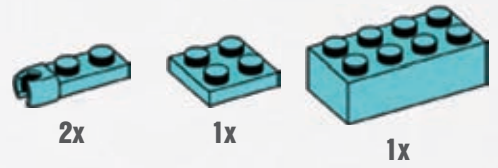

174

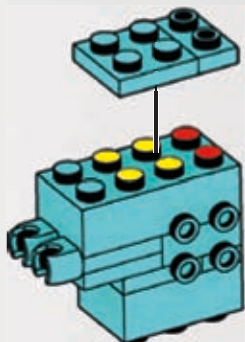
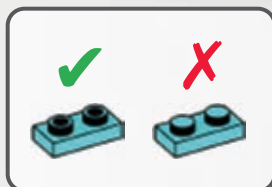
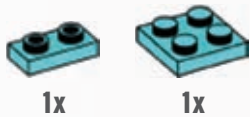

175

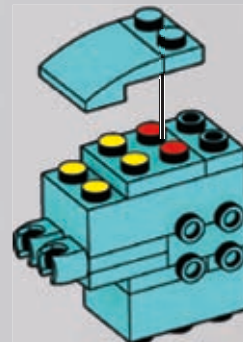
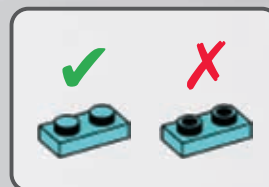

176



1x

3x

1x

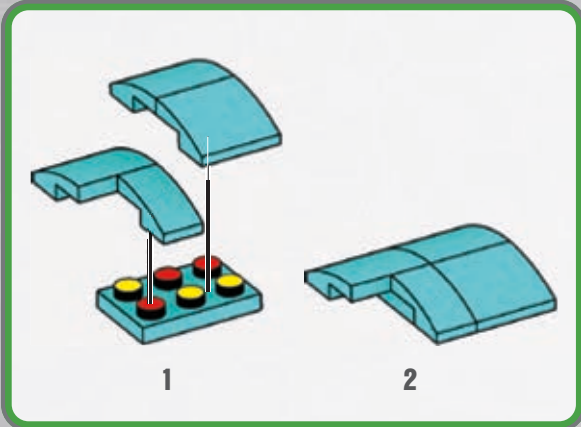

1

2

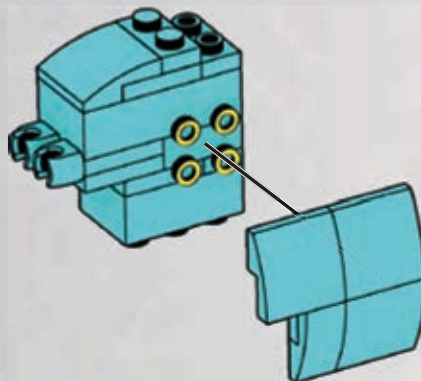

1

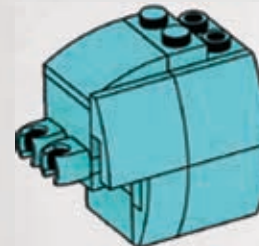

2

177



3x

1x

1x

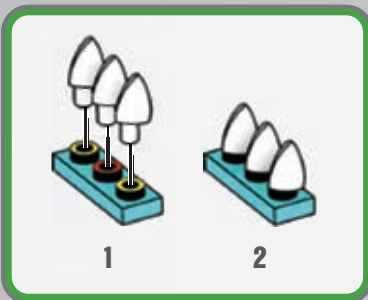

1

2

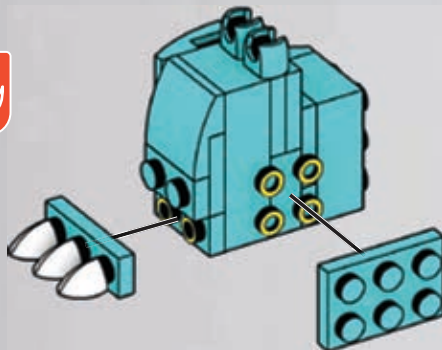
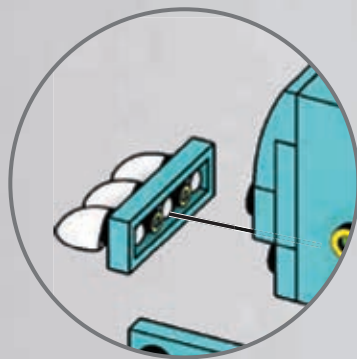

1

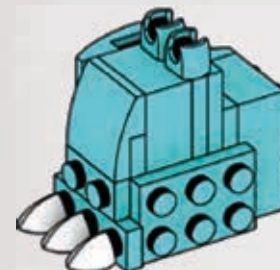

2

178



1x



2x



1x

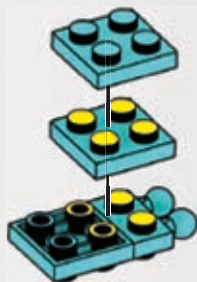

179



1x



1x



180



1x



1x

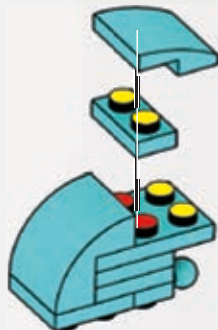
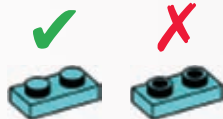

1



2

181



1x



1x



1x

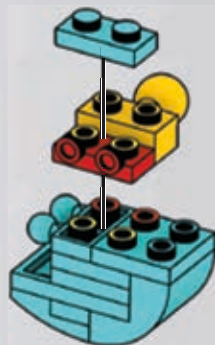

182



1x



1x

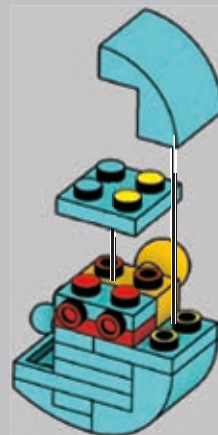

183



1x



1x



3x

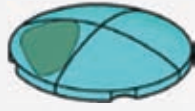
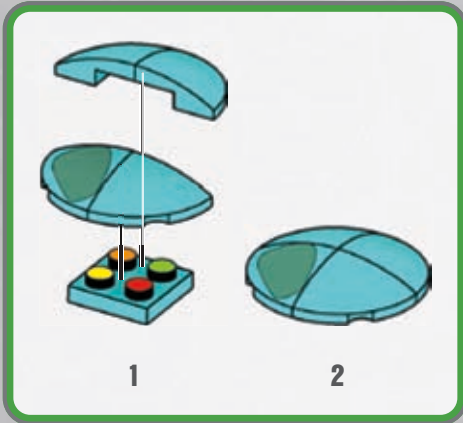

2

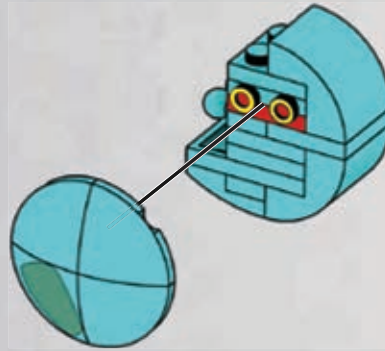

1

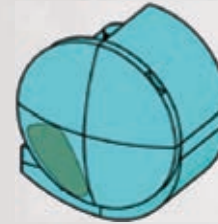

2

184

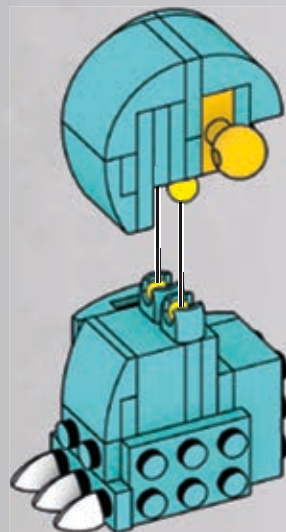

1

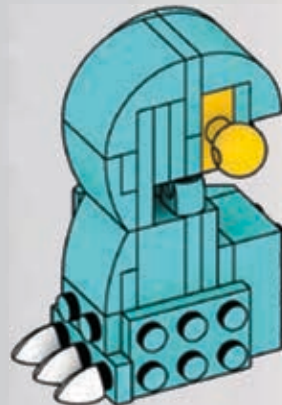

2

185

156

184

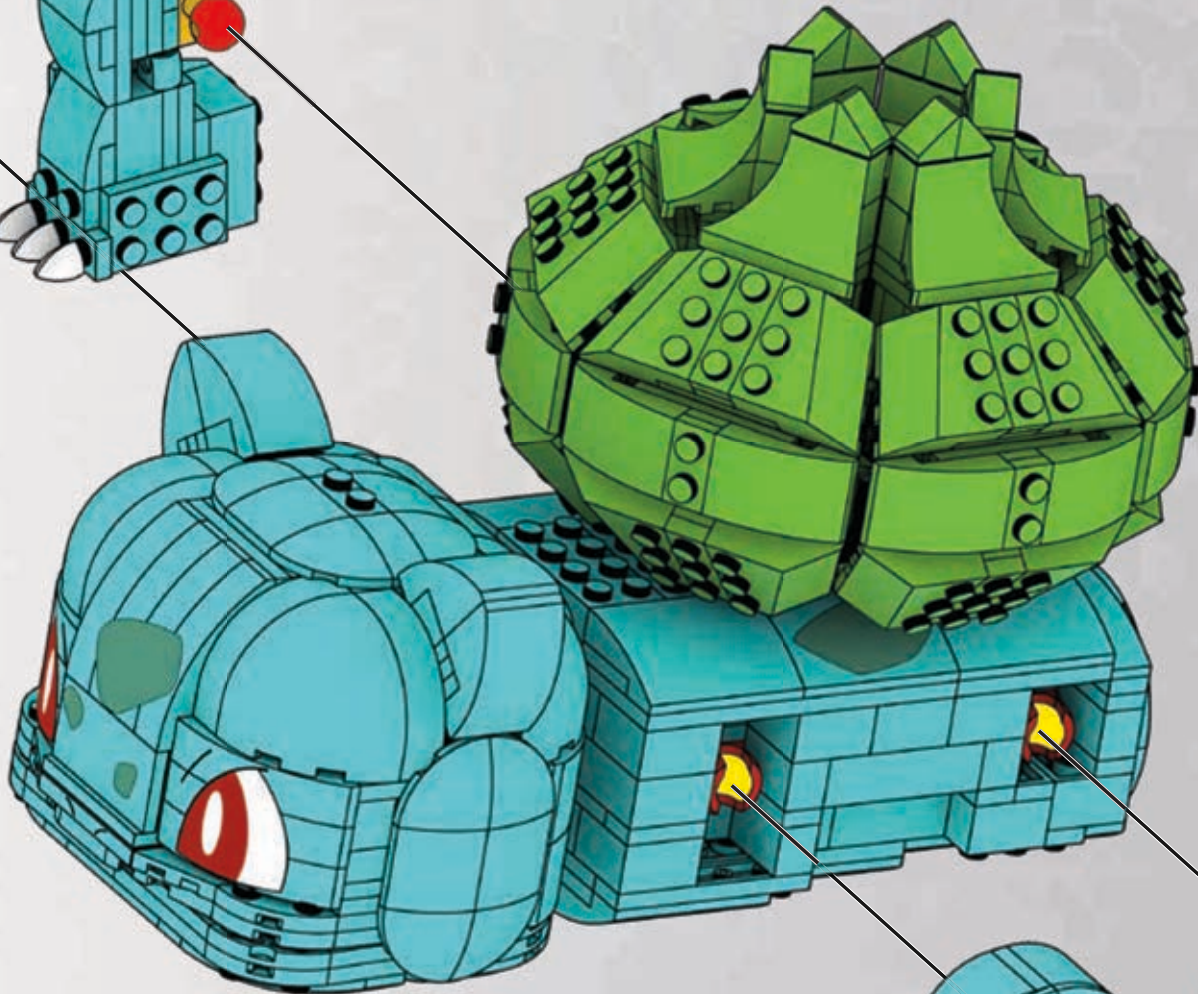
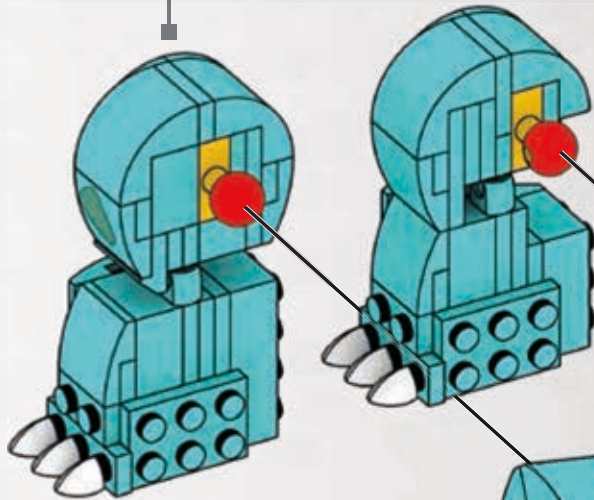

170

142

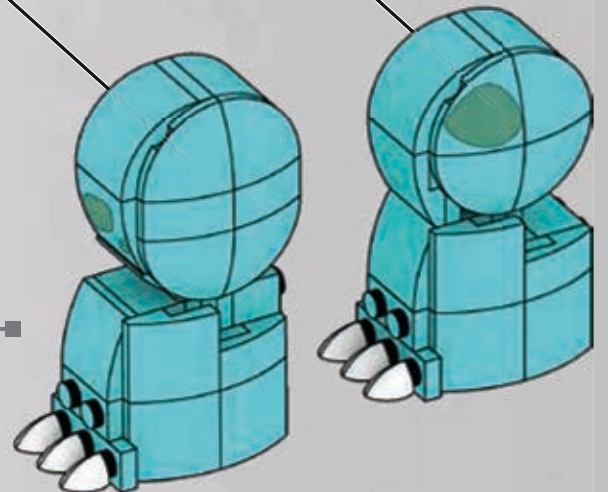

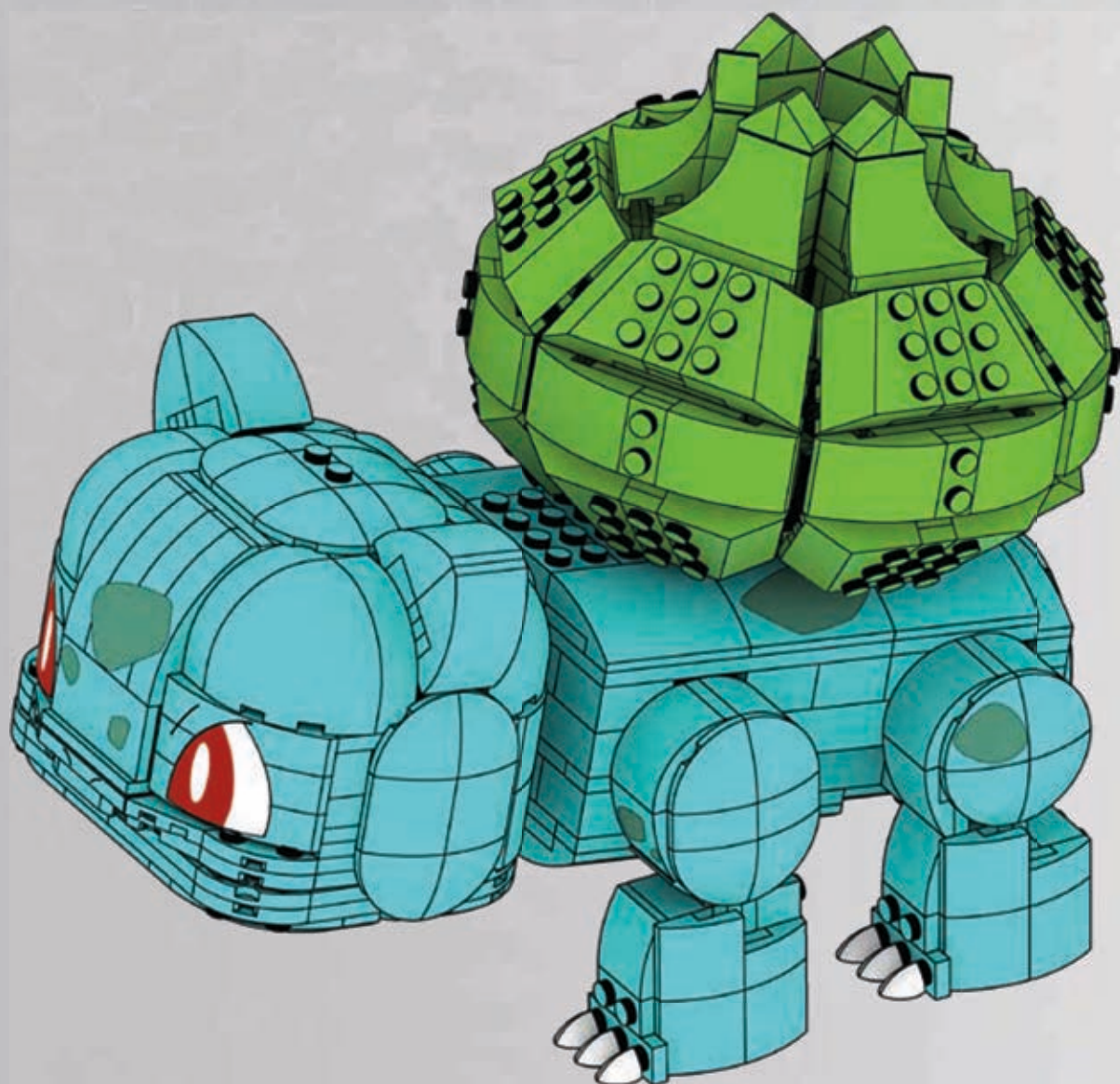

POSE IT! VARIEZ LES POSES !

¡PÓSALO! / VOCÊ PODE POSAR!
LÄSST SICH IN COOLE POSEN BRINGEN!
МЕНЯЙ ПОЗЫ!



6x
AM03328ASU



4x
AM81529AMC



2x
AM77901E



12x
AM15258HT



2x
AM01086ASU



12x
AM81555E



12x
AM74415HT



46x
AM09393ASU



1x
AM09393NU



2x
AM09393AMC



26x
AM09393HT



24x
AM16680ASU



4x
AM79246ASU



4x
AM76467ASU



2x
AM79070ASU



5x
AM79070AMC



2x
AM78277ASU



2x
AM78397ASU



4x
AM79369ASU



8x
AM80765ASU



2x
AM04322ASU



2x
AM09835ASU



6x
AM72000HT



1x
AM18665ASU



1x
AM18666ASU



1x
AM73009AMC



12x
AM81559HT



22x
AM03773ASU



18x
AM03773HT



18x
AM01146ASU



10x
AM78486ASU



2x
AM78486NU



4x
AM17128ASU



10x
AM09013ASU



7x
AM09013HT



12x
AM81353ASU



12x
AM81353HT



2x
AM79796AMC



2x
AM79796BYE



2x
AM79227AMC



2x
AM79227BYE



12x
AM17153ASU



8x
AM09023ASU



12x
AM09023HT



2x
AM01314ASU

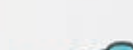

36x
AM01314HT



4x
AM72600ASU



26x
AM76525ASU



2x
AM76525NU



1x
AS-HNT96-15



1x
AS-HNT96-17



1x
AM74106NU



30x
AM74106ASU



1x
AS-HNT96-16



1x
AS-HNT96-14

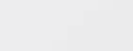

2x
AM18328ASU

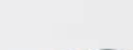

2x
AM18329AMC

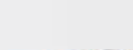

1x
AM80832HT



6x
AM16384ASU



1x
AM17073ASU



1x
AM17074ASU



31x
AM03772ASU

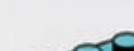

2x
AM03772AMC



12x
AM03772HT



4x
AM17056ASU



1x
AM09838ASU



19x
AM09593ASU



4x
AM09593AMC



12x
AM07230ASU



11x
AM08481ASU



6x
AM03873ASU



12x
AM17021HT



12x
AM15479HT



12x
AM15478HT



3x
AM03323ASU

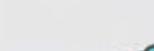

3x
AM03324ASU



6x
AM18299HT



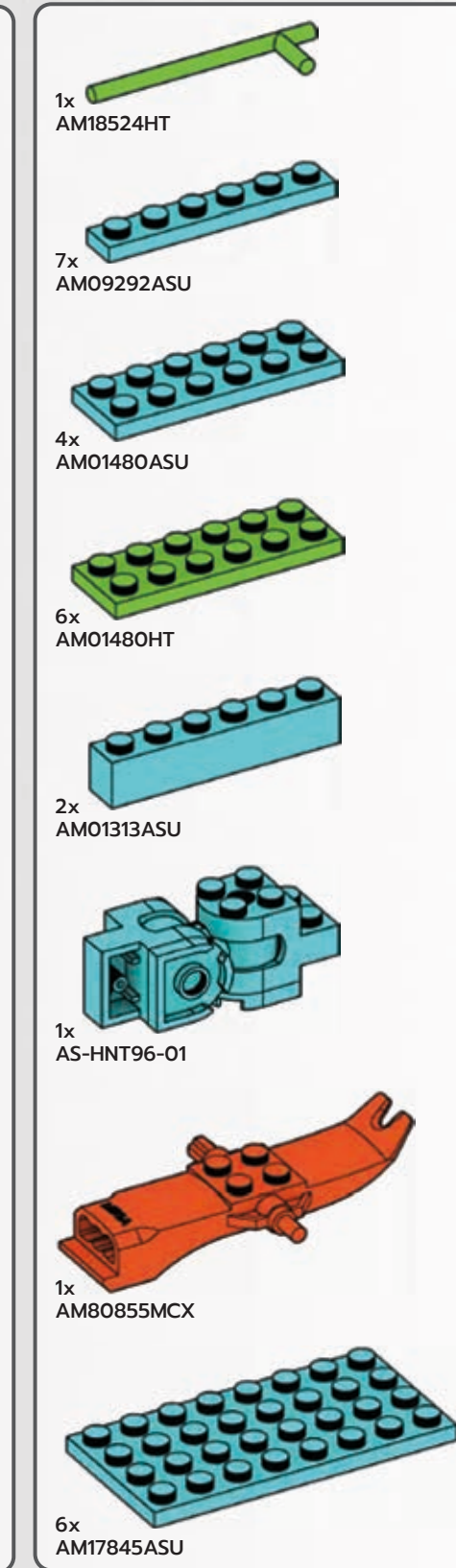
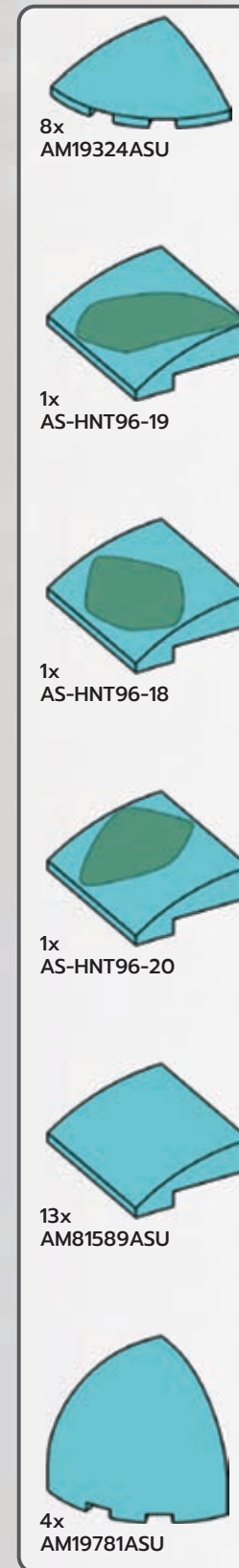
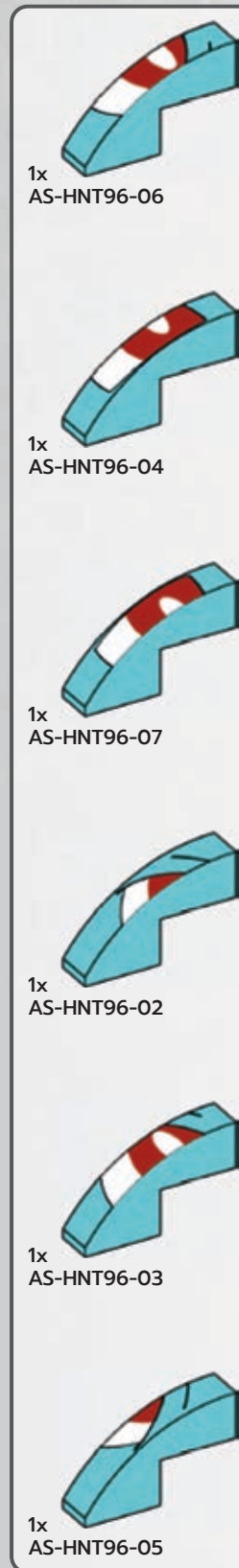
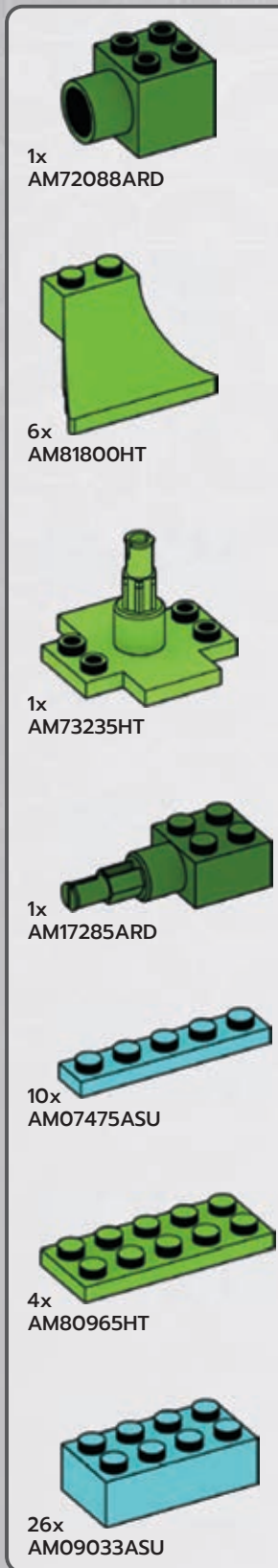
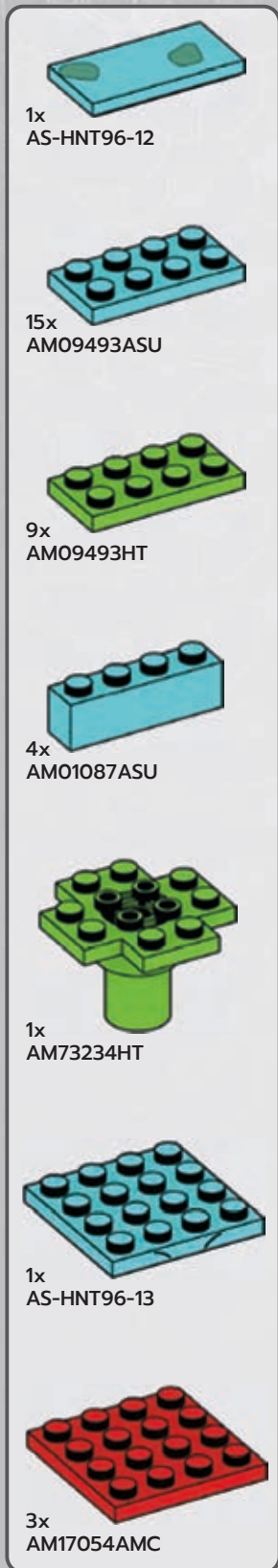

Mattel Europa B.V., Gondel 1, 1196 MJ Amstelveen, Nederland. Mattel U.K. Limited, The Porter Building, 1 Brunel Way, Slough SL1 1FQ, UK. Mattel France, Parc de la Cerisaie, 1/3/5 allée des Fleurs, 94260 Fresnes Cedex. N° Cristal 0969 36 99 99 (Numéro non surtaxé) ou www.lesjouetsmattel.fr. Mattel Belgium, Trade Mart, Atomiumsquare, Bogota 202 - B 275, 1020 Brussels. Gratis nummer België: 0800 - 16 936 - Gratis nummer Luxemburg: 800 - 22 784 - Gratis nummer Nederland: 0800 - 262 88 35. Deutschland : Mattel GmbH, Solmsstraße 83, D-60486 Frankfurt am Main. Schweiz: Mattel AG, Kirchstrasse 24, CH-3099 Liebefeld. Österreich: Mattel Ges.m.b.H., Campus 21, Liebermannstraße A01 404, A-2345 Brunn/Gebrige. Mattel Italy Srl, Via Turati 4, 20121 Milano, Italy. Servizio assistenza clienti: Customersrvitalia@mattel.com - Numero verde 800 11 37 11. Mattel España, S.A., Airbau 200 pl. 9, 08036 Barcelona. cs.service.spain@mattel.com Tel: +34 933 06 79 00 http://www.service.mattel.com/es. Hong Kong: Kids Kingdom Limited, Room 1908-9, Gala Place, 56 Dundas Street, Mongkok, Kowloon, Hong Kong. Customer Care line: (852)2782-0766. Taiwan: Chickabiddy Company Limited, 5/F, No. 186, Section 4, Nanjing East Road, Taipei 10595, Taiwan. Customer Care line: (02)2578-1188. Mainland China: Mattel Barbie (Shanghai) Trading Co., Ltd. Units 4701-4711, 47F, 2 Grand Gateway, 3 Hong Qiao Road, Shanghai, 200030, P.R.C. Customer Care line: 400-819-8658. Diimpor: Diemart & Diemartkan Oleh: Mattel Continental Asia Sdn Bhd. Level 19, Tower 3, Avenue 7, No. 8 Jalan Kerinchi, Bangsar South, 59200 Kuala Lumpur, Malaysia. Mattel South Africa (PTY) LTD, Office 102 B3, 30 Melrose Boulevard, Johannesburg 2196. Distributor: Mattel Poland Sp. z o.o., Warsaw Trade Tower 34 p, ul. Chłodna 51, 00-867 Warszawa. Mattel Australia Pty. Ltd., 658 Church St., Richmond, Victoria, 3121. Consumer Advisory Service - 1300 135 312. Mattel AEBE, EBYayouy Muxoprou 1, Kriprou K-2, TK 17561, Polokou Odhigo, Mattel Oyuncakçılık Tic. Ltd. Şti. Çekirdek Mah. Umut Sokak No: 10 - 12, Quick Tower kat:2 içkapı no:15 Ataşehir 34752, İstanbul, Türkiye. Tel: 0216 570 75 00. Импортер/Уполномоченная организация: ООО "МАТТЕЛ" Российская Федерация, 105120 Москва, 2-й Сыроматинский переулок 1, +7 495 287 79 39. Mattel Czech Republic s.r.o., The Forum, Václavské nám. 19, 11000 Praha1, Mattel, 333 Continental Boulevard, El Segundo, CA 90245, USA. Consumer Services: 1-800-465-MEGA (6342). Mattel Canada Inc., Mississauga, Ontario L5R 3W2. Consumer Services: You may call us free at/Composez sans frais le 1-800-524-8697. Importador y distribuidor por Mattel de México, S.A. de C.V. Miguel de Cervantes Saavedra No. 193, Pisos 10 y 11, Col. Granada, Alcaldía Miguel Hidalgo, C.P. 11520, México, Ciudad de México. R.F.C. MME-920701-NB3. Tels: 59-05-51-00 Ext. 5206 ó 01-800-463-59-89. Mattel Chile, S.A., Avenida Américo Vespucio 501-B, Quilicura, Santiago. Tel: 1230-020-6213. Servicio al consumidor Venezuela: Tel: 0-800-100-9123. Mattel Argentina, S.A., Av. Libertador 1000, Piso 11 - Oficinas 109 y 111, Vicente López - Prov. Buenos Aires. Tel: 0800-666-3373. Mattel Colombia, S.A., Calle 123#7-07 P5, Bogotá. Tel: 01800-710-2069. Mattel Perú, S.A., Av. Juan de Arona # 151, Centro Empresarial Juan de Arona, Torre C, Piso 7, Oficina 704, San Isidro, Lima 27, Perú. RUC: 20425853865. Reg. Importador: 02350-12-JUE-DIGESA. Tel: 0800-54744. E-mail Latinoamérica: servicio.clientes@mattel.com. Mattel do Brasil Ltda. - CNPJ: 54.558.002/0001-20 - Rua Verbo Divino, 1488 - 2ª - Andar - 04719-904 - Chácara Santo Antônio - São Paulo - SP - Brasil. Serviço de Atendimento ao Consumidor: fone 0800 575 0780. E-mail: sac.mattel@brasil.mattel.com

Missing pieces?
Pièces manquantes?
¿Partes faltantes? • Perdeu peças?
Fehlen Teile? • Не хватает деталей?

support.megabrands.com

©2022 Pokémon. ©1995–2022 Nintendo / Creatures Inc. / GAME FREAK inc. TM, ©, and character names are trademarks of Nintendo.
©2022 Pokémon. ©1995–2022 Nintendo/Creatures Inc./GAME FREAK inc. TM, © et les noms des personnages sont des marques de Nintendo.

MEGA™

POKÉMON™



GMD34



HHL13



FVK81

Set(s) sold separately and subject to availability. / Ensemble(s) vendu(s) séparément. Certains produits peuvent ne pas être commercialisés.

/ Se vende(n) por separado y está(n) sujeto(s) a disponibilidad. / Conjunto(s) vendido(s) em separado e sujeito(s) à disponibilidade. / Set in vendita separatamente, secondo disponibilità. / Das/Die Set(s) sind separat erhältlich. / Zestaw(y) sprzedawany(e) oddzielnie w zależności od dostępności. / Set(s) apart verkrijgbaar en afhankelijk van beschikbaarheid. / Набор(-ы) продаются отдельно, при наличии. / Sæt sælges separat og så længe lager haves. / Seten säljs separat så länge lagret räcker. / Settet/settene selges separat så langt lageret rekker. / Pakkaus/pakkaukset myydään erikseen, saatavuus voi vaihdella. / Το(α) σετ πωλούνται ξεχωριστά και ανάλογα με τη διαθεσιμότητα. / Setler ayrı olarak satılır ve stoklarla sınırlıdır. / Set (sety) se prodává (prodávají) samostatně dle aktuální nabídky. / Súprava/-y sa predáva(jú) samostatne a podľa dostupnosti. / A készlet(ek) külön kapható(k), az elérhetőség változhat. /

セット商品は別売りになります。在庫状況は別途ご確認をお願いします。 /

تباع المجموعة أو المجموعات على حدة وتخضع لتوافرها.

每套单独发售，按供货情况决定。

Jumbo Bulbasaur / Bulbizarre géant à construire / Jumbo Bisasam

Bulbasaur Gigante / Bulbasaur Jumbo / Stor Bulbasaur / Duży Bulbasaur

Óriási Bulbasaur / Большой Bulbasaur

©2022 MEGA Brands &™ MEGA Brands.

Printed in China / Imprimé en Chine

AD-HNT96-01A

Mattel Canada Inc. Mississauga, Ontario L5R 3W2.

MADE IN CHINA. FABRIQUÉ EN CHINE. FABRICADO NA CHINA. HECHO EN CHINA.

ИЗГОТОВЛЕНО В КИТАЕ. ÇIN'DE ÜRETİLMİŞTİR. صنع في الصين.

© D781,964, D797,203,
D841,101, D834,105

1186 MJ, 1, NL



FR

