

MEGA

POKÉMON



HTH79

VULPIX EVOLUTION SET COFFRET ÉVOLUTION GOUPIX

CONJUNTO EVOLUCIÓN DE VULPIX / CONJUNTO DE EVOLUÇÃO DO VULPIX
VULPIX ENTWICKLUNGSSET / НАБОР "ЭВОЛЮЦИЯ VULPIX"



**GET INSTRUCTIONS ONLINE
INSTRUCCIONES DISPONIBLES
EN LIGNE**

CONSULTA LAS INSTRUCCIONES EN LÍNEA
OBTEN INSTRUÇÕES ONLINE
ANWEISUNGEN ONLINE ERHÄLTICH
ИНСТРУКЦИИ ДОСТУПНЫ ОНЛАЙН



megaunboxed.com

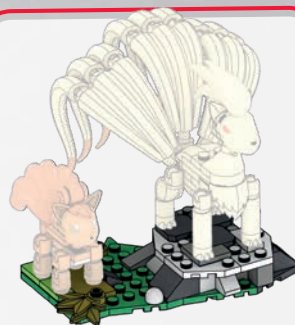
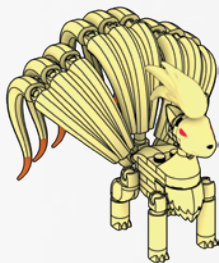

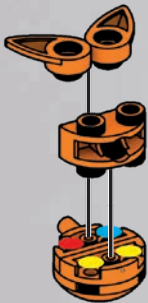
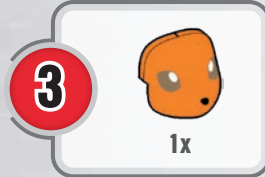
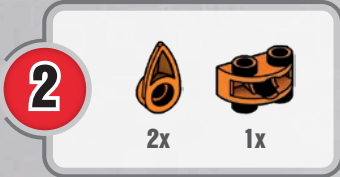
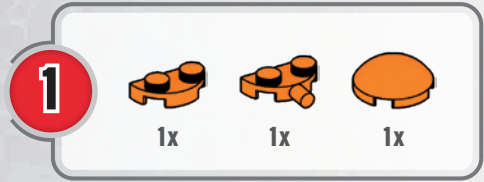

1

2

4



1x



1x



1x



1x

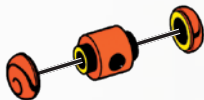

1



2



1



2

5



1x



1x



1x

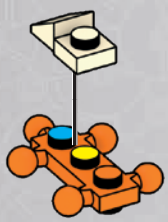

6



1x

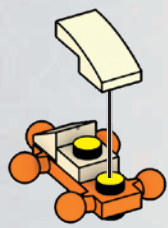

1

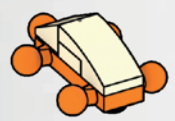

2

7



1x

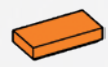

1x

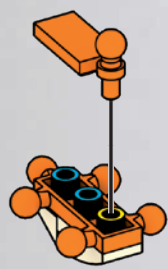

8



1x



1x

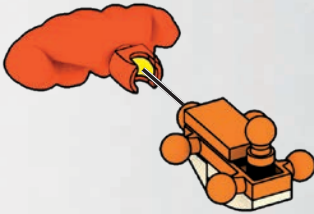
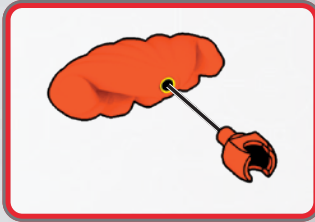

1



2

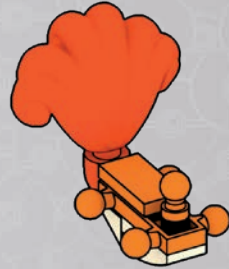

3

9

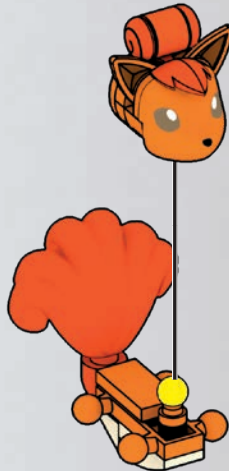

10



4x



4x



1



2

x4

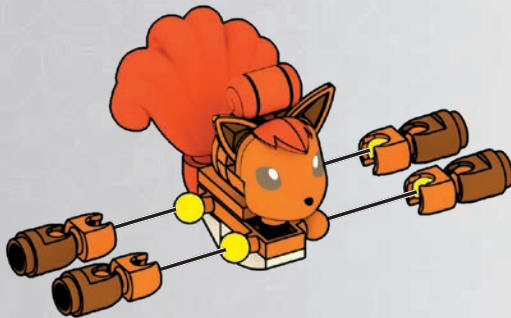

1

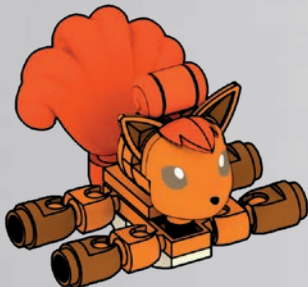

2



3



11



2x



1x



1x

12



1x

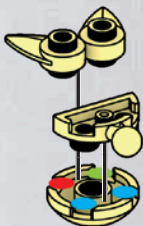

13



1x



1x



1x

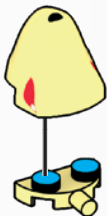

1



2



1



2

14



1x



1



2

15



1x



2x

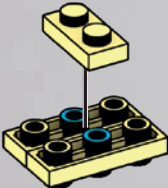

16

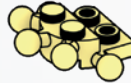

1x

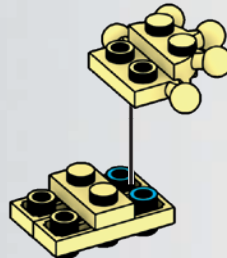

17



1x

2x

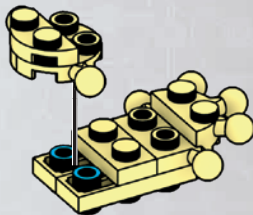
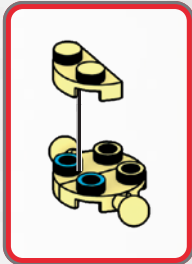

18

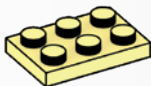

1x

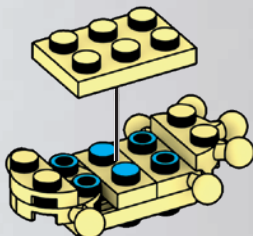

19



1x

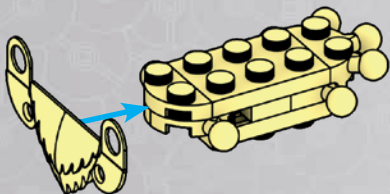

1

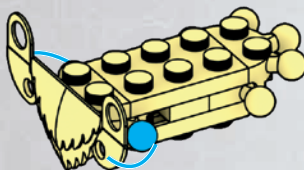

2

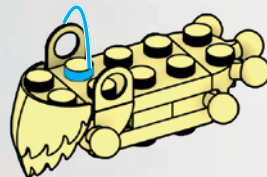

3

20



1x

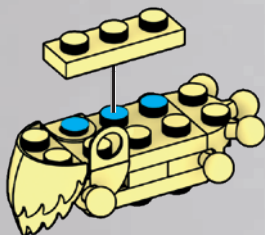

1

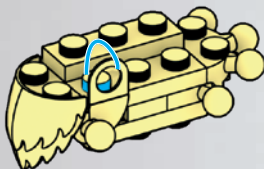

2

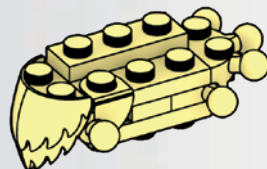

3

21



1x

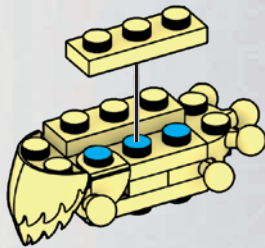

1

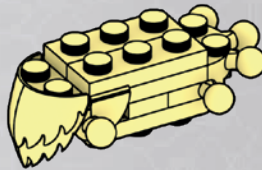

2

22



1x



1x



1x

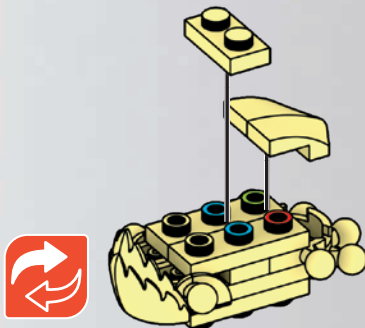

23

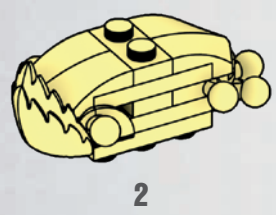
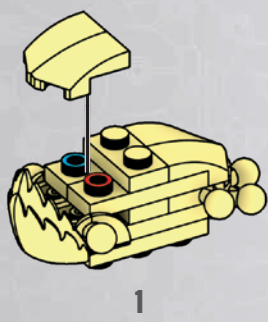
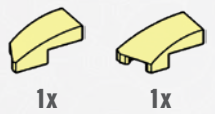

24

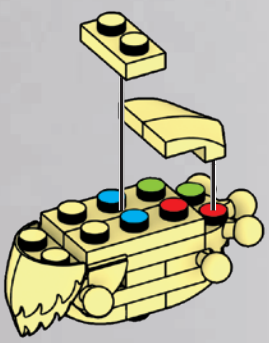

25

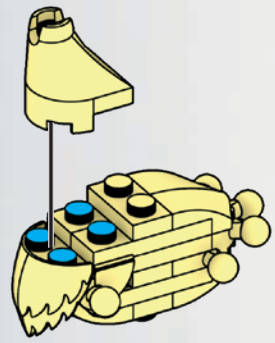

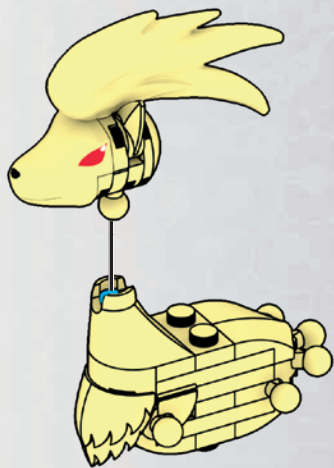

1

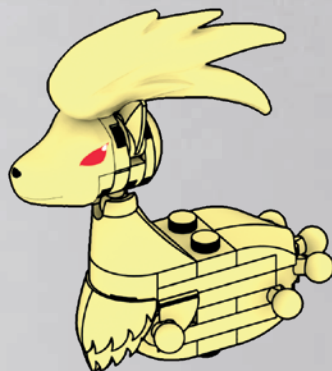

2

27

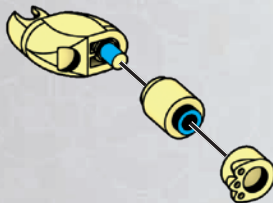
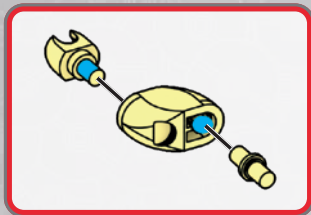
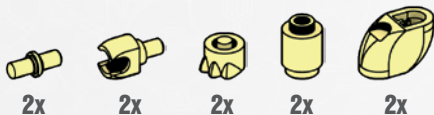

1

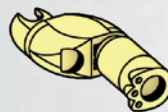

2

x2

28

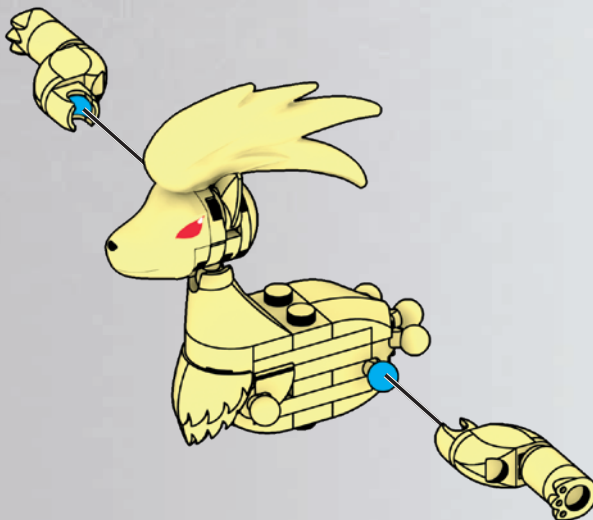

29



2x



2x



2x



1



2

x2

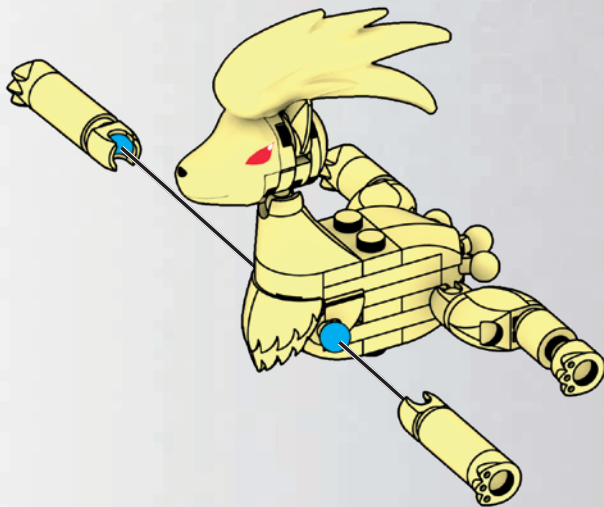

1

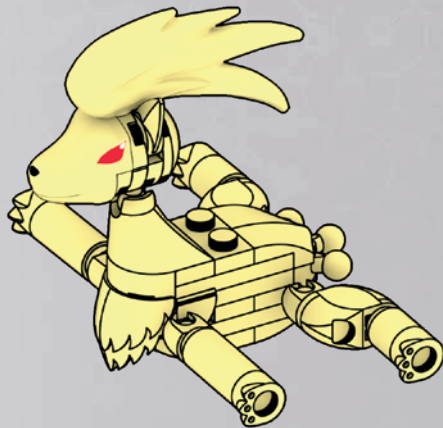

2

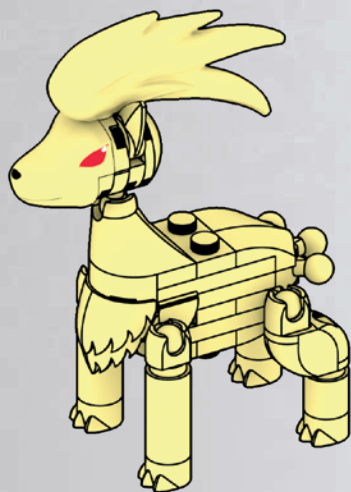

3

30



1x



1x



1x

31



3x

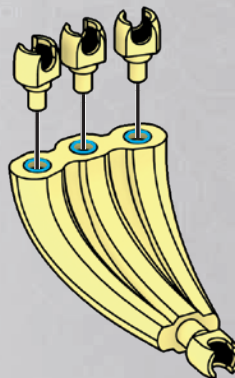
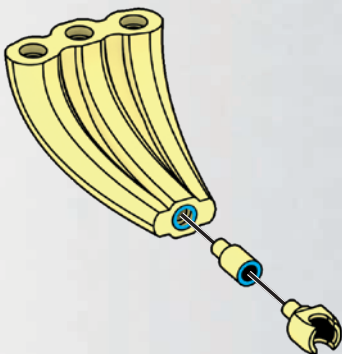

32



3x



3x

x3

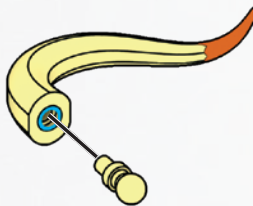

1



2

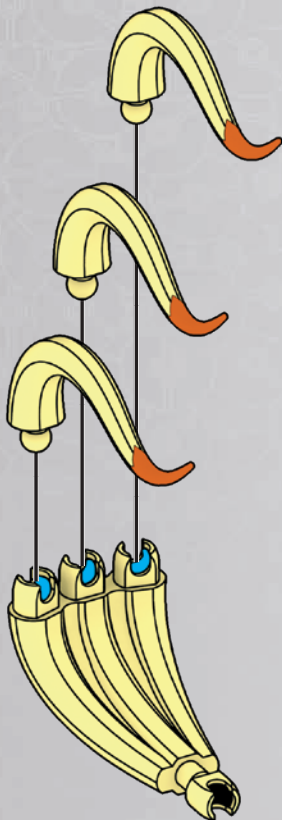

1

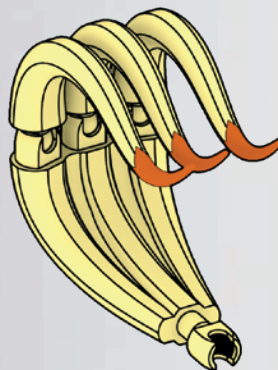

2

33

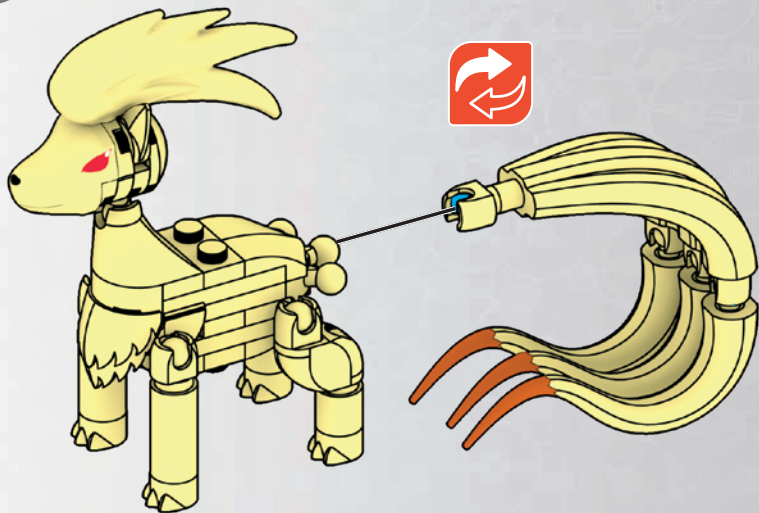

1

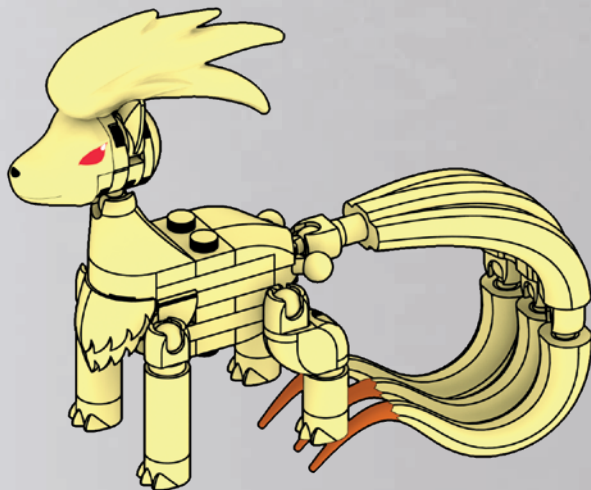

2



3

34



1x



1x

35



3x

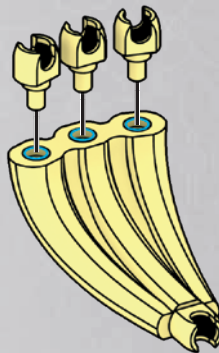
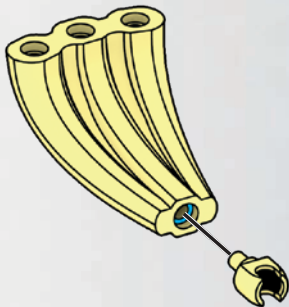

36



3x



3x

x3

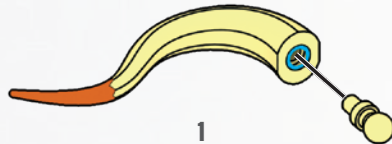

1



2

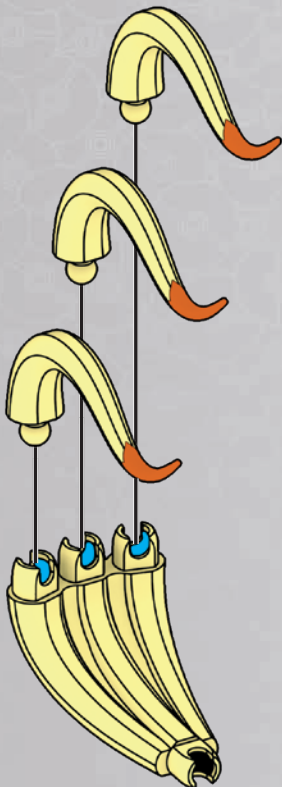

1

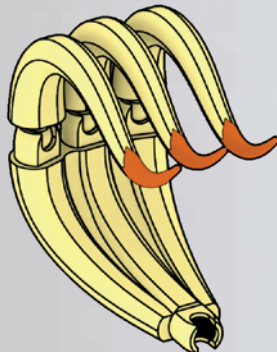

2

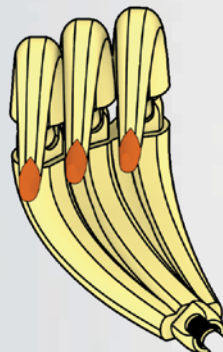

3

37

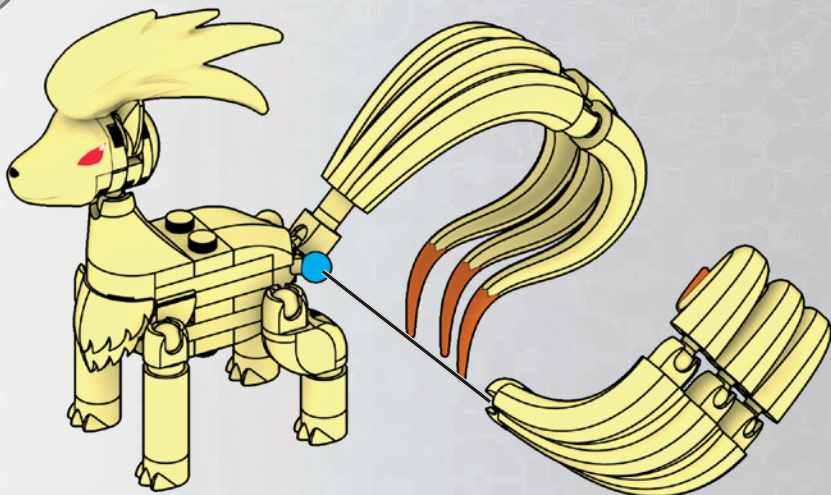

1

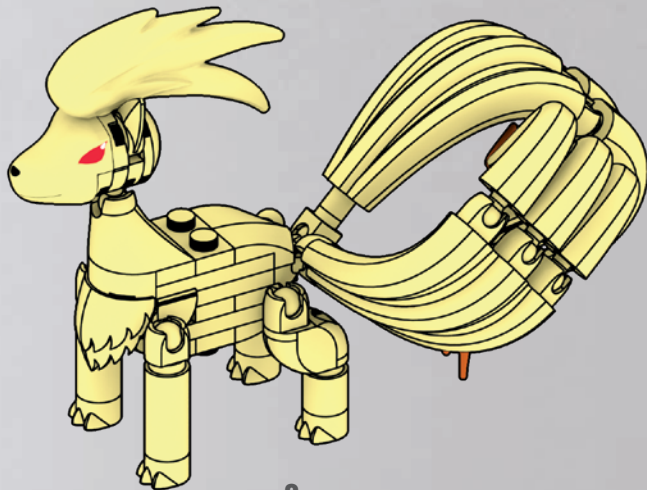

2

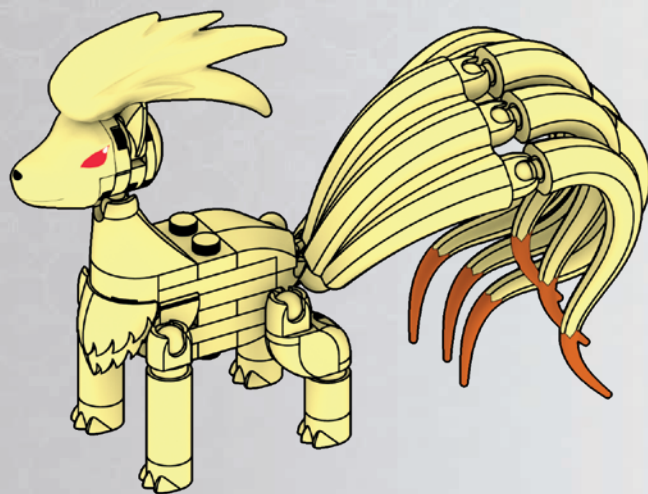

3

38



1x



1x

39



3x

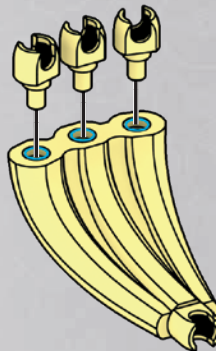
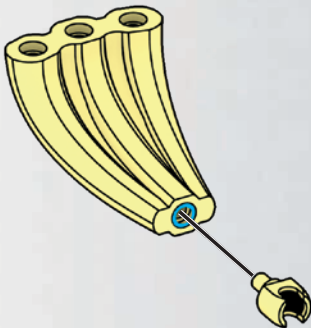

40



3x



3x

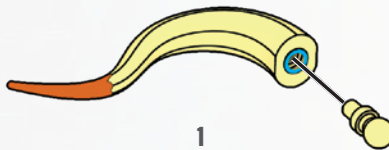

1

x3



2

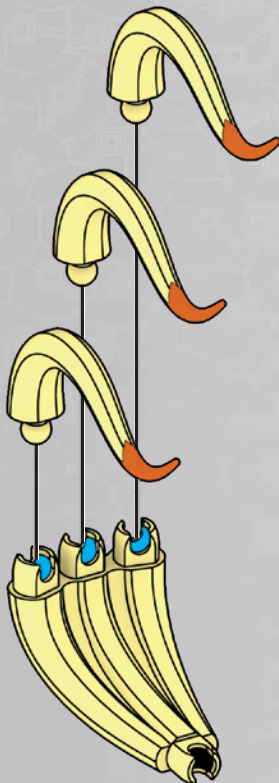

1

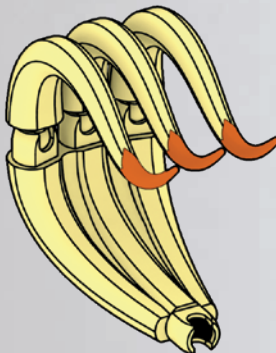

2

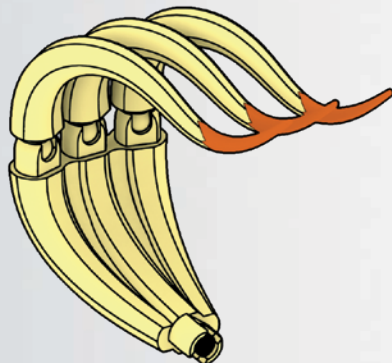

3

41

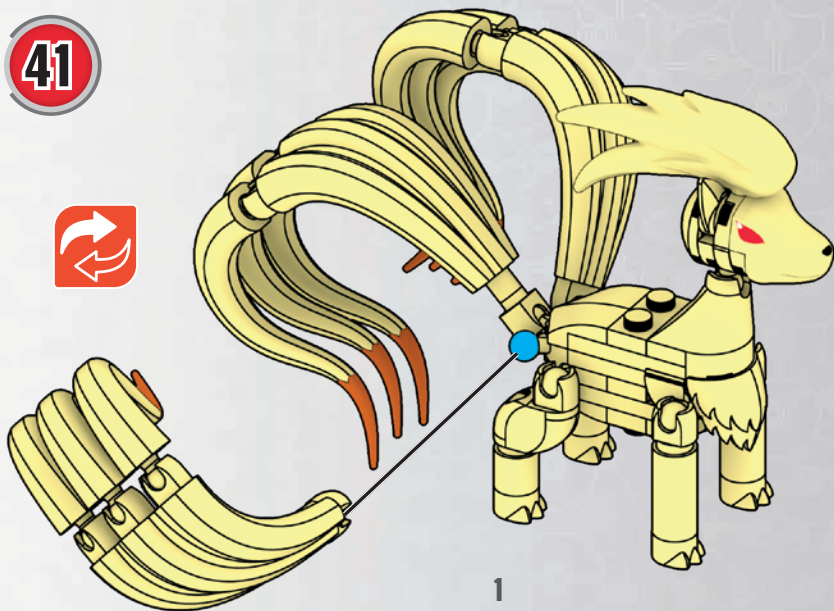

1

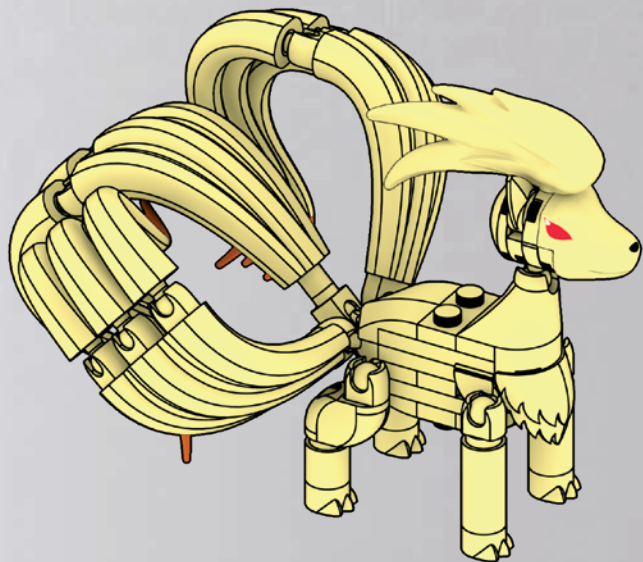

2

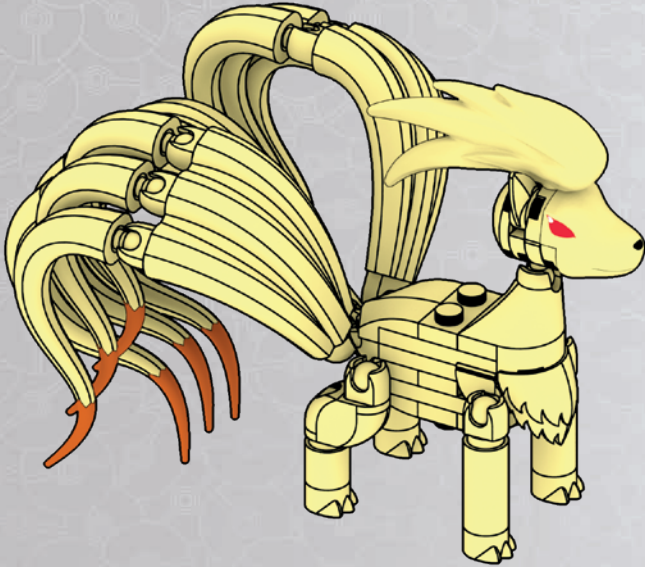

3

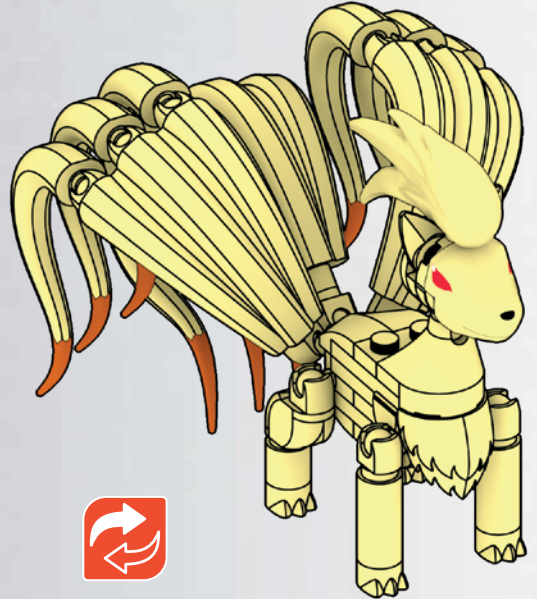

4

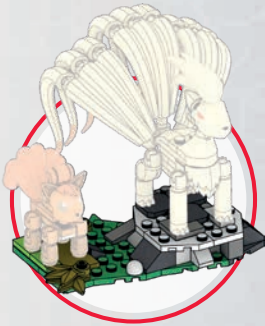

42



2x



1x

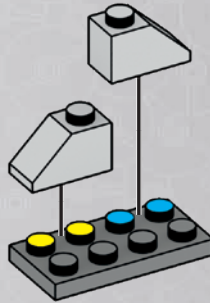

43



1x

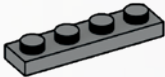

1x



1x

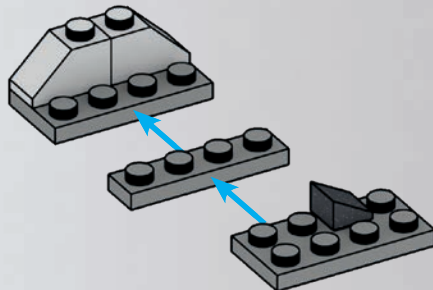
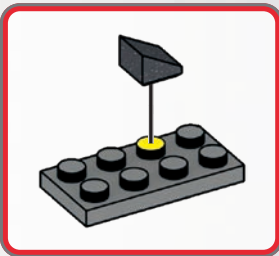

44

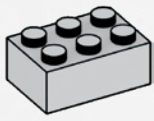

1x

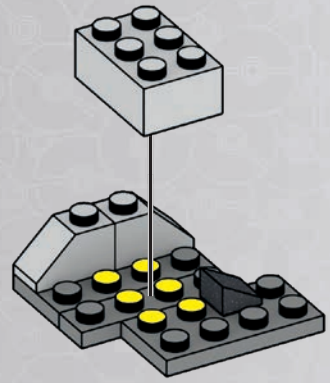

45



1x

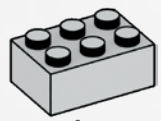

1x

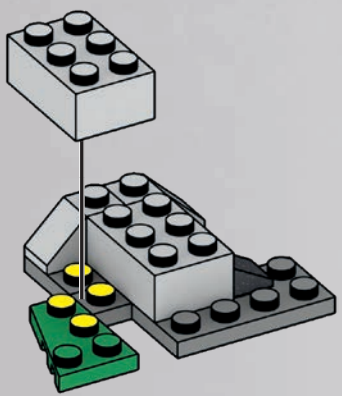

46

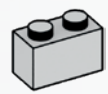

1x

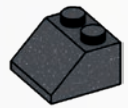

1x

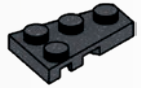

1x

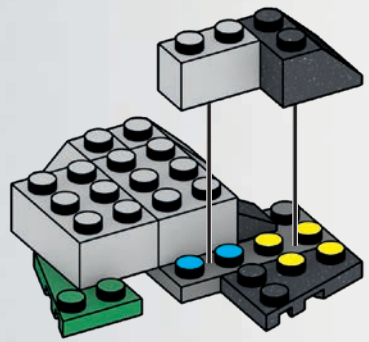

47



1x



1x

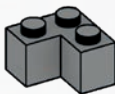

1x



1x

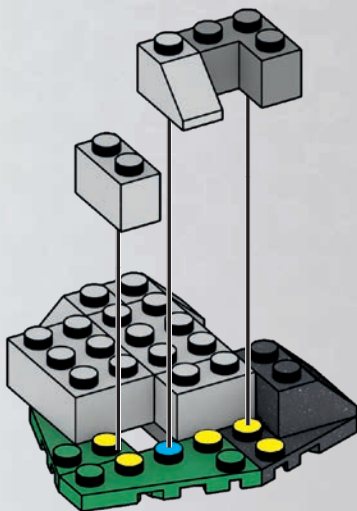

48

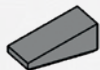

1x

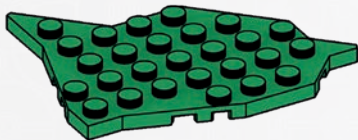

1x

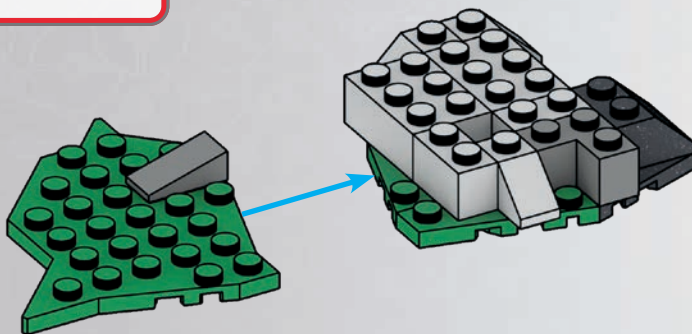
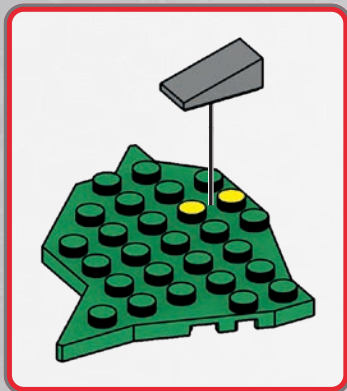

49



1x



1x

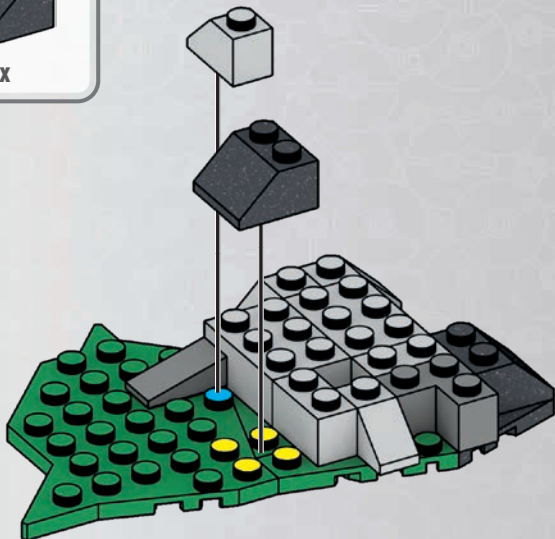

50



1x



1x

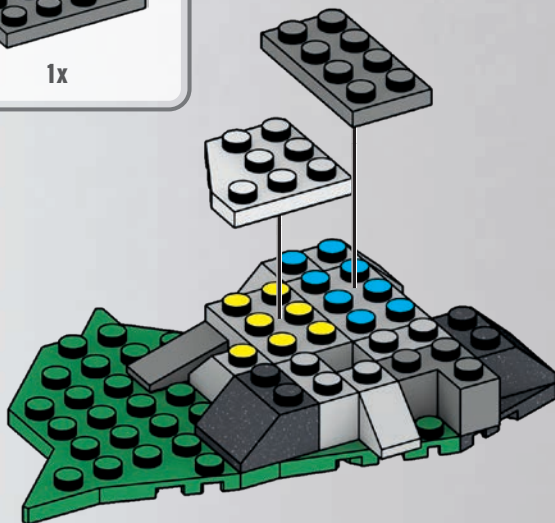

51



2x

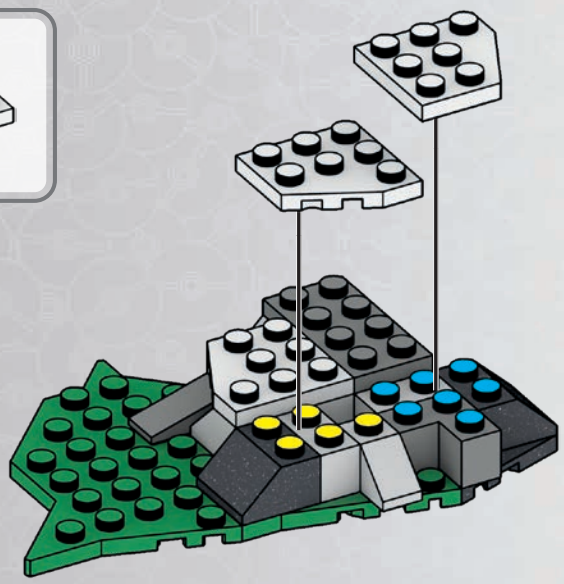

52

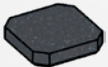

3x

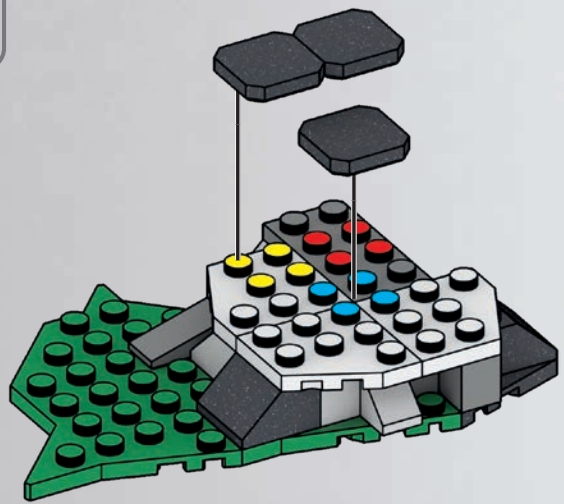

53



1x

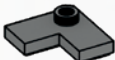

1x

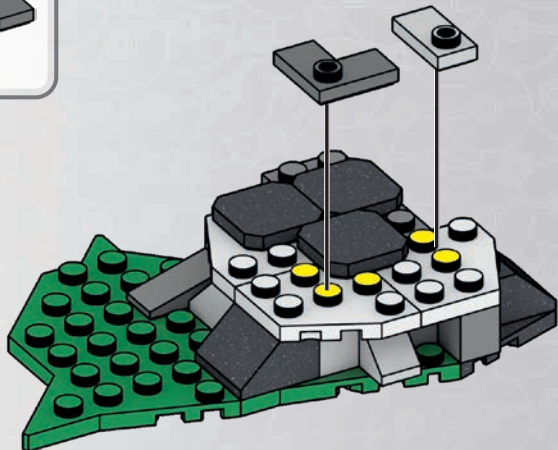

54



1x

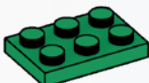

1x

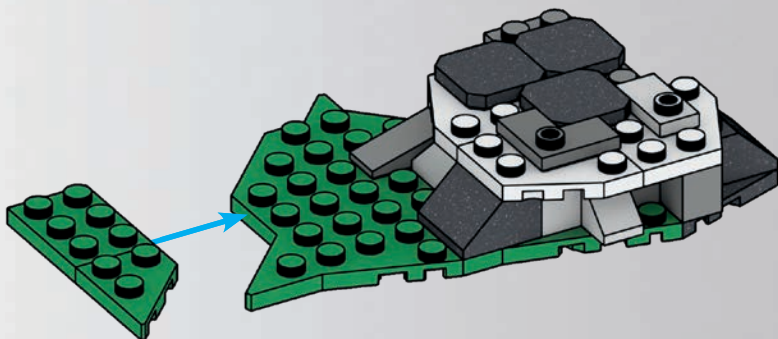

55



1x



1x

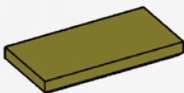

1x

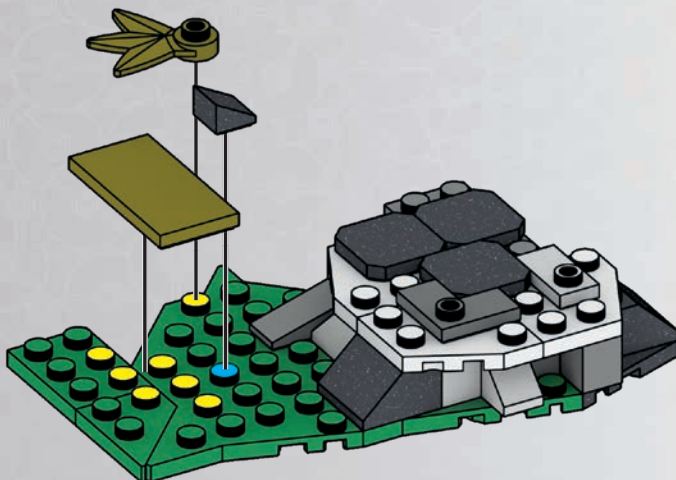

56



1x



2x

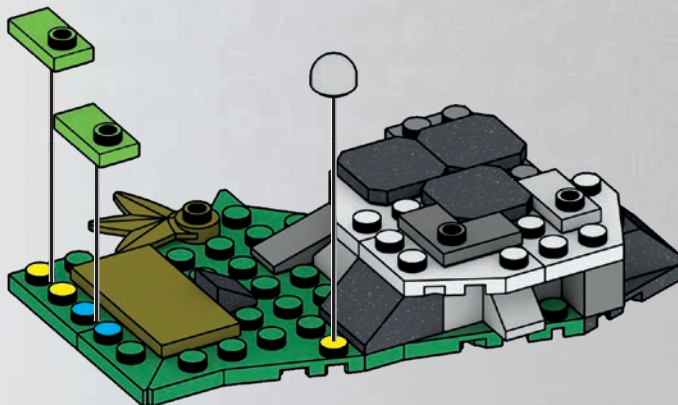

57



2x

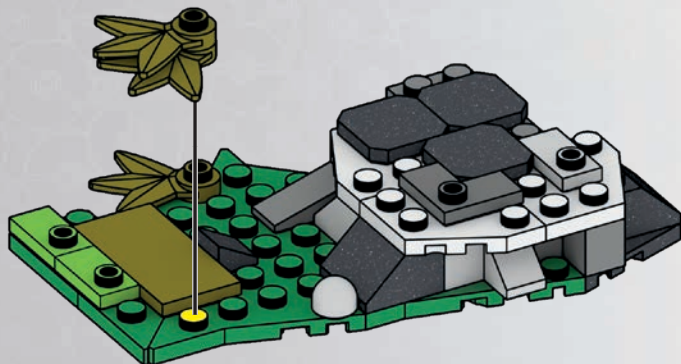

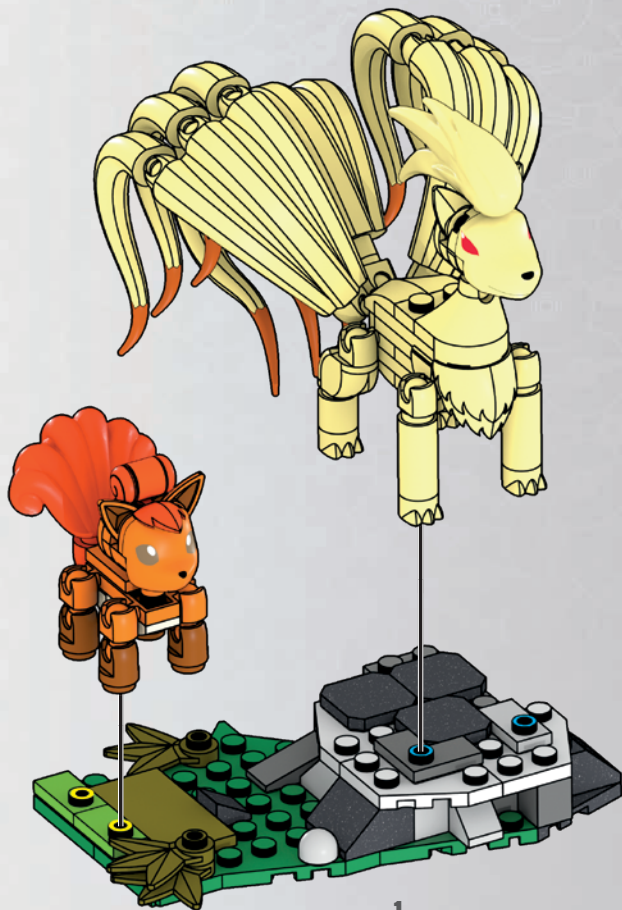

1

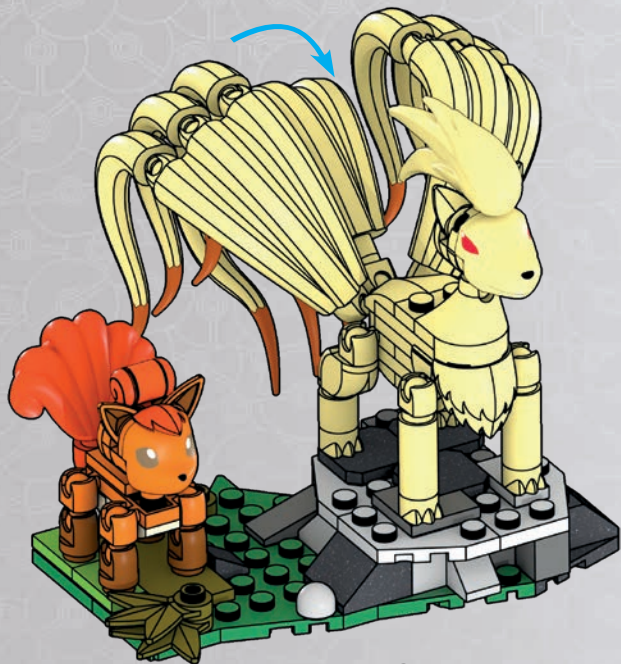

2

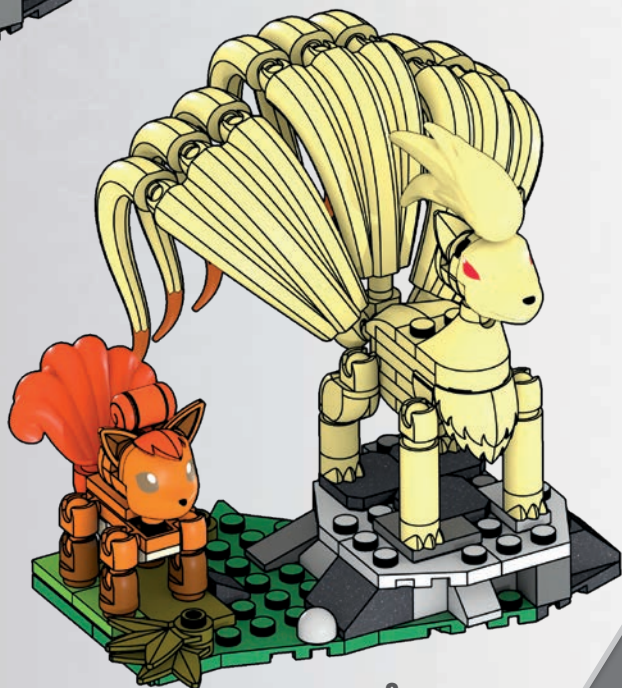

3

1x
AS-GCM73-03



1x
AS-GCM73-04



1x
AM78219BLG



2x
AM17003CS



1x
AM03328WC



2x
AM17127MM



1x
AM17127WC



1x
AM78291JU



9x
AM78291CS



4x
AM79988CS



1x
AM74397CS



1x
AM79487MCX

4x
AM78274ANM



2x
AM80144CS



4x
AM78289JU



1x
AM78296MCX



14x
AM78296CS



2x
AM80485CS



1x
AM78391CS



1x
AM022501JU



2x
AM73758HT



1x
AM73758BLG



3x
AM09393CS

2x
AS-GCM73-02



2x
AM81193CS



1x
AM80116MCX



1x
AM81994CS



1x
AM81994JU



3x
AM80011CS



1x
AM79375JU



2x
AM79375CS



2x
AM80145CS



1x
AM78285JU



1x
AM78285CS

1x
AM78486WC



3x
AM74427CS



3x
AM74426CS



1x
AM17128BDG



1x
AM78281JU



4x
AM01322BLG



2x
AM09013BLG



1x
AM74428BDG



3x
AM18543MM

1x
AS-GCM73-01



1x
AS-HTH79-01



2x
AM09129CS



3x
AM78382RL



2x
AM80143CS



2x
AM01314CS



1x
AM82081CS



2x
AM10273MM



1x
AM17153BDG

1x
AM80563CS



1x
AM17073MM



1x
AM76205BMG



1x
AM17074BMG



1x
AM03772CS



1x
AM03772BMG



1x
AM78283JU



2x
AM03873BLG



3x
AM18283BLG



1x
AM77463RL



1x
AM80117MCX



9x
AS-HTH79-02



1x
AM09593BDG



3x
AM09493BDG



1x
AM82079CS

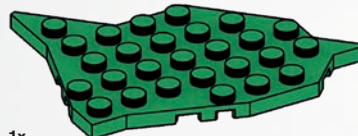

1x
AM73222BMG



1x
AM74064BMG



1x
AM82027CS



3x
AM82077CS

Missing pieces? Pièces manquantes?

¿Partes faltantes? • Perdeu peças?
Fehlen Teile? • Не хватает деталей?



support.megabrands.com

⚠ WARNING:
CHOKING HAZARD – Small parts.
Not for children under 3 years.

ATTENTION :
DANGER D'ÉTOUFFEMENT –
PETITS ÉLÉMENTS. NE
CONVIENT PAS AUX ENFANTS
DE MOINS DE 36 MOIS.

ATENÇÃO: NÃO INDICADO / NÃO RECOMENDÁVEL PARA CRIANÇAS MENORES DE 3 (TRÊS) ANOS POR CONTER PARTE(S) PEQUENA(S) QUE PODE(M) SER ENGOLIDA(S) OU ASPIRADA(S) PODENDO PROVOCAR ASFIXIA.

WARNING: Small parts, **ATTENTION:** PETITS ÉLÉMENTS, **ACHTUNG:** Kleine Teile, **AVVERTENZA:** Piccole parti, **WAARSCHUWING:** Kleine onderdelen, **ADVERTENCIA:** PELIGRO DE ATRAGANTAMIENTO. Juguete no recomendado para menores de 3 años, porque contiene piezas pequeñas que podrían provocar asfixia en caso de ser ingeridas o inhaladas por el/la niño/a, **WARNING:** Små delar, **VAROITUS:** Pieniä osia, **ADVARSEL:** Små dele, **ADVARSEL:** Små deler, **OSTRZEŻENIE:** Małe części, **UPOZORNĚNÍ:** Malé části, **UPOZORNENIE:** Malé části, **FIGYELMEZTETÉS:** Kis alkatrészek, **ПРЕДУПРЕЖДЕНИЕ:** Мелкие детали, **ΠΡΟΕΙΔΟΠΟΙΗΣΗ:** Μικρά κομμάτια, **UYARI:** Küçük parçalar.

تحذير: قطع صغيرة.
警告:
のどにつまる危険 小さな部品が含まれています 3歳以下の子供には与えないで下さい。

警告! 不适合3岁以下儿童使用。内含小零件。



Vulpix Evolution Set
Coffret Evolution Goupix
Vulpix Entwicklungssæt
Set Evoluzione di Vulpix
Vulpix Evolutieset
Conjunto Evolución de Vulpix
Conjunto de Evolução do Vulpix
Vulpix utvecklingsset
Vulpix udviklingsset
Evolucija Vulpixa Zestav
Vulpix evolúció készlet
Набор "Эволюция Vulpix"
Vulpix Evolution Set
Vulpix Evrimi Seti
مجموعة التحول Vulpix Evolution Set

Mattel Europa B.V., Gondel 1, 1186 MJ Amstelveen, Nederland. Mattel UK Limited, The Porter Building, 1Brunel Way, Slough SL1 1FQ, UK. Mattel France, Parc de la Cerisaise, 1/3/5 allée des Fleurs, 94260 Fresnes Cedex. N° Cristal 0969 36 99 99 (Número non surtaxé) ou www.lesjouetsmattel.fr Mattel Belgium N.V. De Kleentan 4, 1831 Machelen (Diegem) Belgium. Deutschland: Mattel GmbH, Solmsstraße 83, D-60486 Frankfurt am Main, Schweiz: Mattel AG, Kirchstrasse 24, CH-3097 Liebefeld, Österreich: Mattel Ges.m.b.H., Campus 21, Liebermannstraße A01 404, A-2345 Brunn/Gebrügere, Mattel Italy Srl, Via Turati 4, 20121 Milano, Italy. Servizio assistenza clienti: Customers.rv.italia@mattel.com - Numéro verde 800 11 37 11. Mattel España, S.A., Aribau 200 pl. 9, 08036 Barcelona. cservicio.spain@mattel.com Tel: +34 933 06 79 00 http://www.service.mattel.com/es. Hong Kong: Kids Kingdom Limited, Room 1908-9, Gala Place, 36 Dundas Street, Mongkok, Kowloon, Hong Kong. Customer Care line: (852)2782-0766. Taiwan: Chickibiddy Company Limited, 5/F, No. 186, Section 4, Nanjing East Road, Taipei 10595, Taiwan. Customer Care line: (02)2578-1188. Mainland China: Mattel Barbie (Shanghai) Trading Co., Ltd. Units 4701-4711, 47F, 2 Grand Gateway, 3 Hong Qiao Road, Shanghai, 200030, P.R.C. Customer Care line: 400-819-9658. Dimport & Diederkan Oleh: Mattel Continental Asia Sdn Bhd. Level 19, Tower 3, Avenue 7, No. 8 Jalan Kerinci, Bangsar South, 59200 Kuala Lumpur, Malaysia. Mattel South Africa (PTY) LTD, Office 102 B, 30 Melrose Boulevard, Johannesburg 2196. Distributor: Mattel Poland Sp. z o.o., Budynek Skyliner 31 p., ul. Prosta 67, 00-838 Warszawa, Polska. Mattel Australia Pty. Ltd., 658 Church St., Richmond, Victoria, 3121. Consumer Advisory Service - 1300 133 312. Mattel AEBE, Εθνάρχου Μακρίδου 1, Κτήριον Κ-2, ΤΚ 17561, Πόλεως Θάμπος, Mattel Oyuncakçılık Tic. Ltd. Şti. İzerenköy Mah. Umut Sokak No: 10 - 12, Quick Tower kat:3 içkapı no:15 Ataşehir 34752, İstanbul, Türkiye. Tel: 0216 570 75 00. Импортёр/полномоченная организация: ООО "МАТТЕЛ" Российская Федерация, 105120 Москва, 2-й Сыромятнинский переулок, 1; +7 495 287 79 39. Mattel Czech Republic s.r.o., The Forum, Václavské nám. 19, 11000 Praha 1. Mattel 333 Continental Boulevard, El Segundo, CA 90245, USA. Consumer Services: 1-800-465-MEGA (6342). Mattel Canada Inc., Mississauga, Ontario L5R 3W2. Consumer Services: You may call us free at/ Composés sans frais le 1-800-524-8697. Importado y distribuido por Mattel de México, S.A. de CV, Miguel de Cervantes Saavedra No. 193, Pisos 10 y 11, Col. Granada, Alcaldía Miguel Hidalgo, C.P. 11520, México. Ciudad de México. R.F.C. MME-920701-NB3. Tel: 59-05-31-00 Ext. 5206 ó 01-800-463-59-89. Mattel Chile S.A. Pte. Risco 5561, Of. 203-204 P52, Las Condes, Santiago. Servicio al consumidor/Venezuela: Tel: 0-800-100-9123. Mattel Argentina, S.A., Av. Libertador 1000, Piso 7, Oficinas 109 y 111, Vicente López - Prov. Buenos Aires. Tel: 0800-666-3373. Mattel Colombia, S.A., Calle 12347-07 P5, Bogotá. Mattel Peru, S.A., Av. Juan de la Virgen de Luján 151, Centro Empresarial Juan de Arona, Torre C, Piso 7, Oficina 704, San Isidro, Lima 27, Perú. RUC: 20425853865. Reg. Importador: 02350-12-JUE-DIGESA. Tel: 0800-54744. E-mail Latinoamérica: servicio.clientes@mattel.com. Mattel do Brasil Ltda. - CNPJ: 54.558.002/0001-20 - Rua Verbo Divino, 1488 - 2º - Andar - 04719-904 - Chácara Santo Antônio - São Paulo - SP - Brasil. Serviço de Atendimento ao Consumidor: Contato: https://faleconosco.mattel.com.br/Contato. E-mail: sac.matteldobrazil@mattel.com.

©2023 Pokémon. ©1995-2023 Nintendo / Creatures Inc. / GAME FREAK inc. TM, ®, and character names are trademarks of Nintendo.

©2023 Pokémon. ©1995-2023 Nintendo/Creatures Inc./GAME FREAK inc. TM, ® et les noms des personnages sont des marques de Nintendo.



POKÉMON



HHM17



HNT95



HKT23

MEGAUNBOXED.COM

Set(s) sold separately and subject to availability. / Ensemble(s) vendu(s) séparément. Certains produits peuvent ne pas être commercialisés. Se vende(n) por separado y está(n) sujeto(s) a disponibilidad. / Conjunto(s) vendido(s) em separado e sujeito(s) à disponibilidade. / Set in vendita separatamente, secondo disponibilità. / Das/Die Set(s) sind separat erhältlich. / Zestaw(y) sprzedawany(e) oddzielnie w zależności od dostępności. / Set(s) apart verkrijgbaar en afhankelijk van beschikbaarheid. / Набор(-ы) продаются отдельно, при наличии. / Sæt sælges separat og så længe lager haves. / Seten säljs separat så länge lagret räcker. / Settet/settene selges separat så langt lageret rekker. / Pakkaus/pakkaukset myydään erikseen, saatavuus voi vaihdella. / Το(α) σετ πωλούνται ξεχωριστά και ανάλογα με τη διαθεσιμότητα. Setler ayrı olarak satılır ve stoklarla sınırlıdır. / Set (sety) se prodává (prodávají) samostatně dle aktuální nabídky. / Σύπρα-/y sa predáva(jú) samostatne a podľa dostupnosti. A készlet(ek) külön kapható(k), az elérhetőség változhat. / セット商品は別売りになります。在庫状況は別途ご確認お願いします。

شباع المجموعة أو المجموعات على حدة وتخضع لتوافرها.
每套单独发售，按供货情况决定。

™ & ©2023 Mattel.

©2023 MEGA Brands & ™ MEGA Brands.
Printed in China / Imprimé en Chine

AD-HTH79-01A



FR



Ⓟ D799,607, D834,104,
D857,115, D834,105

1186 MJ, 1, NL

Mattel Canada Inc. Mississauga, Ontario L5R 3W2.
MADE IN CHINA. FABRIQUÉ EN CHINE. FABRICADO NA CHINA. HECHO EN CHINA.
ИЗГОТОВЛЕНО В КИТАЕ. ЧИՆԻՉԵ ԿՐԵՒԼՄԻՏՏԻՐ. صنع في الصين.



FR

DONNEZ
OU
RECYCLEZ



ASSOCIATION



MAGASIN



DÉCHÈTERIE

Adresses sur quefairemesdechets.fr

MATTEL

Empowering the
next generation
through play.™

Inspirer les futures générations par le jeu.

