

MEGA™

HotWheels

BUILDING SETS

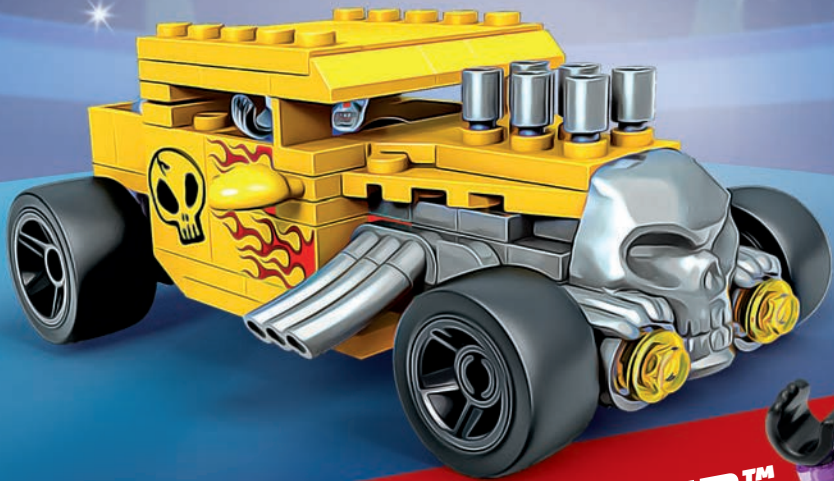

HDJ89

BONE SHAKER™
CLASSICS · CLASSIQUES · CLÁSICOS



MEGA
UNBOXED

Build Construisez

Construye | Constrói
Bauen | Стройте



Share | Partagez

Comparte | Partilha
Teilen | Делитесь

Devices not included | Appareils non inclus | Dispositivos não incluídos | Dispositivos não incluídos | Geräte nicht enthalten | Устройства не входят в комплект

Get creative! Soyez créatif!

¡Sé creativo!
seja criativo!
werde kreativ!
проявите
творческий подход!

Build ideas may use pieces from multiple sets (sold separately). / Les idées de construction peuvent nécessiter des pièces issues de différents coffrets (vendus séparément). / Las ideas de construcción pueden utilizar piezas de varios conjuntos (se venden por separado). / As ideias de construção podem utilizar peças de vários conjuntos (vendidas em separado). / Für Bauiddeen sind möglicherweise Teile von mehreren Sets nötig (separat erhältlich). / В идеях конструкций могут быть использованы детали из разных наборов (продаются отдельно).

unboxed.megaconstrux.com



1



1



2

2

1x



1x

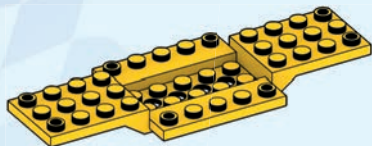

1x

3

2x

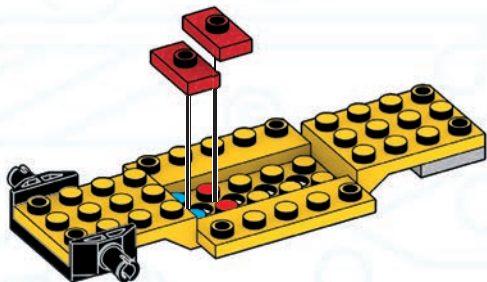
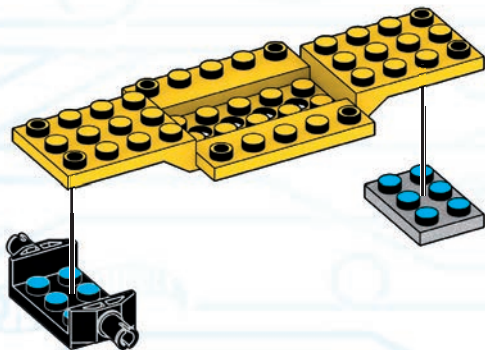



BONE SHAKER™

4



2x



2x

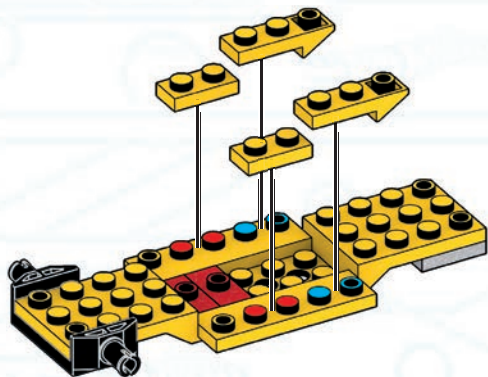

5



1x



1x

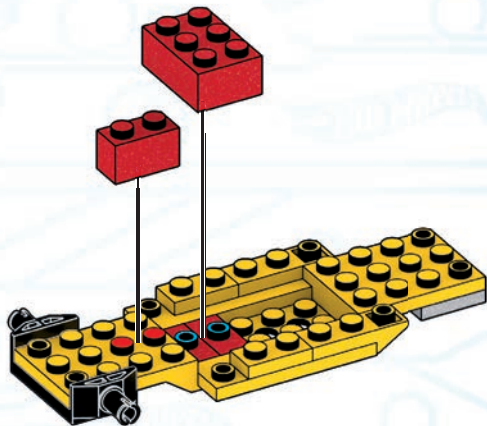

6

2x



1x

7

2x

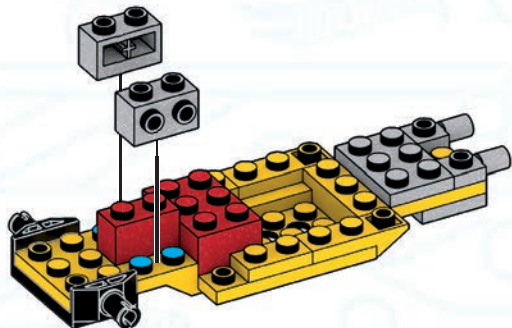
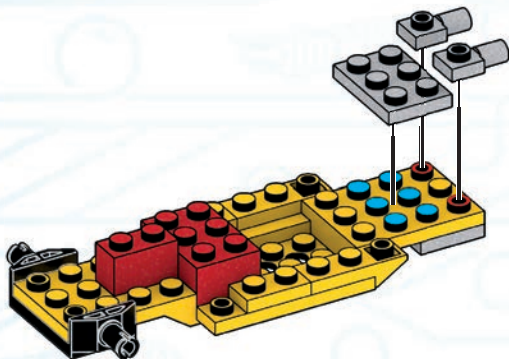



BONE SHAKER™

8



3x

9



2x

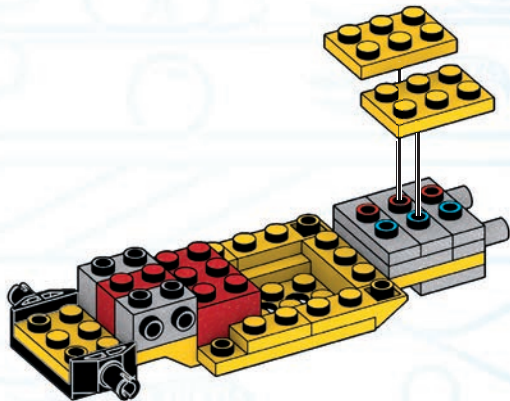
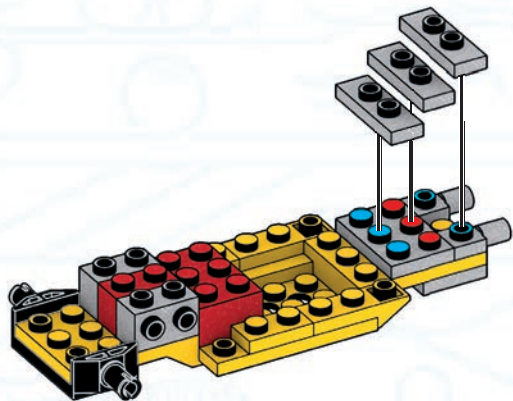

10



1x



1x

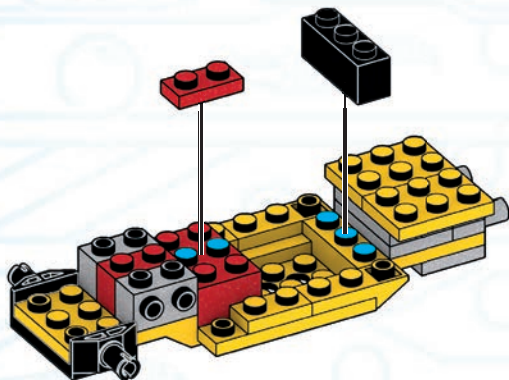

11



1x



1x

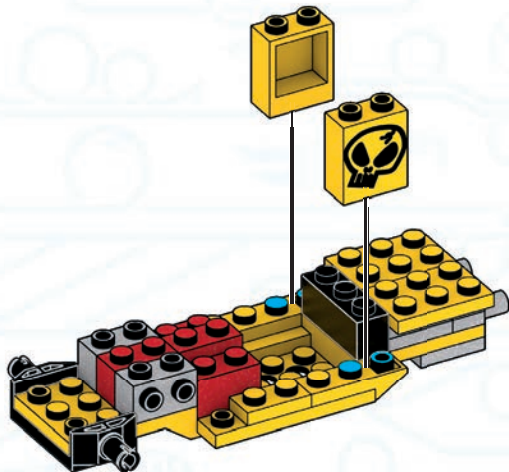



BONE SHAKER™

12



2x

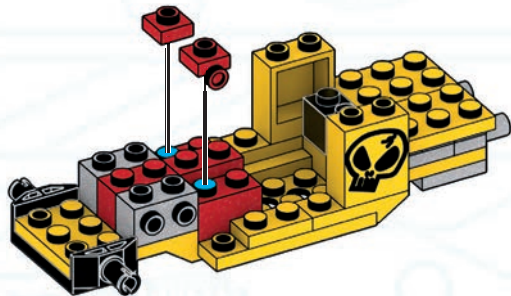

13



2x

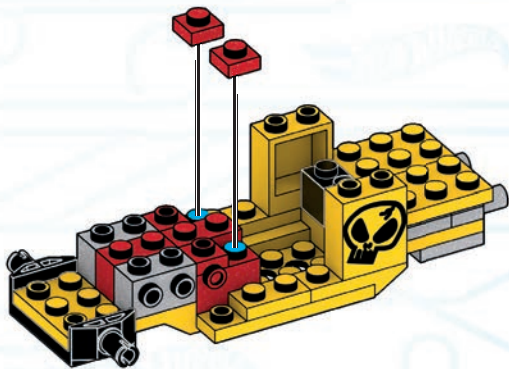

14



1x



1x

15



2x

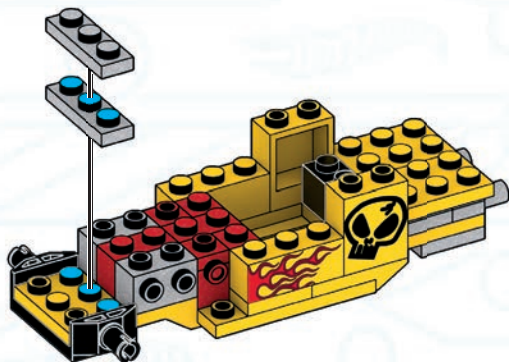
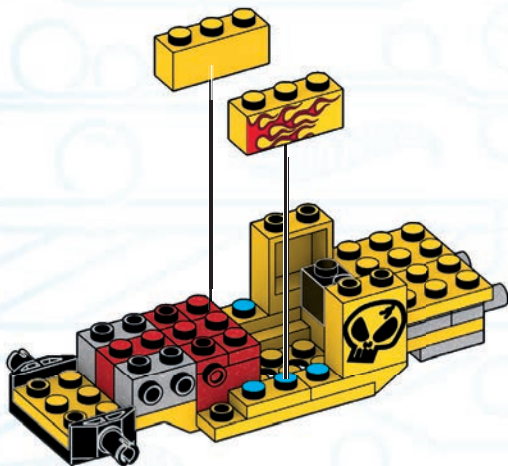



BONE SHAKER™

16



1x

17



1x



1x

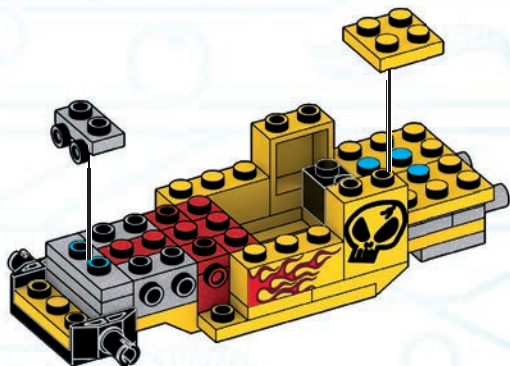
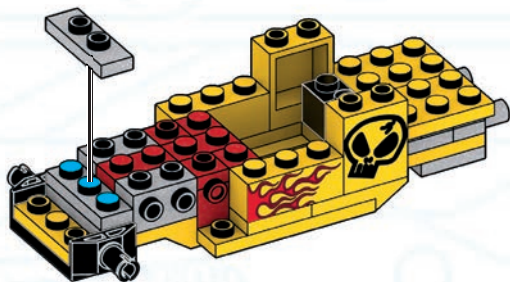

18



1x



1x

19



1x

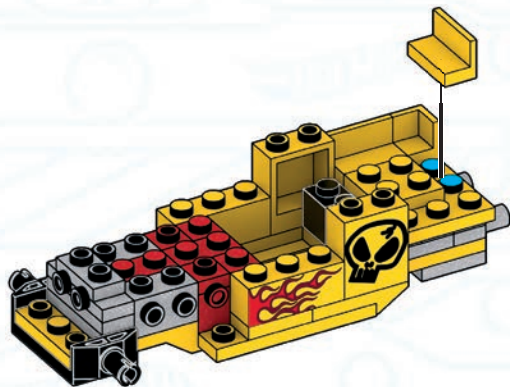
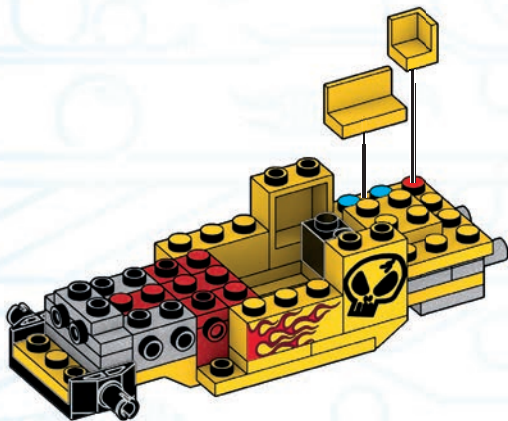



BONE SHAKER™

20



1x



1x

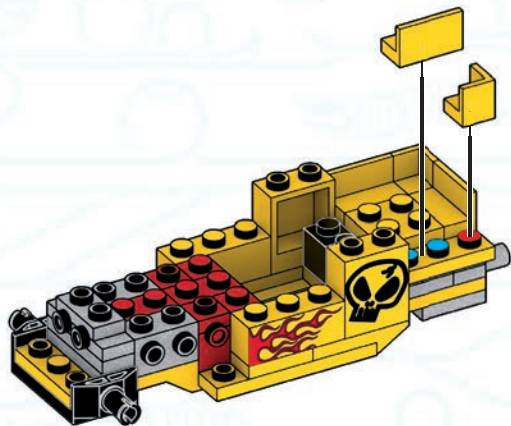

21



1x

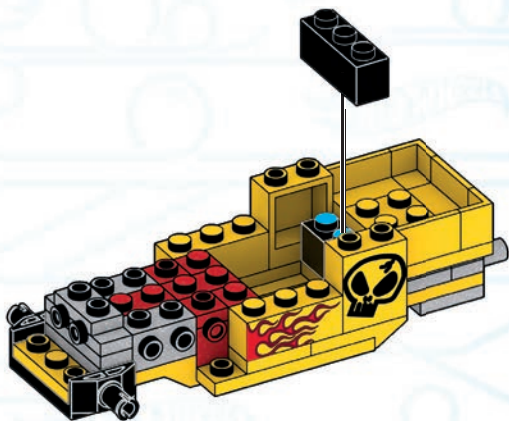

22

1x

23

1x



1x

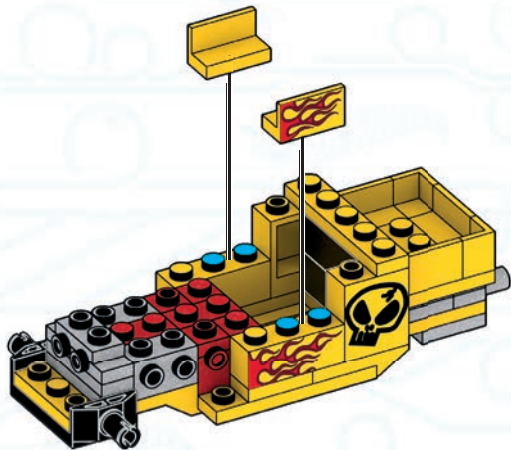
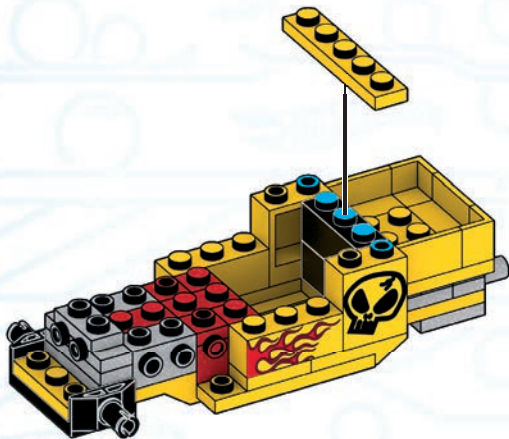



BONE SHAKER™

24



1x



1x

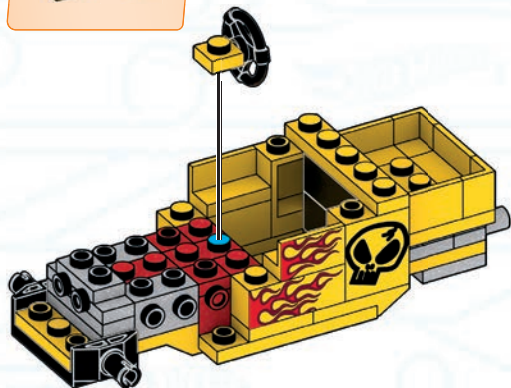

25



2x

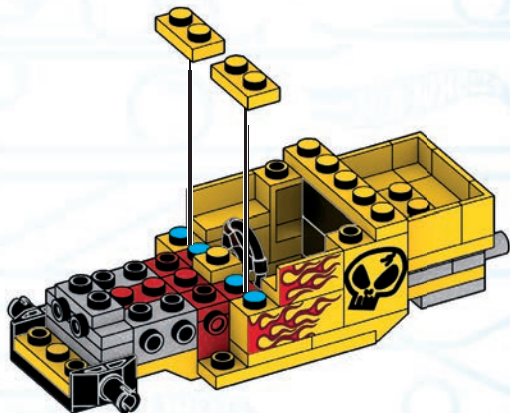

26



3x

27



1x



1x

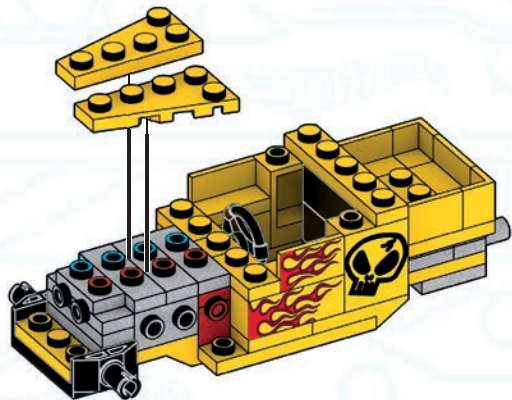
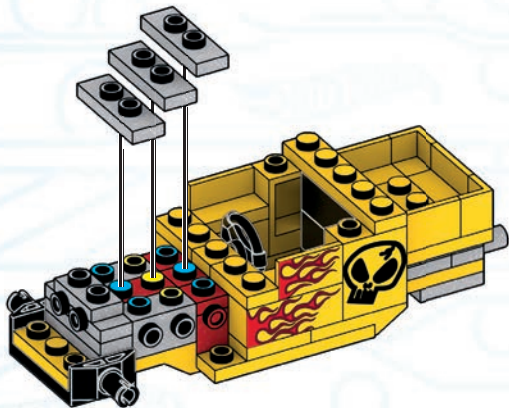



BONE SHAKER™

28



1x

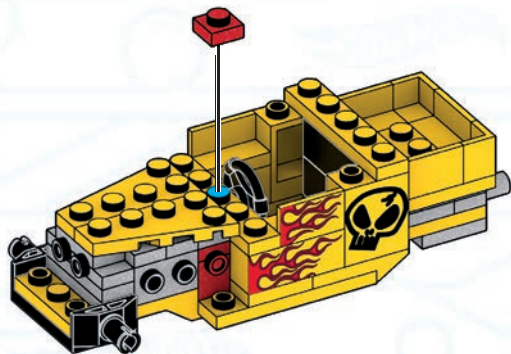

29



1x



1x

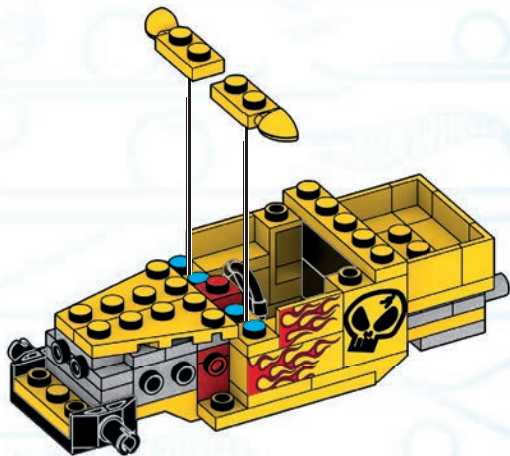

30

1x

31

1x



1x

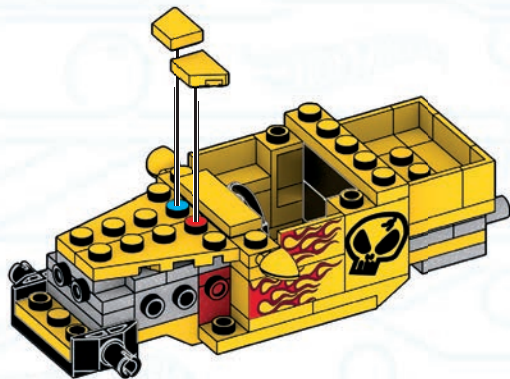
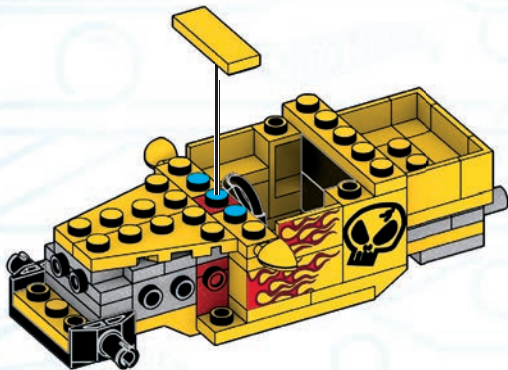



BONE SHAKER™

32



2x

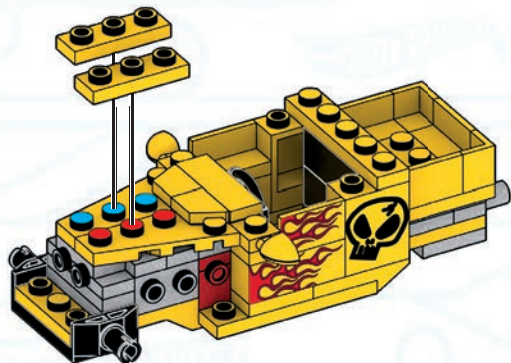

33



2x

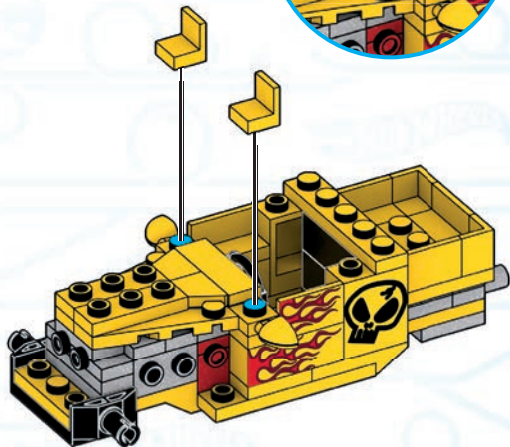
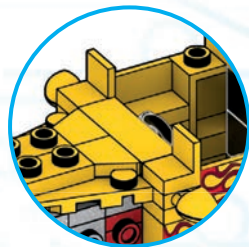

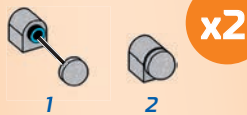
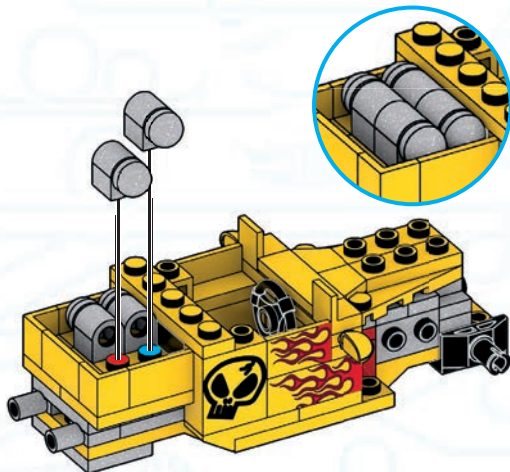
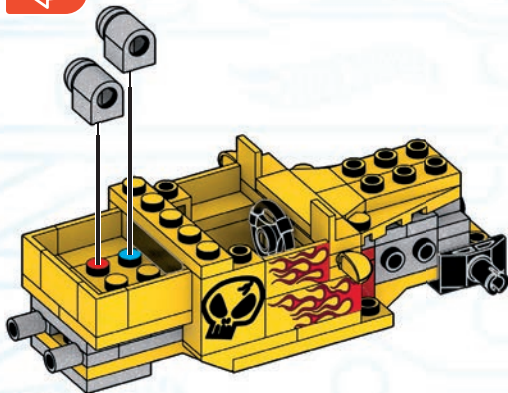
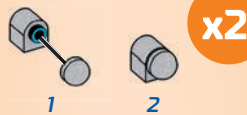
34**35**



BONE SHAKER™

36



6x

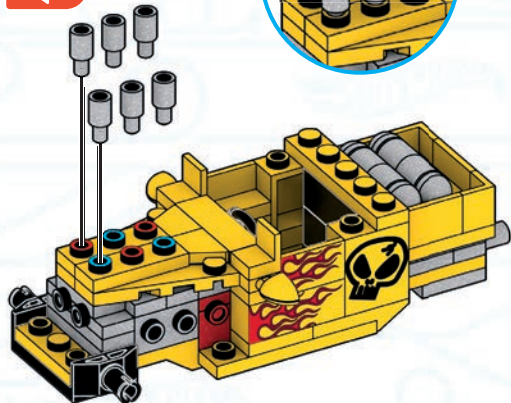

37



2x



2x



1



2

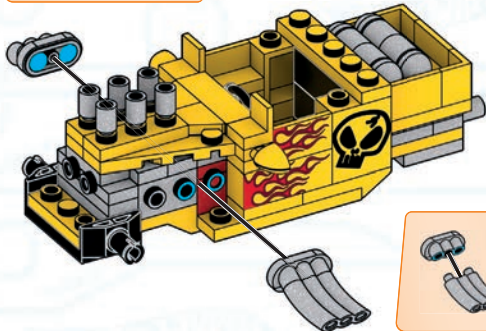

38



2x

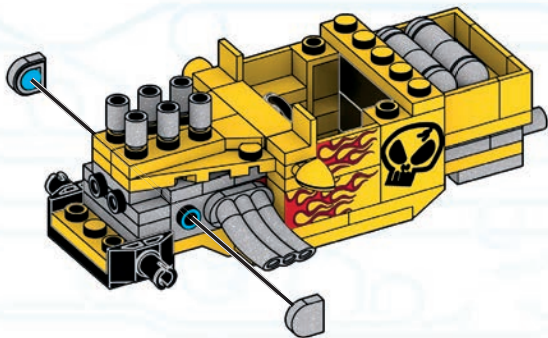

39



1x

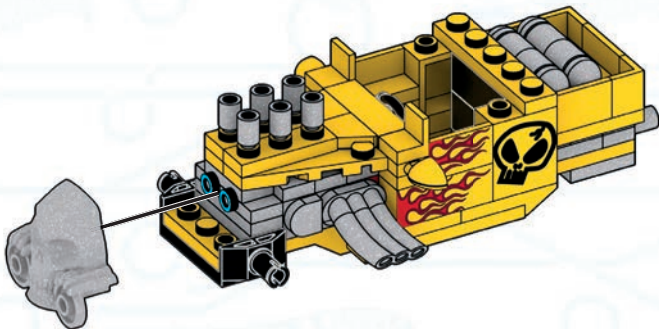



BONE SHAKER™

40



2x

41



2x

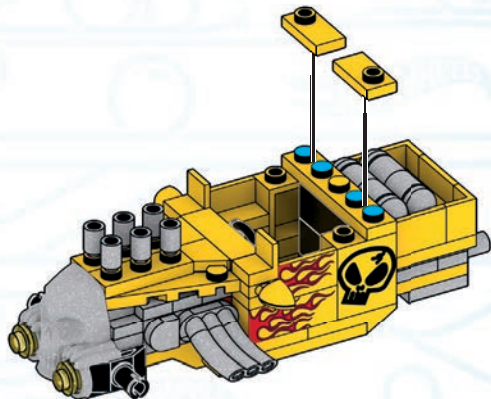
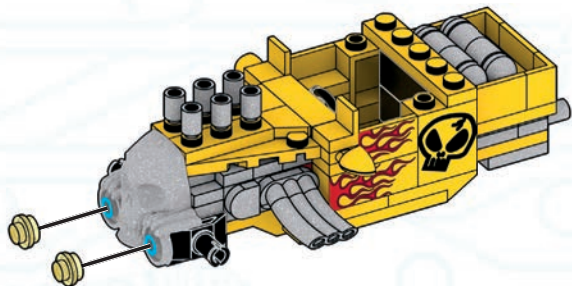

42

2x

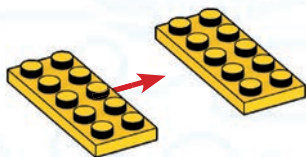
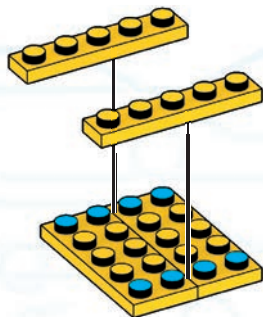

2x

**1****2****43**

1x

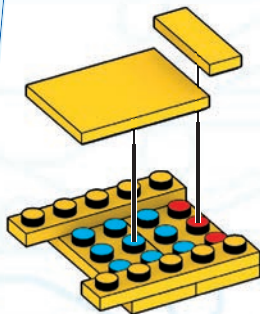

1x

**44**

2x

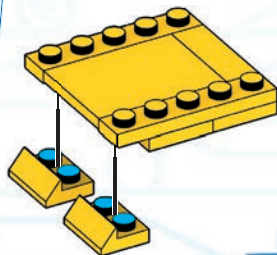



BONE SHAKER™

45



1x

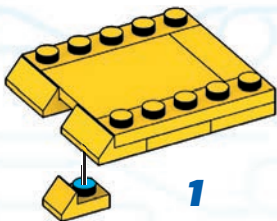

1

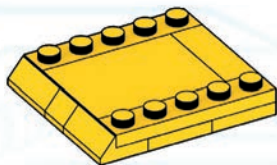

2

46

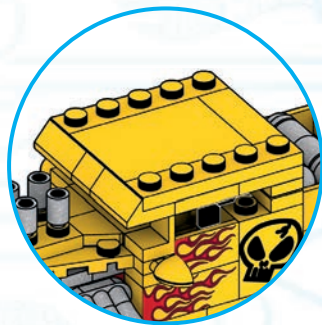
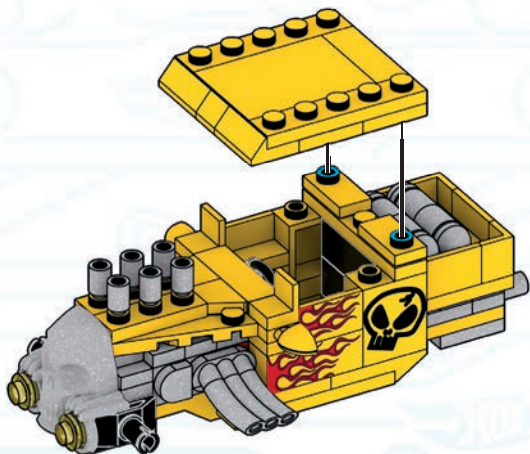

47

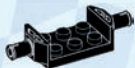

1x

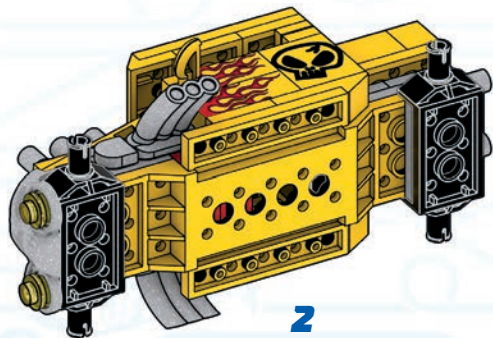
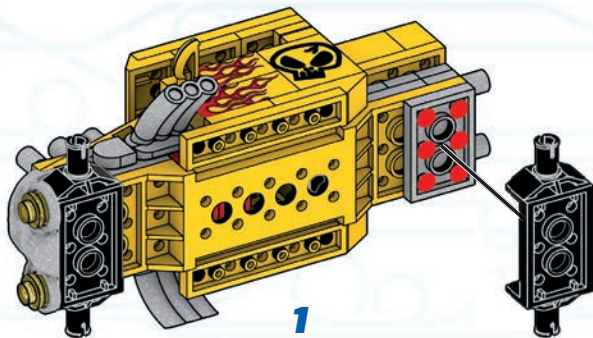



BONE SHAKER™

48



2x



2x

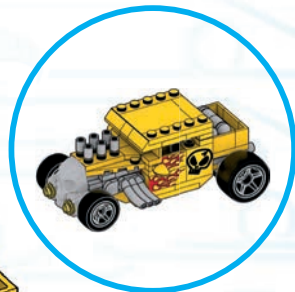
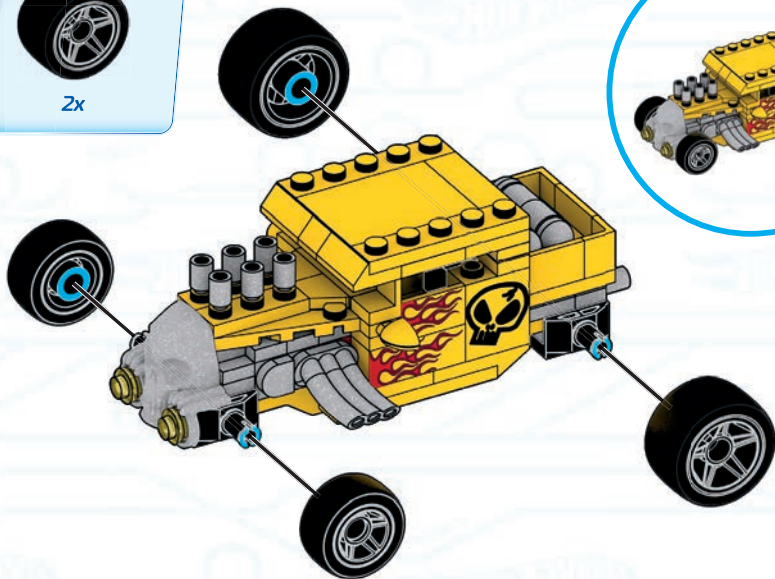

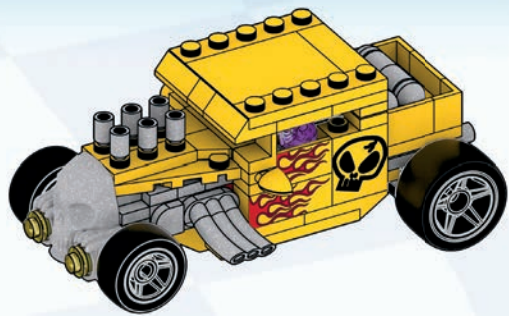
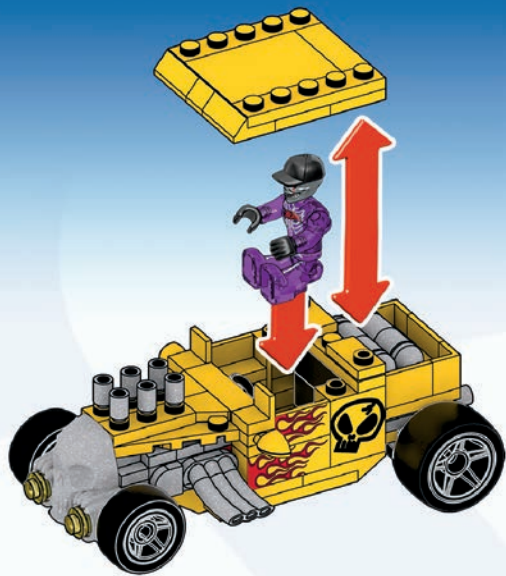

MIX & MATCH! COMBINE-LES!

MEZCLA Y COMBINA! • MISTURA E COMBINA!
ZUM KOMBINIEREN! • СОЧЕТАЙ И ПОДБИРАЙ!



HDJ90*

BONE SHAKER™



HDJ89*

TWIN MILL™



HDJ90*

HW40™



GYG32*

RODGER DODGER™



GYG33*

RODER DODGER™



GYG22*

MEGA WREX™



HDJ95*

TIGER SHARK™



GVM26*

RALLY CAT™



GVM13*

MOD ROD™



GVM13*

TWINDUCTION™



GYG66*

BONE SHAKER™



GVM27*

DAWGZILLA™



GVM13*

NIGHT SHIFTER™



GVM13*

BAJA TRUCK



GYG34*

ARISTO RAT™



GYG35*

AMAZOOM™



GYG36*

RIP ROD™



GYG37*



* HDJ89 / HDJ90 / GYG32 / GYG33 / GYG22 / HDJ95 / GVM26 / GVM27 / GVM13 / GYG66 / GYG34 / GYG35 / GYG36 / GYG37 / HDJ93 / HDJ94

Set(s) sold separately and subject to availability. / Ensemble(s) vendu(s) séparément. Certains produits peuvent ne pas être commercialisés. / Se vende(n) por separado y está(n) sujeto(s) a disponibilidad. / Conjunto(s) vendido(s) em separado e sujeito(s) à disponibilidade. / Set in vendita separatamente, secondo disponibilità. / Das/Die Set(s) sind separat erhältlich. / Zestaw(y) sprzedawany(e) oddzielnie w zależności od dostępności. / Set(s) apart verkrijgbaar en afhankelijk van beschikbaarheid. / Набор(-ы) продается(ются) отдельно, при наличии. / Set sælges separat og så længe lager haves. / Seten säljs separat så länge lagret räcker. / Set(s)/settene selges separat så langt lagret rekker. / Pakkaus/pakkaukset myydään erikseen, saatavuus voi vaihdella. / Το(α) σετ πωλούνται ξεχωριστά και ανάλογα με τη διαθεσιμότητα. / Setler ayrı olarak satılır ve stoklarla sınırlıdır. / Set (sety) se prodává (prodávají) samostatně dle aktuální nabídky. / Súprava/-y sa predáva(jú) samostatne a podľa dostupnosti. / A készlet(ek) külön kapható(k), az elérhetőség változhat. /

セツト商品は別売りになります。在庫状況は別途ご確認をお願いします。 / 每套单独发售，按供货情况决定。 /
تباع المجموعة أو المجموعات على حدة وتخضع لتوافرها.

Additional purchase required. / Achat additionnel requis. / Zusätzlicher Kauf erforderlich. / Richiede acquisto addizionale. / Aanvullende aankoop vereist. / Requiere compra adicional. / Requer compra adicional. / Ytterligere kjøp kreves. / Edellyttää lisäosien ostamista. / Supplerende køb nødvendig. / Ekstra kjøp kreves. / Wymagany dodatkowy zakup. / Vyžaduje dodatečný nákup. / Vyžaduje sa dokúpenie. / További vásárlás szükséges. / Необходима дополнительная покупка. / Αναγκαίται επιπλέον αγορά. / Ek ürünü satın alınması gerekir. / تتطلب شراء القطع الإضافية.

REBUILD YOUR CARS INTO MONSTER TRUCKS! RÉASSEMBLE TES VOITURES POUR EN FAIRE DES MONSTER TRUCKS!

CONVIERTE TUS COCHES EN "MONSTER TRUCKS!" · TRANSFORMA OS SEUS CARROS EM MONSTER TRUCKS!
FAHRZEUGE IN MONSTER TRUCKS UMBAUEN! · ПЕРЕСТРАИВАЙ СВОИ МАШИНКИ В МОИСТР-ТРАКИ!



HDJ95*

RACE ACE™



HDJ93*

GUNKSTER™



HDJ94*

RACER™



GYG22*

MEGA WREX™



HDJ95*

TIGER SHARK™



GVM26*

BONE SHAKER™



GVM27*

RODGER DODGER™



GYG22*



1



2



3

Most models can be built one at a time. / La plupart des modèles peuvent être construits un à la fois. / La mayoría de modelos se pueden construir de uno en uno. / A maioria dos modelos pode ser construída separadamente. / La maggior parte dei modelli possono essere realizzati uno per volta. / Die meisten Modelle können eines nach dem anderen gebaut werden. / Większość modeli nie da się budować jednocześnie z innymi. / De meeste modellen kunnen één voor één gebouwd worden. / Большинство моделей могут быть собраны по одной за раз. / De fleste modeller kan bygges en i taget. / De fleste modellene kan bygges en om gangen. / seimmat mallit voidaan rakentaa yksi kerrallaan. / Τα περισσότερα μοντέλα μπορούν να κατασκευασθούν ένα ένα. / Modellerein çoğu ayrı ayrı inşa edilmeyi gerektirebilir. / Většinou lze najednou sestavit pouze jeden model. / Väčšina modelov môže byť zostavená iba raz. / A modellek többségéből egyszerre csak egy építhető.

ほとんどのモデルは、一度に一つを組み立てることができます。

يمكن تركيب التصميم الواحد تلو الآخر.

大多數型號可一次性建構。

2x
AM01113ZD



6x
AM74397APG



4x
AM78219APG



2x
AM76204APG



3x
AM03328AXW



2x
AM77574AXW



1x
AM80546BYE



2x
AM76058APG



1x
AM19530BYE



2x
AM15485BYE



2x
AM76959BYE



1x
AM74299BYE



1x
AM74300BYE



4x
AM76767APG



2x
AM73758BYE



2x
AM07590AXW



4x
AM09393BYE



1x
AM09393AXW



1x
AM76467APG



1x
AS-HDJ89-02



1x
AS-HDJ89-01



3x
AM07228BYE



2x
AM09835BYE



1x
AM81383F



2x
AM76469APG



1x
AM81381BYE



1x
AM81382BYE



1x
AM03773BYE



2x
AM80966BYE



7x
AM74298APG



2x
AM72600BYE



2x
AM01314APG



2x
AM19326BYE



2x
AM03772BYE



2x
AM03772APG



2x
AM81338APG



1x
AM09013AXW



2x
AM17502APG



2x
AM16384F



1x
AS-HDJ89-07



1x
AS-HDJ89-05



1x
AS-HDJ89-03



1x
AS-HDJ89-04



1x
AM03873AXW



1x
AM72025BYE



3x
AM07475BYE



2x
AM80965BYE



1x
AM74064BYE



1x
AM74065BYE



1x
AM80974APG

2x
AS-HDJ89-06



2x
AM80971F



2x
AS-HDJ89-08



1x
AM80975BYE



1x
FIG-HDJ89-A



**Missing pieces?
Pièces manquantes?**

¿Partes faltantes? • Perdeu peças?
Fehlen Teile? • Не хватает деталей?

support.megabrand.com

Mattel Europa B.V., Gondel 1, 1186 MJ Amstelveen, Nederland. Mattel U.K. Limited, The Porter Building, 1 Brunel Way, Slough SL1 1FQ, UK. Mattel France, Parc de la Cerisaie, 1/3/5 allée des Fleurs, 94260 Fresnes Cedex. N° Cristal 0969 36 99 99 (Numéro non surtaxé) ou www.lesjouetsmattel.fr Mattel Belgium, Trade Mart, Atomiumsquare, Bogota 202 – B 275, 1020 Brussels. Gratis nummer België: 0800 – 16 936 - Gratis nummer Luxemburg: 800 - 22 784 -Gratis nummer Nederland: 0800 - 262 88 35. Deutschland : Mattel GmbH, Solmsstraße 4, D-60486 Frankfurt am Main. Schweiz: Mattel AG, Kirchstrasse 24, CH-3097 Liebefeld. Österreich: Mattel Ges.m.b.H., Campus 21, Liebermannstraße A01 404, A- 2345 Brunn/Gebirge. Mattel Italy Srl, Via Bracco, 6-MAC 6, 20159 Milano, Italy. Servizio assistenza clienti: Customersrv.italia@mattel.com - Numero verde 800 11 37 11. Mattel España, S.A., Aribau 200. 08036 Barcelona. c.service.spain@mattel.com Tel: 900 102 390 http://www.service.mattel.com/es. Mattel East Asia Ltd., Room 503-09, North Tower, World Finance Centre, Harbour City, Tsimshatsui, HK, China. Tel.: (852) 3185-6500. Diimport & Diedarkan Oleh: Mattel Continental Asia Sdn Bhd. Level 19, Tower 3, Avenue 7, No. 8 Jalan Kerinchi, Bangsar South, 59200 Kuala Lumpur, Malaysia. Mattel South Africa (PTY) LTD, Office 102 I3, 30 Melrose Boulevard, Johannesburg 2196. Dystributor: Mattel Poland Sp. z o.o., Warsaw Trade Tower 34 p., ul. Chłodna 51, 00-867 Warszawa. Mattel Australia Pty. Ltd. 658 Church St., Richmond, Victoria, 3121. Consumer Advisory Service - 1300 135 312. Mattel AEBE, Εθνάρχου Μακαρίου 1, Κτήριο Κ-2, ΤΚ 17561, Παλιό Φάληρο. Mattel Ouncacılık Tic. Ltd. Şti. İçerenköy Mah., Erkut Sok. A Blok No:12 Üner Plaza Kat:9-10 34752 Ataşehir İstanbul. Tel: 0216 570 75 00. Импортёр/ Уполномоченная организация: ООО "МАТТЕЛ" Российская Федерация, 105120 Москва, 2-й Сыромятнический переулок, 1; +7 495 287 79 39. Mattel Czech Republic s.r.o., The Forum, Václavské nám. 19, 11000 Praha1. Mattel, 333 Continental Boulevard, El Segundo, CA 90245, USA. Mattel Canada Inc., Mississauga, Ontario L5R 3W2. Consumer Services: You may call us free at/ Composez sans frais le 1-800-524-8697. Importado y distribuido por Mattel de México, S.A. de C.V., Miguel de Cervantes Saavedra No. 193, Pisos 10 y 11, Col. Granada, Alcaldía Miguel Hidalgo, C.P. 11520, México, Ciudad de México. R.F.C. MME-920701-NB3. Tels.: 59-05-51-00 Ext. 5206 ó 01-800-463-59-89. Mattel Chile, S.A., Avenida América Vespuccio 501-B, Quilicura, Santiago. Tel: 1230-020-6213. Servicio al consumidor Venezuela: Tel: 0-800-100-9123. Mattel Argentina, S.A., Av. Libertador 1000, Piso 11 – Oficinas 109 y 111, Vicente López – Prov. Buenos Aires. Tel.: 0800-666-3373. Mattel Colombia, S.A., Calle 123#7-07 P5, Bogotá. Tel: 01800-710-2069. Mattel Perú, S.A., Av. Juan de Arona # 151, Centro Empresarial Juan de Arona, Torre C, Piso 7, Oficina 704, San Isidro, Lima 27, Perú. RUC: 20425853865. Reg. Importador: 02350-12-JUE-DIGESA. Tel.: 0800-54744. E-mail Latinoamérica: servicio.clientes@mattel.com. Mattel do Brasil Ltda.- CNPJ : 54.558.002/0001-20 - Rua Verbo Divino, 1488 - 2º. Andar - 04719-904 - Chácara Santo Antônio - São Paulo - SP - Brasil. Serviço de Atendimento ao Consumidor: fone 0800 575 0780. E-mail: sac.matteldobrazil@mattel.com

⚠ WARNING:
CHOKING HAZARD. - Small parts.
Not for children under 3 years.

⚠ ATTENTION:
DANGER D'ÉTOUFFEMENT. - Présence de petits éléments.
Ne convient pas aux enfants de moins de 3 ans.

⚠ 警告:
のどにつまる危険 小さな部品が含まれています
3歳以下の子供には与えないで下さい。

⚠ تحذير:
غير مناسبة للأطفال دون 36 شهراً - قطع صغيرة.

⚠ **警告!**
不适合3岁以下儿童使用。
内含小零件。

ADVERTENCIA: PELIGRO DE ATAGANTAMIENTO. Juguete no recomendado para menores de 3 años, porque contiene piezas pequeñas que podrían provocar asfixia en caso de ser ingeridas o inhaladas por el/ la niño/a.

ATENÇÃO! Não indicado / não recomendável para crianças menores de 3 (três) anos por conter parte(s) pequena(s) que pode(m) ser engolid(a)s ou aspirada(s) podendo provocar asfixia.

AVVERTENZA: Contiene pezzi di piccole dimensioni.

ACHTUNG: Kleine Teile.

OSTRZEŻENIE: Małe części. Niebezpieczeństwo zadławienia.

WAARSCHUWING: Kleine onderdelen

ПРЕДУПРЕЖДЕНИЕ: Мелкие детали.

ADVARSEL: Indeholder små dele.

VARNING: Smådelar

ADVARSEL: Små deler

VAROITUS: Pieniä osia

ΠΡΟΣΟΧΗ: Περιλαμβάνονται μικρά κομμάτια.

UYARI: Küçük parçalar.

UPOZORNĚNÍ: Malé díly

UPOZORNENIE: Malé časti

FIGYELMEZTETÉS: Kis alkatrészek.





BONE SHAKER™
CLASSICS · CLÁSSICOS
КЛАССИЧЕСКИЕ МОДЕЛИ

MORE TO BUILD! · ENCORE PLUS À CONSTRUIRE!
¡MÁS PARA CONSTRUIR! · MAIS PARA CONSTRUIR!
МЕНЬШЕ ЗУМ БАУЕН! · КОНСТРУИРУЙ БОЛЬШЕ!



HDJ95



GYG32



GYG33



HDJ90



GVM26

Set(s) sold separately and subject to availability. / Ensemble(s) vendu(s) séparément. Certains produits peuvent ne pas être commercialisés. / Se vende(n) por separado y está(n) sujeto(s) a disponibilidad. / Conjunto(s) vendido(s) em separado e sujeito(s) à disponibilidade. / Set in vendita separatamente, secondo disponibilità. / Das/Die Set(s) sind separat erhältlich. / Zestaw(y) sprzedawany(e) oddzielnie w zależności od dostępności. / Set(s) apart verkrijgbaar en afhankelijk van beschikbaarheid. / Набор(ы) продаются отдельно, при наличии. / Set sælges separat og så længe lager haves. / Seten säljs separat så länge lagret räcker. / Settet/settene selges separat så langt lageret rekker. / Pakkaus/pakkaukset myydään erikseen, saatavuus voi vaihdella. / To(a) set πωλούνται ξεχωριστά και ανάλογα με τη διαθεσιμότητα. / Setler ayrı olarak satılır ve stoklarla sınırlıdır. / Set (sety) se prodává (prodávajú) samostatně dle aktuální nabídky. / Súprava/-y sa predáva(jú) samostatne a podľa dostupnosti. / A készlet(ek) külön kapható(k), az elérhetőség változhat. / セット商品は別売りになります。在庫状況は別途ご確認をお願いします。 / تبايع المجموعة أو المجموعات على حدة وتخضع لتوافرها.

每套单独发售，按供货情况决定。

Mattel Canada Inc. Mississauga, Ontario L5R 3W2.
MADE IN CHINA. FABRIQUÉ EN CHINE. FABRICADO NA / HECHO EN CHINA.
ИЗГОТОВЛЕНО В КИТАЕ. ÇIN'DE ÜRETİLMİŞTİR. صنع في الصين

Ⓟ D714,887, D781,964, D797,203

1186 MJ, 1, NL

©2021 MEGA Brands &™ MEGA Brands. HOT WHEELS™ and associated trademarks and trade dress are owned by and used under license from Mattel. HOT WHEELS™ ainsi que les marques et designs y afférents appartiennent à, et sont utilisés sous licence de Mattel. ©2021 Mattel. Printed in China / Imprimé en Chine AD-HDJ89-01

