

**MEGA**<sup>TM</sup>  
**CONSTRUX**

**POKÉMON**<sup>TM</sup>



Build it!  
Construis-Le!  
¡Constrúyelo!

**CORVIKNIGHT**  
**CORVAILLUS**  
**KRARMOR**



**WONDER**  
**BUILDERS**<sup>TM</sup>

GYG98





Fuel their imagination with building toys that support creative thinking and problem solving.  
Stimulez leur imagination avec des jouets de construction qui encouragent l'esprit créatif et la résolution de problèmes.

Alimenta su imaginación con juguetes de construcción que ayudan a desarrollar el ensamblaje creativo y la resolución de problemas.  
Abasteça a imaginação dele com brinquedos de montar que suportam o pensamento criativo e a resolução de problemas.  
Dieses Bauspielzeug beflügelt nicht nur die Phantasie, sondern unterstützt auch kreatives und lösungsorientiertes Denken.  
Разжигайте воображение детей с помощью конструктора, развивающего творческие способности и логическое мышление.



### Authentic details Détails authentiques

Detalles auténticos  
Detalhes autênticos  
Authentische Details  
Реалистичные детали



### Different sizes to build Différentes tailles à construire

Tamanhos diferentes para construir  
Verschiedene Größen zum Bauen  
Se pueden crear en distintos tamaños  
Модели для сборки разных размеров

Learn more  
Pour en savoir plus

Más información • Sabe mais • Weitere  
Infos gibt es auf • Узнать большез

[play.megaconstrux.com](http://play.megaconstrux.com)

MEGA™  
CONSTRUX

MEGA  
UNBOXED



Build  
Construisez

Construye | Constrói  
Bauen | Стройте

Devices not included | Appareils non inclus | Dispositivos no incluido | Dispositivos não incluídos  
Geräte nicht enthalten | Устройства не входят в комплект

unboxed.megaconstrux.com



1

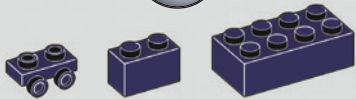

2x

2x

1x

2



1x

1x

1x

3



1x

1x

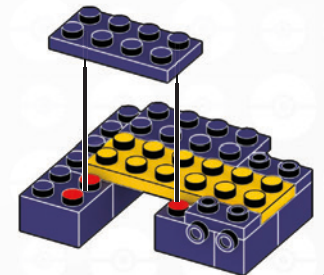
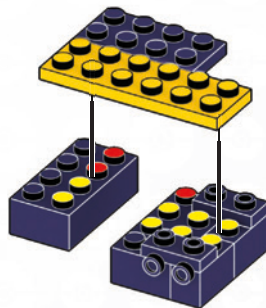
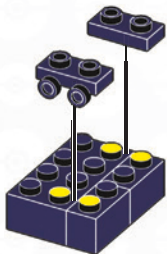



**4**  
2x

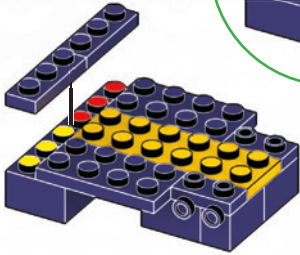
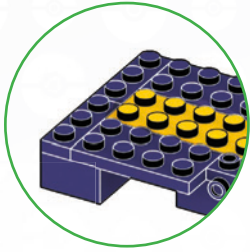

**5**  
1x 2x

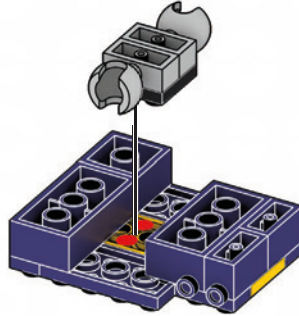
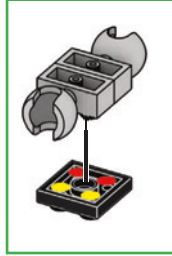

**6**  
1x 2x

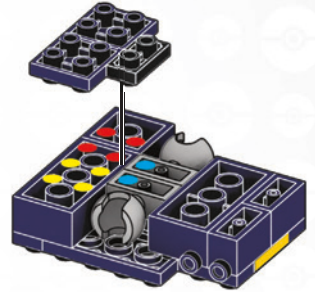

**7**  
3x

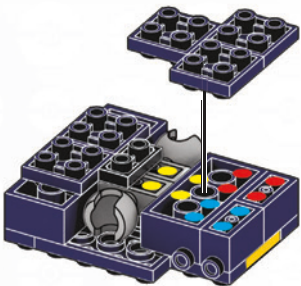

**8**  
1x

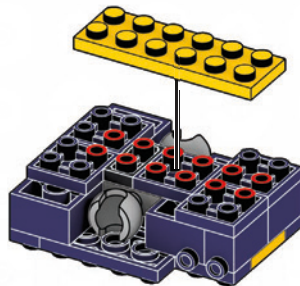

**9**  
1x 1x

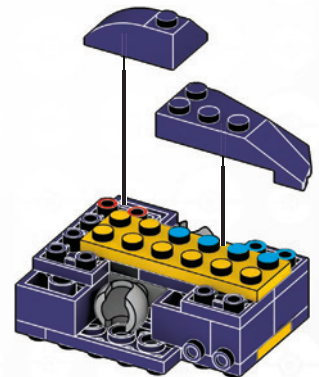



10



1x

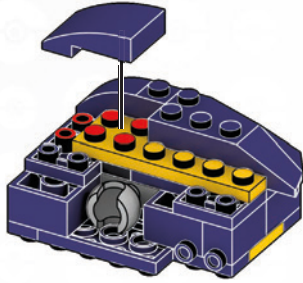

11



1x



1x

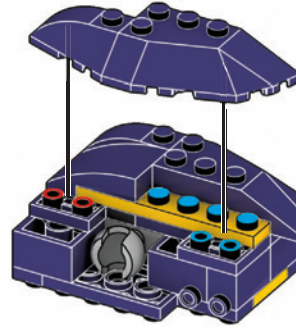

1

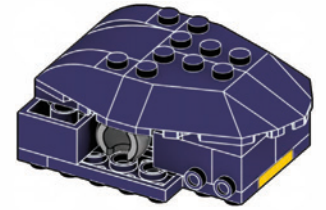

2

12



3x



1x

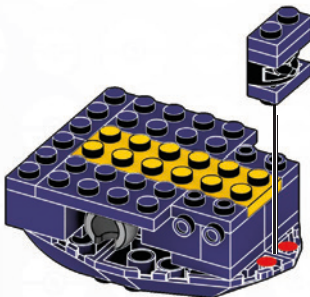

13



2x



2x



1



2

x2

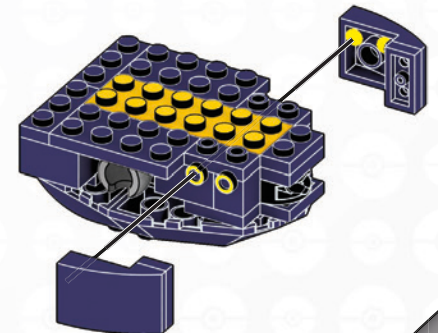

14



1x



1x

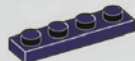

1x



15



1x



16



1x



1x

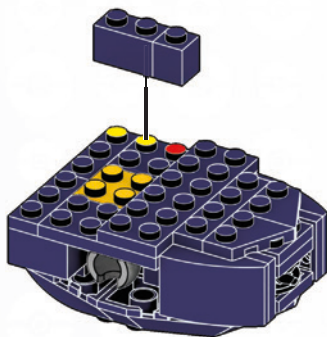

17



1x



1x

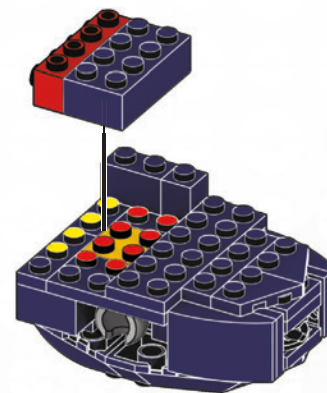

18

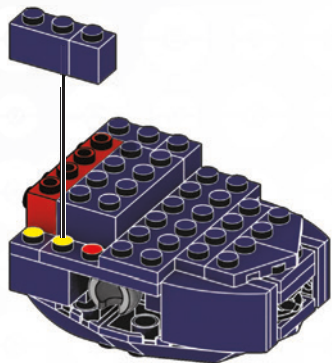

19

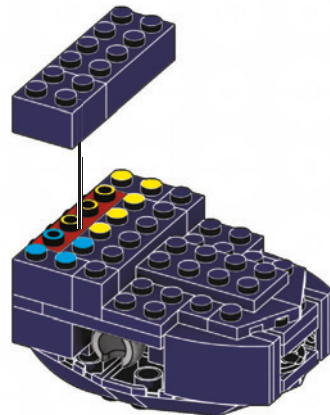
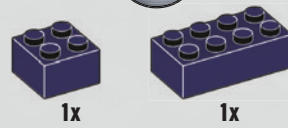

20

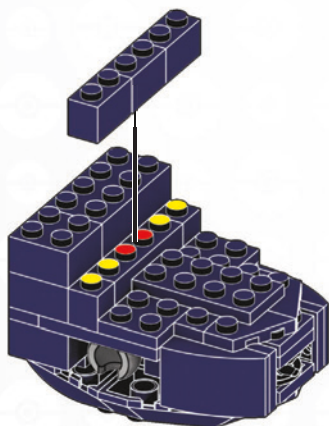

21

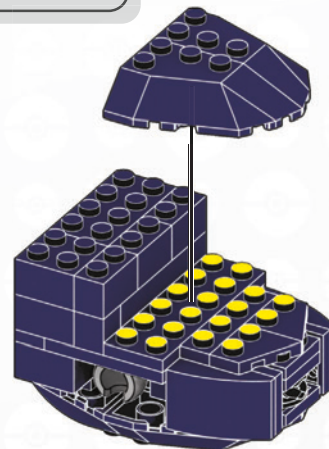
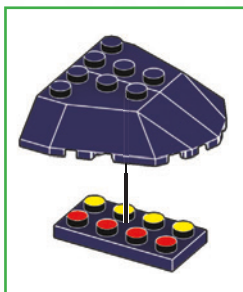



22



2x

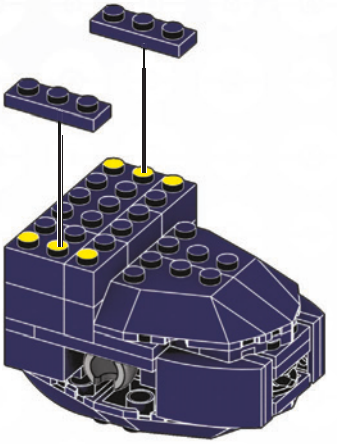

23



2x

1x

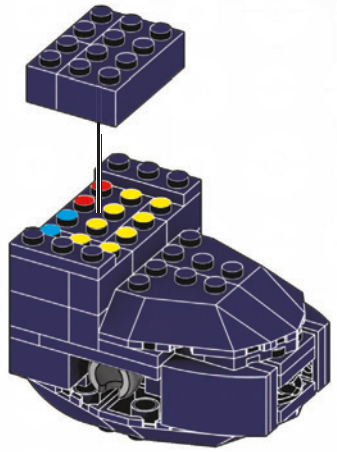

24

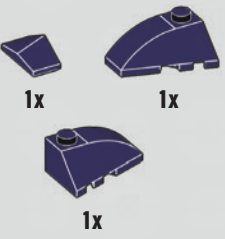

1x

1x

1x

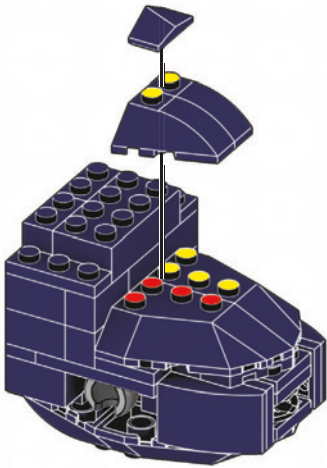

25

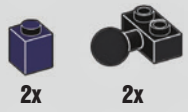

2x

2x

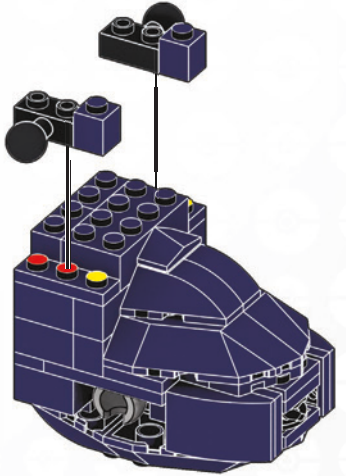

26

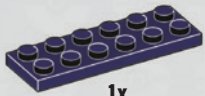

1x

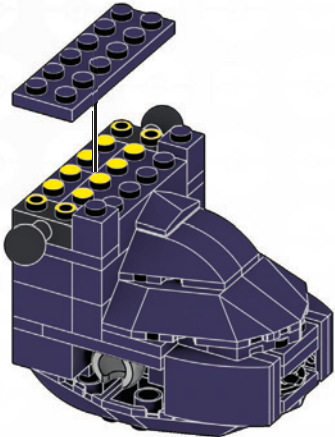

27



2x

2x

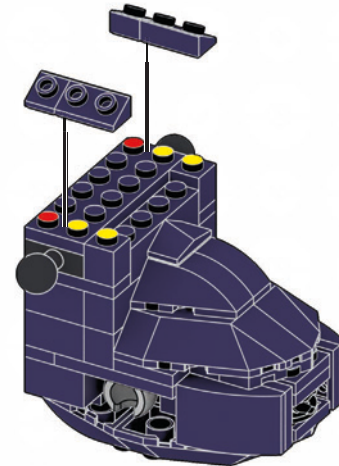

28



1x

2x

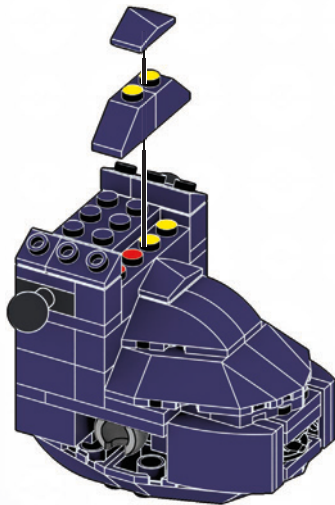

1

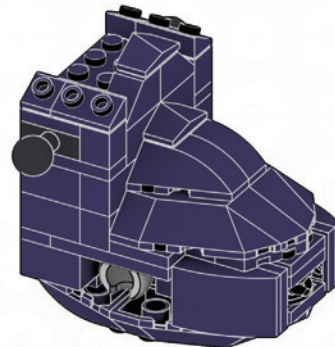

2

29

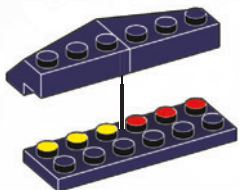
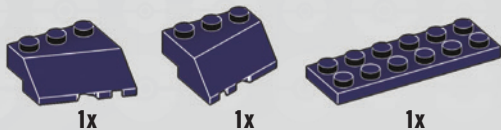

30



31

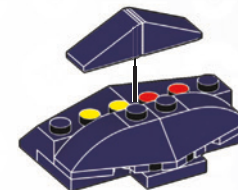

32

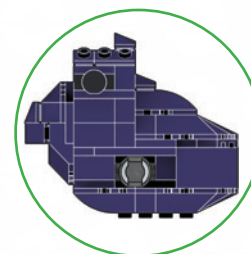
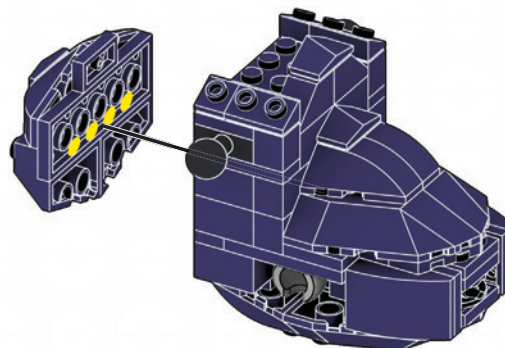
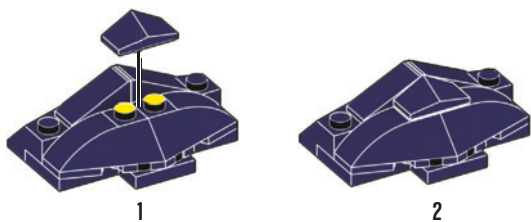





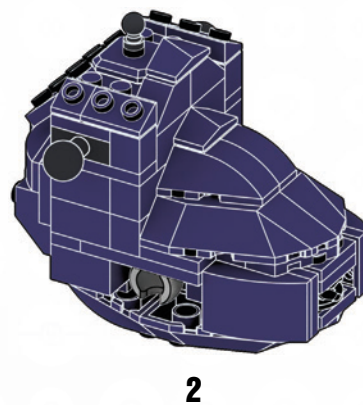
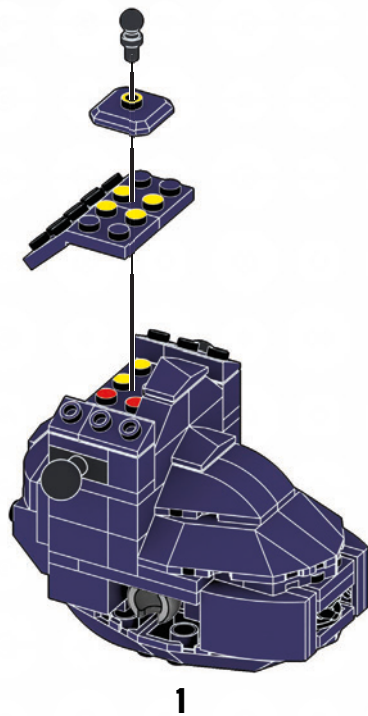

**33**

1x  1x 

2x 



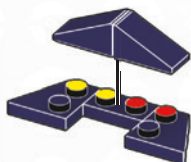

**34**

1x  1x  1x  2x 





**35**

1x  1x  1x 



**36**

1x  1x 

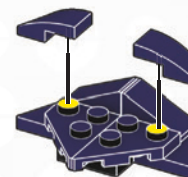

37



1x

1x



38



1x



1

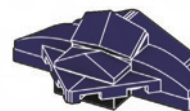

2

39

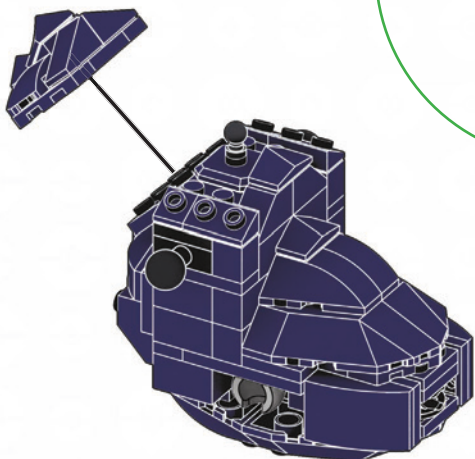

1

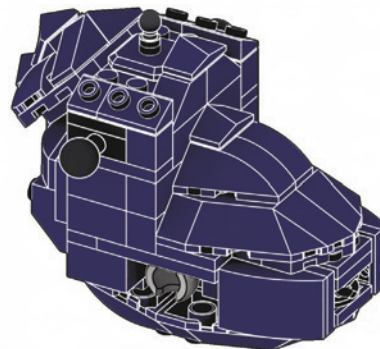
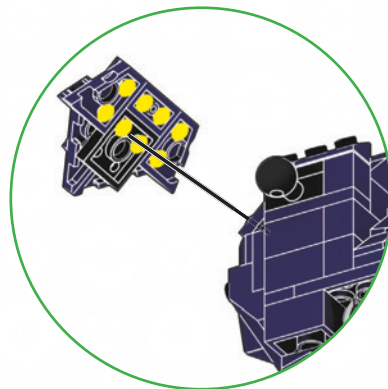

2

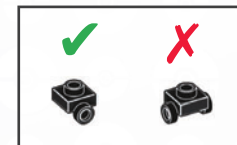
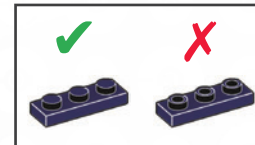
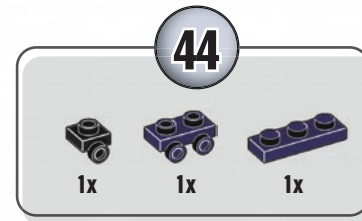
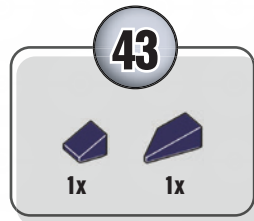
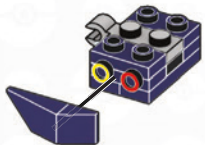
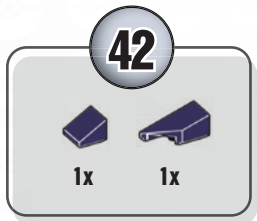
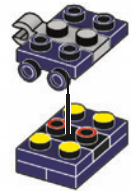
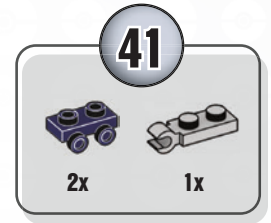
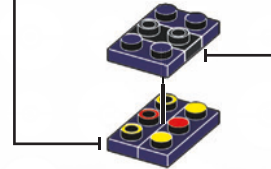
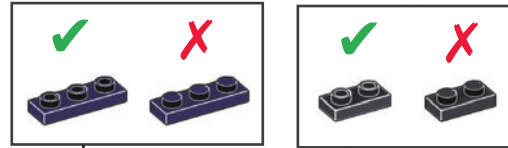
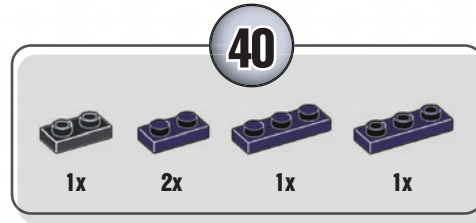

1



2



45



2x 1x

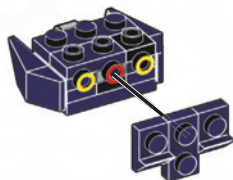

46



1x 1x 1x

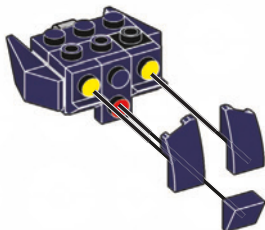

47



1x 1x

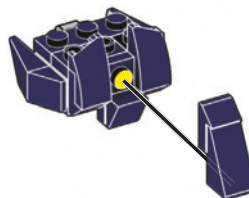

1



2

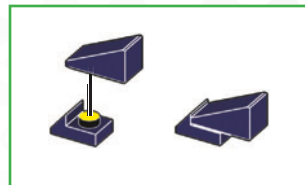

48

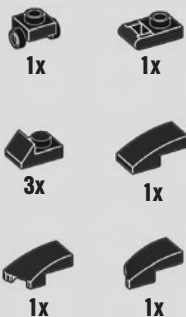

1x 1x  
3x 1x  
1x 1x

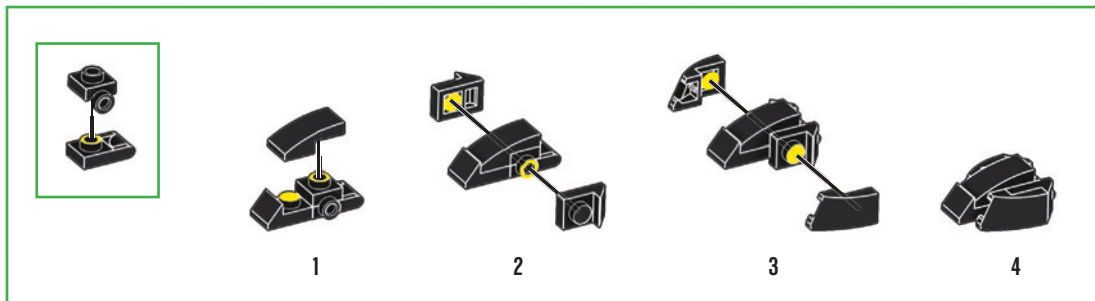
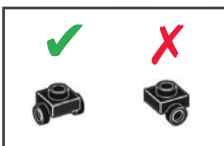

1

2

3

4

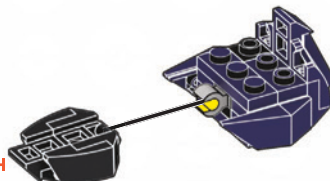

49



1x



1



2



3

50



1x

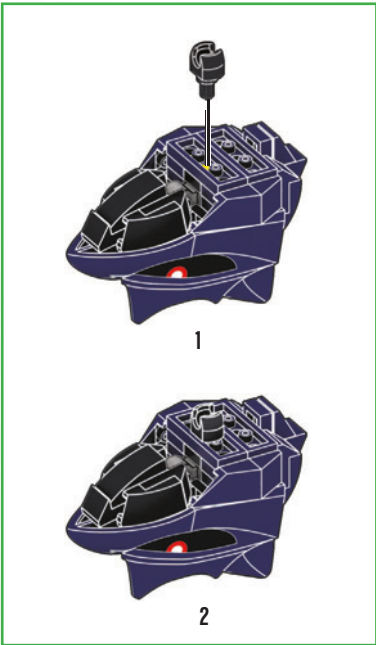

1

2

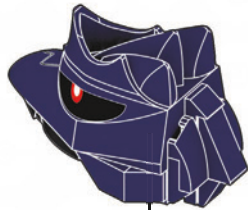
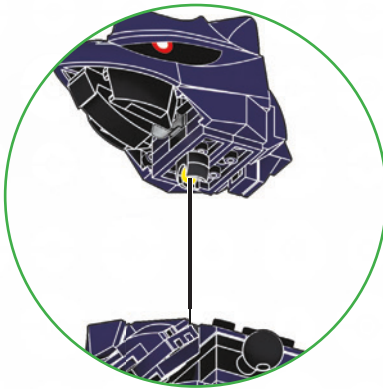

1

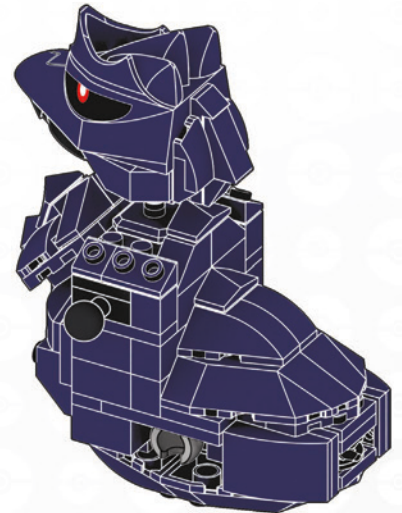

2

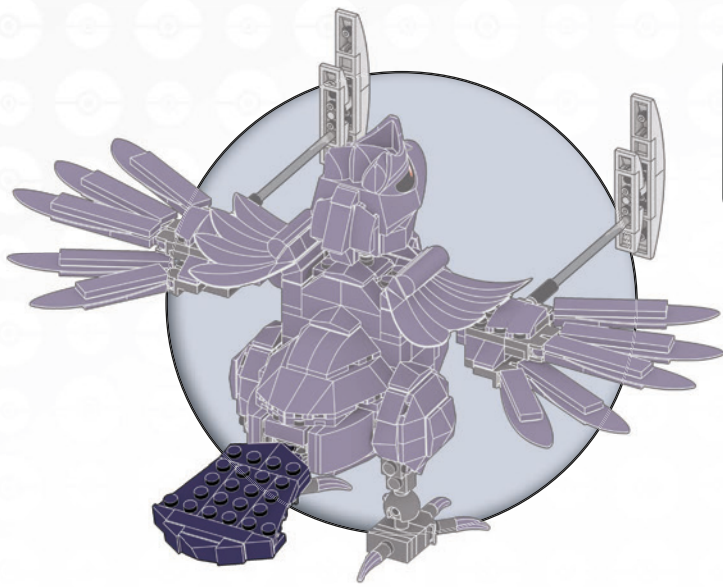

51

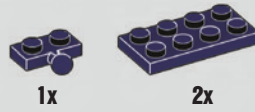

1x

2x



52

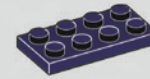

2x

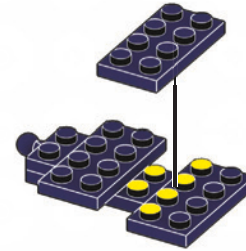

53



1x

1x

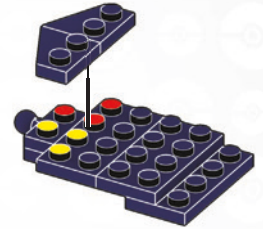

54



3x

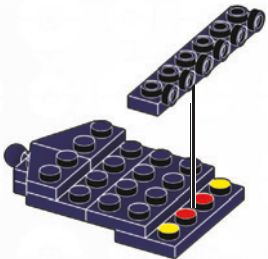

55

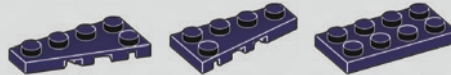

1x

1x

1x

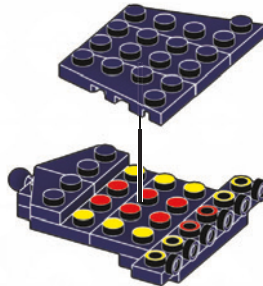

56



2x

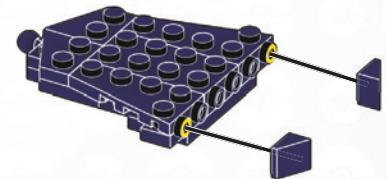



57

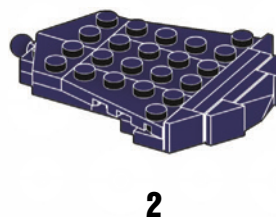
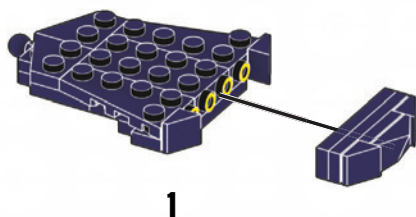
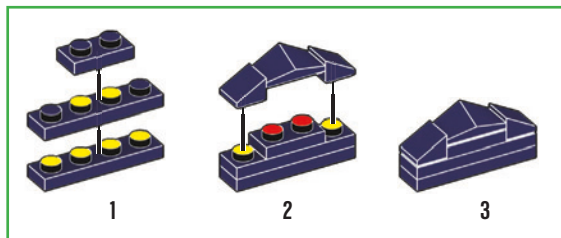

58

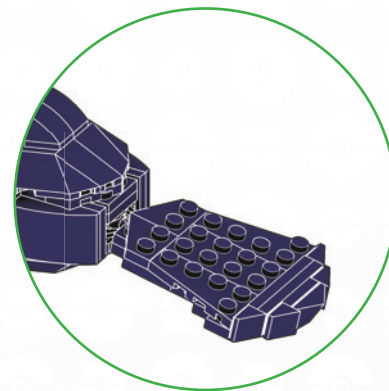
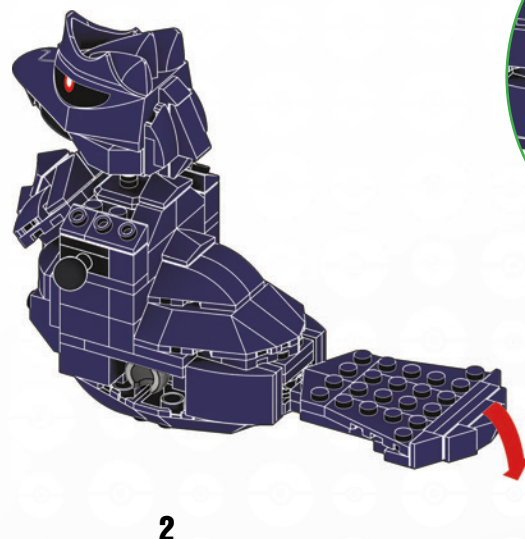
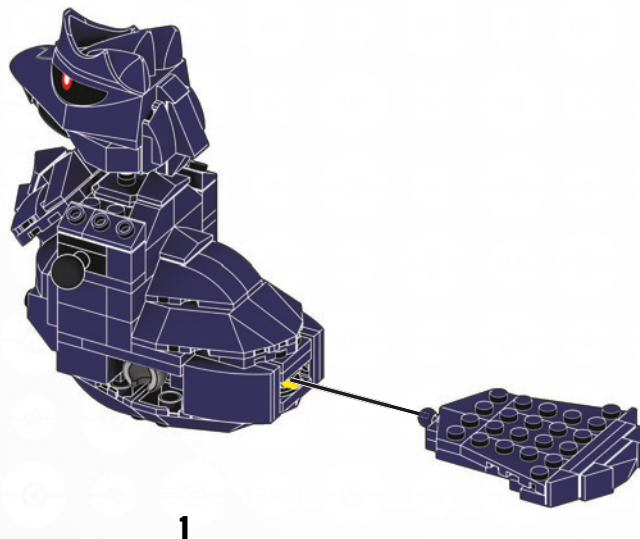



**x2**

59 → 63

**59**

1x 1x 1x

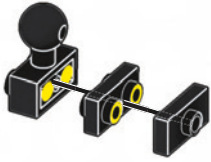

**60**

1x 1x

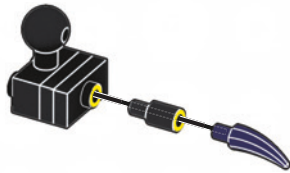

1

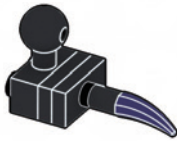

2

**61**

3x 1x

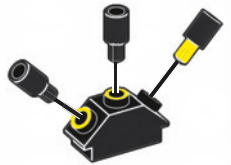

**62**

3x



1



2

**63**

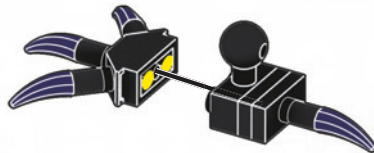

1

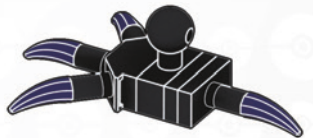

2

64



1x 2x

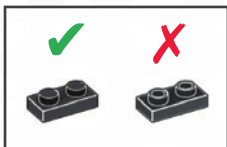

1



2

65



1x 1x 1x

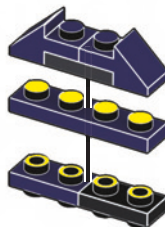

1



2

66



1x

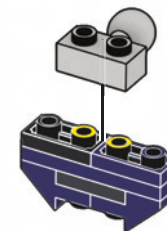

67



3x

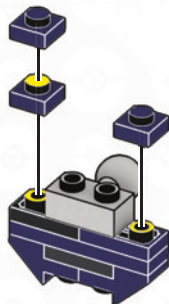

68



2x

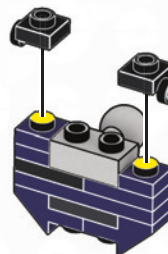
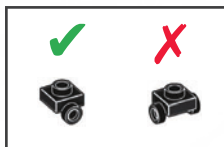

69

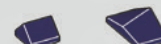

1x 1x



70



1x

1x

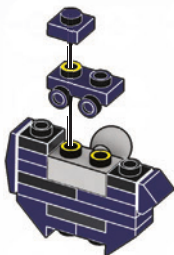

71



1x

1x

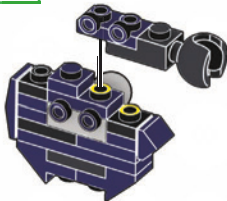

72



1x

1x

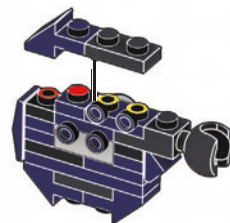
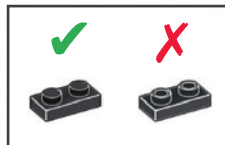

1

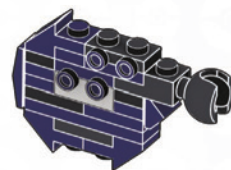

2

73



2x

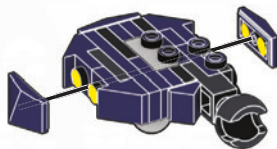

74



1x

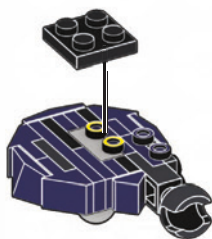

75



2x





76



2x



1



2

77

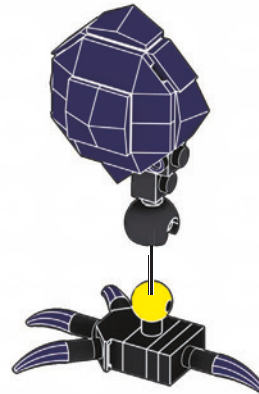

1

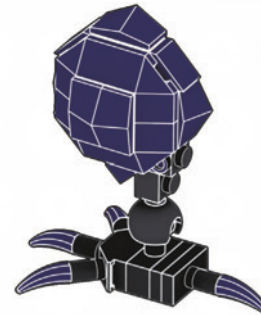

2

78



1x



2x



1



2

79



1x



1x



1x

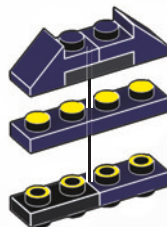

1



2

80



1x

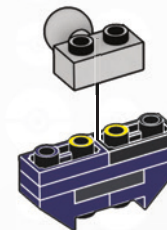

81



3x

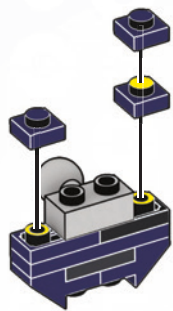

82



2x

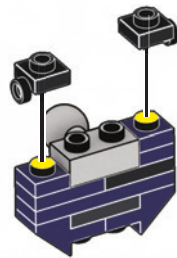
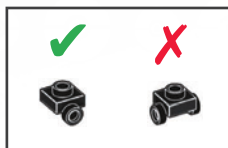

83



1x



1x

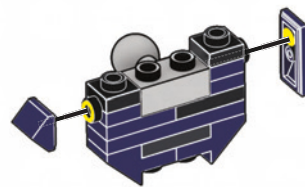

84



1x



1x

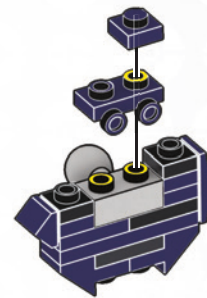

85



1x



1x

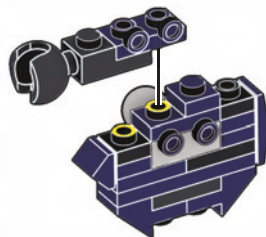
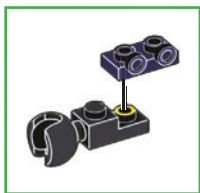

86



1x



1x

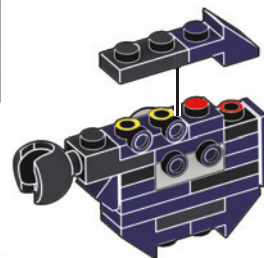
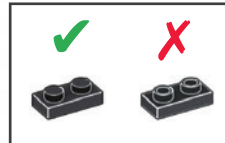

1

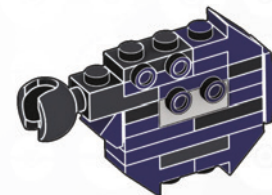

2

87



2x

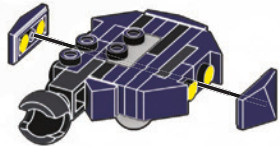

88



1x

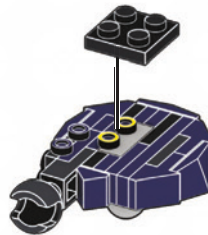

89



2x



90



2x



1

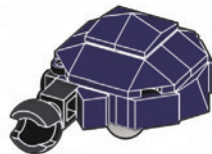

2

91



1



2

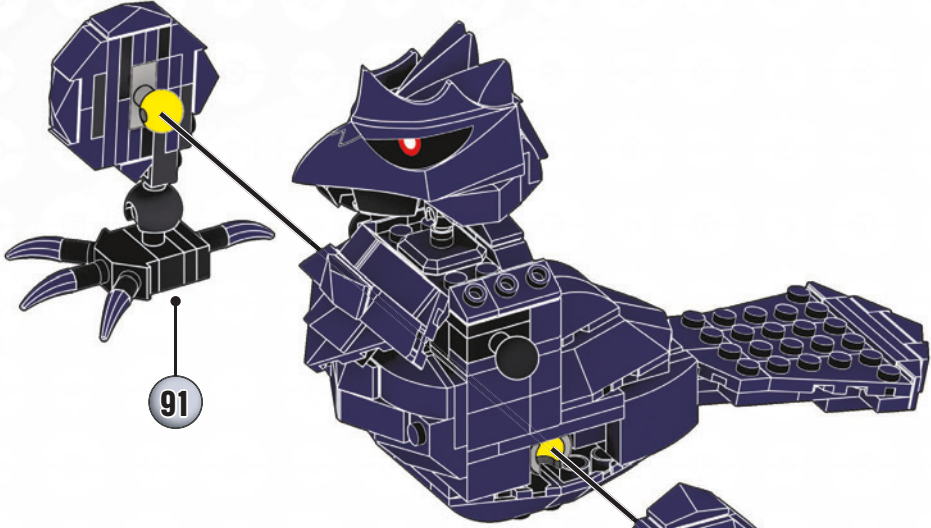

1

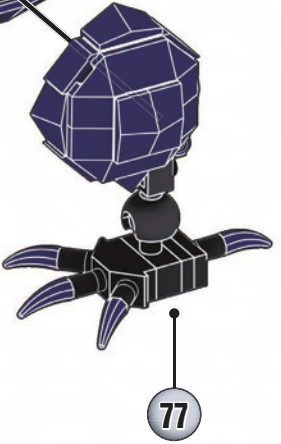

77



2



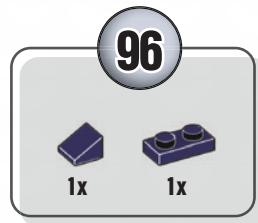
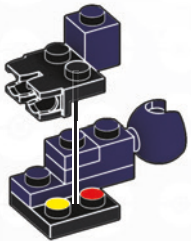
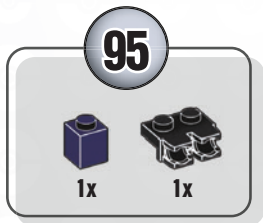
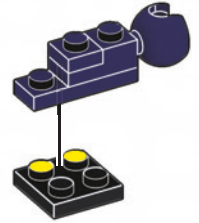
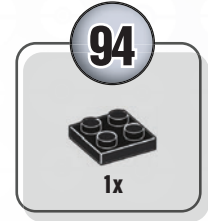
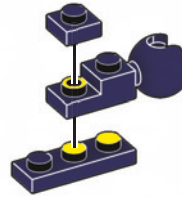
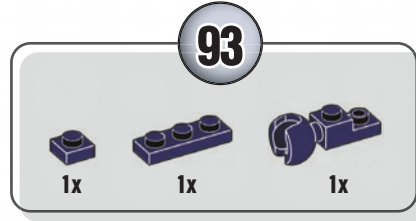
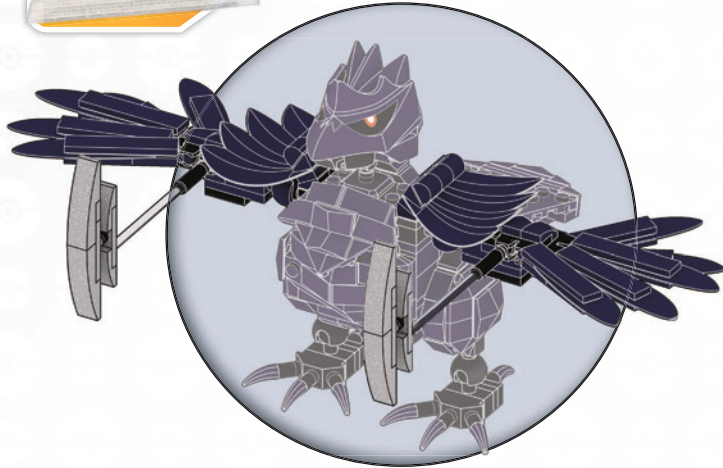

1

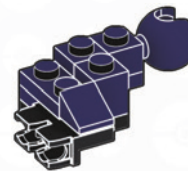
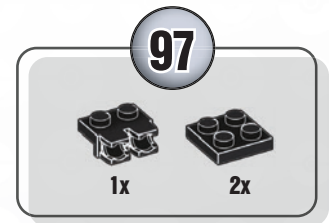

2



98



1x



99



2x

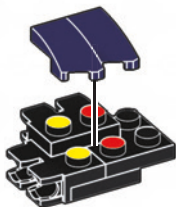

100

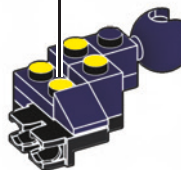

1

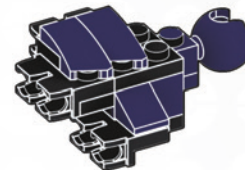

2

101



1x



1x



1x



1x

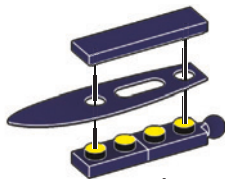

1



2

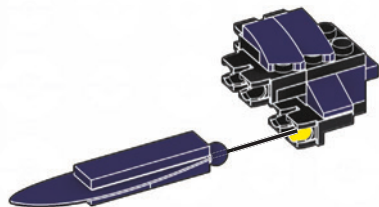

1

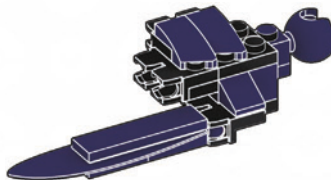

2



3

102

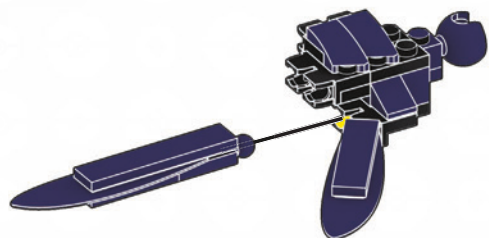
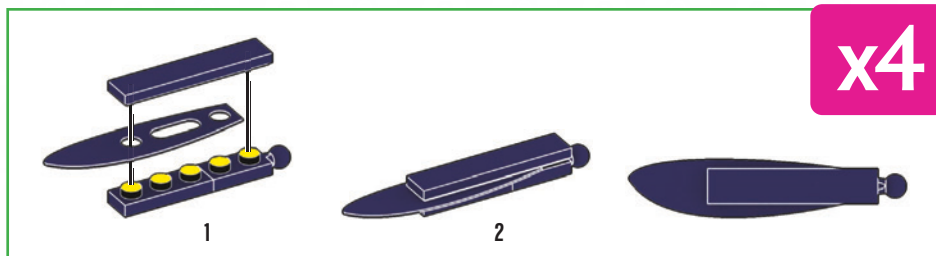
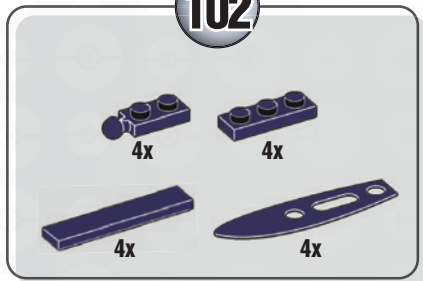

1

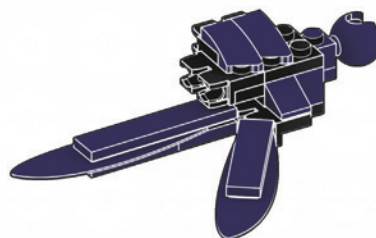

2

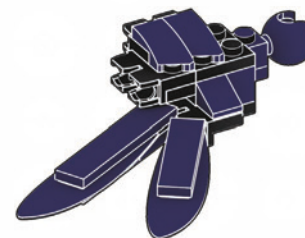

3

103

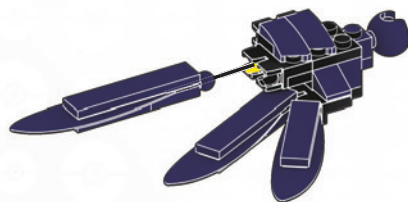

1

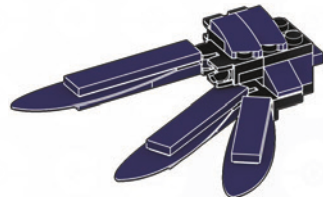

2

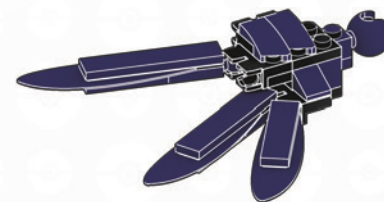

3

104



1

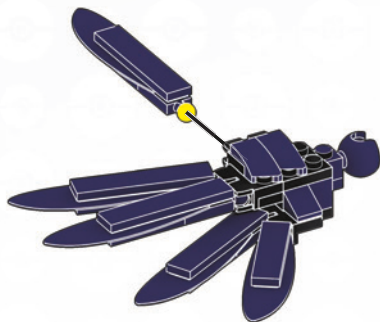

2

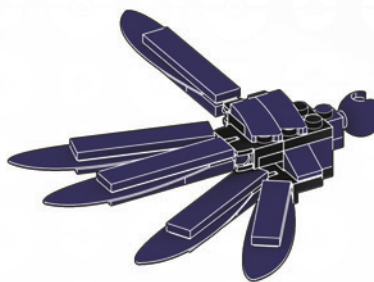

3

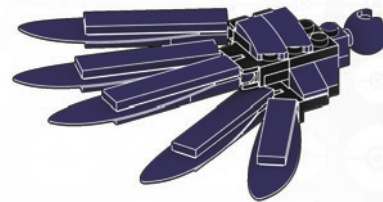

4

105

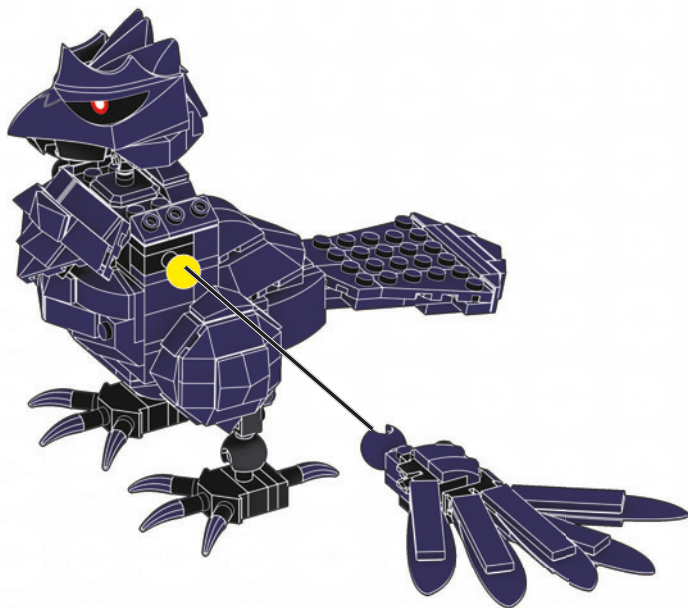

1



2



106

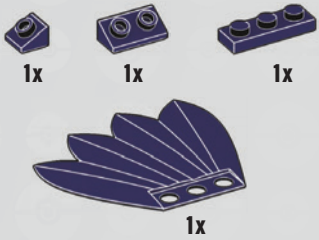

107

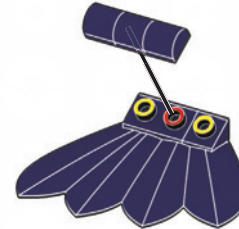

1



2

108



1



2

109

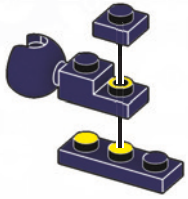

110

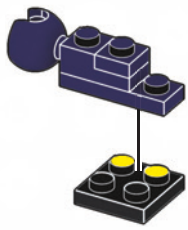

111

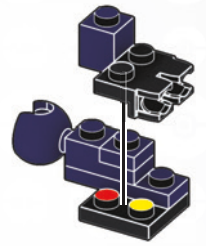

112



1

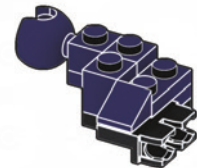

2

113



114



115



2x

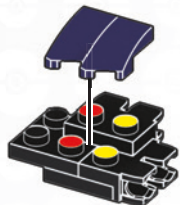

116

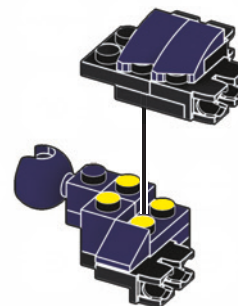

1

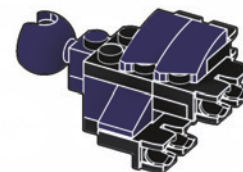

2

117



1x



1x



1x



1x

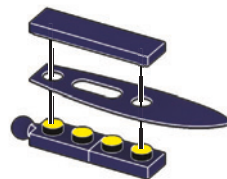

1



2

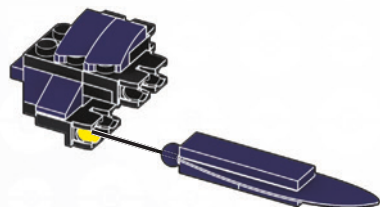

1

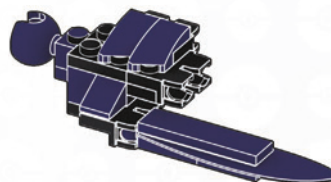

2

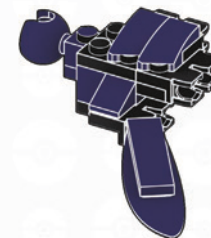

3

118

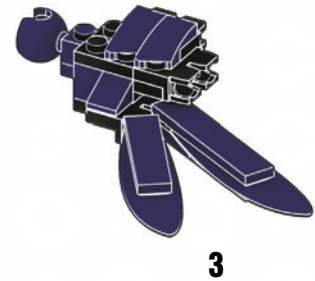
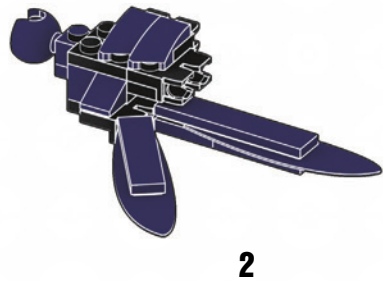
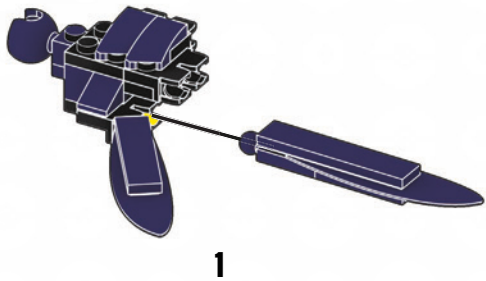
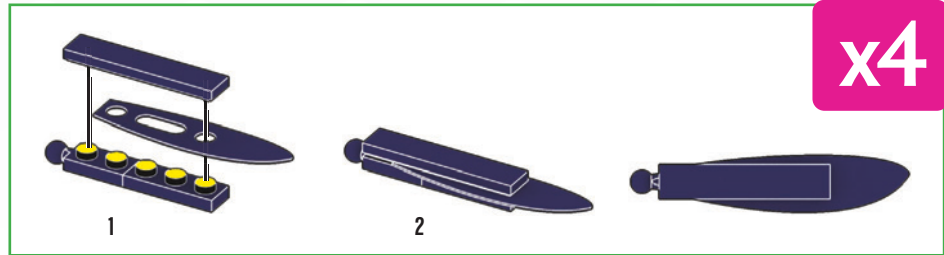
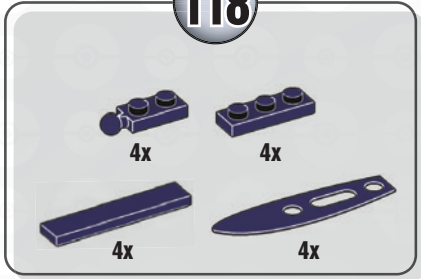

119

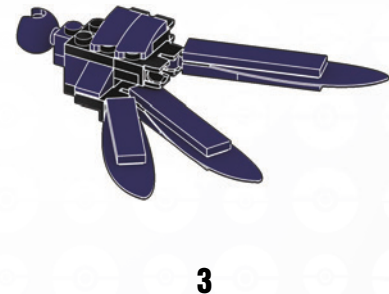
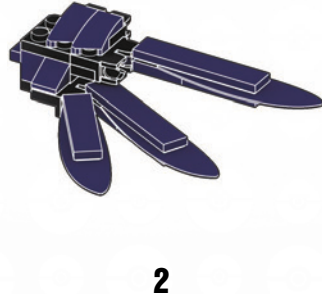
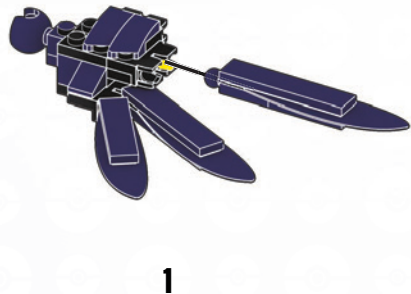



120



1

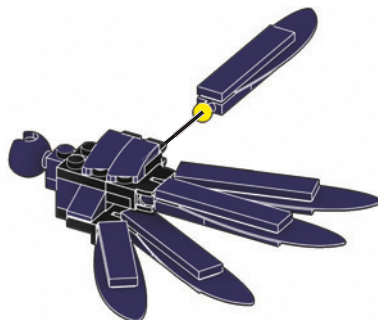

2

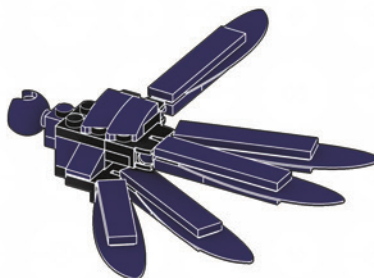

3

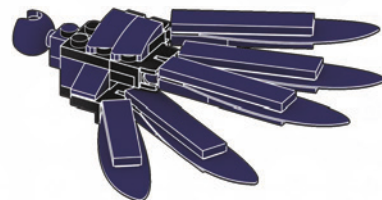

4

121



1



2

122



123

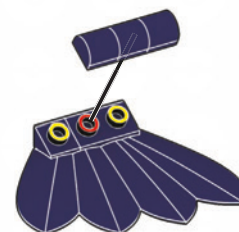

1



2

124



1



2

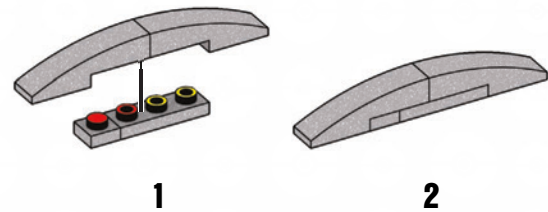
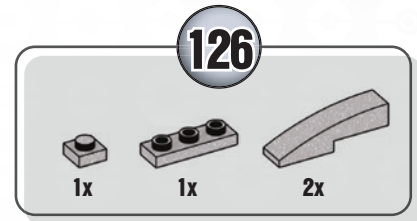
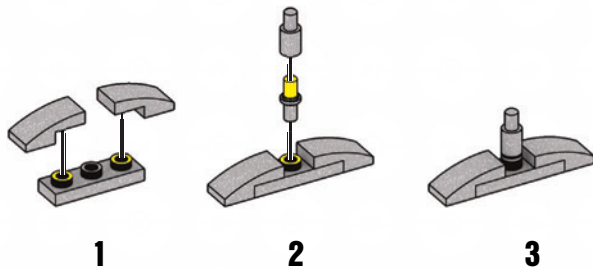
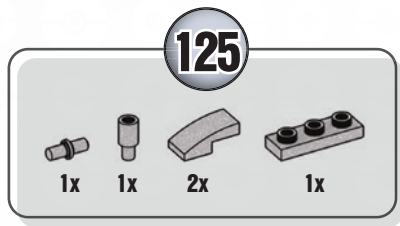
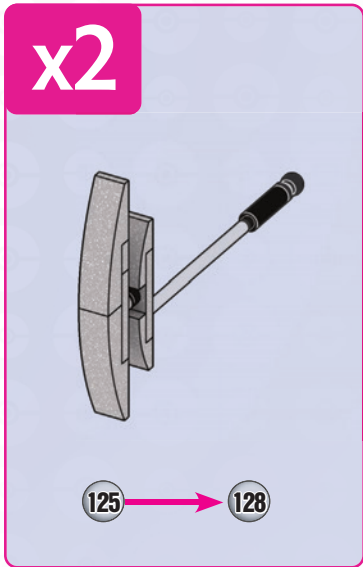

**127**

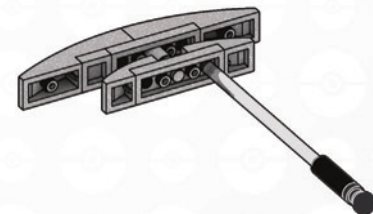
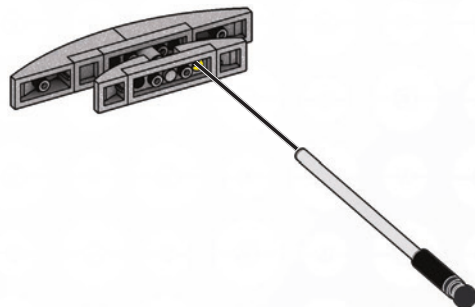
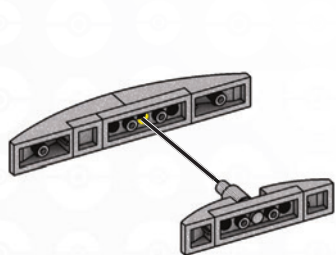
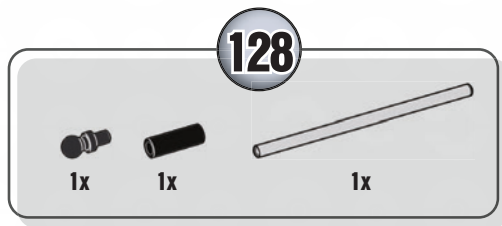



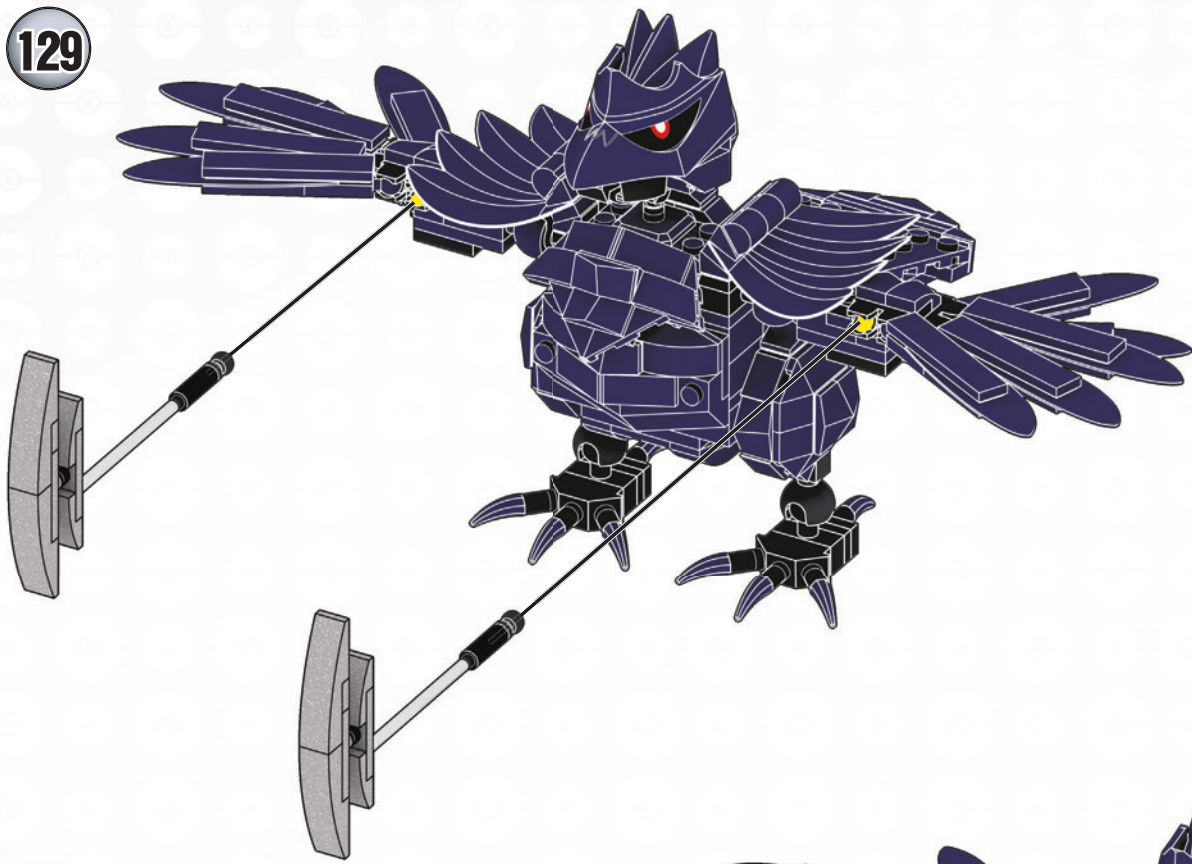

1



2



# CORVIKNIGHT CORVAILLUS KRARMOR

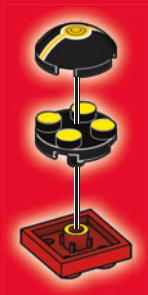

1



2

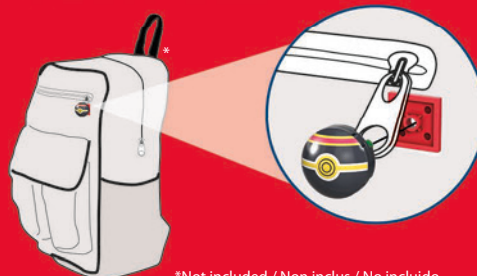

\*Not included / Non inclus / No incluido  
não incluido / Nicht enthalten / не входит



**BUILD THEM!  
CONSTRUJS-LES!  
¡CONSTRUYELOS!  
CONSTROI TODOS!  
ΚΑΤΑΣΚΕΥΗ! • ПОСТРОЙ!**



Set(s) sold separately and subject to availability. / Ensemble(s) vendu(s) séparément. Certains produits peuvent ne pas être commercialisés. / se

vende(n) por separado y está(n) sujeto(s) a disponibilidad. / Conjunto(s) vendido(s) em separado e sujeito(s) à disponibilidade. / Set in vendita separatamente, secondo disponibilità. / Das/Die Set(s) sind separat erhältlich. / Zestaw(y) sprzedawany(e) oddzielnie w zależności od dostępności. / Set(s) apart verkrijgbaar en afhankelijk van beschikbaarheid. / Набор(-ы) продаются отдельно, при наличии. / Sæt sælges separat og så længe lager haves. / Seten säljs separat så länge lagret räcker. / Settet/settene selges separat så langt lageret rekker. / Pakkaus/pakkaukset myydään erikseen, saatavuus voi vaihdella. / Το(α) σετ πωλούνται ξεχωριστά και ανάλογα με τη διαθεσιμότητα. / Setler ayrı olarak satılır ve stoklarla sınırlıdır. / Set (sety) se prodává (prodávají) samostatně dle aktuální nabídky. / Súprava/-y sa predáva(jú) samostatne a podľa dostupnosti. / A készlet(ek) külön kapható(k), az elérhetőség változhat. /

セット商品は別売りになります。在庫状況は別途ご確認をお願いします。 /

تباع المجموعة أو المجموعات على حدة وتخضع لتوافرها.

每套单独发售，按供货情况决定。



- 2x AM74397APG
- 8x AM74397AYB
- 2x AM17003APG
- 10x AM03328AYU
- 2x AM03328APG
- 5x AM77574AYB
- 1x AM78273AYB
- 2x AM77901AYU
- 6x AM16980AYU
- 9x AM17127AYU
- 4x AM72001AYU
- 6x AM01086AYU
- 3x AM78291AYB
- 1x AM76054AYB
- 1x AM78296AYB

- 3x AM19530AYU
- 3x AM19530AYB
- 2x AM17506F
- 8x AM72384AYU
- 16x AM17131AYU
- 2x AM07590AYB
- 15x AM09393AYU
- 4x AM09393AYB
- 5x AM16680AYB
- 2x AM16680AYU
- 1x AM79246AYB
- 4x AM72001AYU
- 1x AM78397AYU
- 7x AM76467AYU
- 5x AM79070AYU
- 3x AM18665AYU
- 3x AM18666AYU

- 1x AS-GYG98-02
- 1x AM79018AYB
- 4x AM78486APG
- 1x AM78486AYB
- 1x AM78281F
- 5x AM18272AYU
- 1x AM17130AYU
- 1x AM17129AYU
- 4x AM74427AYU
- 1x AM74427AYB
- 4x AM74426AYU
- 1x AM74426AYB
- 6x AM18740AYU
- 5x AM04430AYU
- 2x AM01322AYU

- 9x AM09013AYU
- 1x AM73009AYU
- 10x AM03773AYB
- 5x AM01146AYU
- 1x AM79017AMC
- 1x AM16975BLG
- 10x AM78276AYU
- 2x AM79796BLG
- 4x AM79227AYB
- 2x AM79227BLG
- 2x AM80282AYB
- 2x AM80282AYU
- 3x AM18775AYU
- 3x AM18776AYU

- 2x AM16653AYU
- 2x AM74060AYB
- 6x AM80577AYB
- 2x AM09023AYU
- 1x AM76205AYU
- 1x AM76206AYU
- 18x AM01314AYU
- 1x AM72600AYU
- 4x AM72600APG

- 1x AM15478AYU
- 1x AM15479AYU
- 3x AM17021AYU
- 1x AM17503AMC
- 5x AM09593AYU
- 2x AM09838AYU
- 5x AM09033AYU
- 8x AM09493AYU

- 4x AM18736AYU
- 1x AM74065AYU
- 1x AM74064AYU
- 4x AM19323APG
- 8x AM17793AYU
- 2x AM01480BYE
- 3x AM01480AYU
- 10x AM81210AYU

- 2x AM18227AYU
- 2x AM18226AYU
- 1x AS-GYG98-01
- 2x AM81209AYU
- 2x AM18259W

**Missing pieces?**  
**Pièces manquantes?**  
¿Partes faltantes? • Perdeu peças?  
Fehlen Teile? • Не хватает деталей?  
[support.megabrands.com](http://support.megabrands.com)

**ATTENTION : DANGER**  
D'ÉTOUFFEMENT. - PRÉSENCE DE PETITS ÉLÉMENTS. NE CONVIENT PAS AUX ENFANTS DE MOINS DE 3 ANS.

**ATENÇÃO!** NÃO INDICADO / NÃO RECOMENDÁVEL PARA CRIANÇAS MENORES DE 3 (TRÊS) ANOS POR CONTER PARTE(S) PEQUENA(S) QUE PODE(M) SER ENGOLIDA(S) OU ASPIRADA(S) PODENDO PROVOCAR ASFIXIA.

警告:  
のどにつまる危険 小さな部品が含まれています  
3歳以下の子供には与えないで下さい。

**警告!**  
不适合3岁以下儿童使用。内含小零件。

⚠ WARNING : CHOKING HAZARD. - Small parts. Not for children under 3 years.  
ADVERTENCIA: PELIGRO DE ATRAGANTAMIENTO. Juguete no recomendado para menores de 3 años, porque contiene piezas pequeñas que podrían provocar asfixia en caso de ser ingeridas o inhaladas por el/la niño/a.  
AVVERTENZA: Contiene pezzi di piccole dimensioni.  
ACHTUNG: Kleine Teile.  
OSTRZEŻENIE: Małe części. Niebezpieczeństwo zadławienia.  
WAARSCHUWING: Kleine onderdelen.  
ΠΡΟΣΟΧΗ: Περιλαμβάνονται μικρά κομμάτια.  
UYARI: Küçük parçalar.  
UPOZORNĚNÍ: Malé díly  
UPOZORNENIE: Malé časti  
FIGYELMEZTETÉS: Kis alkatrészek.



تحذير:  
غير مناسبة للأطفال دون 36 شهراً - قطع صغيرة.

MEGA  
CONSTRUX

POKÉMON

10+  
PRO  
BUILDERS

MORE TO BUILD! / ENCORE PLUS À CONSTRUIRE! / MÁS PARA CONSTRUIR!  
MAIS PARA CONSTRUIR! / MEHR ZUM BAUEN! / СОБЕРИ ИХ ВСЕХ!



GYH00



GYG96



GYG94

Are you ready for  
the next challenge?  
Prêt pour le prochain défi?

¿Estás listo para el siguiente desafío?  
Você está pronto para o próximo desafio?  
Bist du bereit für die nächste  
Herausforderung?  
Вы готовы к следующему испытанию?



Set(s) sold separately and subject to availability. / Ensemble(s) vendu(s) séparément. Certains produits peuvent ne pas être commercialisés. / Se vende(n) por separado y está(n) sujeto(s) a disponibilidad. / Conjunto(s) vendido(s) em separado e sujeito(s) à disponibilidade. / Set in vendita separatamente, secondo disponibilità. / Das/Die Set(s) sind separat erhältlich. / Zestaw(y) sprzedawany(e) oddzielnie w zależności od dostępności. / Set(s) apart verkrijgbaar en afhankelijk van beschikbaarheid. / Набор(ы) продаются отдельно, при наличии. / Sæt sælges separat og så længe lager haves. / Seten säljs separat så länge lager räcker. / Settet/settne selges separat så langt lageret rekker. / Pakkaus/pakkaukset myydään erikseen, saatavuus voi vaihdella. / Το(α) σετ πωλούνται ξεχωριστά και ανάλογα με τη διαθεσιμότητα. / Setler ayrı olarak satılır ve stoklara sınırlıdır. / Set (sety) se prodává (prodávají) samostatně dle aktuální nabídky. / Súprava/-y sa predáva(jú) samostatne a podľa dostupnosti. / A készlet(ek) külön kapható(k), az elérhetőség változhat. / セット商品は別売りになります。在庫状況は別途ご確認をお願いします。 / تباع المجموعة أو المجموعات على حدة وتخضع لتوافرها. / 每套单独发售，按供货情况决定。

Mattel Europa B.V., Gondel 1, 1186 MJ Amstelveen, Nederland. Mattel U.K. Limited, The Porter Building, 1 Brunel Way, Slough SL1 1FQ, UK. Mattel France, Parc de la Cerisaie, 1/3/5 allée des Fleurs, 94260 Fresnes Cedex. N° Cristal 0969 36 99 99 (Numéro non surtaxé) ou www.lesjouetsmattel.fr Mattel Belgium, Trade Mart, Atomiumsquare, Bogota 202 - B 275, 1020 Brussels. Gratis nummer België: 0800 - 16 936. Gratis nummer Luxemburg: 800 - 22 784. Gratis nummer Nederland: 0800 - 262 88 35. Deutschland: Mattel GmbH, Solmsstraße 83, D 60486 Frankfurt am Main, Schweiz: Mattel AG, Kirchstrasse 24, CH-3097 Liebfeld, Österreich: Mattel Ges.m.b.H., Campus 21, Liebermannstraße A01 404, A - 2345 Brunn/Cebrige, Mattel Italy Srl, Via Turati 4, 20121 Milano, Italy. Servizio assistenza clienti: Customer.rv.italia@mattel.com - Numero verde 800 11 37 11. Mattel España, S.A. Arribau 200 pl. 9, 08036 Barcelona. cs.service.spain@mattel.com Tel.: +34 933 06 79 00 http://www.service.mattel.com/es. Mattel East Asia Ltd., Room 503-09, North Tower, World Finance Centre, Harbour City, Tsimshatsui, HK, China. Tel.: (852) 3185-6500. Diimport & Diedarkan Oleh: Mattel Continental Asia Sdn Bhd, Level 19, Tower 3, Avenue 7, No. 8 Jalan Kerinci, Bangsar South, 59200 Kuala Lumpur, Malaysia. Mattel South Africa (PTY) LTD, Office 102 B, 30 Melrose Boulevard, Johannesburg 2196. Distributor: Mattel Poland Sp. z o.o., Warsaw Trade Tower 34 p. ul. Chłodna 51, 00-867 Warszawa. Mattel Australia Pty Ltd., 658 Church St., Richmond, Victoria, 3121. Consumer Advisory Service - 1300 135 312. Mattel AEBE, Εθνάρχου Μακρυίου 1, Κτίριο Κ-2, Τ.Κ. 17561, Πτολίδια @άθηνες, Mattel Oyuncakları Tic. Ltd. Sti. İkerenköy Mah., Umut Sok. No:10-12 Quick Tower Kat:2/15 34752 Ataşehir İstanbul Tel: 0216 570 75 00. Импортер/Уполномоченная организация: ООО "МАТТЕЛ" Российская Федерация, 105120 Москва, 2-й Сургутинский переулок, 1; +7 495 287 79 39. Mattel Czech Republic s.r.o., The Forum, Václavské nám. 19, 11000 Praha 1. Mattel, 333 Continental Boulevard, El Segundo, CA 90245, USA. Consumer Services: 1-800-465-MEGA (6342). Mattel Canada Inc., Mississauga, Ontario L5R 3W2. Consumer Services: You may call us free at / Composez sans frais le 1-800-524-8697. Importado y distribuido por Mattel de México, S.A. de C.V., Miguel de Cervantes Saavedra No. 193, Pisos 10 y 11, Col. Granada, Alcaldía Miguel Hidalgo, CP. 11520, México, Ciudad de México. R.F.C. IMME-920701-NB3. Tel: 59-95-51-00 Ext. 5206 e 01-800-463-59-89. Mattel Chile, S.A., Avenida Américo Vesputcio 501-B, Quilicura, Santiago. Tel: 1230-020-6213. Servicio al consumidor Venezuela: Tel: 0-800-100-9123. Mattel Argentina, S.A., Av. Libertador 1000, Piso 11 - Oficinas 109 y 111, Vicente López - Prov. Buenos Aires. Tel: 0800-666-3373. Mattel Colombia, S.A., Calle 123#7-07 PS, Bogotá. Tel: 01800-710-2069. Mattel Perú, S.A., Av. Juan de Arona # 151, Centro Empresarial Juan de Arona, Torre C, Piso 7, Oficina 704, San Isidro, Lima 27, Perú. RUC: 20425853865. Reg. Importador: 02350-12-JUE-DIGESA. Tel: 0800-54744. E-mail Latinoamérica: servicio.clientes@mattel.com. Mattel do Brasil Ltda. - CNPJ: 54.558.002/0001-20 - Rua Verbo Divino, 1488 - 2º. Andar - 04719-904 - Chácara Santo Antônio - São Paulo - SP - Brasil. Serviço de Atendimento ao Consumidor: fone 0800 575 0780. E-mail: sac.matteldobrazil@mattel.com

Mattel Canada Inc. Mississauga, Ontario L5R 3W2.  
MADE IN CHINA. FABRIQUE EN CHINE. FABRICADO EN CHINA. HECHO EN CHINA.  
ИЗГОТОВЛЕНО В КИТАЕ. ÇIN'DE ÜRETİLMİŞTİR. صنع في الصين

©2020 MEGA Brands &™ MEGA Brands.  
Printed in China / Imprimé en Chine AD-GYG98-01A

©2020 Pokémon. ©1995–2020 Nintendo / Creatures Inc. / GAME FREAK inc. TM, ®, and character names are trademarks of Nintendo.

©2020 Pokémon. ©1995–2020 Nintendo/Creatures Inc./GAME FREAK inc. TM, ® et les noms des personnages sont des marques de Nintendo.



© D781,964, D797,203, D799,607,  
D835,727, D841,101, D834,105

1186 MJ, 1, NL

