

MEGATM



HKF87

BONE SHAKERTM CRUSH COURSE
PARCOURS BONE SHAKER

PISTA DE CHOQUES DE BONE SHAKERTM / CIRCUITO DE DESTRUIÇÃO BONE SHAKER
BONE SHAKER CRASH SET / ИГРОВОЙ НАБОР BONE SHAKERTM

SMASHTM
CRASH



Build Construisez

Construye | Constrói
Bauen | Стройте



Share | Partagez

Comparte | Partilha
Teilen | Делитесь



Easy-to-follow steps! Des instructions faciles à suivre !

¡Pasos fáciles de seguir!
Passos fáceis de seguir!
Einfache Schritte!
Простые действия!



Devices not included | Aparellos non inclús | Dispositivos no incluido | Dispositivos não incluídos | Geräte nicht enthalten | Устройства не входят в комплект

megaunboxed.com



BUILDING TOOL OUTIL DE CONSTRUCTION

HERRAMIENTA DE CONSTRUCCIÓN
BAUWERKZEUG
FERRAMENTA DE MONTAGEM
ИНСТРУМЕНТ ДЛЯ КОНСТРУИРОВАНИЯ

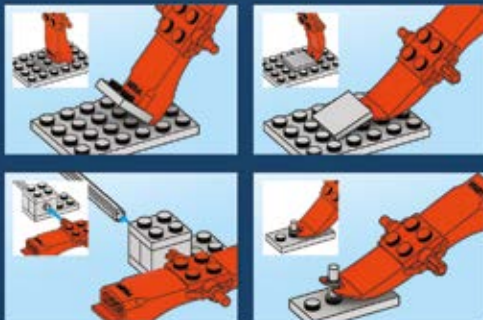



1



2

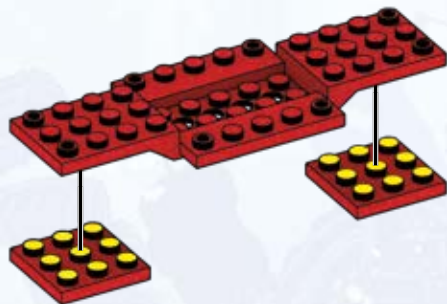

3



2x

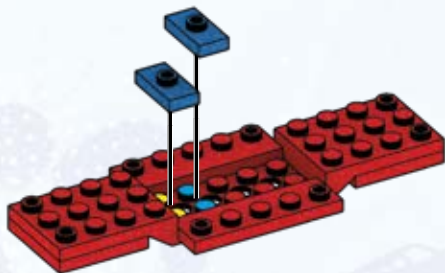

4



2x



2x

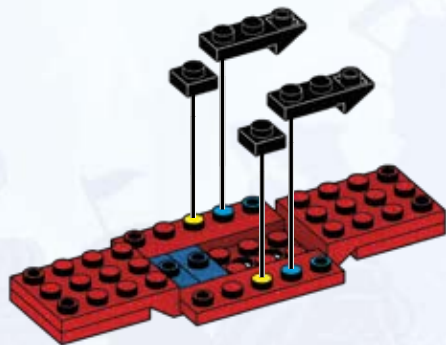

5



1x

6



2x

1x

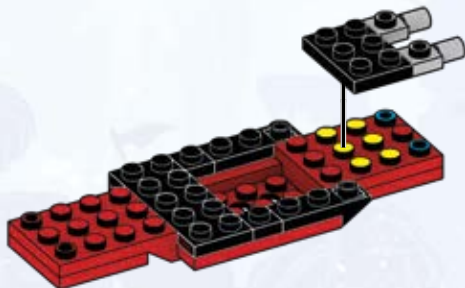
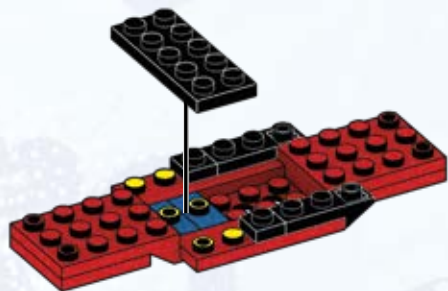

7



3x

8



2x

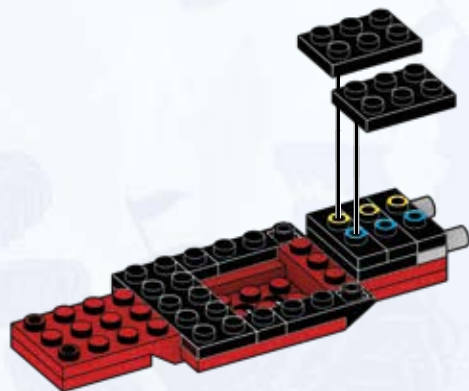
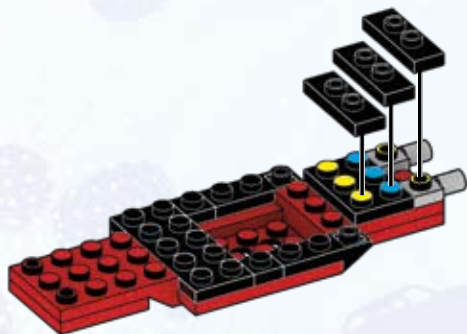

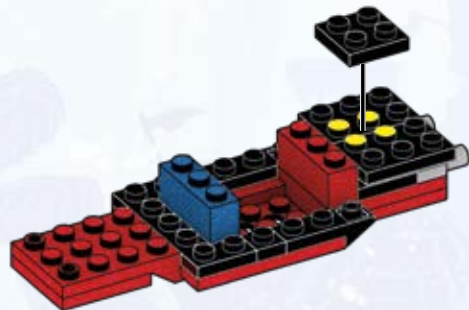
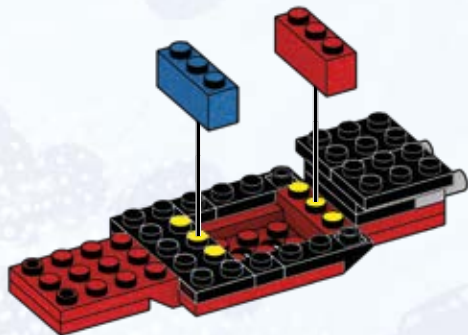
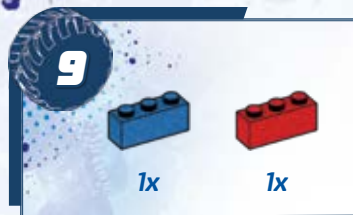

11



3x

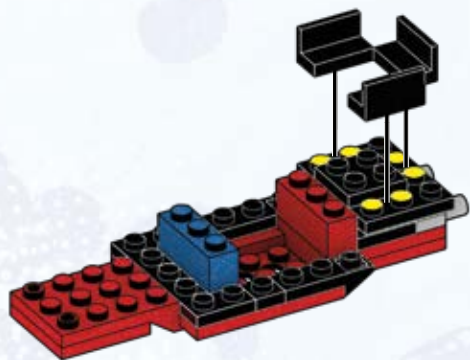

12



2x

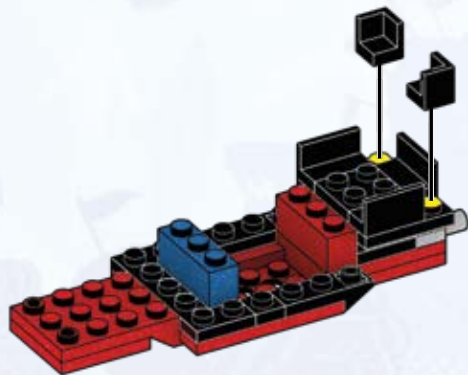

13



1x

1x



14



1x

1x



15



1x



1x



1

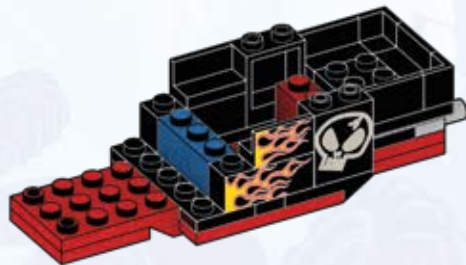

2

16



4x



4x

x4



1



2

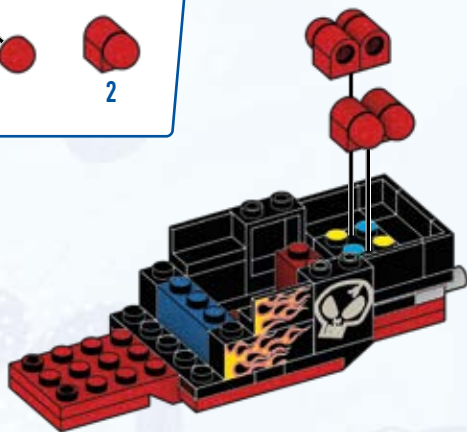

1



2

17



1x



1x

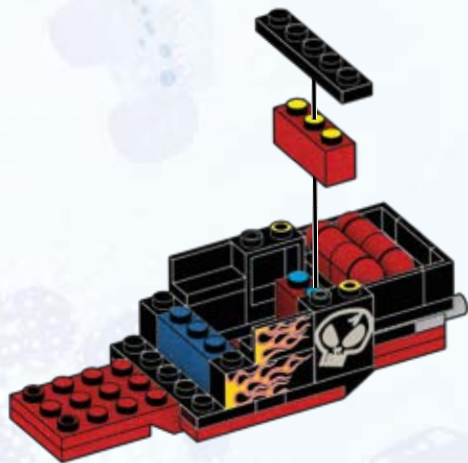

18



1x



1x

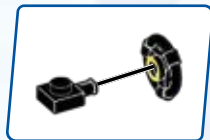

19



2x

20



2x

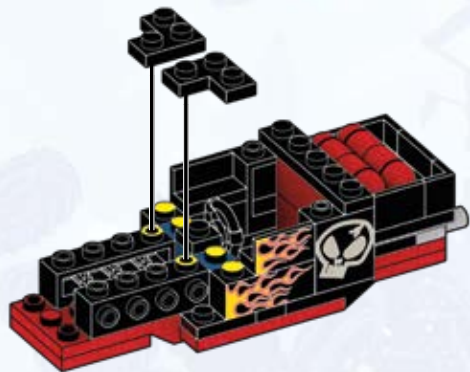

21



2x

1x

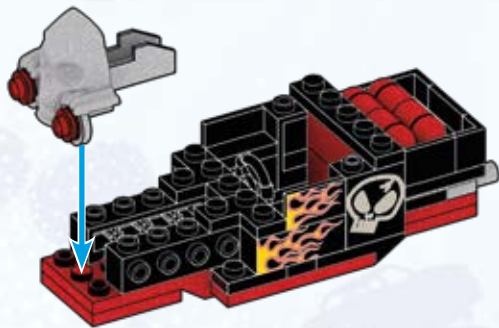
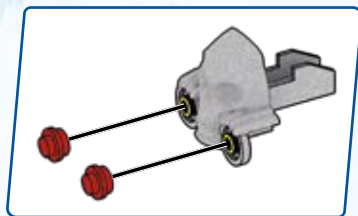

22



1x

1x

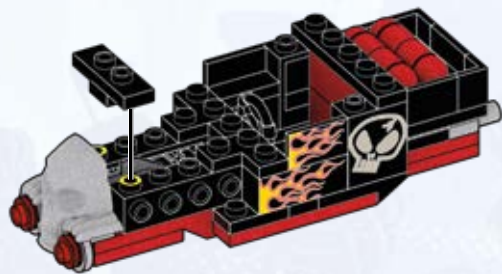
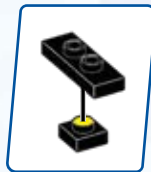

23



1x

24



1x



1x



1x



25



1x

3x

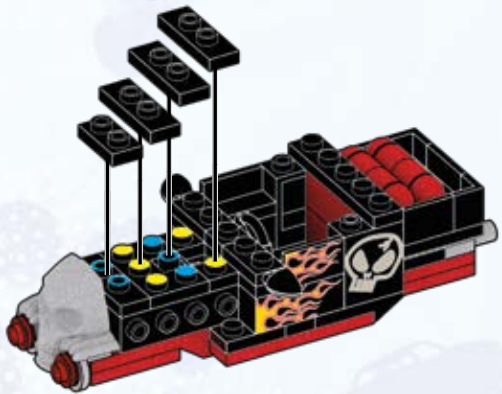

26



2x

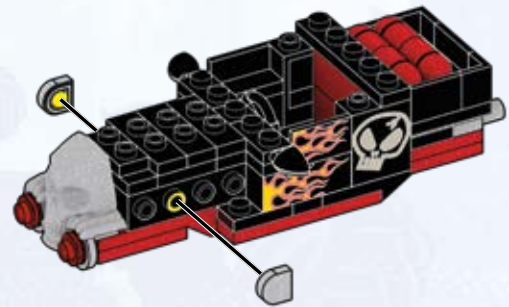

27



2x



2x



1



2

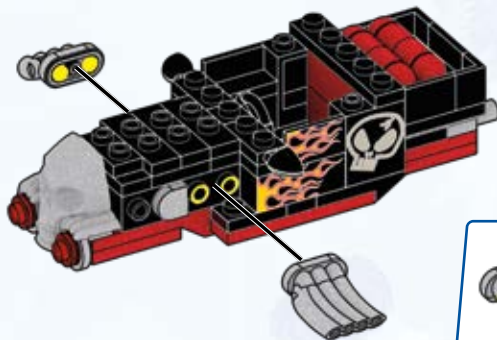

1



2

28



2x



1x

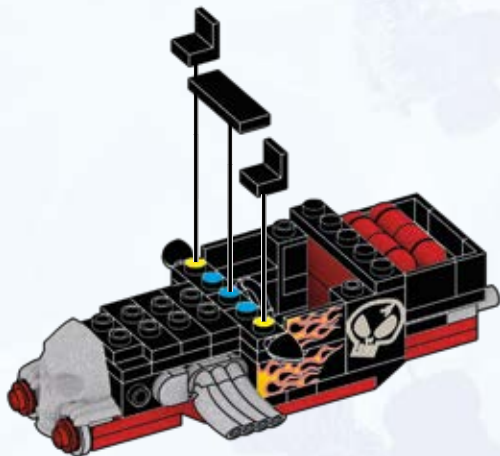

29



2x

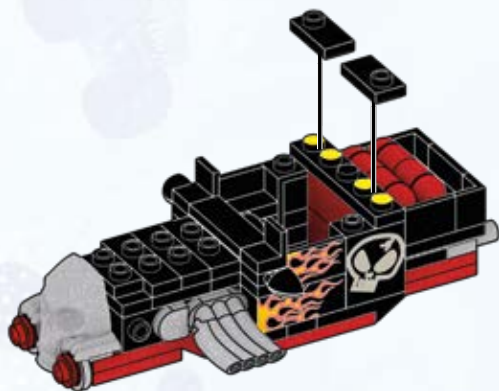

1

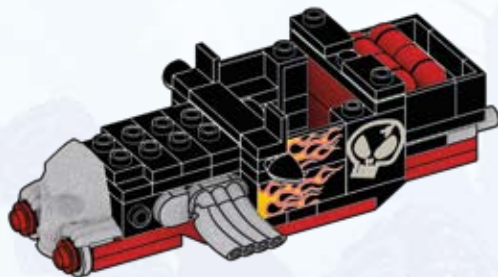

2

30



1x



1x



31



1x



32



2x

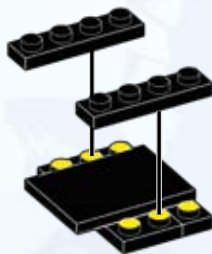

33



1x



2x

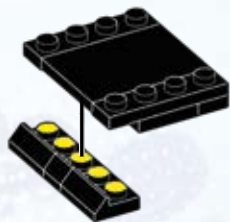

1

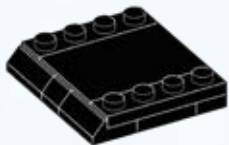

2

34

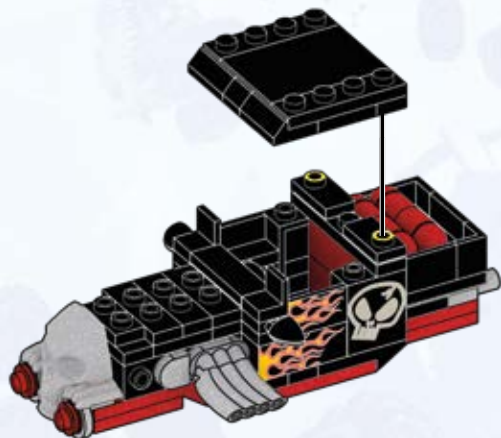

35



8x

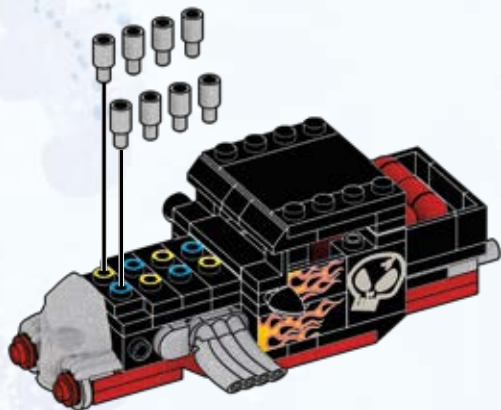

1

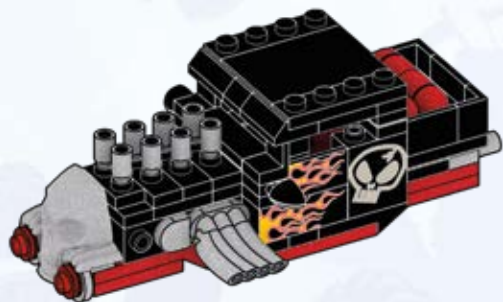

2

36



1x



1x

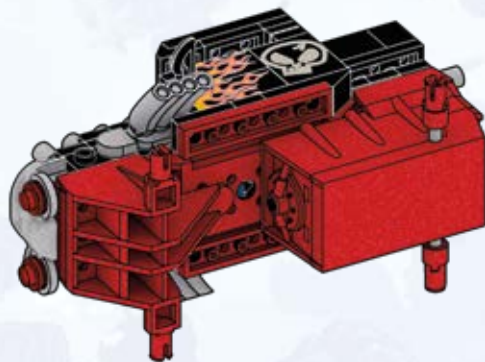
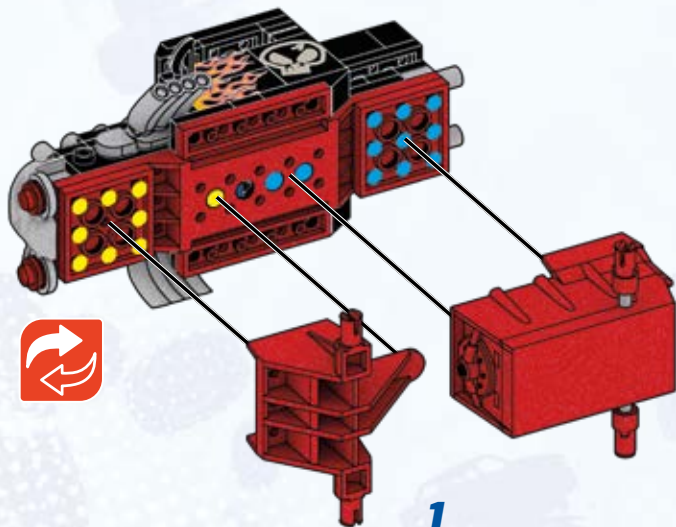

2

37



2x



2x

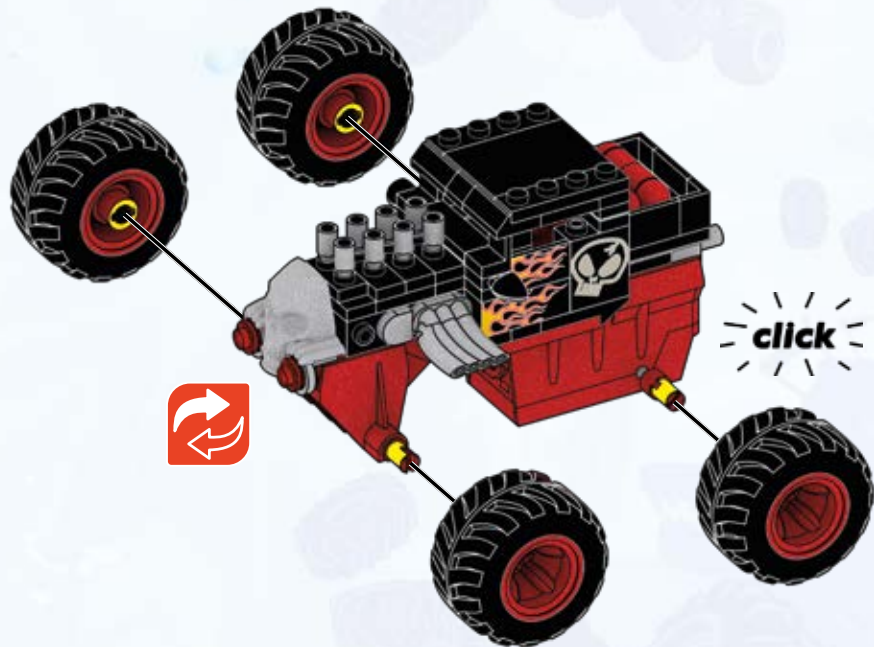

1



2



1



2

3

38



2x



1x

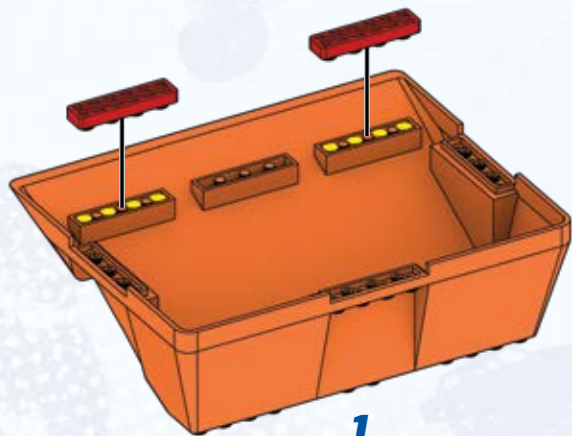

1

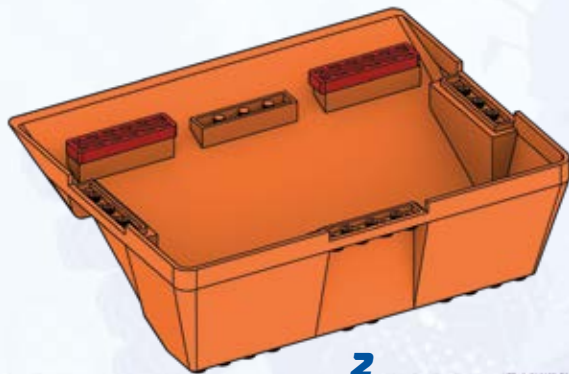

2

39



2x

40



3x

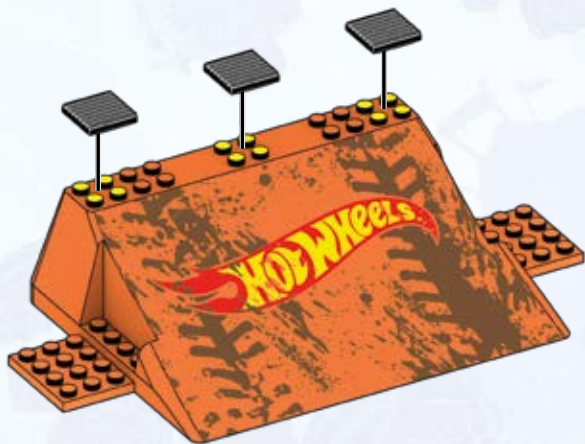

41



2x



2x

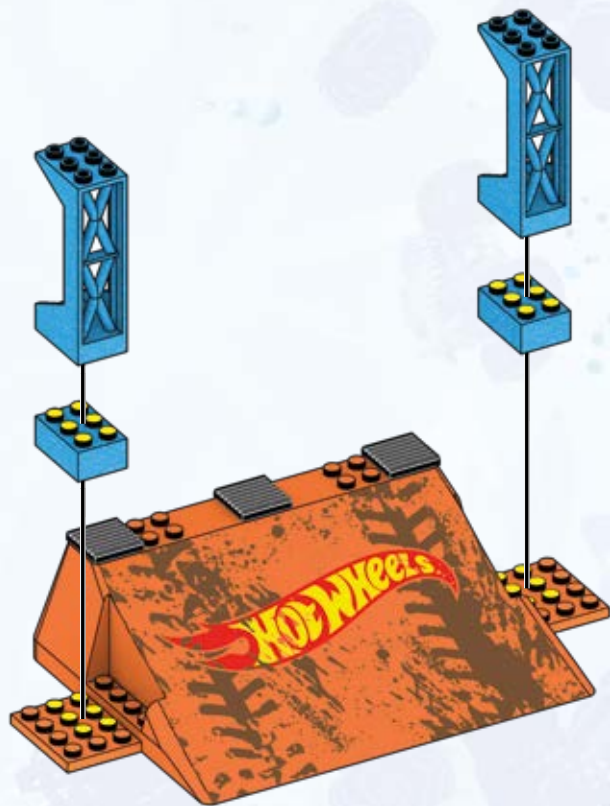

42



2x



2x

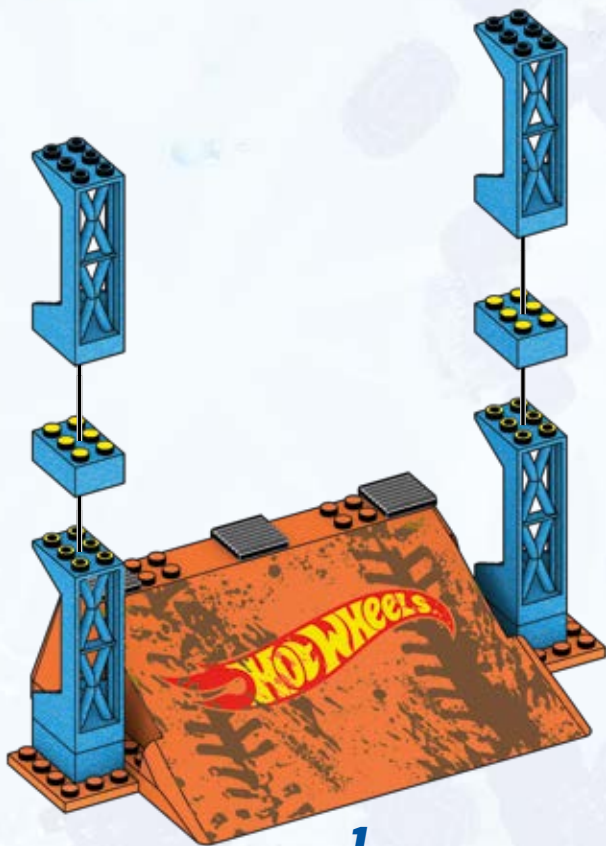

1

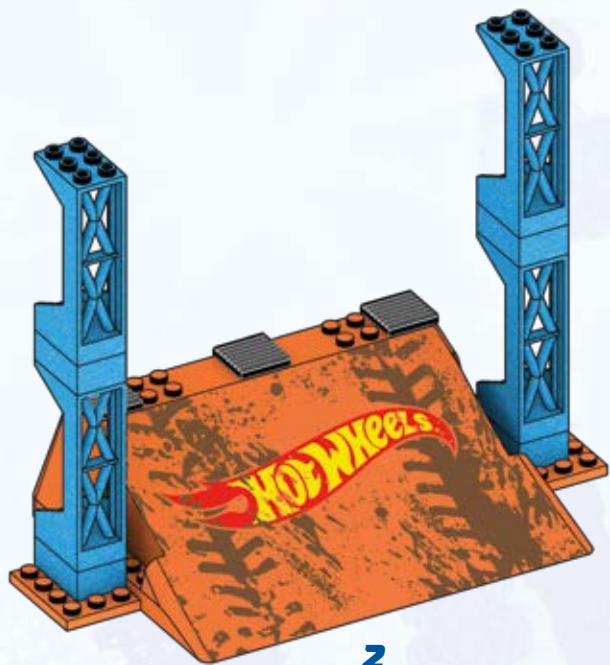

2

43

2x

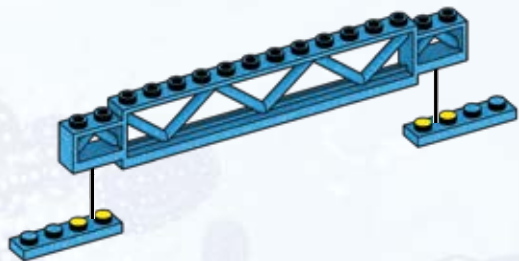

1x

**44**

2x



2x

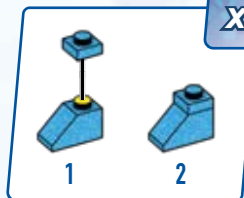

x2

1

2

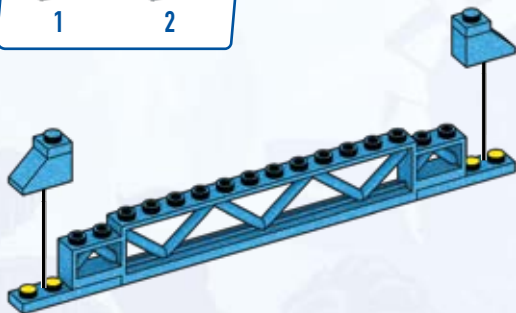

45



2x

46



8x

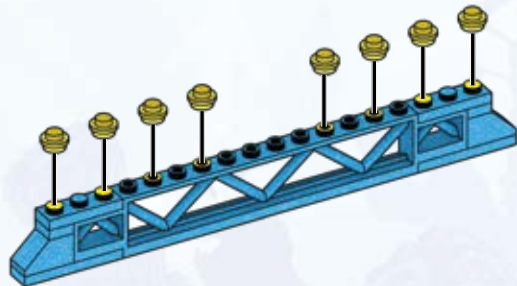
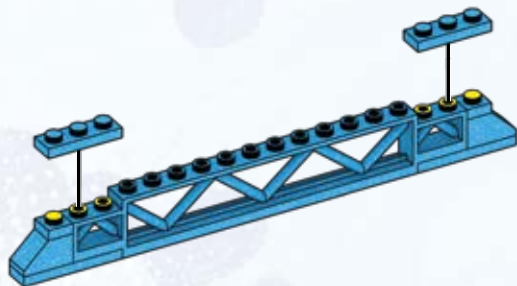

47



1x

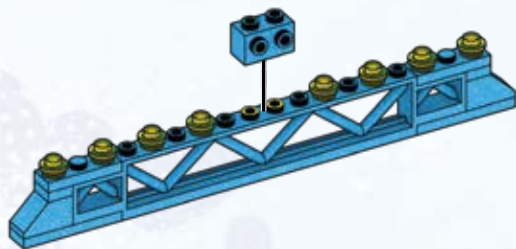

48



2x



1x

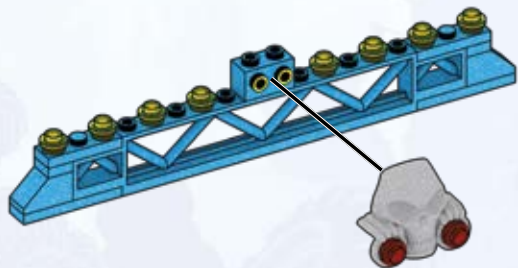
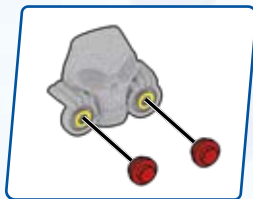

49

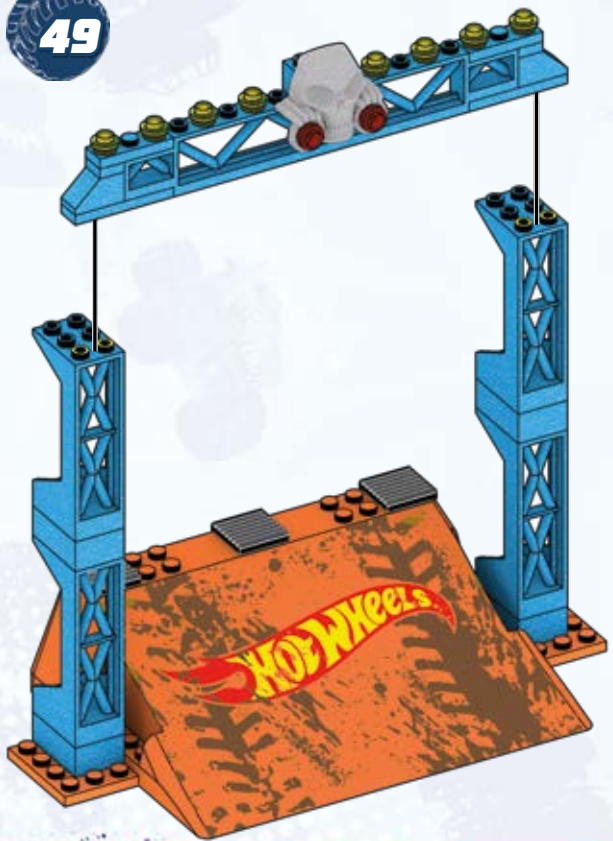

50

		
2x	2x	2x

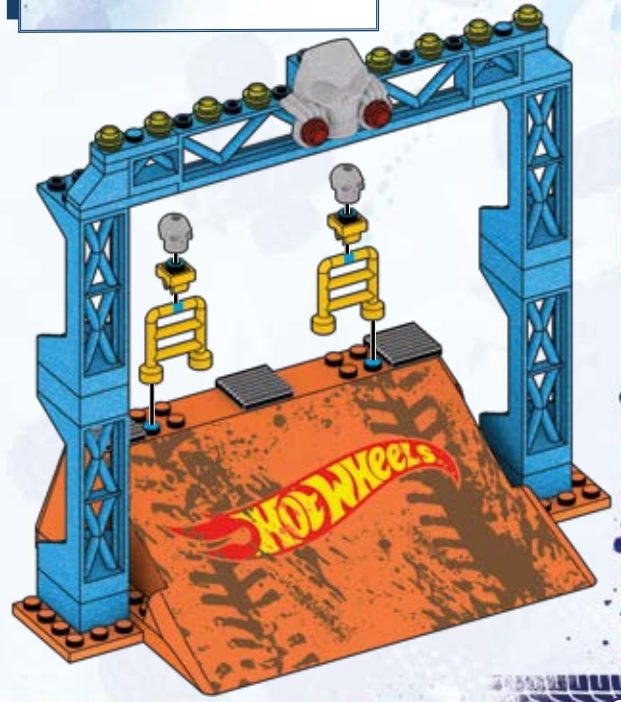

51



3x

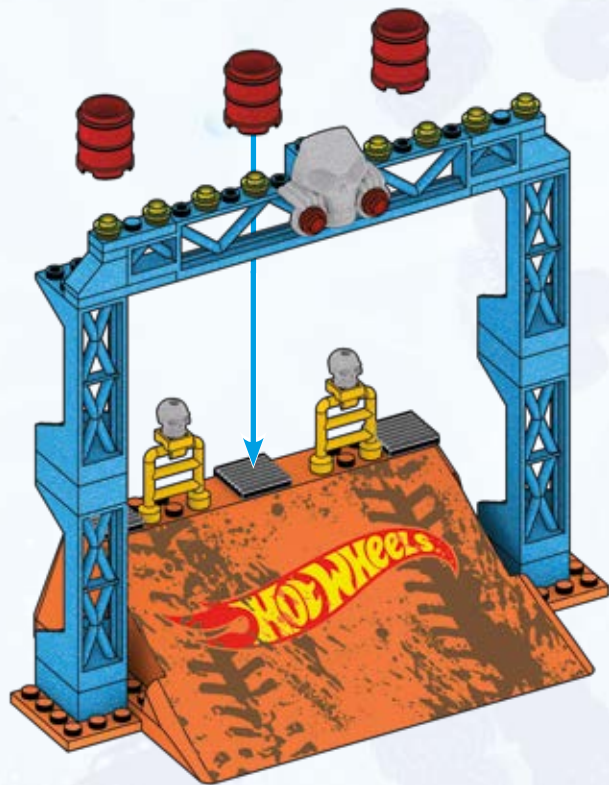

52



3x

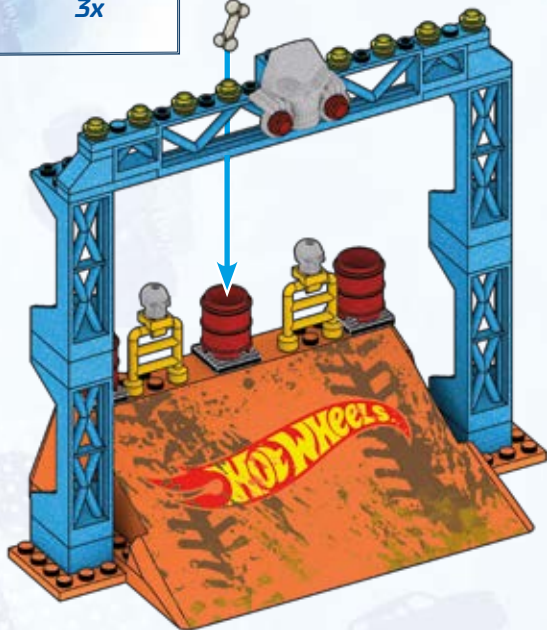

1

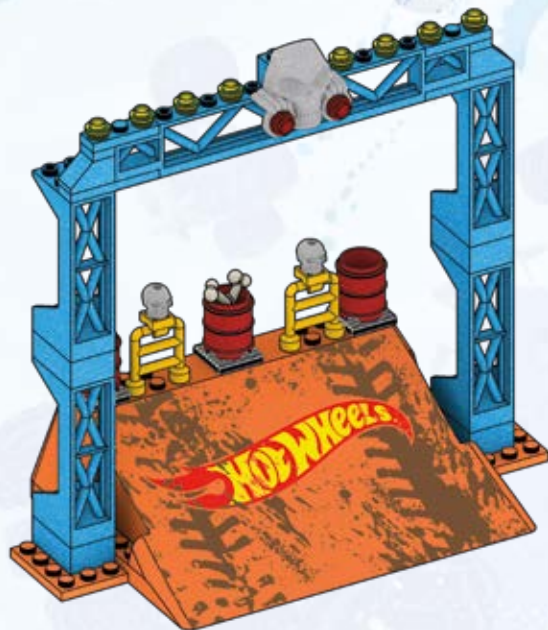

2



Bone Shaker™ Crush Course / Parcours Bone Shaker / Pista de choques de Bone Shaker / Circuito de Destruição Bone Shaker / Bone Shaker Salti Estremi / Bone Shaker Crash Set / Bone Shaker Kaskaderska sztuczka Zestaw / Bone Shaker Pletbaan / Игровой набор Bone Shaker / Bone Shaker Σετ / Bone Shaker Çarpışma Pisti / Bone Shaker törő-zúzó pályá / Bone Shaker kraschkurs / Bone Shaker Crush Course / Bone Shaker-knusebane / Bone Shaker-knusekurs / Závodní dráha autička Bone Shaker / Нарážacia dráha Bone Shaker / Bone Shaker ومسار التخطيم

**PULL BACK AND GO!
TIREZ LE VÉHICULE
VERS L'ARRIÈRE
ET PARTEZ !**



**61 cm
(24 in)**

**¡HAZLO RODAR HACIA ATRÁS Y SUÉLTALO!
PUXA PARA TRÁS PARA ARRANCAR!
ZURÜCKZIEHEN UND LOSS GEHT'S! ПОТЯНИ И ЗАПУСТИ!**

**HIT THE RAMP!
PRENEZ LA RAMPE !**



**¡SALTA POR LA RAMPA! • SOBRE A RAMPA!
AUF DIE RAMPE FAHREN! • ЗАЕЗЖАЙ ПО РАМПЕ!**

**HOOD POPS OFF!
LE CAPOT SAUTE !**



**¡EL CAPÓ SALE DESPEDIDO!
O CAPÓ SALTA!
DIE MOTORHAUBE ÖFFNET SICH!
КАПОТ ОТКРЫВАЕТСЯ!**



Warning: Do not aim at eyes or face. Only use projectiles supplied with this toy. Do not fire at point blank range.
Advertència: No apuntar a los ojos ni a la cara. Si adquirió un modelo con proyectil(es) incluido(s): Utilizar únicamente el(los) proyectil(es) incluido(s) en este juguete. No disparar a personas ni animales. No disparar a quemarropa.

ATTENTION : NE PAS VISER LES YEUX OU LE VISAGE. NE PAS UTILISER D'AUTRES PROJECTILES QUE CEUX FOURNIS AVEC CE JOUET. NE PAS TIRER À BOUT PORTANT.

ATENÇÃO!: NÃO APONTAR PARA OS OLHOS E PARA A FACE. NÃO UTILIZAR PROJÉTEIS DIFERENTES DOS PROVIDOS E DOS INDICADOS PELO FABRICANTE DO BRINQUEDO.

Avvertenza: Non mirare agli occhi o al viso. Usare solo i proiettili forniti con il giocattolo. Non sparare a distanza ravvicinata.
Achtung: Nicht auf Augen oder Gesicht zielen. Nur die zu diesem Spielzeug gehörenden Projektile verwenden. Nicht auf Menschen oder Tiere oder aus nächster Nähe zielen.

Ostrzeżenie: Nie celuj w oczy i twarz. Nie strzelaj pociskami innymi niż dostarczone z zabawką. Nie strzelaj z bliska.
Waarschuwing: niet op ogen of gezicht richten. Gebruik uitsluitend de bijgeleverde projectielen. Niet van te dichtbij afschieten.
Предупреждение: Не направляйте в глаза или лицо. Используйте только снаряды, входящие в комплект. Не стреляйте со слишком близкого расстояния.

Advarsel: Sigt ikke mod øjne eller ansigt. Brug kun de projektiler, som følger med legetøjet. Skyd ikke direkte på personer eller ting.
Varning: Sikta inte mot ögon eller ansikte. Använd endast projektiler som medföljer leksaken. Fyra inte av på mycket nära håll.
Advarsel: Du må ikke sikte mot øyne eller ansikt. Bruk bare prosjektilene som følger med leken. Ikke skyt på noe på kloss hold.
Varoitus: Älä tähtää silmiin äläkä kasvoihin. Käytä ainoastaan tämän tuotteen mukana tulleita ammuksia. Älä ammu lähietäisyydeltä.

Προσοχή: Μην στοχεύετε στα μάτια ή στο πρόσωπο. Χρησιμοποιείτε μόνο τα βλήματα που περιλαμβάνονται. Μην στοχεύετε όταν δεν έχετε ορατότητα.

Uyarı: Göze veya yüze nişan almayın. Fırlatmak için yalnızca bu oyuncakla birlikte verilen objeleri kullanın. İnsanlara ve hayvanlara nişan almayın.

Upozornění: Nemiřte na oči nebo na obličej. Používejte pouze projektily dodávané s touto hračkou. Nestřílejte z bezprostřední blízkosti.

Upozomenie: Nemierte do očí ani do tváre. Používajte iba strely dodané spolu s touto hračkou. Nestrieľajte z bezprostrednej blízkosti.

Figyelmeztetés: Tilos szemre és arcra célozni. Kizárólag a játékhoz mellékelt lövedékeket használja. A játékkal tilos közvetlen közélről löni.

警告: 目や顔に向けてのご使用、至近距離での発射はお控えください。このおもちゃの同梱物のみご使用ください。
تحذير: يجب عدم التصويب باتجاه العينين أو الوجه. يجب استخدام المقذوفات المزودة مع هذه اللعبة فقط. يجب عدم الإطلاق من مدى قريب.

警告: 请勿对着眼睛或脸部发射。仅使用本玩具自带的抛射物。请勿近距离射击。

4x
AM01113X



8x
AM01113ZD



4x
AM78219AXW



2x
AM77658APG



2x
AM76204APG



8x
AM74397APG



2x
AM03328AYP



4x
AM03328AYT



1x
AM80546AYT



2x
AM76058APG



1x
AM19530AYT



2x
AM18623BYE



2x
AM15485AYT



2x
AM76959AYT



4x
AM76767AXW



1x
AM81383AYT



3x
AM72973DD



2x
AM76469APG



2x
AM73758AYT



2x
AM07590KZ



1x
AM79246AYT



2x
AM09835AYT



1x
AS-HKF87-05



1x
AS-HKF87-08



3x
AM07228AYT



1x
AM81381AYT



1x
AM81382AYT



2x
AM01322AYP



1x
AM17502AYP



1x
AM80966AYT



7x
AM74298AYT



2x
AM01314AYP



2x
AM19326AYT



2x
AM16384AXW



1x
AM16384KZ



1x
AS-HKF87-04



1x
AS-HKF87-07



2x
AM15484AYT



1x
AM03773AYT



3x
AM81476AYT



2x
AM81636APG



3x
AM15064AXW



2x
AM03514BYE



3x
AM03772AYT



1x
AM81688AYT



4x
AM03873AYP



2x
AM09593AYP



2x
AM81640AMC



2x
AM09593AYT



2x
AM17503AYT



2x
AM07475AYT



2x
AM80965AYT





1x
AS-HKF87-06



1x
AS-HKF87-09



4x
AM06618AYP



2x
AM81163AXW



1x
AM72025AYT



2x
AM17054B0R



1x
AM80974APG



1x
AM81638APG



2x
AS-HKF87-02



2x
AS-HKF87-03



1x
AM81331AXW



1x
AS-HKF87-01

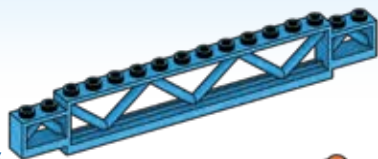

1x
AM09245AYP



1x
AS-HKF87-10



1x
AM80855MCX



1x
AM80975AXW

Missing pieces? • Pièces manquantes?

¿Partes faltantes? • Perdeu peças?
Fehlen Teile? • Не хватает деталей?

support.megabrand.com



1x
FIG-HKF87-A



ATTENTION : DANGER
D'ÉTOUFFEMENT. - PRÉSENCE DE PETITS
ÉLÉMENTS. NE CONVIENT PAS AUX ENFANTS DE
MOINS DE 3 ANS.

ATENÇÃO! NÃO INDICADO / NÃO
RECOMENDÁVEL PARA CRIANÇAS MENORES DE 3
(TRÊS) ANOS POR CONTER PARTE(S) PEQUENA(S)
QUE PODE(M) SER ENGOLIDA(S) OU ASPIRADA(S)
PODENDO PROVOCAR ASFIXIA.

警告:

のどにつまる危険 小さな部品が含まれています
3歳以下の子供には与えないで下さい。

警告!
不适合3岁以下儿童使用。
内含小零件。

WARNING : CHOKING HAZARD. - Small parts. Not for children under 3 years.
ADVERTENCIA : PELIGRO DE ATRAGANTAMIENTO. Juguete no recomendado
para menores de 3 años, porque contiene piezas pequeñas que podrían
provocar asfixia en caso de ser ingeridas o inhaladas por el/la niño/a.
AVVERTENZA : Contiene pezzi di piccole dimensioni.

ACHTUNG : Kleine Teile.

OSTRZEŻENIE : Małe części. Niebezpieczeństwo zadławienia.

WAARSCHUWING : Kleine onderdelen

ПРЕДУПРЕЖДЕНИЕ : Мелкие детали.

ADVARSEL : Indeholder små dele.

VARNING : Smådelar

ADVARSEL : Små deler

VAROITUS : Pieniä osia

ΠΡΟΣΟΧΗ : Περιλαμβάνονται μικρά κομμάτια.

UVARI : Kùcùk parçalar.

UPOZORNĚNÍ : Malé díly

UPOZORNENIE : Malé časti

FIGYELMEZTETÉS : Kis alkatrészek.



تحذير:

غير مناسبة للأطفال دون 36 شهراً - قطع صغيرة.

Mattel Europa B.V., Gondel 1, 1186 MJ Amstelveen, Nederland. Mattel U.K. Limited, The Porter Building, 1 Brunel Way, Slough SL1 1FQ, UK. Mattel France, Parc de la Cerisaie, 1/3/5 allée des Fleurs, 94260 Fresnes Cedex. N° Cristal 0969 36 99 99 (Numéro non surtaxé) ou www.lesjouetsmattel.fr Mattel Belgium, Trade Mart, Atomiumsquare, Bogota 202 - B 275, 1020 Brussels. Gratis nummer België: 0800 - 16 936 - Gratis nummer Luxemburg: 800 - 262 784 - Gratis nummer Nederland: 0800 - 262 88 35. Deutschland : Mattel GmbH, Solmsstraße 4, D-60486 Frankfurt am Main. Schweiz: Mattel AG, Kirchstrasse 24, CH-3097 Liebefeld. Österreich: Mattel Ges.m.b.H., Campus 21, Liebermannstraße A01 404, A- 2345 Brunn/Gebirge. Mattel Italy Srl, Via Bracco, 6-MAC 6, 20159 Milano, Italy. Servizio assistenza clienti: Customersrv.italia@mattel.com - Numero verde 800 11 37 11. Mattel España, S.A., Aribau 200.08036 Barcelona. cservice.spain@mattel.com. Tel: 900 102 390 http://www.service.mattel.com/es. Mattel East Asia Ltd., Room 503-09, North Tower, World Finance Centre, Harbour City, Tsimshatsui, HK, China. Tel: (852) 3185-6500. Diiimport & Diederkan Oleh: Mattel Continental Asia Sdn Bhd. Level 19, Tower 3, Avenue 7, No. 8 Jalan Kerinci, Bangsar South, 59200 Kuala Lumpur, Malaysia. Mattel South Africa (PTY) LTD, Office 102 B, 30 Melrose Boulevard, Johannesburg 2196. Dystrybutor: Mattel Poland Sp. z o.o., Warsaw Trade Tower 34 p., ul. Chłodna 51, 00-867 Warszawa. Mattel Australia Pty Ltd., 658 Church St., Richmond, Victoria, 3121. Consumer Advisory Service - 1300 135 312. Mattel AEBE, Εθνικού Μακρολίου 1, Κτήριο Κ-2, ΤΚ 17561, Πολυάτο Όφελη. Mattel Oynuncakçılık Tic. Ltd. Şti. İerenkü Mah., Erkit Sok. A Blok No:12 Üner Plaza Kat:9-10 34752 Ataşehir İstanbul. Tel: 0216 570 75 00. Импортёр/Уполномоченная организация: ООО "МАТТЕЛ" Российская Федерация, 105120 Москва, 2-й Сыроматинский переулок, 1; +7 495 287 79 39. Mattel Czech Republic s.r.o., The Forum, Václavské nám. 19, 11000 Praha 1. Mattel, 333 Continental Boulevard, El Segundo, CA 90245, USA. Mattel Canada Inc., Mississauga, Ontario L5R 3W2. Consumer Services: You may call us free at / Composez sans frais le 1-800-524-8697. Importado y distribuido por Mattel de México, S.A. de CV, Miguel de Cervantes Saavedra No. 193, Pisos 10 y 11, Col. Granada, Alcaidía Miguel Hidalgo, C.P. 11520, México, Ciudad de México. R.F.C. MME-920701-NB3. Tels: 59-05-51-00 Ext. 5206 ó 01-800-463-59-89. Mattel Chile, S.A., Avenida Americo Vesputcio 501-B, Quilicura, Santiago. Tel: 1230-020-6213. Servicio al consumidor Venezuela: Tel: 0-800-100-9123. Mattel Argentina, S.A., Av. Libertador 1000, Piso 11 - Oficinas 109 y 111, Vicente López - Prov. Buenos Aires. Tel: 0800-666-3373. Mattel Colombia, S.A., Calle 12347-07 P5, Bogotá. Tel: 01800-710-2069. Mattel Perú, S.A., Av. Juan de Arona n° 151, Centro Empresarial Juan de Arona, Torre C, Piso 7, Oficina 704, San Isidro, Lima 27, Perú. RUC: 20425853865. Reg. Importador: 02350-12-JUE-DIGESA. Tel: 0800-54744. E-mail Latinoamérica: servicio.clientes@mattel.com. Mattel do Brasil Ltda. - CNPJ : 54.558.002/0001-20 - Rua Verbo Divino, 1488 - 2º. Andar - 04719-904 - Chácara Santo Antônio - São Paulo - SP - Brasil. Serviço de Atendimento ao Consumidor: fone 0800 575 0780. E-mail: sac.matteldobrazil@mattel.com

BUILD YOUR WAY CONSTRUIS TON UNIVERS



HMM49



HKF88



HKF87

Crea tu camino | Constrói à tua maneira
Bauen, wie es dir gefällt! | Построй мир гонок

Set(s) sold separately and subject to availability. / Ensemble(s) vendu(s) séparément. Certains produits peuvent ne pas être commercialisés. / Se vende(n) por separado y está(n) sujeto(s) a disponibilidad. / Conjunto(s) vendido(s) em separado e sujeito(s) à disponibilidade. / Set in vendita separatamente, secondo disponibilità. / Das/Die Set(s) sind separat erhältlich. / Zestaw(y) sprzedawany(e) oddzielnie w zależności od dostępności. / Set(s) apart verkrijgbaar en afhankelijk van beschikbaarheid. / Набор(ы) продается(ются) отдельно, при наличии. / Sæt sælges separat og så længe lager haves. / Seten säljs separat så länge lagret räcker. / Settet/settene selges separat så langt lagret rekker. / Pakkaus/pakkausset myydään erikseen, saatavuus voi vaihdella. / Το(α) σετ πωλούνται ξεχωριστά και ανάλογα με τη διαθεσιμότητα. / Setler ayrı olarak satılır ve stoklarla sınırlıdır. / Set (setk) se prodává (prodávají) samostatně dle aktuální nabídky. / Súprava/-y sa predáva(jú) samostatne a podľa dostupnosti. / A készlet(ek) külön kapható(k), az elérhetőség változhat. /

セット商品は別売りになります。在庫状況は別途ご確認ください。 / 每套单独发售，按供货情况决定。

Mattel Canada Inc. Mississauga, Ontario L5R 3W2.
MADE IN CHINA. FABRIQUÉ EN CHINE. FABRICADO NA / HECHO EN CHINA.
ИЗГОТОВЛЕНО В КИТАЕ. ÇİN'DE ÜRETİLMİŞTİR. صنع في الصين

©2022 MEGA Brands &™ MEGA Brands.
Printed in China / Imprimé en Chine

AD-HKF87-01A

1186 MJ, 1 NL
© D714,887, D809,611



HOT WHEELS™ and associated trademarks and trade dress are owned by, and used under license from, Mattel. ©2022 Mattel.

