



HHL99

MUSCLE BOUND™



Tyler Charest is a university-trained Transportation Designer with experience in consumer centered design thinking. During his time with Hot Wheels, he has designed a variety of die-cast vehicles for the Basic, Character Car and Monster Truck lines and has also worked on a number of high-profile RC vehicles.

Titulaire d'un diplôme universitaire, Tyler Charest est designer de véhicules et possède de l'expérience en conception créative, une approche centrée sur les clients. Tout au long de sa carrière chez Hot Wheels, il a conçu de nombreux modèles de véhicules en métal pour les gammes classiques, Character Car et Monster Truck, et a également participé à la création de certains véhicules télécommandés haut de gamme.

Tyler Charest es un diseñador de medios de transporte con formación universitaria y experiencia en crear diseños centrados en el consumidor. Durante su paso por Hot Wheels, ha diseñado vehículos metálicos muy variados para las líneas Básica, Coches de personajes y Monster Truck y, además, ha trabajado en una serie de vehículos teledirigidos muy popular.

Tyler Charest é um Designer de Transporte com formação universitária e experiência em “design thinking” focado no consumidor. Durante o tempo em que trabalhou com a Hot Wheels, concebeu uma variedade de veículos metalizados para as linhas Basic, Character Car e Monster Truck, e contribuiu para criação de inúmeros veículos telecomandados de alto nível.

Tyler Charest ist ein an der Universität ausgebildeter Transportmittelentwickler mit Erfahrung in verbraucherbezogenem Designdenken. Während seiner Zeit bei Hot Wheels hat er zahlreiche Die-Cast-Fahrzeuge für verschiedene Serien wie der der Charakterfahrzeuge und Monster Trucks entworfen. Außerdem hat er an verschiedenen bekannten ferngesteuerten Fahrzeugen gearbeitet.

Тайлер Чарест (Tyler Charest) — дипломированный специалист, разработчик транспортных средств со опытом проектирования, ориентированного на потребителя. За время работы в Hot Wheels он спроектировал множество литых машинок для линеек Basic, Character Car и Monster Truck, а также работал над созданием нескольких радиоуправляемых моделей.

BUILDING TOOL OUTIL DE CONSTRUCTION

HERRAMIENTA DE CONSTRUCCIÓN
BAUWERKZEUG
FERRAMENTA DE MONTAGEM
ИНСТРУМЕНТ ДЛЯ КОНСТРУИРОВАНИЯ

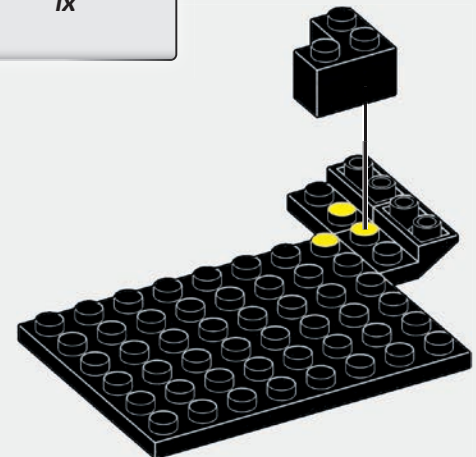
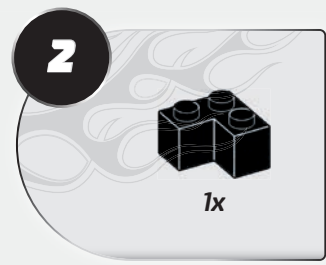
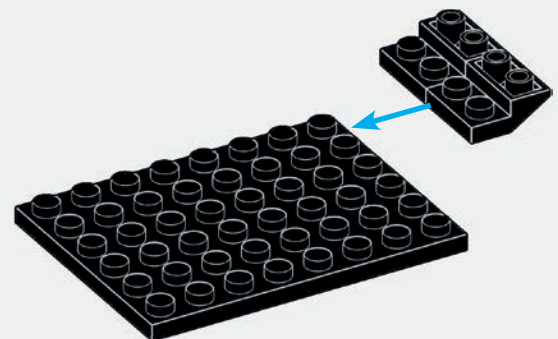
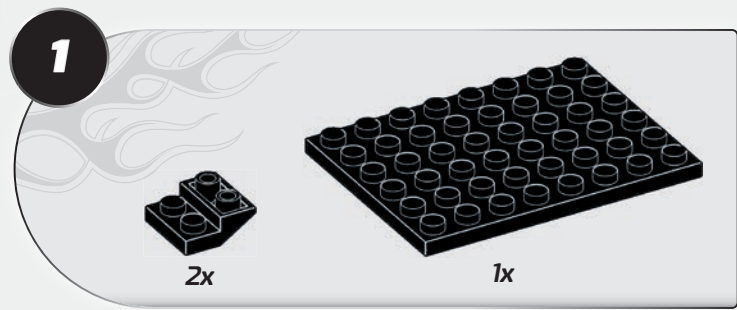
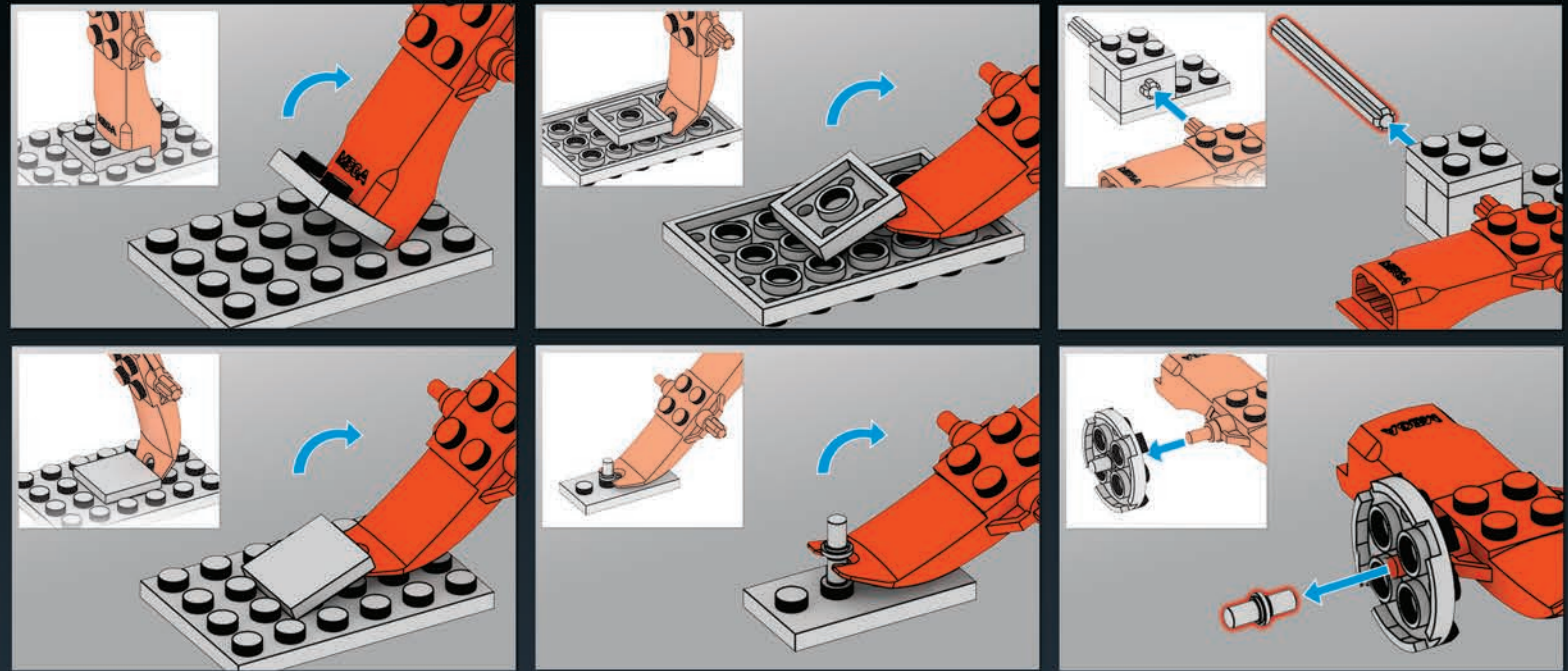

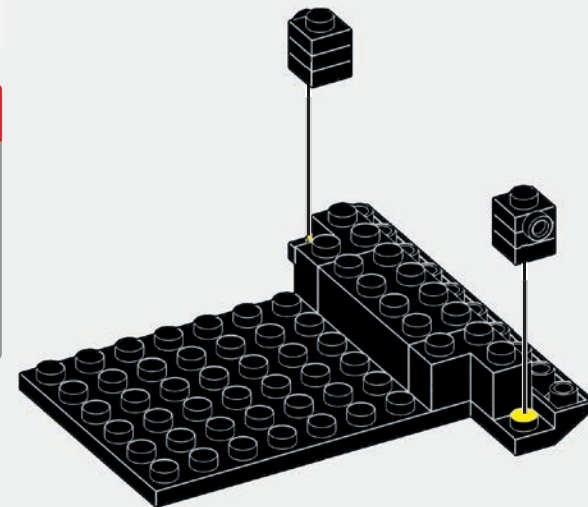
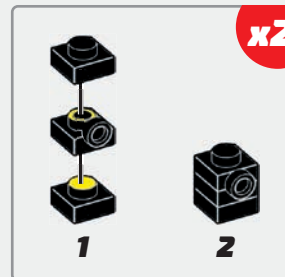
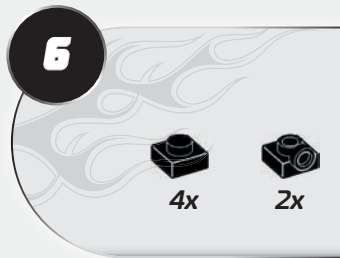
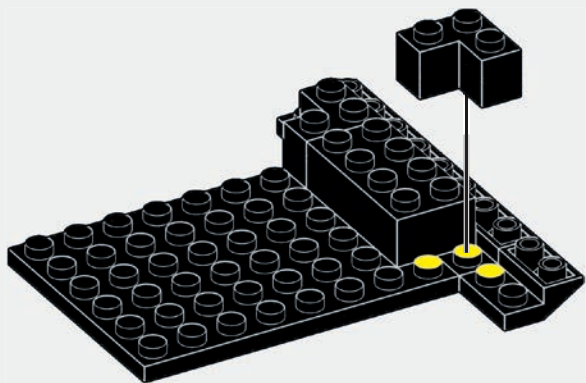
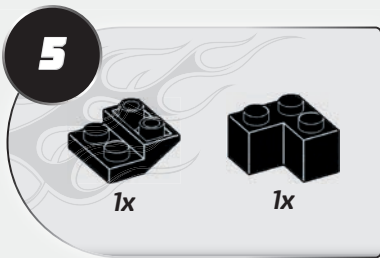
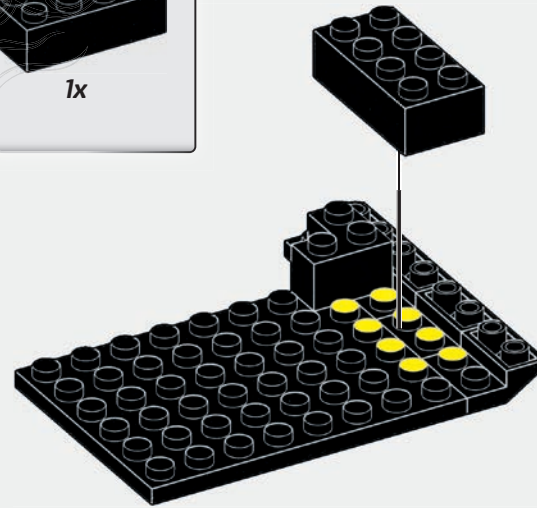
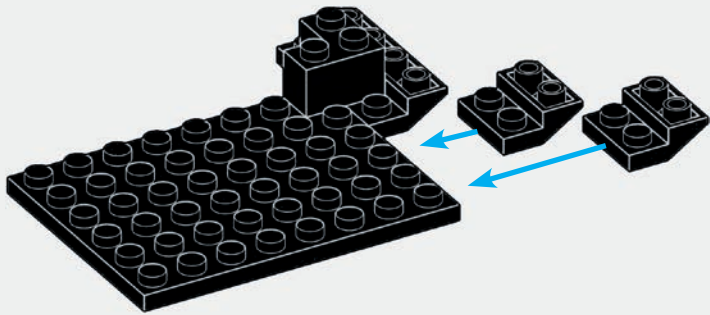

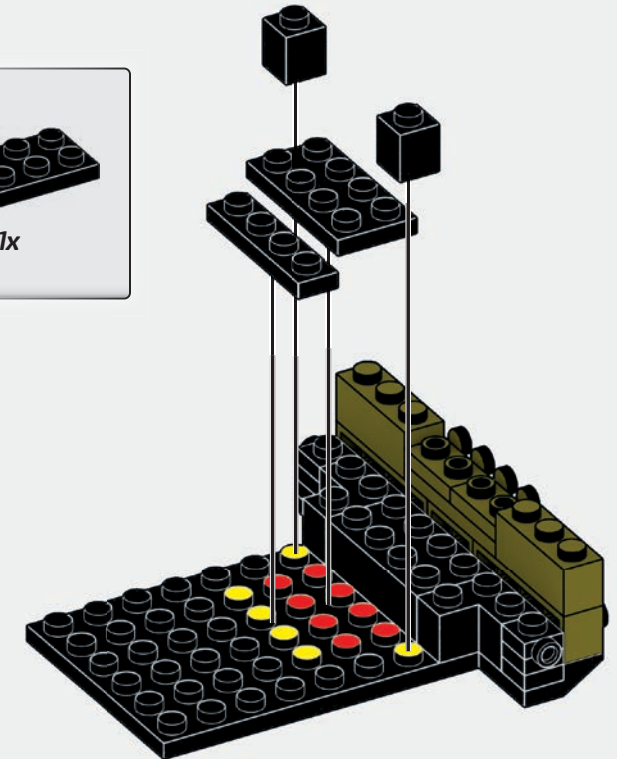
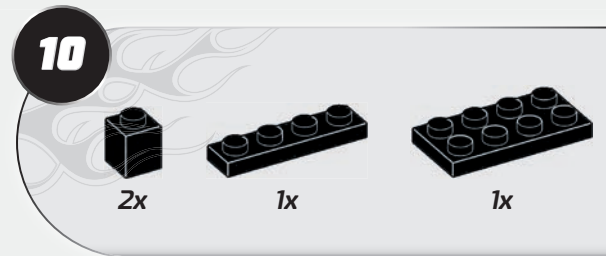
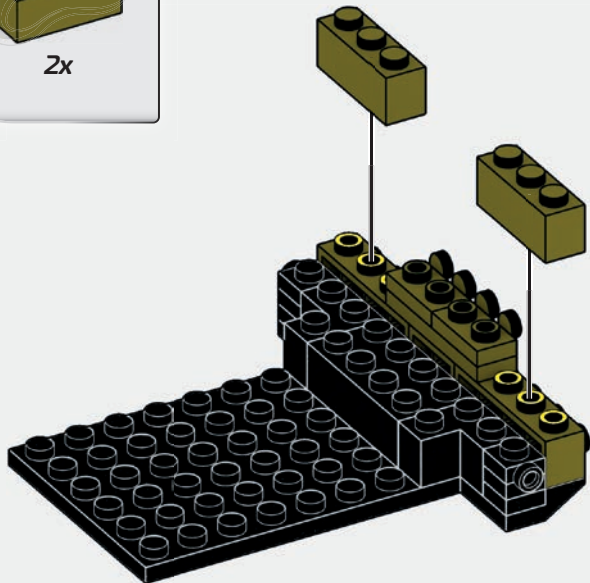
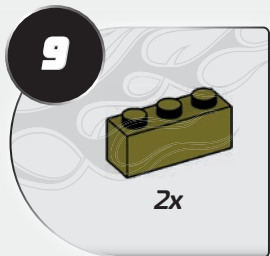
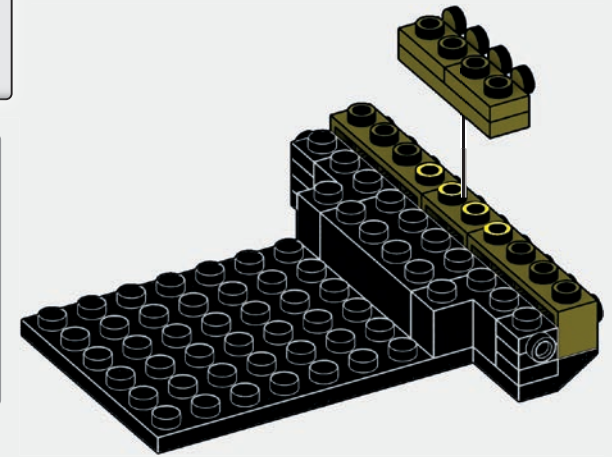
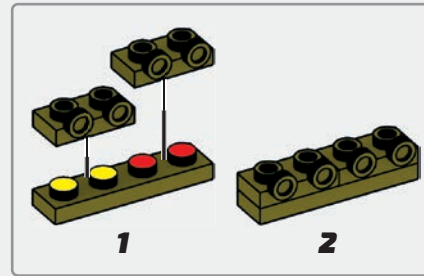
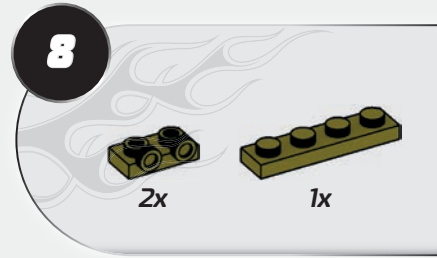
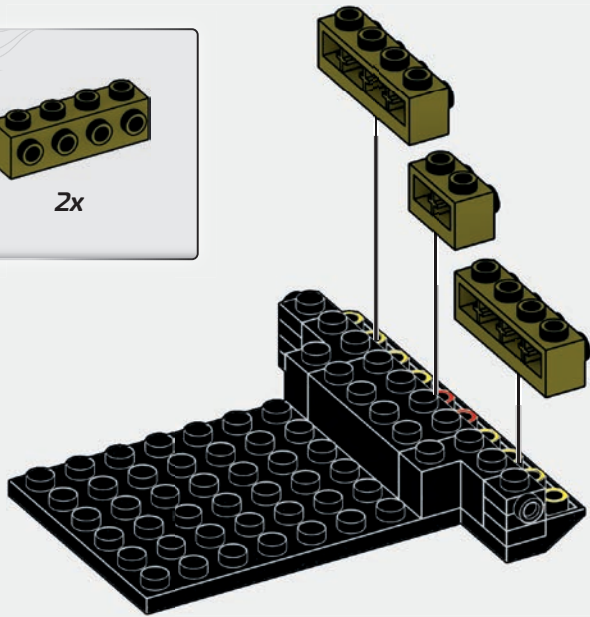
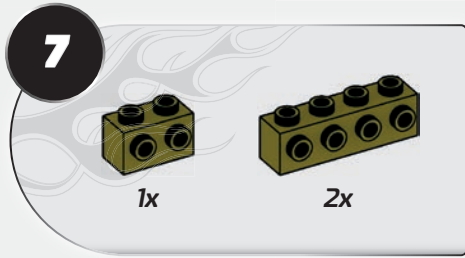

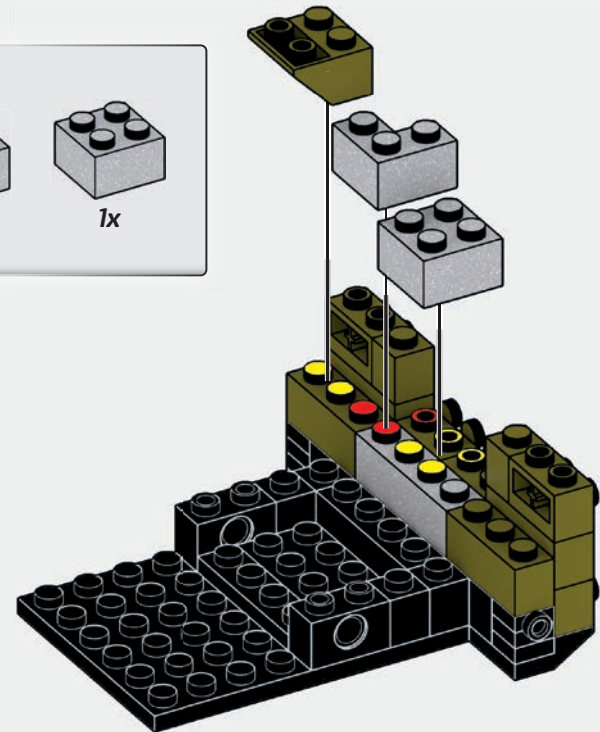
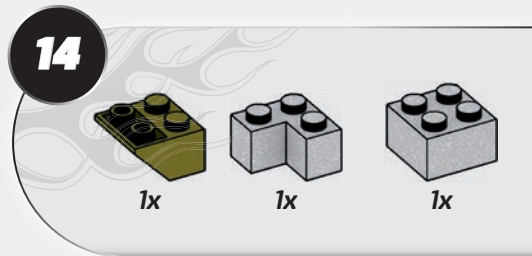
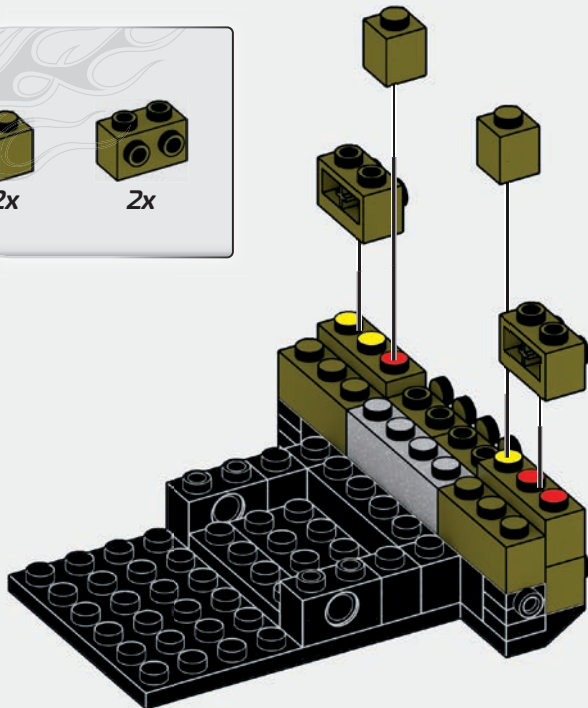
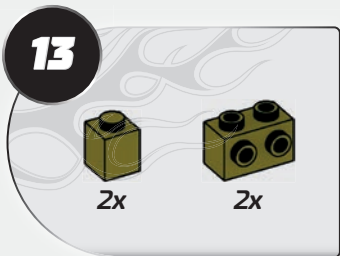
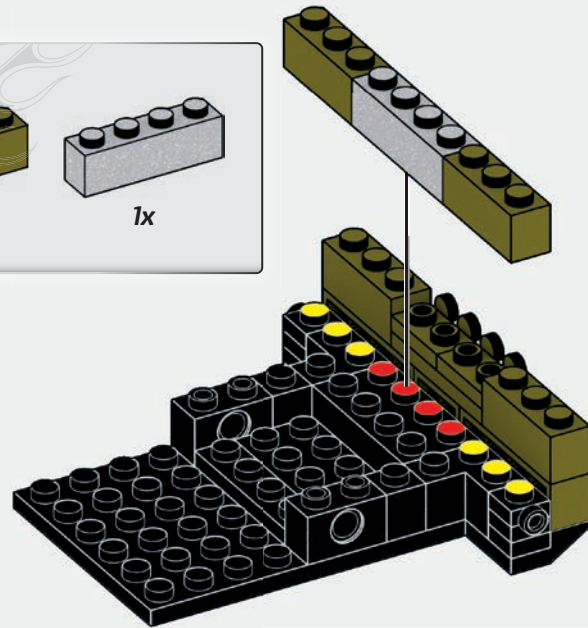
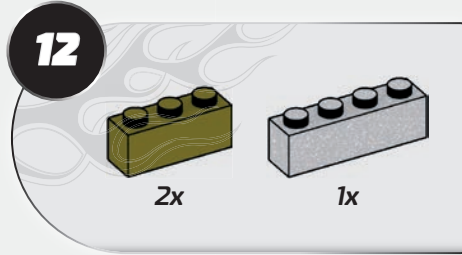
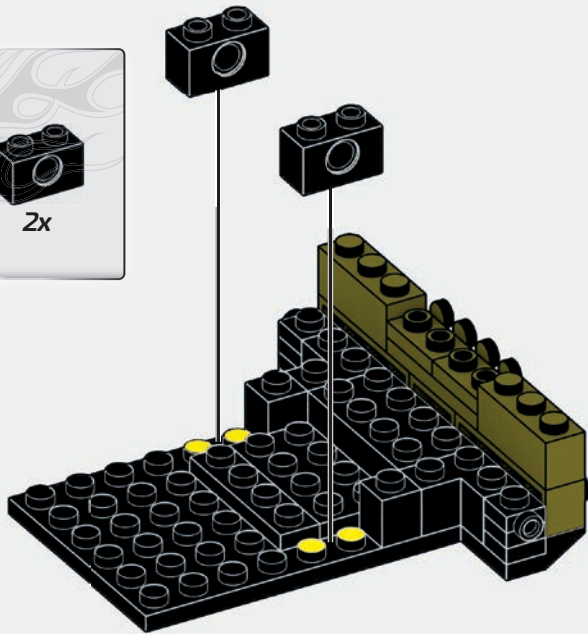

15

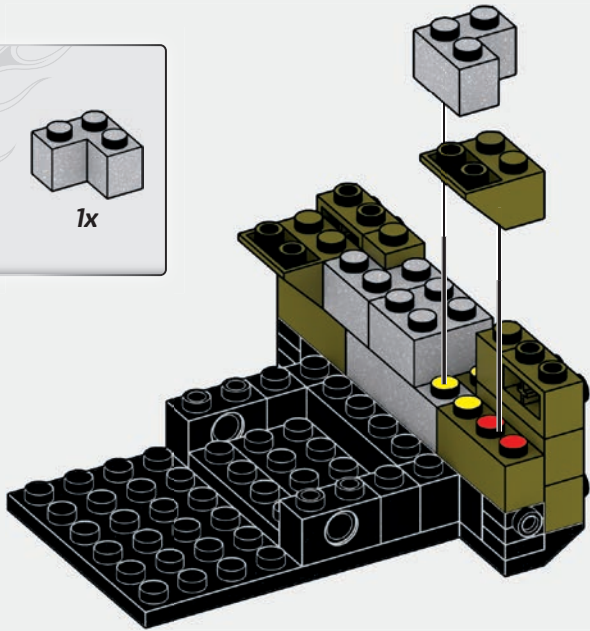
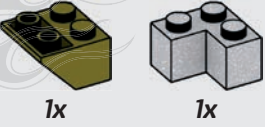

16

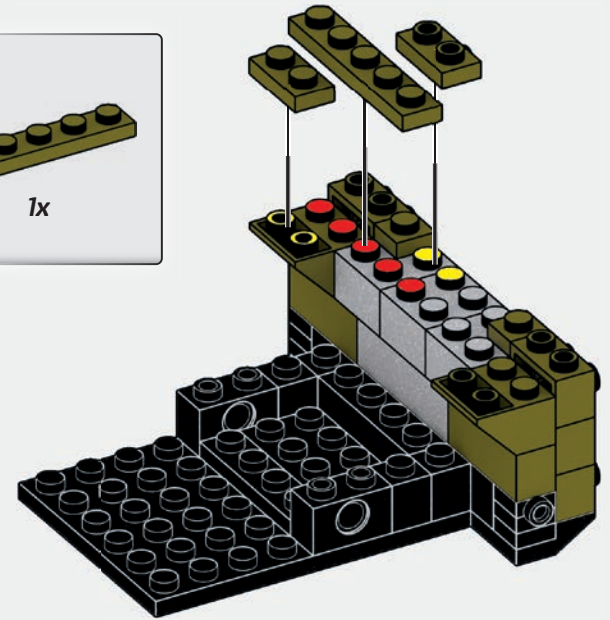
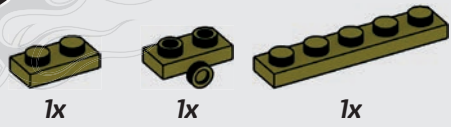

17

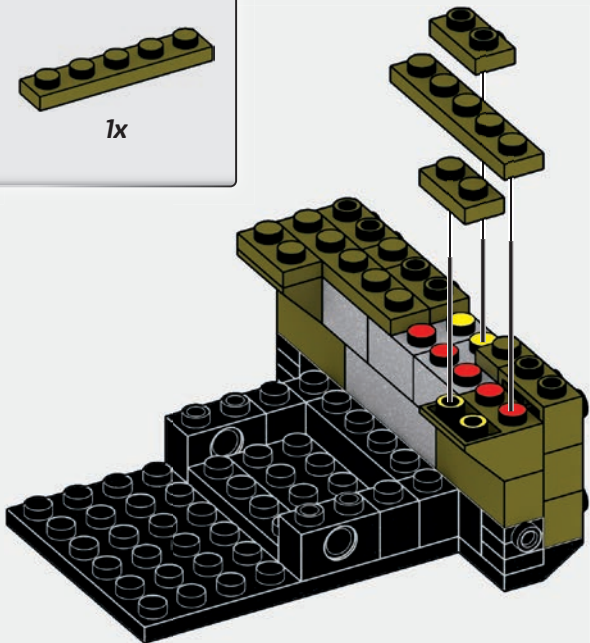
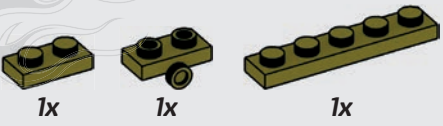

18

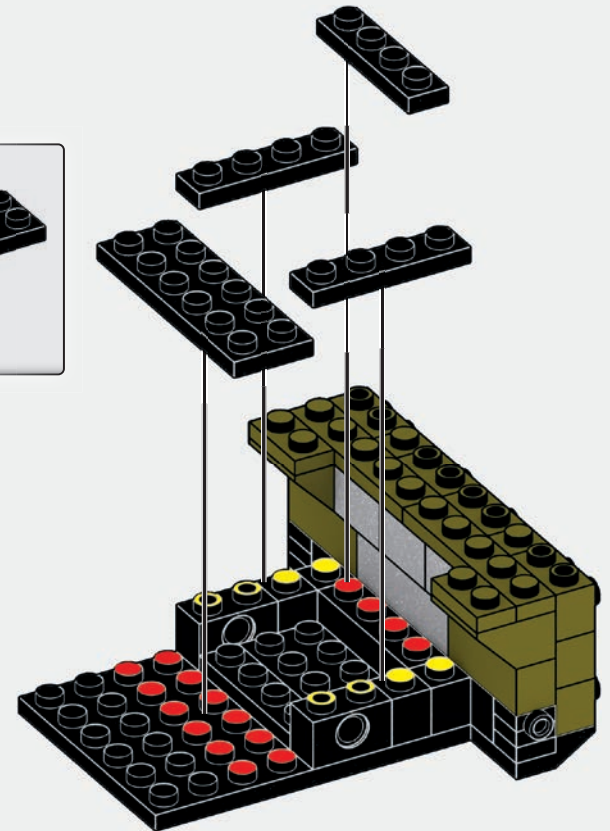
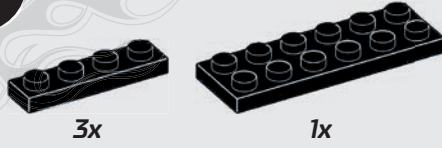

19



2x

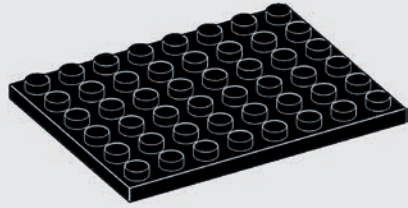

1x

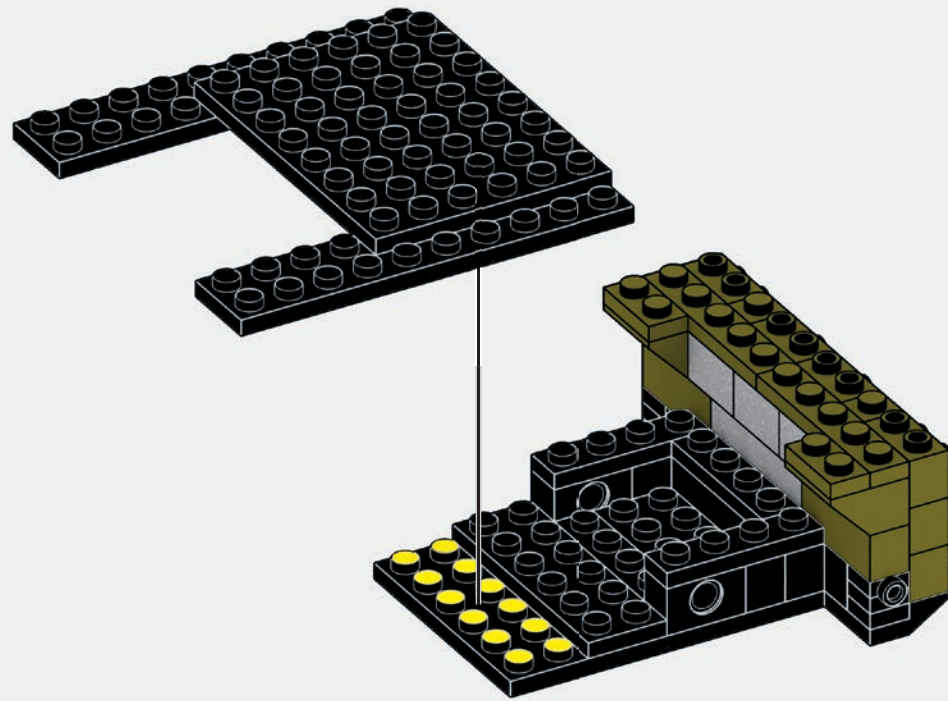
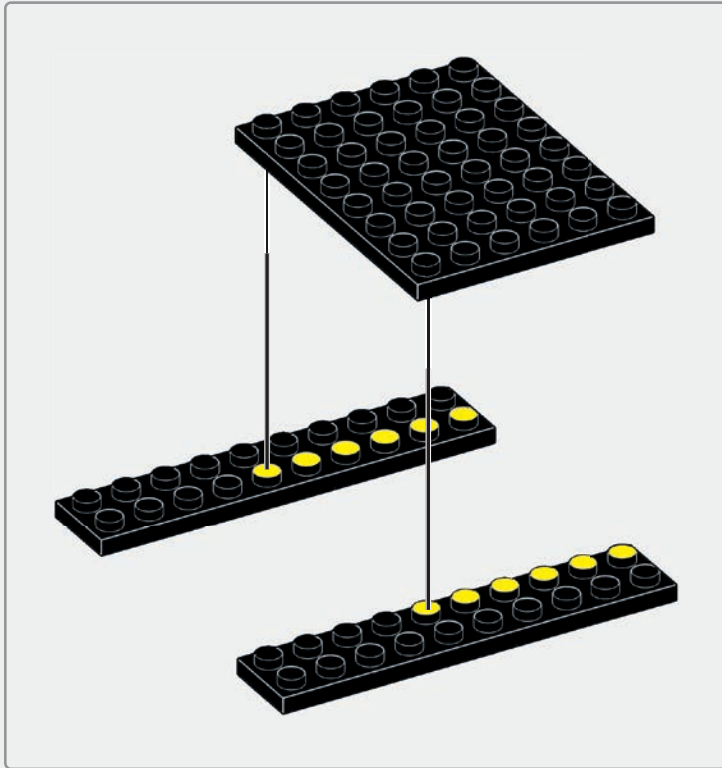

20

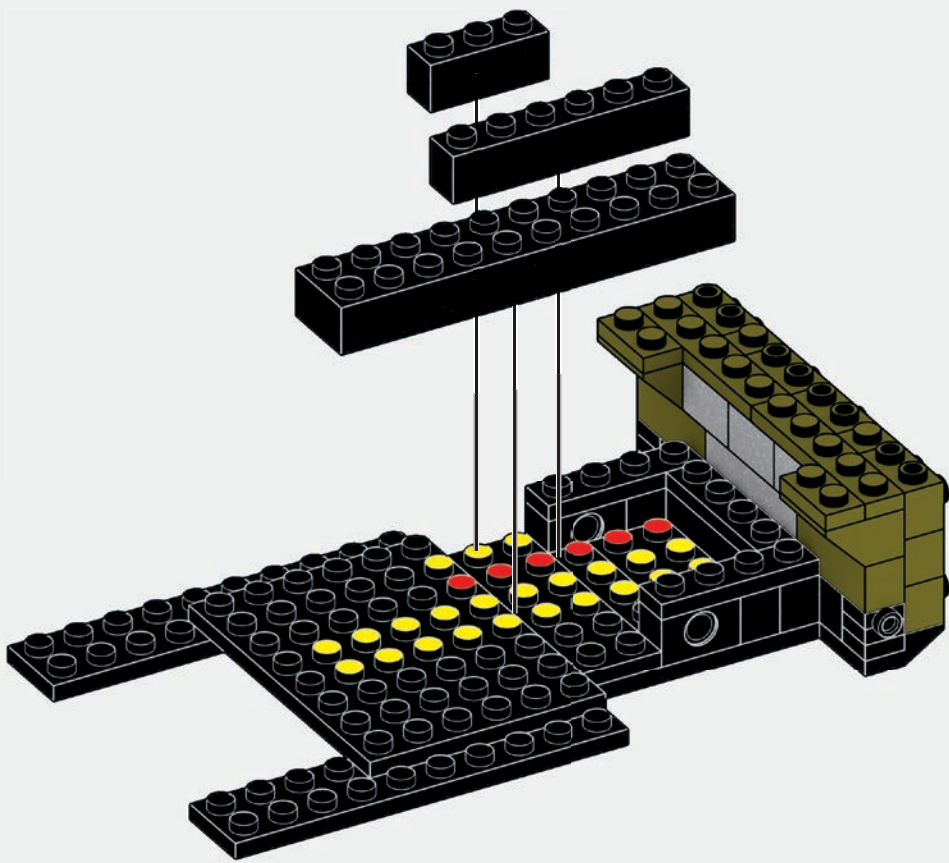
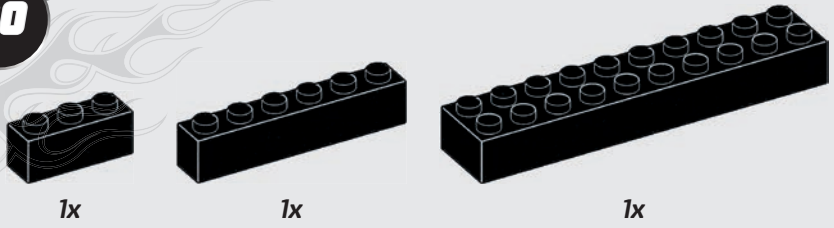

21

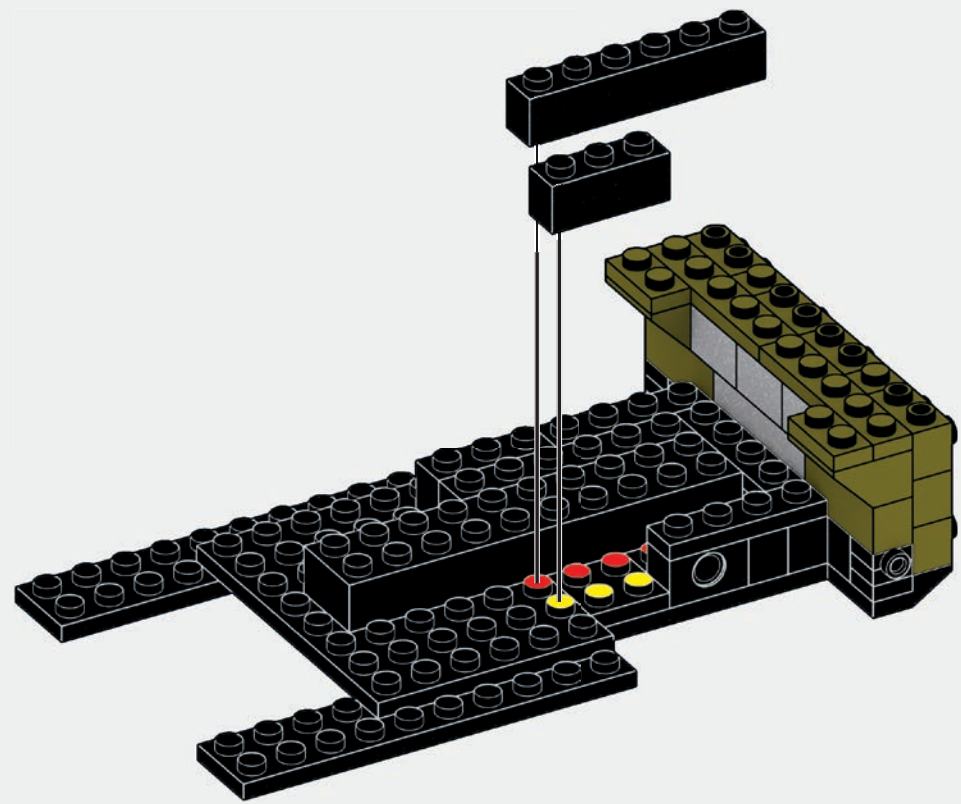
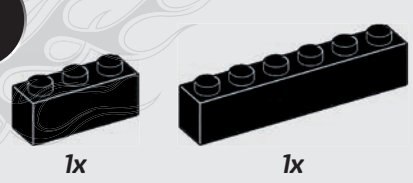

22



5x

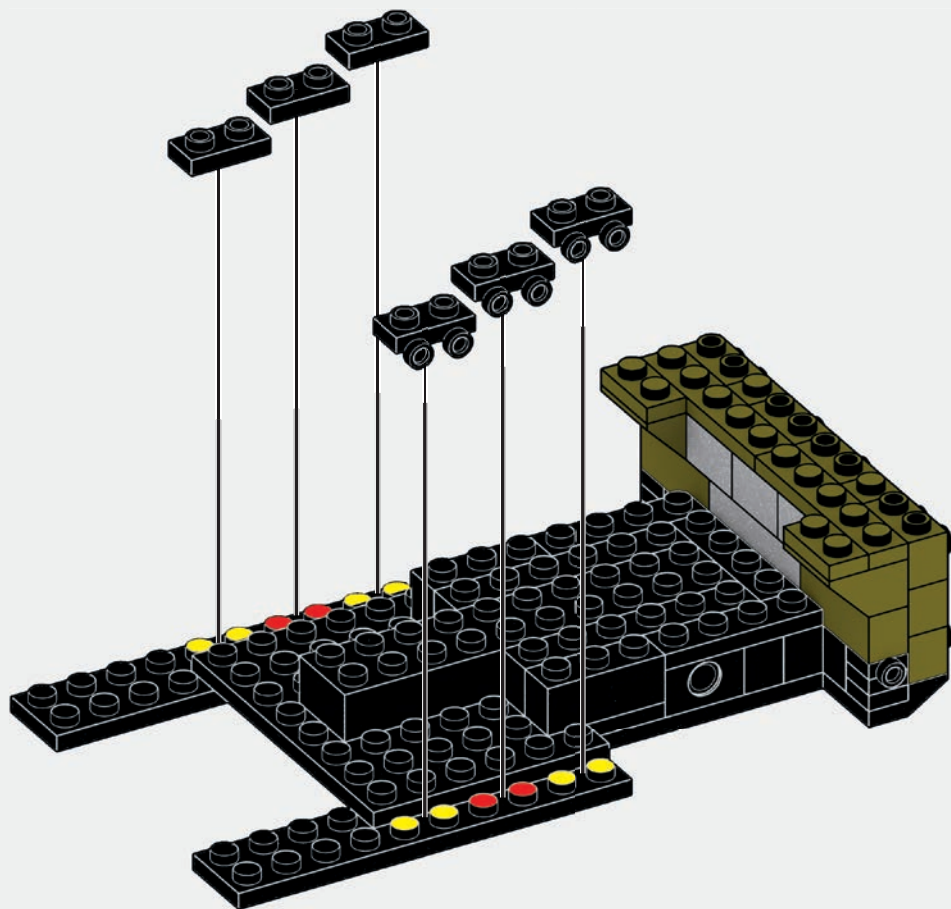

23



2x

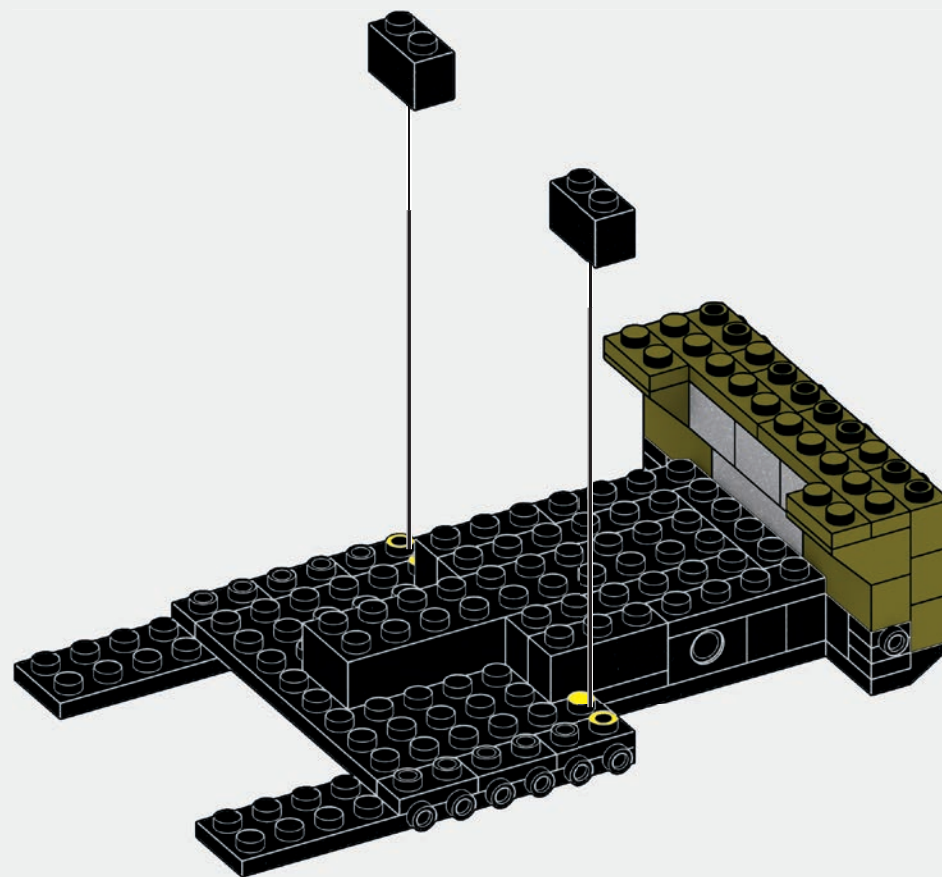

24



1x



2x



1x

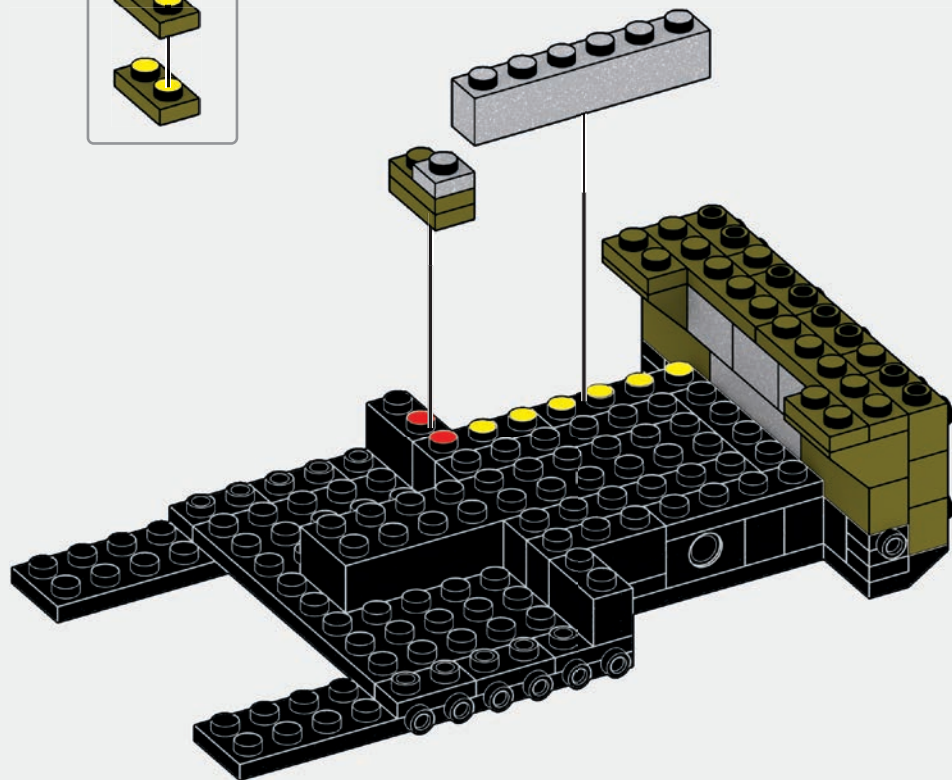
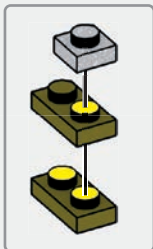

1

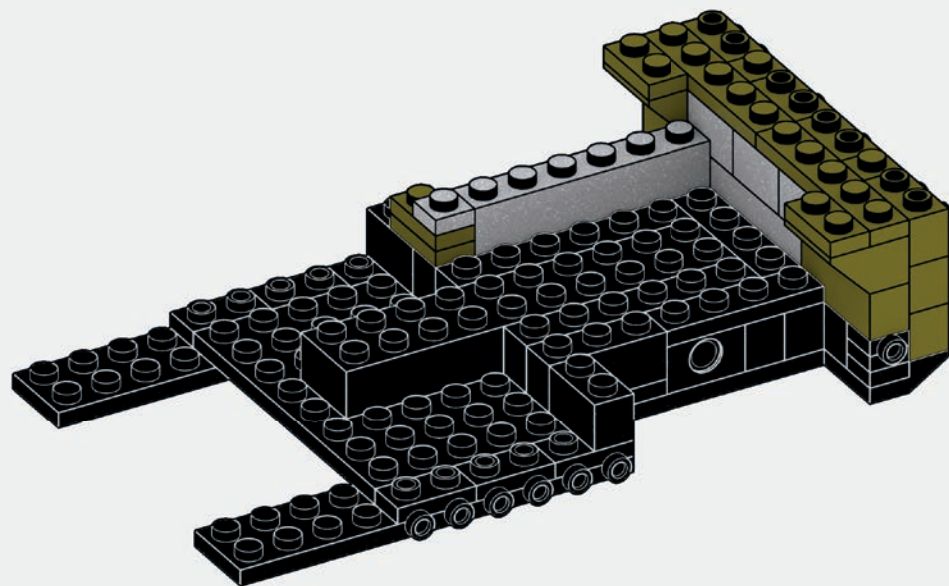

2

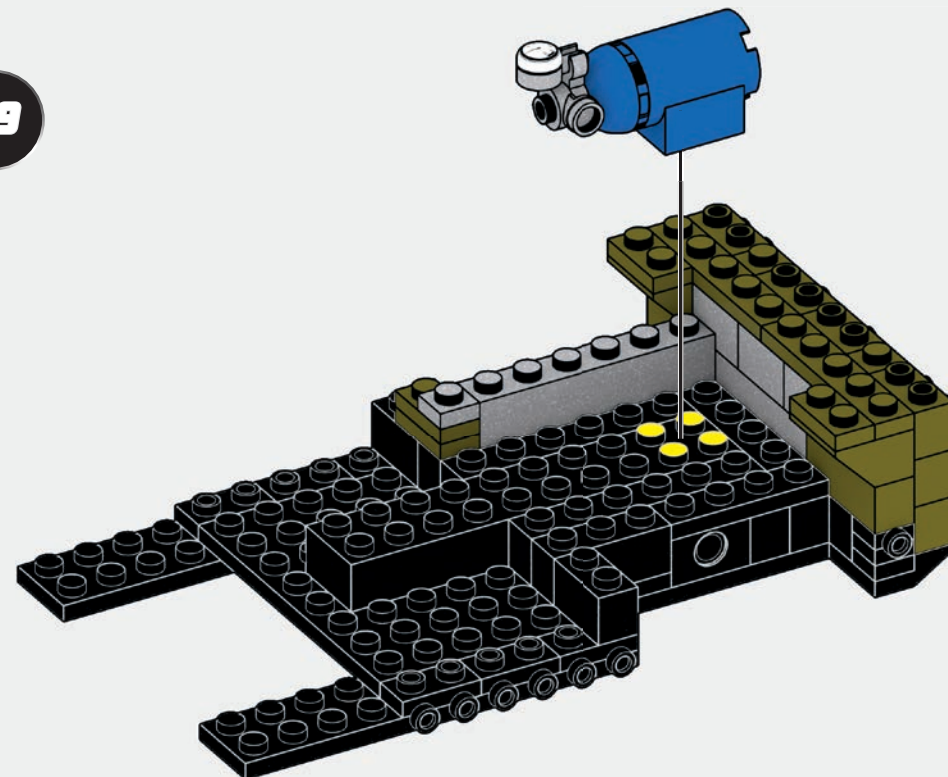
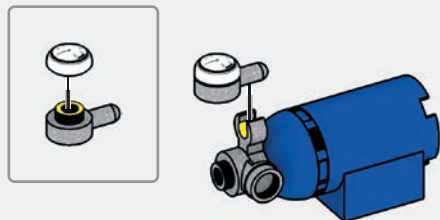
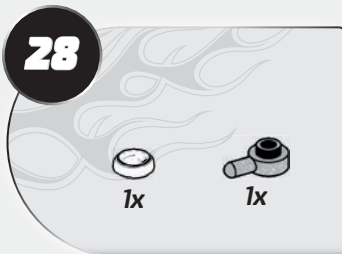
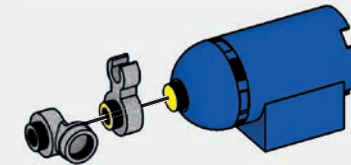
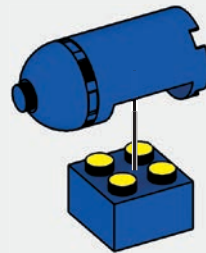
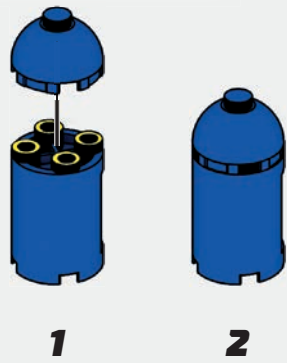
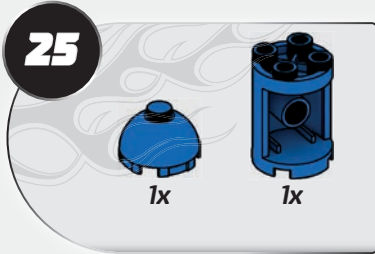

30

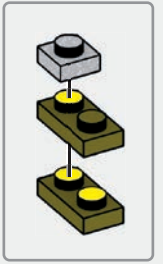
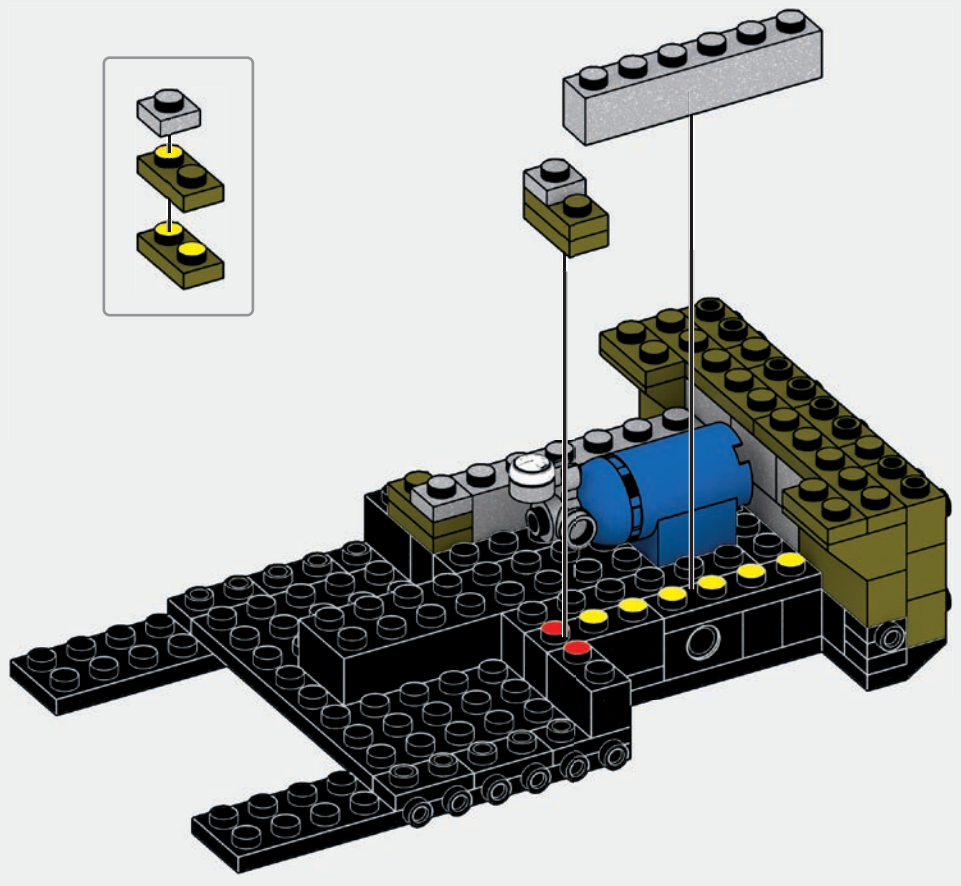
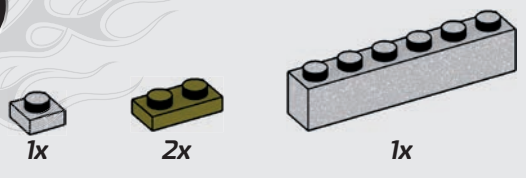

31

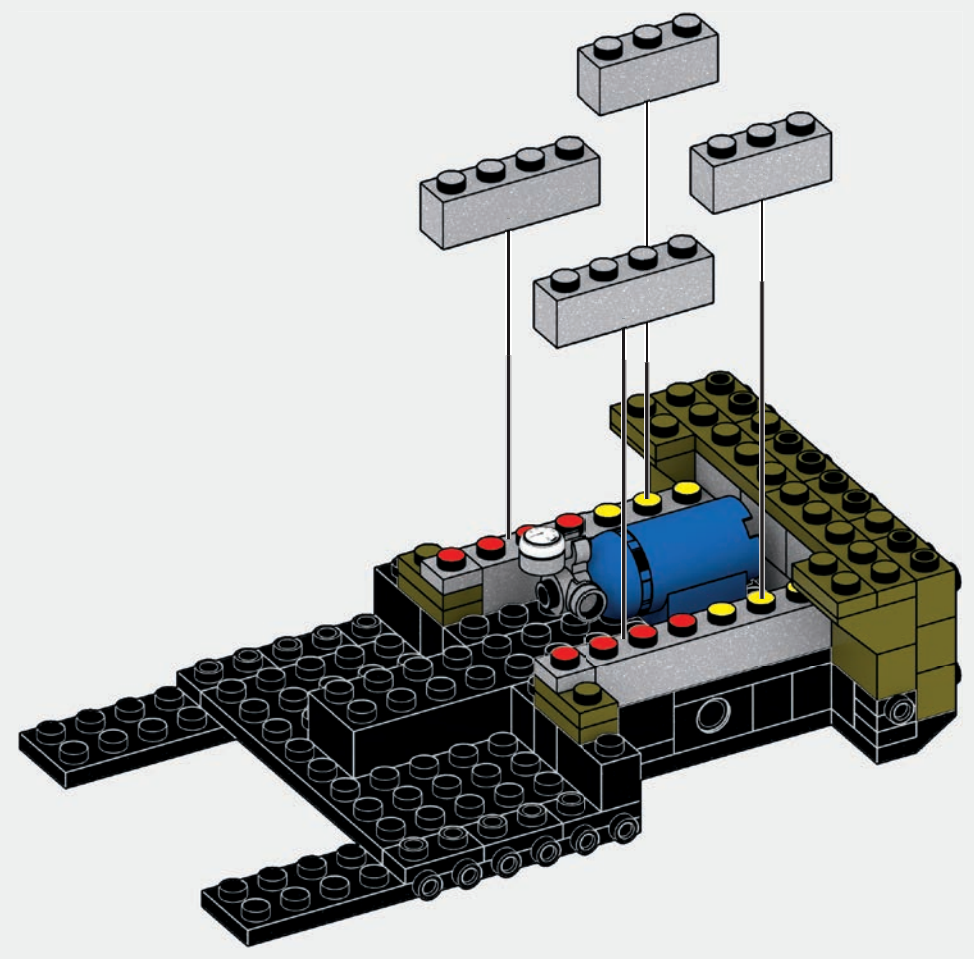
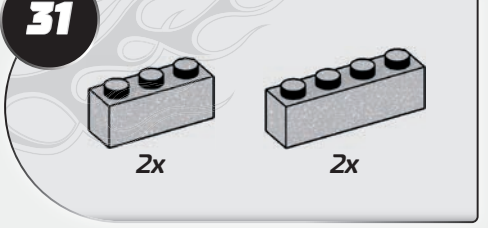

32



1x

33



1x

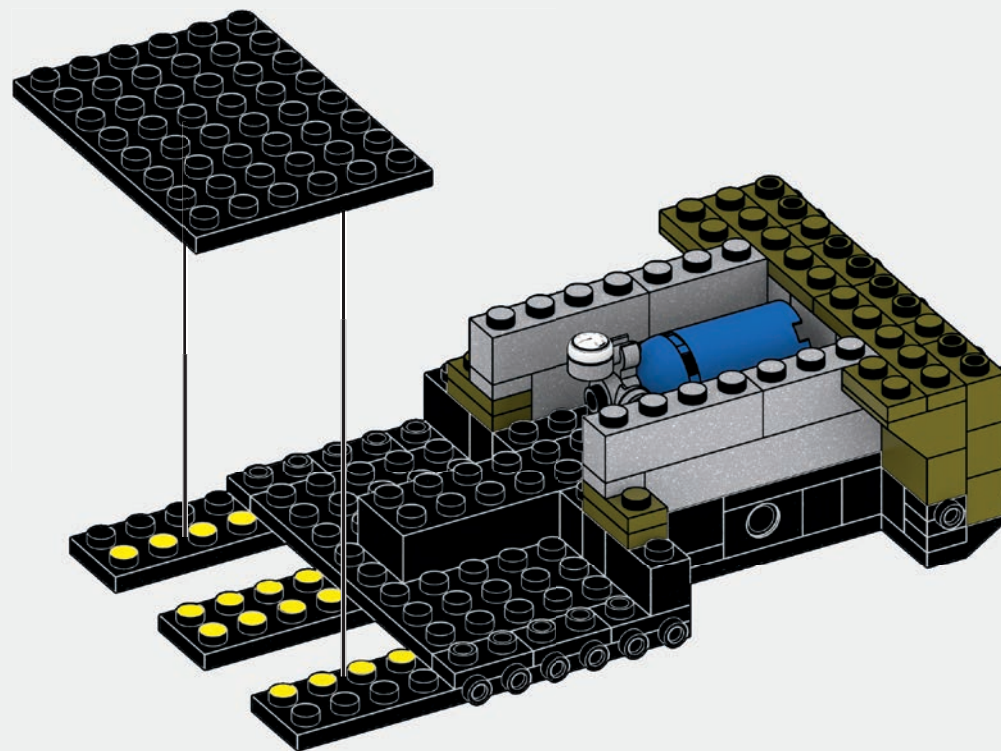
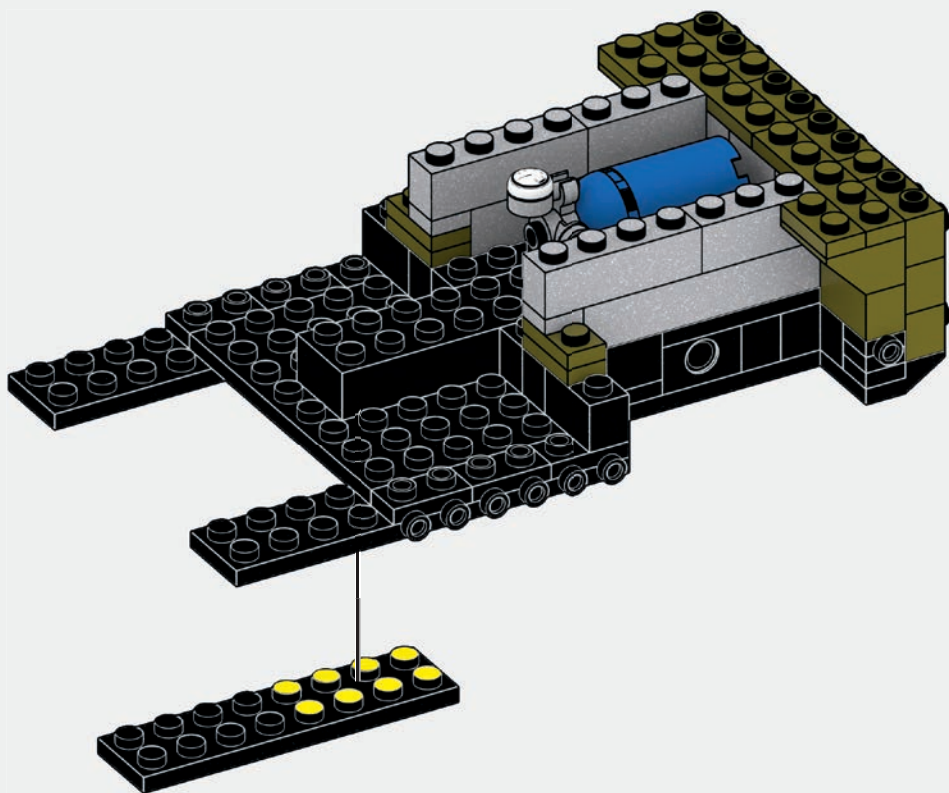

34



4x

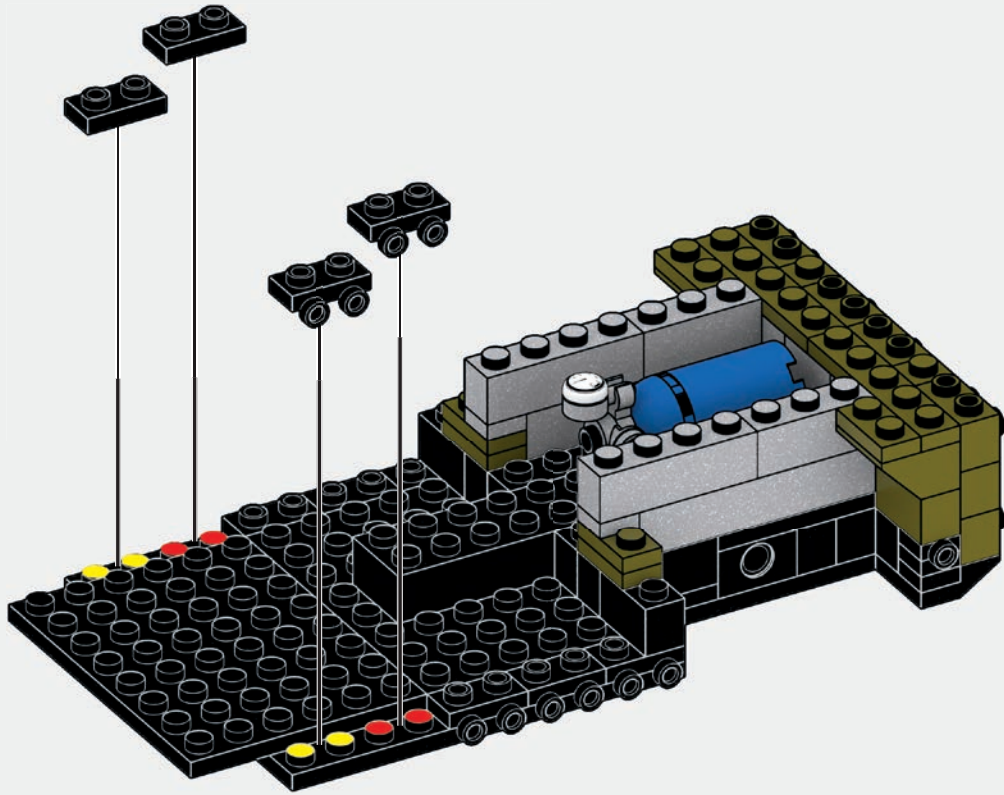

35



2x

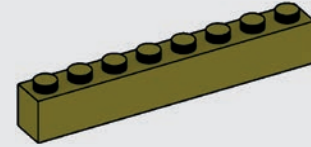

2x

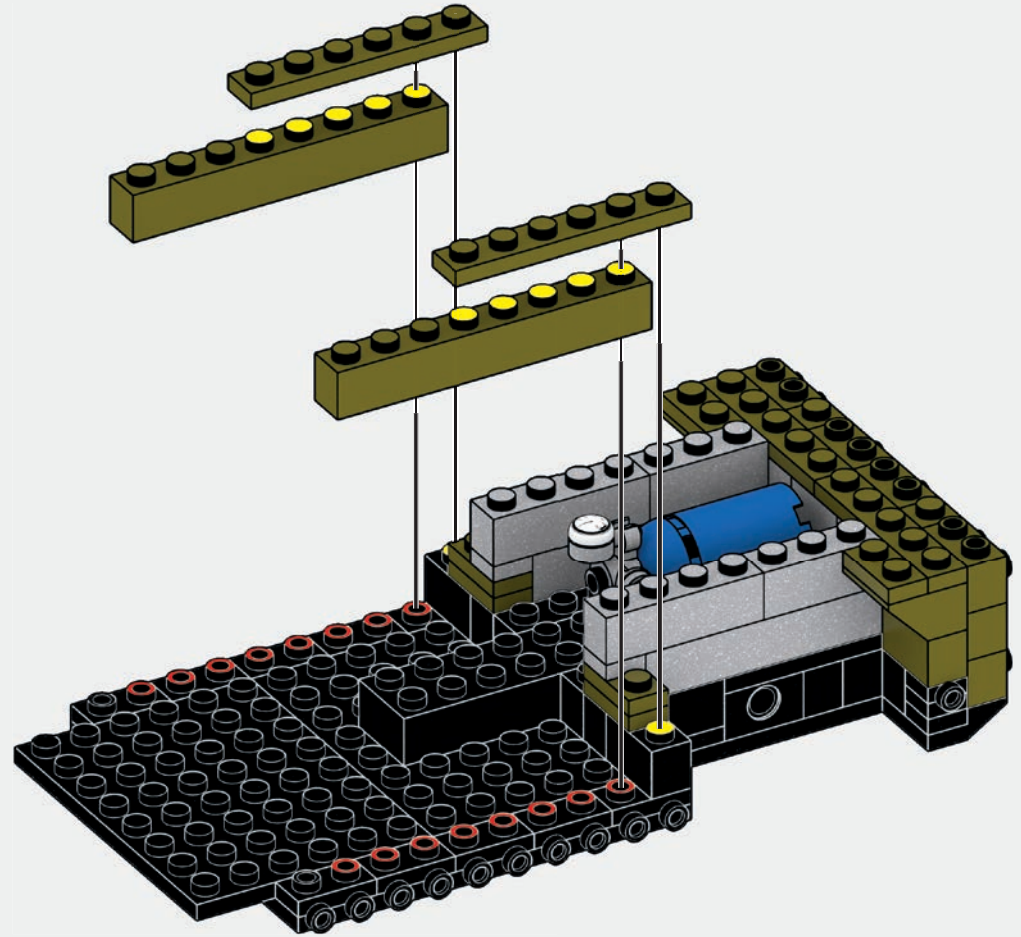

36

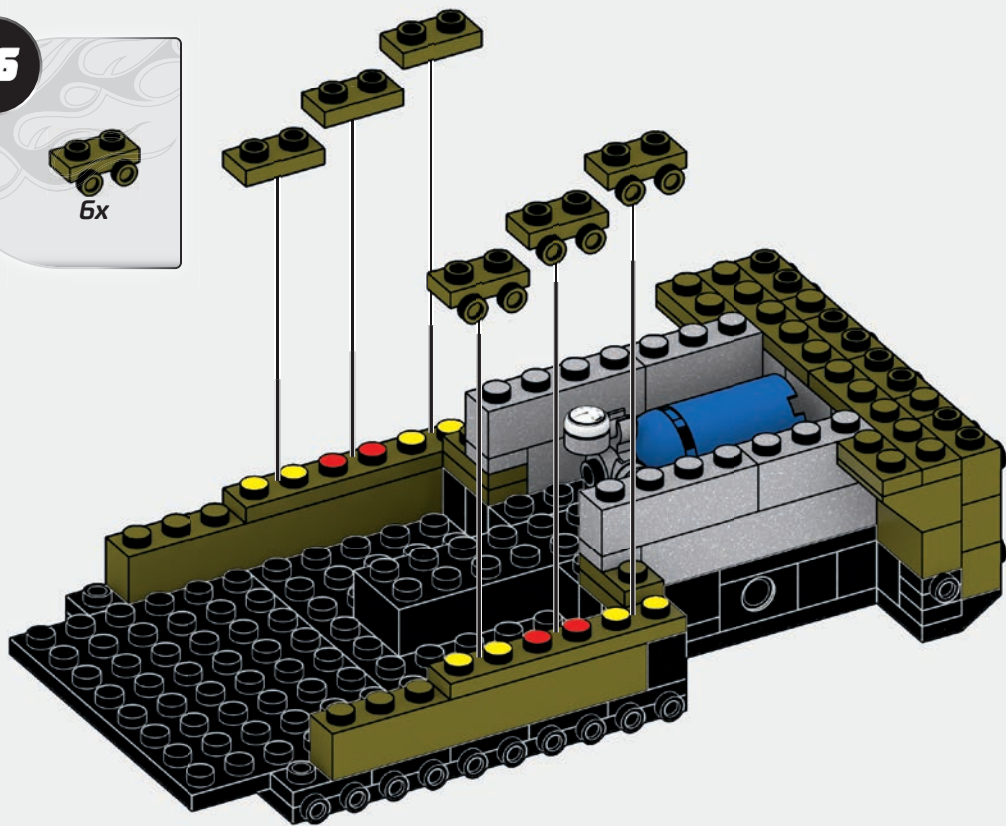
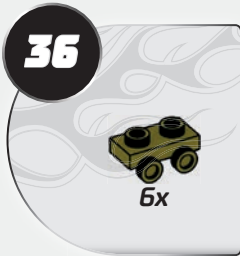

37

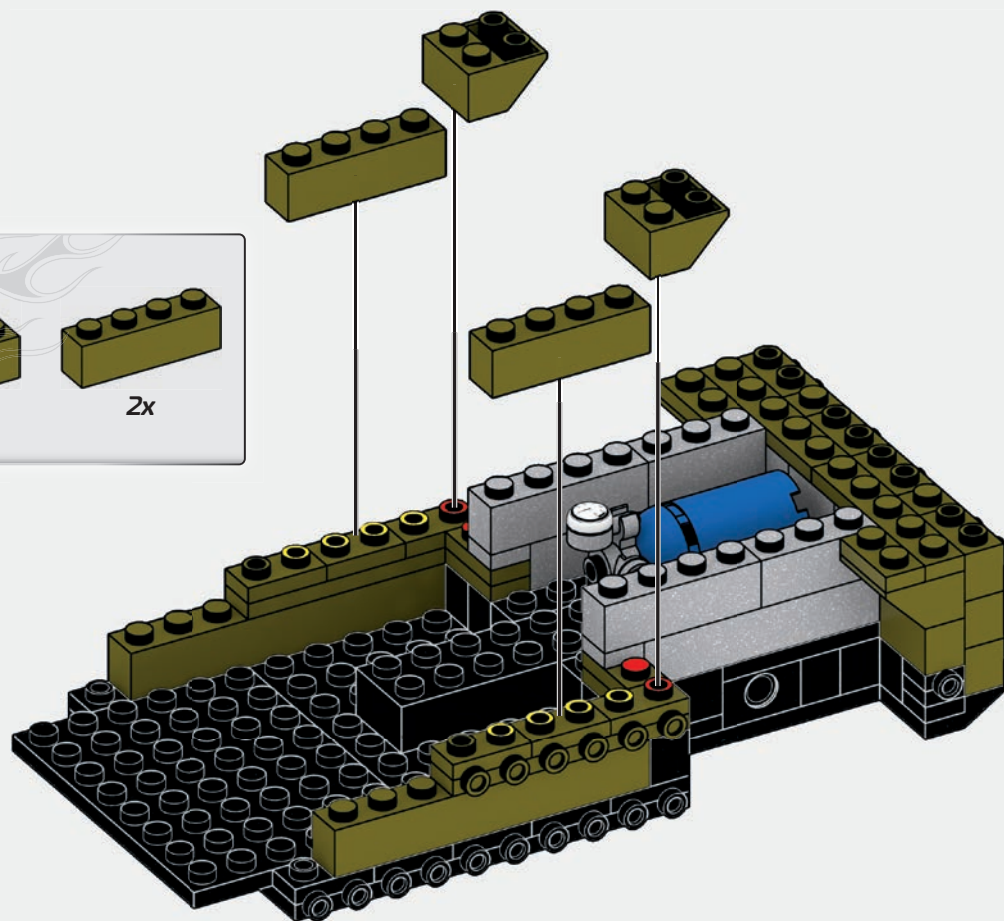
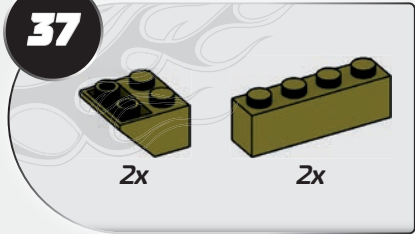

38



1x

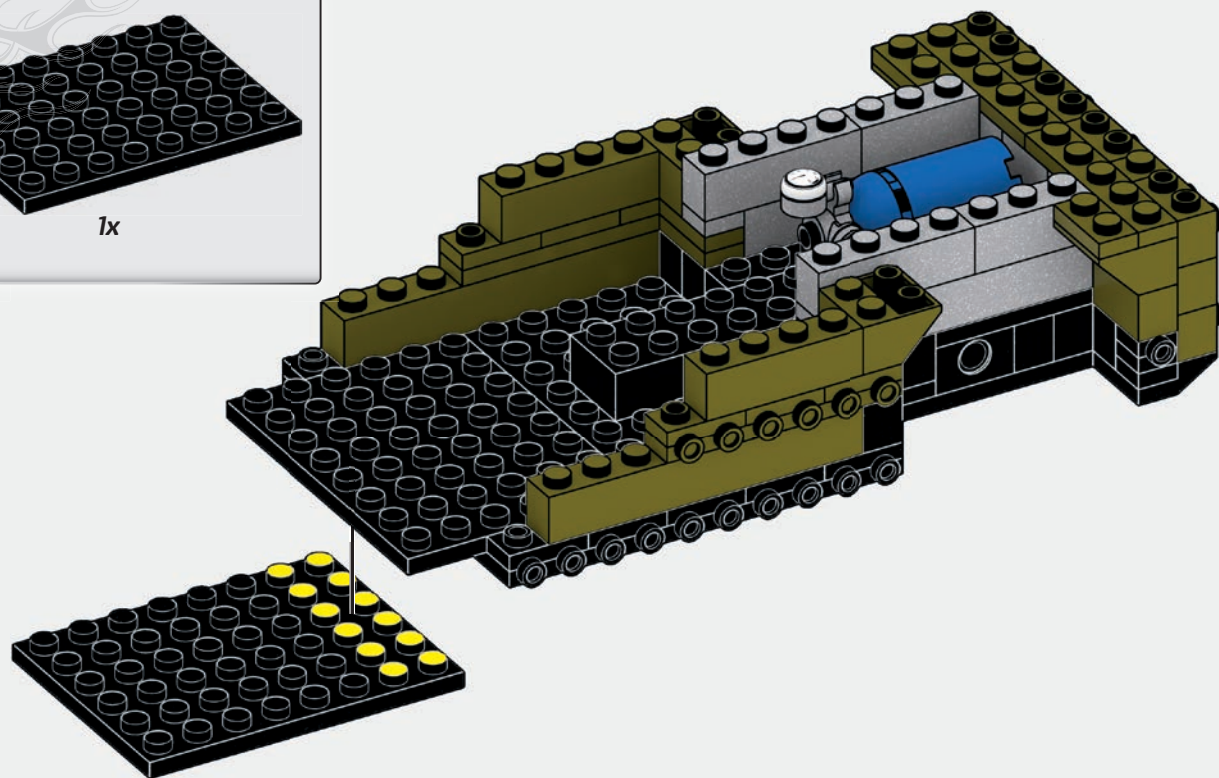

39



1x

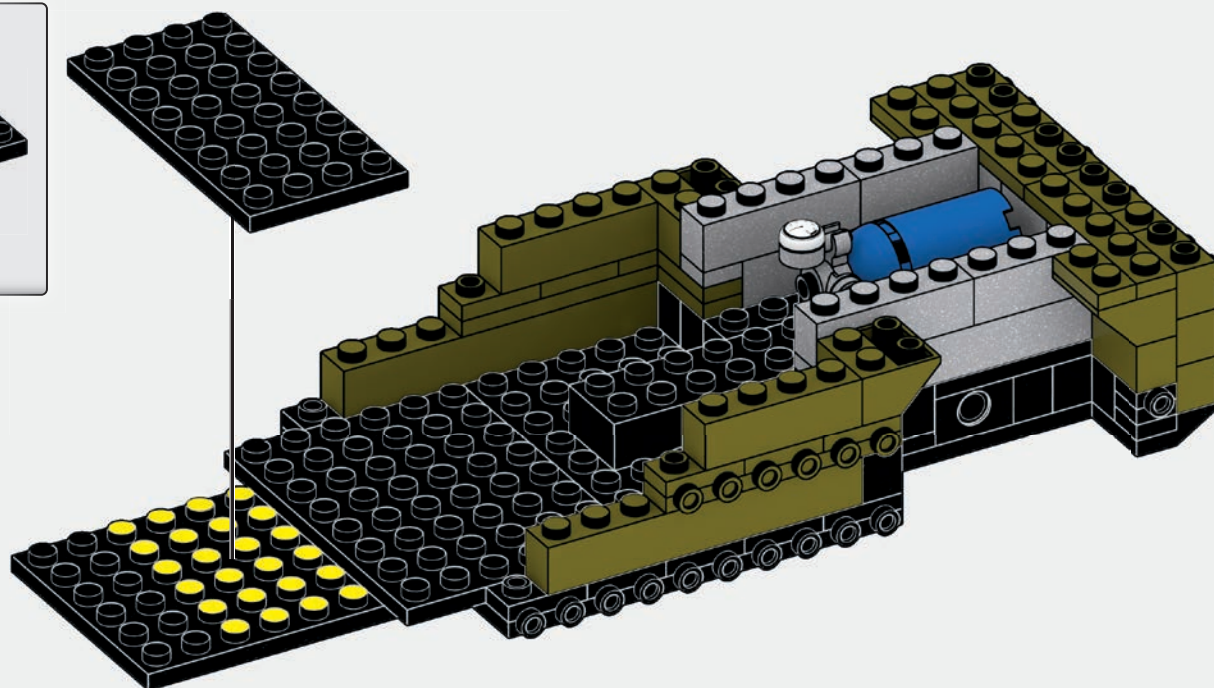

40



2x



1x

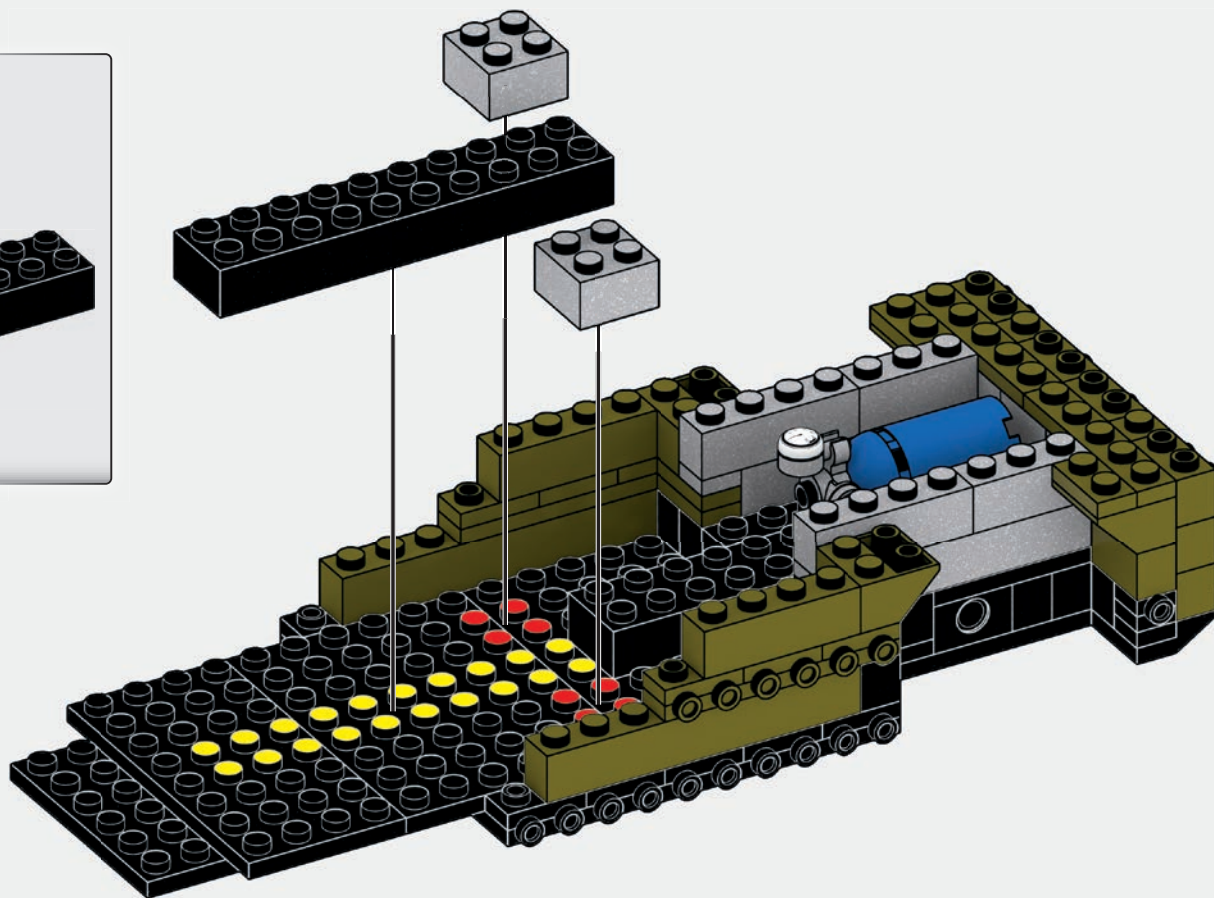

41



2x



1x



1x

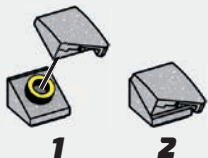

1

2

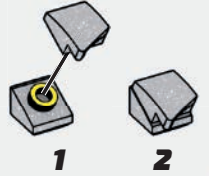

1

2

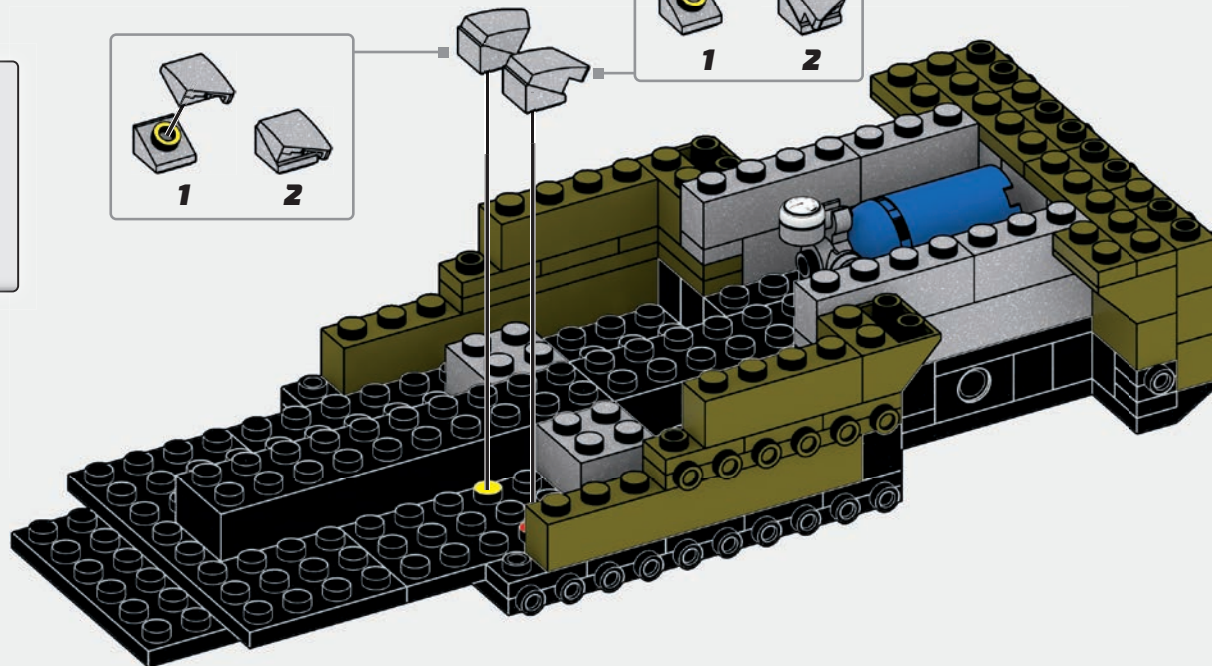

42



2x

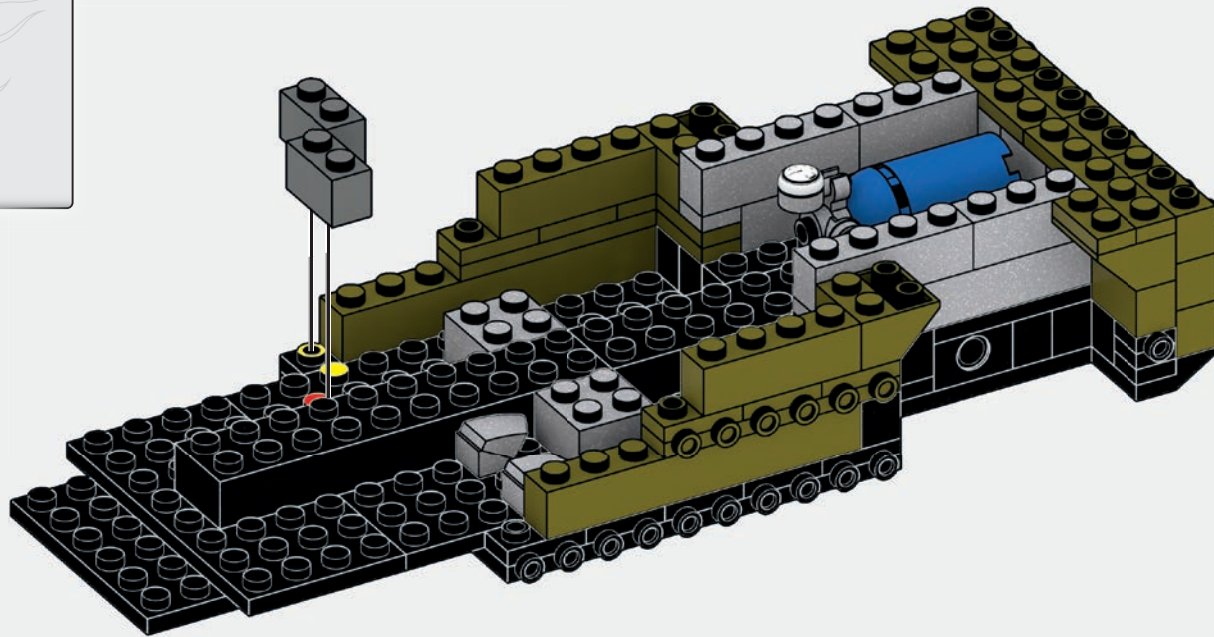

43



2x



1x



1x

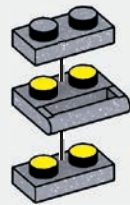

1

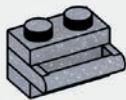

2

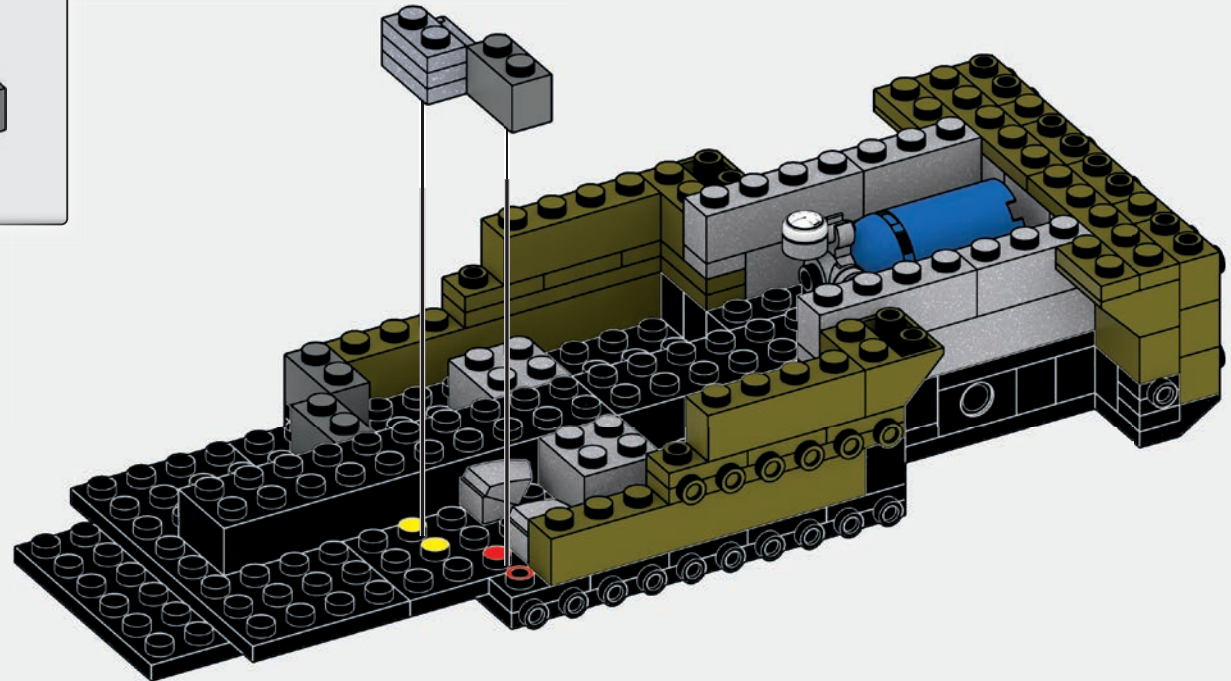

44

- 2x
- 1x
- 1x

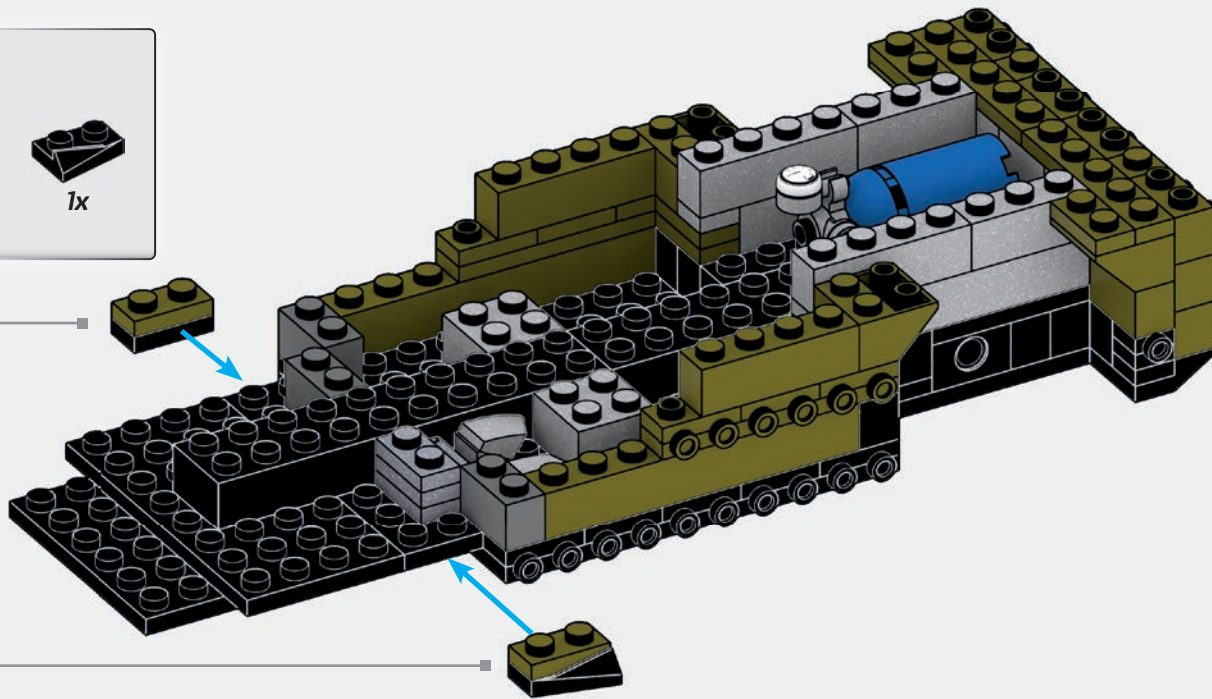
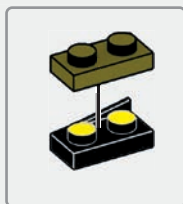

45

- 2x
- 2x
- 2x

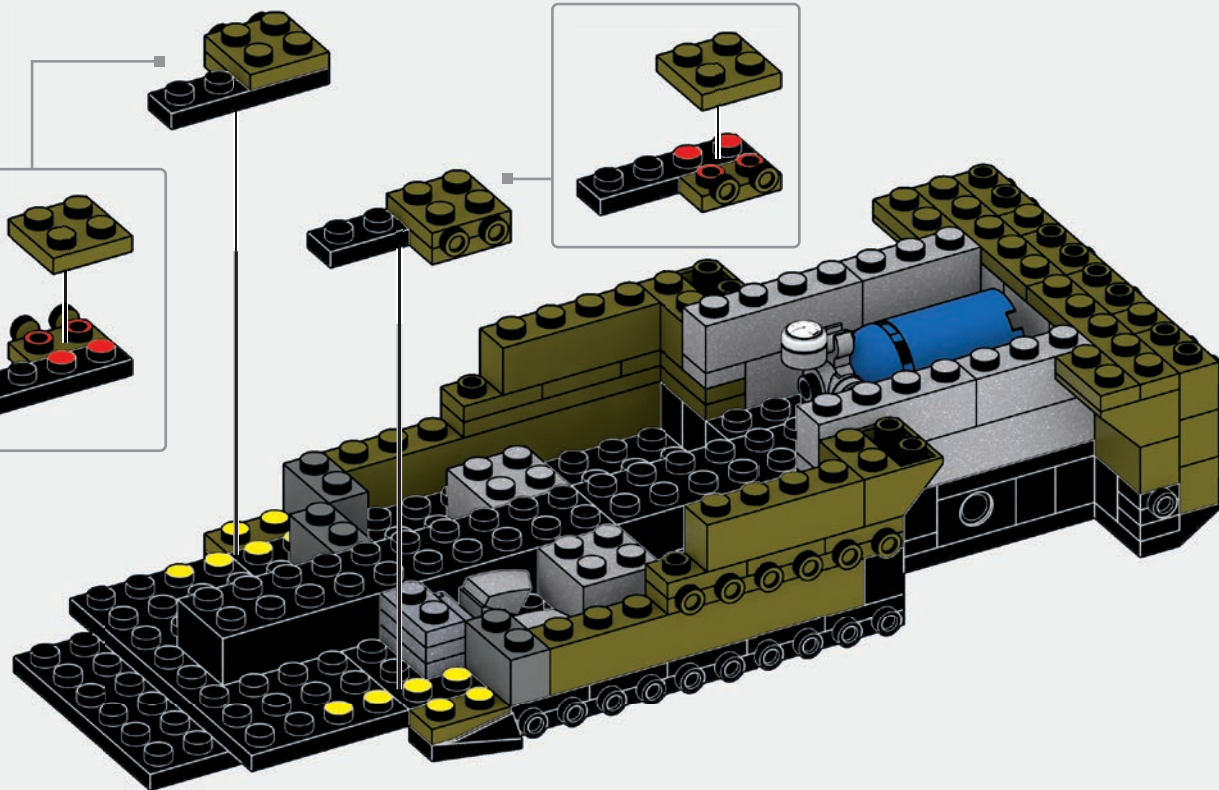
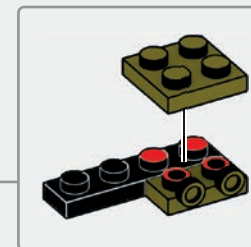
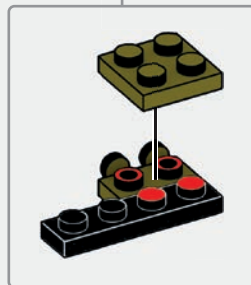

46



3x



1x

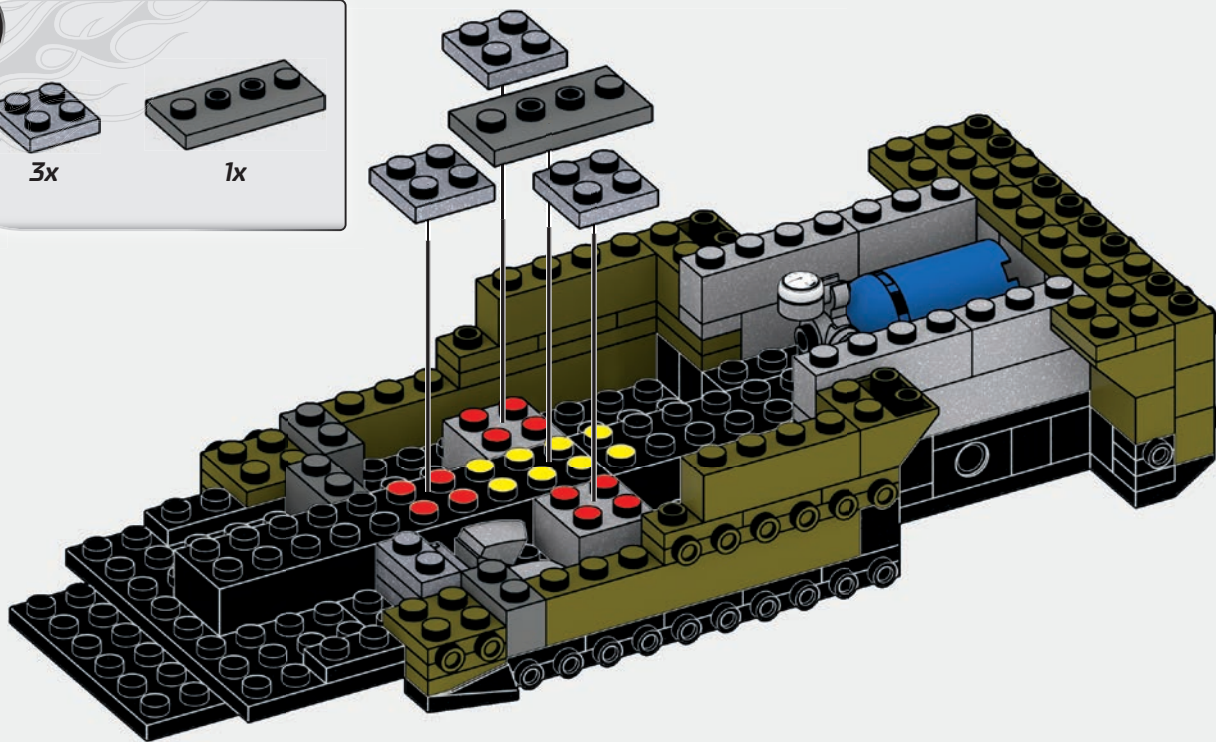

47



1x

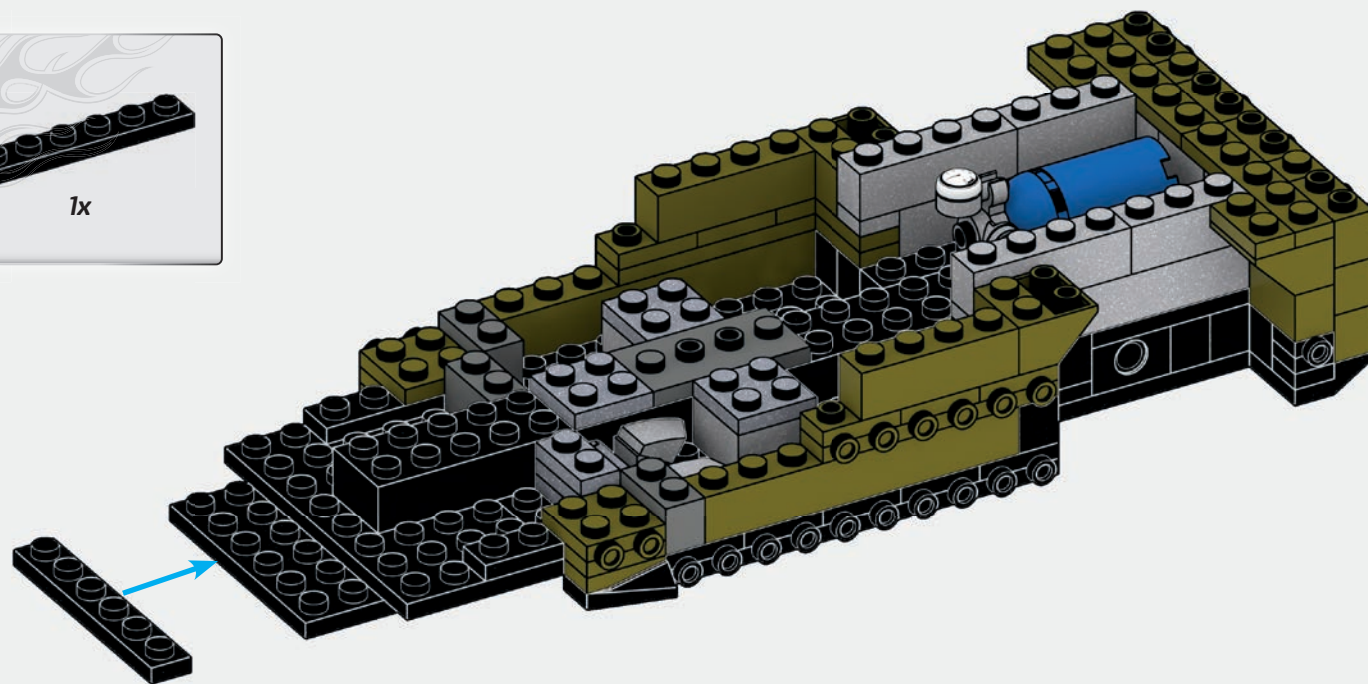

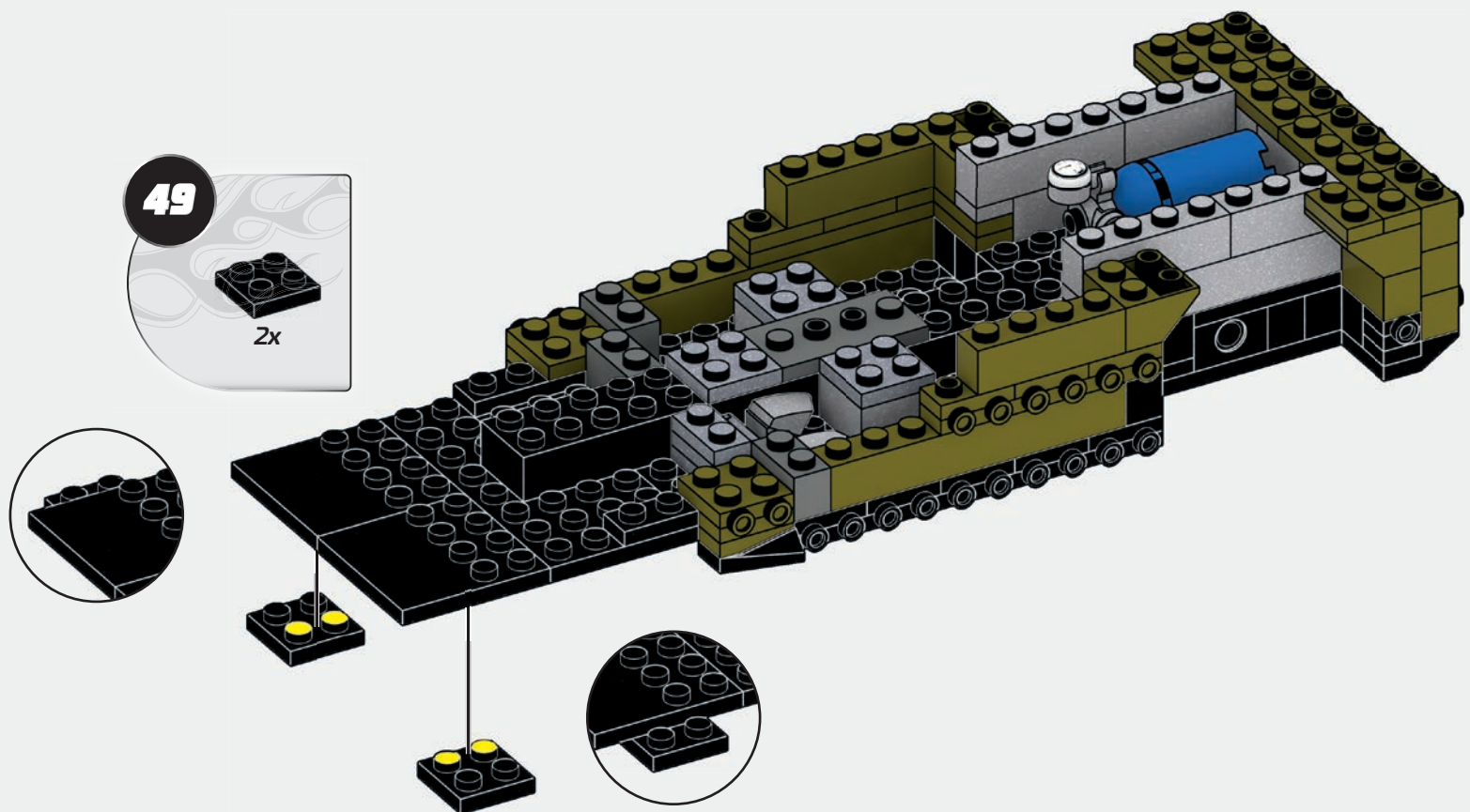
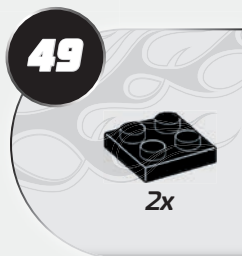
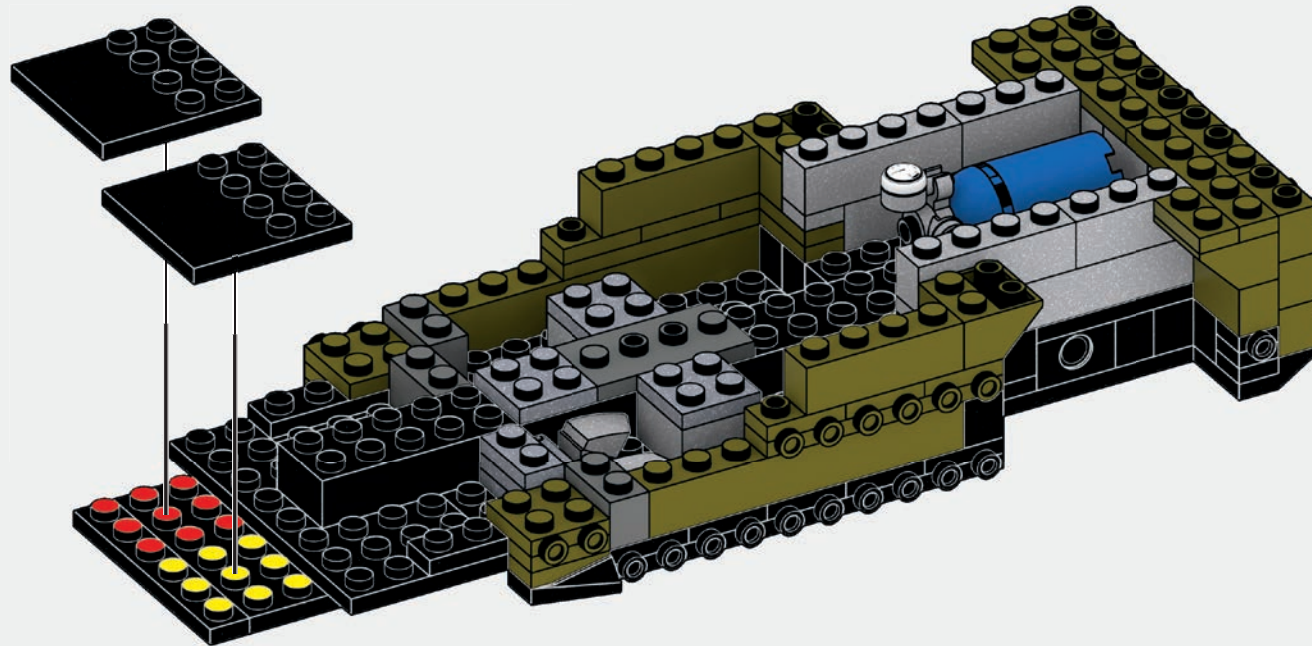

50

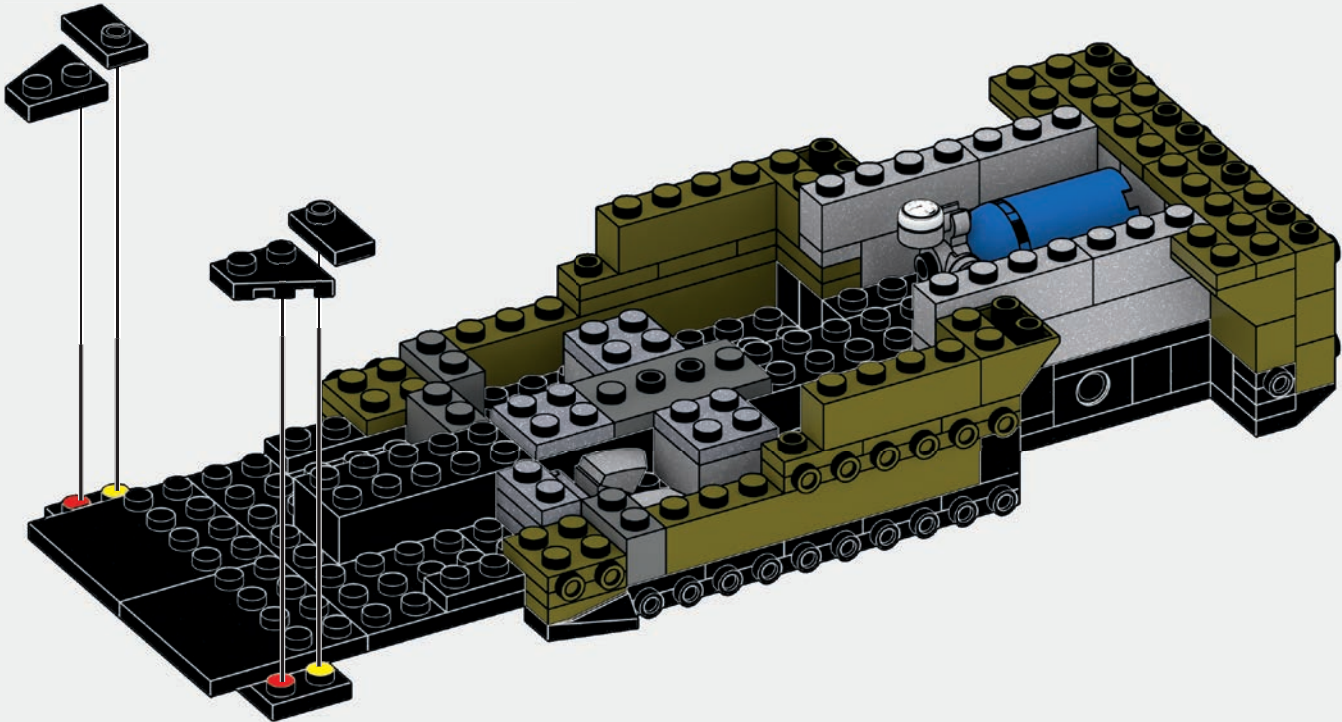

51

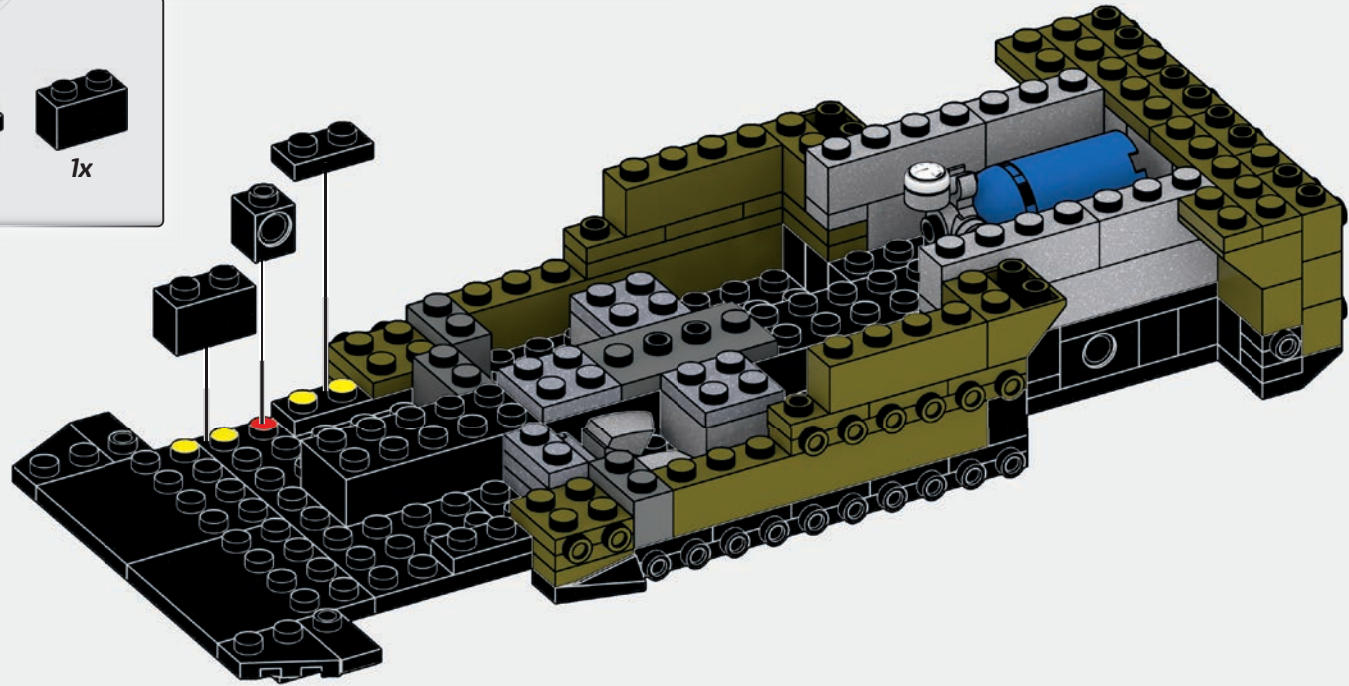

52



1x



1x

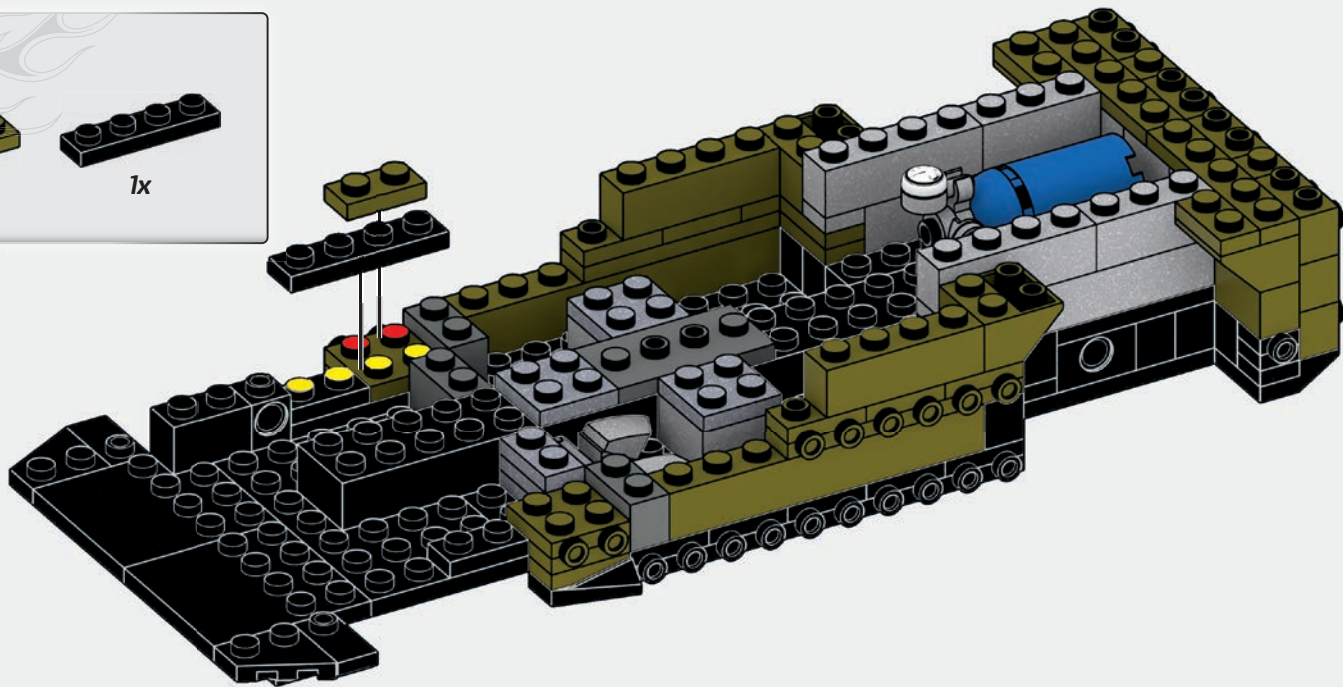

53



3x

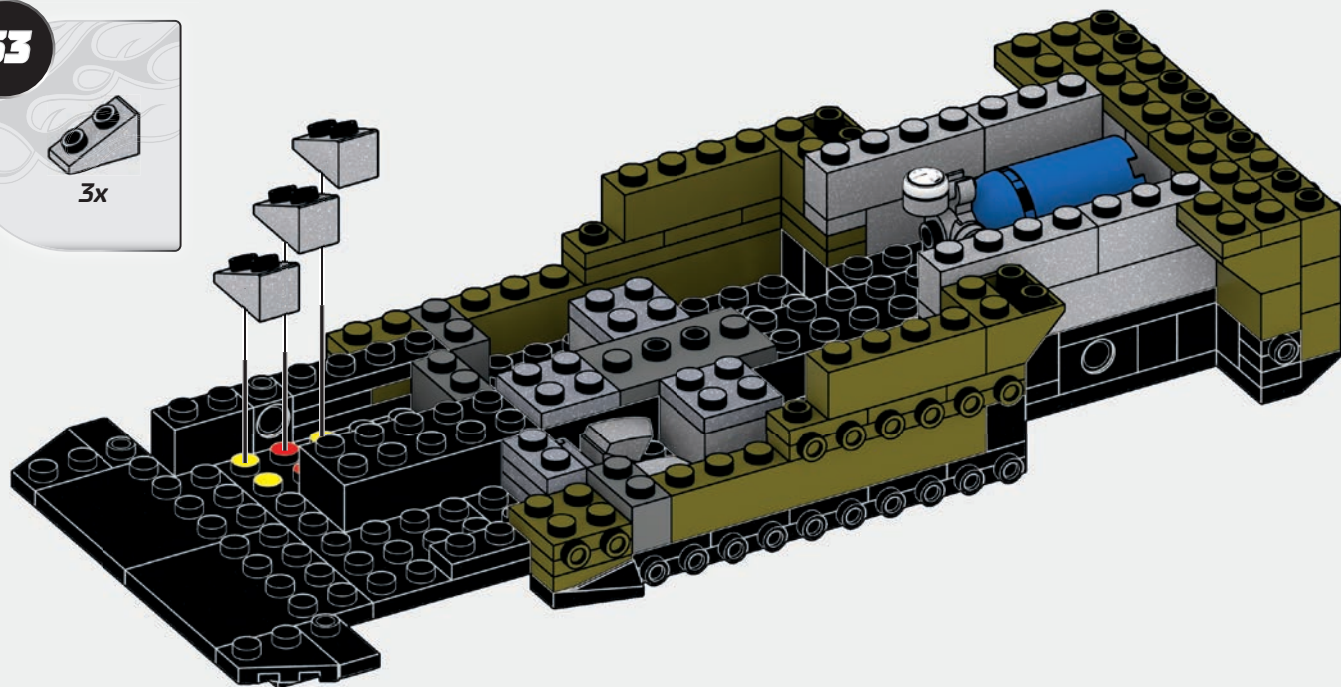

54



3x

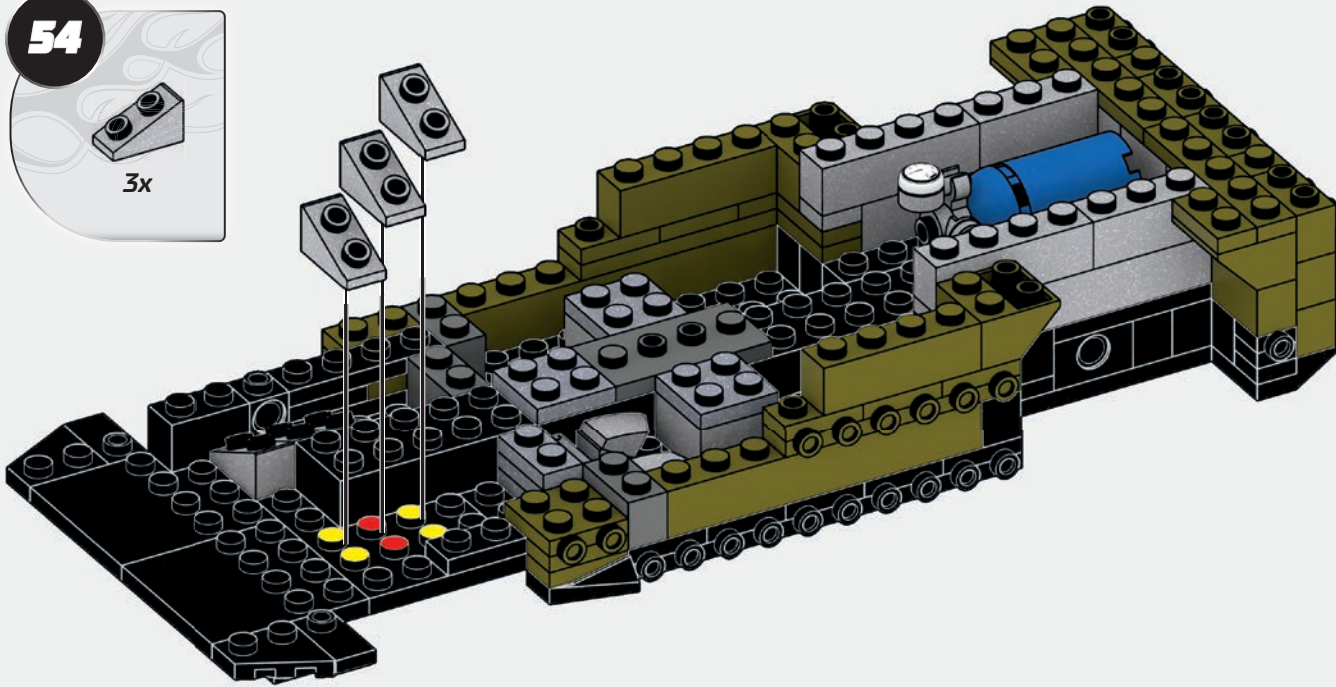

55



1x



1x



1x

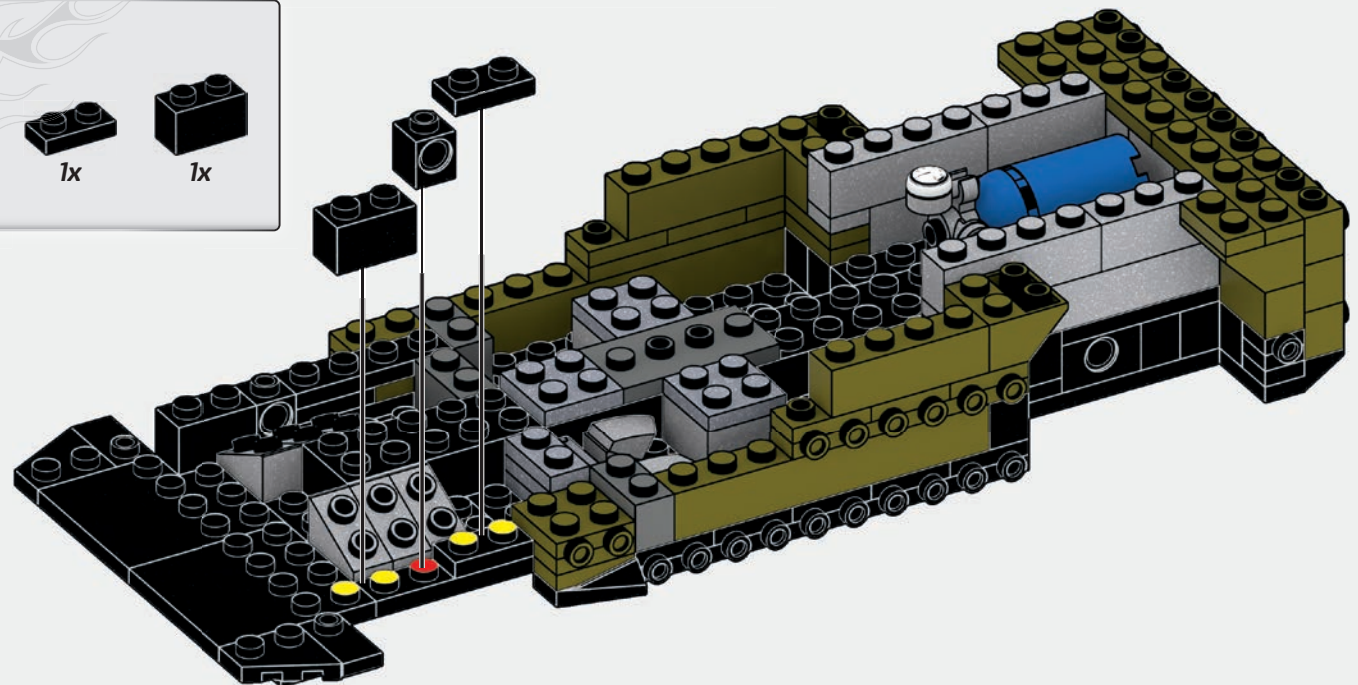

56



1x



1x

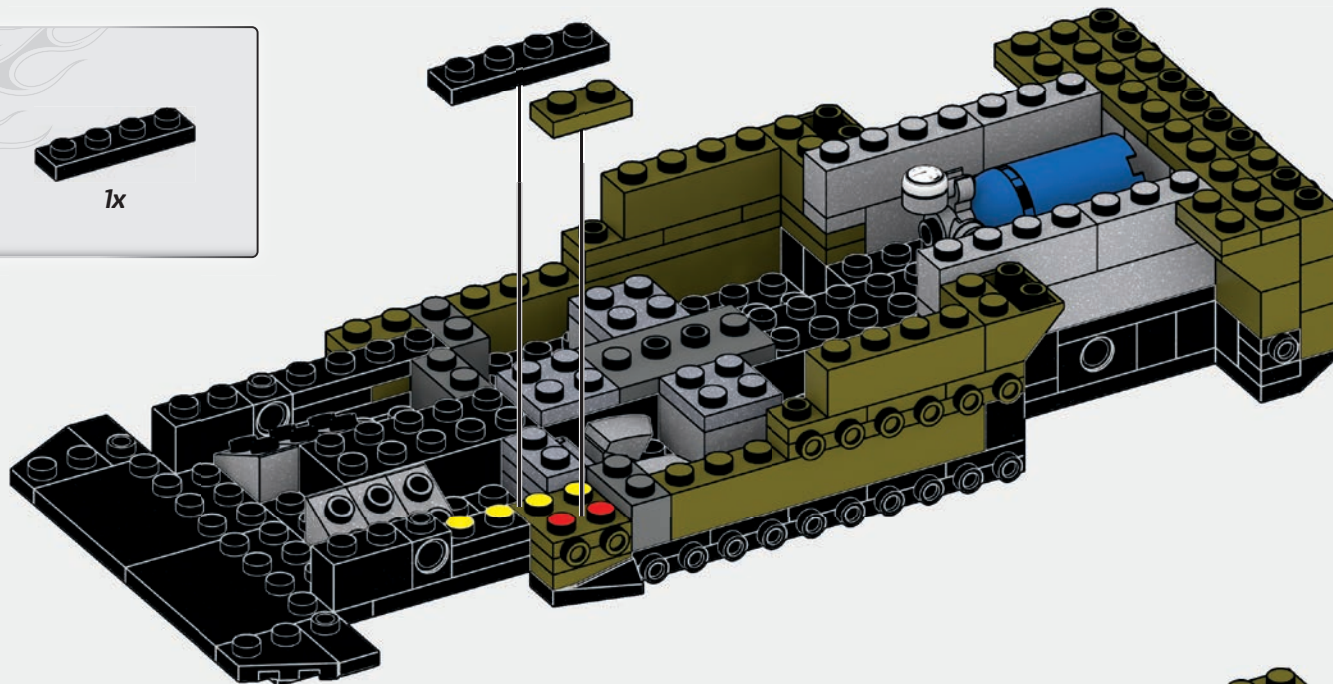

57



1x



1x



1x

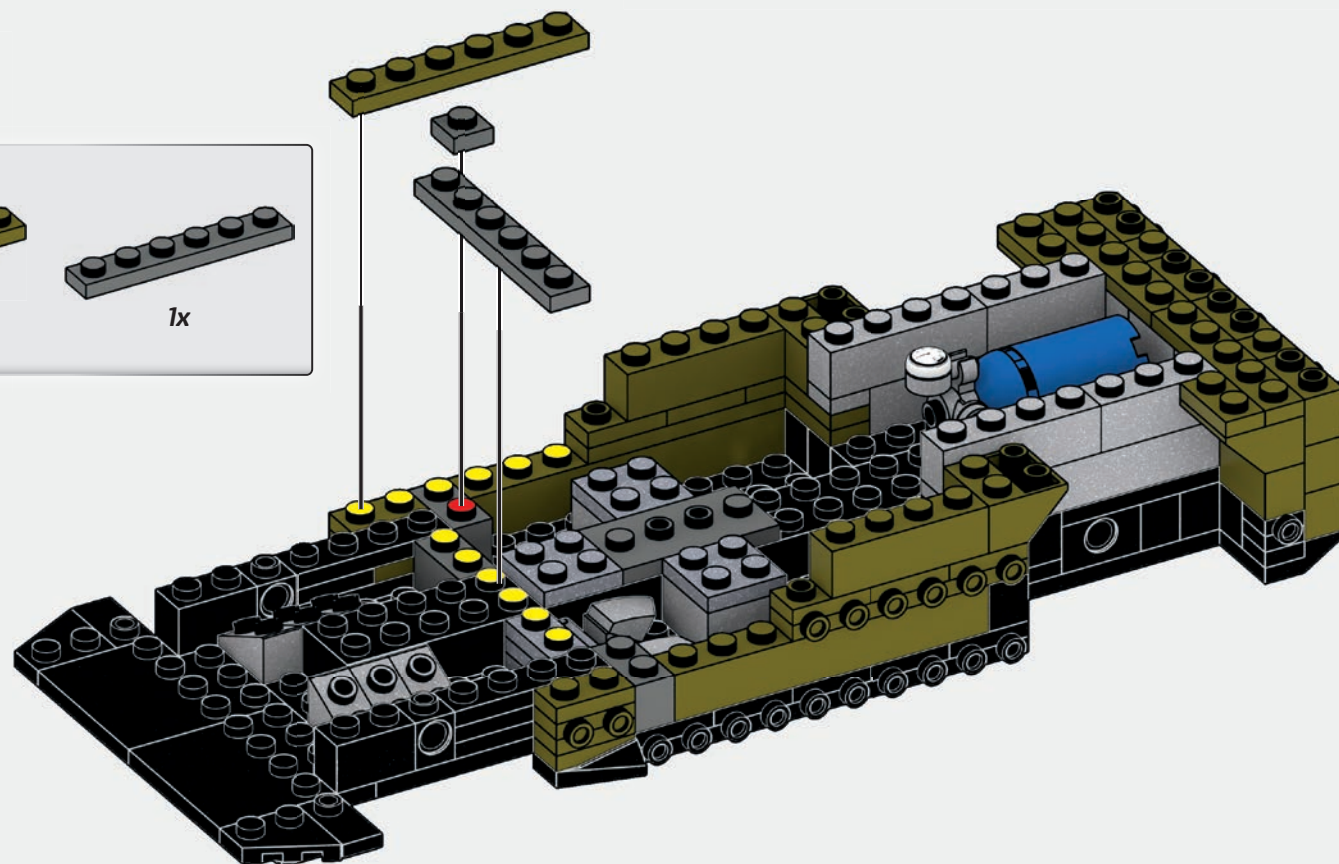

58



1x



1x

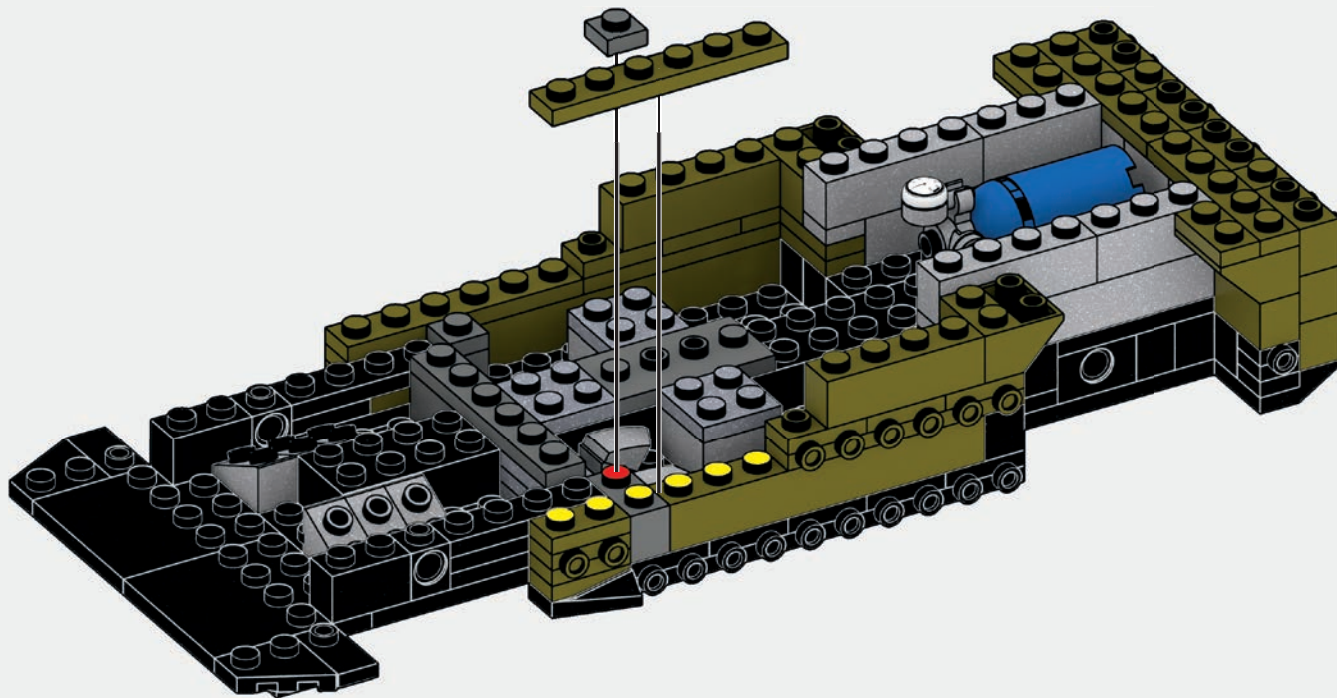

59

- 1x [Black Pin]
- 1x [Red Pin]
- 1x [Red Technic Axle]
- 1x [Grey Technic Axle]
- 1x [Grey Technic Axle]

- 1 [Red and Yellow Axle Assembly]
- 2 [Red and Black Axle Assembly]

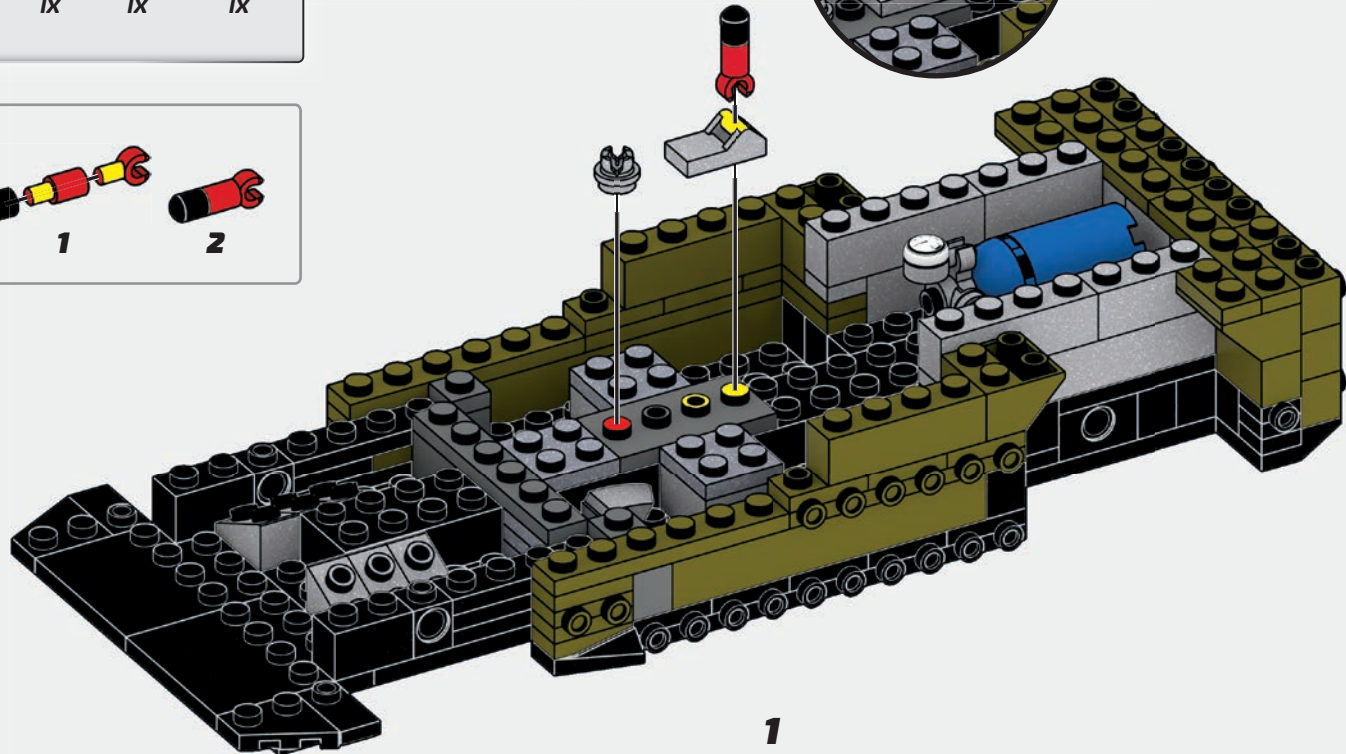
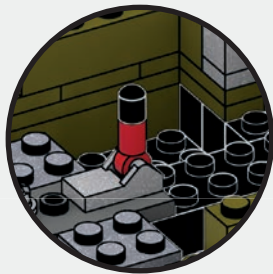

1

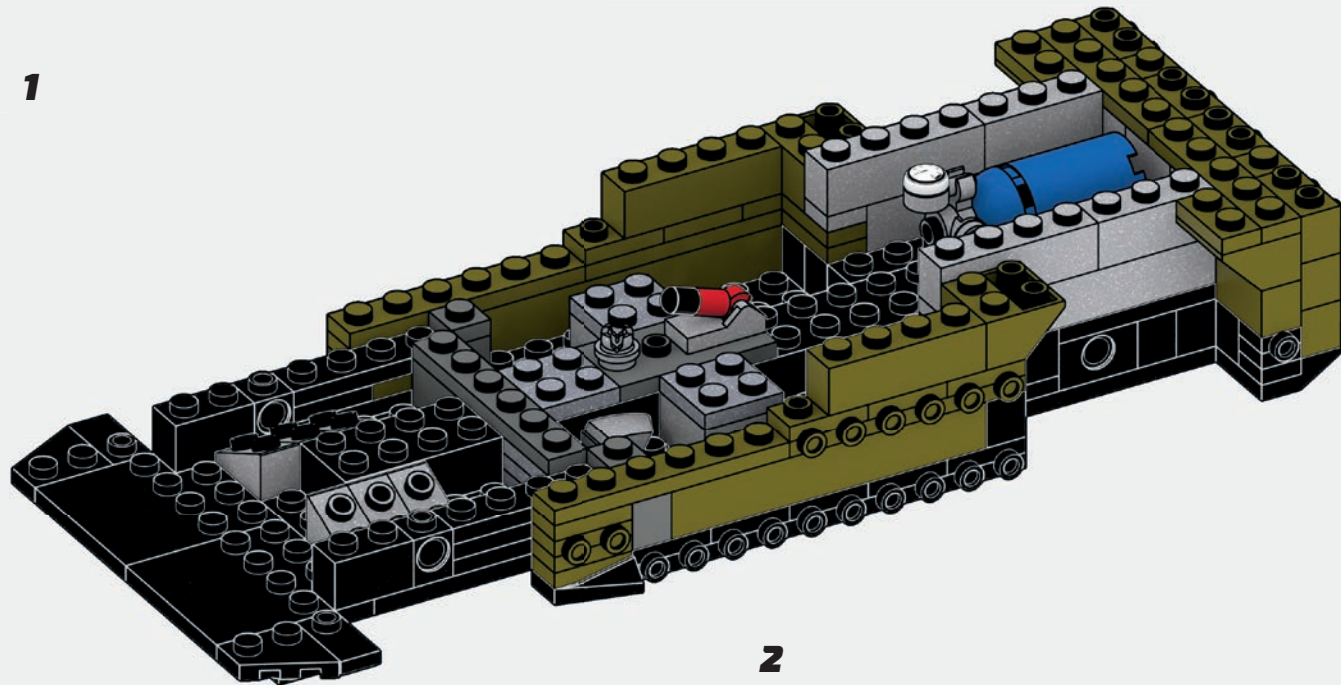

2

60

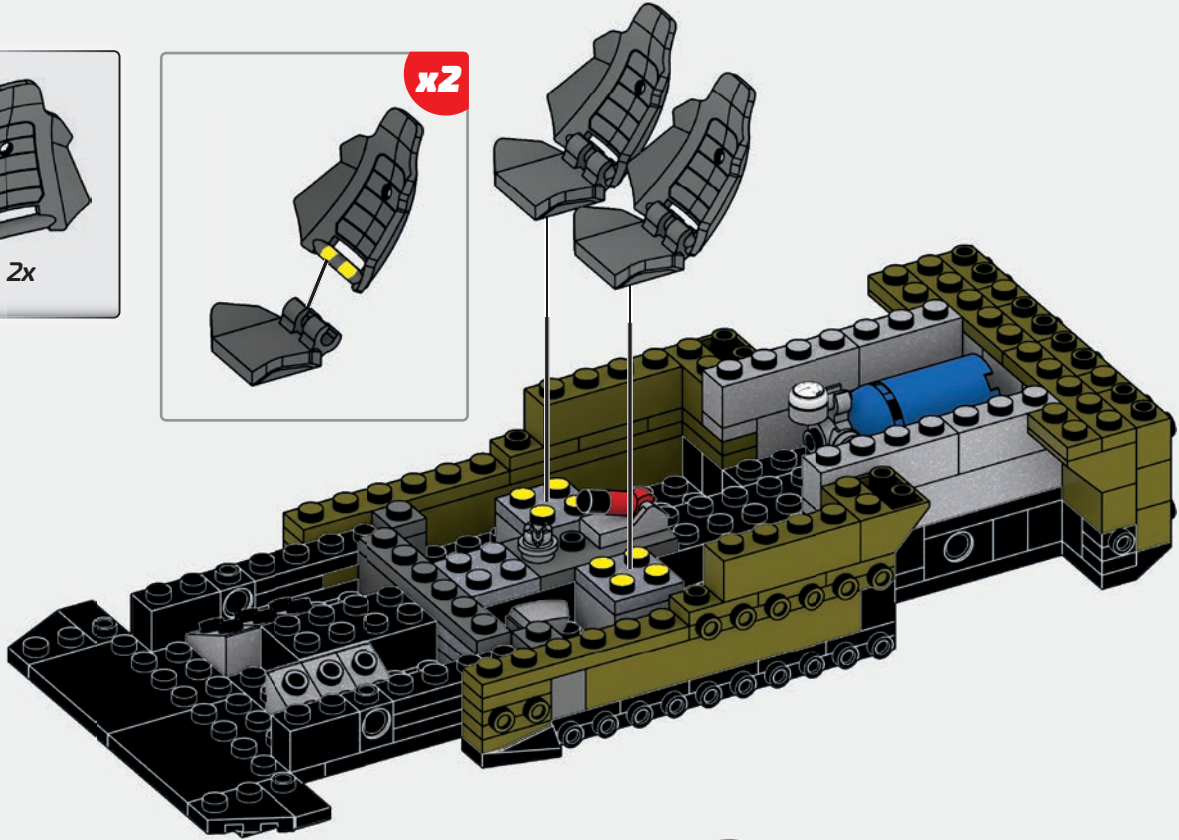
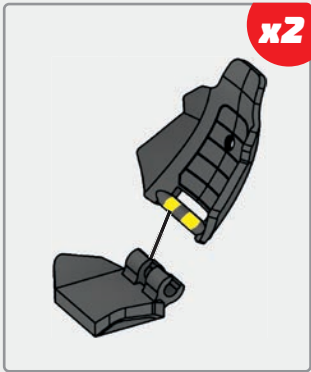
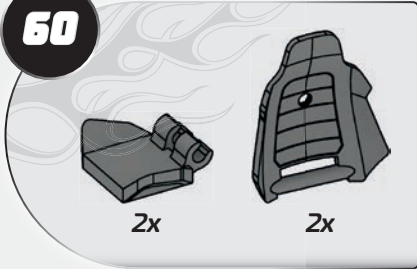

61

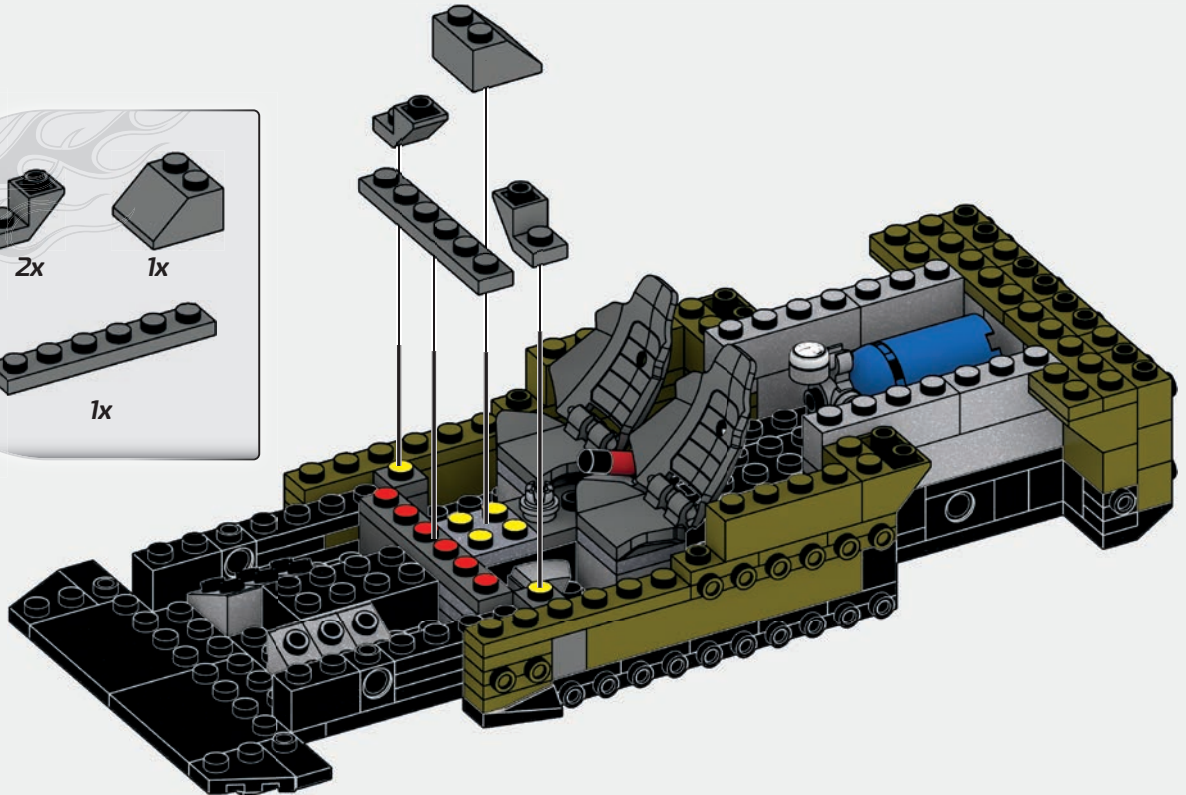
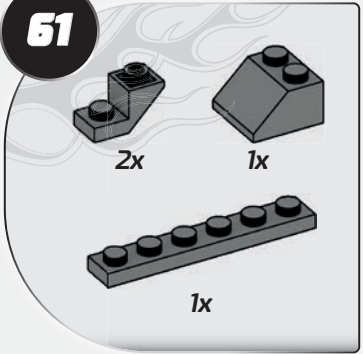

62



4x



1x

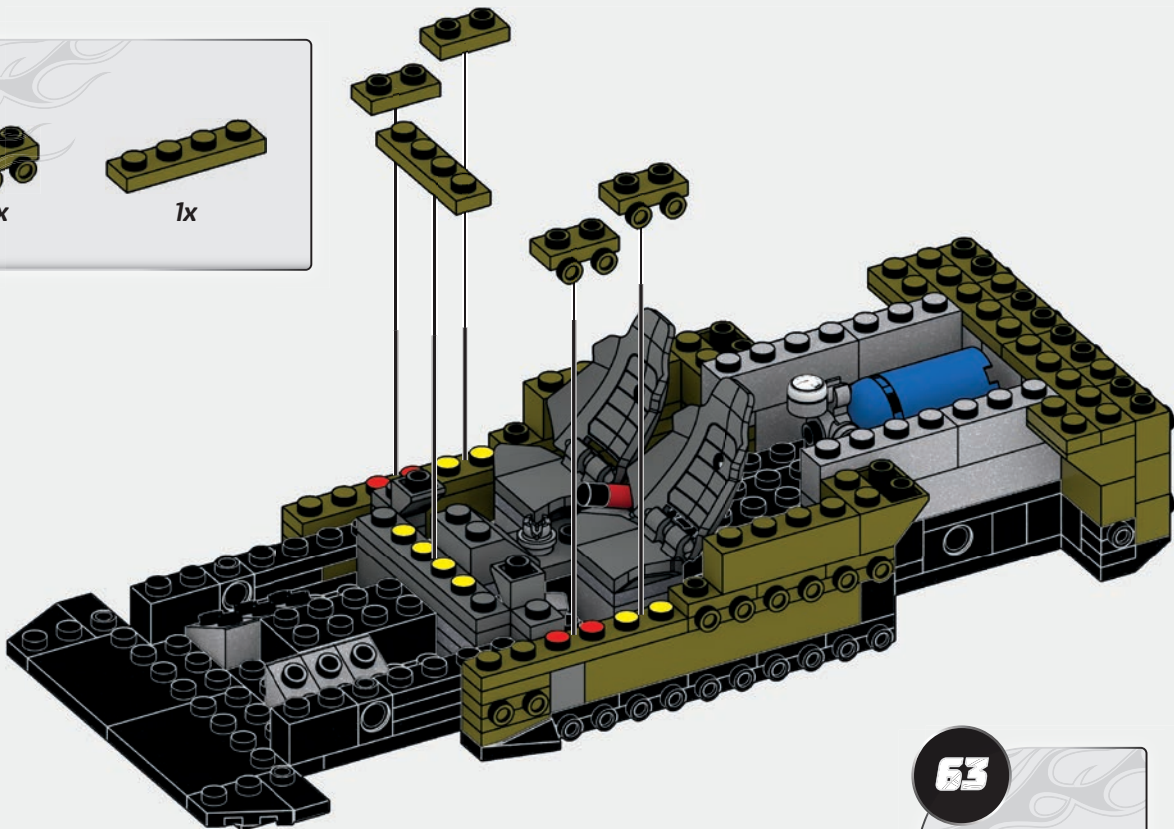

63



5x

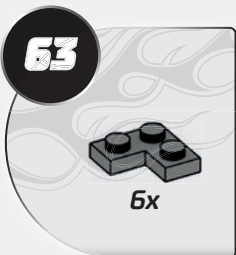

1



2

x2

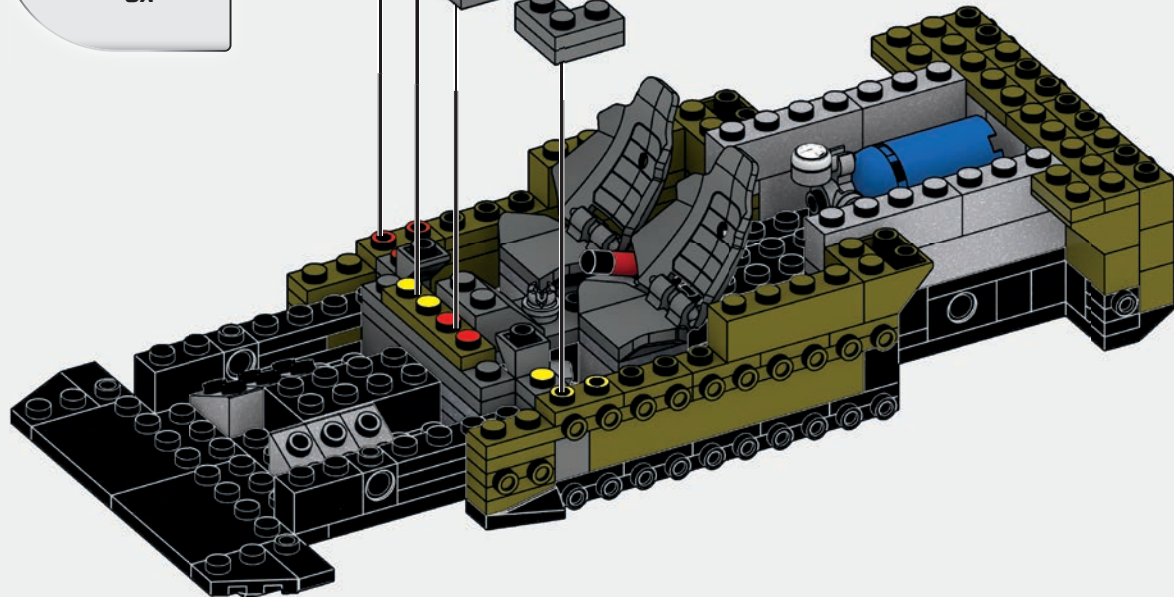
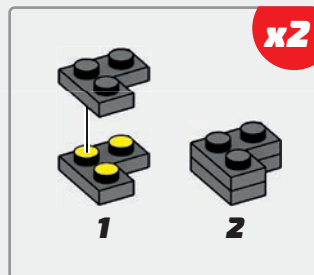

64

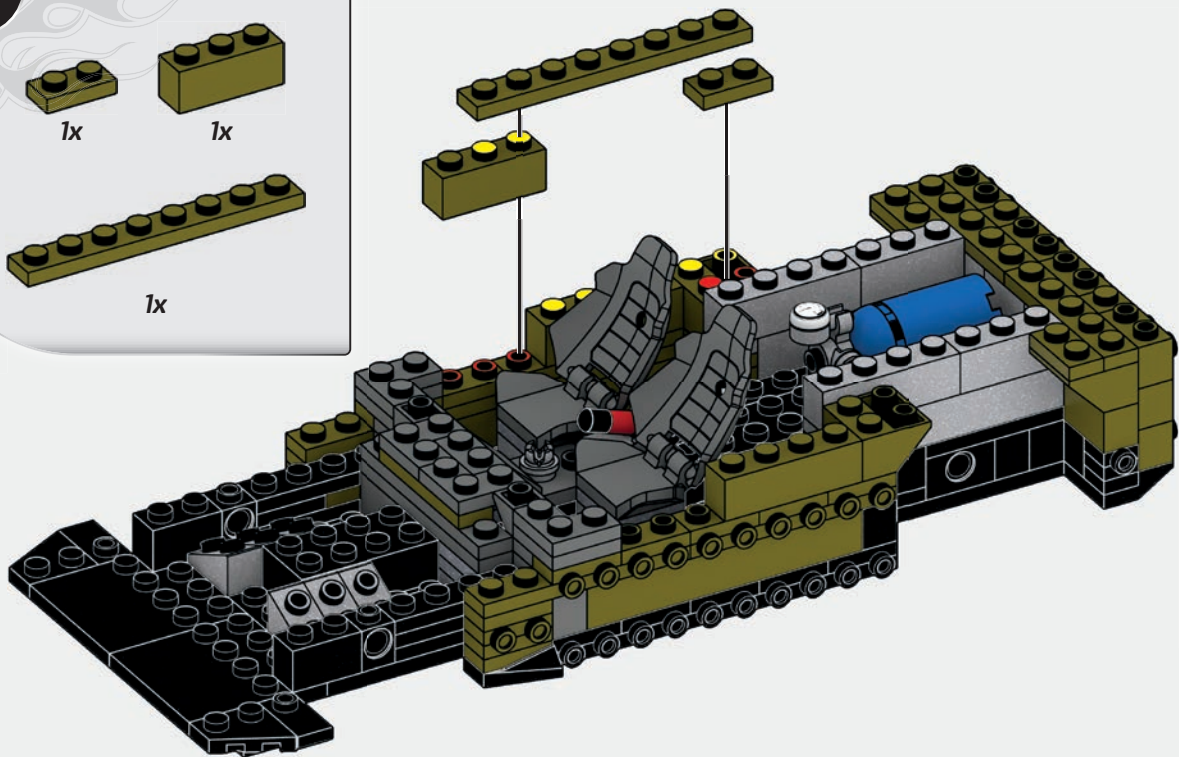
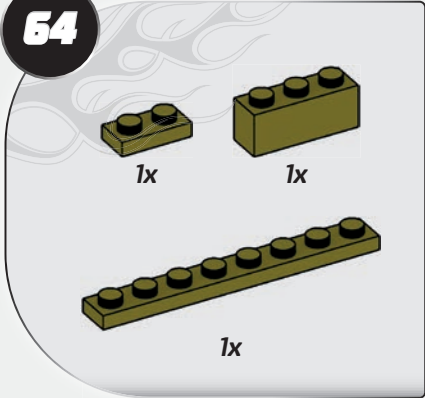

65

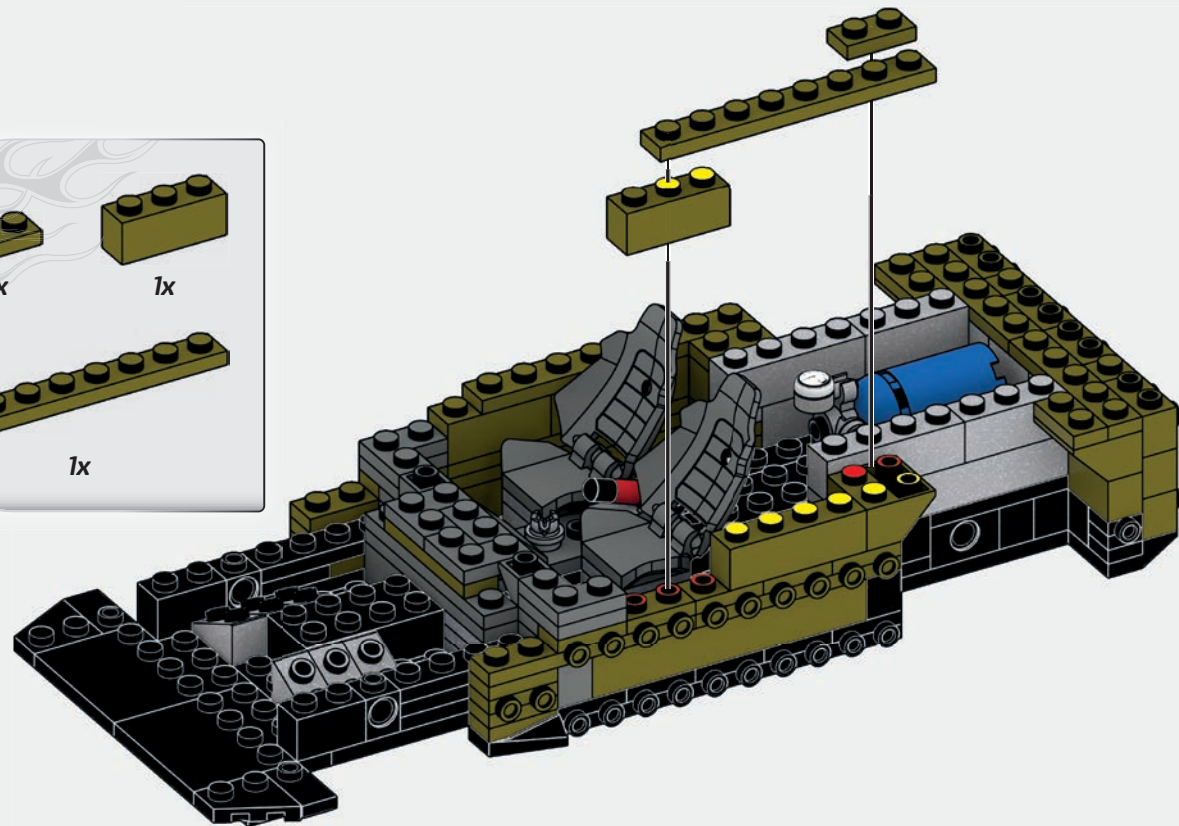
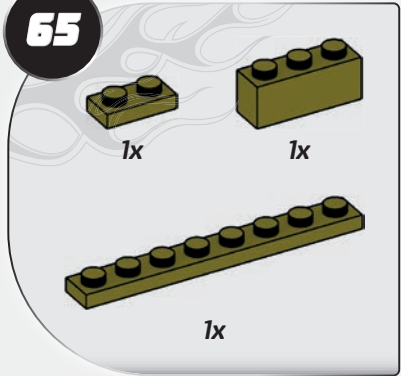

66

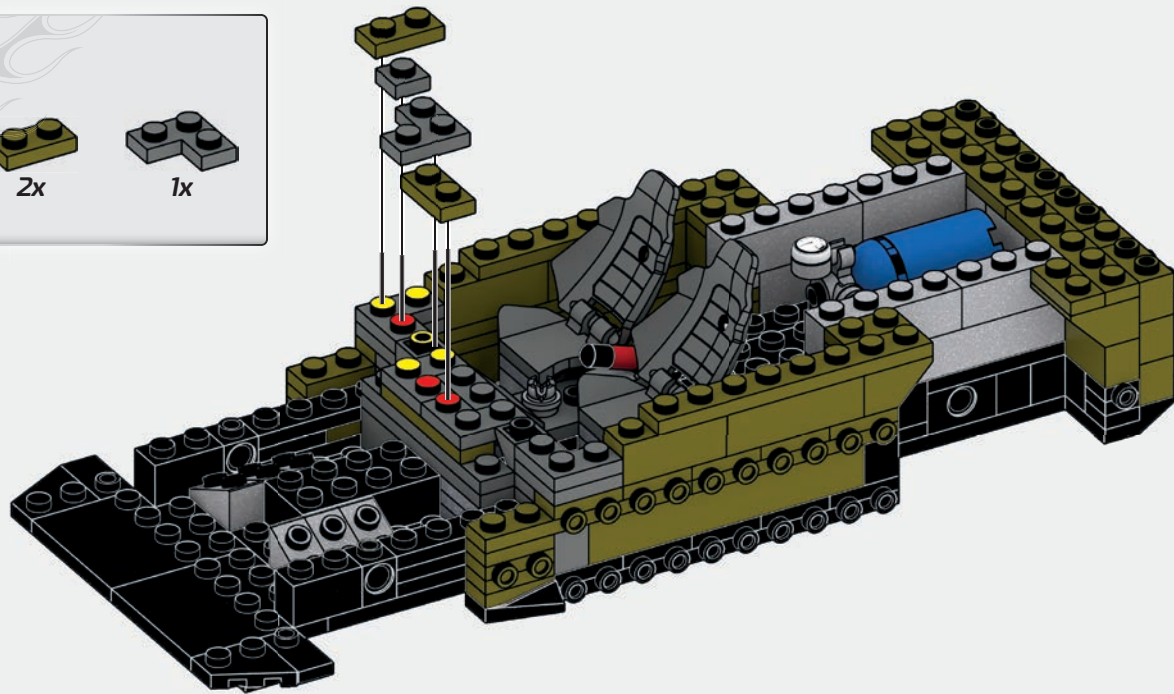

67

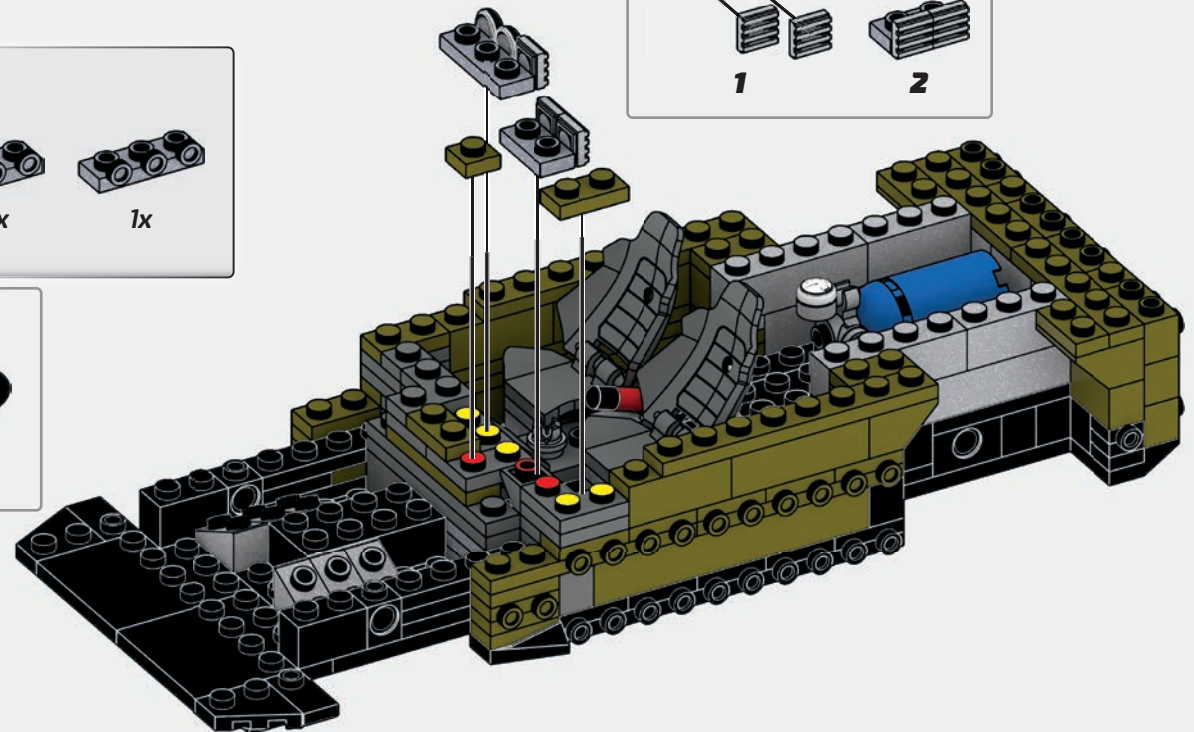
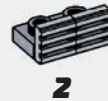
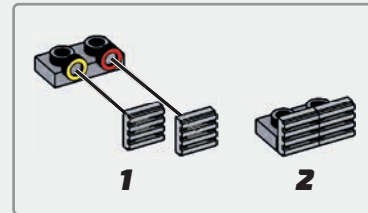
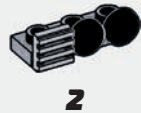
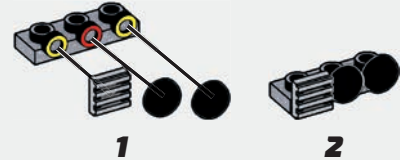
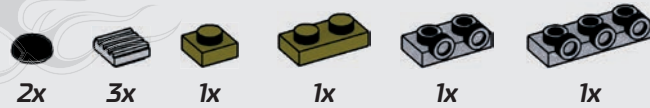

68



1x



1x



1x

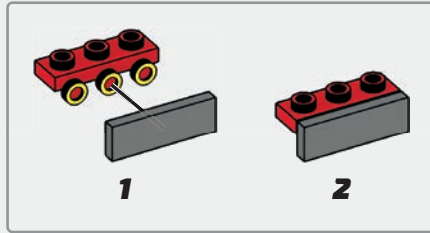

1

2

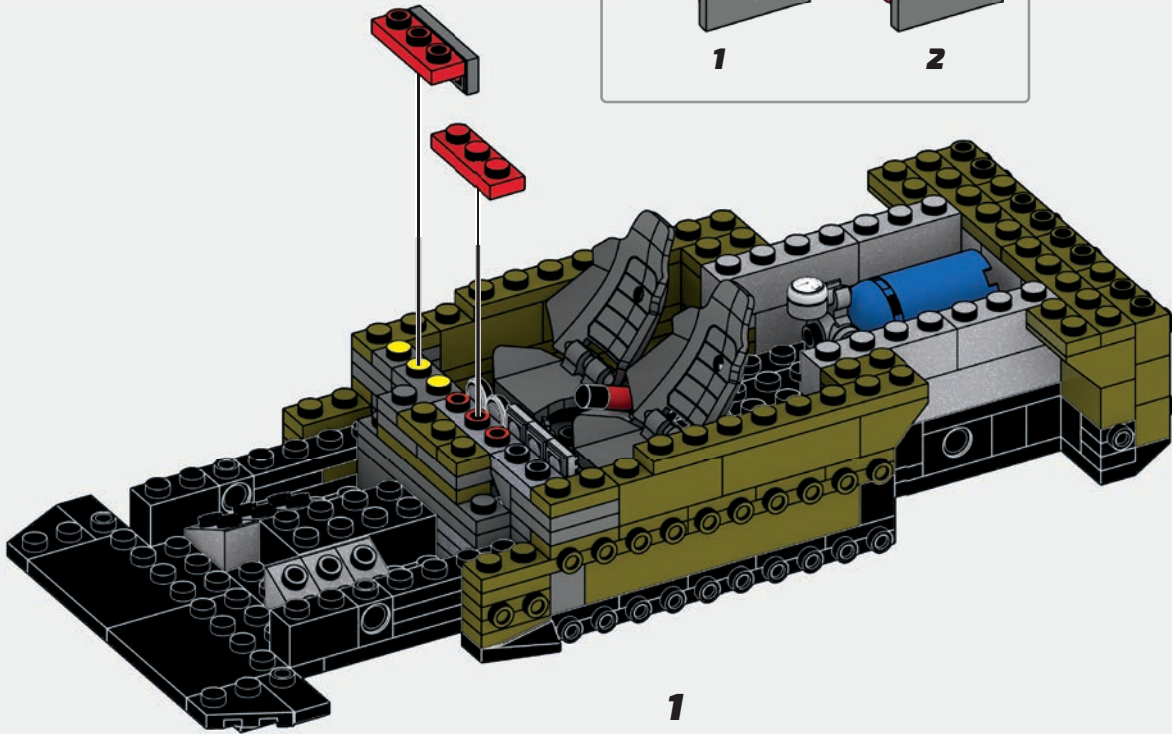

1

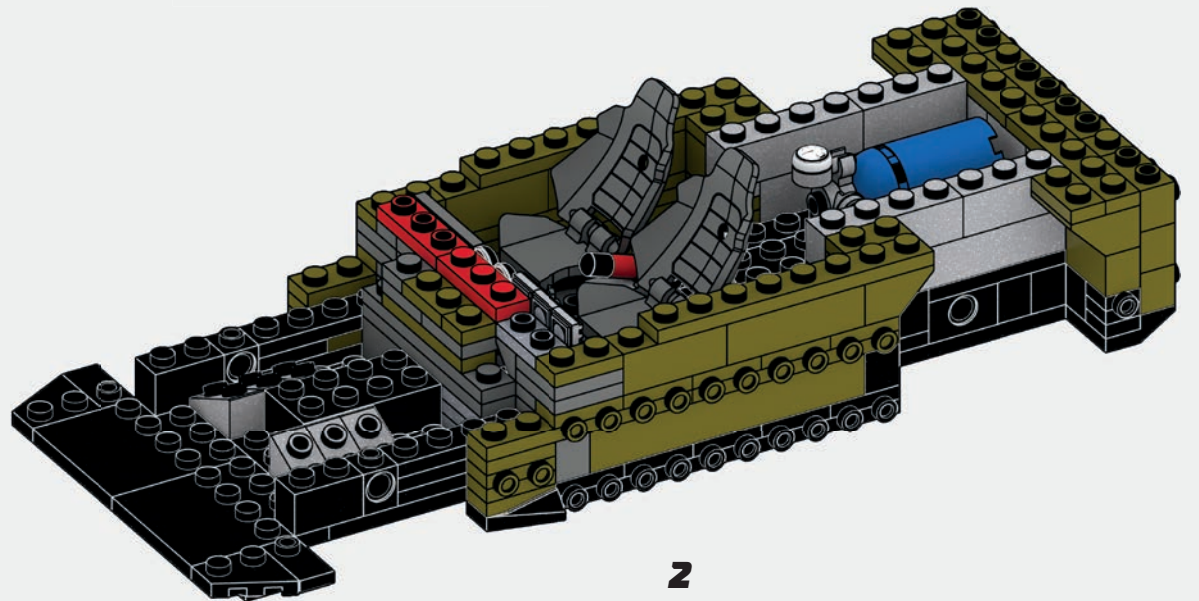

2

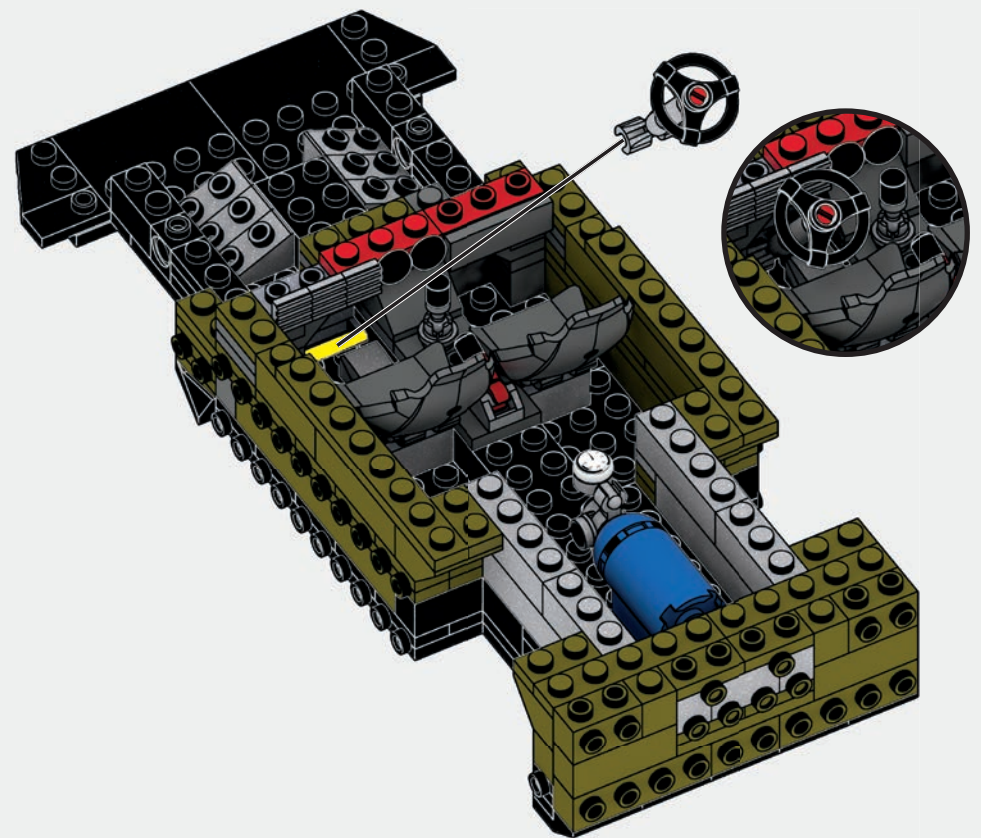
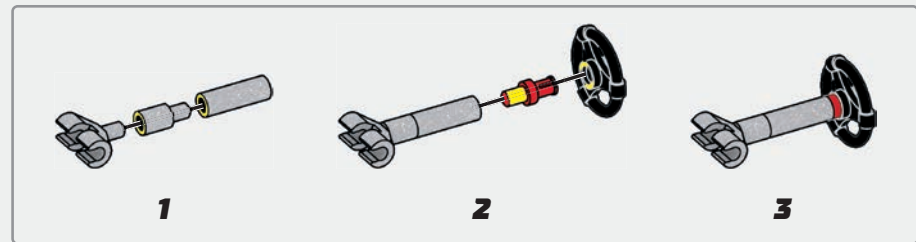
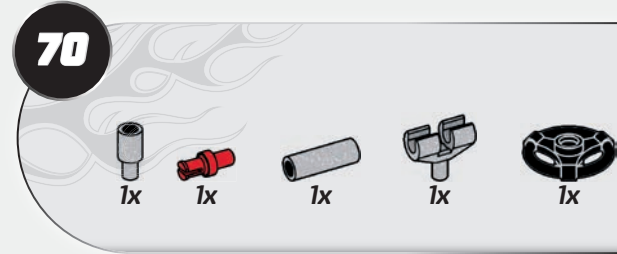
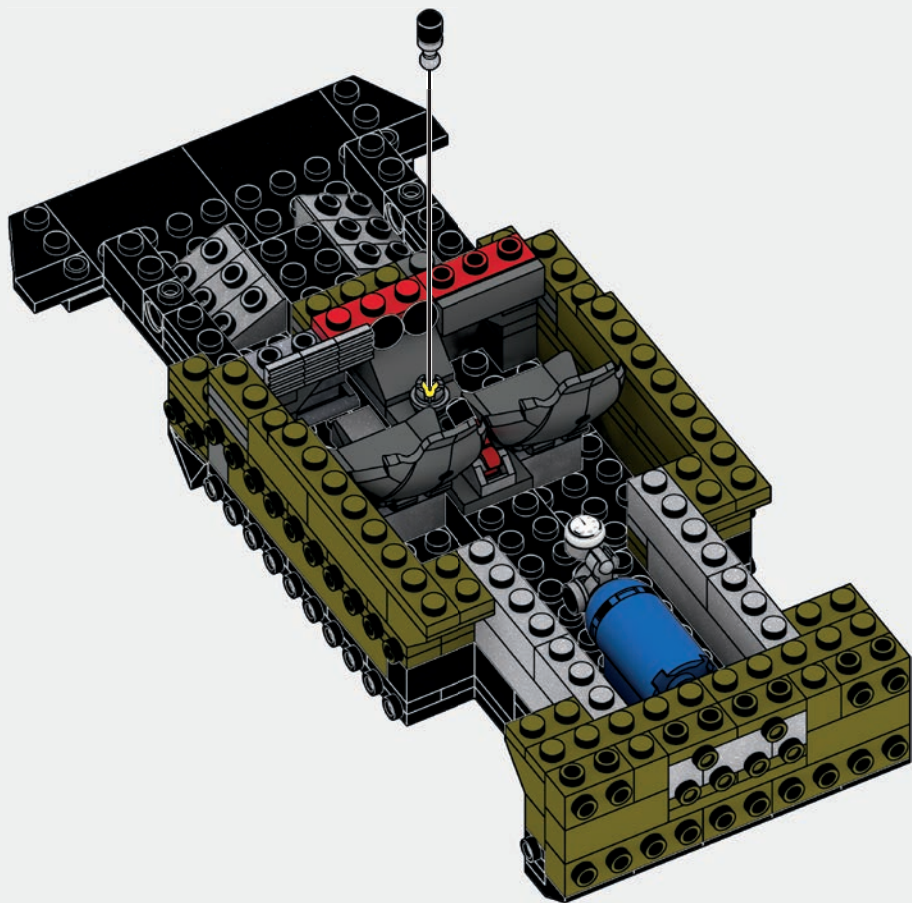
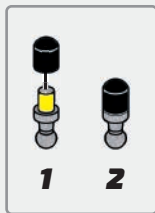

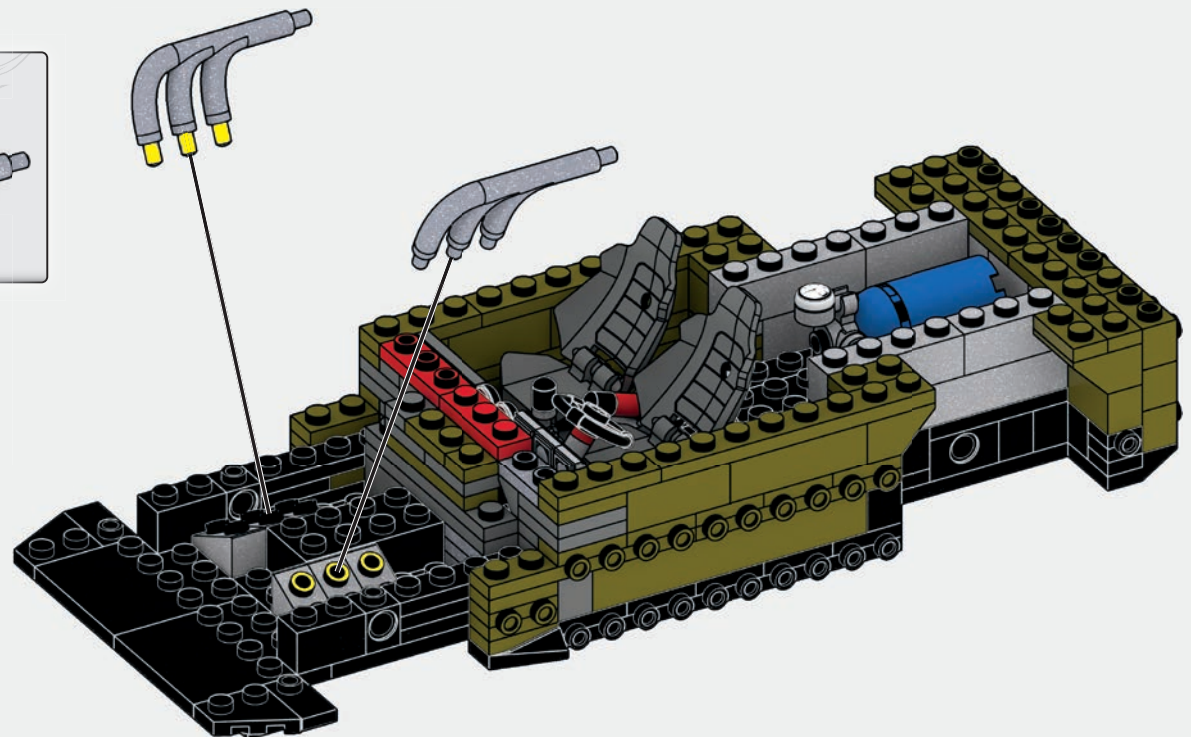
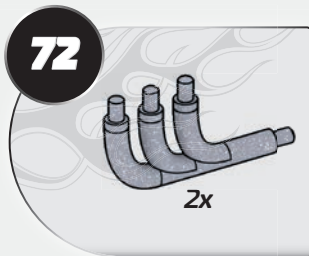
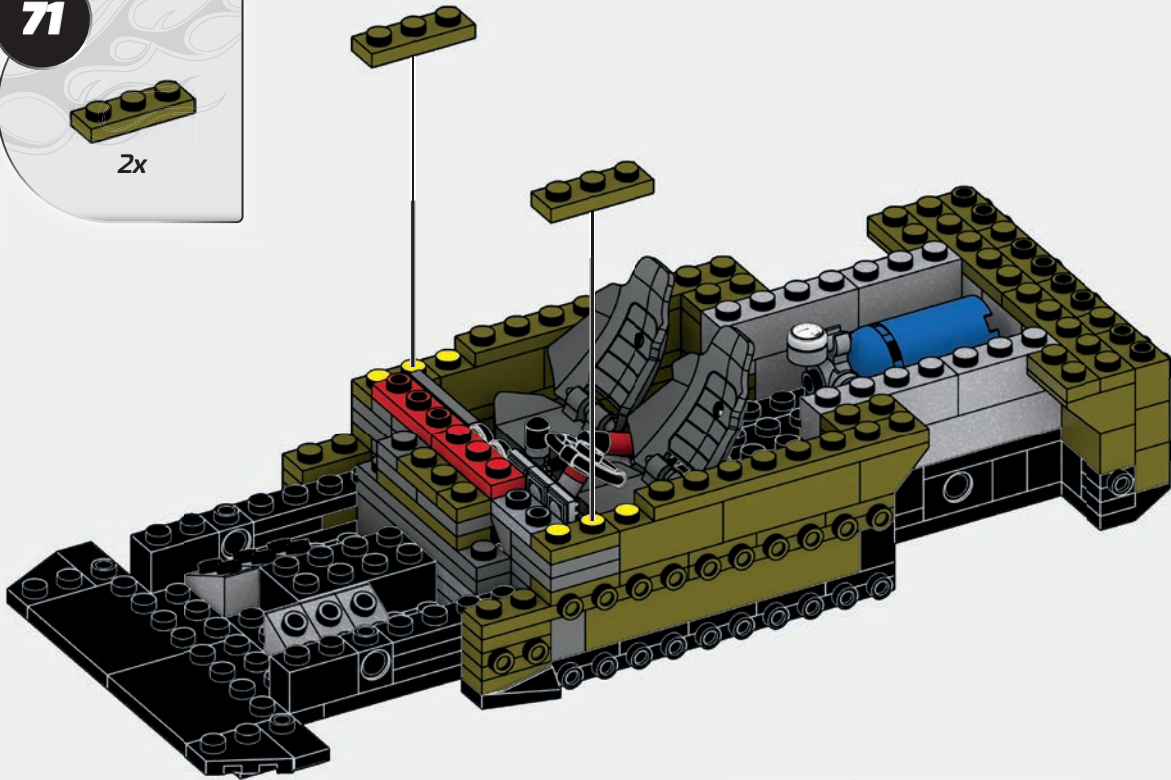

73



1x



1x



1x

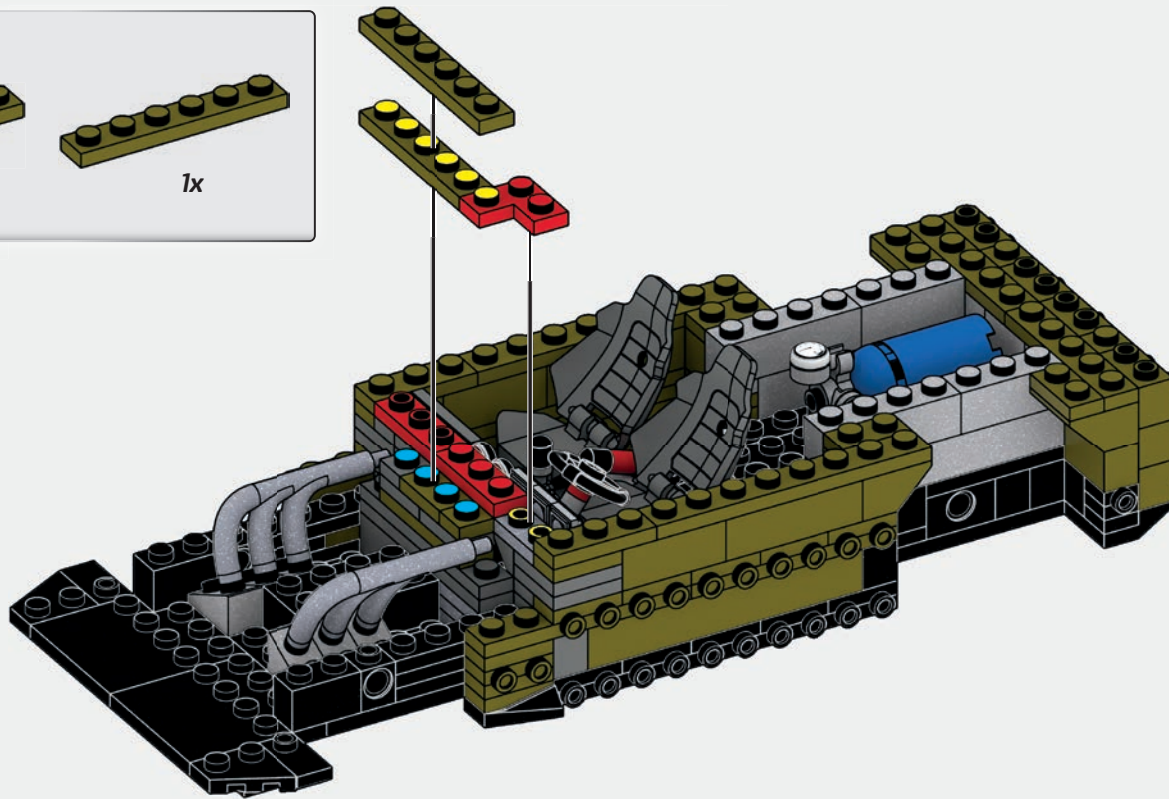

74



1x



1x

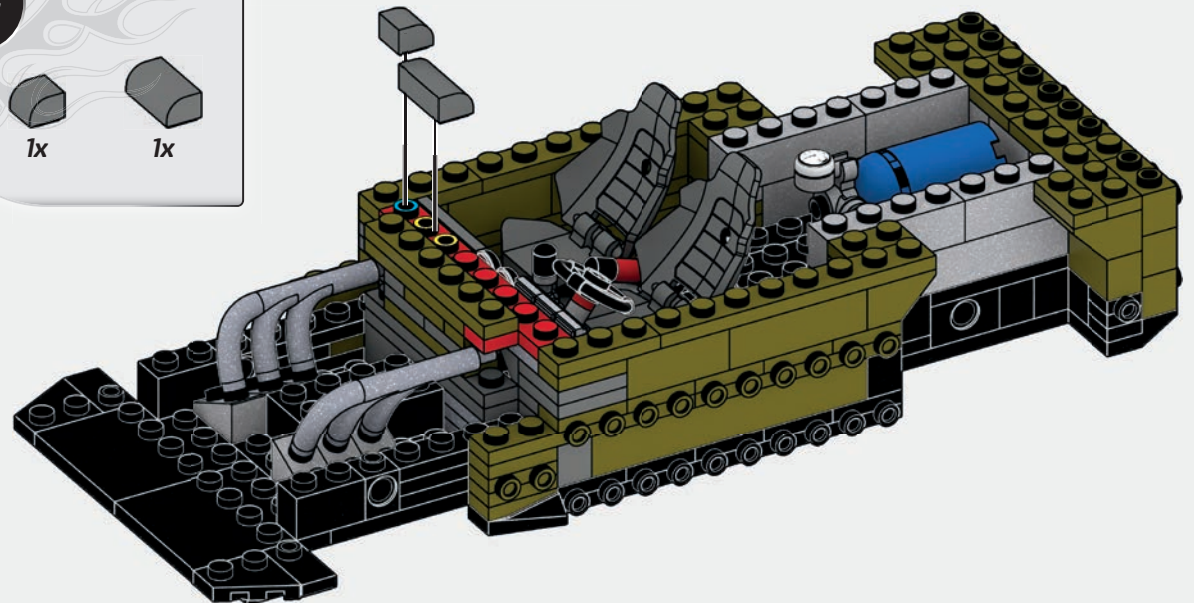

75

1x 2x

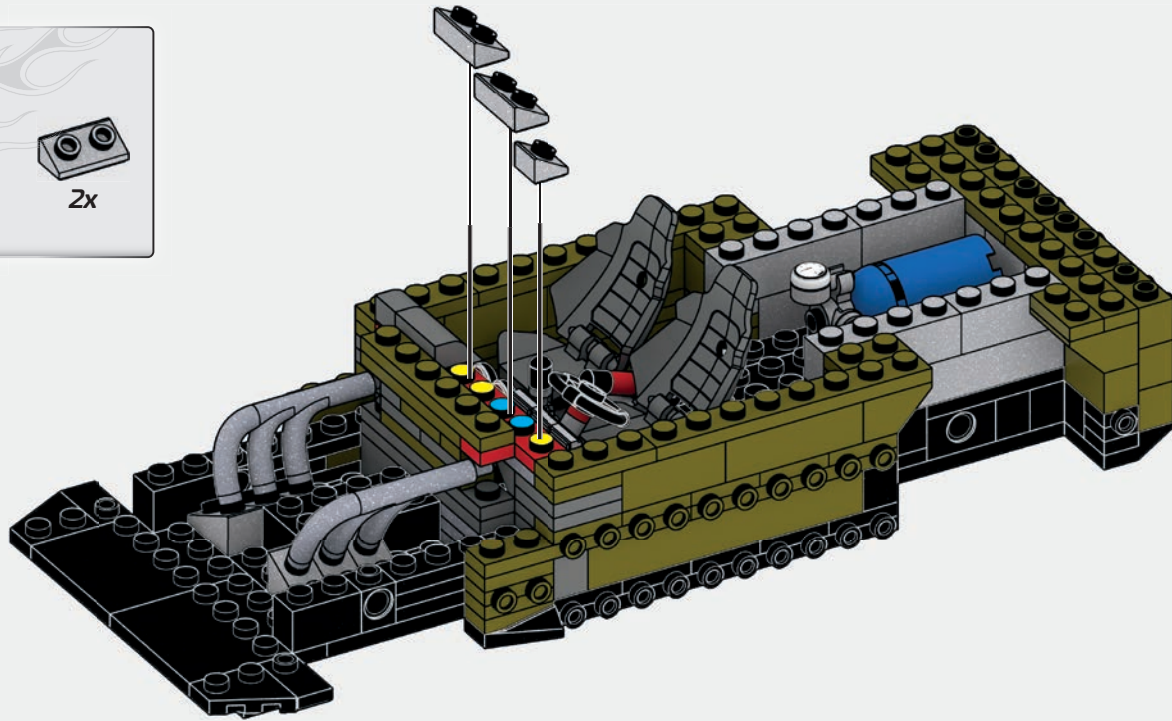

76

1x 1x 1x

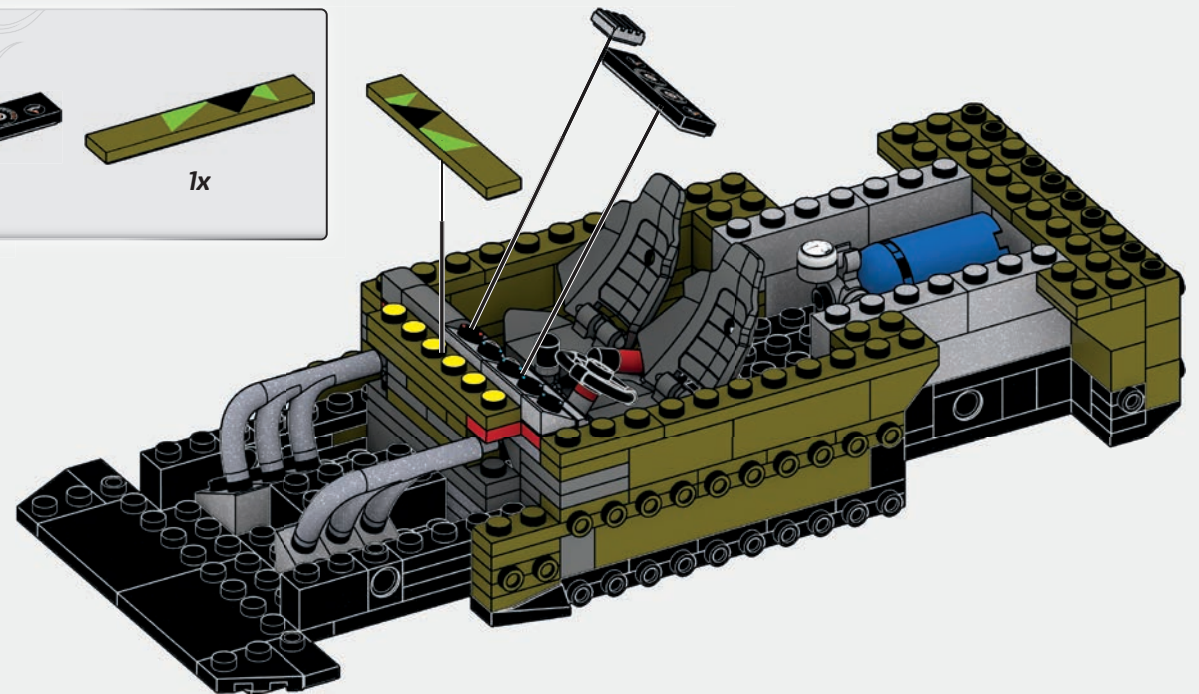

77

2x 4x

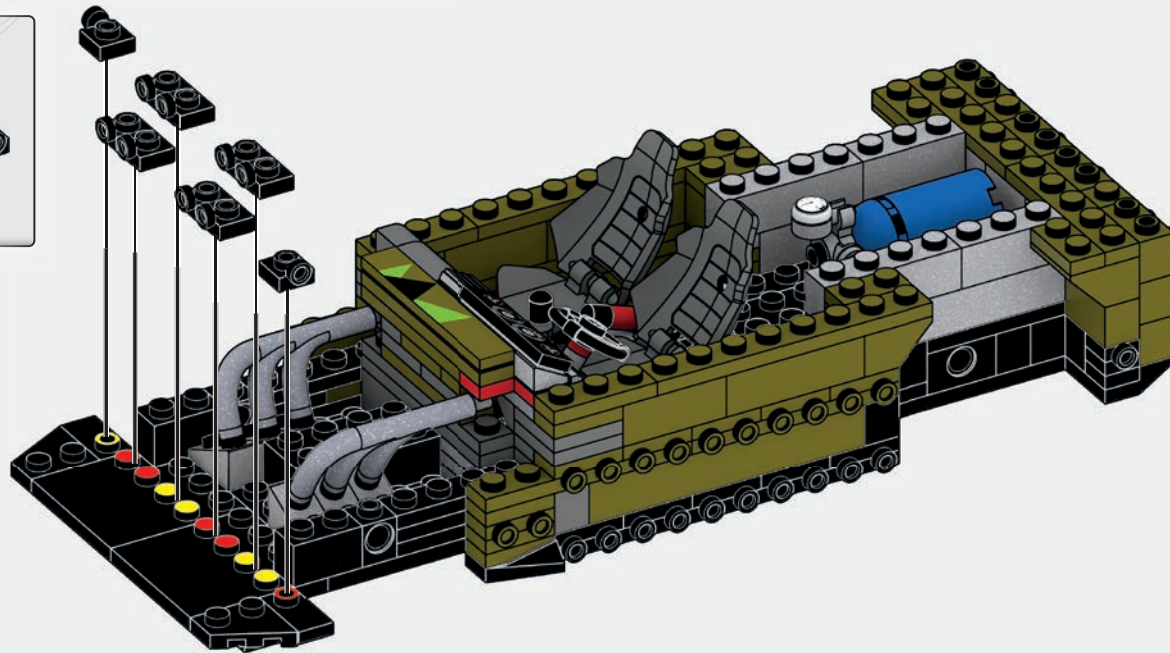

78

2x 2x

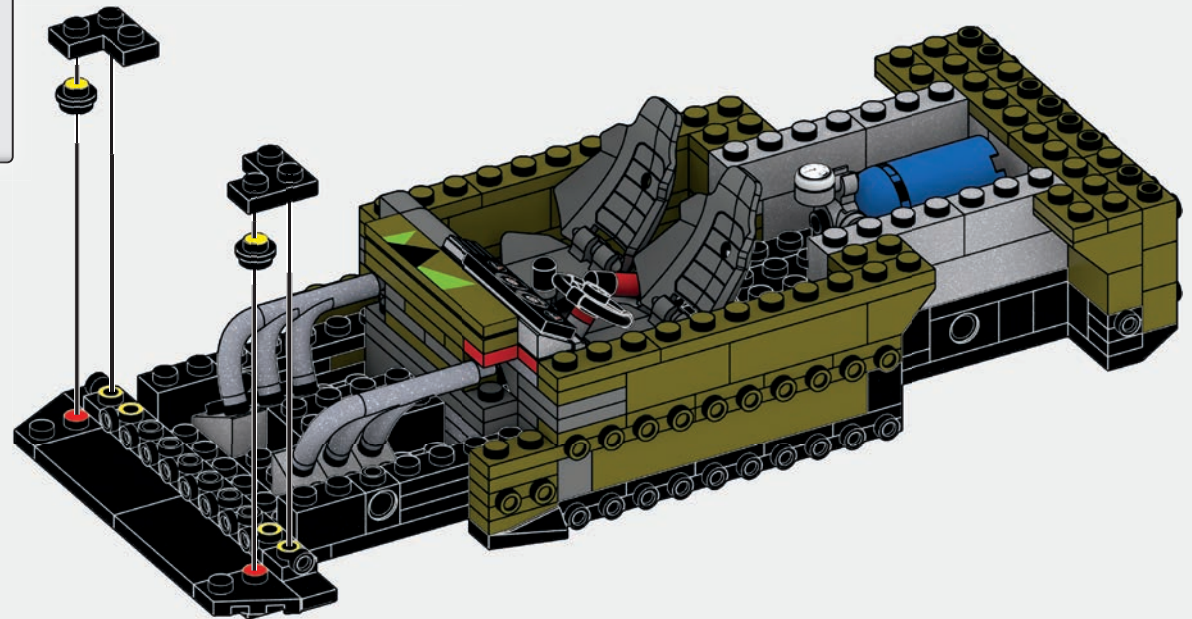

79

2x 2x

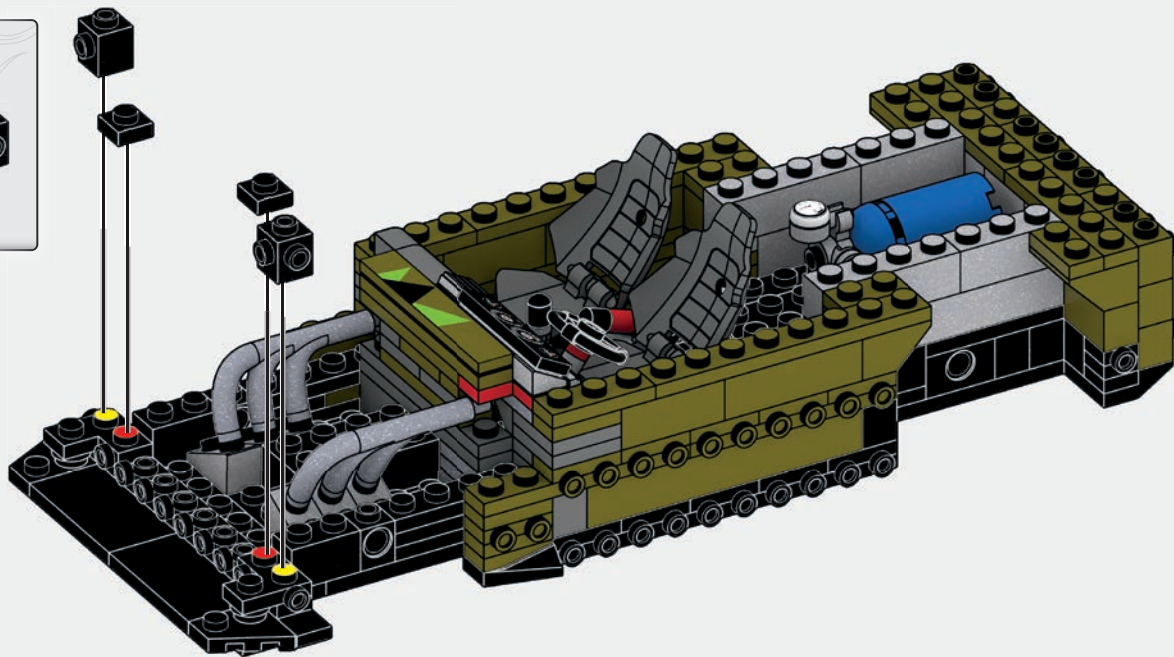

80

2x

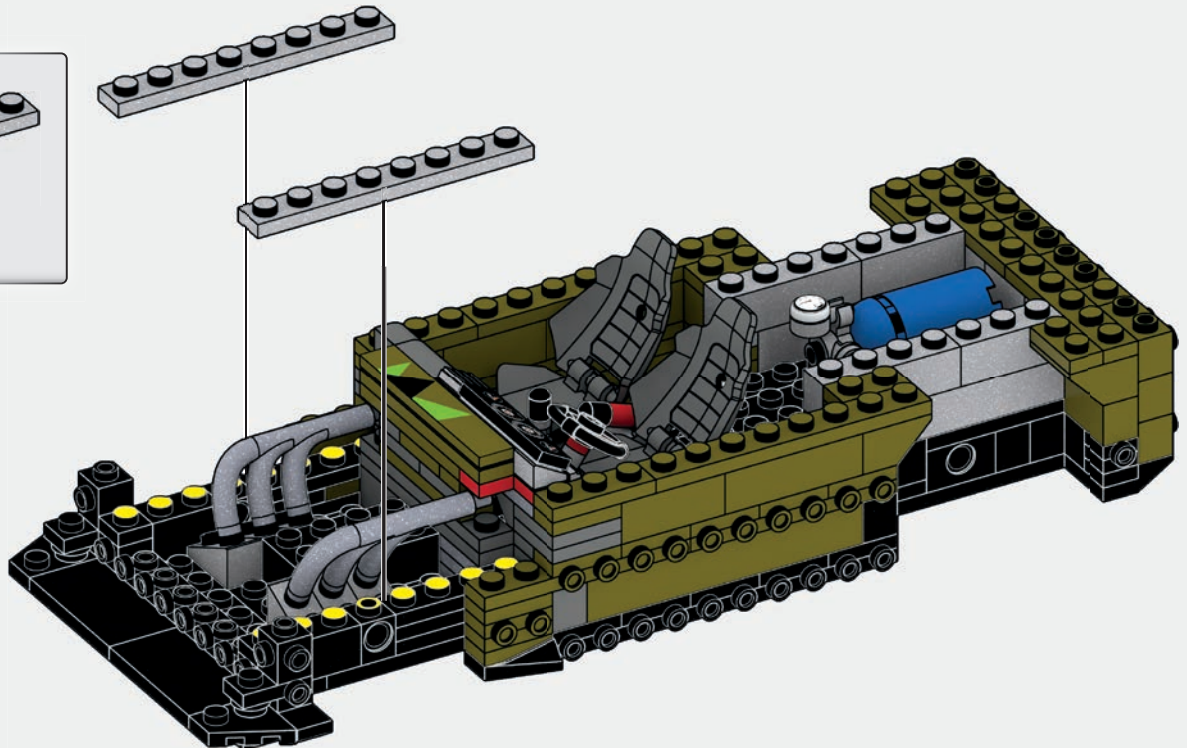

81

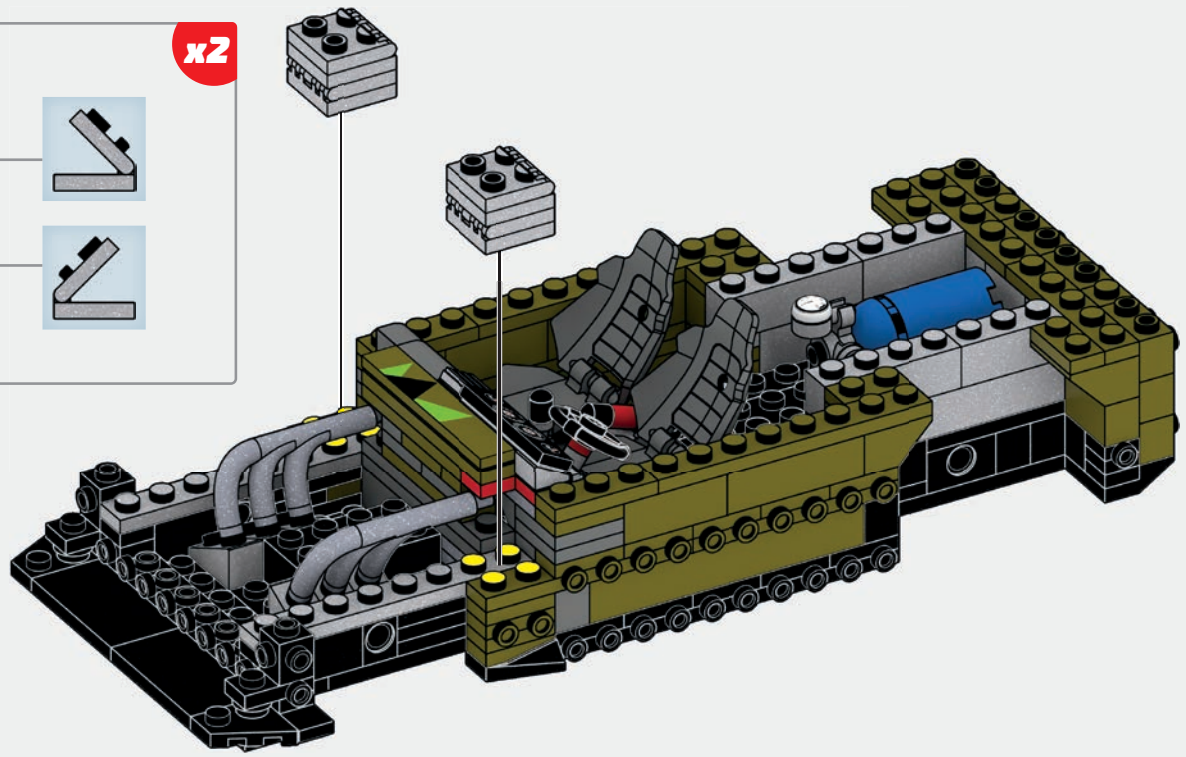
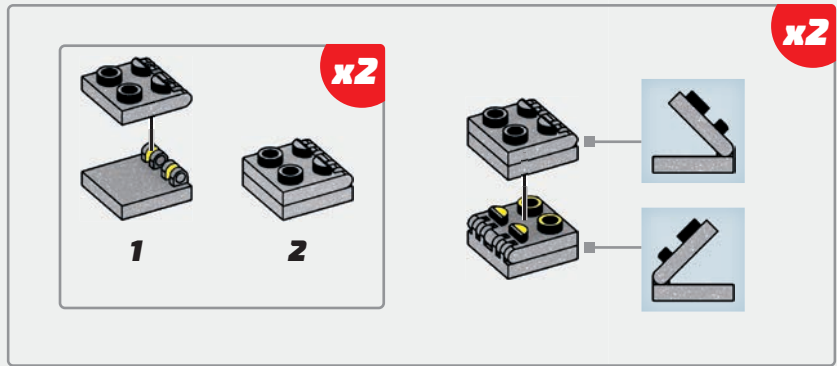

82

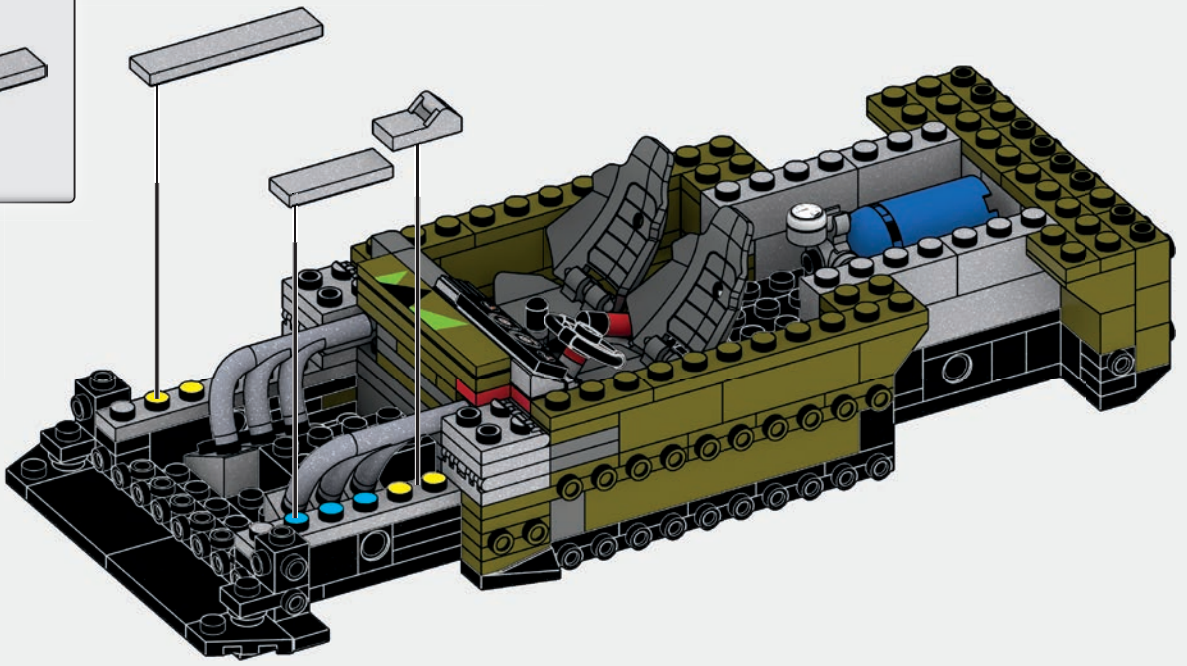
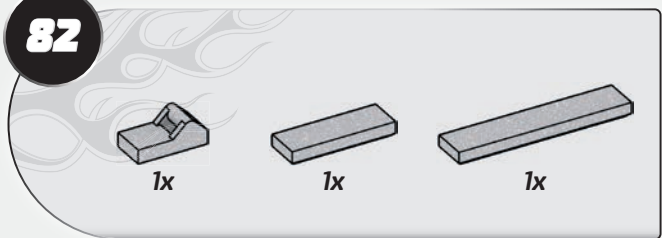

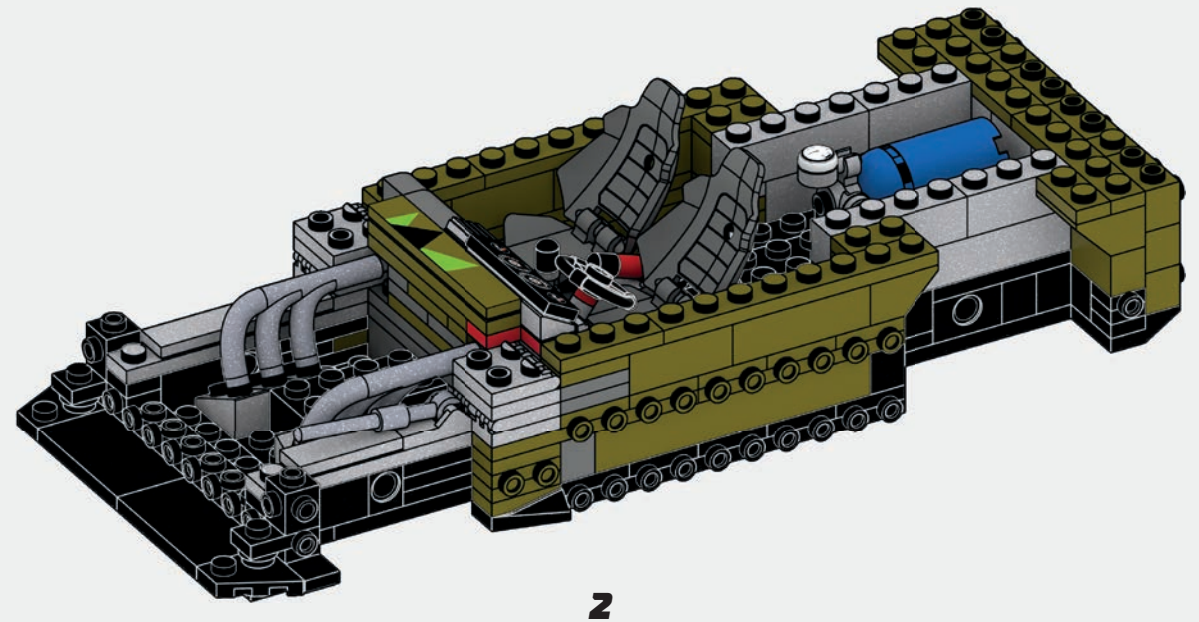
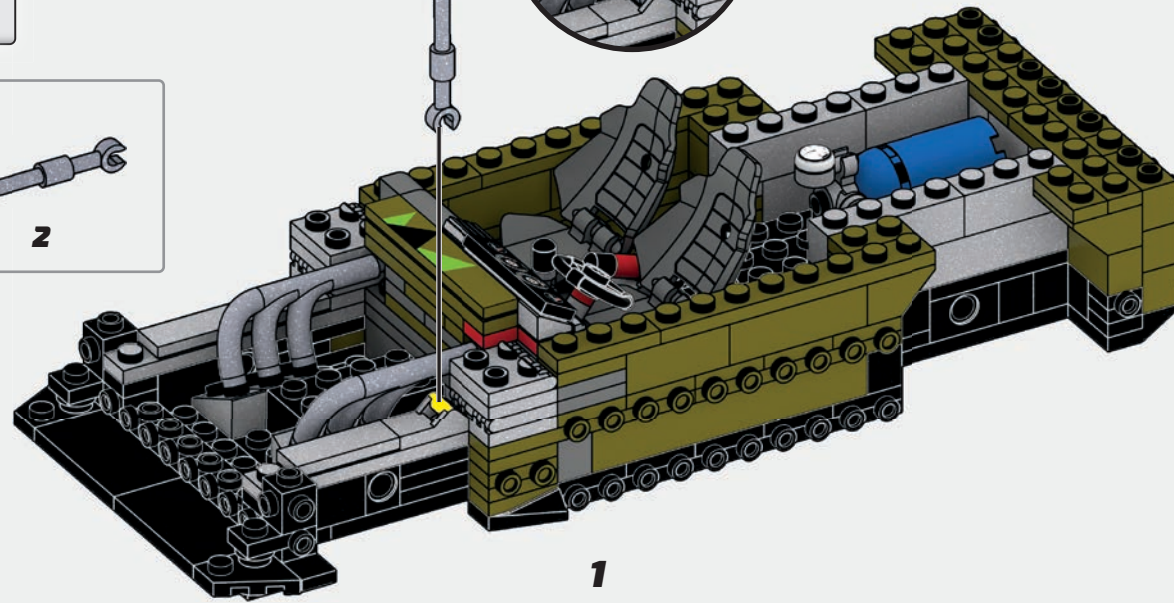
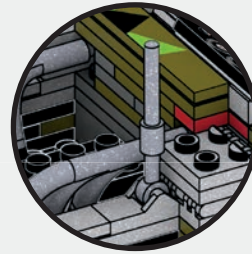
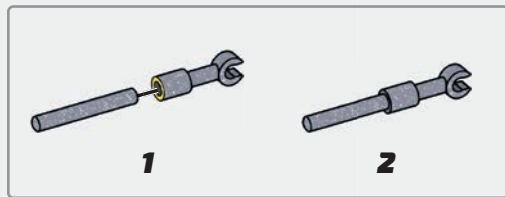
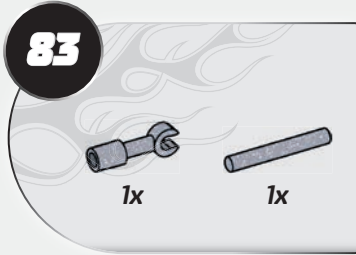

84

1x 1x 2x

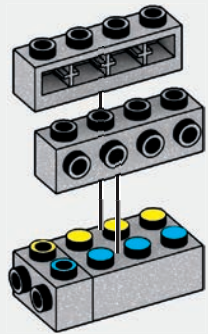

85

2x 2x 2x

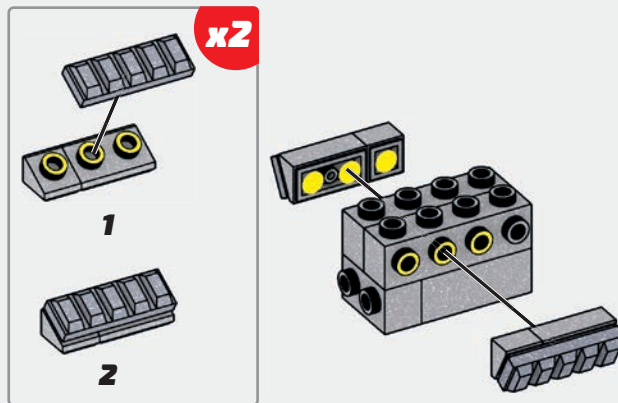

86

2x 1x

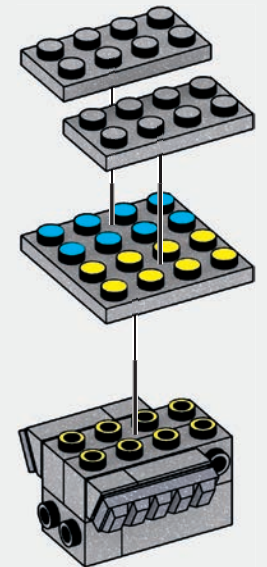

87

1x 1x 1x

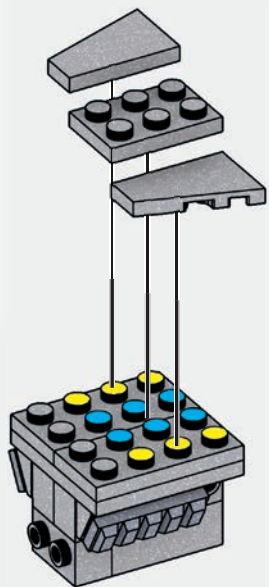

88

1x 1x

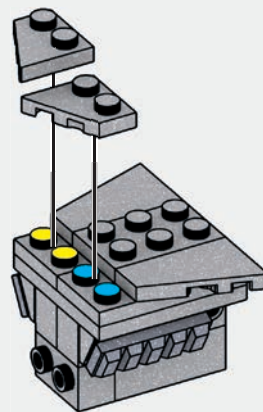

89

1x 1x

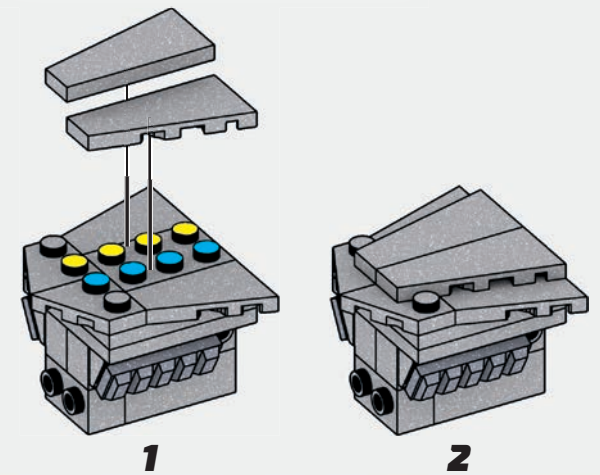

90

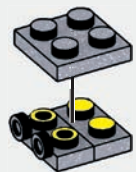
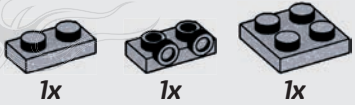

91

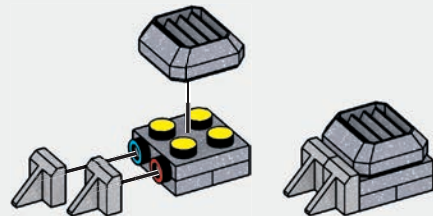
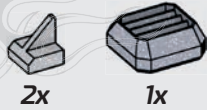

1 2

92

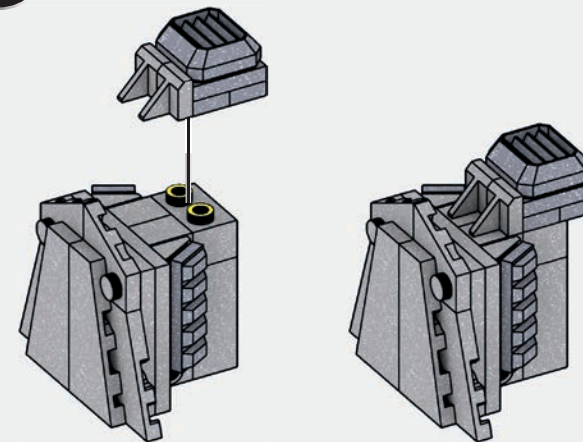

1 2

93

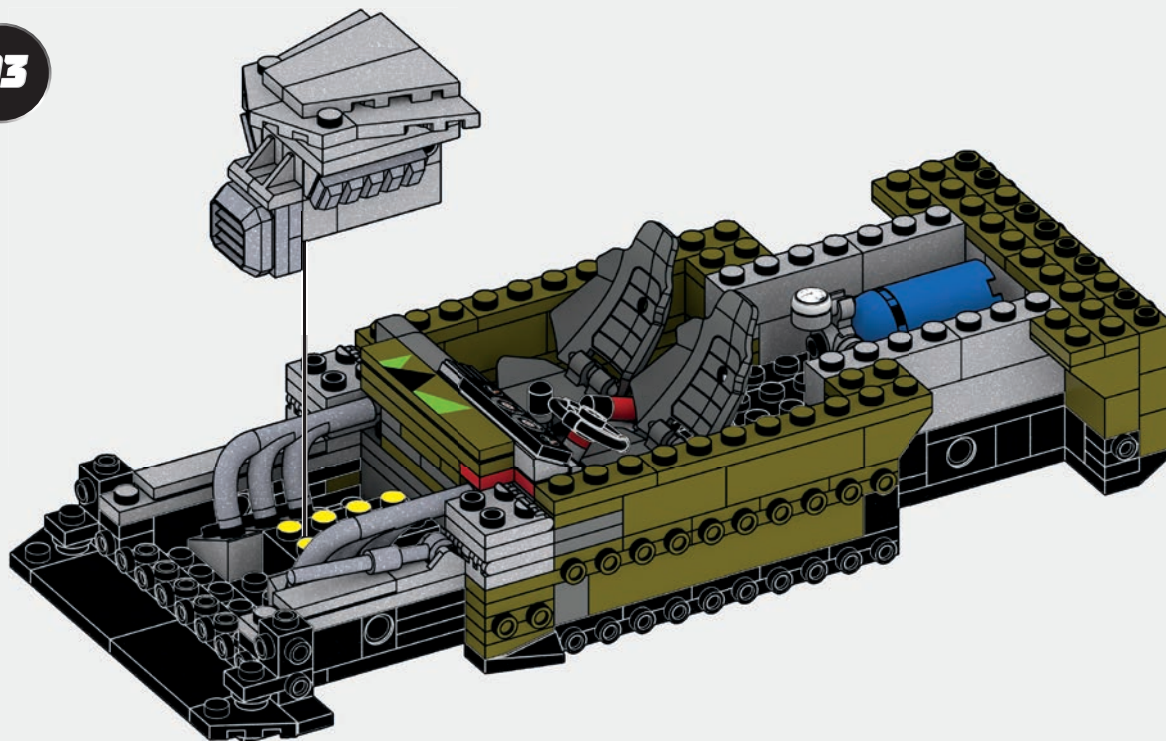

94



2x



2x

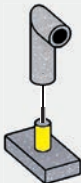

1



2

x2

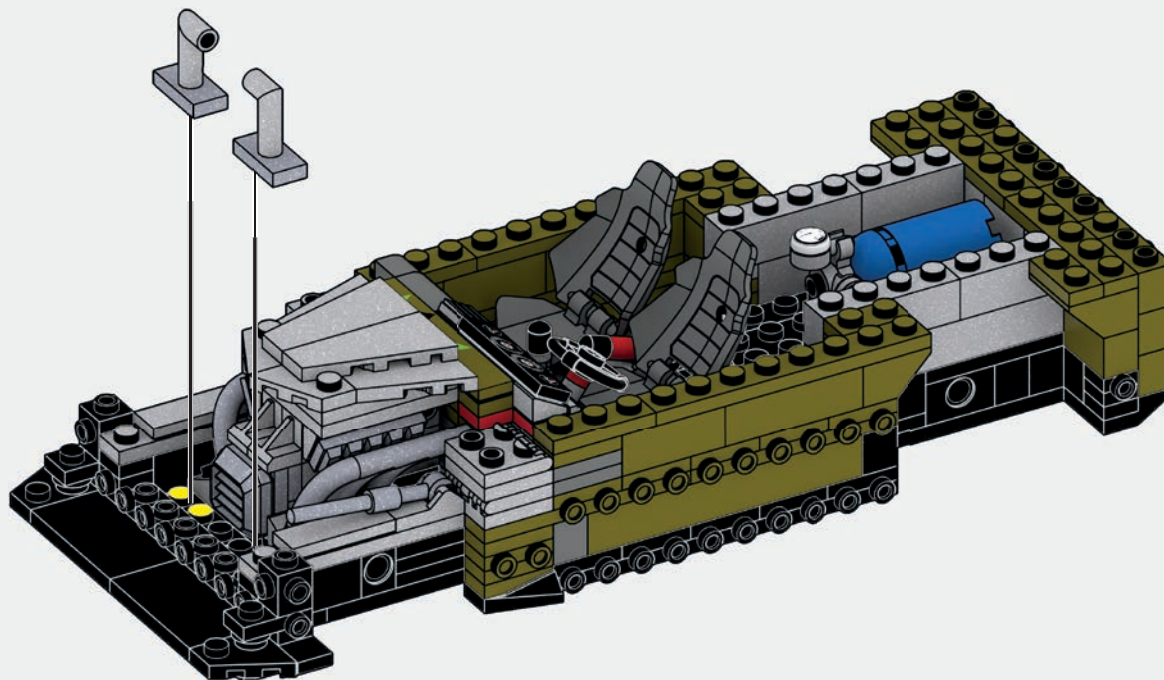



95

2x 1x 1x

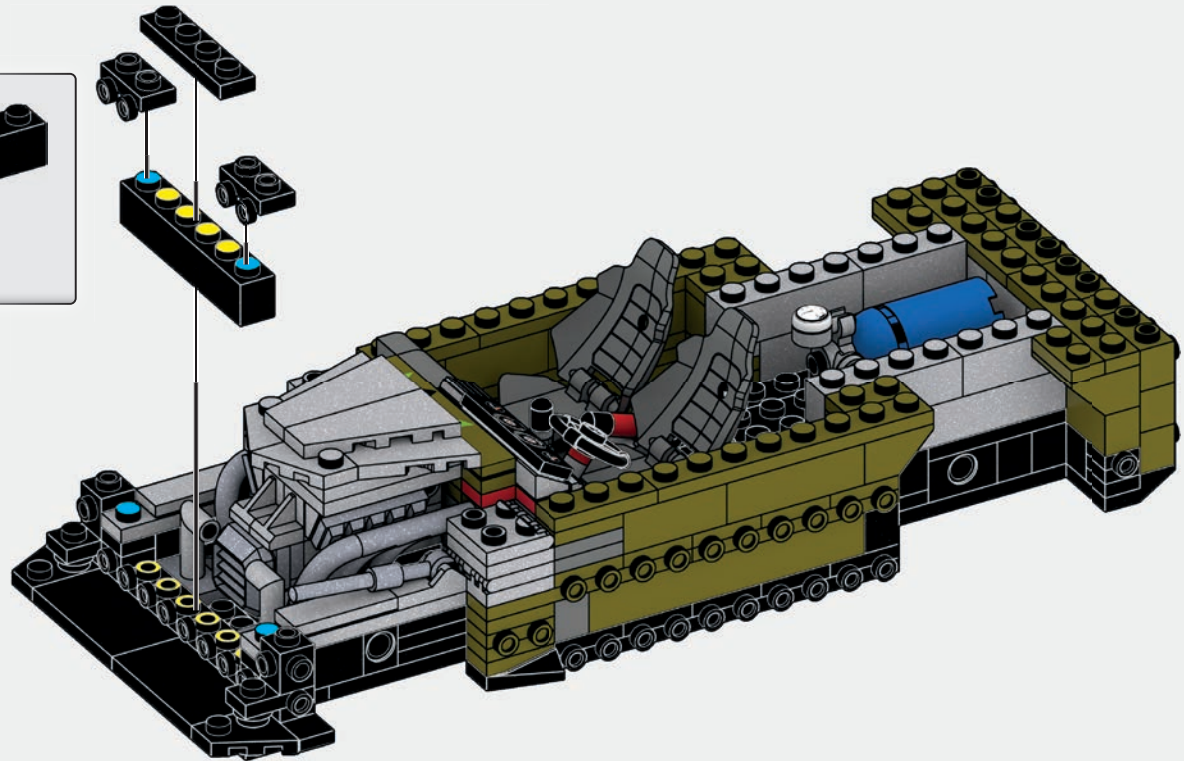

96

3x

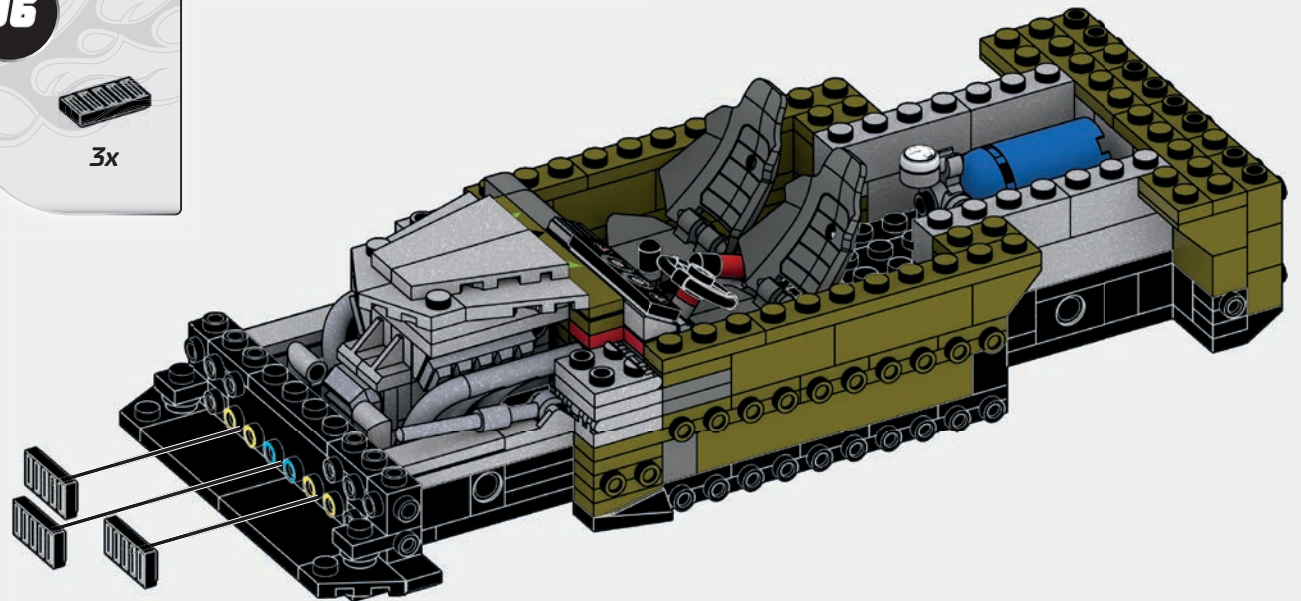

97

2x

2x

x2



1



2

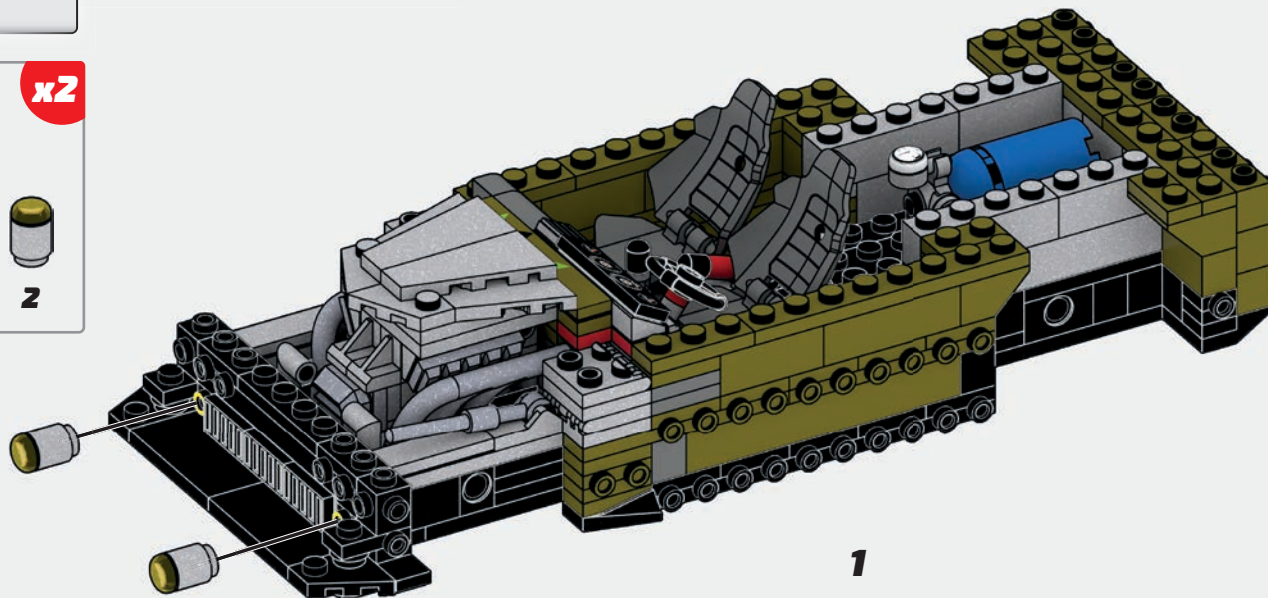

1

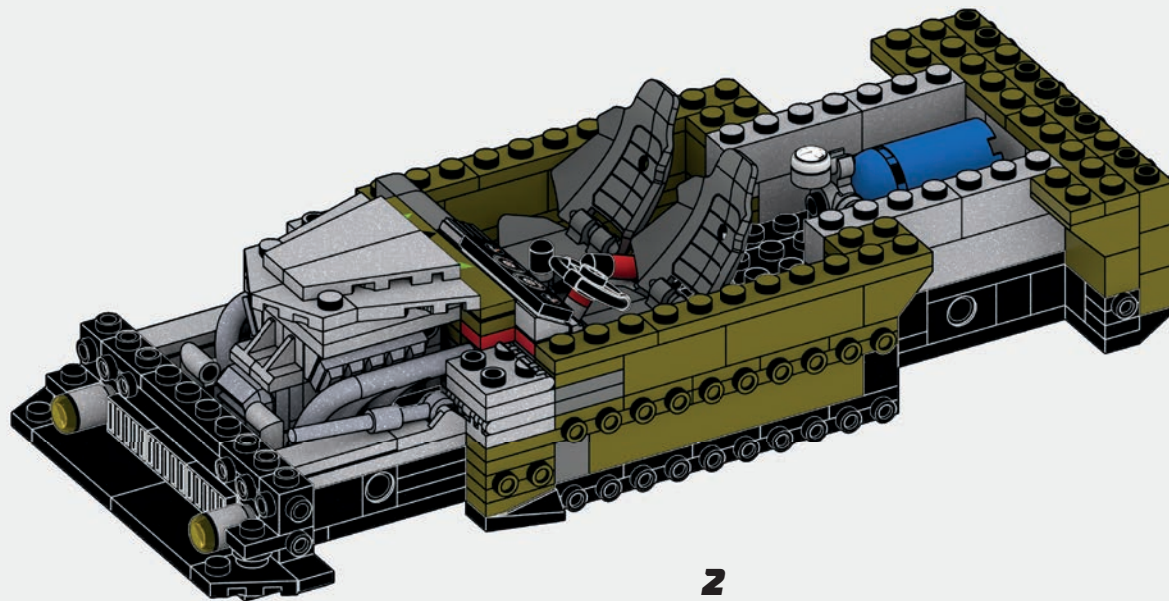

2

98

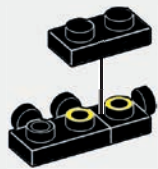

99

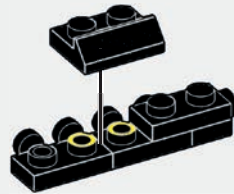
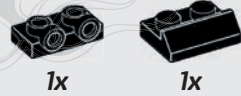

100

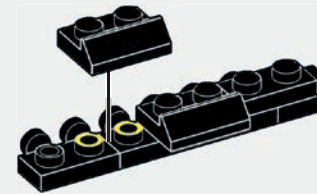
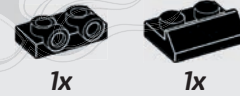

101

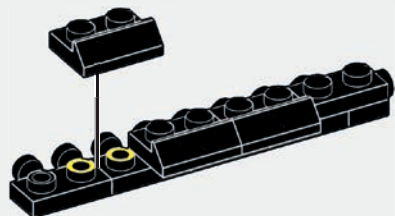

102

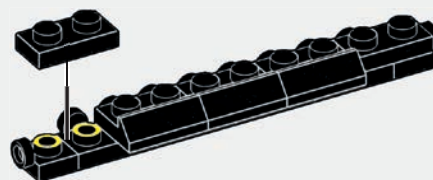
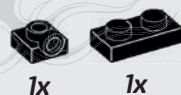

103

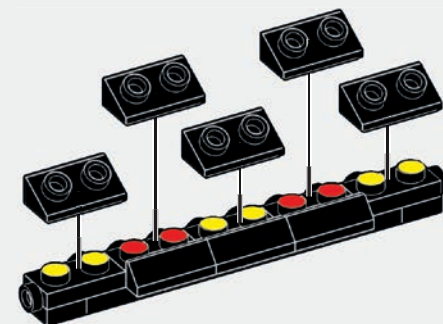

104

2x 1x 1x

1

2

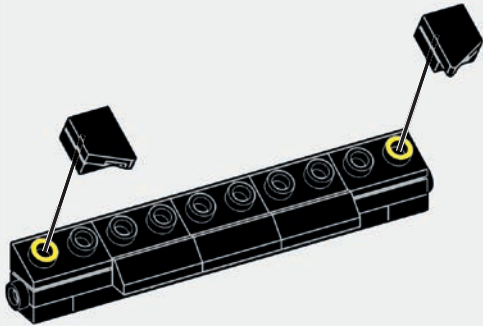

1

2

105

4x

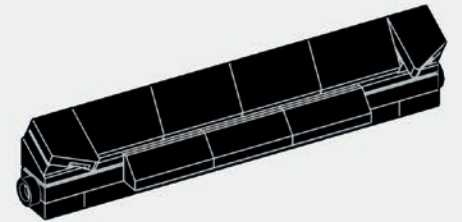
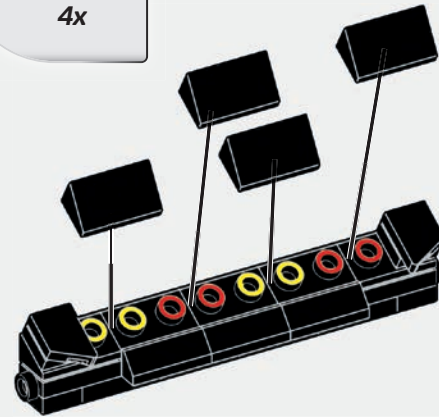

106

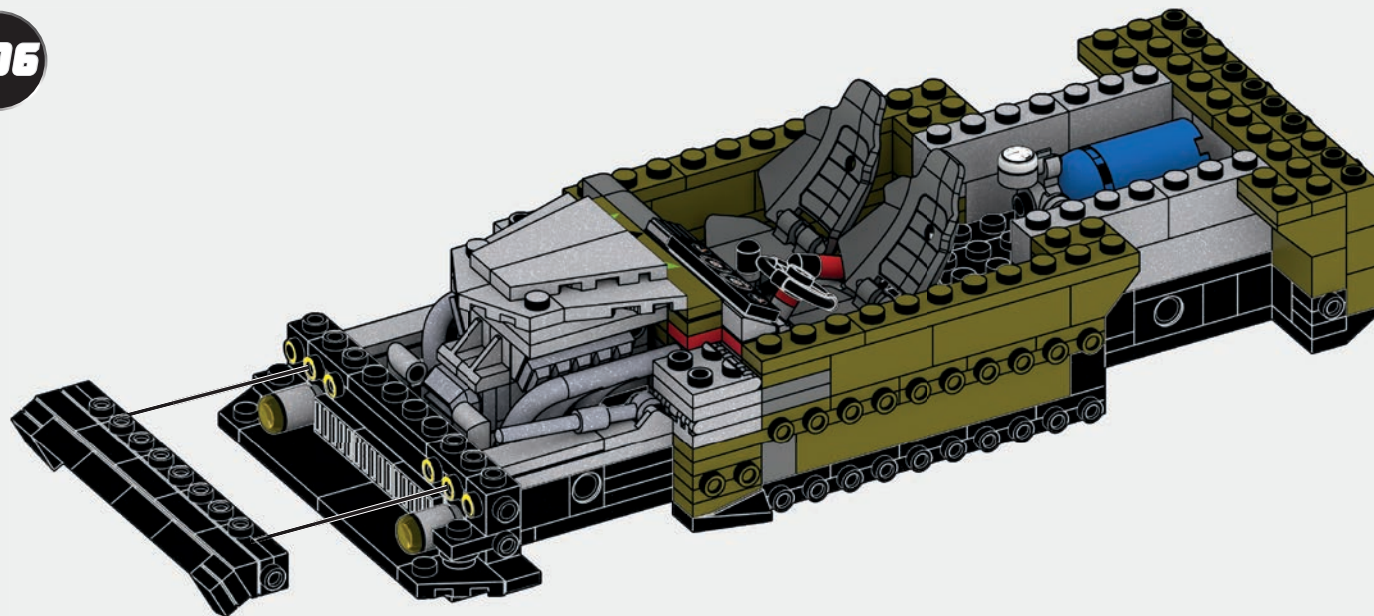

107



2x



2x

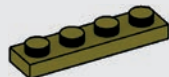

1x

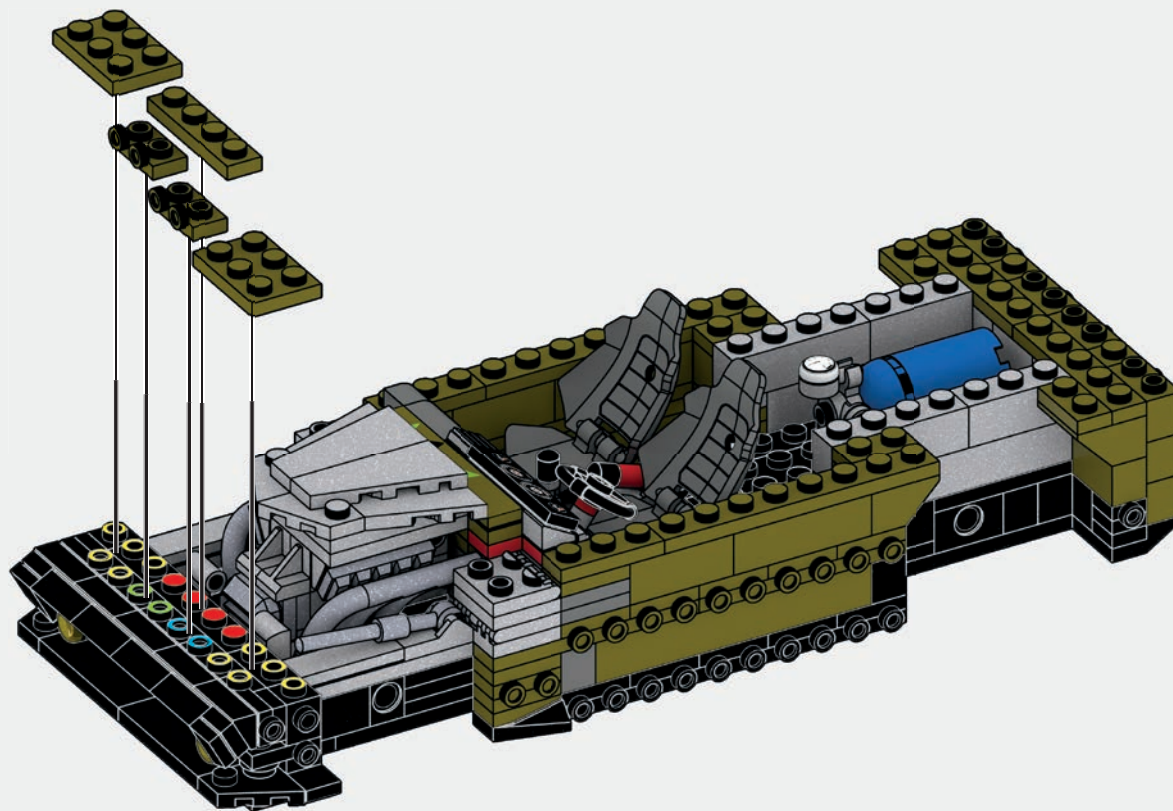

108
4x

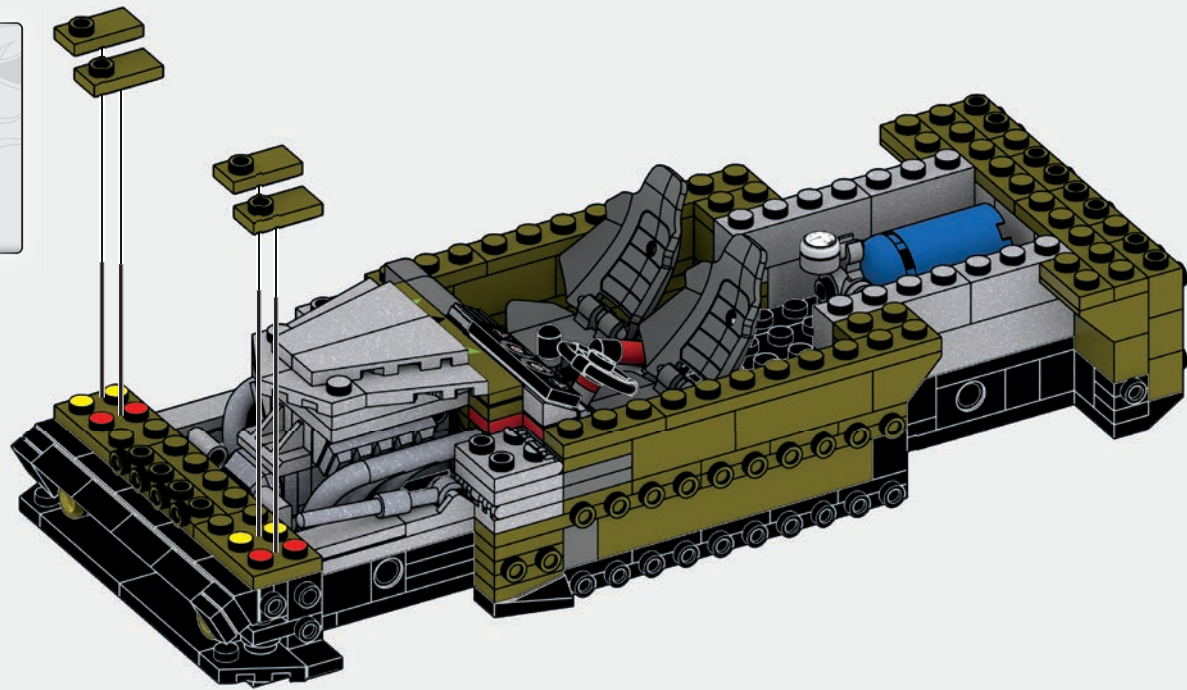

109
2x

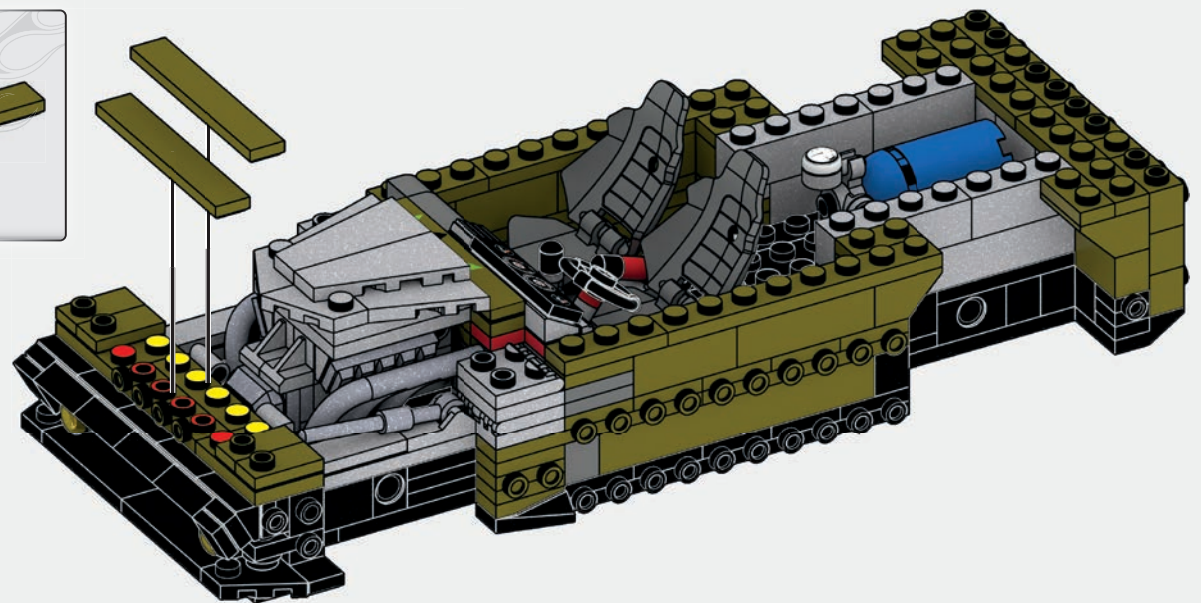

110



4x

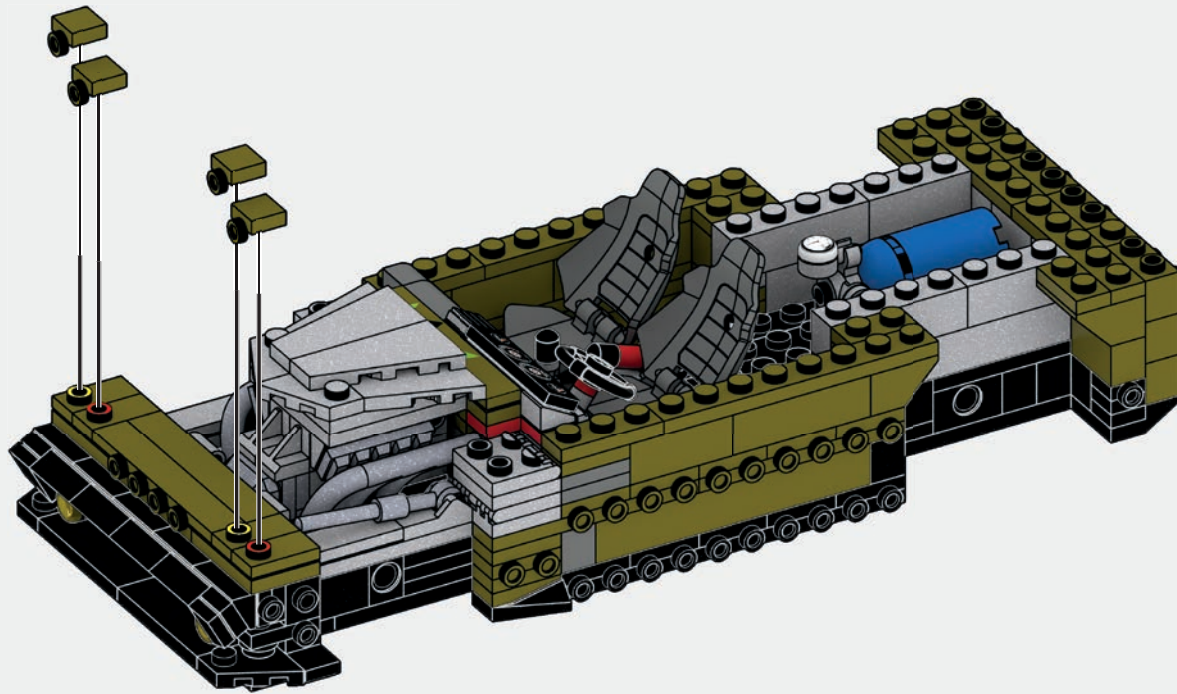

111



2x



1x



1x

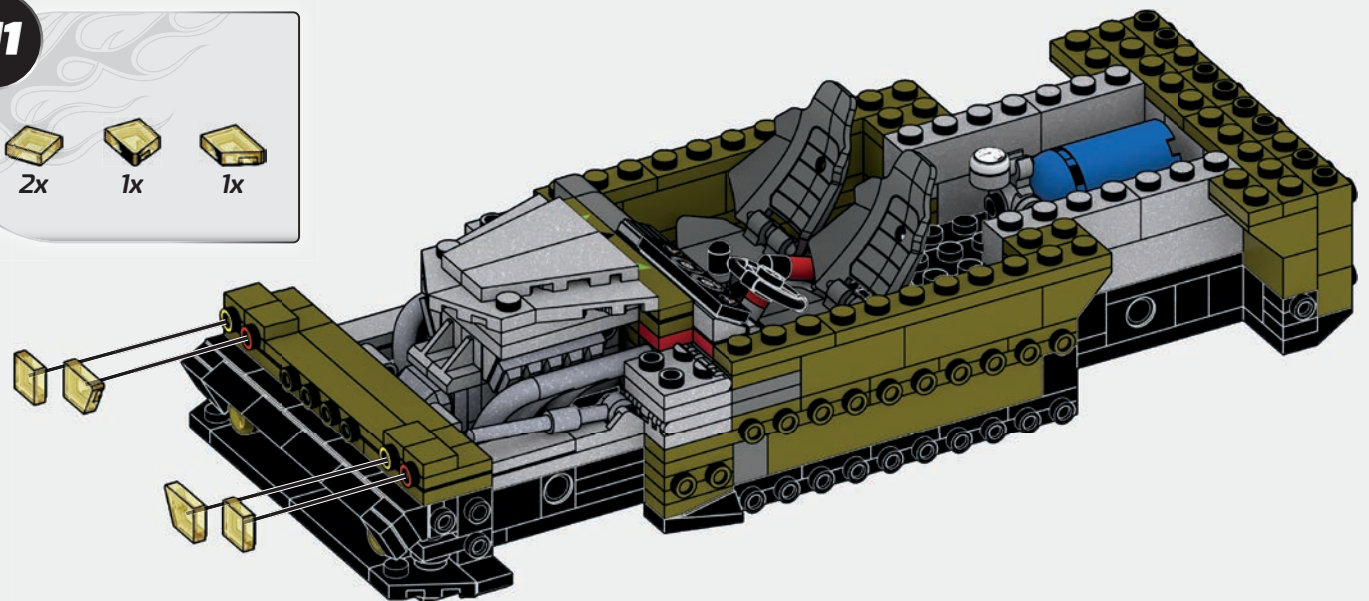

112

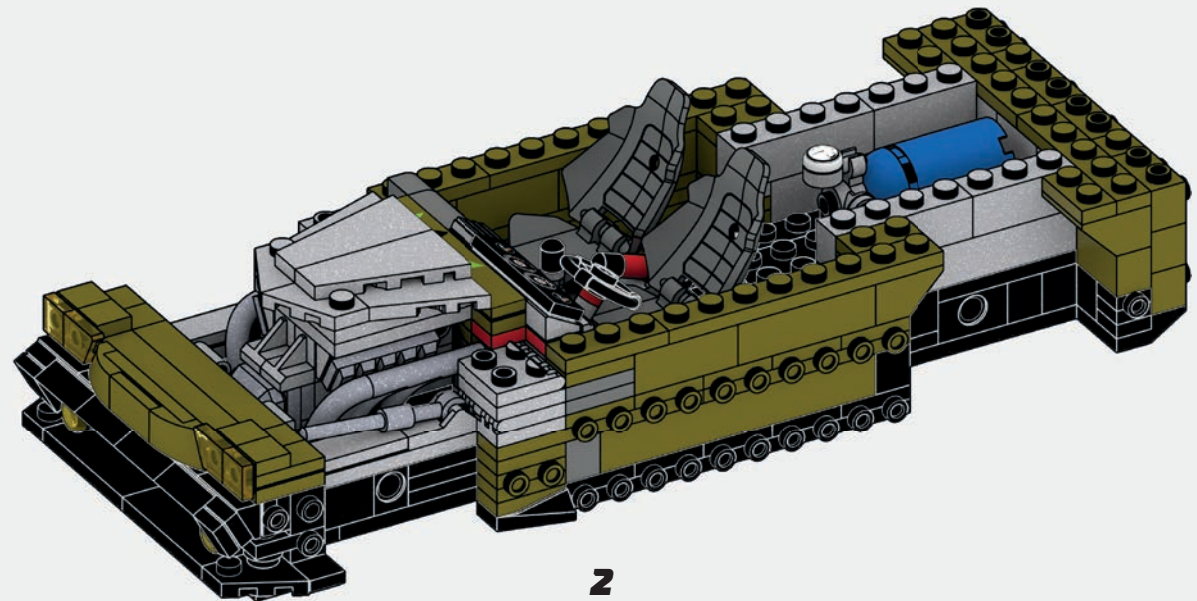
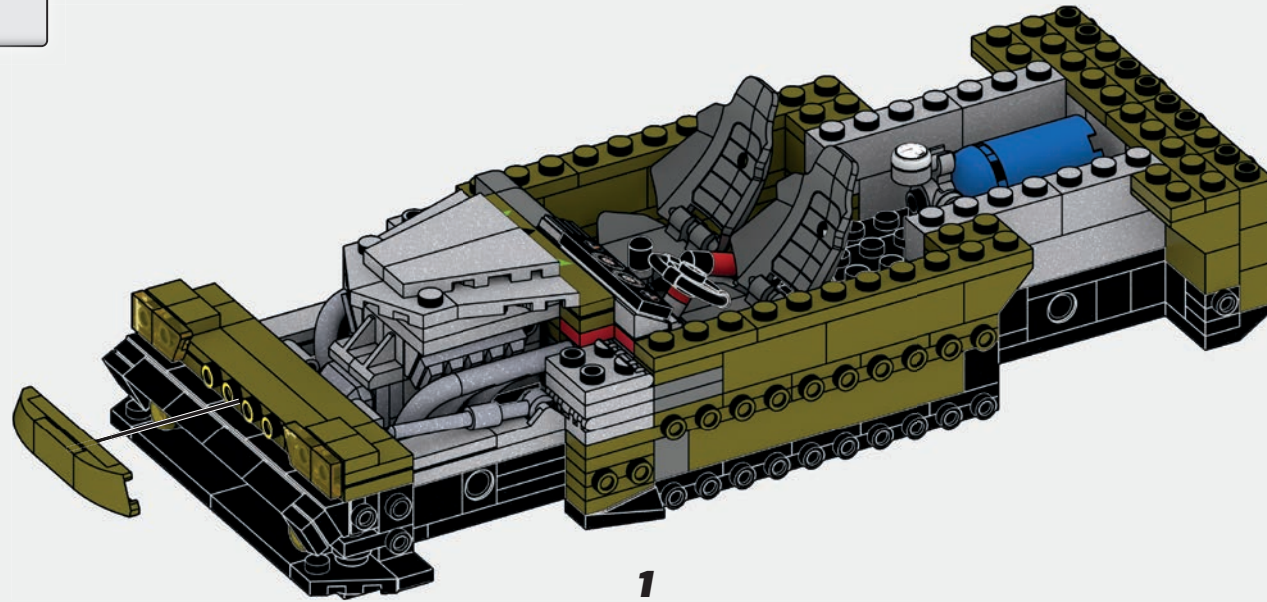
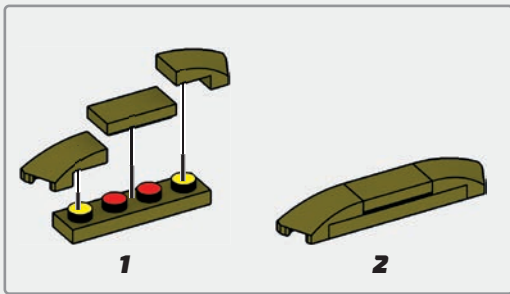

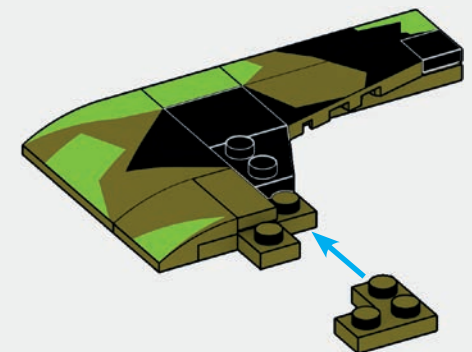
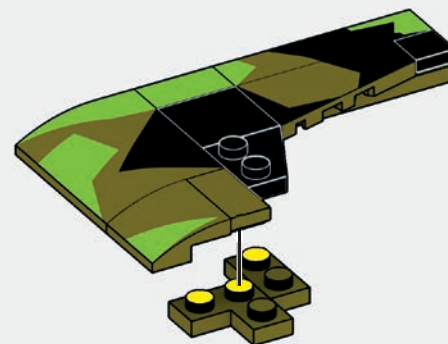
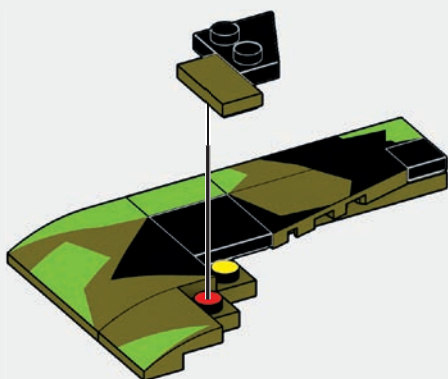
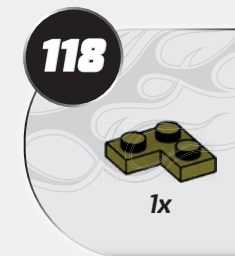
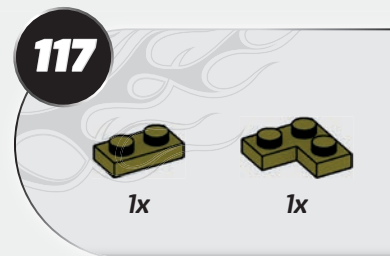
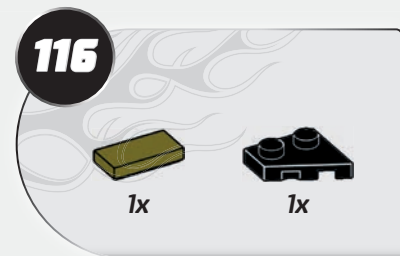
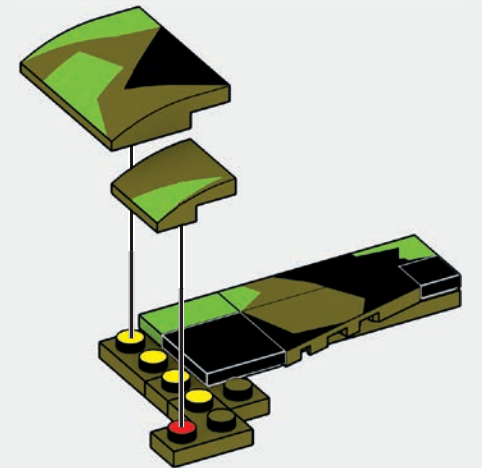
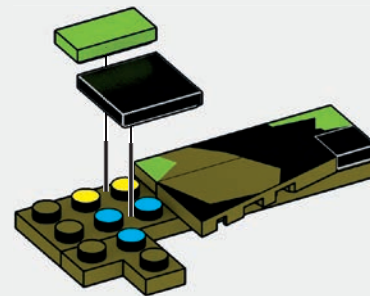
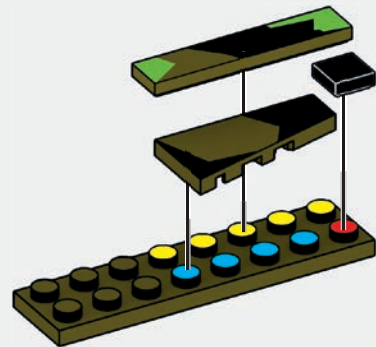
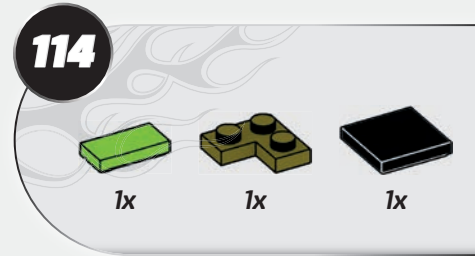
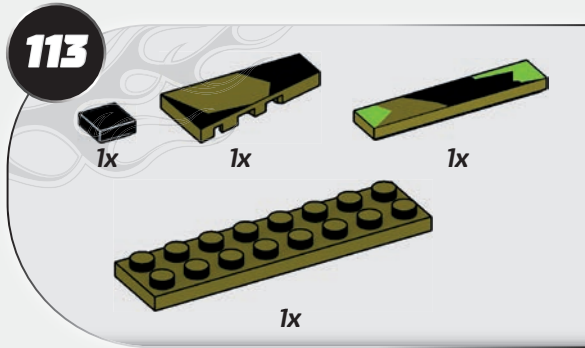

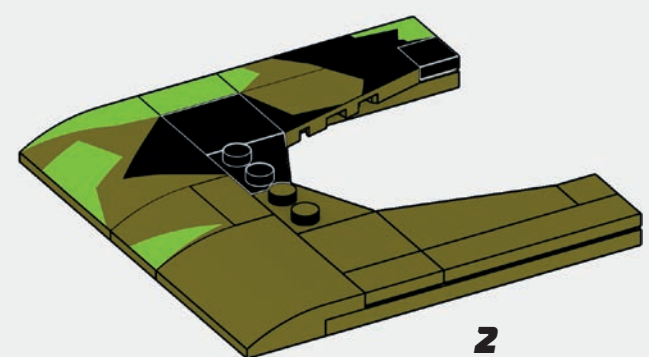
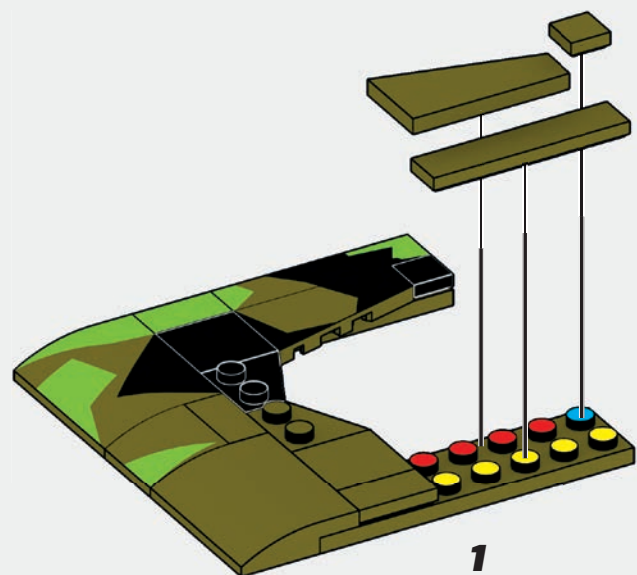
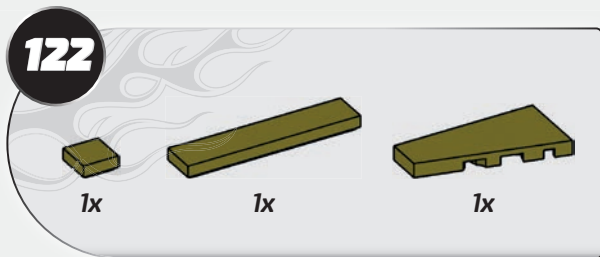
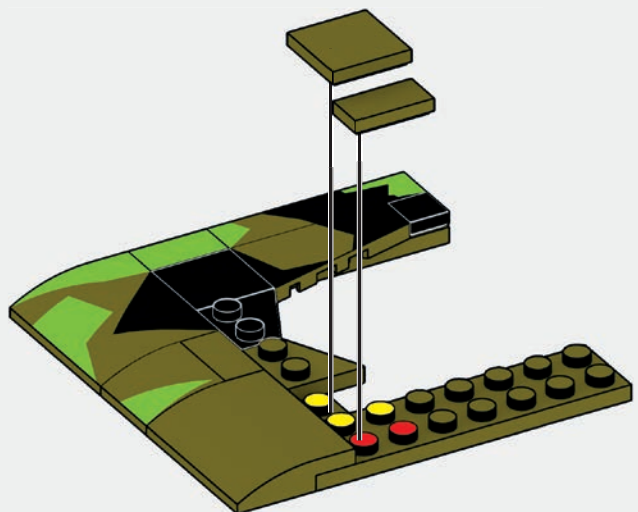
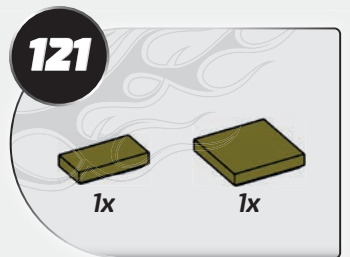
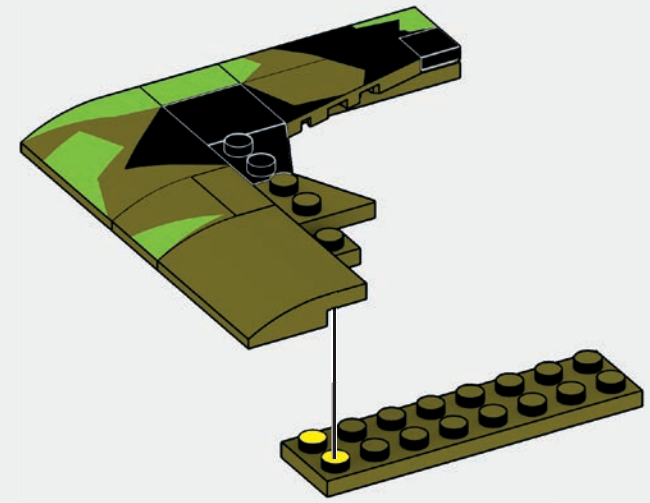
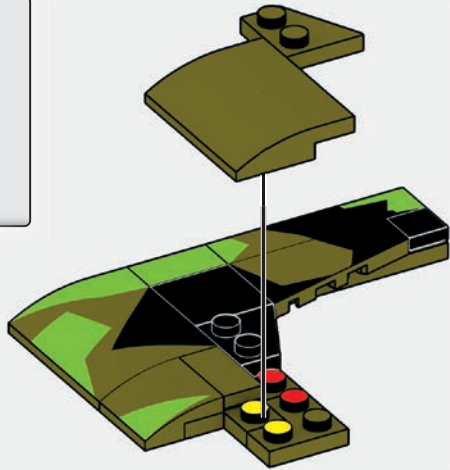
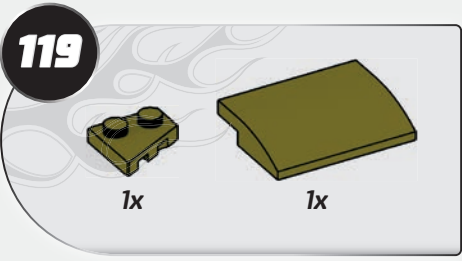

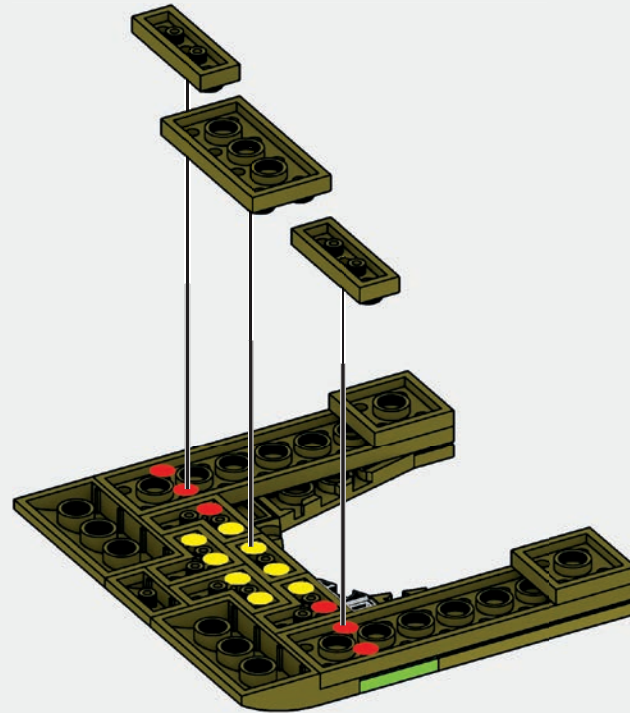
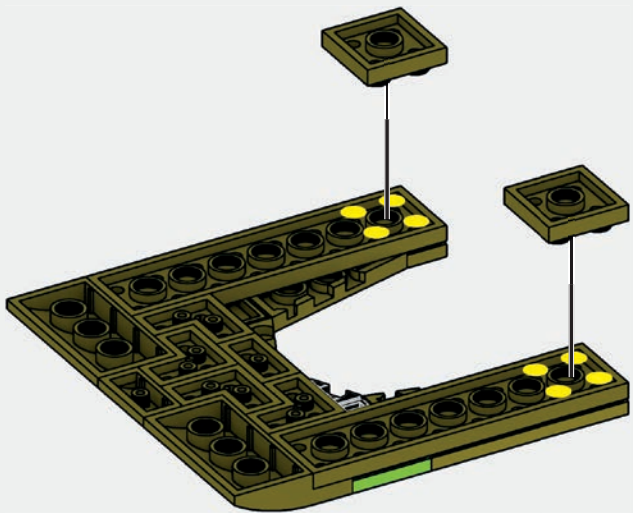
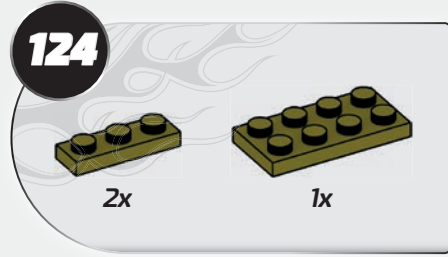

1

2

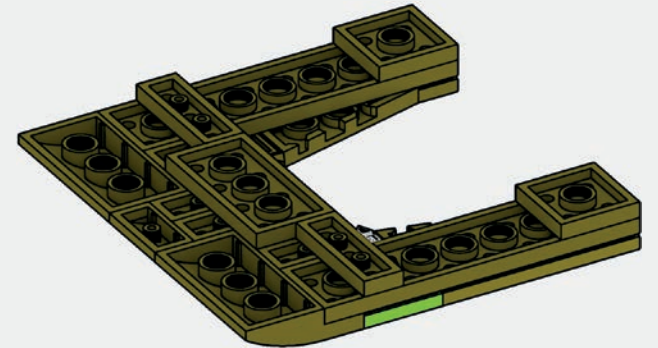

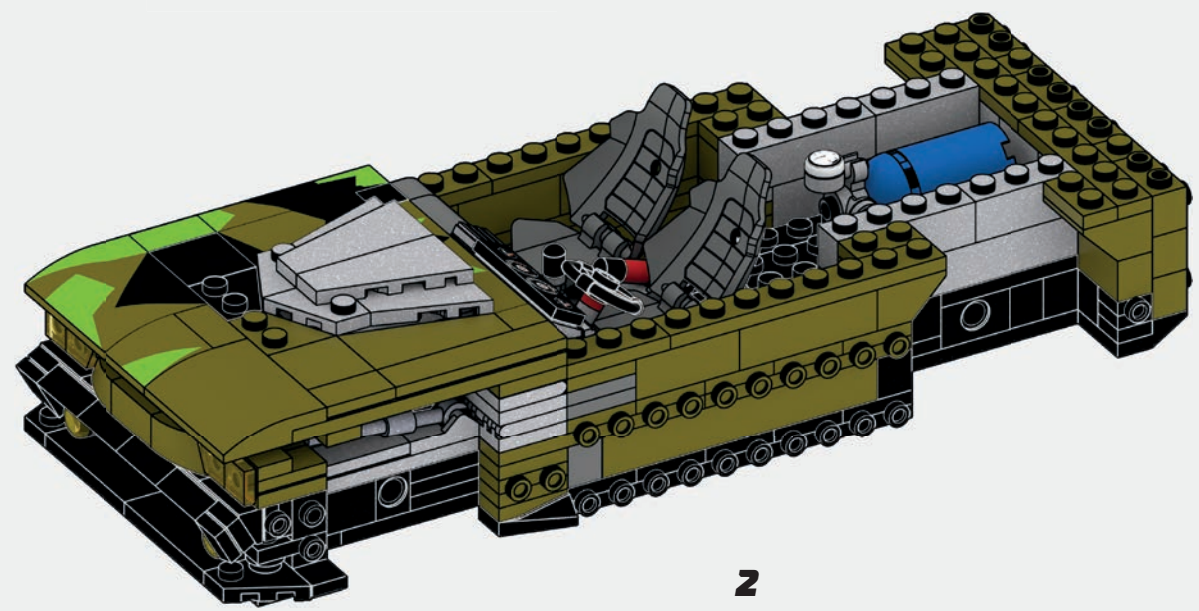
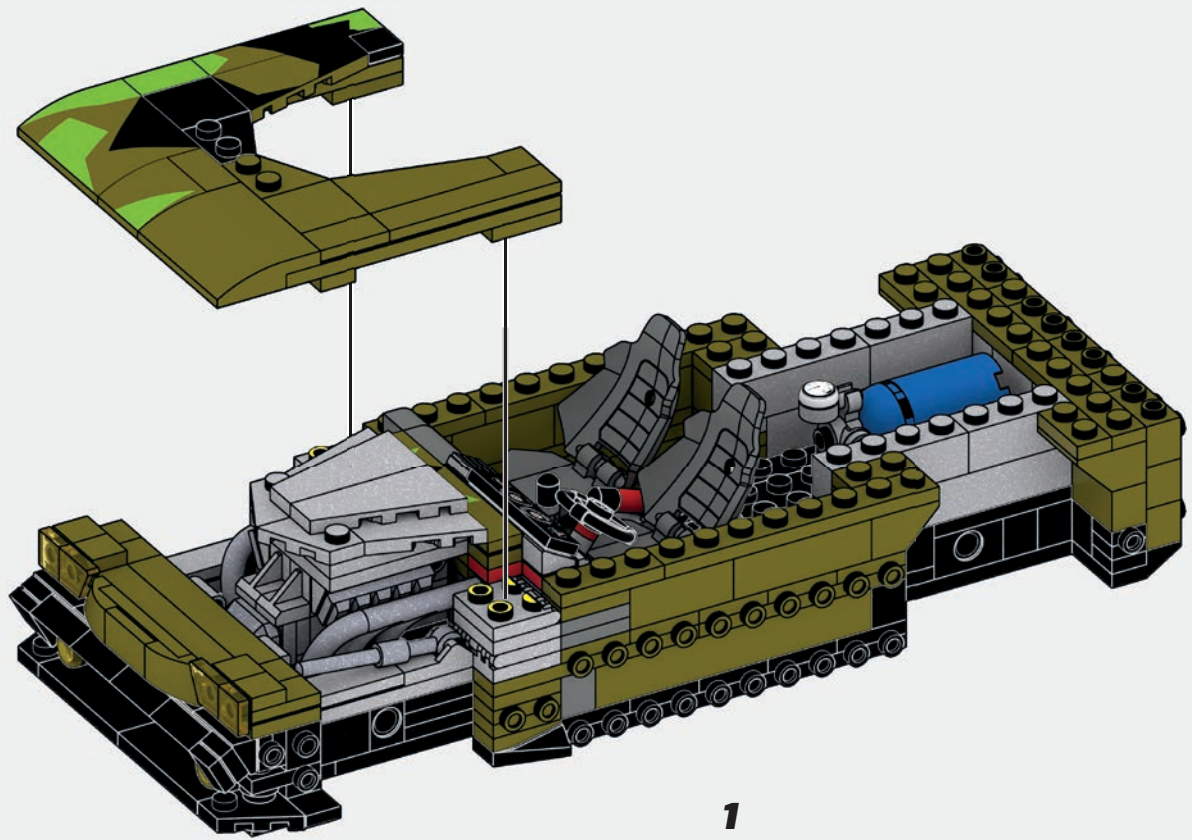

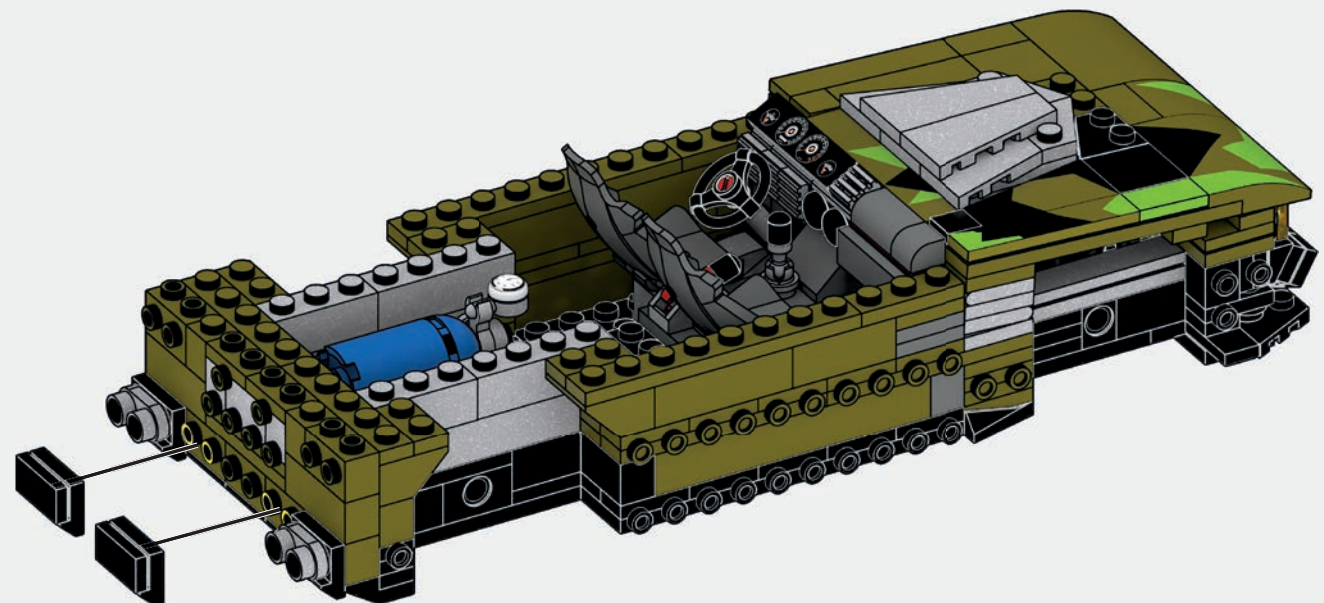
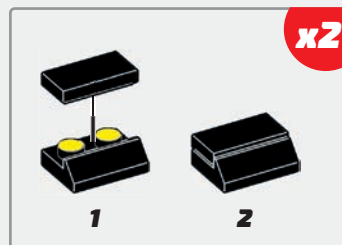
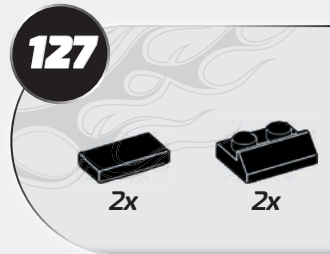
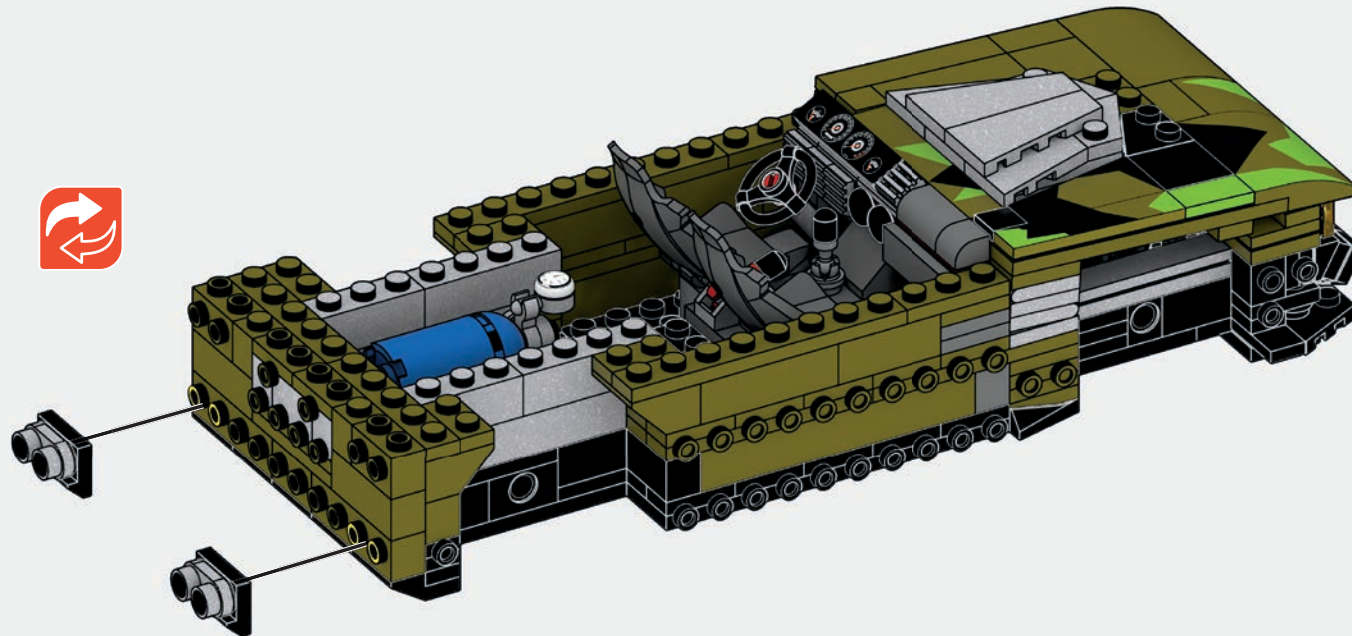
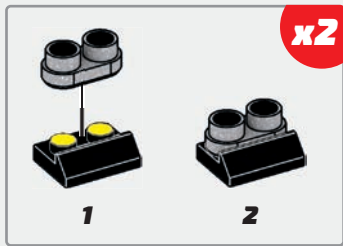
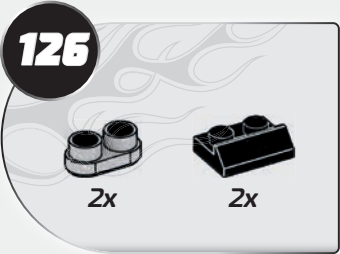

128



1x



1x



1



2

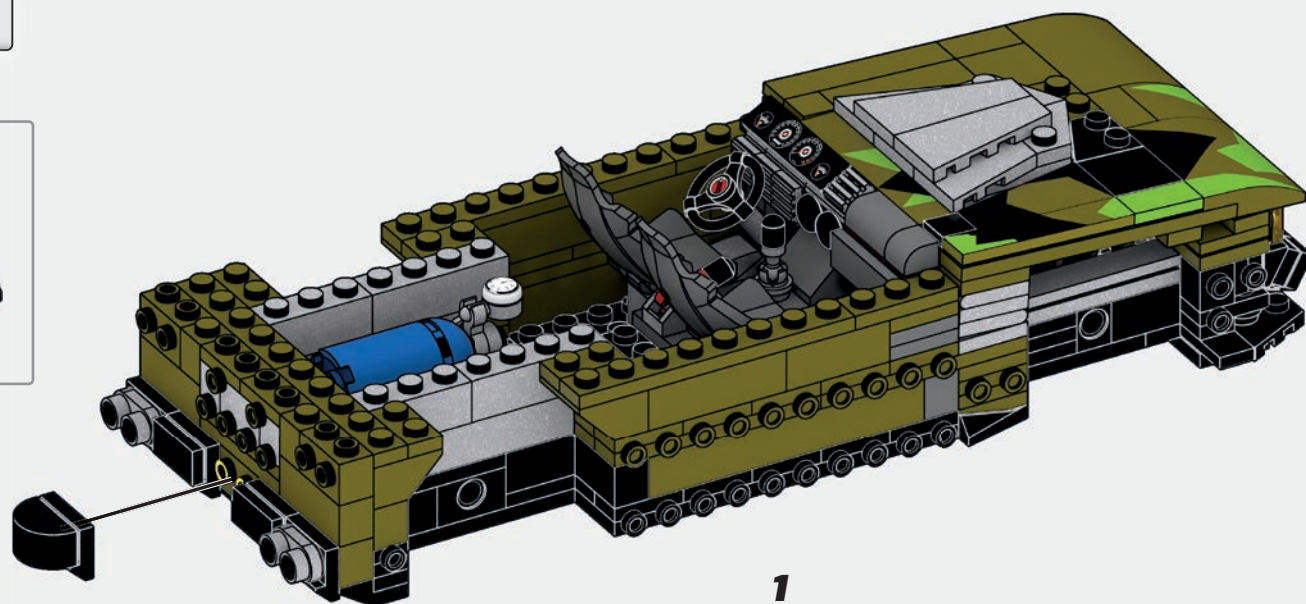

1

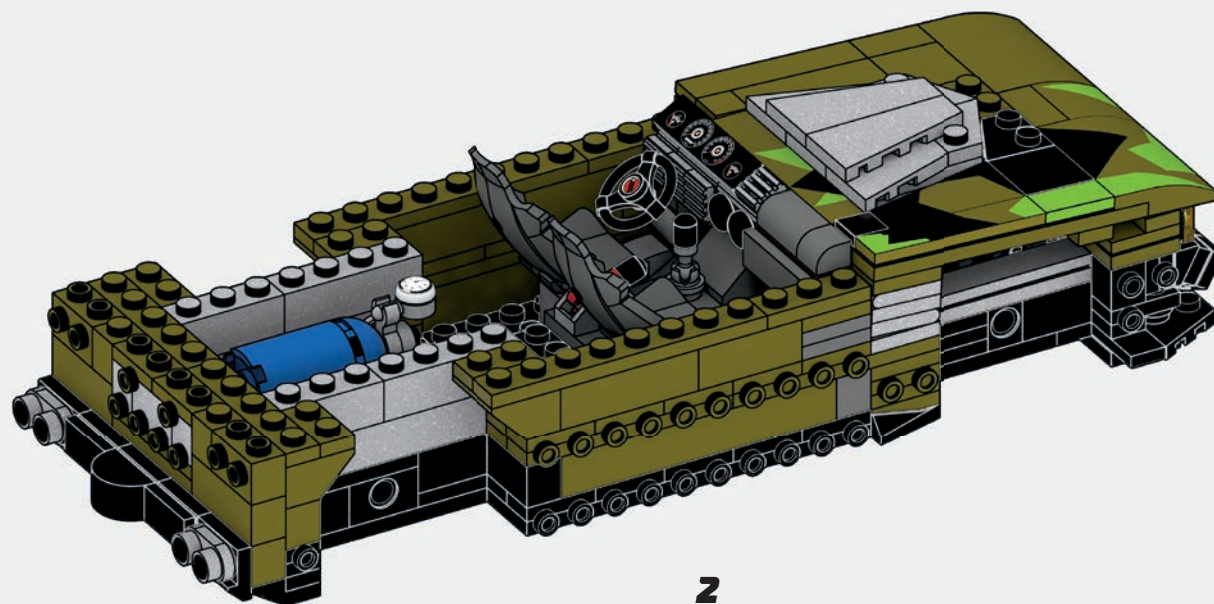

2

129

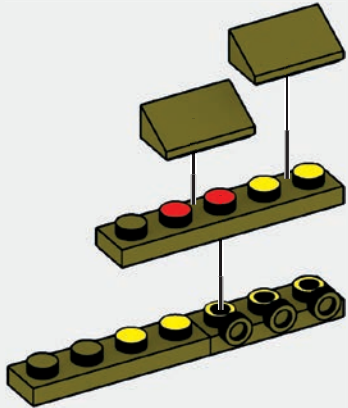
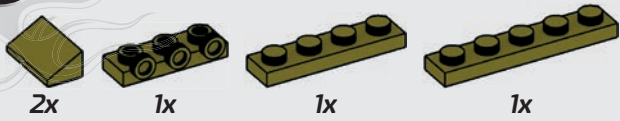

130

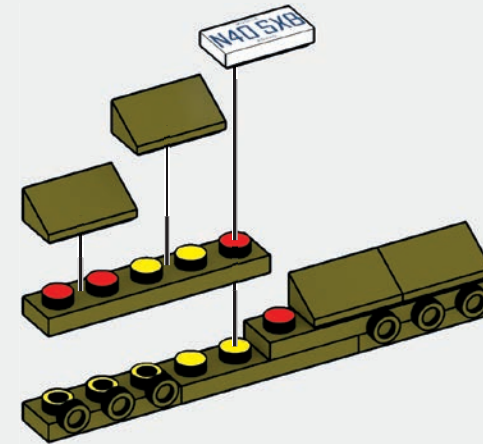
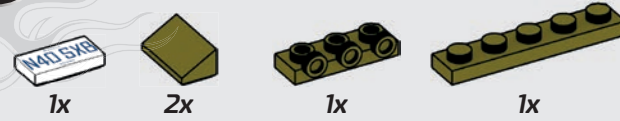

131

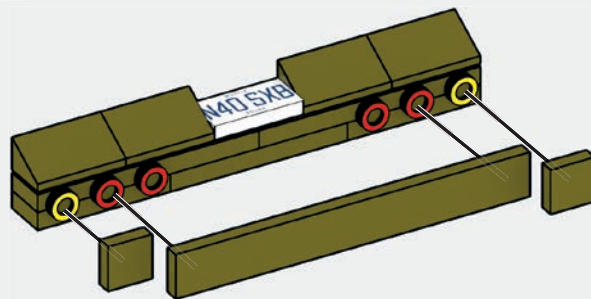
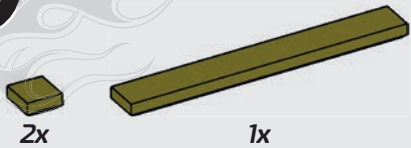

1

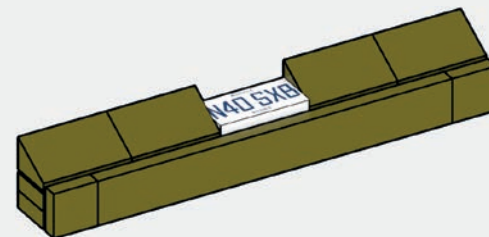

2

132

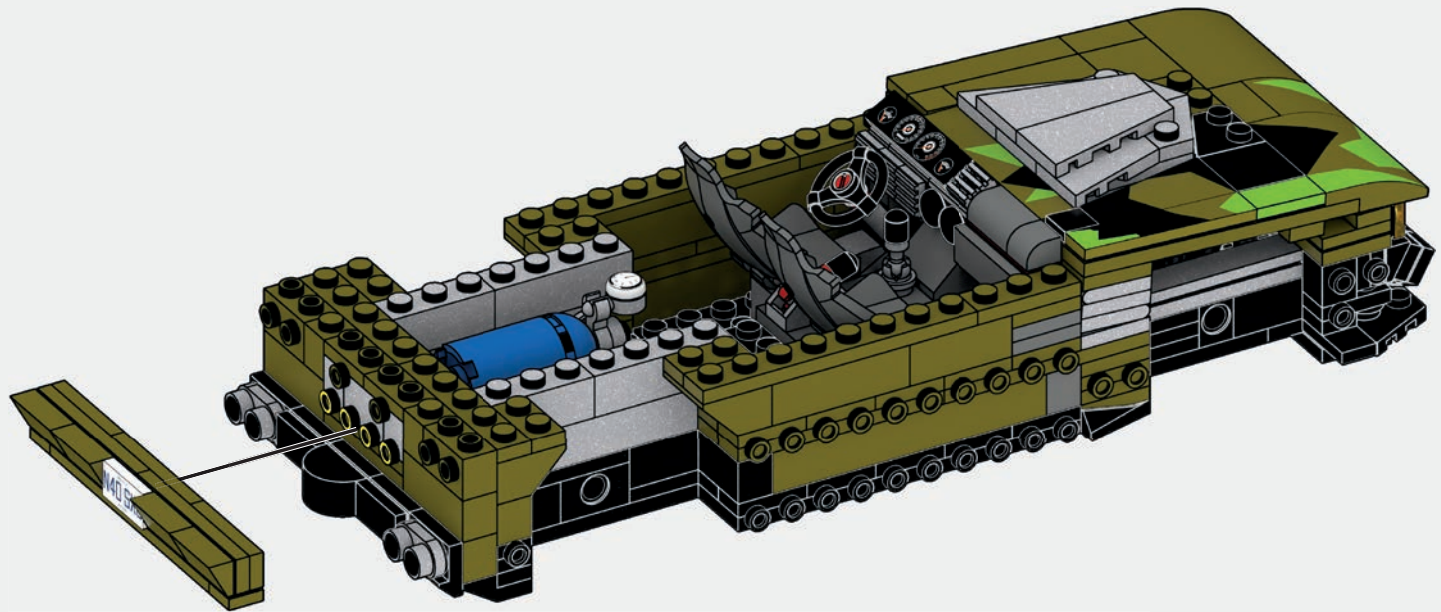

133

1x 1x 2x

1 2

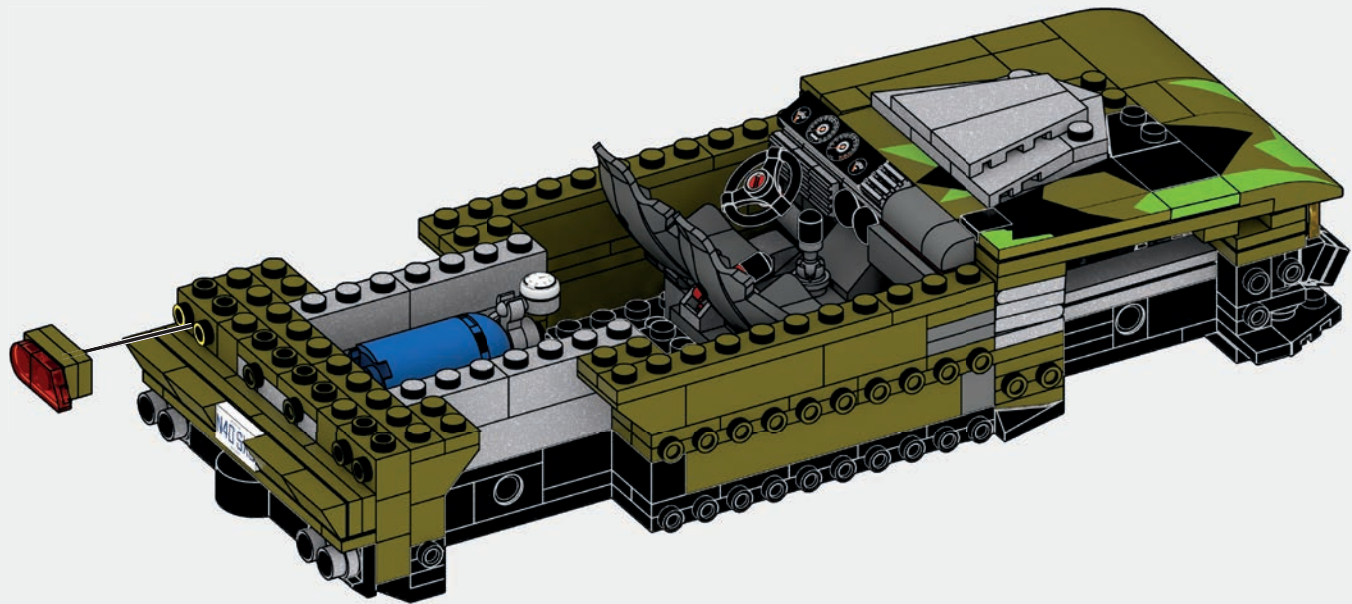

134

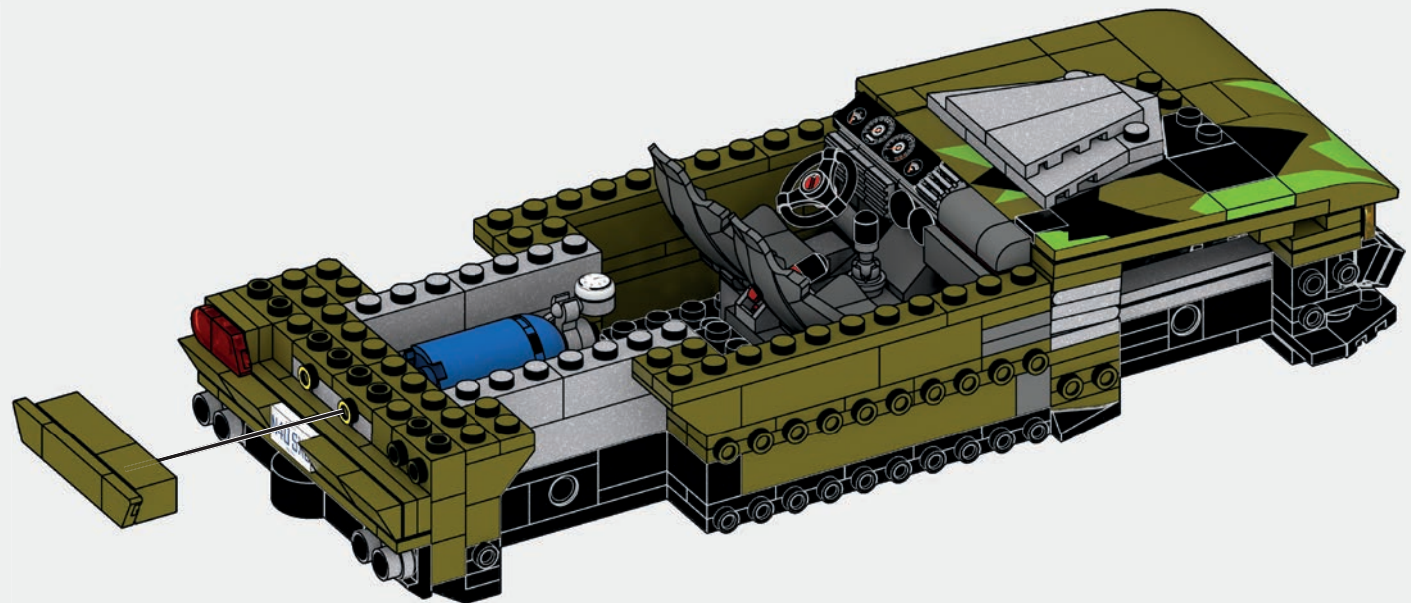
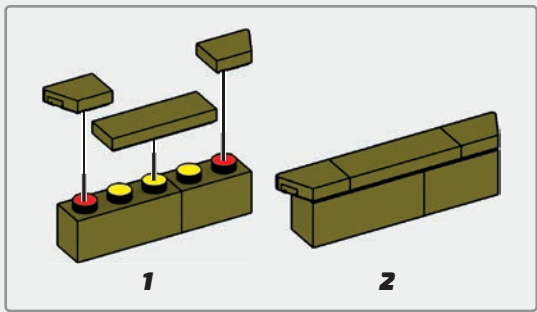
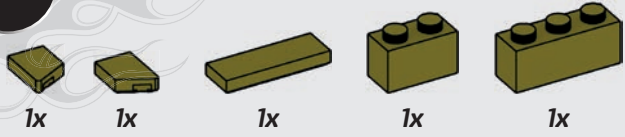

135

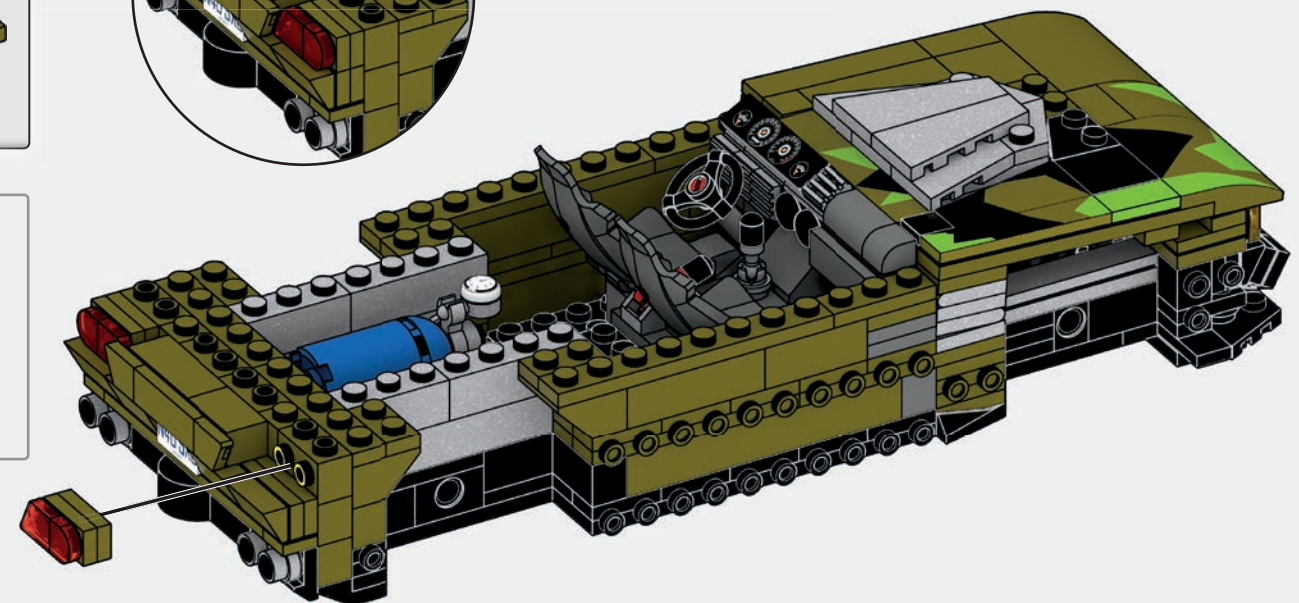
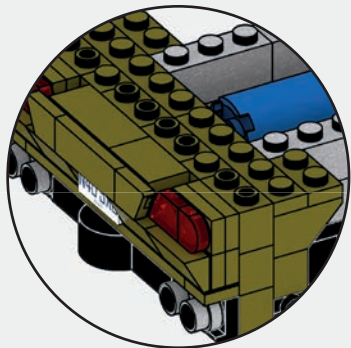
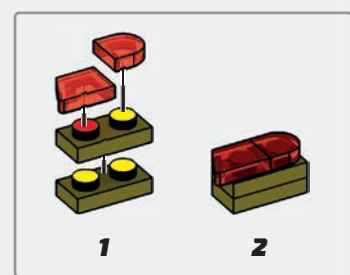

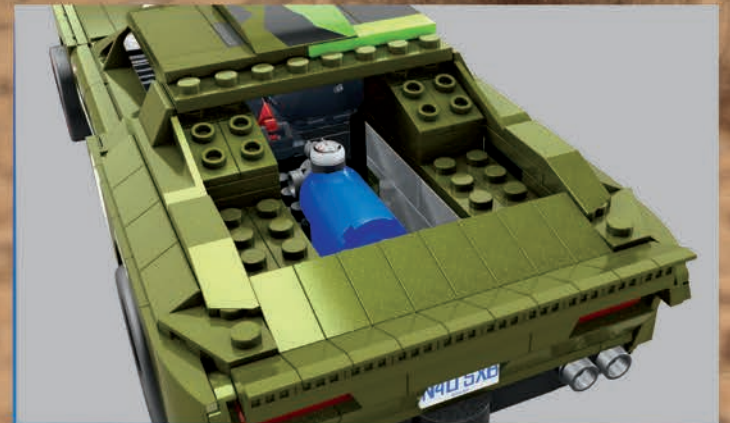





136

2x

4x

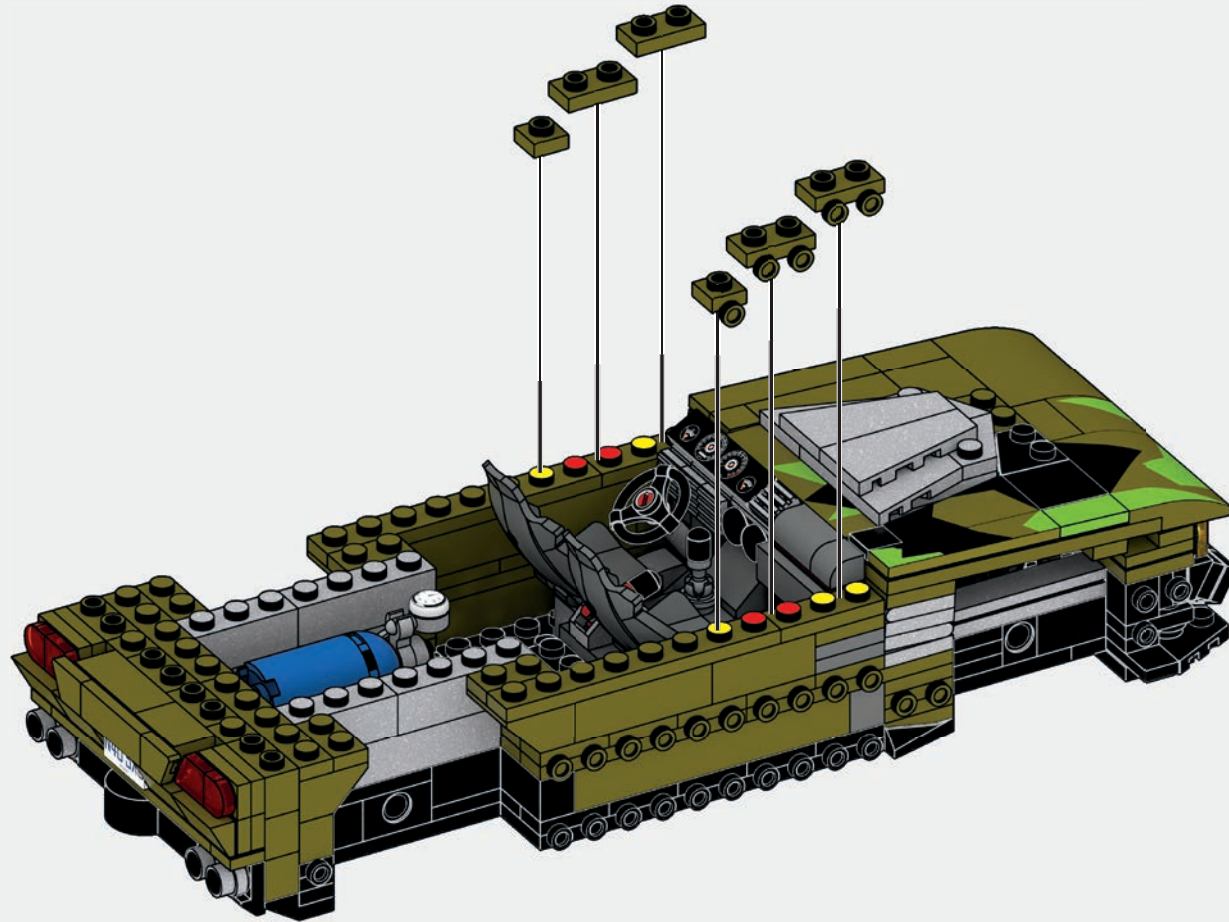

137

4x

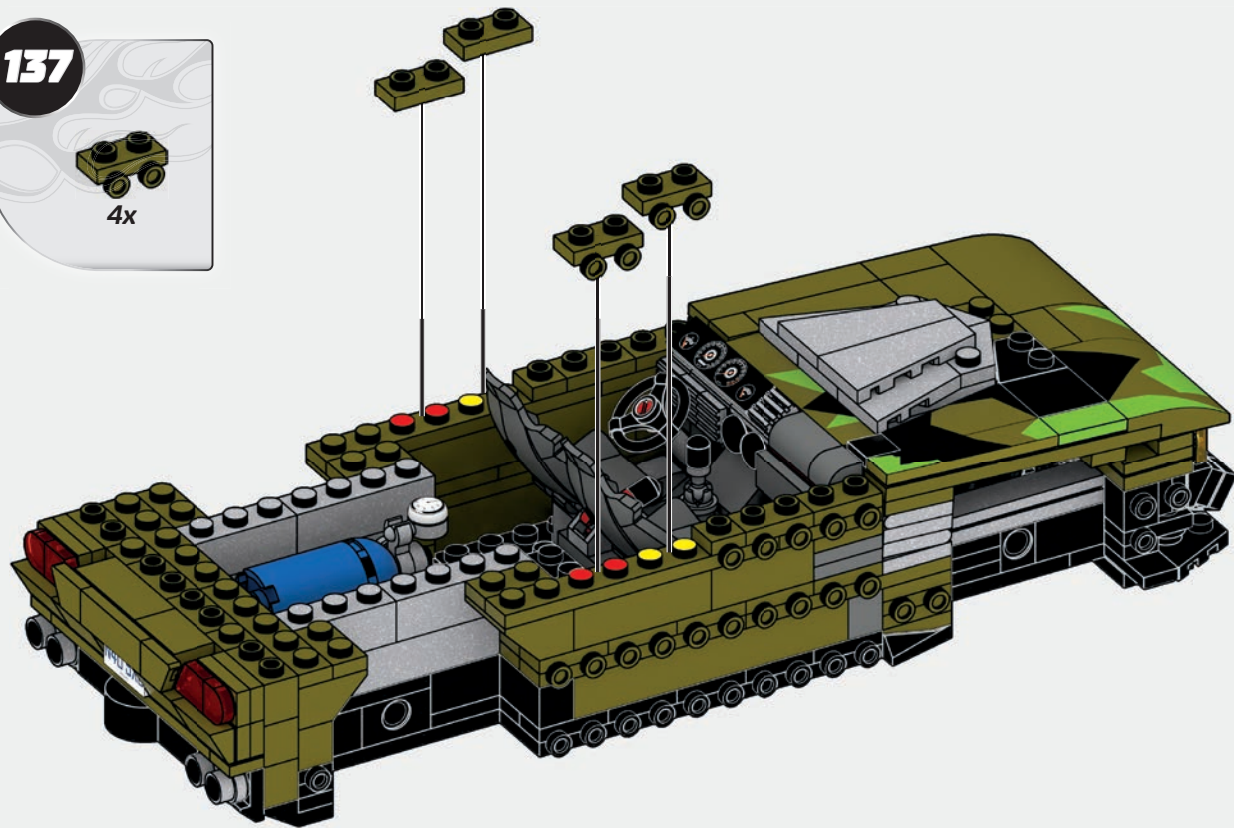

138

1x 1x

1x

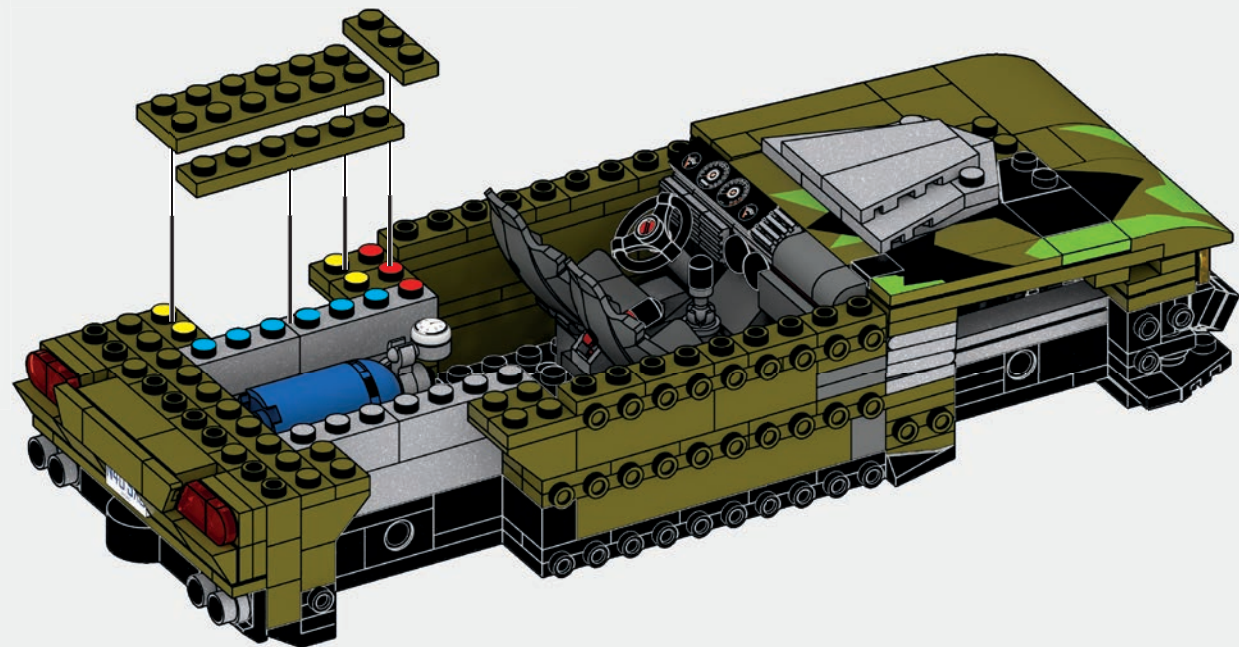

139

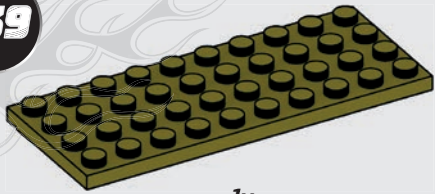

1x

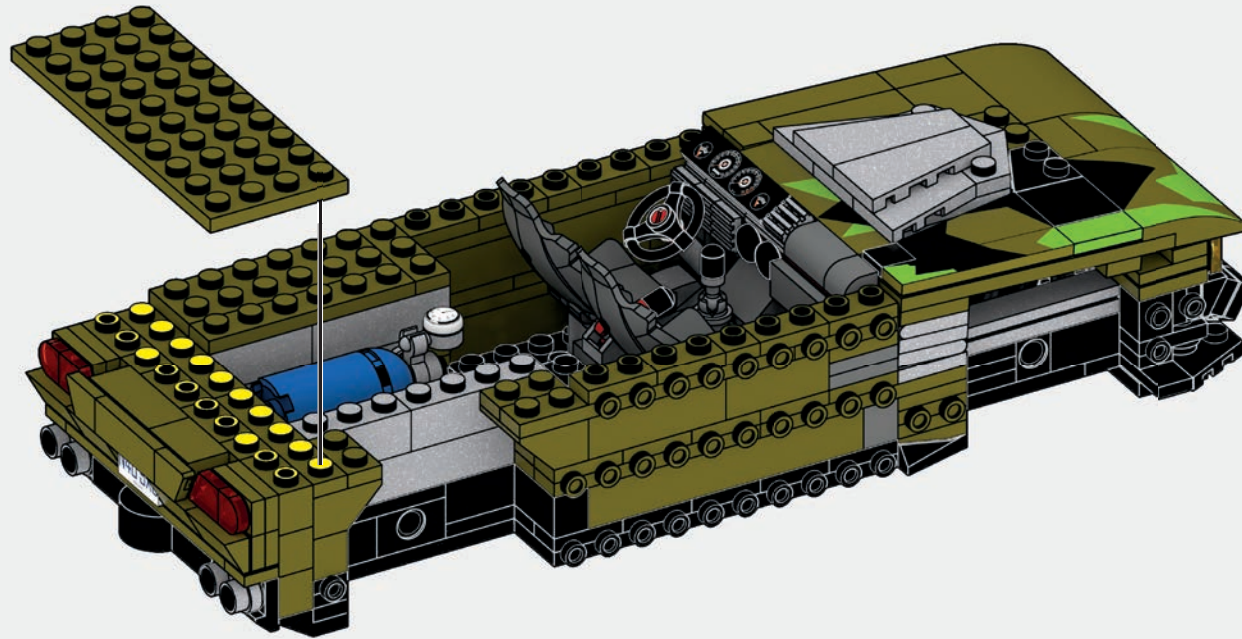

140



1x

1x

1x

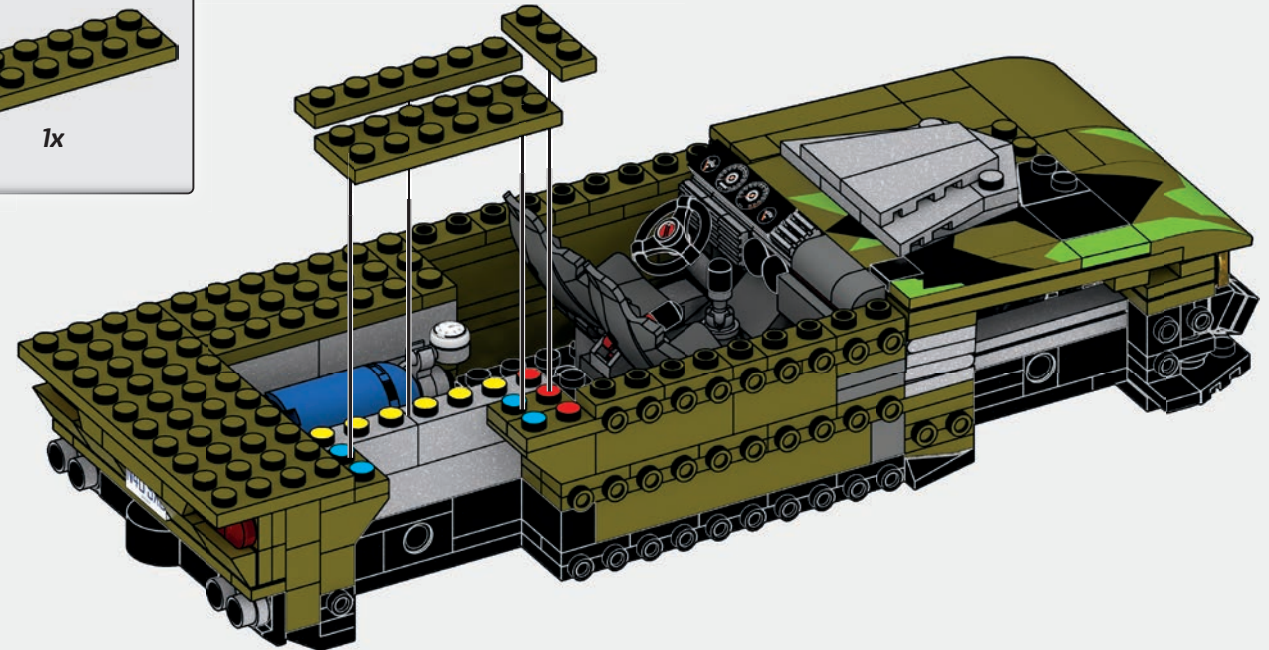

141



2x

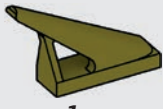

1x



1x

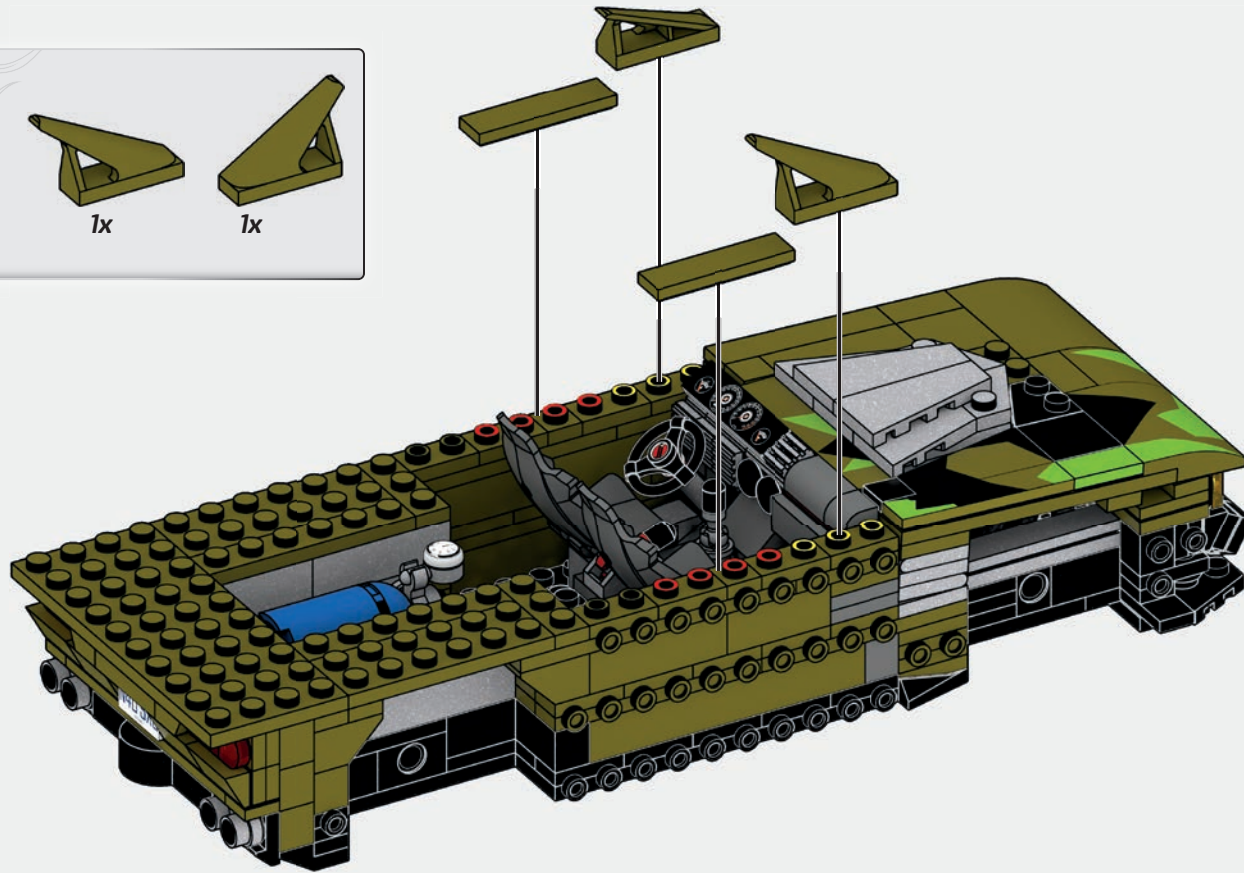

142



1x



2x

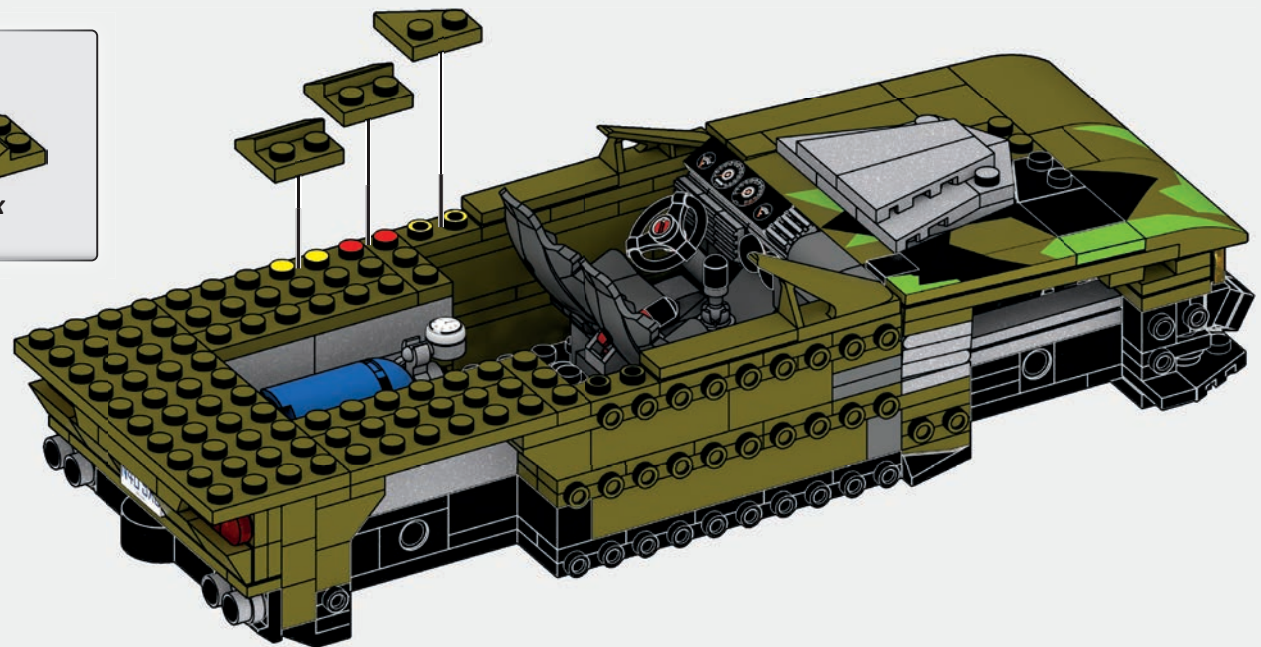

143



1x



2x

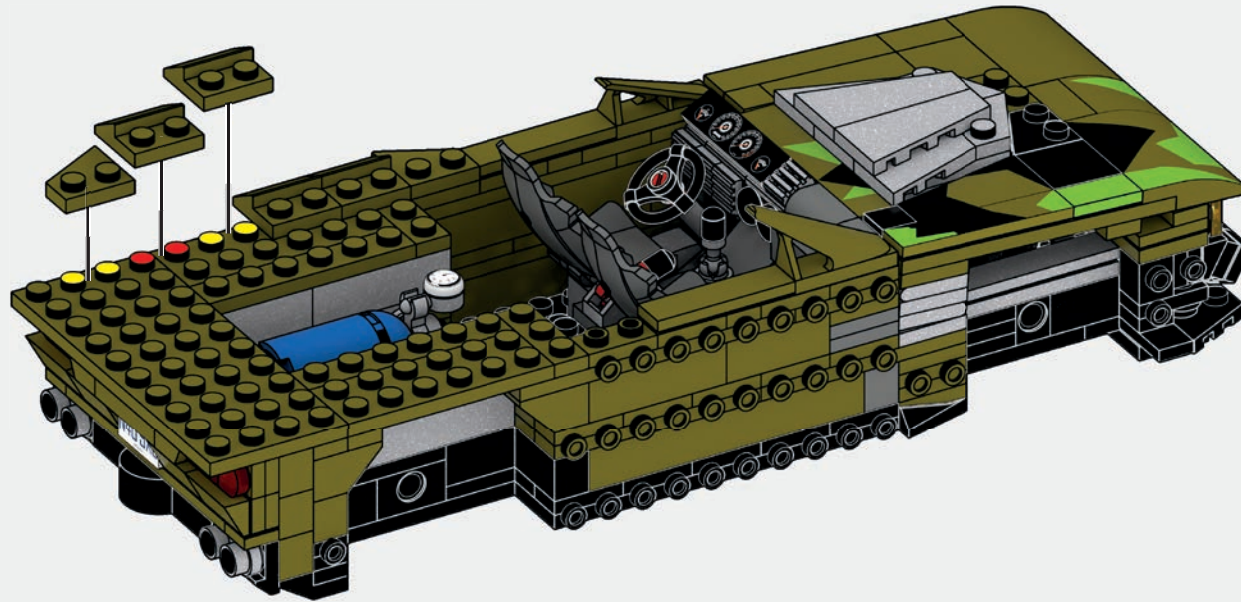

144



1x



1x



1x



1x



1x

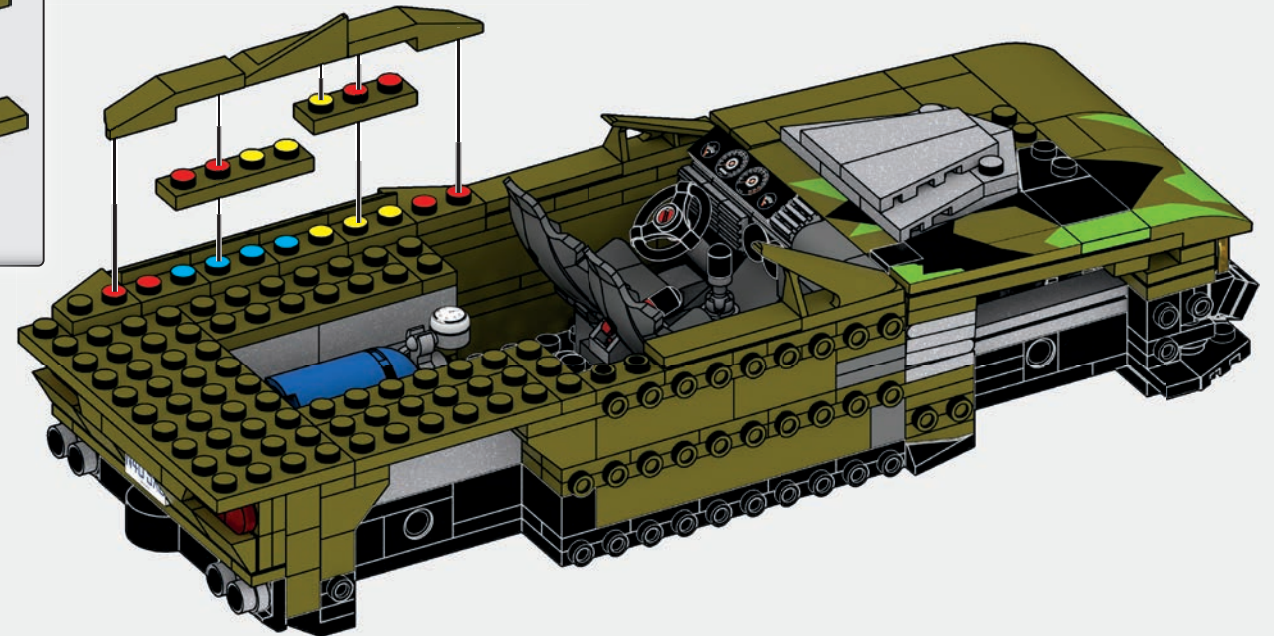

145



2x

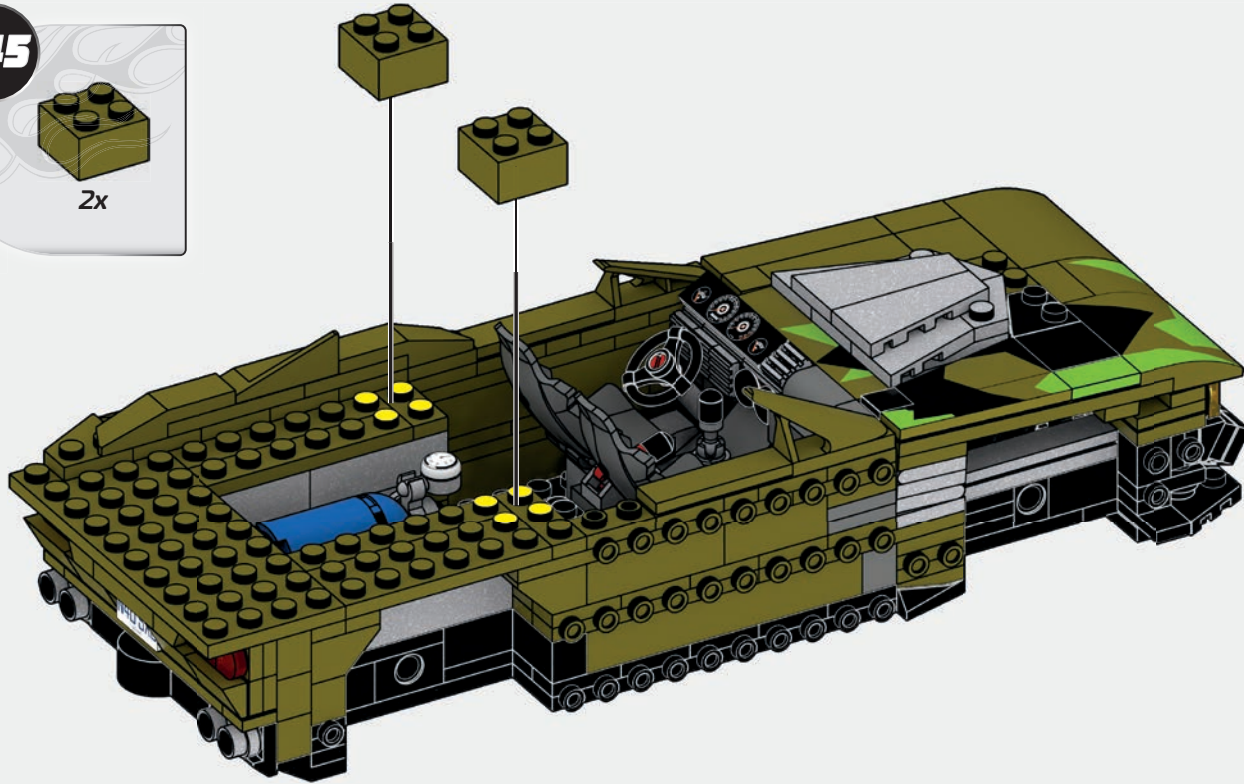

146



4x



4x

x2

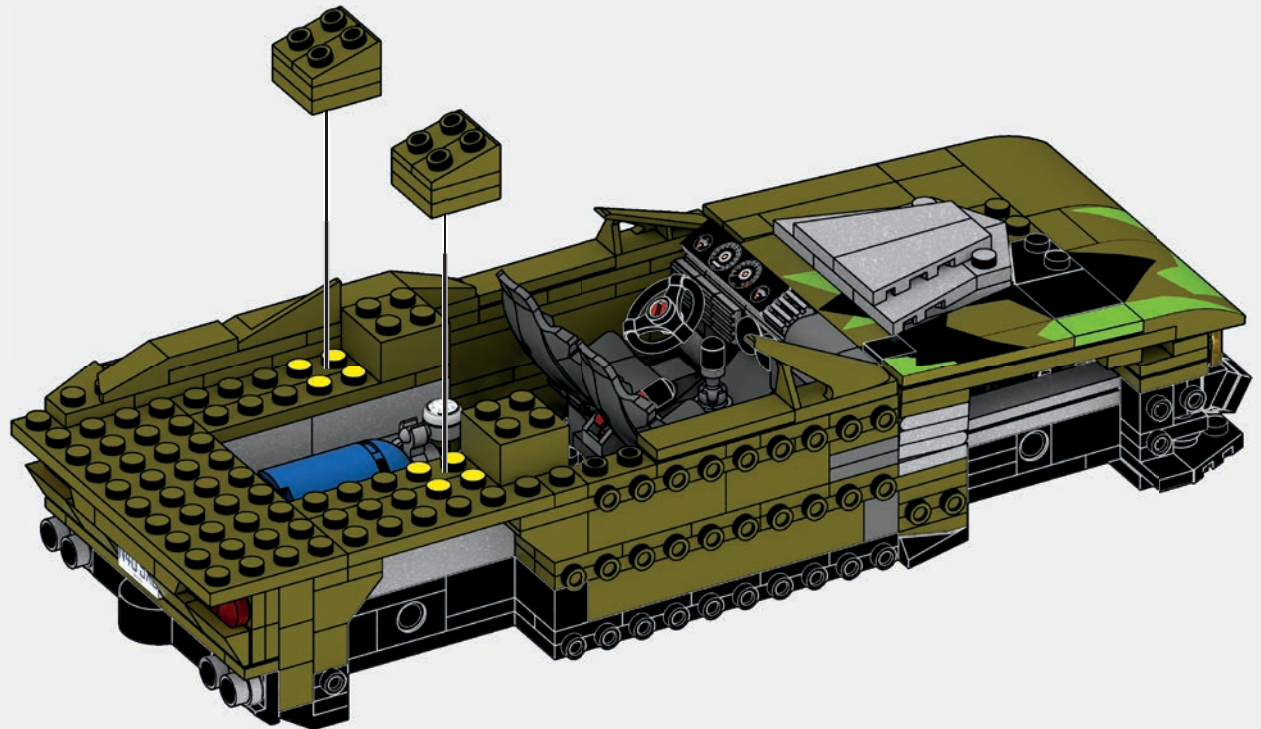

147

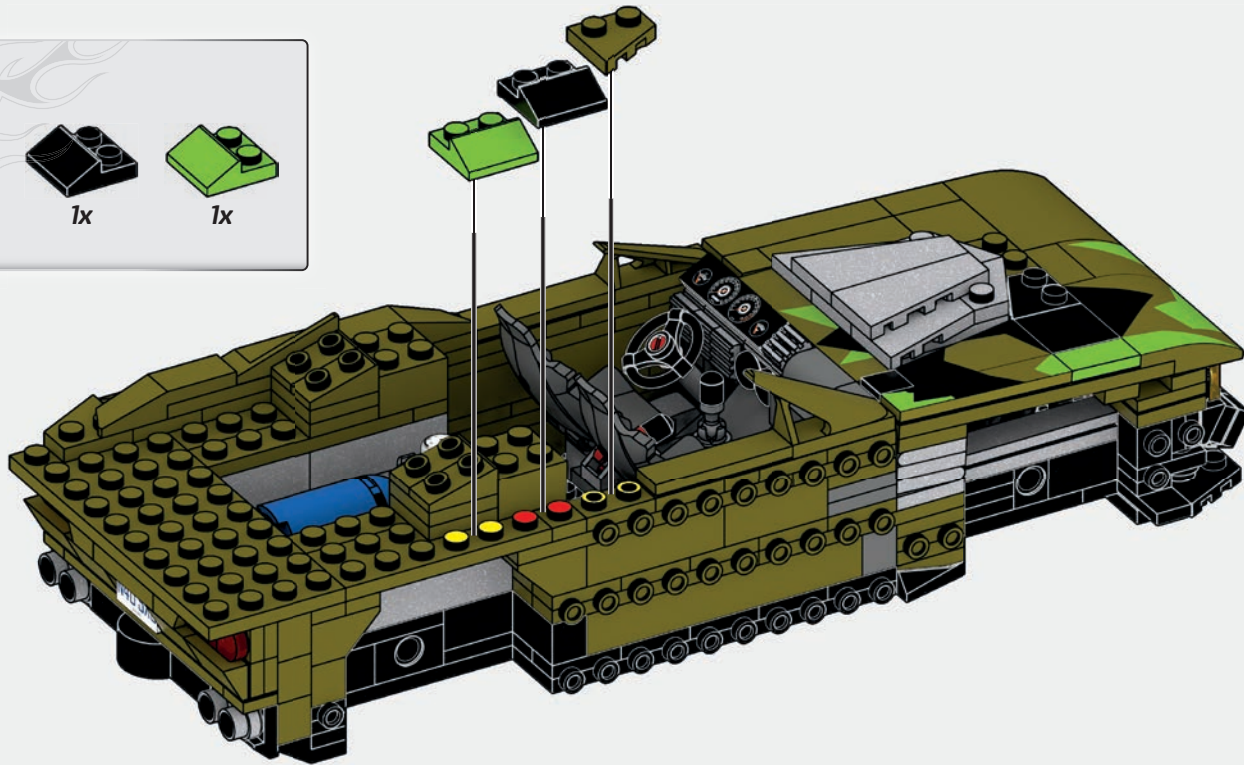

148

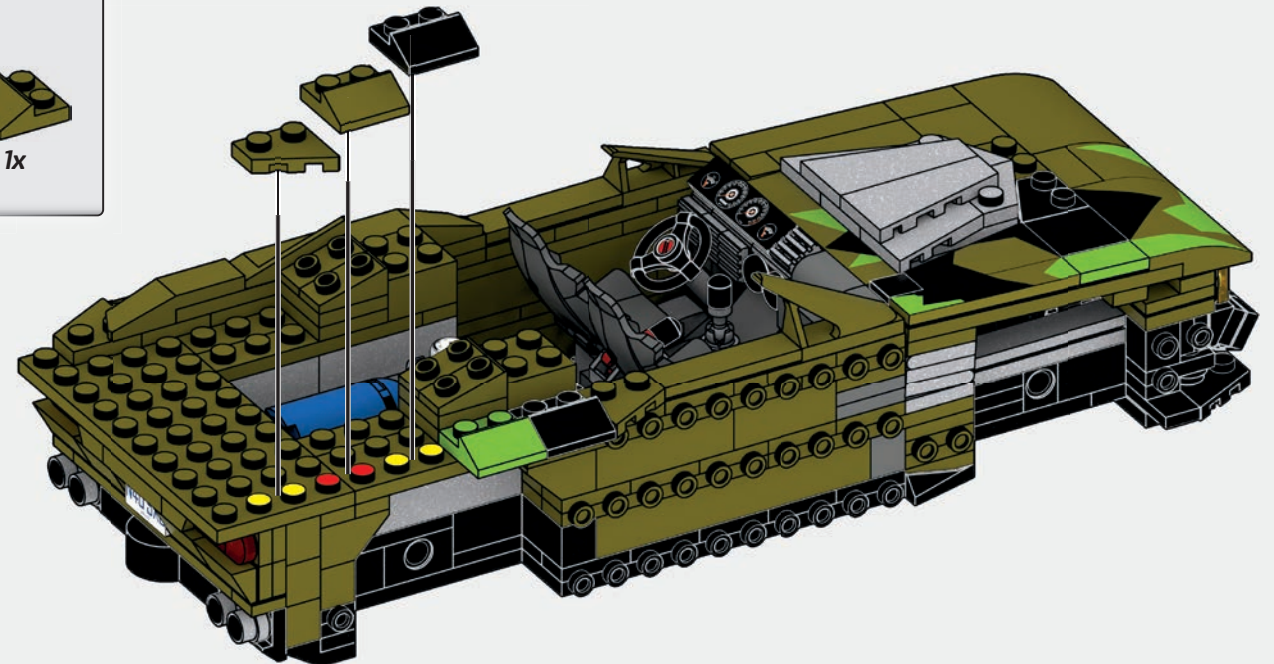
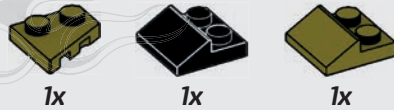

149

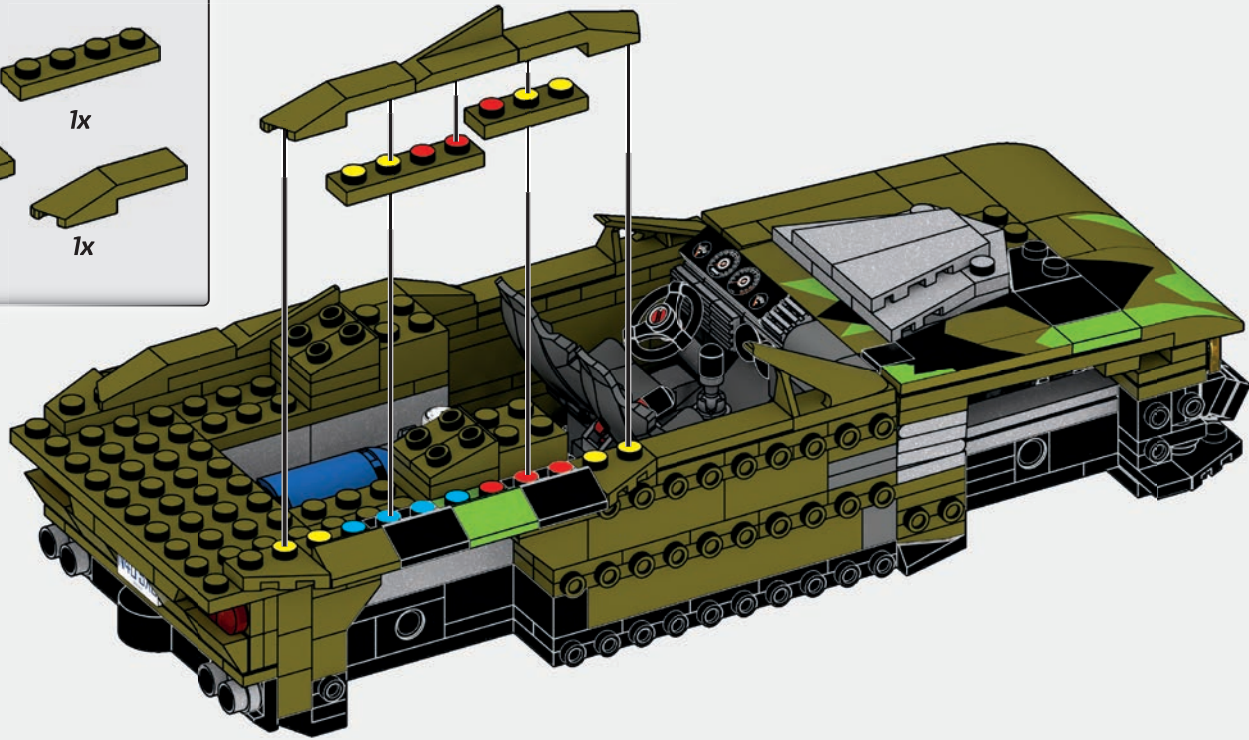
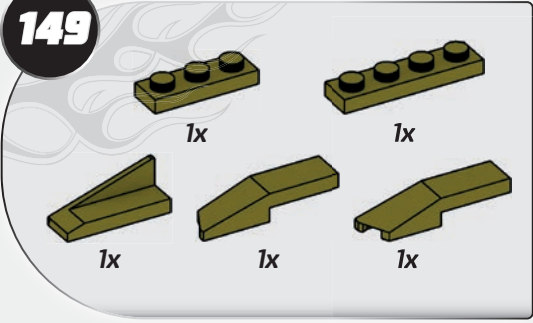

150

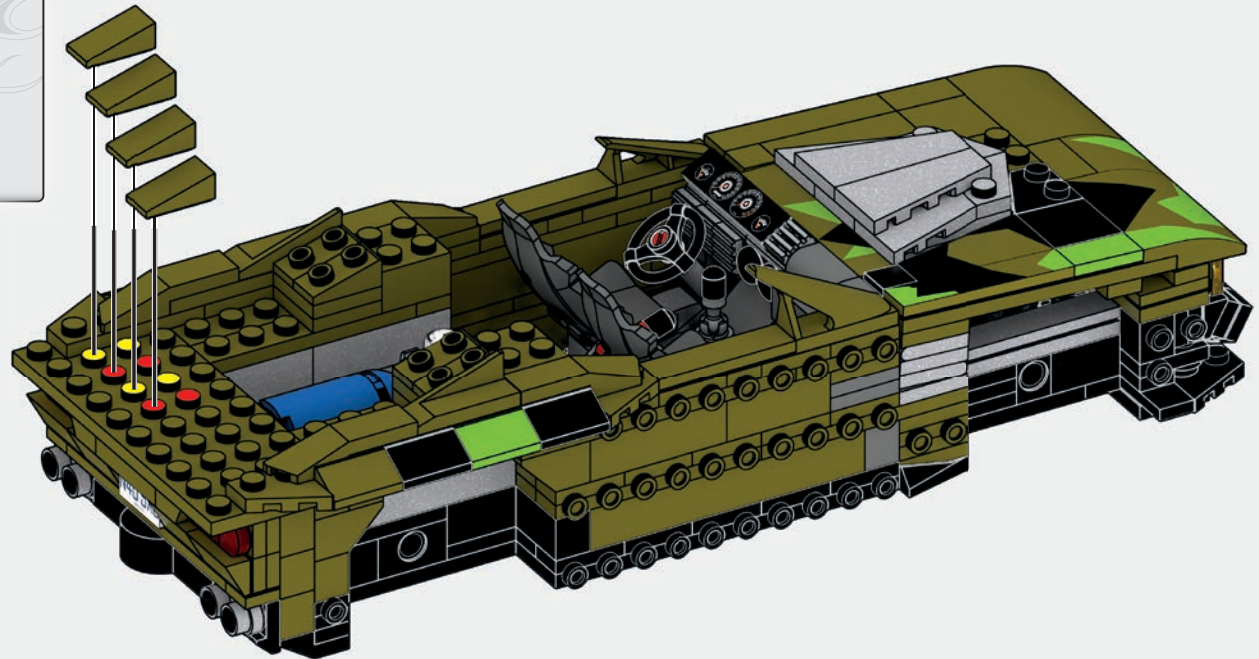
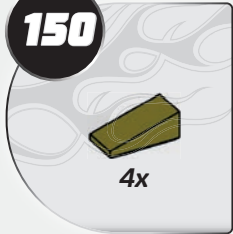

151
4x

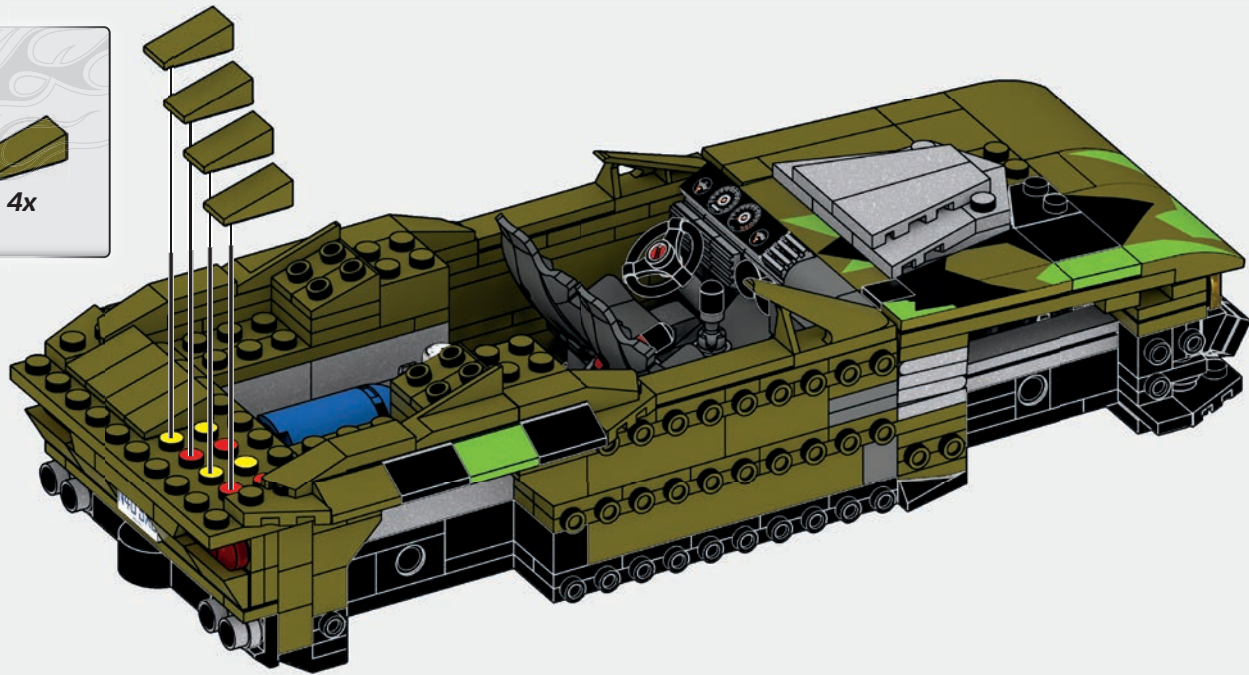

152
5x

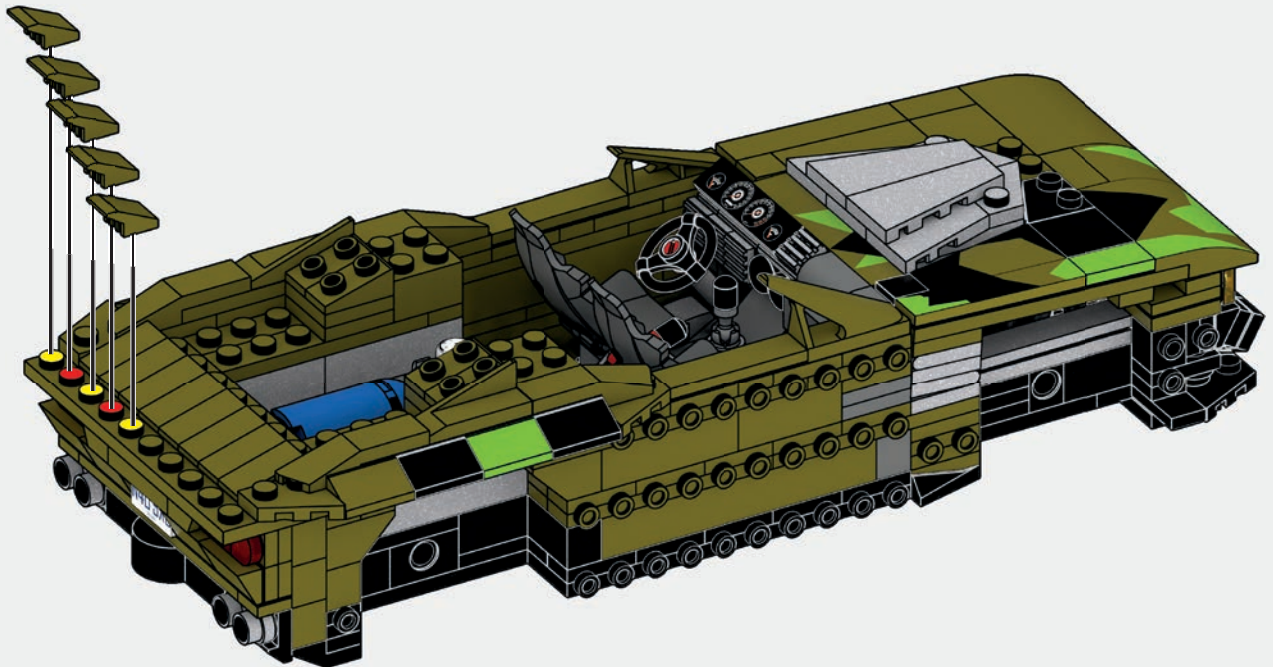

153



5x

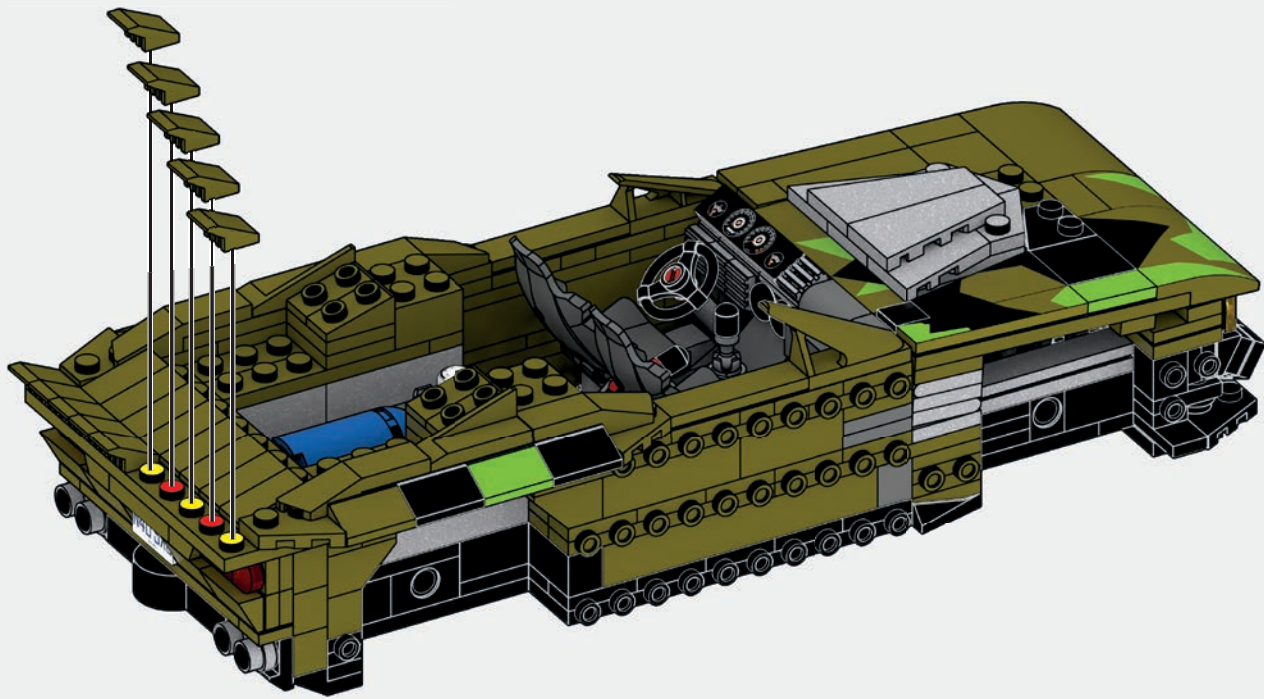

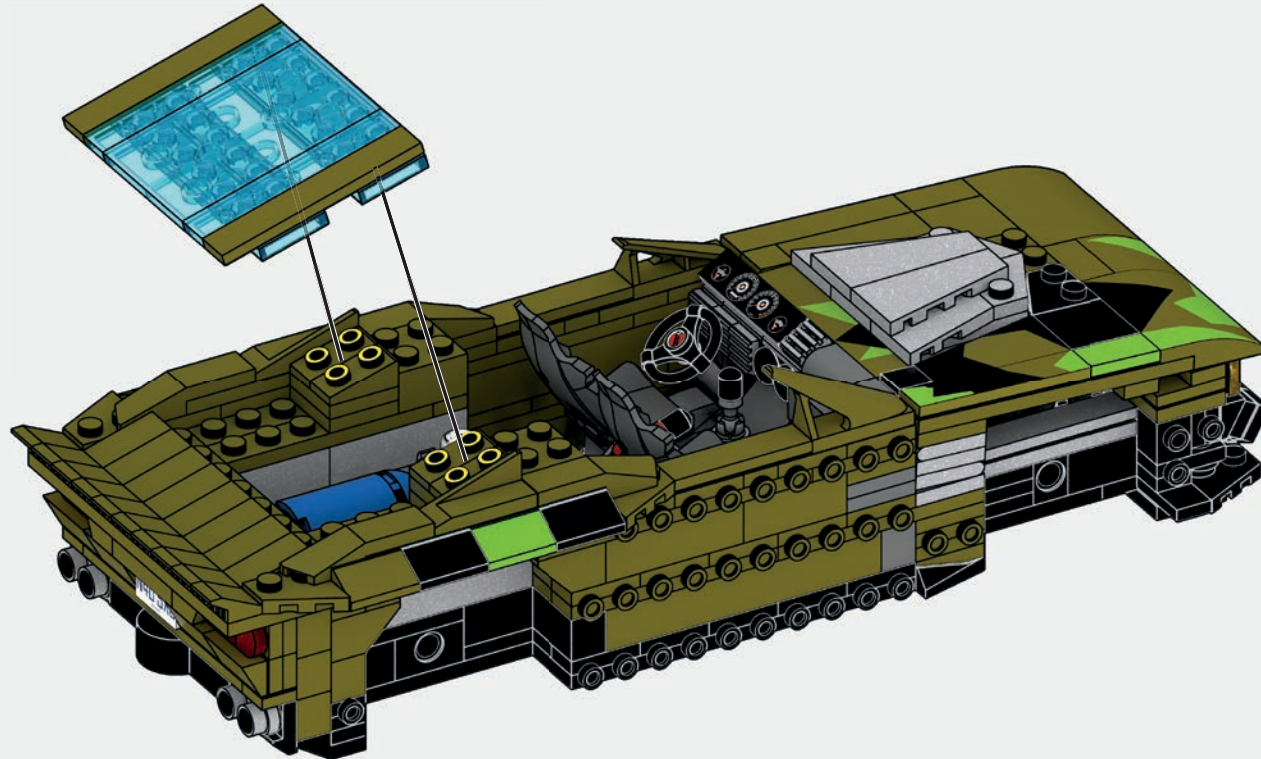
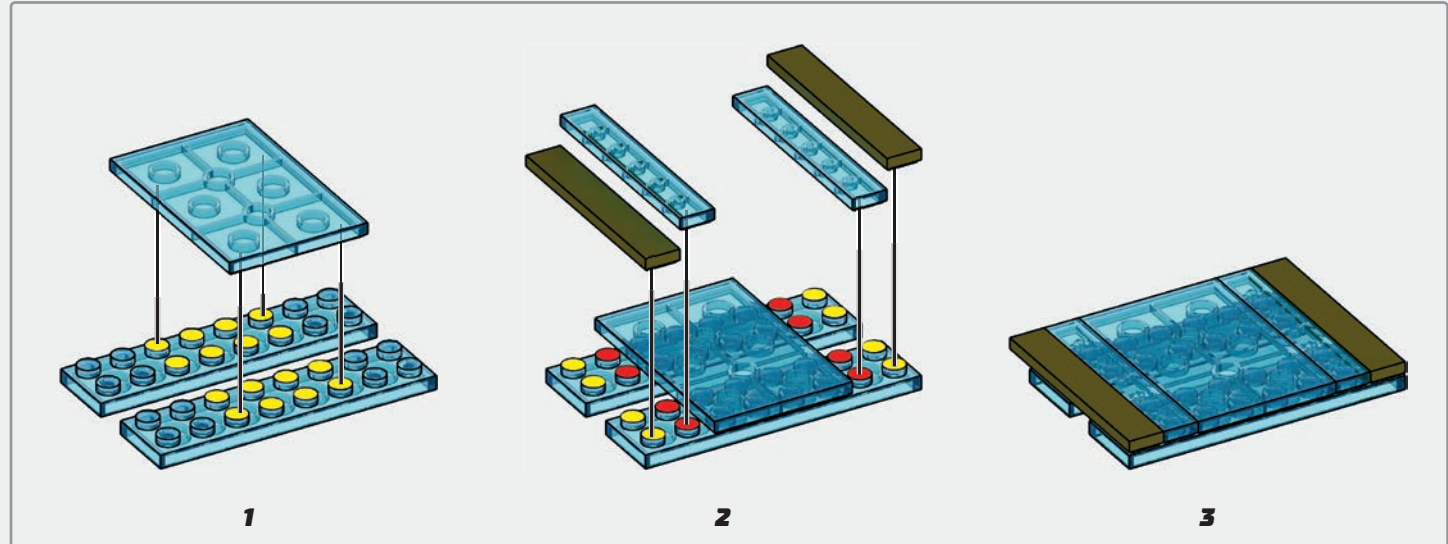
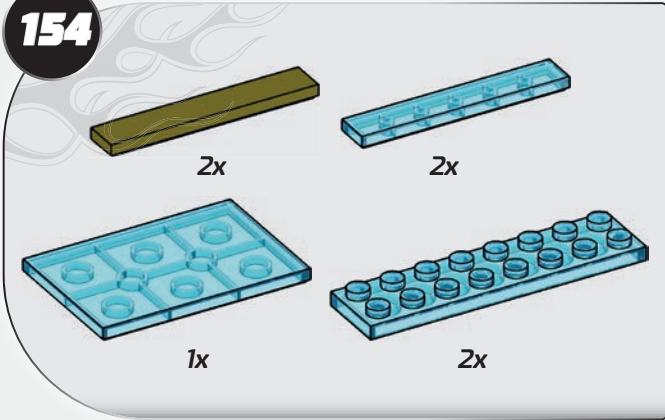

155

- 2x
- 2x
- 2x

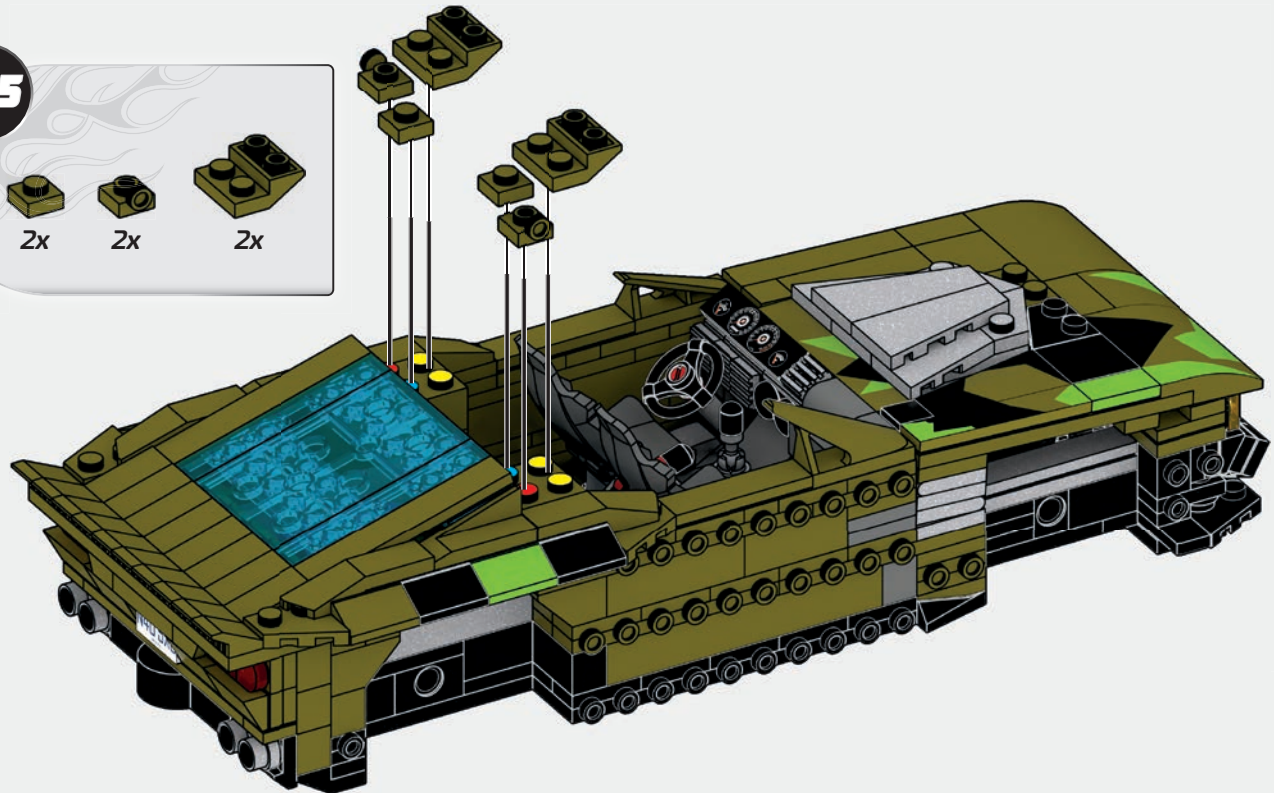

156

- 1x
- 1x

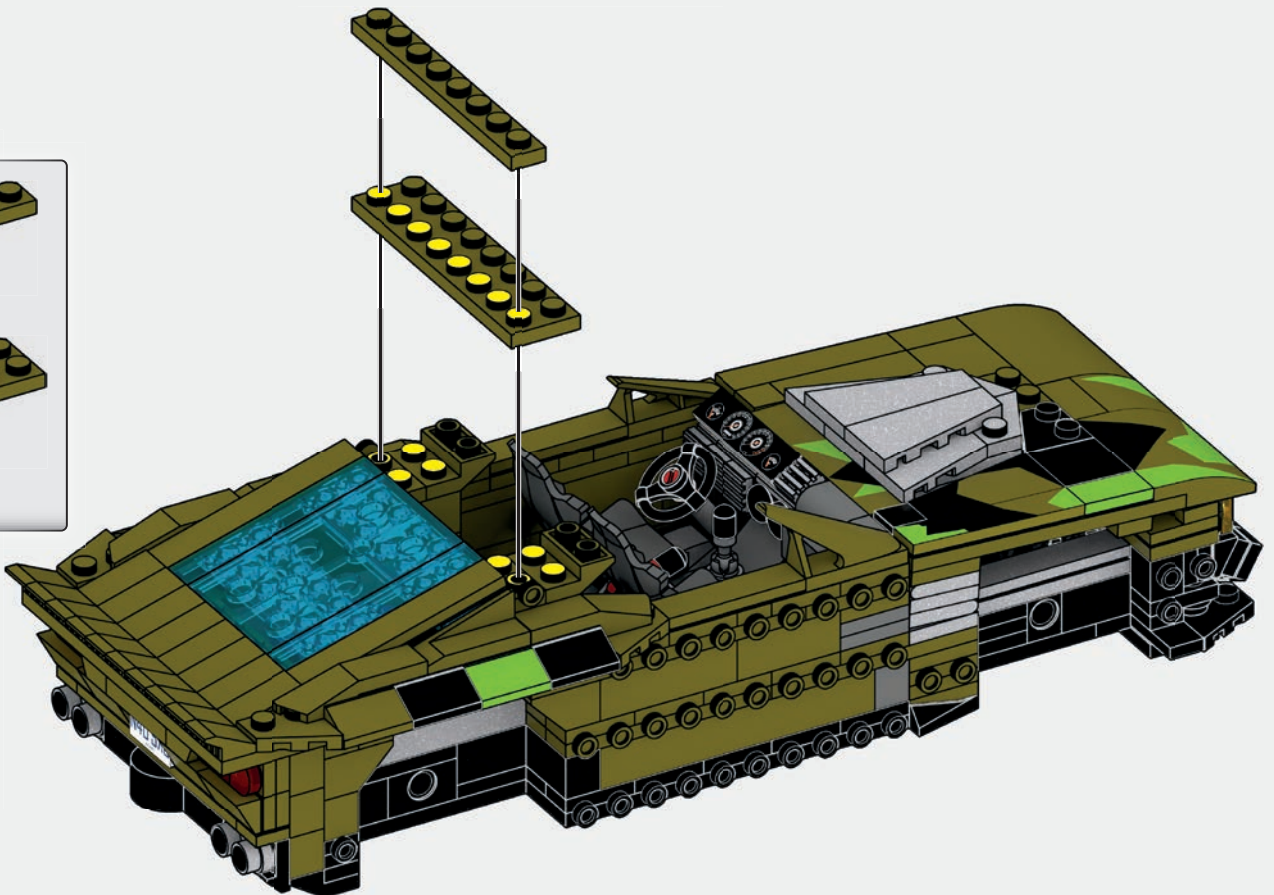

157



2x

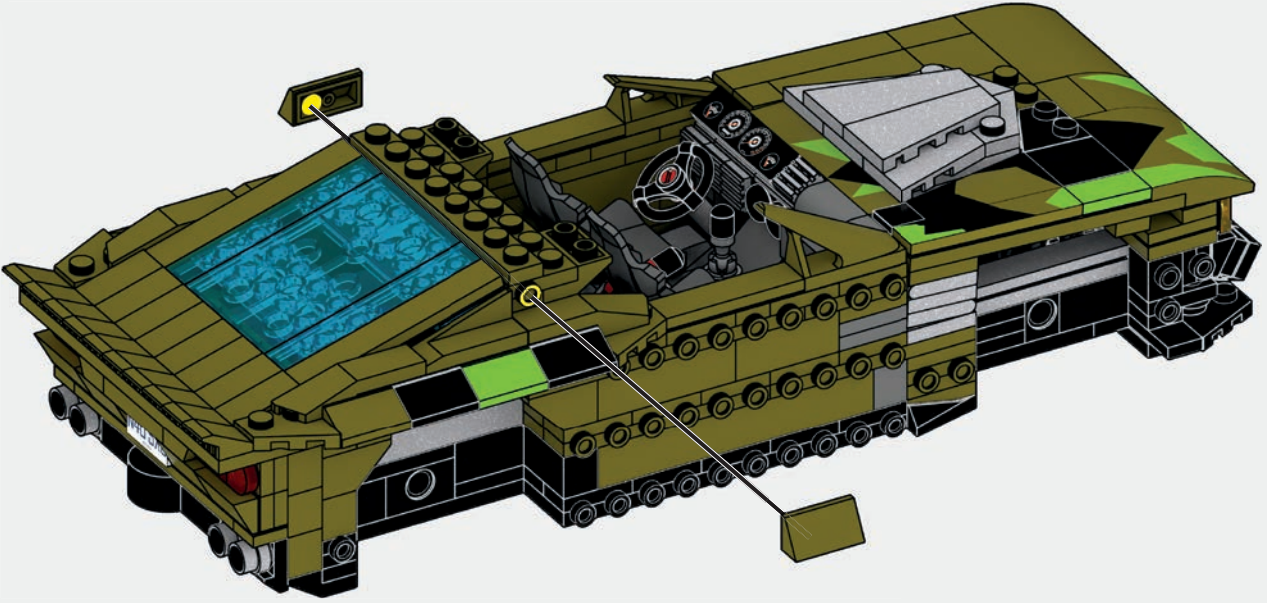

158

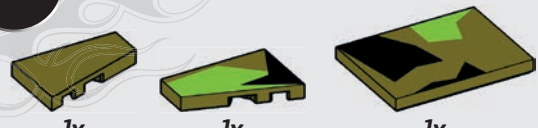

1x 1x 1x

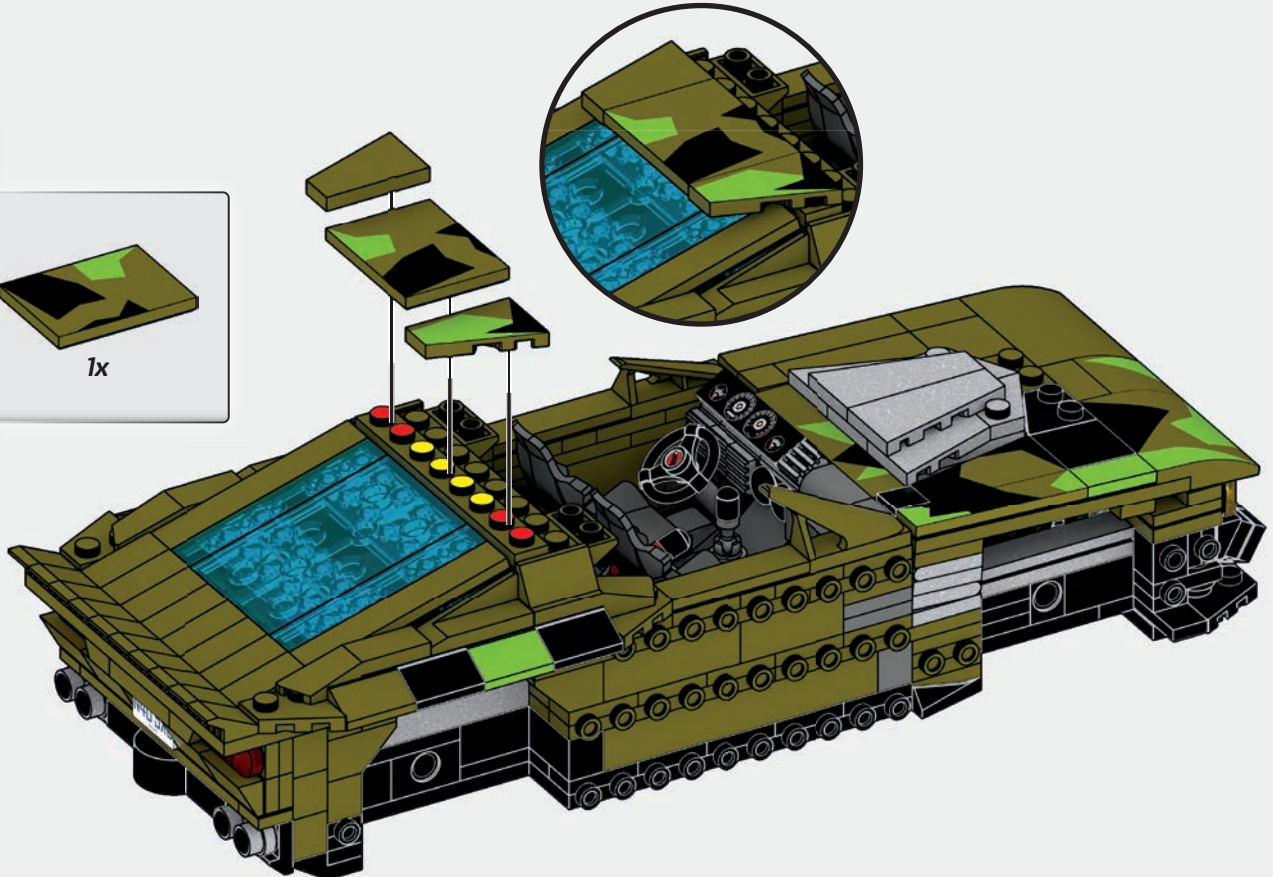

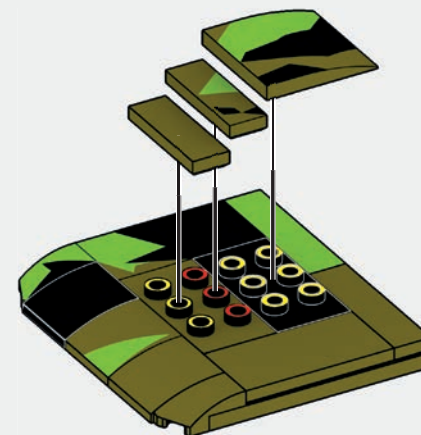
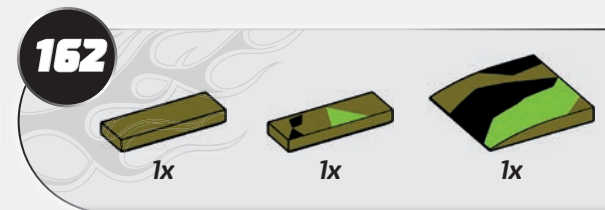
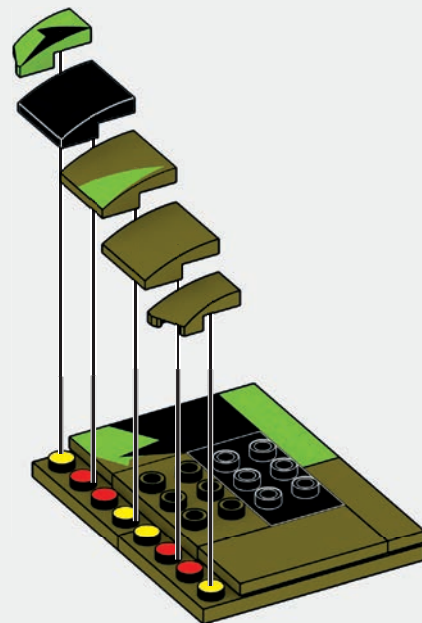
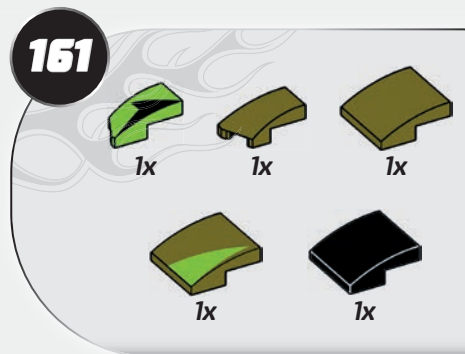
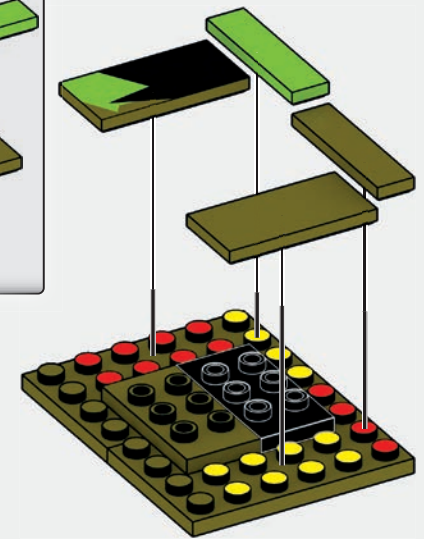
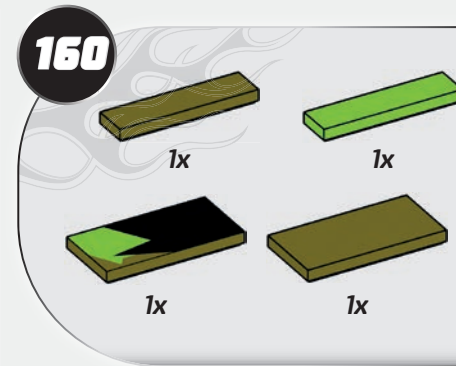
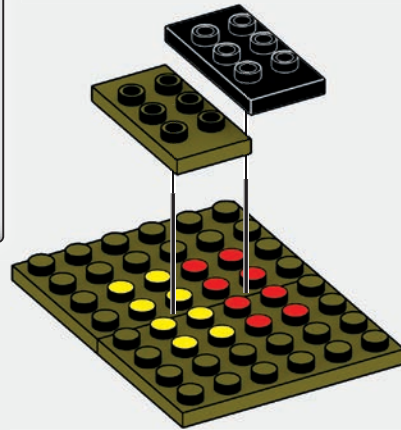
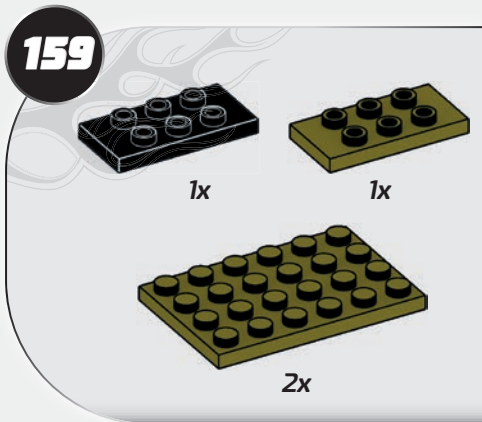

1

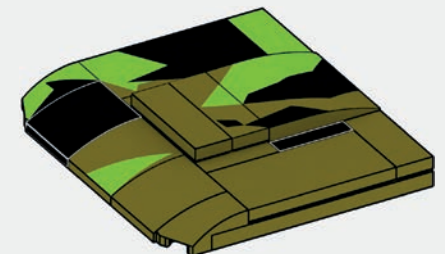

2

163

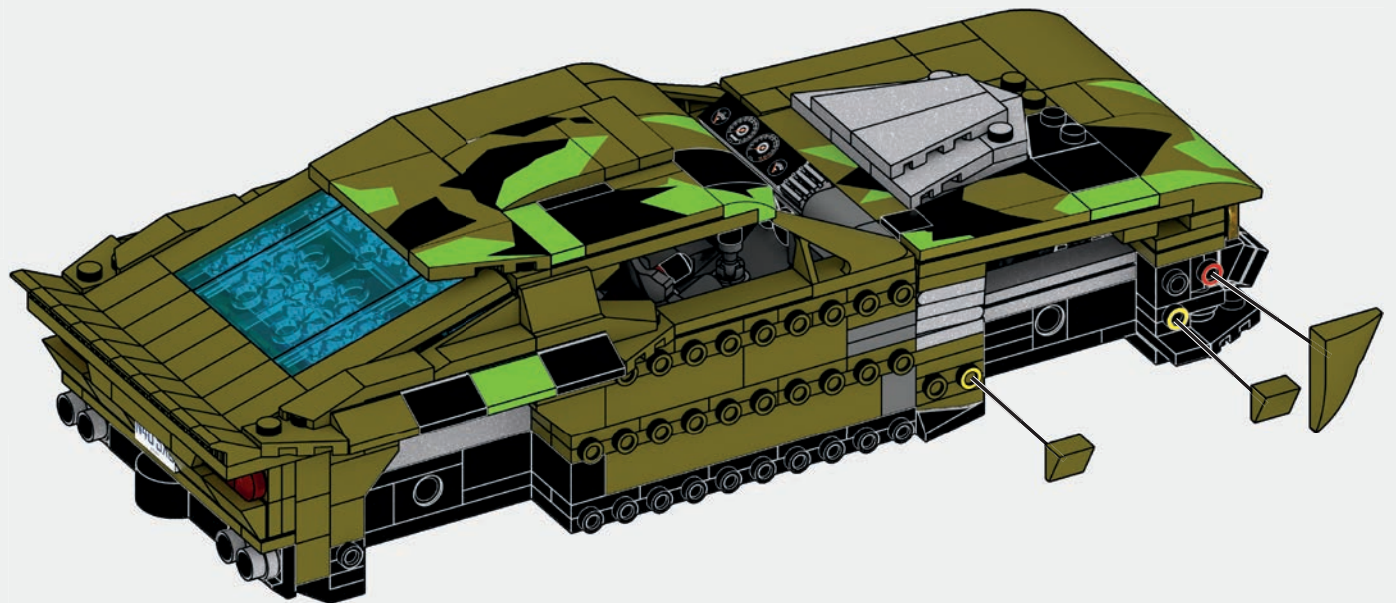
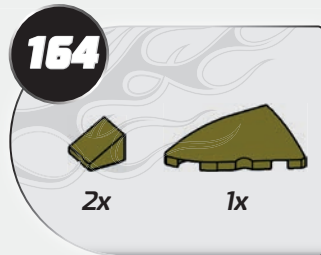
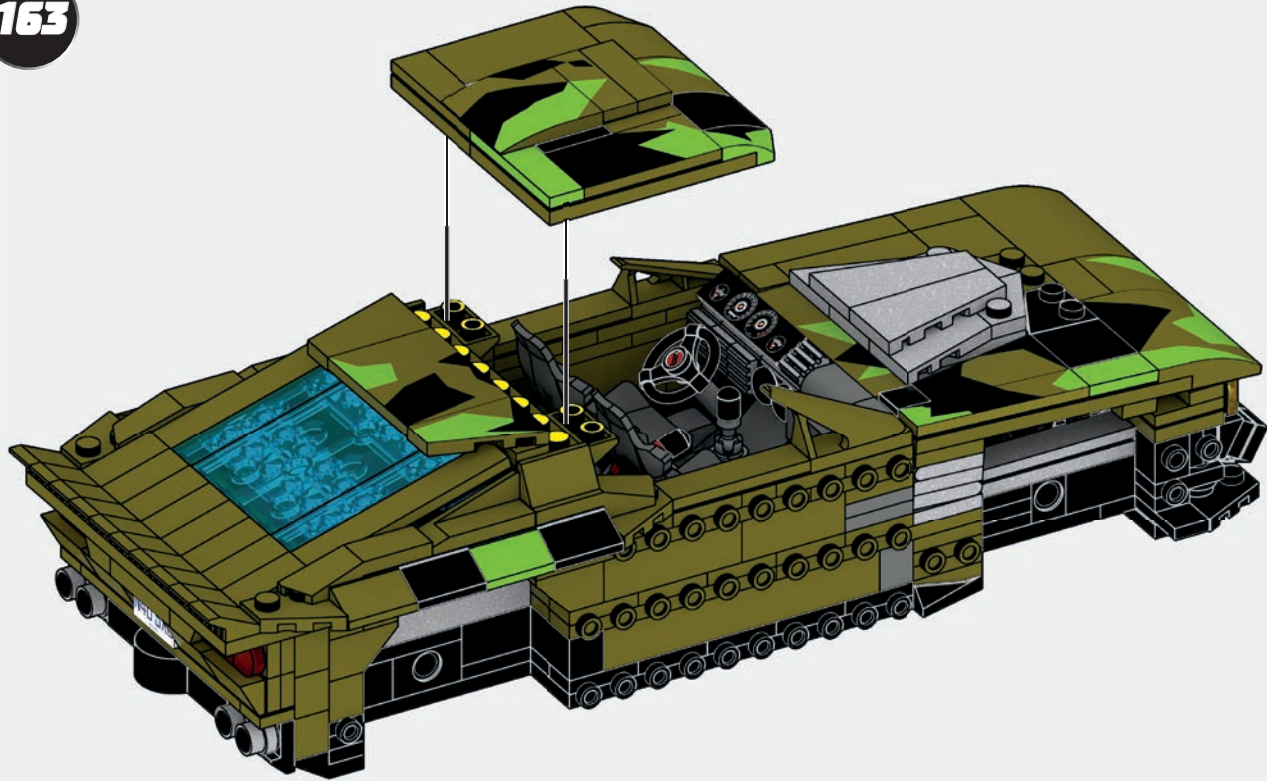

165

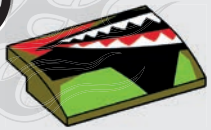

1x



1x

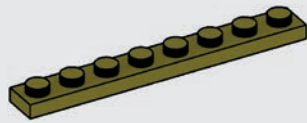

1x

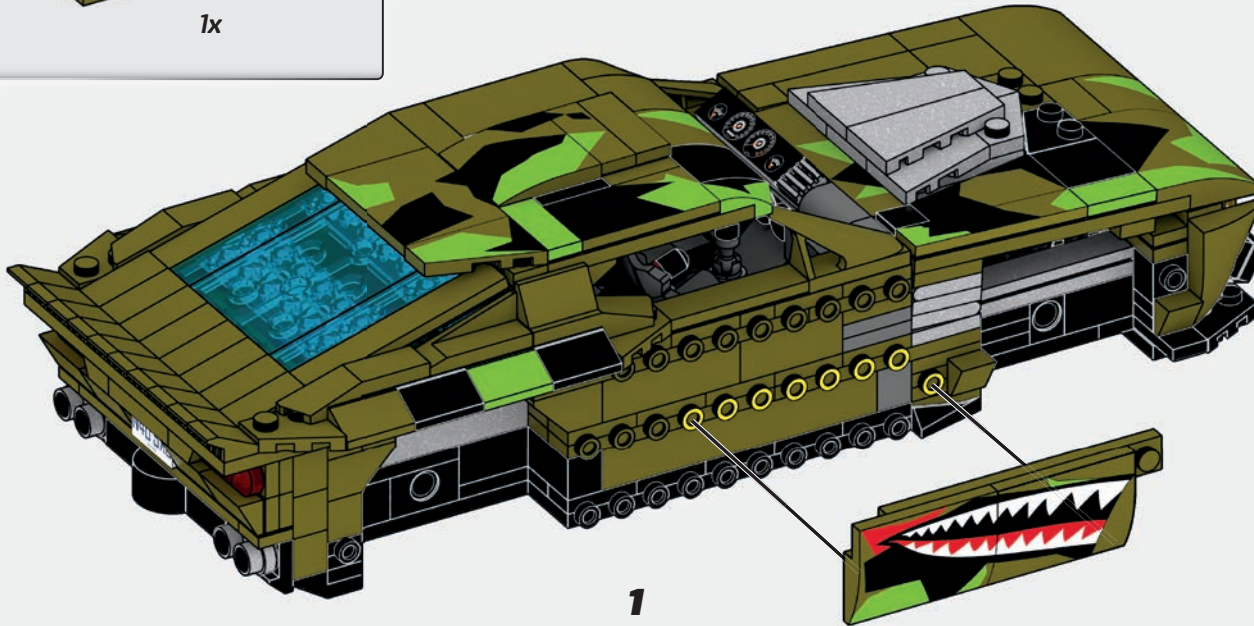
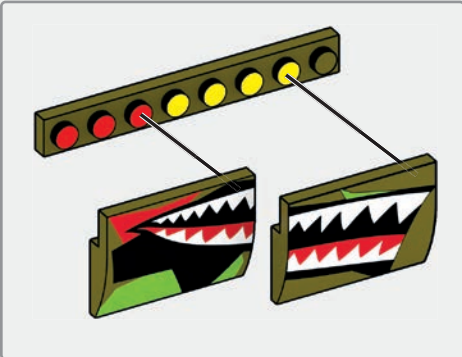

1

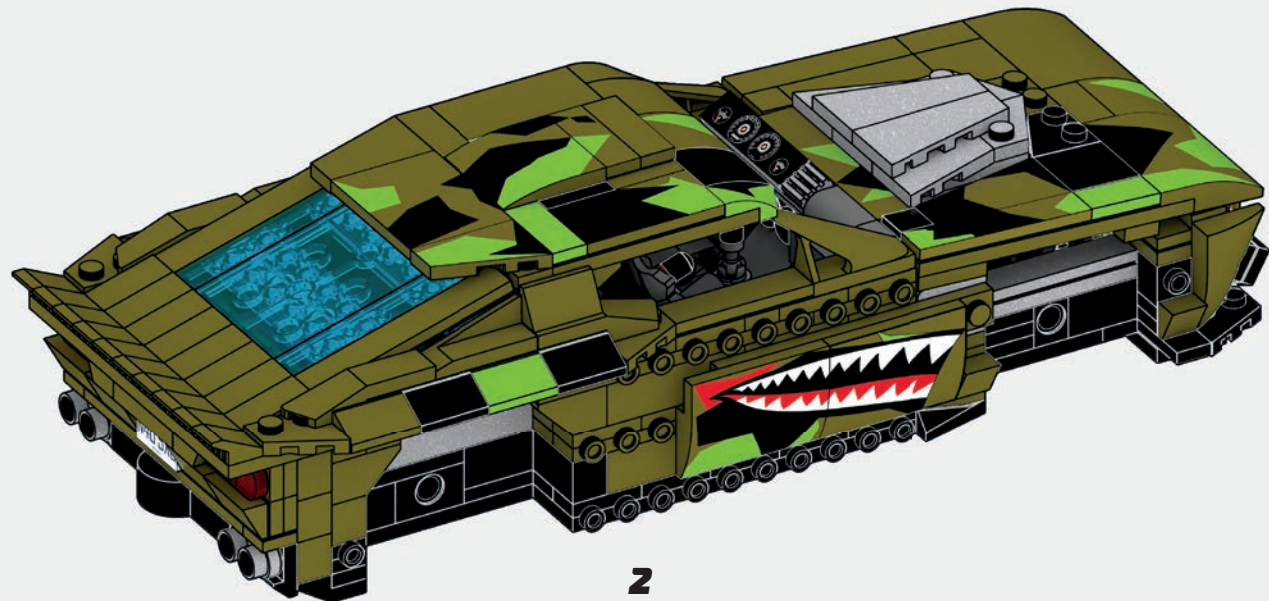

2

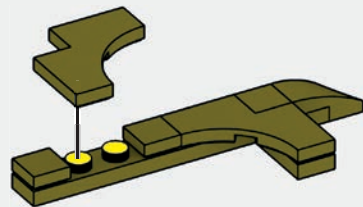
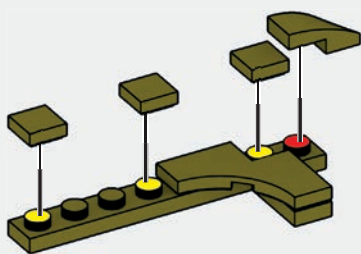
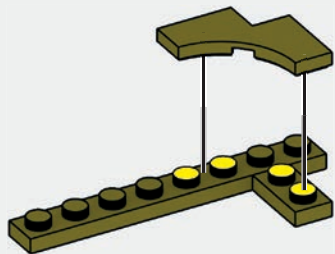
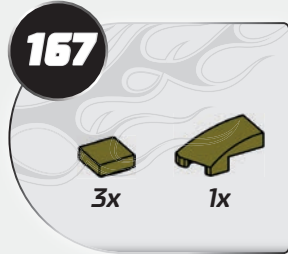
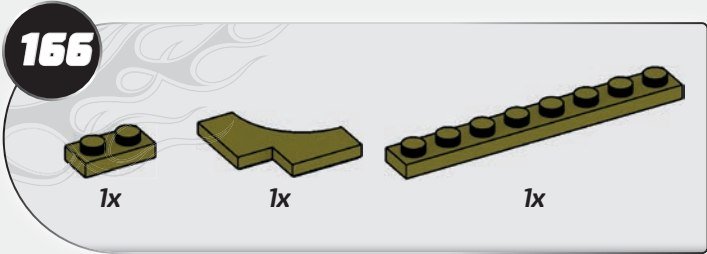

1

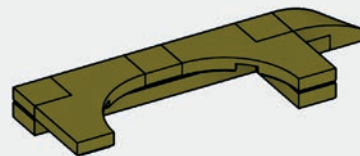

2

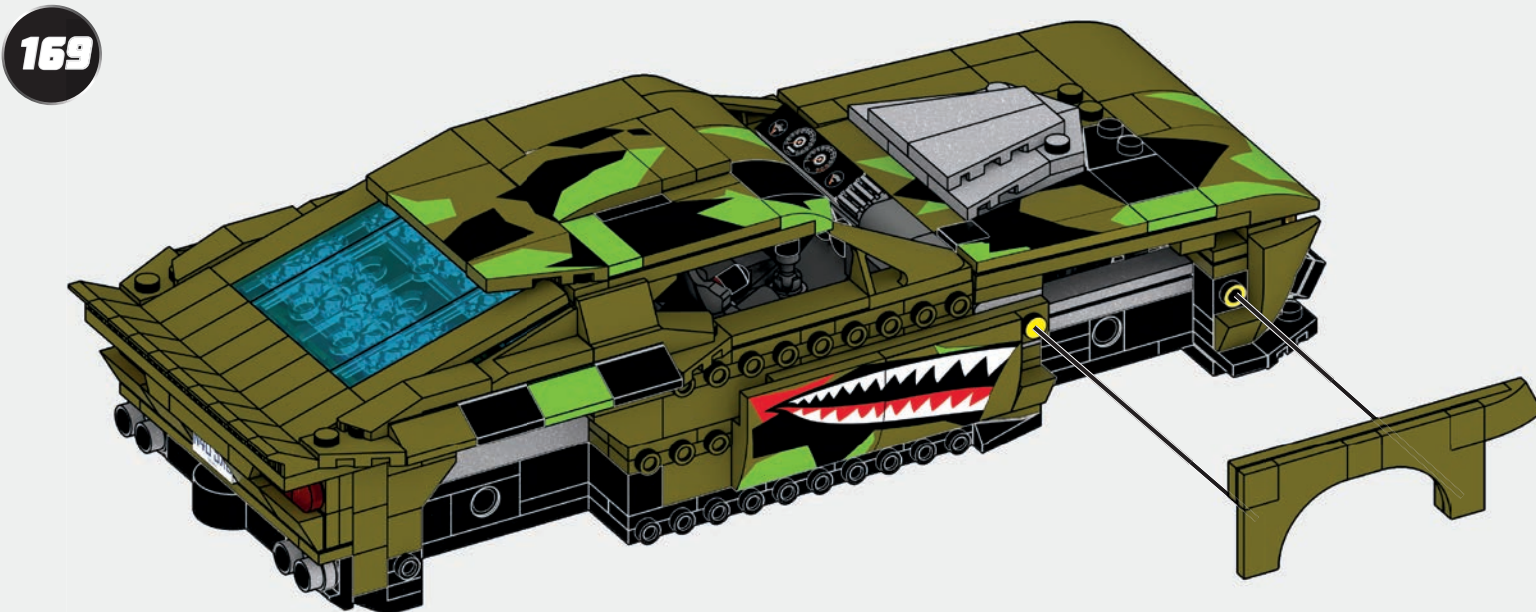

170



1x

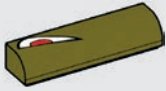

1x

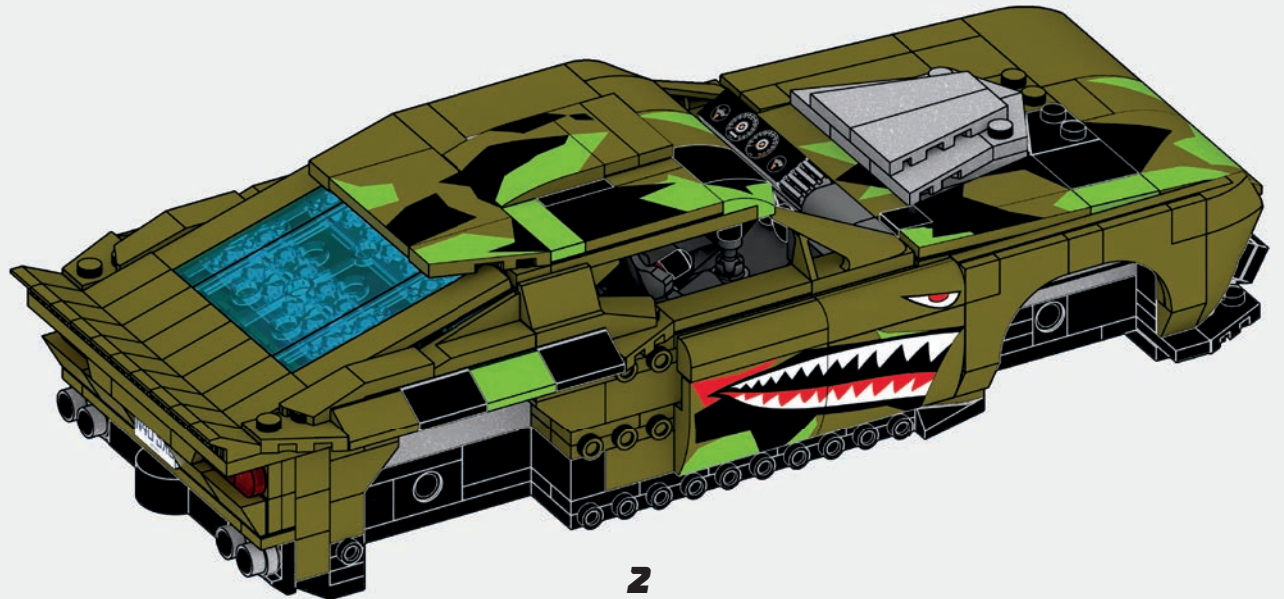
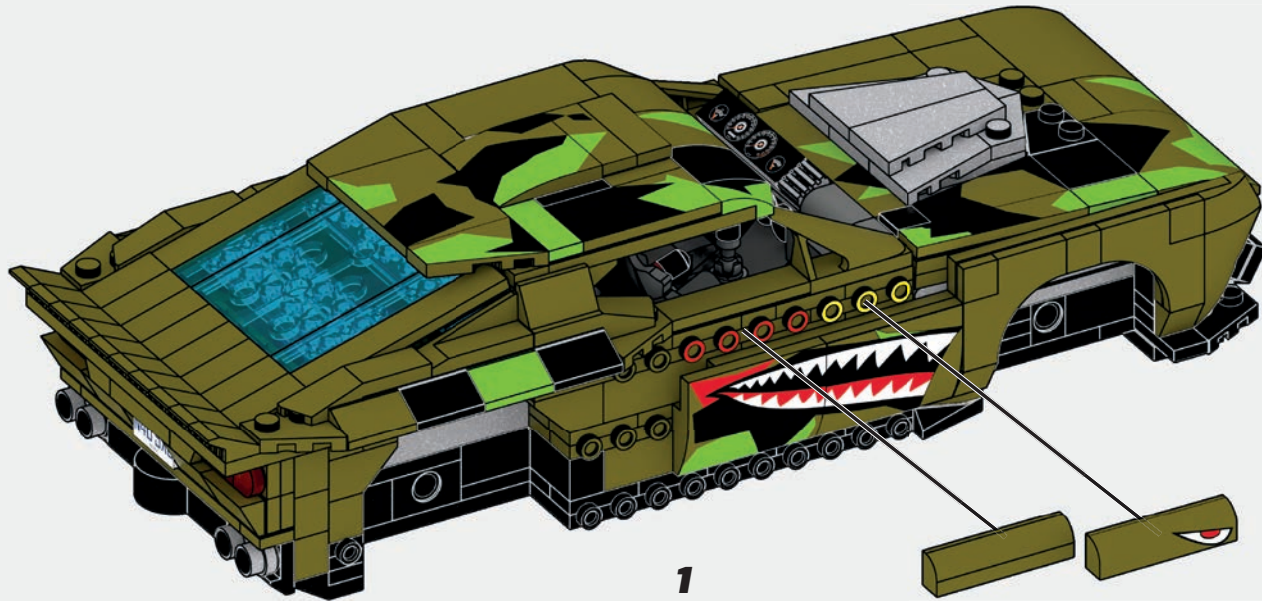

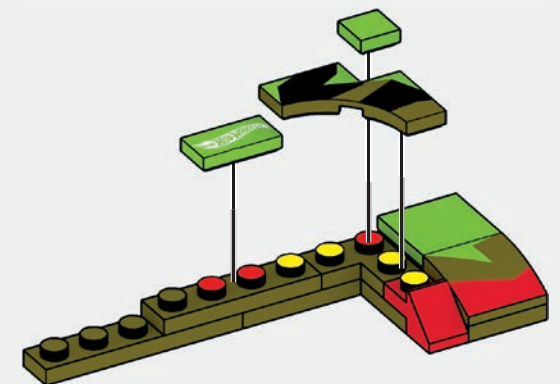
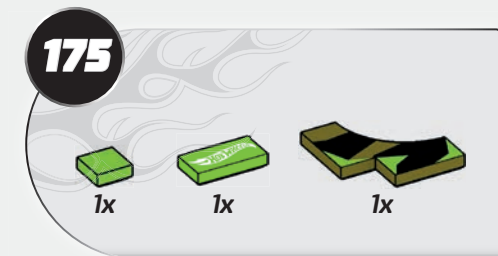
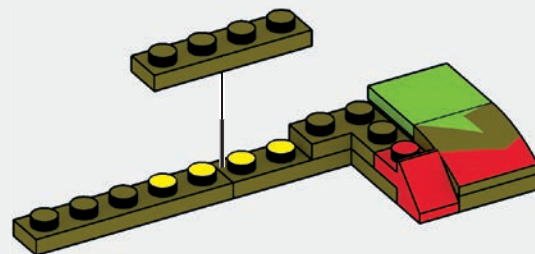
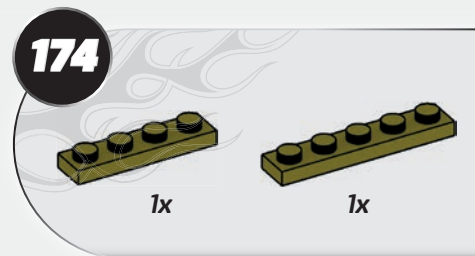
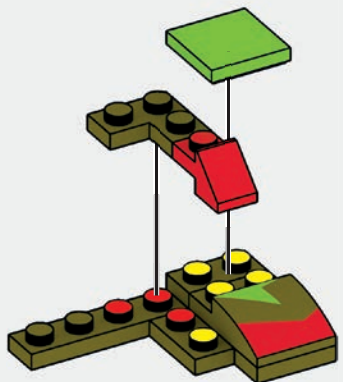
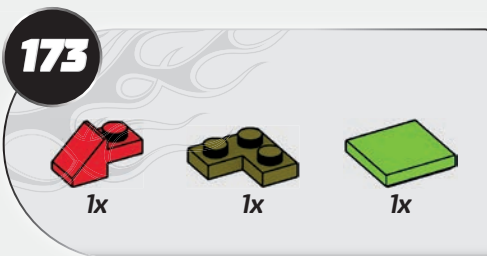
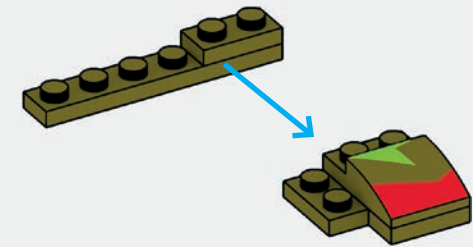
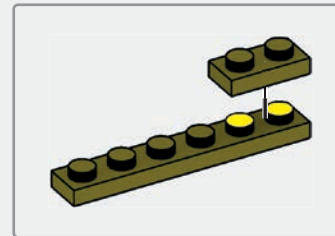
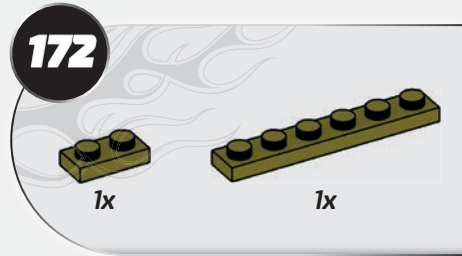
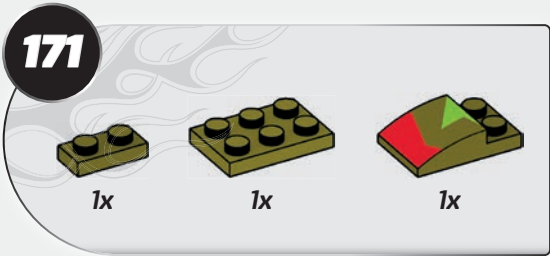

176

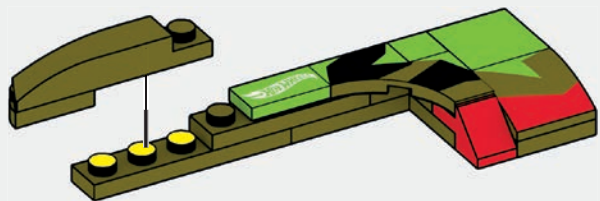
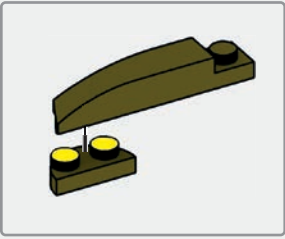
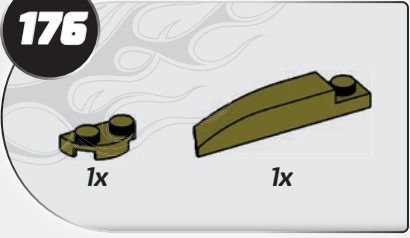

177

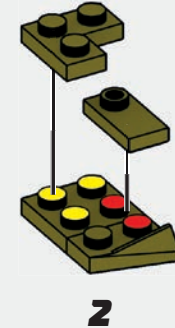
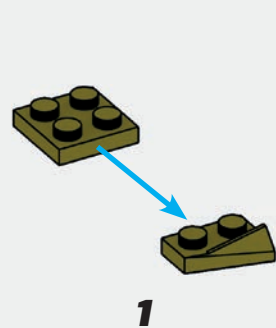
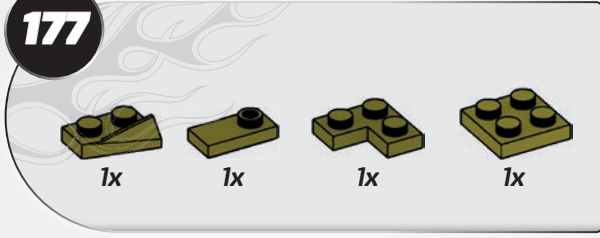

178

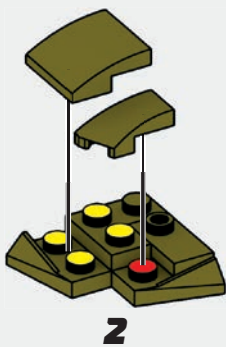
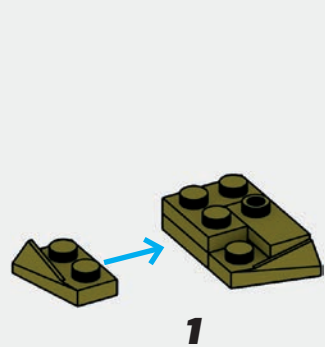
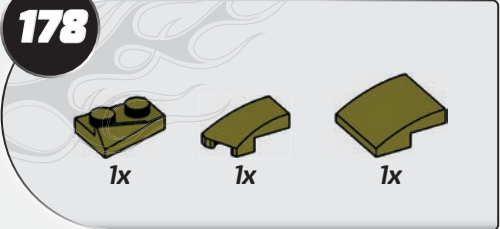

179

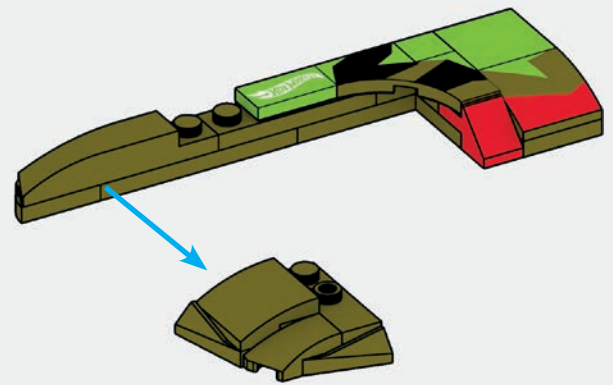

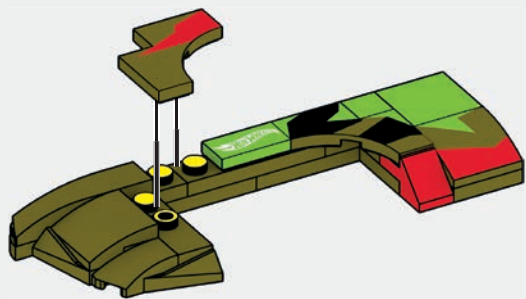
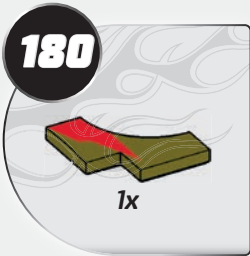

1

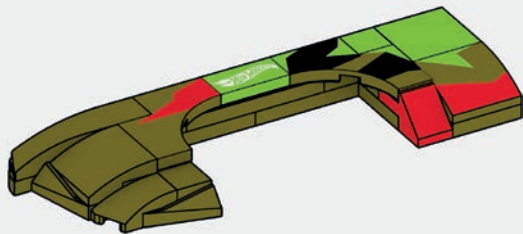

2

181

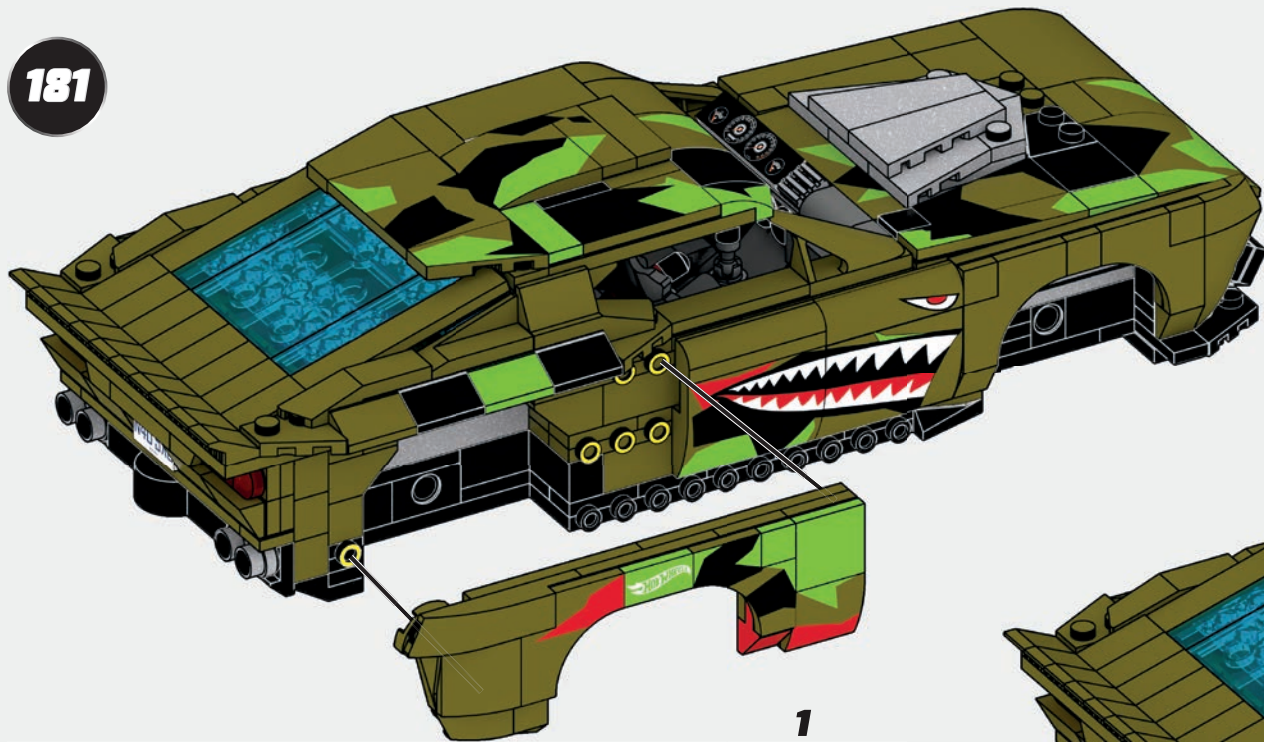

1

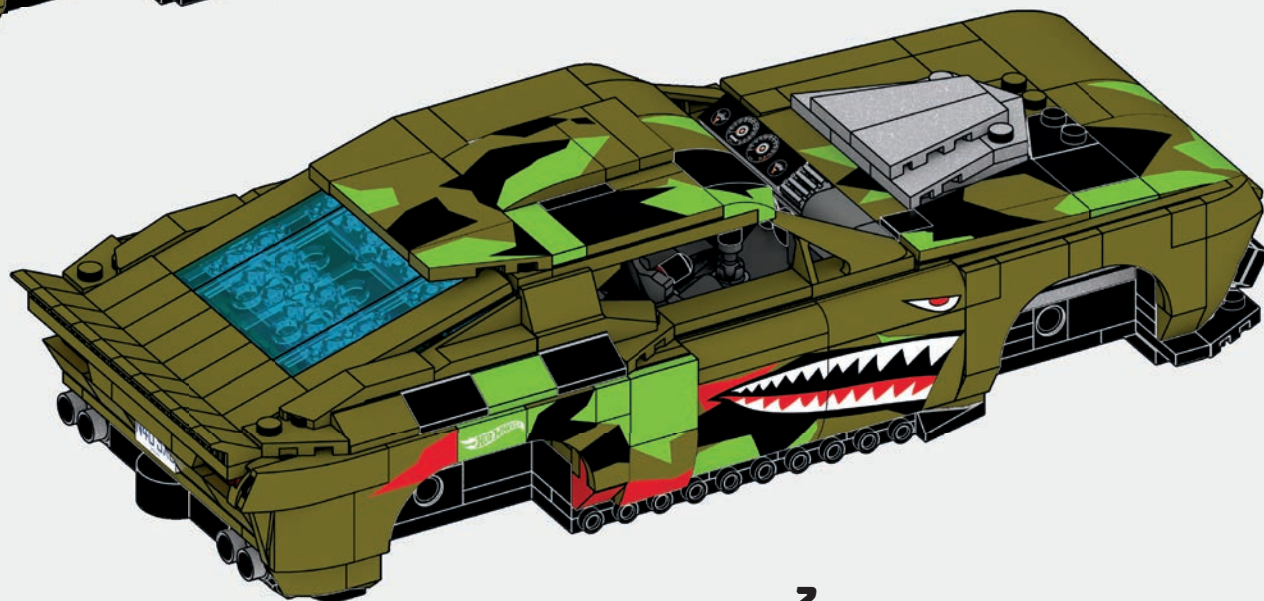

2

182

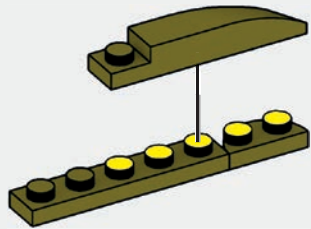
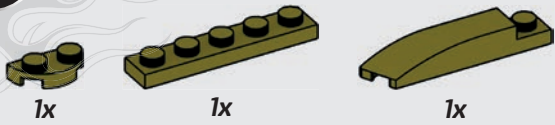

183

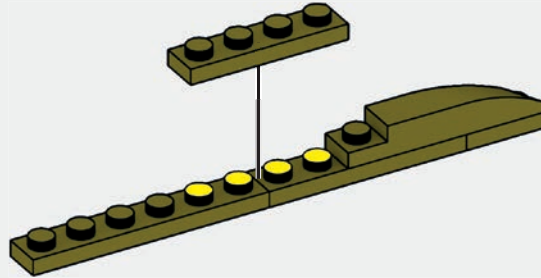
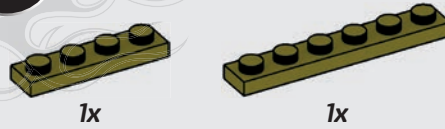

184

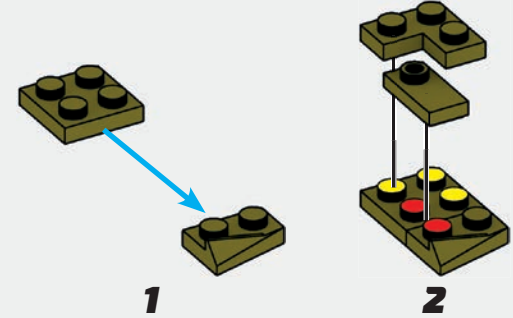
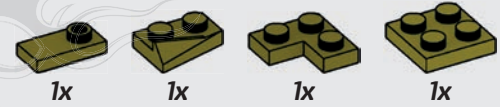

185

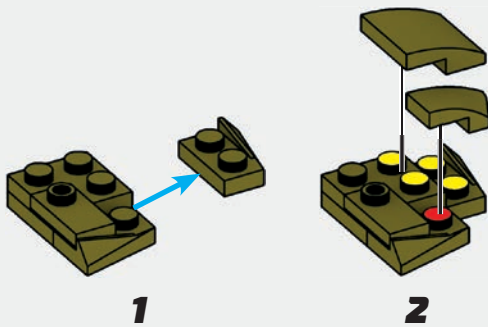
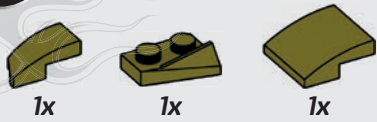

186

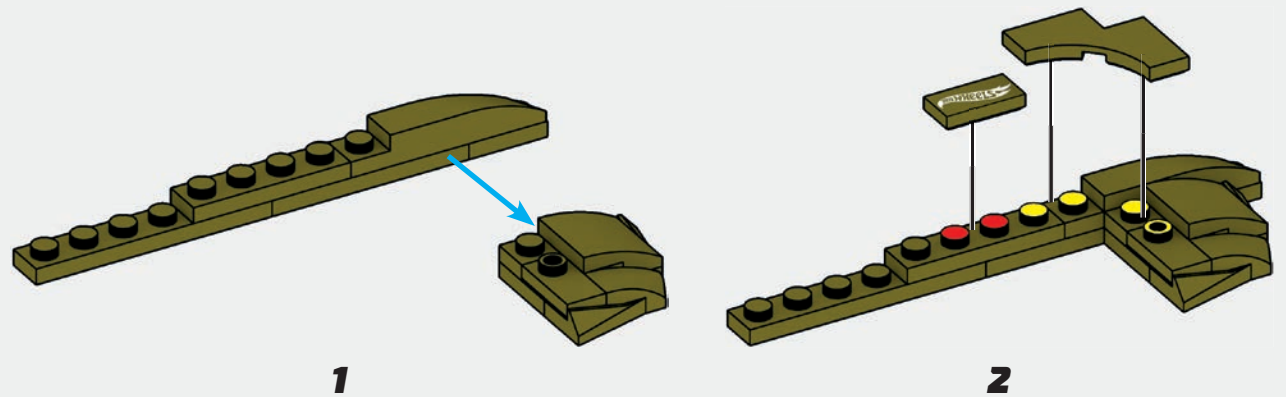

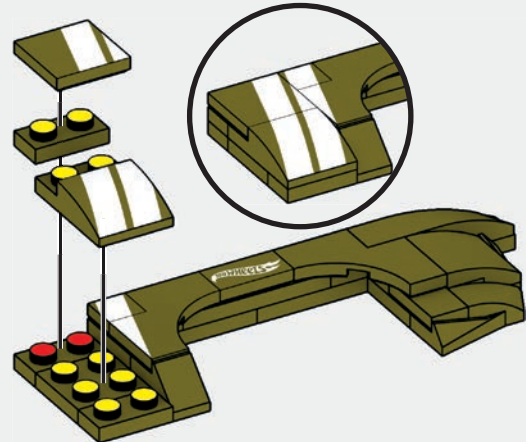
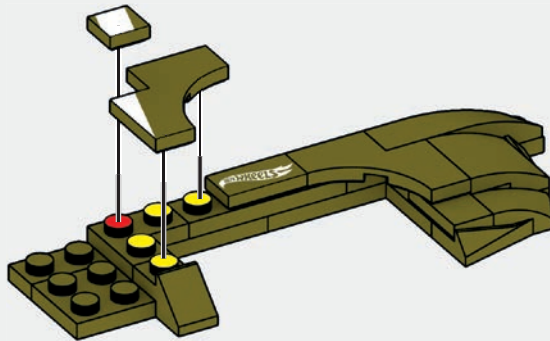
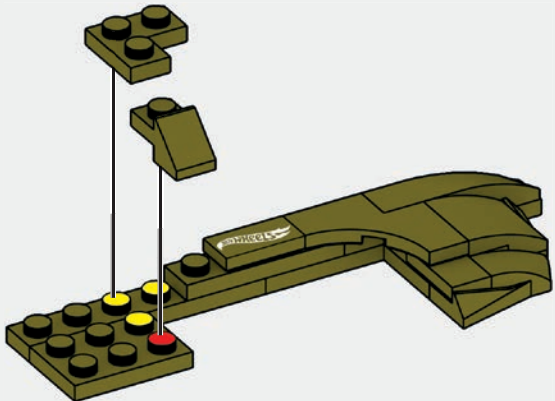
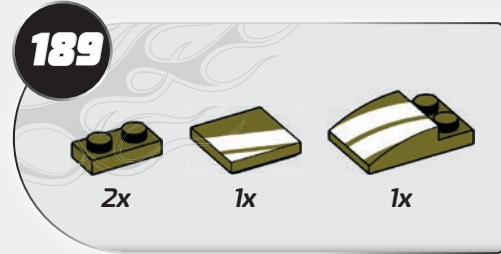
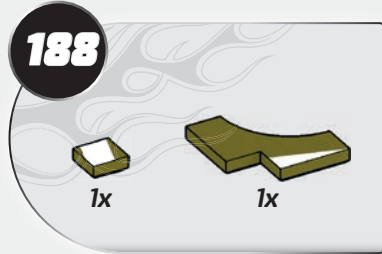
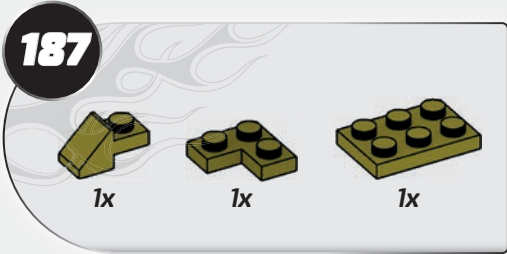

190

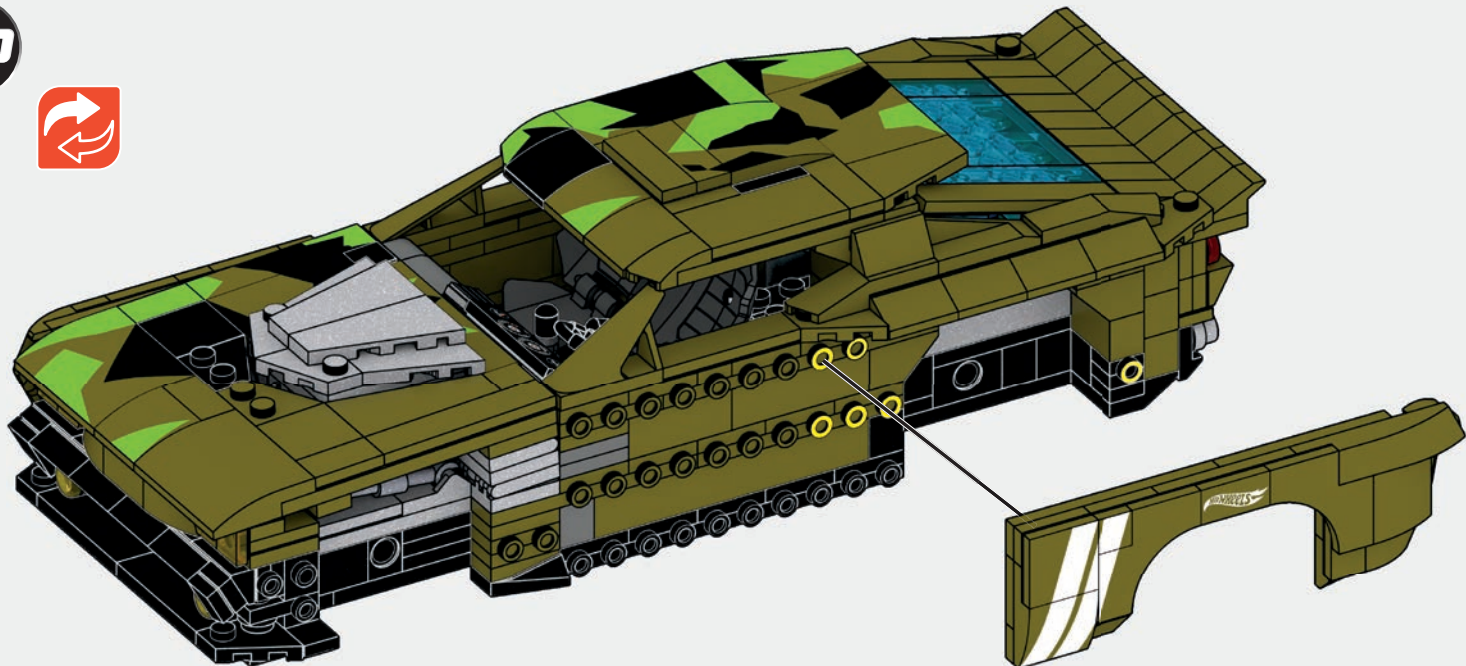

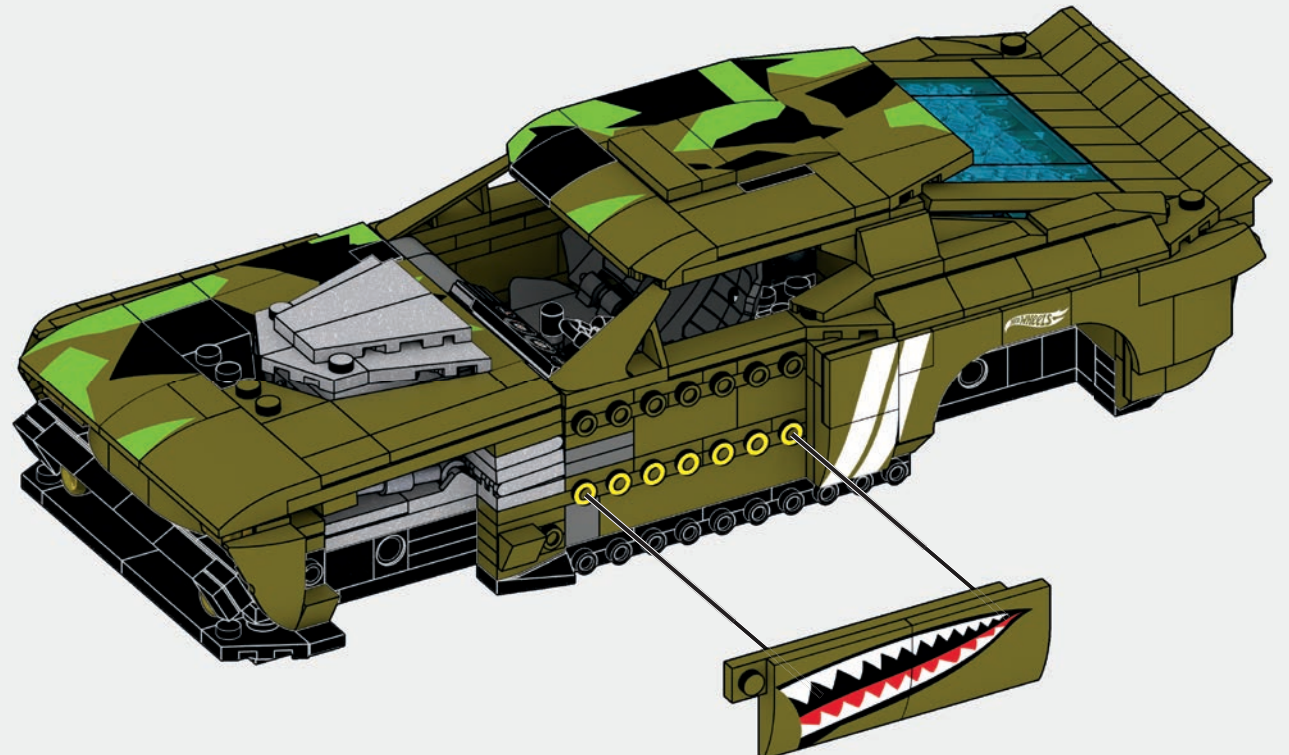
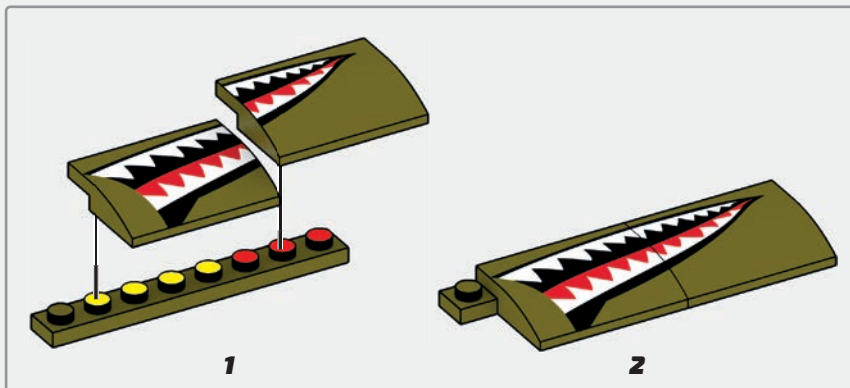
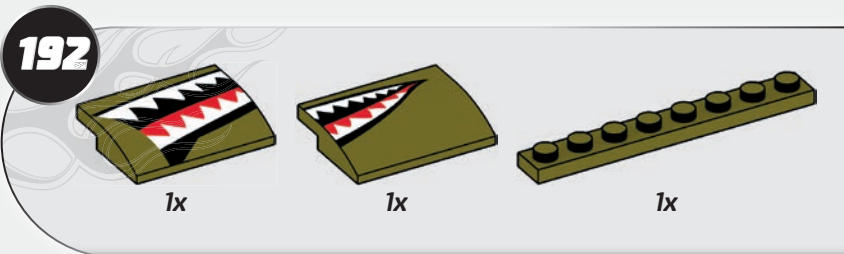
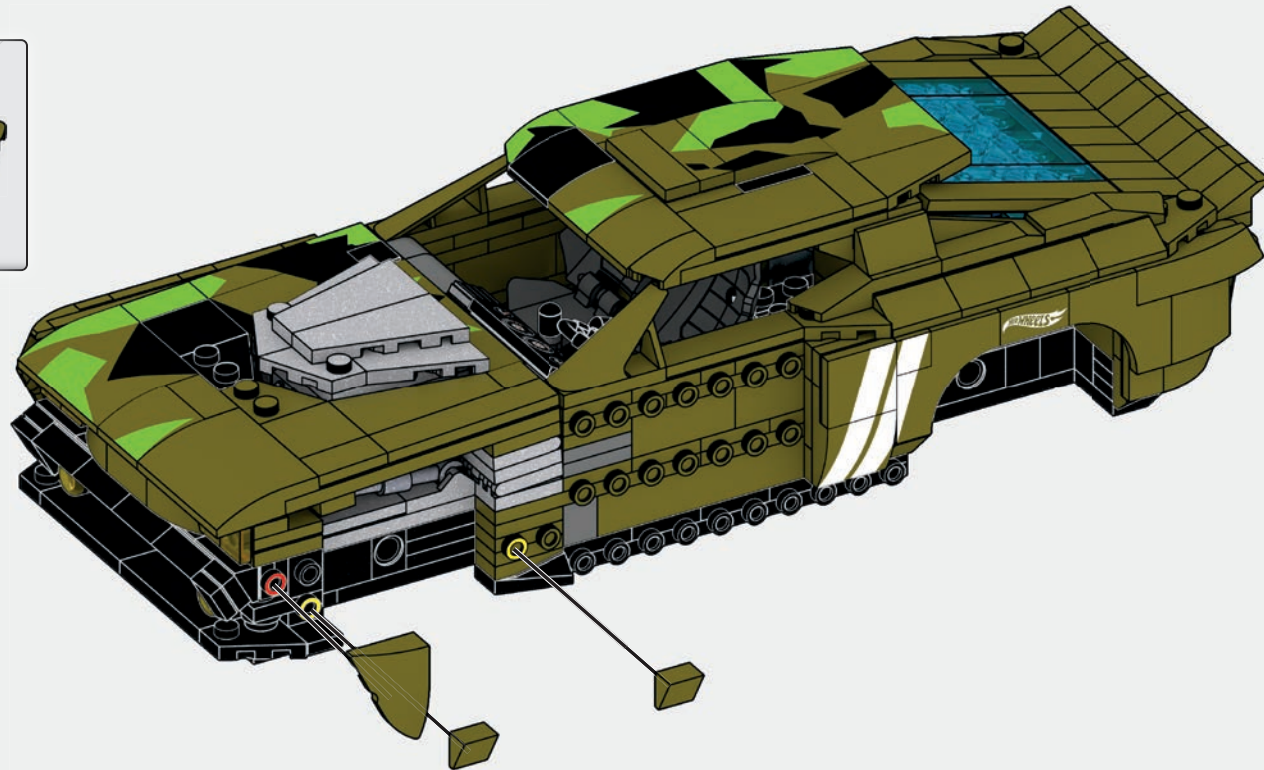
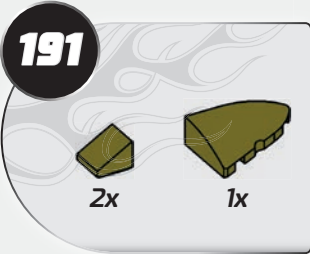

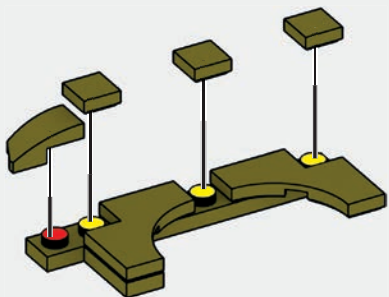
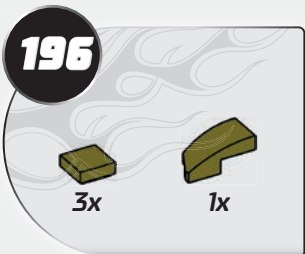
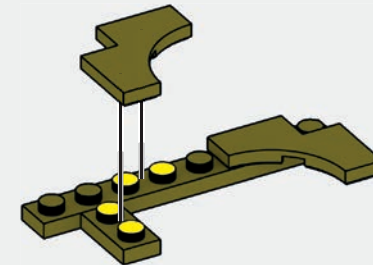
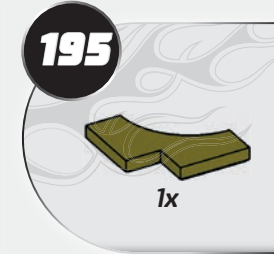
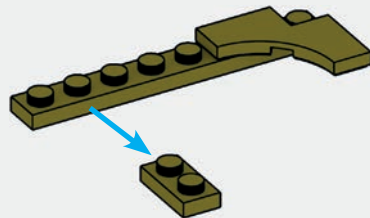
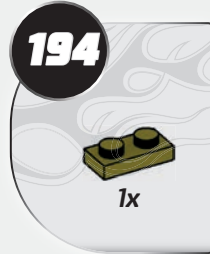
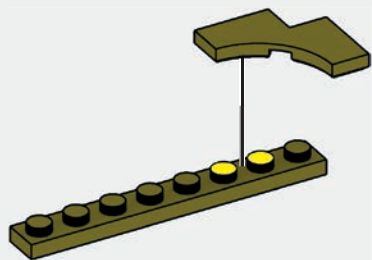
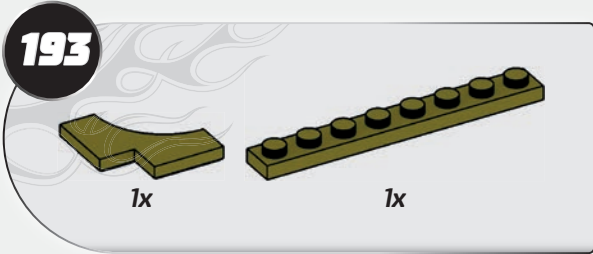

1

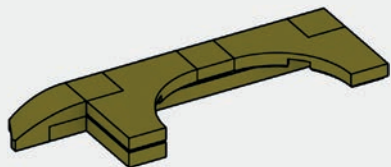

2

197

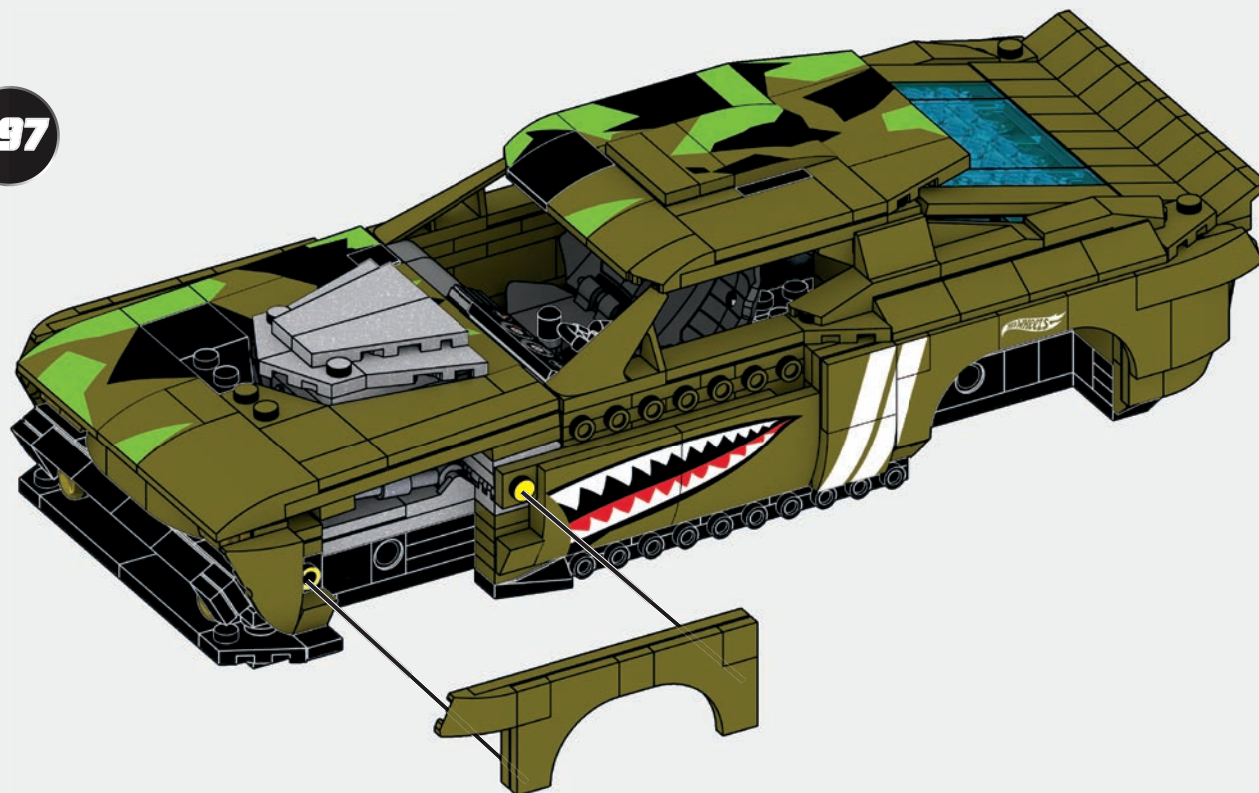

198



1x



1x

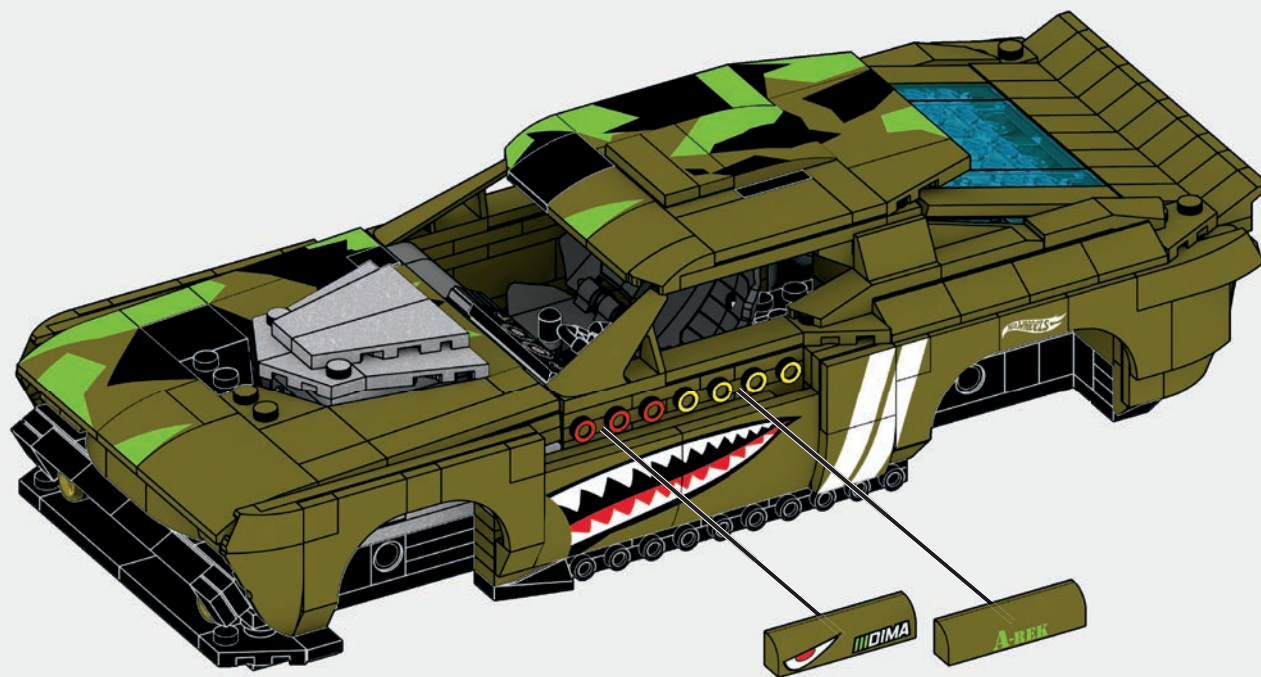



199

4x

2x

2x

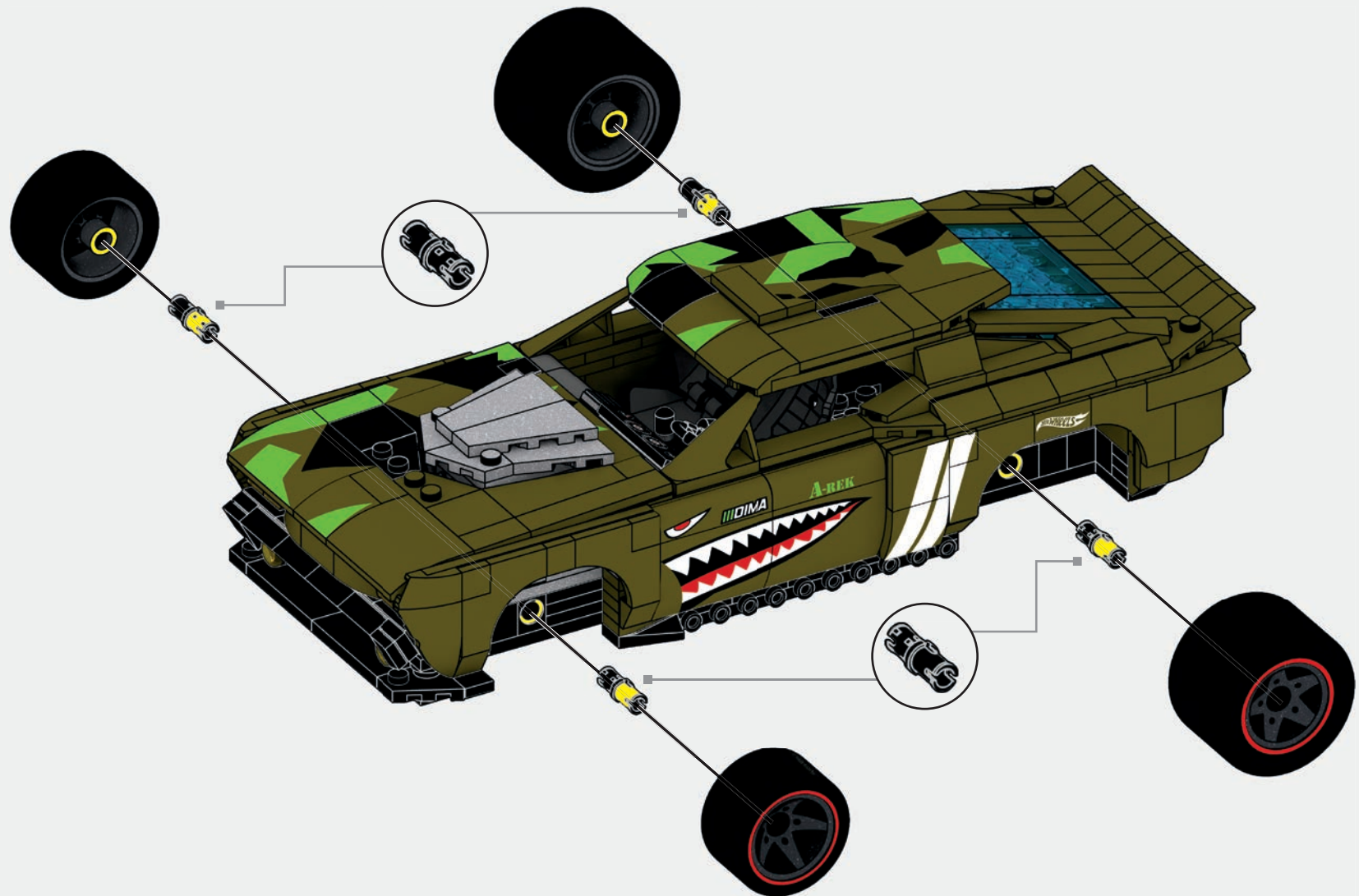

200



5x

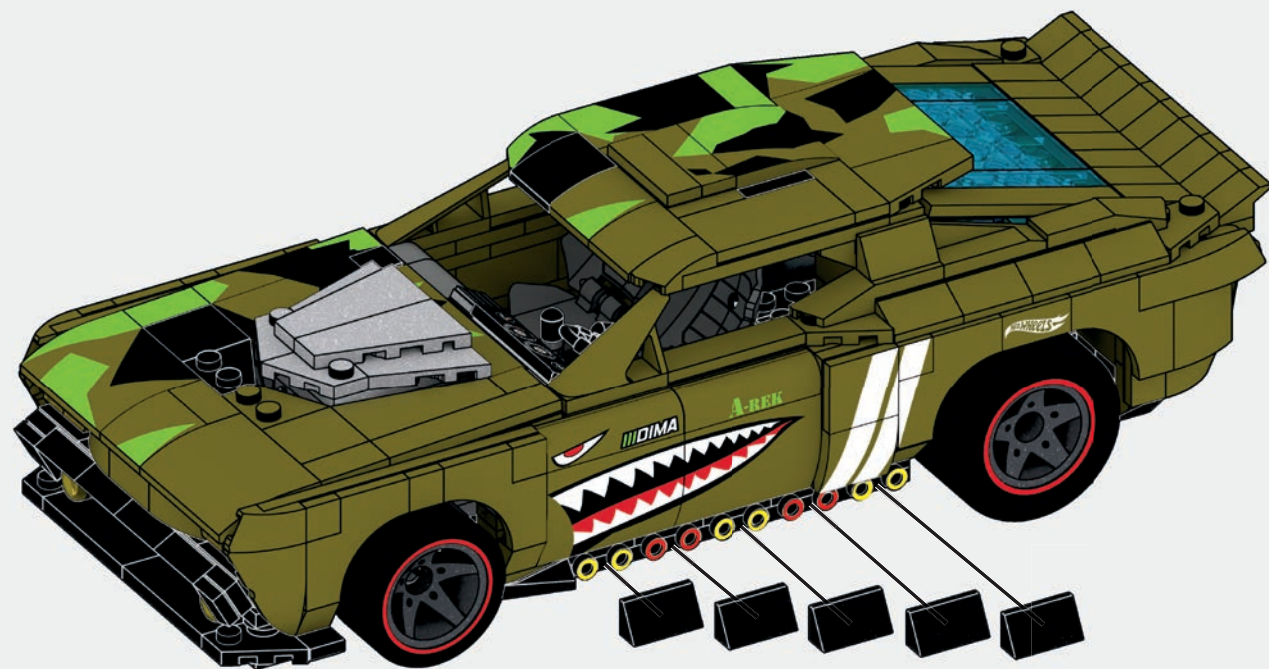

1

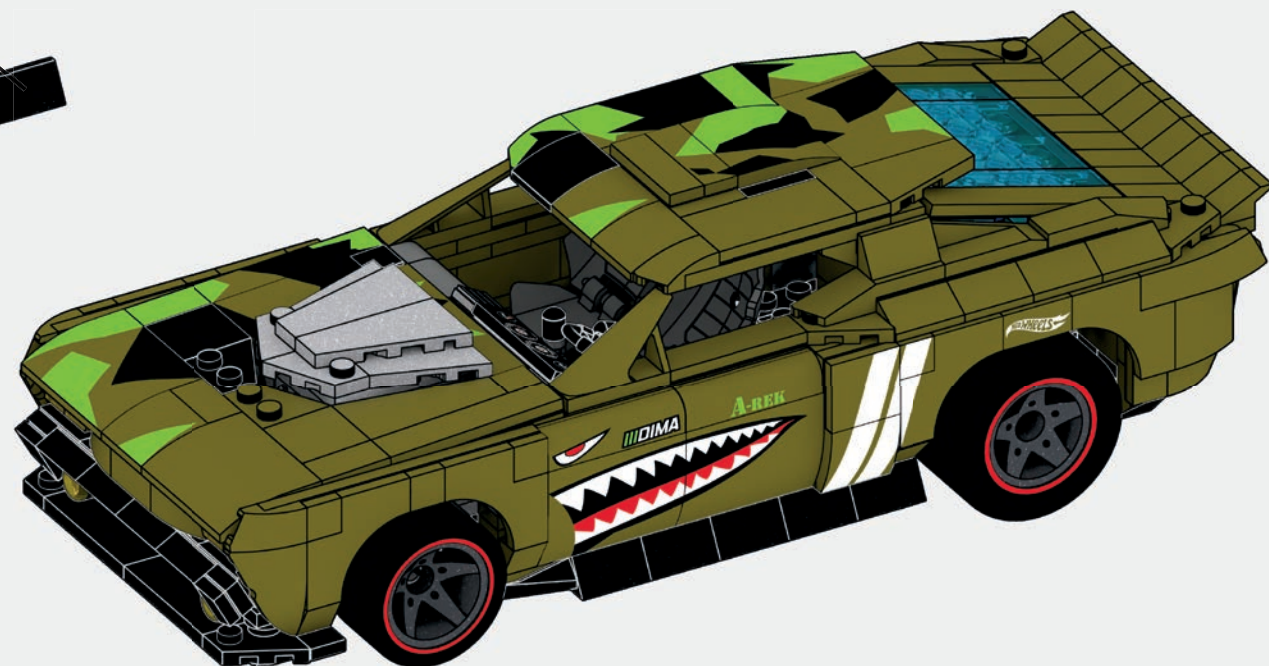

2

201



5x

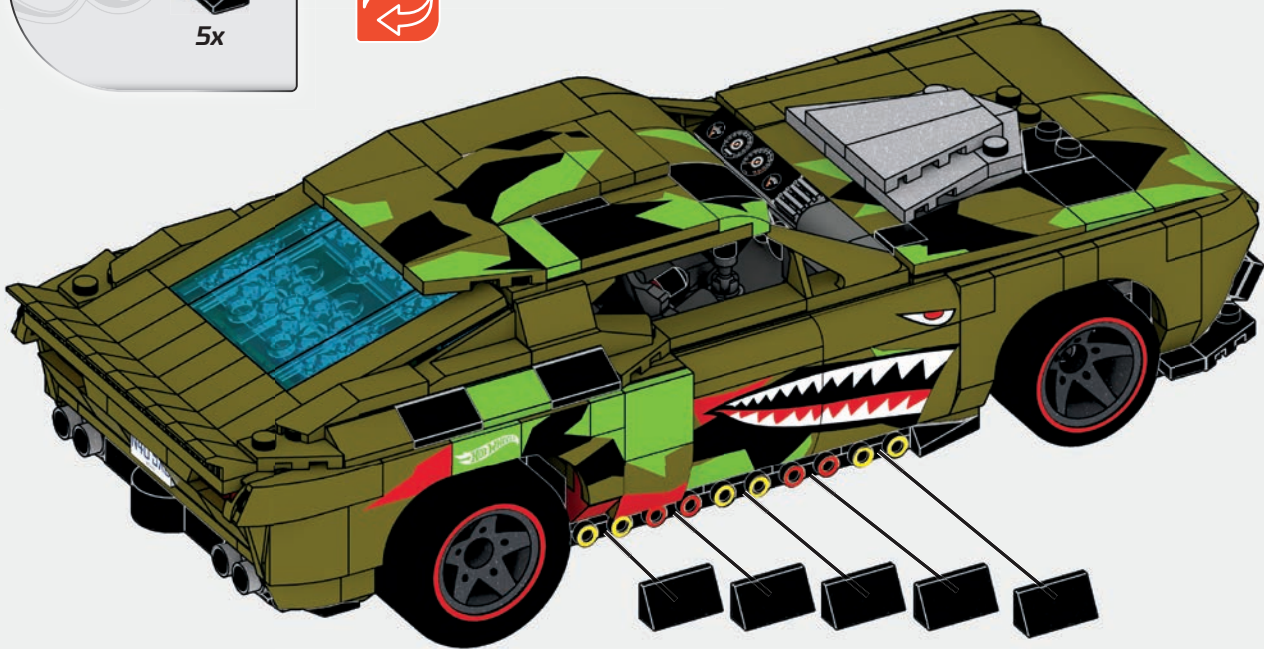

1

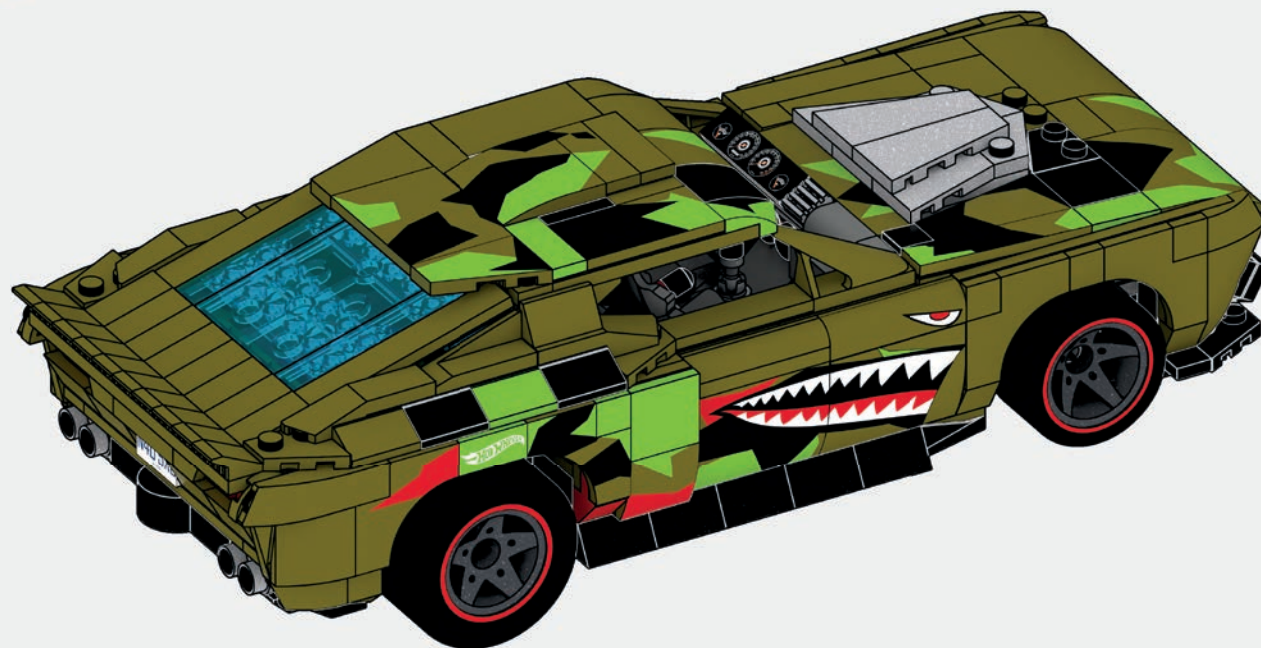

2



2x AM77583F	3x AM03328BDG	2x AM80356AYT	2x AM79375AXU	8x AM79070AYT	8x AM17128AXU	1x AM04245B	8x AM15484AXU	4x AM09267APG	2x AM17153AYT	1x AS-HHL99-08	1x AM81518AXU
1x AM74397AMC	3x AM03328AXU	2x AM18286AYT	1x AS-HHL99-20	6x AM79070AXU	2x AM17522BDG	14x AM18549AYT	7x AM15484BDG	4x AM09268APG	2x AM17153APG	1x AM19898APG	1x AM81519AXU
1x AM74397APG	2x AM79590AXU	1x AM01312APG	1x AS-HHL99-26	2x AM79070AWB	1x AM18740AMC	6x AM18549AXU	1x AM15484AMC	10x AM03773AXU	4x AM01154AXU	4x AM03772AXU	1x AM81516AXU
1x AS-HHL99-30	6x AM79590AYT	1x AM12251APG	1x AS-HHL99-29	4x AM80573AXU	1x AM18740AXU	1x AM03017BDG	2x AM15484AYT	2x AM03773AYT	4x AM03773AWB	1x AM03772APG	1x AM81517AXU
2x AM75332F	2x AM77574AXU	1x AM78395APG	2x AM022501AYT	4x AM80573AXU	2x AM18901APG	1x AM03017BDG	1x AM72000AWB	4x AM03773AWB	1x AM03873APG	1x AS-HHL99-17	1x AM81517AXU
2x AM75332ZD	4x AM79665AXU	1x AM74299ZD	1x AM022501JS	4x AM18272APG	4x AM18272APG	1x AM77206AWB	1x AM0948JS	1x AM09113AWB	3x AM09023APG	1x AS-HHL99-24	2x AM77045BDG
2x AM01113AYT	1x AM74648AMC	1x AM74299XD	3x AM022501AXU	5x AM18272AYT	4x AM72534F	1x AM17834AYT	1x AS-HHL99-16	5x AM18223AYT	2x AM09023APG	5x AM78472AXU	2x AM81380AWB
1x AM17062AMC	1x AM19319APG	1x AM74299X	3x AM09198AYT	2x AM15480AXU	1x AM81384F	1x AM17834AYT	1x AM0948AXU	2x AM18223AYT	2x AM09023AXU	1x AS-HHL99-19	1x AS-HHL99-11
1x AM15026APG	1x AM81545APG	1x AM74299AXU	6x AM73758AXU	1x AM15480AYT	2x AM17070AWB	6x AM04429APG	1x AM0948F	2x AM18223AXU	1x AM09023B	1x AS-HHL99-25	1x AM10273BDG
2x AM76204X	1x AM81546APG	1x AM74299AYT	2x AM73758AYT	2x AM15481AXU	1x AM79355AWB	2x AM79877AYT	8x AM01314AXU	3x AM74106AXU	1x AM09023B	1x AS-HHL99-27	1x AM17601B
4x AM79666APG	1x AM17787BDG	1x AM74300X	26x AM09393AXU	1x AM15481AYT	1x AM18665AYT	4x AM09013AYT	1x AM01314AMC	2x AS-HHL99-01	1x AM09023B	1x AM81260AMC	2x AM16384AYT
1x AM07223JS	4x AM17127AXU	1x AM74300ZD	3x AM09393AWB	1x AM15481AYT	1x AM18665APG	1x AM09013AXU	2x AM01314AMC	2x AM74106AXU	2x AM81259AXU	1x AM81260AMC	7x AM16384AXU
9x AM07223AXU	2x AM76277APG	1x AM74300AXU	4x AM09393AYT	8x AM09835AYT	1x AM18665F	1x AM09013AXU	1x AM09013AXU	1x AM74106F	2x AM81259AWB	1x AM78189AXU	2x AM16384APG
1x AS-HHL99-18	2x AM0910APG	1x AM74300AYT	2x AM09393AYT	3x AM74427AXU	2x AM18665AXU	3x AM09013BDG	2x AM74103AWB	1x AM74106F	1x AM81259AWB	5x AM78189AXU	
2x AM07223ZD	2x AM0910APG	10x AM17018AXU	2x AM16649APG	1x AM78926AXU	1x AM18666AYT	1x AS-HHL99-10	1x AS-HHL99-10	1x AM74106F	1x AM19899AXU	2x AM78189F	
1x AM07223F	5x AM72001APG	1x AM18260APG	2x AM78926AXU	12x AM76467AYT	1x AM18666APG	3x AM17502AXU	2x AM80966AXU	1x AM19899APG	1x AM19899APG	1x AM78189JS	
8x AM03328AYT	2x AM01086AYT	1x AM17506APG	2x AM76467AYT	18x AM76467AXU	1x AM18666APG	1x AM17502APG	1x AM80966APG	1x AM19899APG	2x AM77046BDG		
2x AM03328APG	2x AM01086AXU	2x AM74645APG	4x AM74426AXU		3x AM18666AXU						

- 1x AS-HHL99-28
- 3x AM09838AXU
- 1x AM09838JS
- 9x AM09593AXU
- 9x AM09593AYT
- 2x AM80981AXU
- 2x AM80982AXU
- 1x AM81479AXU
- 1x AS-HHL99-12
- 1x AS-HHL99-13
- 1x AS-HHL99-21
- 3x AM01087APG
- 2x AM01087AXU
- 2x AM17503APG
- 2x AM17503AXU

- 1x AM18299F
- 1x AM18299AXU
- 1x AM01531BDG
- 1x AM09493AYT
- 2x AM09493APG
- 1x AM09493AXU
- 1x AM09033AYT
- 1x AM19014AXU
- 1x AM19013AXU
- 1x AS-HHL99-09
- 7x AM07475AXU
- 1x AS-HHL99-04
- 1x AM17793AXU
- 1x AM17793APG

- 1x AS-HHL99-03
- 1x AM77321APG
- 1x AM77320APG
- 1x AM77320AXU
- 1x AS-HHL99-07
- 1x AM77463AXU
- 9x AM09292AXU
- 1x AM09292AYT
- 2x AM09292BDG
- 1x AS-HHL99-05
- 4x AM16331AXU
- 2x AM16331AAV

- 1x AM01480AYT
- 2x AM01480AXU
- 3x AM01313AYT
- 2x AM01313APG
- 1x AS-HHL99-02
- 1x AS-HHL99-15
- 1x AS-HHL99-14
- 1x AS-HHL99-22
- 1x AM72412AXU
- 1x AS-HHL99-23
- 2x AM18617AYT
- 1x AM17054APG

- 2x AM17055AXU
- 1x AM16389AAV
- 1x AM09922AXU
- 7x AM18298AXU
- 2x AM18298APG
- 2x AM08483AAV
- 1x AM08483AYT
- 3x AM08483AXU
- 2x AM10233AXU
- 1x AM17845AYT
- 2x AM09923AYT



Missing pieces? • Pièces manquantes?
 ¿Partes faltantes? • Perdeu peças?
 Fehlen Teile? • Не хватает деталей?

support.megabrands.com

Mattel Europa B.V., Gondel 1, 1186 MJ Amstelveen, Nederland. Mattel U.K. Limited, The Porter Building, 1 Brunel Way, Slough SL1 1FQ, UK. Mattel France, Parc de la Cerisaie, 1/3/5 allée des Fleurs, 94260 Fresnes Cedex. N° Cristal 0969 36 99 99 (Numéro non surtaxé) ou www.lesjouetsmattel.fr Mattel Belgium, Trade Mart, Atomiumsquare, Bogota 202 - B 275, 1020 Brussels. Gratis nummer België: 0800 - 16 936 - Gratis nummer Luxemburg: 800 - 22 784 - Gratis nummer Nederland: 0800 - 262 88 35. Deutschland: Mattel GmbH, Solmsstraße 83, D-60486 Frankfurt am Main. Schweiz: Mattel AG, Kirchstrasse 24, CH-3097 Liebefeld. Österreich: Mattel Ges.m.b.H., Campus 21, Liebermannstraße A01 404, A-2345 Brunn/Gebirge. Mattel Italy Srl, Via Turati 4, 20121 Milano, Italy. Servizio assistenza clienti: Customersrvitalia@mattel.com - Numero verde 800 11 37 11. Mattel España, S.A., Aribau 200 pl. 9, 08036 Barcelona. cservice.spain@mattel.com Tel.: +34 933 06 79 00 http://www.service.mattel.com/es. Mattel East Asia Ltd., Room 503-09, North Tower, World Finance Centre, Harbour City, Tsimshatsui, HK, China. Tel.: (852) 3185-6500. Diimporter/Diedarkan Oleh: Mattel Continental Asia Sdn Bhd. Level 19, Tower 3, Avenue 7, No. 8 Jalan Kerinchi, Bangsar South, 59200 Kuala Lumpur, Malaysia. Mattel South Africa (PTY) LTD, Office 102 I3, 30 Melrose Boulevard, Johannesburg 2196. Dystrybutor: Mattel Poland Sp. z o.o., Warsaw Trade Tower 34 p., ul. Chłodna 51, 00-867 Warszawa. Mattel Australia Pty. Ltd., 658 Church St., Richmond, Victoria, 3121. Consumer Advisory Service - 1300 135 312. Mattel AEBE, Εθνάρχου Μακαρίου 1, Κτήριο Κ-2, ΤΚ 17561, Παλιό Φάληρο, Mattel Oyuncakçılık Tic. Ltd. Şti. İçerenköy Mah., Umut Sok. No:10-12 Quick Tower Kat:2/15 34752 Ataşehir İstanbul Tel: 0216 570 75 00. Импортёр/Уполномоченная организация: ООО "МАТТЕЛ" Российская Федерация, 105120 Москва, 2-й Сыромятинский переулок; +7 495 287 79 39. Mattel Czech Republic s.r.o., The Forum, Václavské nám. 19, 11000 Praha1. Mattel, 333 Continental Boulevard, El Segundo, CA 90245, USA. Consumer Services: 1-800-465-MEGA (6342). Mattel Canada Inc., Mississauga, Ontario L5R 3W2. Consumer Services: You may call us free at/ Composez sans frais le 1-800-524-8697. Importado y distribuido por México de México, S.A. de C.V., Miguel de Cervantes Saavedra No. 193, Pisos 10 y 11, Col. Granada, Alcatlalia Miguel Hidalgo, C.P. 11520, México, Ciudad de México. R.F.C. MME-920701-NB3. Tels.: 59-05-51-00 Ext. 5206 6 01-800-463-59-89. Mattel Chile, S.A., Avenida Américo Vespucio 501-B, Quilicura, Santiago. Tel.: 1230-020-6213. Servicio al consumidor Venezuela: Tel.: 0-800-100-9123. Mattel Argentina, S.A., Av. Libertador 1000, Piso 11 - Oficinas 109 y 111, Vicente López - Prov. Buenos Aires. Tel.: 0800-666-3373. Mattel Colombia, S.A., Calle 123#7-07 P5, Bogotá. Tel.: 01800-710-2069. Mattel Perú, S.A., Av. Juan de Arona # 151, Centro Empresarial Juan de Arona, Torre C, Piso 7, Oficina 704, San Isidro, Lima 27, Perú. RUC: 20425853865. Reg. Importador: 02350-12-JUE-DIGESA. Tel.: 0800-54744. E-mail Latinoamérica: servicio_clientes@mattel.com. Mattel do Brasil Ltda - CNPJ: 54.558.002/0001-20 - Rua Verbo Divino, 1488 - 2º Andar - 04719-904 - Chácara Santo Antônio - São Paulo - SP - Brasil. Serviço de Atendimento ao Consumidor: fone 0800 575 0780. E-mail: sac.matteldobrazil@mattel.com

BUILD YOUR COLLECTION CONSTRUISEZ VOTRE COLLECTION



CONSTRUYE TU COLECCIÓN.
CONSTRUA A SUA COLEÇÃO.
ERWEITERE DEINE SAMMLUNG.
ПОСТРОЙТЕ СВОЮ КОЛЛЕКЦИЮ.

Mattel Canada Inc. Mississauga, Ontario L5R 3W2.
MADE IN CHINA. FABRIQUÉ EN CHINE. FABRICADO NA CHINA. HECHO EN CHINA.
ИЗГОТОВЛЕНО В КИТАЕ. ÇIN'DE ÜRETİLMİŞTİR. صنع في الصين

HOT WHEELS® and associated trademarks and trade dress are owned by, and used under license from Mattel. ©2021 Mattel.

©2021 MEGA Brands &™ MEGA Brands.
Printed in China / Imprimé en Chine

AD-HHL99-01B

1186 MJ, 1, NL
© D781,964, D797,203, D841,101



BUILD & SHARE!
CONSTRUIRE ET PARTAGER
CONSTRUYE Y COMPARTE
MONTAR E COMPARTILHAR / BAUEN UND MIT ANDEREN TEILEN / СОЗДАВАЙ И ДЕЛИСЬ
megaunboxed.com



JOIN THE COMMUNITY
REJOIGNEZ LA COMMUNAUTÉ
ÚNETE A LA COMUNIDAD
ENTRE NA COMUNIDADE DER COMMUNITY BEITRETEN
ПРИСОЕДИНЯЙТЕСЬ К СООБЩЕСТВУ