

MEGA™

Barbie®



GWR35

ADVENTURE DREAMCAMPER™  
AVENTURE EN CAMPING-CAR DE RÊVE

SUPER ABENTEUER-CAMPER | CAMPER DEI SOGNI | AVONTUURLIJKE DROOMCAMPER | CAMPER DE AVENTURAS TRAILER DE AVENTURAS | WYMARZONY KAMPER  
LAKÓKOC SIS KALAND | ПРИКЛЮЧЕНИЯ В ДОМЕ НА КОЛЕСАХ | ONEIREMENO TPOXOCΠITO | BARBIE'NIN MEGA KARAVANI™ | DREAMCAMPER™ مغامرة

# PLAY AS YOU BUILD! JOUER EN CONSTRUISANT!

JUEGA MIENTRAS CONSTRUYES • CONSTRUÇÃO E BRINCADEIRA SIMULTÂNEAS  
GLEICHZEITIG BAUEN UND SPIELEN • СТРОЙ И ИГРАЙ



# CHOOSE WHAT YOU WANT TO BUILD FIRST! CHOISISSEZ CE QUE VOUS VOULEZ CONSTRUIRE EN PREMIER!

¿ELIGE QUÉ QUIERES CONSTRUIR PRIMERO! • ESCOLHA O QUE VOCÊ QUER CONSTRUIR PRIMEIRO! KINDER KÖNNEN AUSSUCHEN, WAS SIE ZUERST BAUEN WOLLEN! • ВЫБЕРИ, ЧТО ТЫ ХОЧЕШЬ СОБРАТЬ СНАЧАЛА!



## Build Construisez

Construye | Constrói  
Bauen | Стройте



## Share | Partagez

Comparte | Partilha  
Teilen | Делитесь

Devices not included | Appareils non inclus | Dispositivos no incluido  
Dispositivos não incluídos | Geräte nicht enthalten | Устройства не входят в комплект

## Play as you build! Jouez en construisant!

Juega mientras construyes!  
Construção e brincadeira simultâneas!  
Gleichzeitig bauen und spielen!  
Строй и играй!



[megaunboxed.com](http://megaunboxed.com)



# CUSTOMIZE YOUR BARBIE FIGURE! PERSONNALISEZ VOTRE FIGURINE BARBIE!

PERSONALIZA TU BARBIE! • PERSONALIZE SUA BARBIE!  
DIE BARBIE-FIGUREN INDIVIDUELL GESTALTEN!  
СДЕЛАЙ СВОЮ ФИГУРКУ БАРБИ УНИКАЛЬНОЙ!



1



2

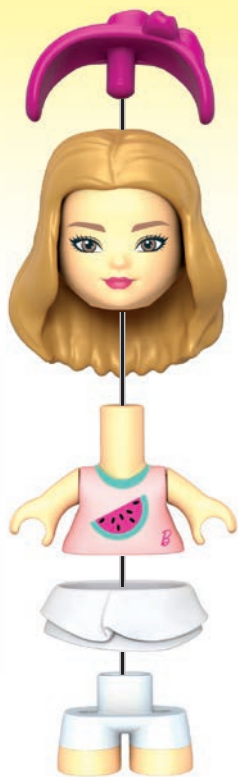

1



2



## LET'S BUILD THE DREAMCAMPER™! CONSTRUISONS LE DREAMCAMPER!

¡CONSTRUYAMOS EL CÁMPER DE BARBIE!  
CONSTRUAMOS O TRAILER DA BARBIE!  
DAS TRAUMWOHNMOBIL BAUEN!  
ДАВАЙ СОБЕРЕМ ВОЛШЕБНЫЙ ДОМ НА КОЛЕСАХ™!





1

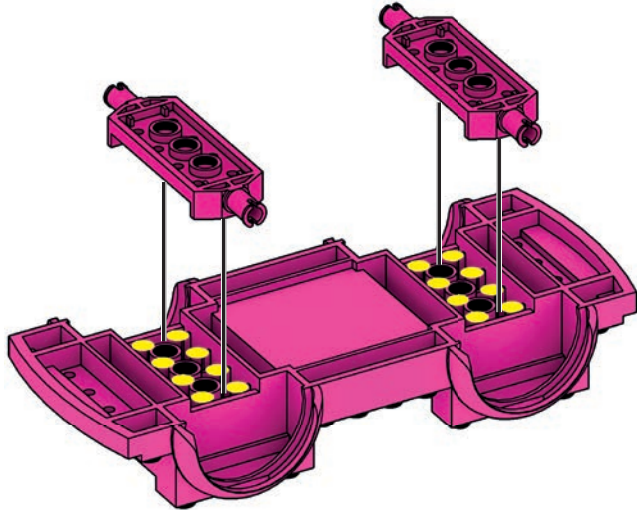
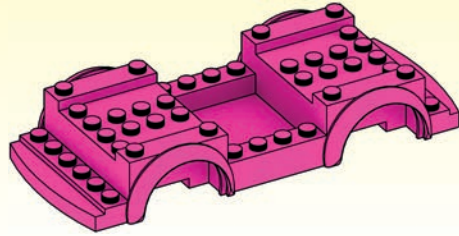
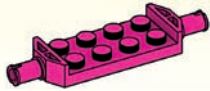
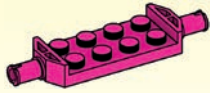

1

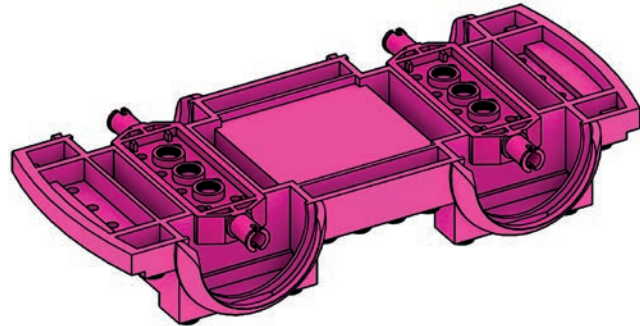

2

2

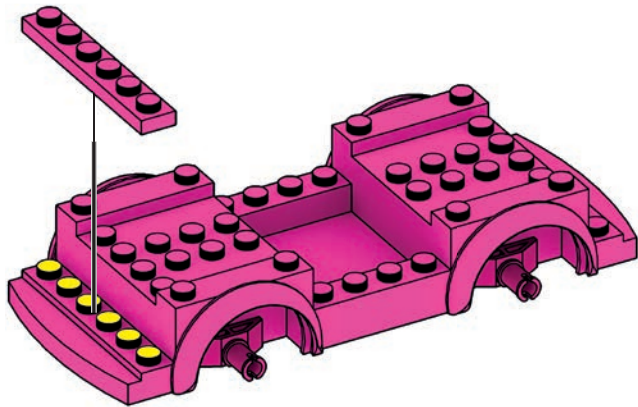
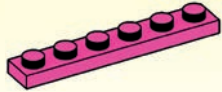

3

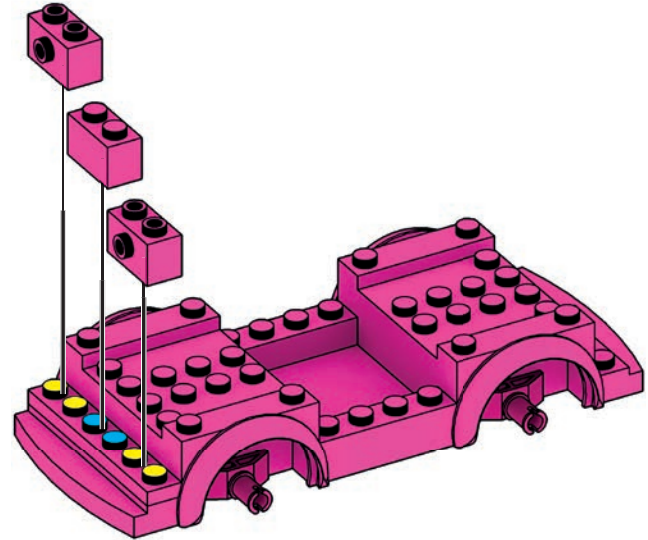

4

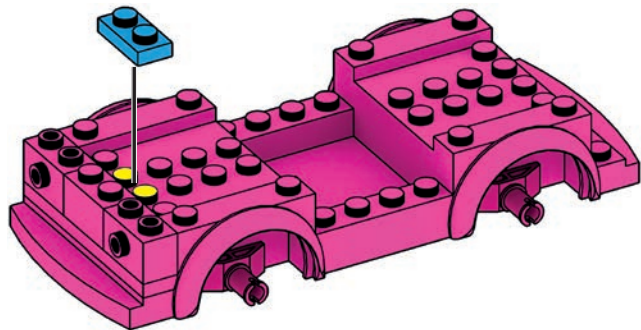

5

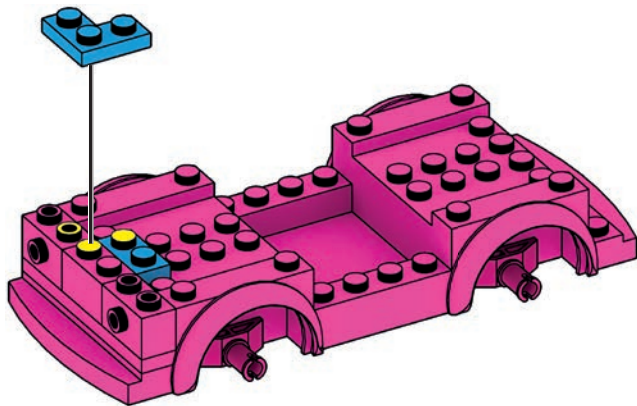



6

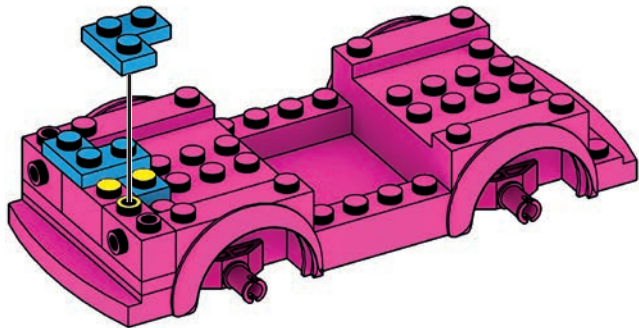

7

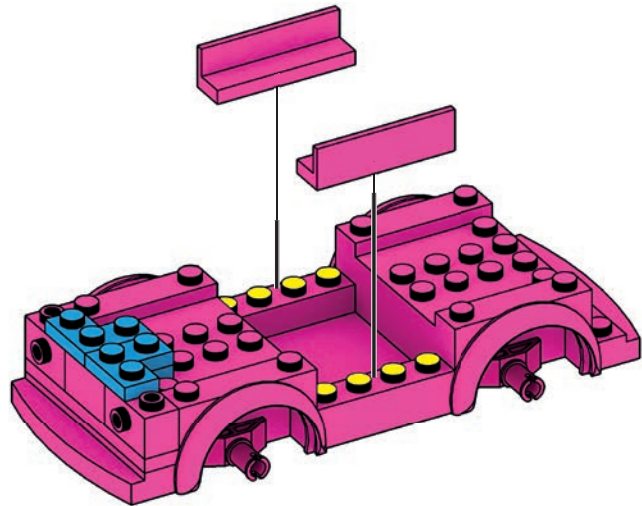
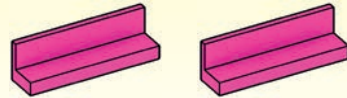

8

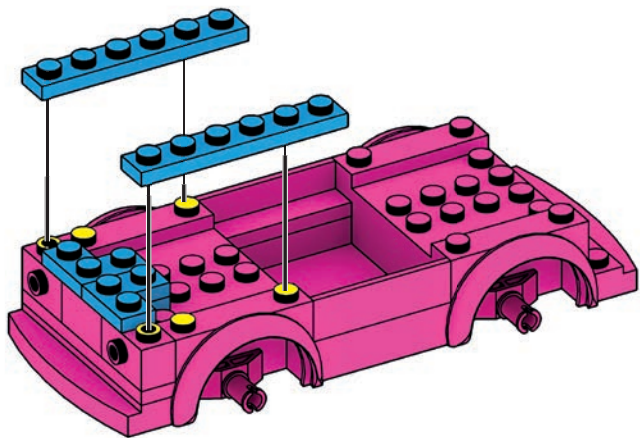
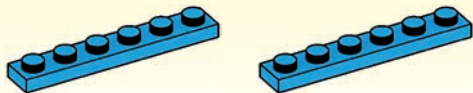

9

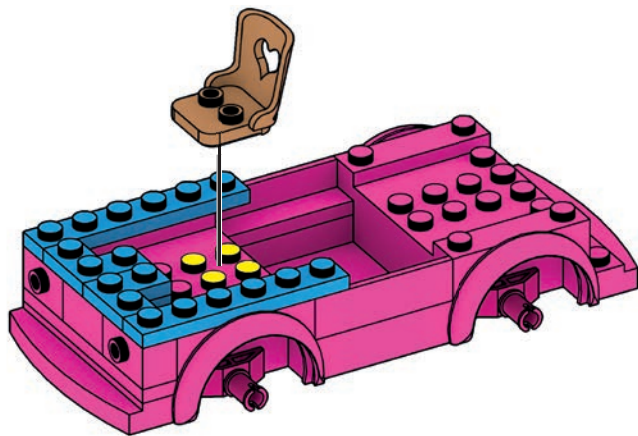

10

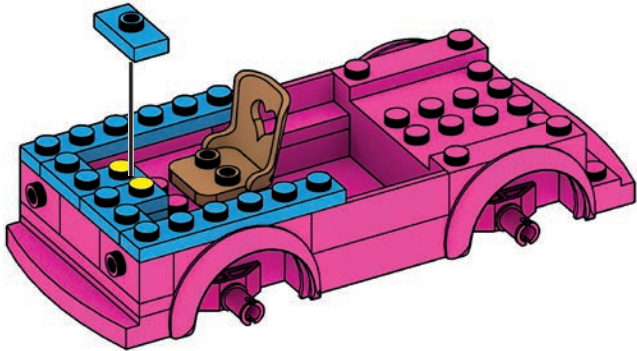

11

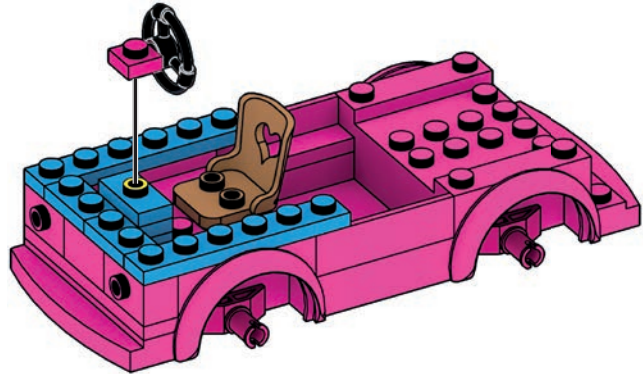
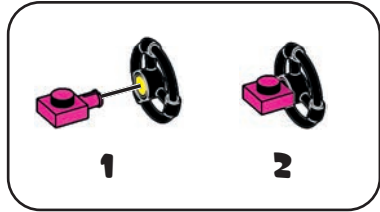

12

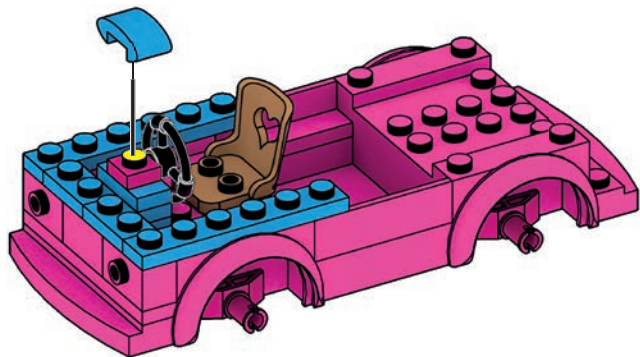

13

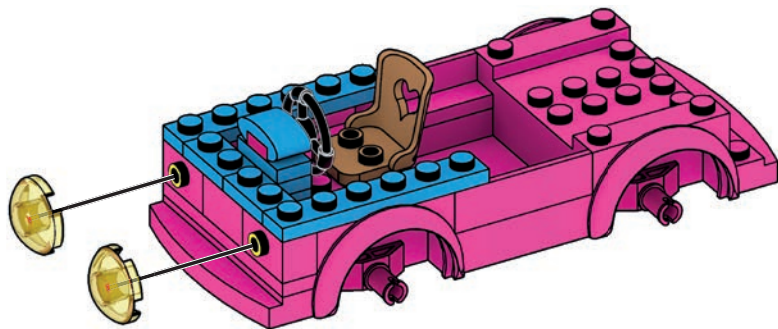

1

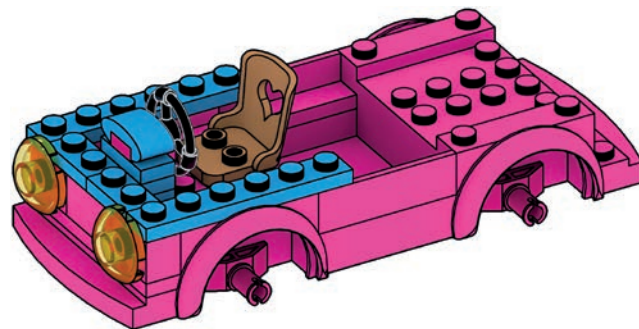

2

14

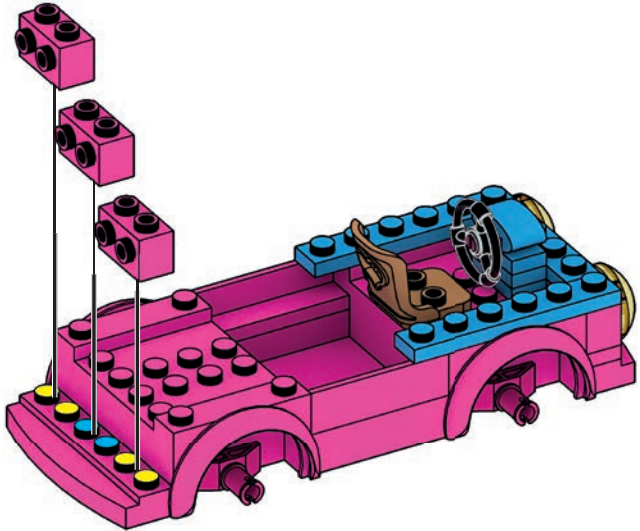

15

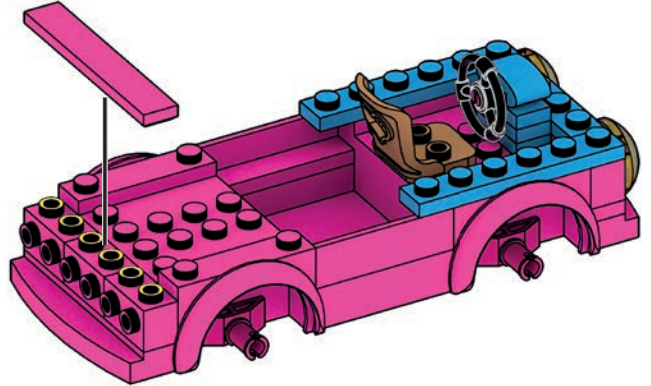

16

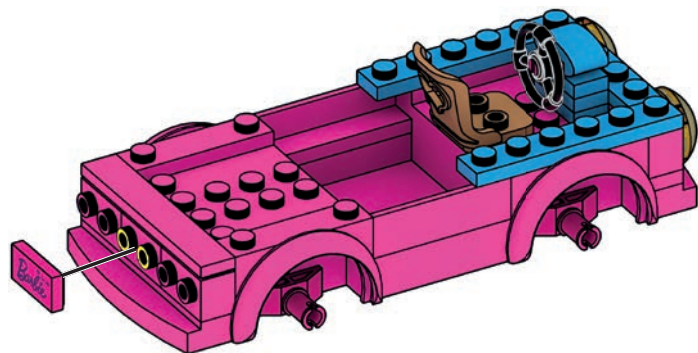

17

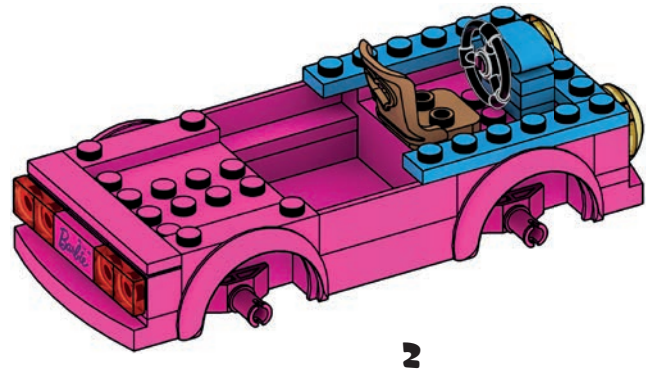
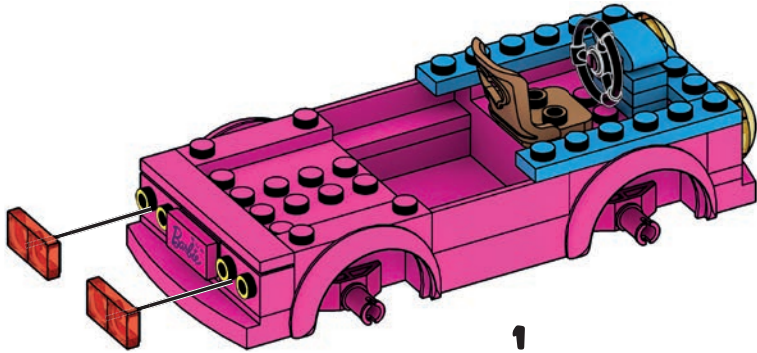
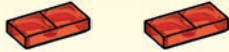

18

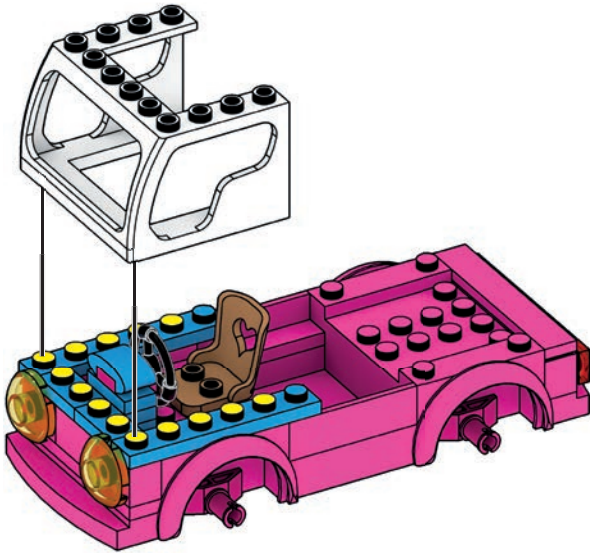
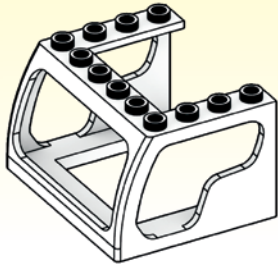

19

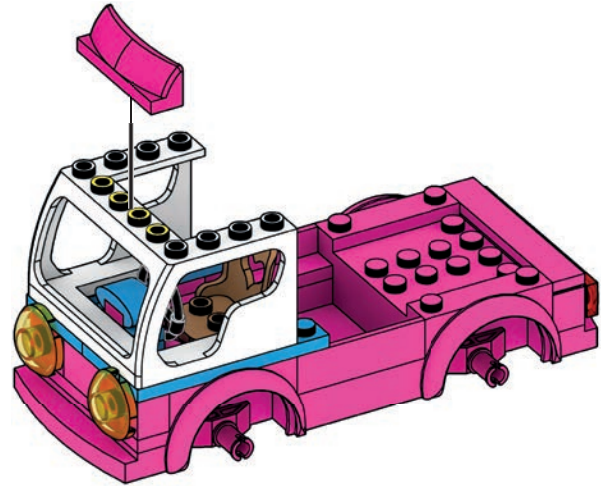
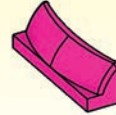



20

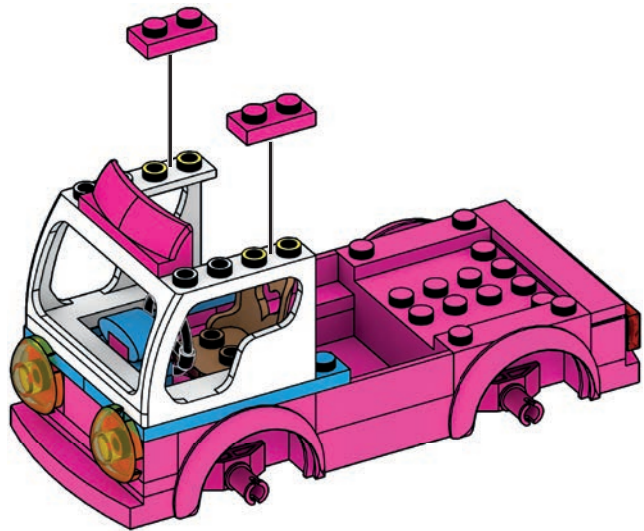
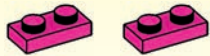

21

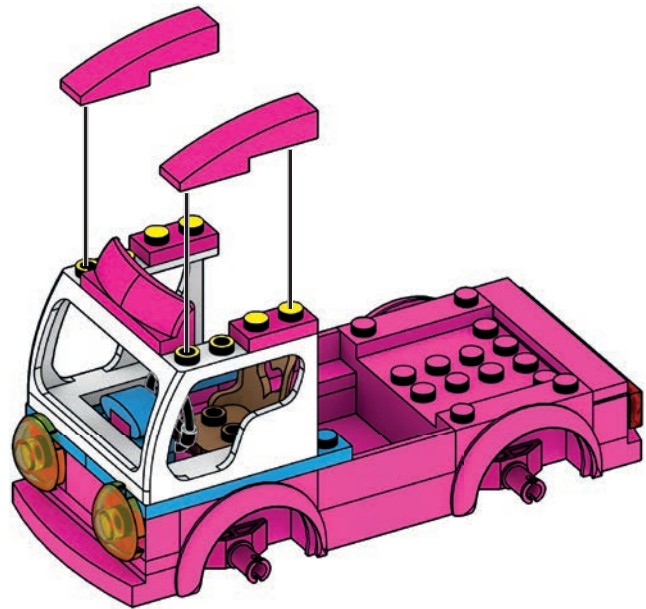
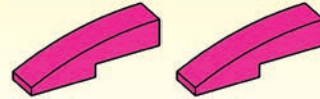

22

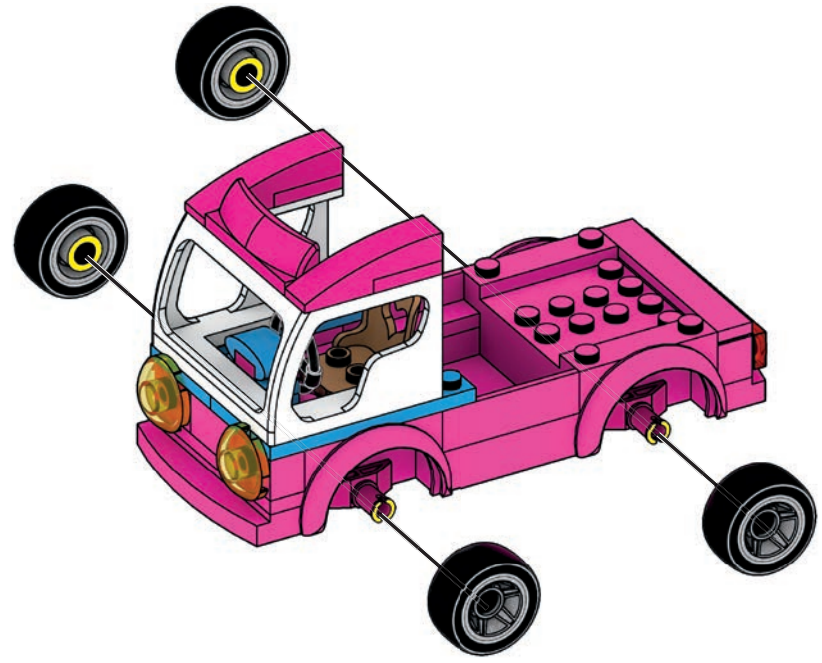
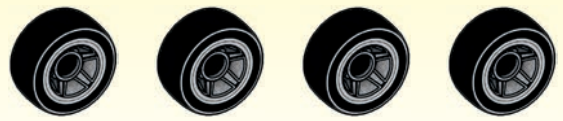

23

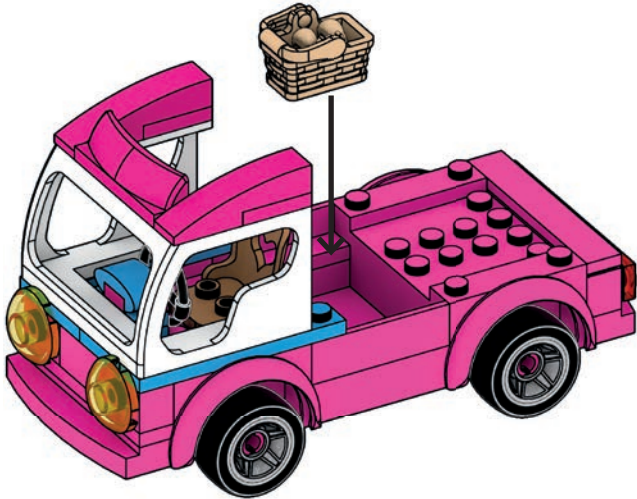
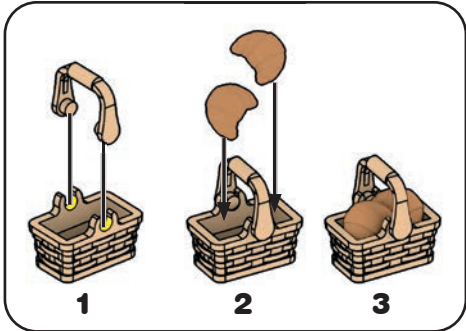

1

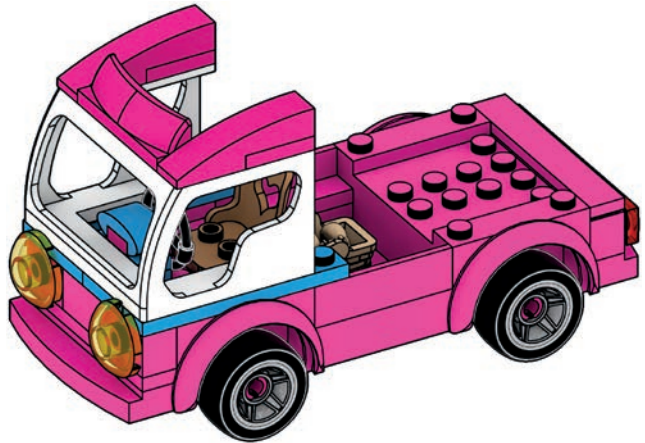

2



# CUSTOMIZE YOUR BARBIE FIGURE! PERSONNALISEZ VOTRE FIGURINE BARBIE!

PERSONALIZA TU BARBIE! • PERSONALIZE SUA BARBIE!  
DIE BARBIE-FIGUREN INDIVIDUELL GESTALTEN!  
СДЕЛАЙ СВОЮ ФИГУРКУ БАРБИ УНИКАЛЬНОЙ!



1



2



24

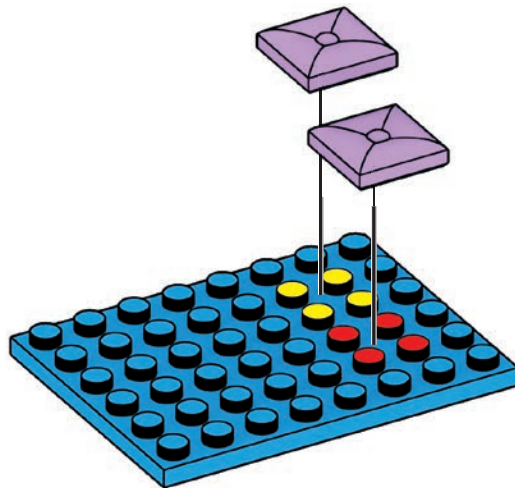
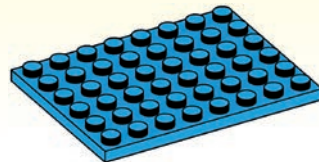

25

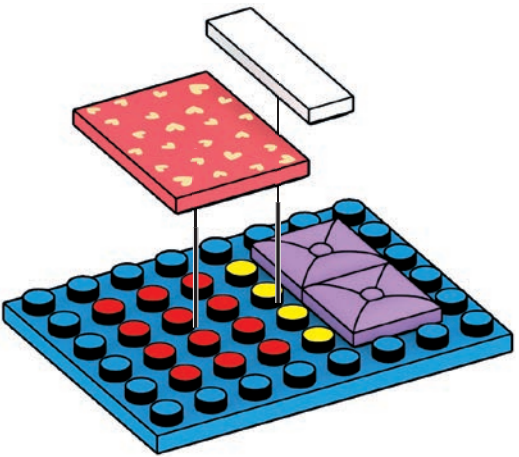

26

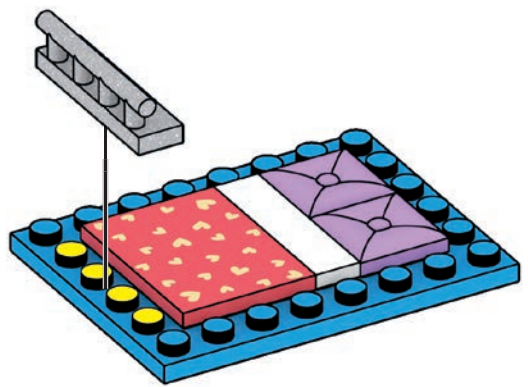
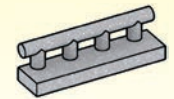

27

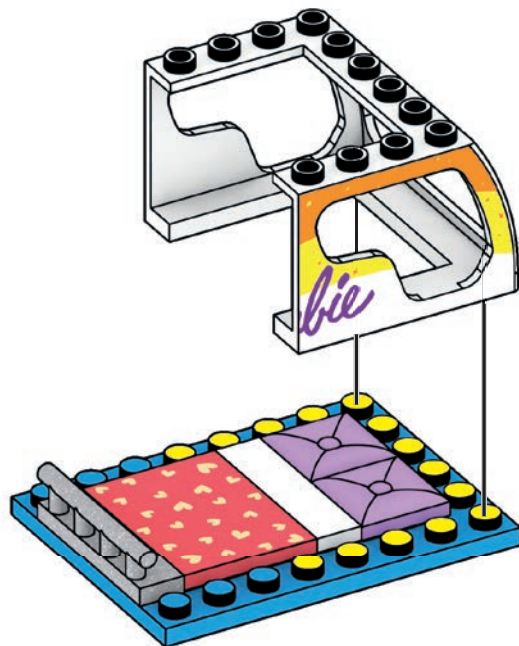
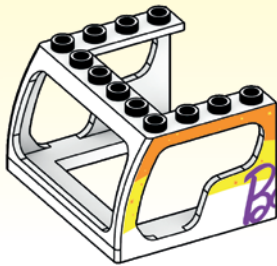

28

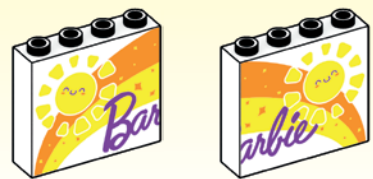

29

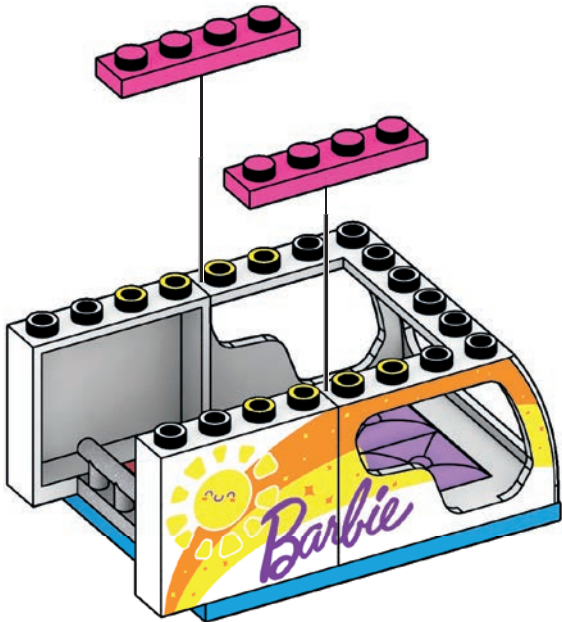
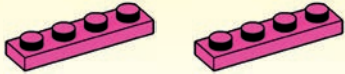

30

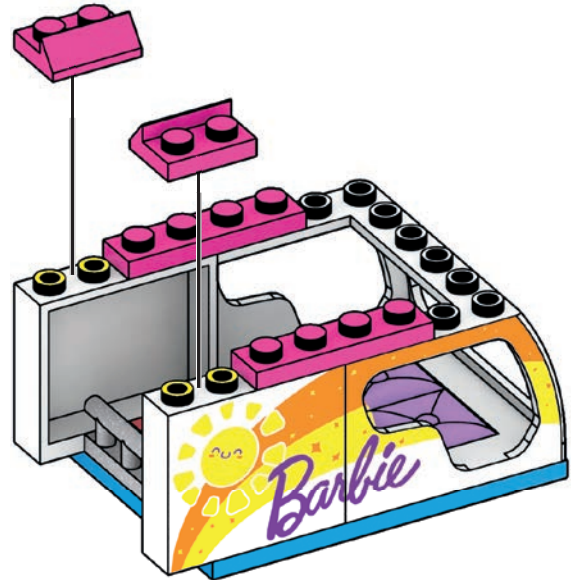
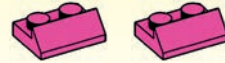

31

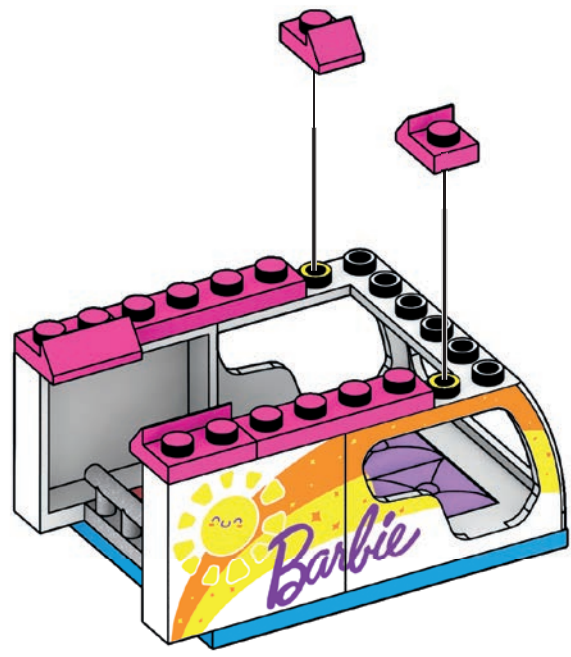
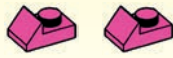

32

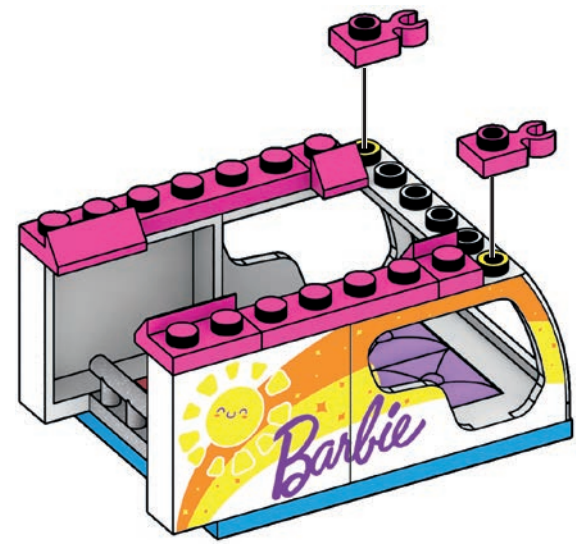



33

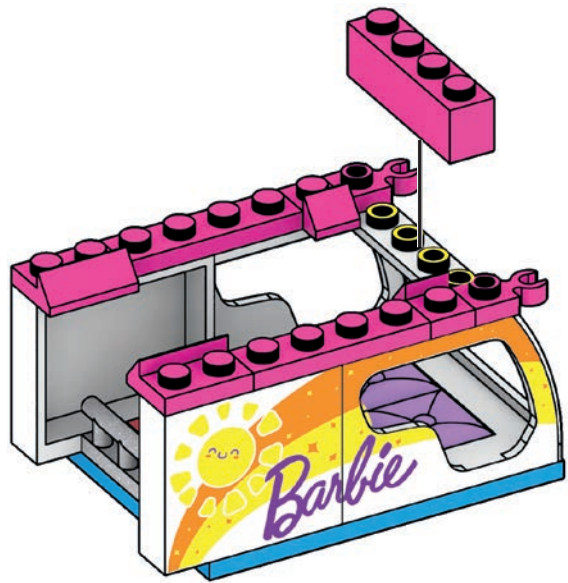
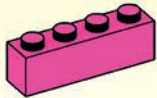

34

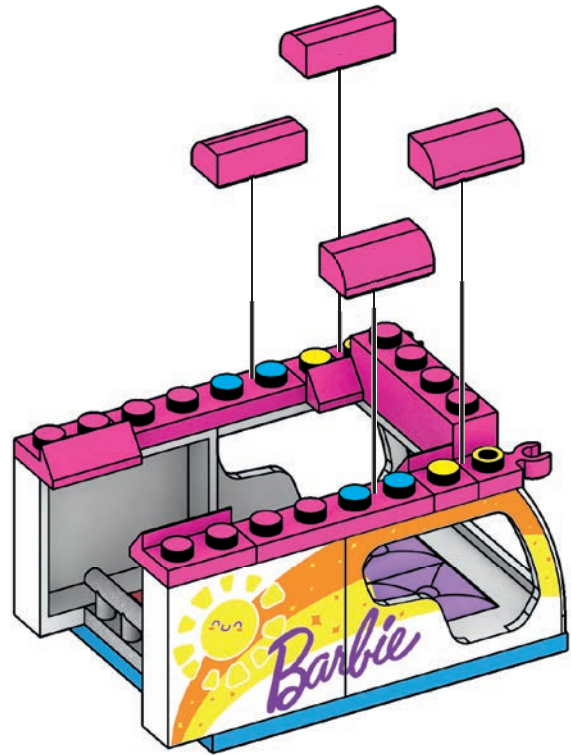
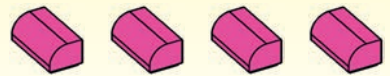

35

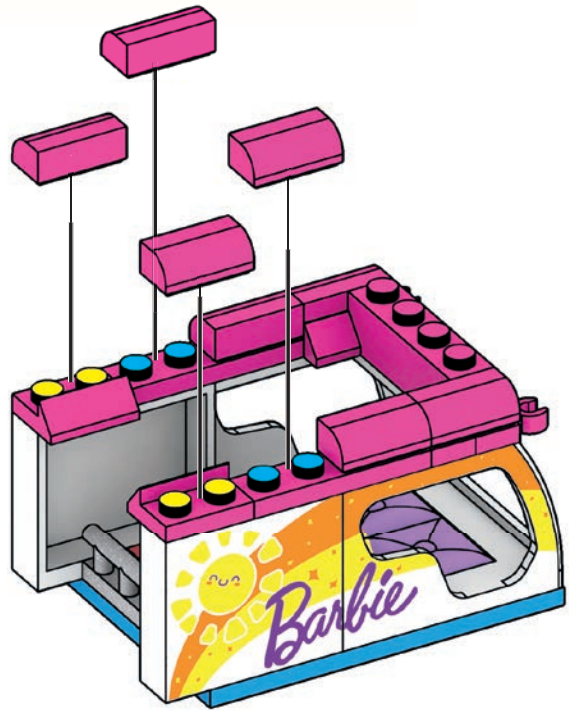
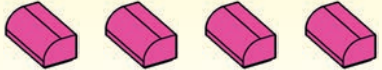

1

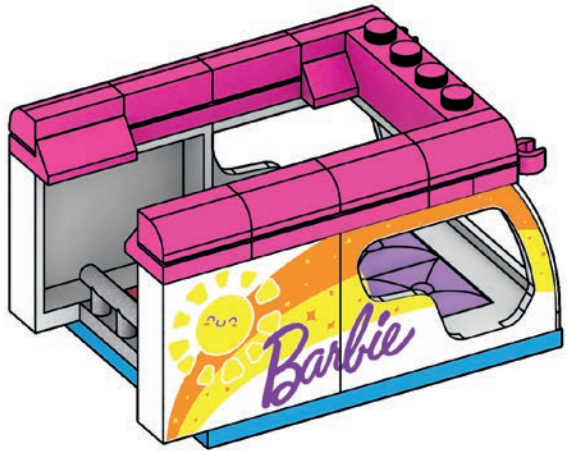

2

36

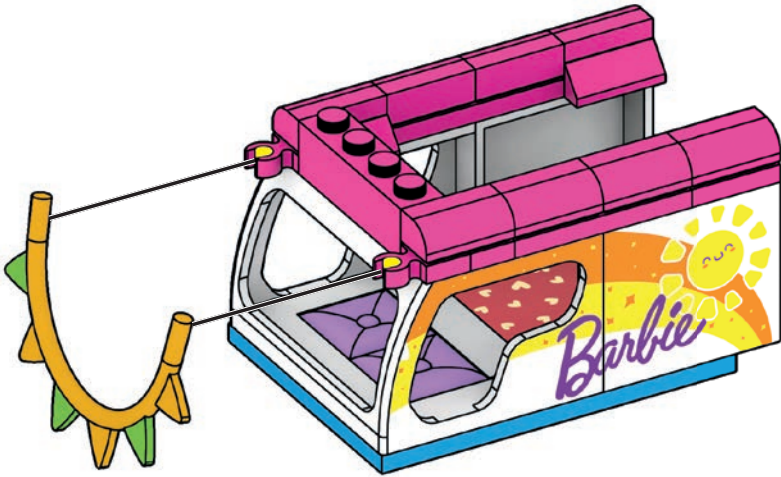
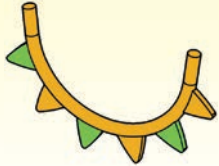

1

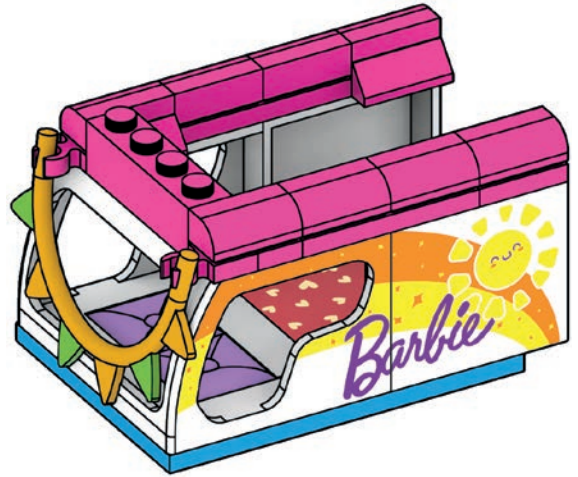

2



1



2

**CUSTOMIZE YOUR  
BARBIE FIGURE!  
PERSONALISEZ  
VOTRE FIGURINE BARBIE!**

PERSONALIZA TU BARBIE! • PERSONALIZE SUA BARBIE!  
DIE BARBIE-FIGUREN INDIVIDUELL GESTALTEN!  
СДЕЛАЙ СВОЮ ФИГУРКУ БАРБИ УНИКАЛЬНОЙ!



38

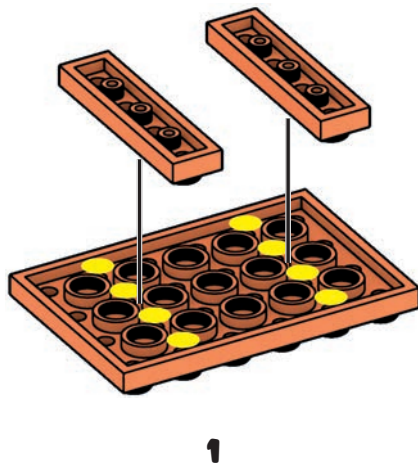
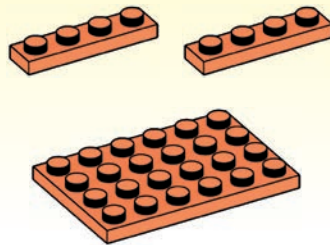

39

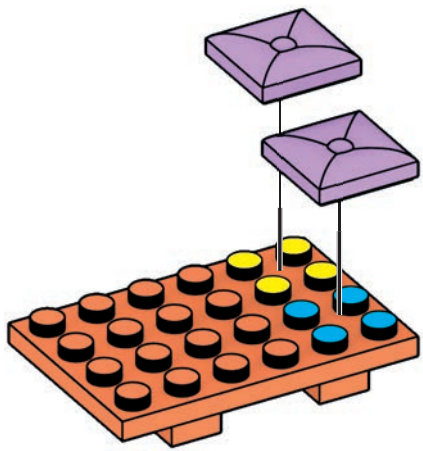
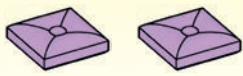

40

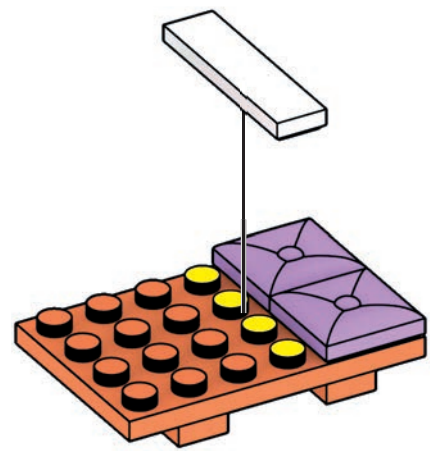

41

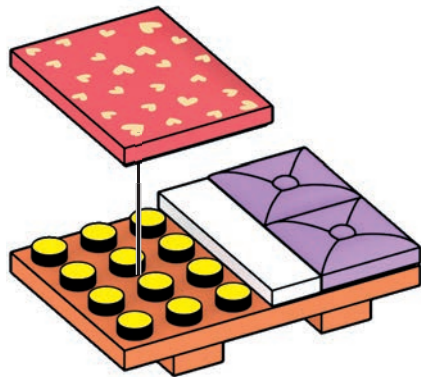

1



2

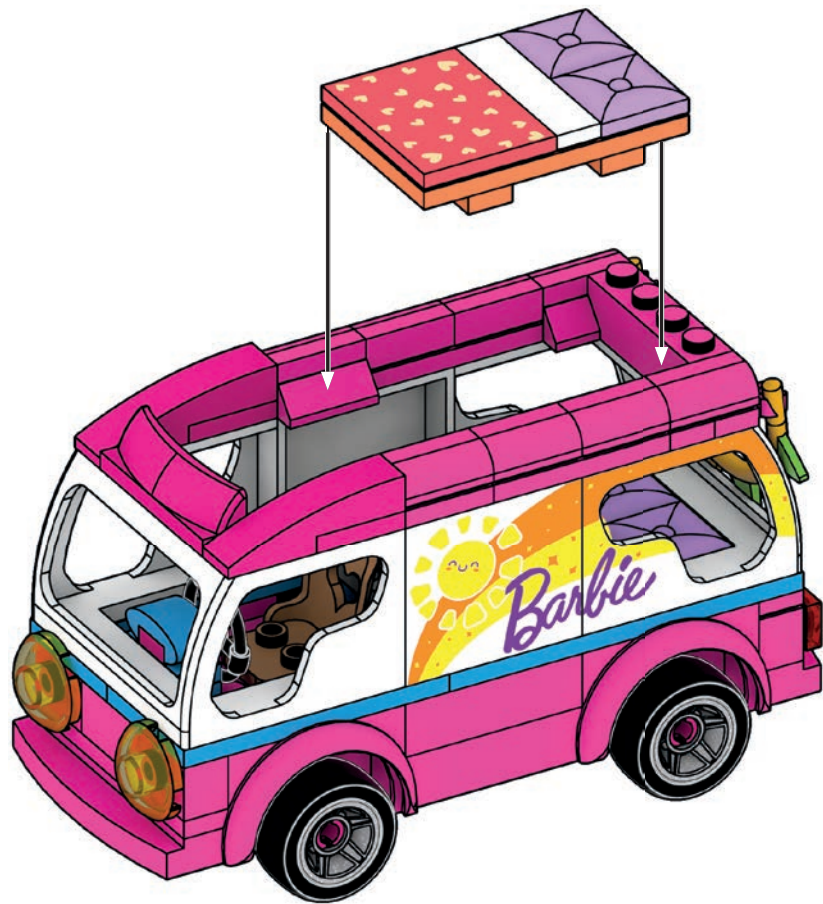



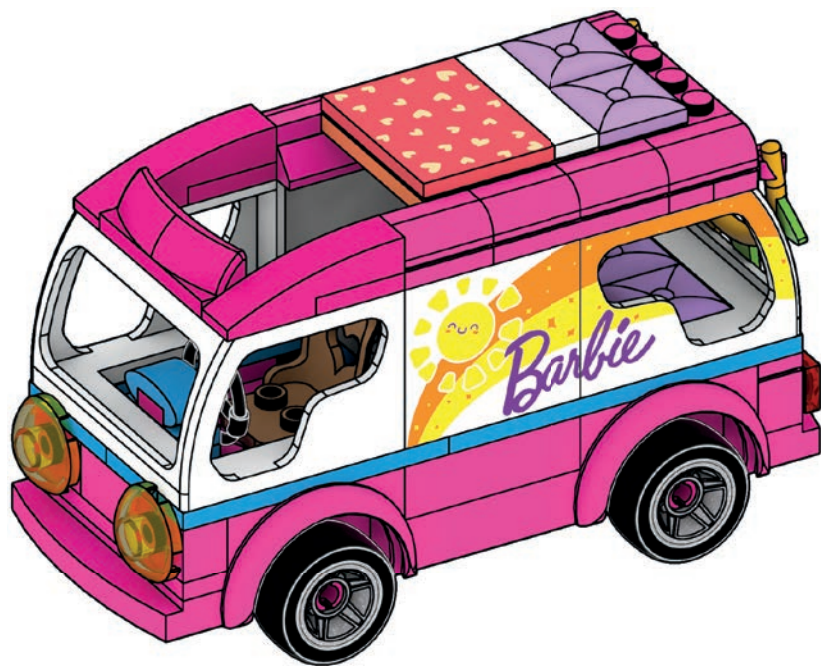

2



# LET'S BUILD A PICNIC! CONSTRUIONS UN PIQUE-NIQUE!

¡CONSTRUYAMOS UN PICNICO! • CONSTRUAMOS UM PIQUENIQUE!  
EIN PICKNICK BAUEN! • ДАВАЙ СОБЕРЕМ МЕСТО ДЛЯ ПИКНИКА!



# CUSTOMIZE YOUR BARBIE FIGURE! PERSONNALISEZ VOTRE FIGURINE BARBIE!

¡PERSONALIZA TU BARBIE! • PERSONALIZE SUA BARBIE!  
DIE BARBIE-FIGUREN INDIVIDUELL GESTALTEN!  
СДЕЛАЙ СВОЮ ФИГУРКУ БАРБИ УНИКАЛЬНОЙ!

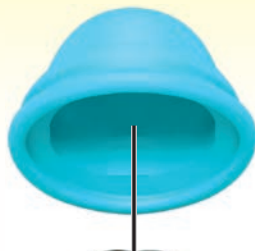

1



2



1



2

43

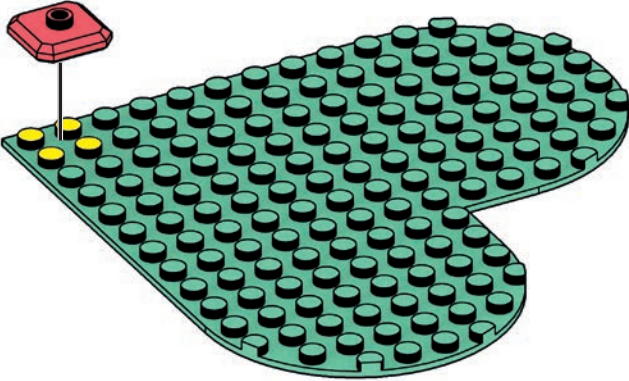
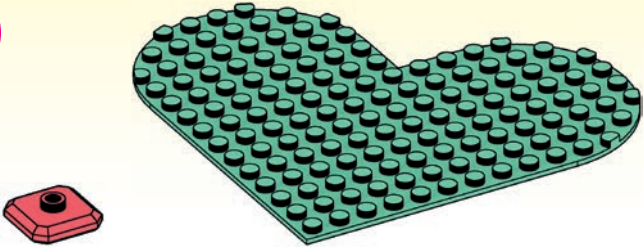

44

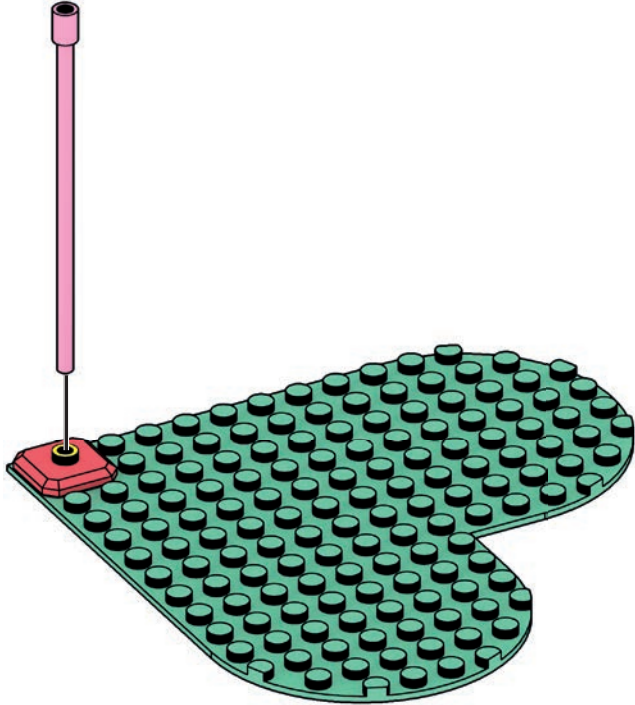
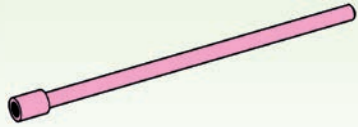

45

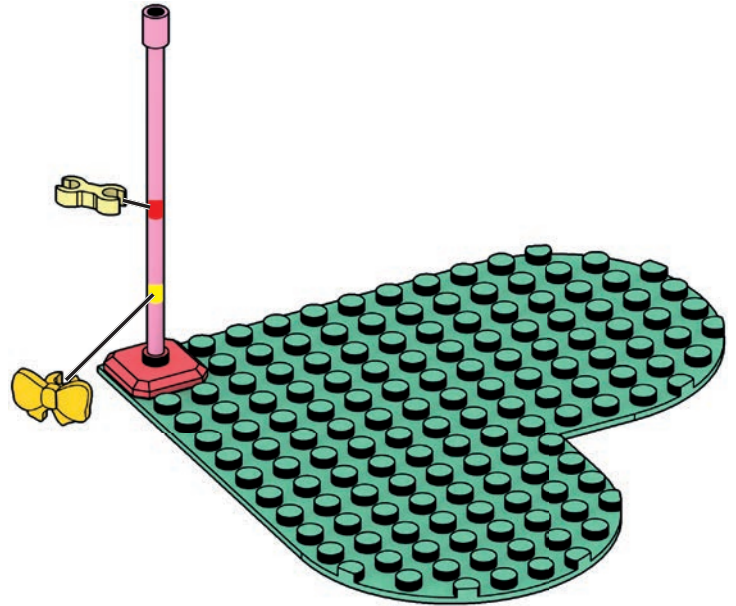

46

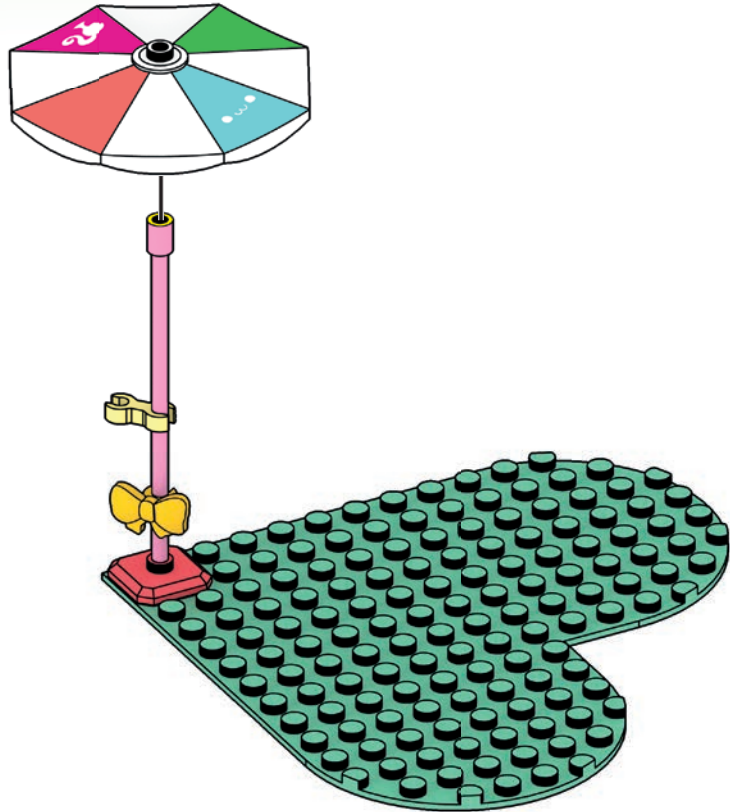
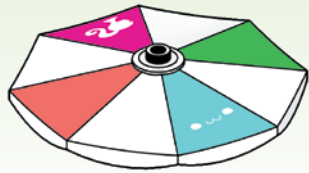

47

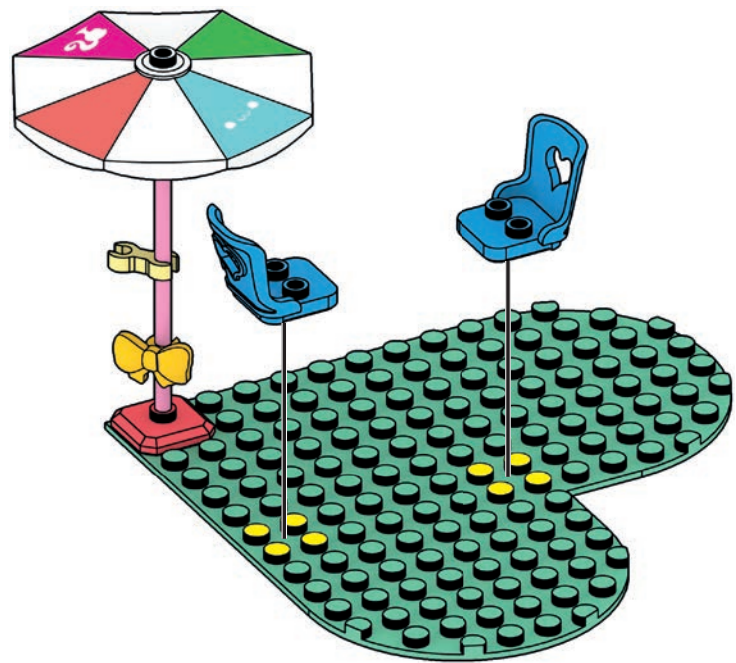
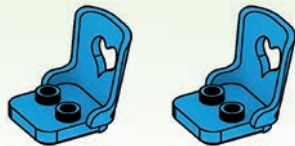

1

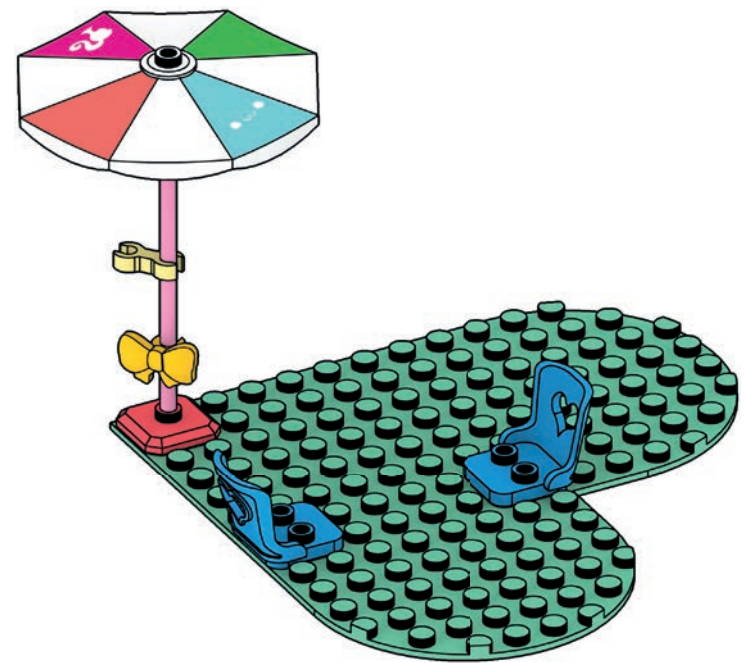

2

48

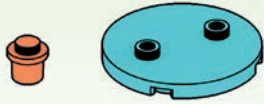

49

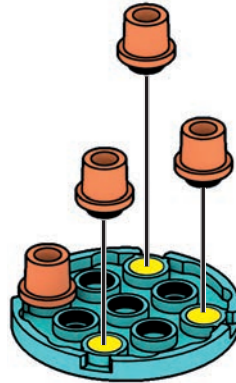

1

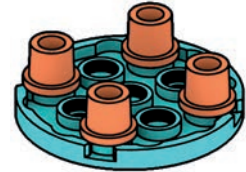

2

50

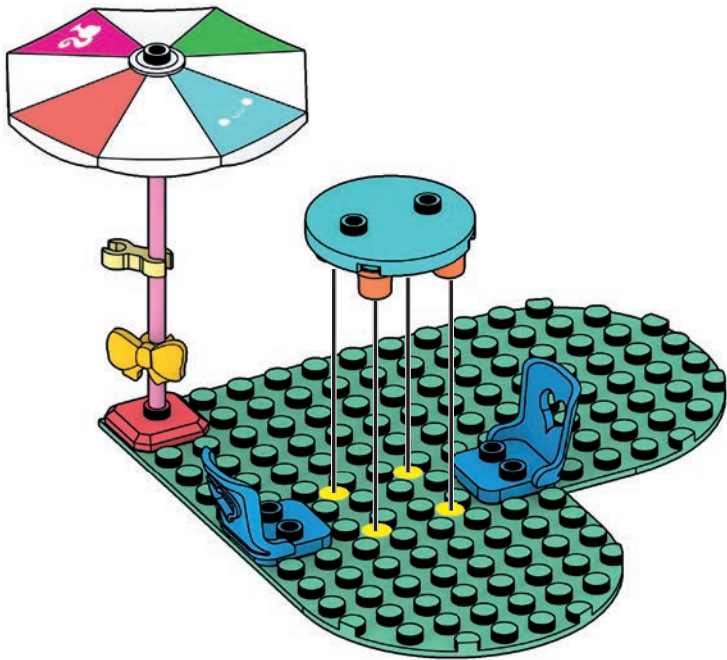

51

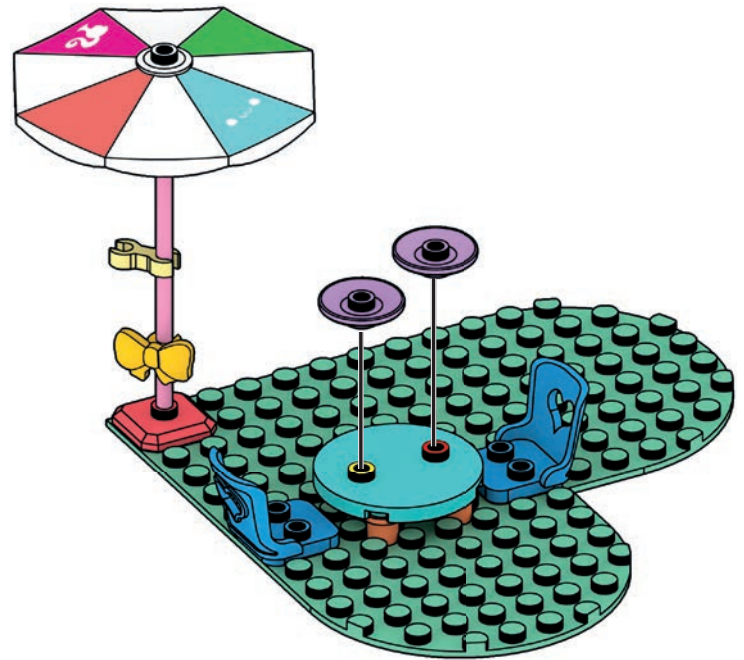



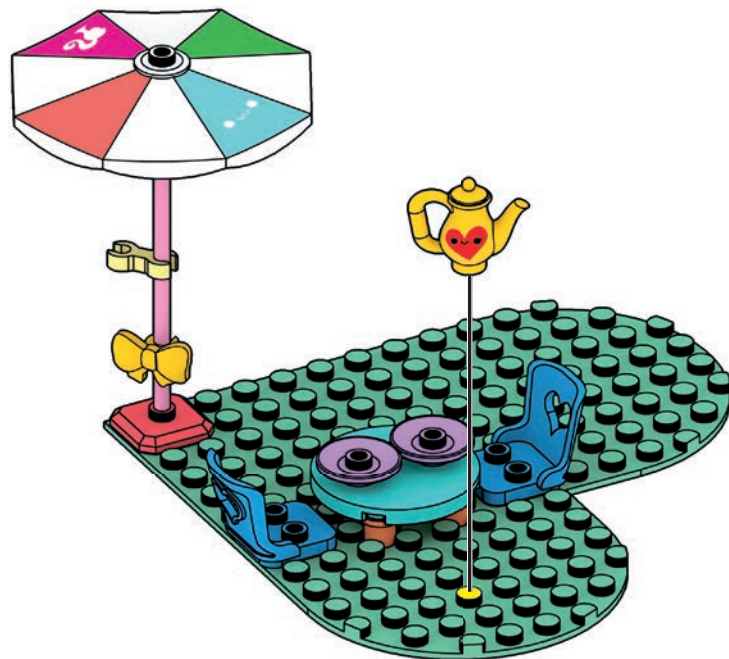

53

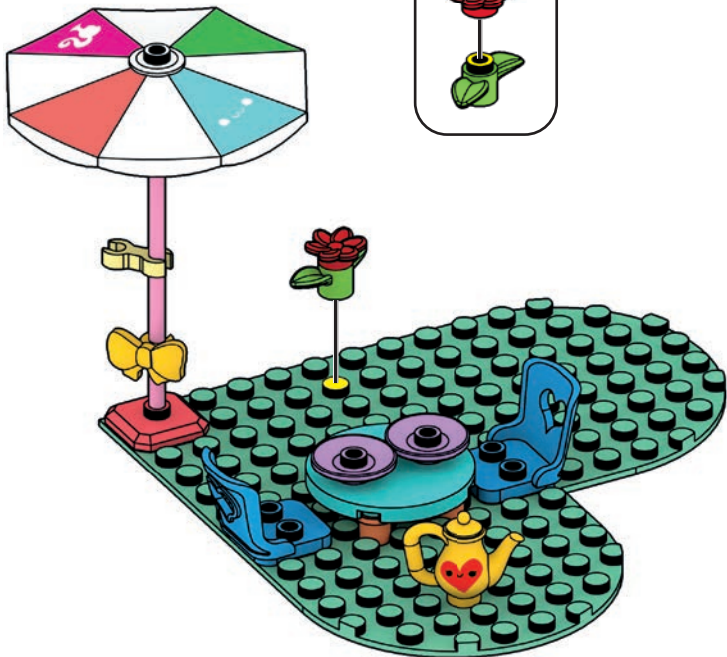

54

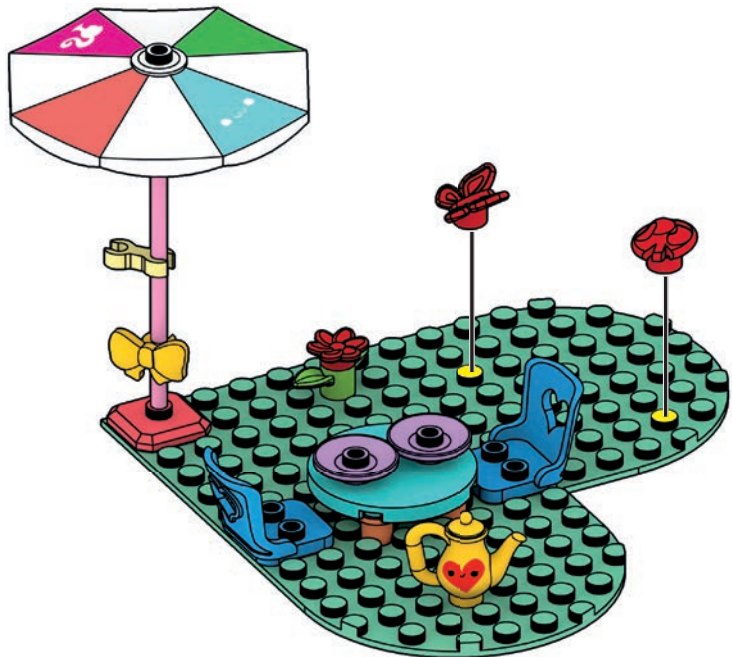

55

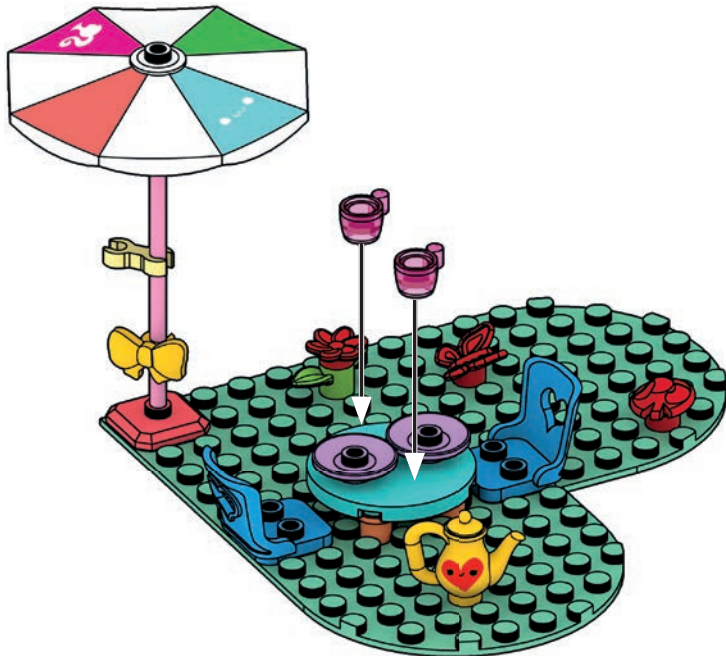
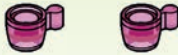

56

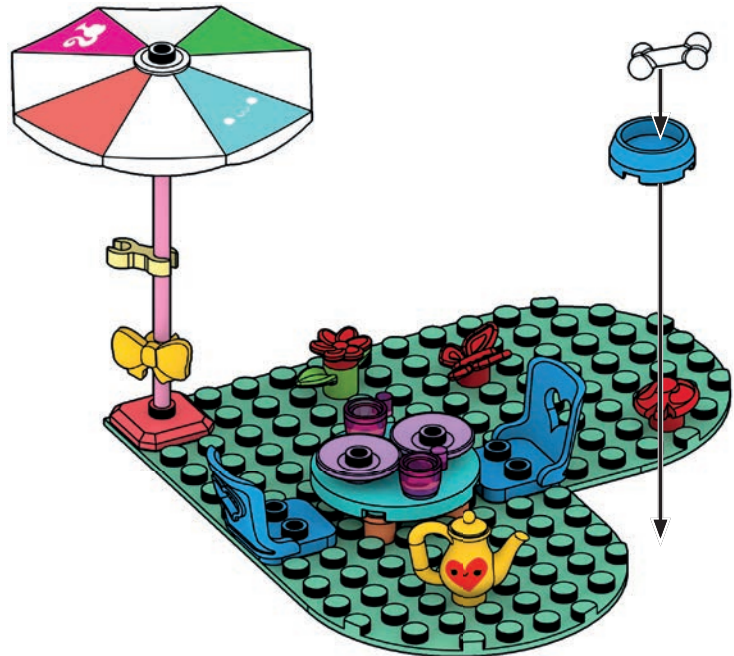















57























# LET'S PLAY! AMUSONS-NOUS!

¡AJUGAR! • A BRINCAR!  
LASS UNS SPIELEN! • НА ИГНАЕМ ИГРУ!











- 4x  AM81164AAD
- 2x  AM79638AUZ
- 2x  AM78800AMR
- 1x  AM18592CS
- 1x  AM80546ATC
- 2x  AM18591GW
- 1x  AM72973E
- 1x  AM75175AMC
- 1x  AM75176AMC
- 1x  AM75174AMC
- 1x  AM73193BYE
- 2x  AM19530GW
- 1x  AM78726HT
- 1x  AM15555GX
- 1x  AS-GWR35-05

- 2x  AM76413X
- 1x  AM07590GX
- 1x  AM09393GX
- 2x  AM09393ATC
- 1x  AM72972GX
- 2x  AM78285ZD
- 2x  AM74414NL
- 1x  AM78500F
- 8x  AM03017GW
- 2x  AM09835GW
- 1x  AM73009RQ
- 4x  AM72956NL
- 2x  AM15484GX
- 3x  AM17502GW
- 1x  AM09013GW

- 2x  AM18601GW
- 1x  AM78194AMR
- 1x  AS-GWR35-11
- 1x  AM78195AMR
- 1x  AS-GWR35-06
- 4x  AS-GWR35-13
- 2x  AM81142GX
- 1x  AM81142VL
- 2x  AM09838E
- 2x  AM09593AAD
- 2x  AM09593GW

- 1x  AM81086ATC
- 2x  AM17521GW
- 1x  AM01847APG
- 1x  AM01087GW
- 2x  AM19323ATC
- 1x  AS-GWR35-02
- 1x  AS-GWR35-07
- 1x  AM77622ASU
- 2x  AS-GWR35-03
- 1x  AM09292GW

- 2x  AM09292GX
- 1x  AM16331GW
- 2x  AM81091ATC
- 1x  AM17055AAD
- 1x  AS-GWR35-12
- 1x  AS-GWR35-04
- 1x  AM76192ASX
- 1x  AM74678GX

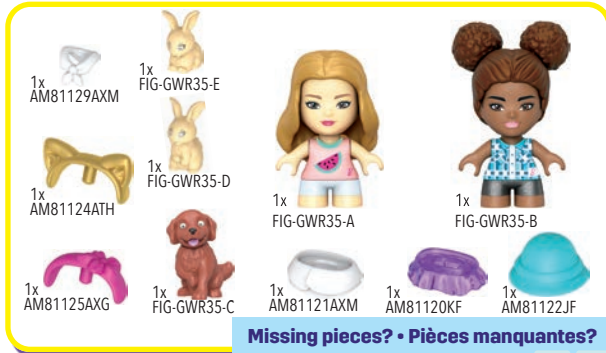
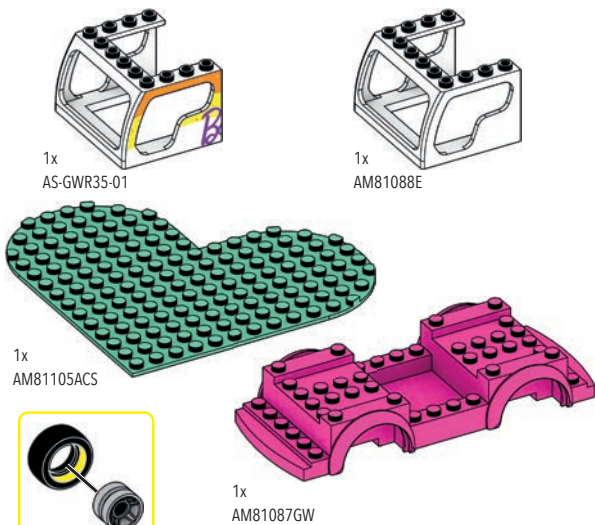

**Missing pieces? • Pièces manquantes?**  
 ¿Partes faltantes? • Perdeu peças?  
 Fehlen Teile? • He хватает деталей?  
[support.megabrands.com](http://support.megabrands.com)

\*HHP86, HHP87, HHP88, HHM01, HHW83 / Set(s) sold separately and subject to availability. / Ensemble(s) vendu(s) séparément. Certains produits peuvent ne pas être commercialisés. / Se vende(n) por separado y está(n) sujeto(s) a disponibilidad. / Conjunto(s) vendido(s) em separado e sujeito(s) à disponibilidade. / Set in vendita separatamente, secondo disponibilità. / Das/Die Set(s) sind separat erhältlich. / Zestawy) sprzedawany(ę) oddzielnie w zależności od dostępności. / Set(s) apart verkrijgbaar en afhankelijk van beschikbaarheid. / Набор(-ы) продаются отдельно, при наличии. / Sæt sælges separat og så længe lager haves. / Seten säljs separat så länge lagret räcker. / Settet/settene selges separat så langt lageret rekker. / Pakkaus/pakkaukset myydään erikseen, saatavuus voi vaihdella. / Το(α) σετ πωλούνται ξεχωριστά και ανάλογα με τη διαθεσιμότητα. / Setler ayrı olarak satılır ve stoklarla sınırlıdır. / Set (sety) se prodává (prodávají) samostatně dle aktuální nabídky. / Súprava/-y sa predáva(jú) samostatne a podľa dostupnosti. / A készlet(ek) külön kapható(k), az elérhetőség változhat. / セット商品は別売りになります。在庫状況は別途ご確認お願いします。 / تباع المجموعة أو المجموعات على حدة وتخضع لتوافرها. / 每套单独发售，按供货情况决定。

Mattel Europa B.V., Gondel 1, 1186 MJ Amstelveen, Nederland. Mattel U.K. Limited, The Porter Building, 1 Brunel Way, Slough SL1 1FQ, UK. Mattel France, Parc de la Cerisaie, 1/3/5 allée des Fleurs, 94260 Fresnes Cedex. N° Cristal 0969 36 99 99 (Numéro non surtaxé) ou www.lesjouetsmattel.fr Mattel Belgium, Trade Mart, Atomiumsquare, Bogota 202 - B 275, 1020 Brussels. Gratis nummer België: 0800 - 16 936 - Gratis nummer Luxemburg: 800 - 22 784 - Gratis nummer Nederland: 0800 - 262 88 35. Deutschland: Mattel GmbH, Solmsstraße 83, D-60486 Frankfurt am Main. Schweiz: Mattel AG, Kirchstrasse 24, CH-3097 Liebefeld. Österreich: Mattel Ges.m.b.H., Campus 21, Liebermannstraße A01 404, A-2345 Brunn/Gebrige. Mattel Italy Srl, Via Turati 4, 20121 Milano, Italy. Servizio assistenza clienti: Customerserv.italia@mattel.com - Numero verde 800 11 37 11. Mattel España, S.A., Aribau 200 pl. 9, 08036 Barcelona. cservicio.spain@mattel.com Tel.: +34 933 06 79 00 http://www.servicio.mattel.com/evs. Mattel East Asia Ltd., Room 503-09, North Tower, World Finance Centre, Harbour City, Tsimshatsui, HK, China. Tel.: (852) 3185-6500. Dimport & Diedarkan Oleh: Mattel Continental Asia Sdn Bhd. Level 19, Tower 3, Avenue 7, No. 8 Jalan Kerinci, Bangsar South, 59200 Kuala Lumpur, Malaysia. Mattel South Africa (PTY) Ltd, Office 10213, 30 Melrose Boulevard, Johannesburg 2196. Distributor: Mattel Poland Sp. z o.o., Warsaw Trade Tower 34 p., ul. Chłodna 51, 00-867 Warszawa. Mattel Australia Pty Ltd., 658 Church St., Richmond, Victoria, 3121. Consumer Advisory Service - 1300 135 312. Mattel AEBE, Εθνόγυο Μακαρίου 1, Κτηριο Κ-2, ΤΚ 17561, Πόλις Οφθλο. Mattel Oyuncakçılık Tic. Ltd. Şti. İçerenköy Mah., Umut Sok. No:10-12 Quick Tower Kat:1/5 34752 Ataşehir İstanbul Tel: 0216 570 75 00. Импортёр/Уполномоченная организация: ООО "МАТТЕЛ" Российская Федерация, 105120 Москва, 2-й Савромитинский переулок, 1; +7 495 287 79 39. Mattel Czech Republic s.r.o., The Forum, Václavské nám. 19, 11000 Praha1. Mattel, 333 Continental Boulevard, El Segundo, CA 90245, USA. Consumer Services: 1-800-465-MEGA (6342), Mattel Canada Inc., Mississauga, Ontario L5R 3W2. Consumer Services: You may call us free at/ Composez sans frais le 1-800-524-8697. Importado y distribuido por Mattel de México, S.A. de C.V., Miguel de Cervantes Saavedra No. 193, Pisos 10 y 11, Col. Granada, Alkalidia Miguel Hidalgo, C.P. 11520, México, Ciudad de México. R.F.C. MME-920701-NB3. Tels.: 59-05-51-00 Ext. 5206 6 01-800-463-59-89. Mattel Chile, S.A., Avenida Américo Vespucio 501-B, Quilicura, Santiago. Tel.: 1230-020-6213. Calle al consumidor Venezuela: Tel: 0-800-100-9123. Mattel Argentina, S.A., Av. Libertador 1000, Piso 11 - Oficinas 109 y 111, Vicente López - Prov. Buenos Aires. Tel.: 0800-666-3373. Mattel Colombia, S.A., Calle 12347-07 P5, Bogotá. Tel.: 01800-710-2069. Mattel Perú, S.A., Av. Juan de Arona 8 151, Centro Empresarial Juan de Arona, Torre C, Piso 7, Oficina 704, San Isidro, Lima 27, Perú. RUC: 20425853865. Reg. Importador: 02350-12-JUE-DIGESA. Tel.: 0800-54744. E-mail Latinoamérica: servicio.clientes@mattel.com. Mattel do Brasil Ltda.: CNPJ: 54.558.002/0001-20 - Rua Verbo Divino, 1488 - 2ª. Andar - 04719-904 - Chácara Santo Antônio - São Paulo - SP - Brasil. Serviço de Atendimento ao Consumidor: fone 0800 575 0780. E-mail: sac.mattelobrazil@mattel.com



\*HHW83



\*HHP87



\*HHP86



\*HHP88



\*HHM01

**ATTENTION : DANGER**  
D'ÉTOUFFEMENT. - PRÉSENCE DE PETITS  
ÉLÉMENTS. NE CONVIENT PAS AUX ENFANTS DE  
MOINS DE 3 ANS.

**ATENÇÃO!** NÃO INDICADO / NÃO  
RECOMENDÁVEL PARA CRIANÇAS MENORES DE 3  
(TRÊS) ANOS POR CONTER PARTE(S) PEQUENA(S)  
QUE PODE(M) SER ENGOLIDA(S) OU ASPIRADA(S)  
PODENDO PROVOCAR ASFIXIA.

警告:  
のどにつまる危険 小さな部品が含まれています  
3歳以下の子供には与えないで下さい。

**警告!**  
不适合3岁以下儿童使用。  
内含小零件。

**⚠ WARNING : CHOKING HAZARD. - Small parts.**  
Not for children under 3 years.  
**ADVERTENCIA : PELIGRO DE ATRAGANTAMIENTO.** Juguete no recomendado  
para menores de 3 años, porque contiene piezas pequeñas que podrían  
provocar asfixia en caso de ser ingeridas o inhaladas por el/la niño/a.

**AVVERTENZA :** Contiene pezzi di piccole dimensioni.  
ACHTUNG: Kleine Teile.  
OSTRZEŻENIE: Małe części. Niebezpieczeństwo zadławienia.  
WAARSCHUWING: Kleine onderdelen.  
ΠΡΕΔΠΡΕΨΕΔΗΜΕ: Μελкие детали.  
ADVARSEL: Indeholder små dele.  
VARNING: Smådelar  
ADVARSEL: Små deler  
VAROITUS: Pieniä osia  
ΠΡΟΨΟΧΗ: Περιλαμβάνονται μικρά κομμάτια.



UYARI: Küçük parçalar.  
UPOZORNĚNÍ: Malé díly  
UPOZORNENIE: Malé časti  
FIGYELMEZTETÉS: Kis alkatrészek.

تحتوي:  
غير مناسبة للأطفال دون 36 شهراً - قطع صغيرة.

# DISCOVER, DELIGHT AND DREAM WITH MEGA™ BARBIE® COLOR REVEAL! UN MONDE DE DÉCOUVERTES, DE PLAISIRS ET DE RÊVES VOUS ATTEND AVEC BARBIE® COLOR REVEAL



¡DESCUBRE, DISFRUTA Y SUEÑA CON BARBIE® COLOR REVEAL DE MEGA™!  
DESCUBRA, SONHE E DELICIE-SE COM A BARBIE® COLOR REVEAL DA MEGA™  
ENTDECKEN, FREUEN UND TRÄUMEN MIT MEGA BARBIE COLOR REVEAL!  
ОТКРЫВАЙТЕ НОВЫЙ МИР, РАДУЙТЕСЬ И МЕЧТАЙТЕ С НАБОРОМ MEGA™ BARBIE® COLOR REVEAL!

BARBIE® and associated trademarks and trade dress are owned  
by, and used under license from Mattel. ©2022 Mattel.

©2022 MEGA Brands &™ MEGA Brands.

Printed in China / Imprimé en Chine

A0-GWR35-02A

Mattel Canada Inc. Mississauga, Ontario L5R 3W2.  
MADE IN CHINA. FABRIQUÉ EN CHINE. FABRICADO NA CHINA. HECHO EN CHINA.  
ИЗГОТОВЛЕНО В КИТАЕ. ÇIN'DE ÜRETİLMİŞTİR. صنع في الصين



1186 MJ, 1, NL

