

MEGA™

POKÉMON™



HRL52

QUAXLY AND PARAS'S SEA SPLASH
LE PLONGEON DE COIFFETON ET PARAS

EL CHAPUZÓN MARINO DE QUAXLY Y PARAS / DIVERSÃO AQUÁTICA DO QUAXLY E PARAS
KWAKS UND PARAS WASSERSPASS / МОРСКИЕ ПРИКЛЮЧЕНИЯ QUAXLY И PARAS



Build Construisez

Construye | Constrói
Bauen | Стройте



Share Partagez

Comparte
Partilha
Teilen
Делитесь



Device not included | Appareil non inclus
Dispositivo no incluído | Dispositivo não incluído
Gerät nicht enthalten | Устройство не входит в комплект



megaunboxed.com



1



1x



1x

2



1x

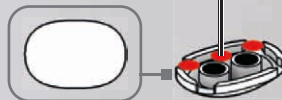

3



1x



4



1x



1



2

5



1x



1x

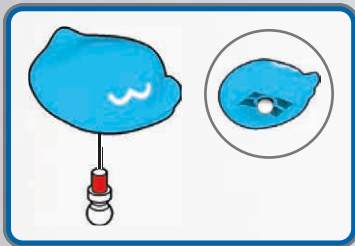

1



2

6



2x

1x



7



2x

2x

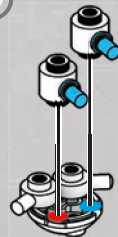

8



1x



9



1x



1



2

10



2x

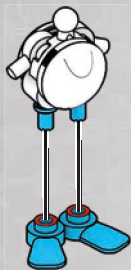

11



2x

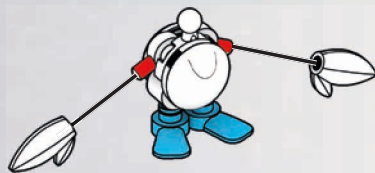

1



2

12



1x

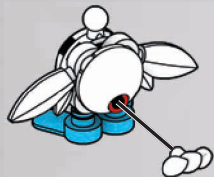

1



2

13



1



2



14



3x 1x

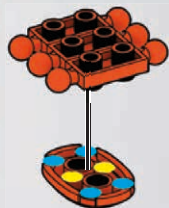

15



1x

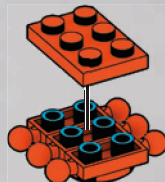

16



1x



1x



1x

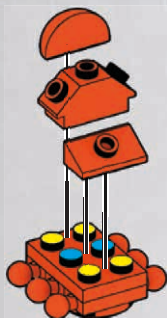

17



2x

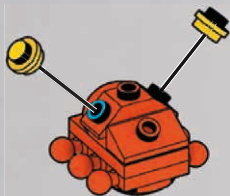

18



2x

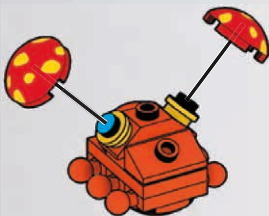

1



2

19



2x



2x



2x



2x



4x



4x



2x

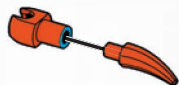

1



2

x4

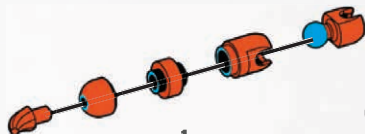

1



2



3

x2

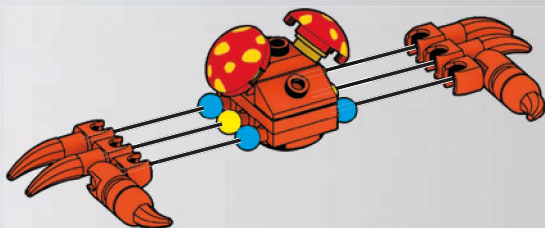

20



1x

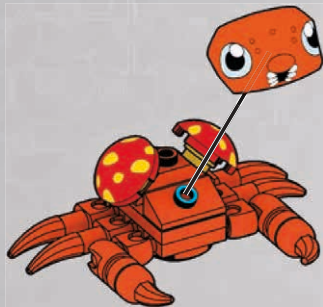

1

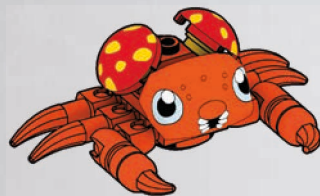

2

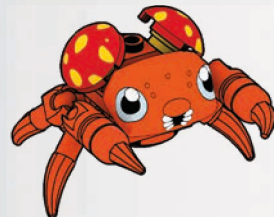

3

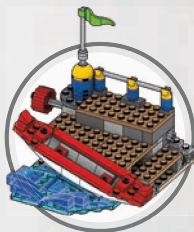

21



3x

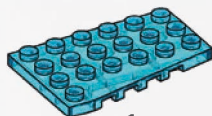

1x



1x

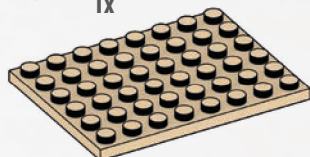

1x

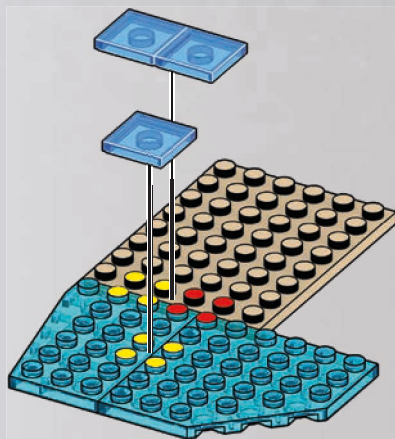

22



23

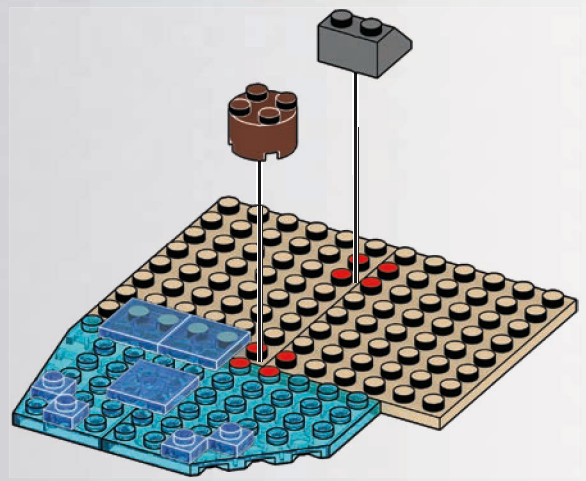
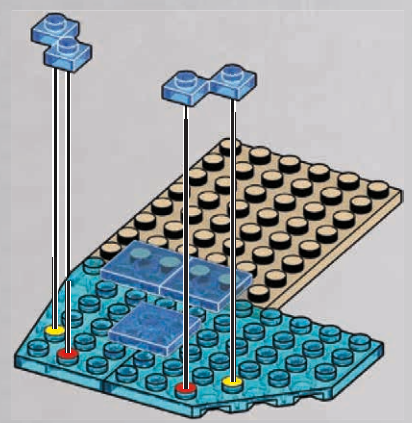
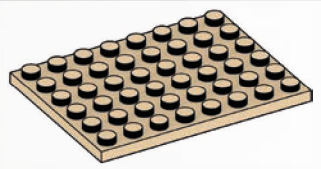
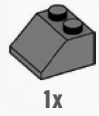

24



2x

2x

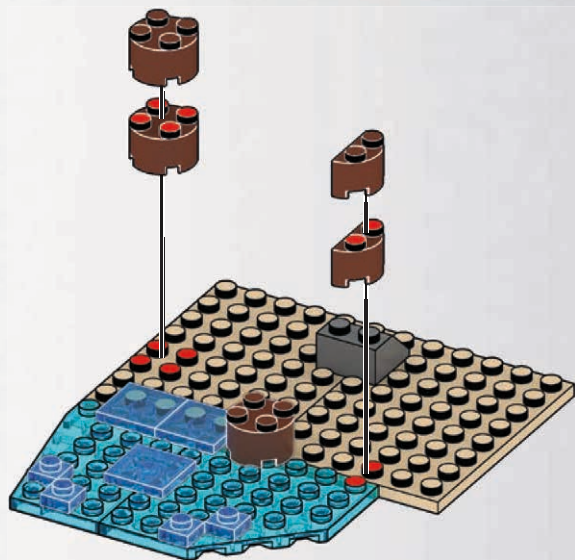

25



2x

2x

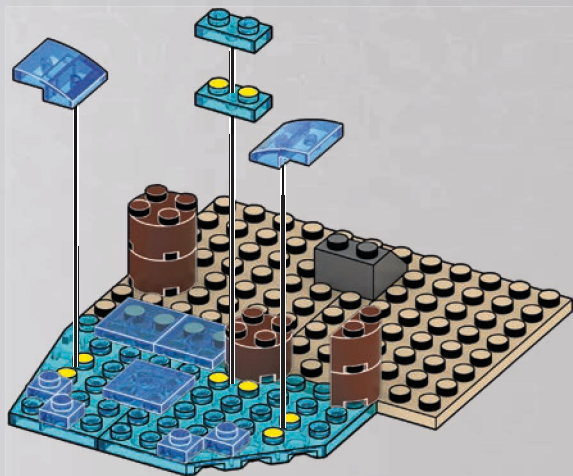

26



4x

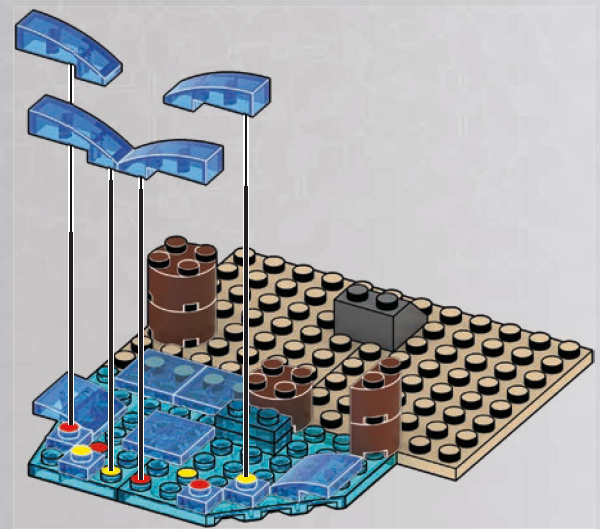

1

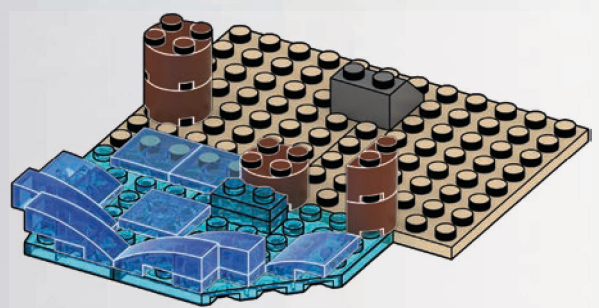

2

27

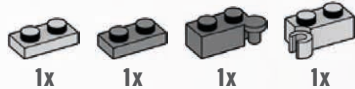

1x

1x

1x

1x

28

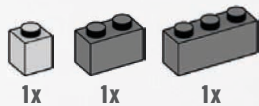

1x

1x

1x

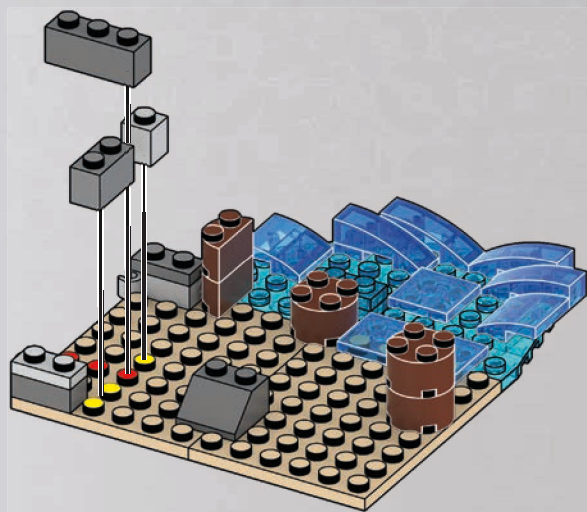
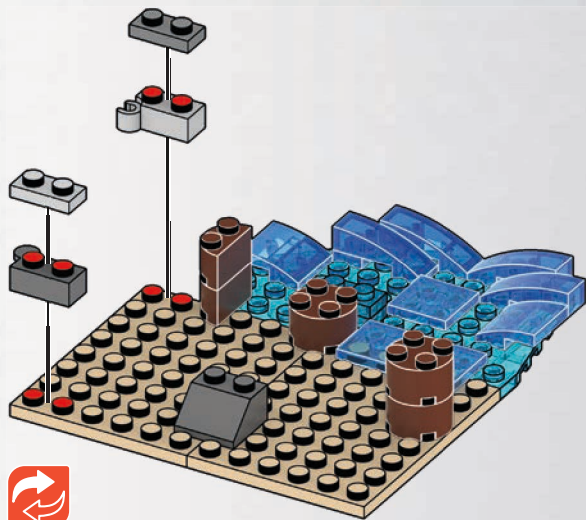

29



1x

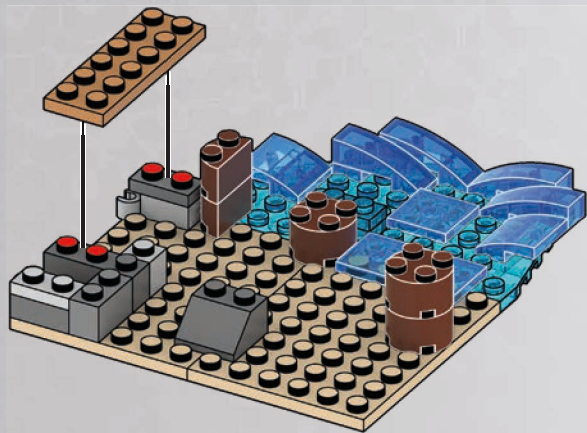

1

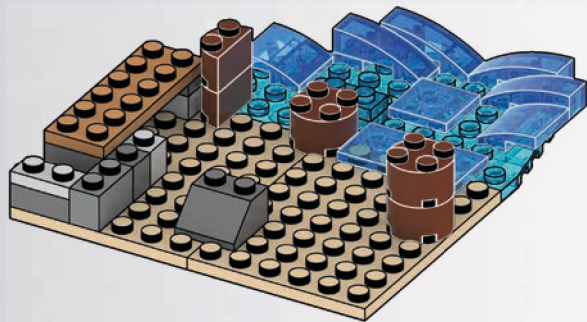

2



30

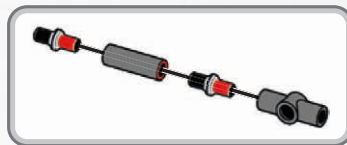
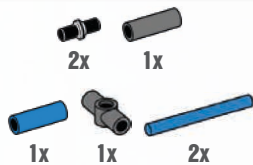

x2

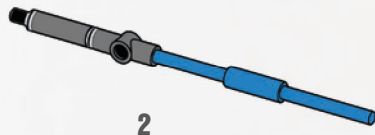
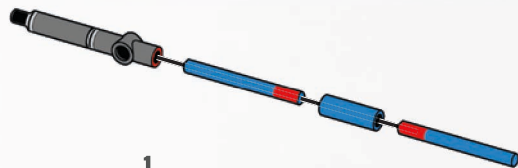

31

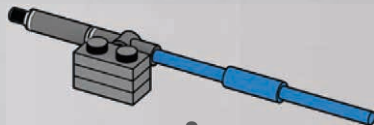
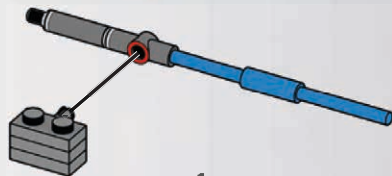
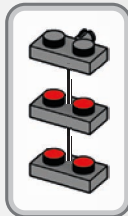

32

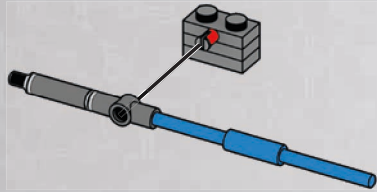
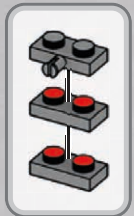

1

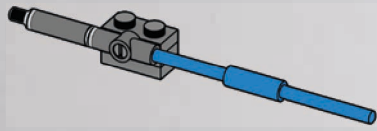

2

33

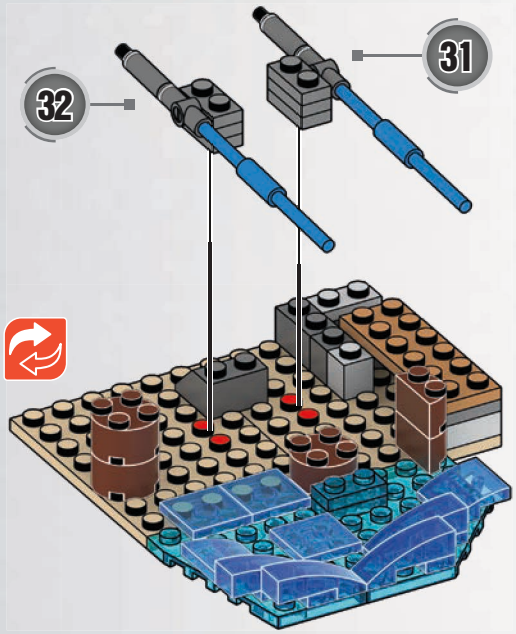

34



1x



1x



1x

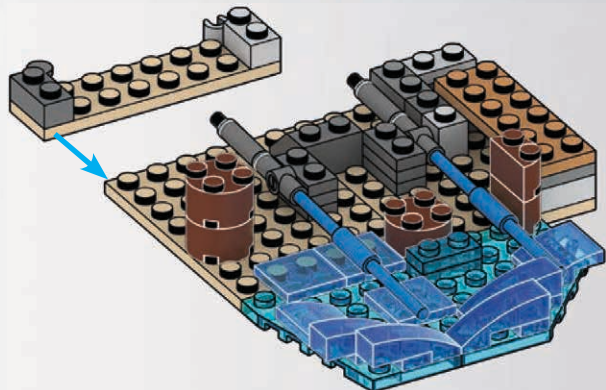
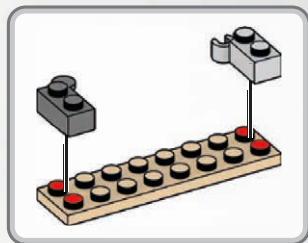

1

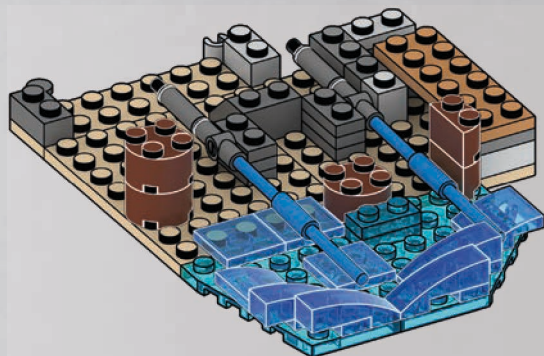

2

35



2x



1x

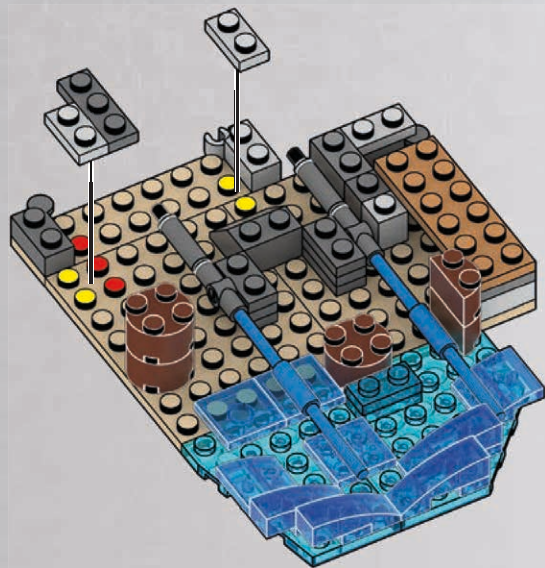

1

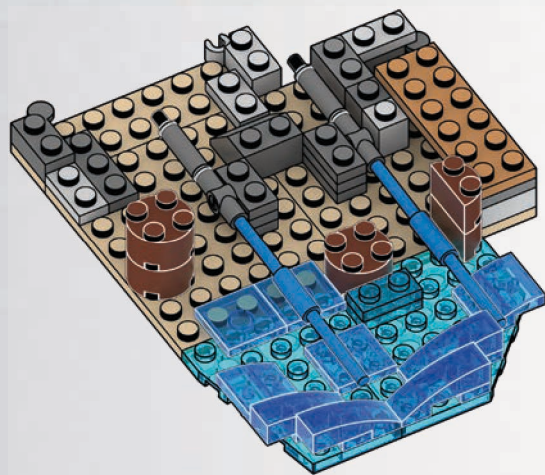

2

36

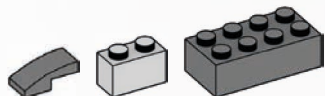

1x

2x

1x

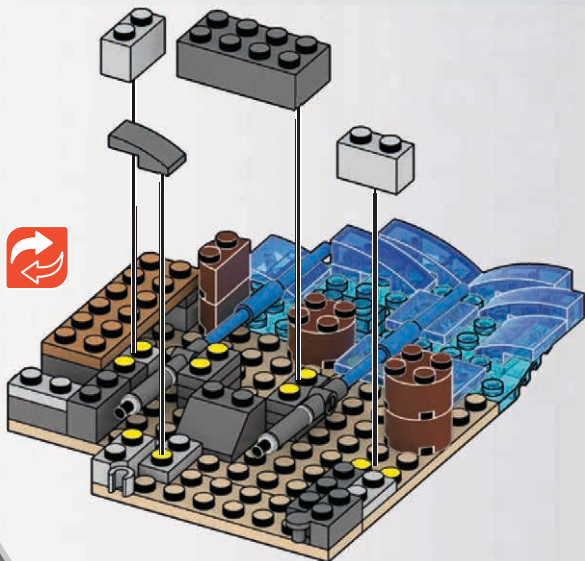

37



2x

1x

1x

1x

1x

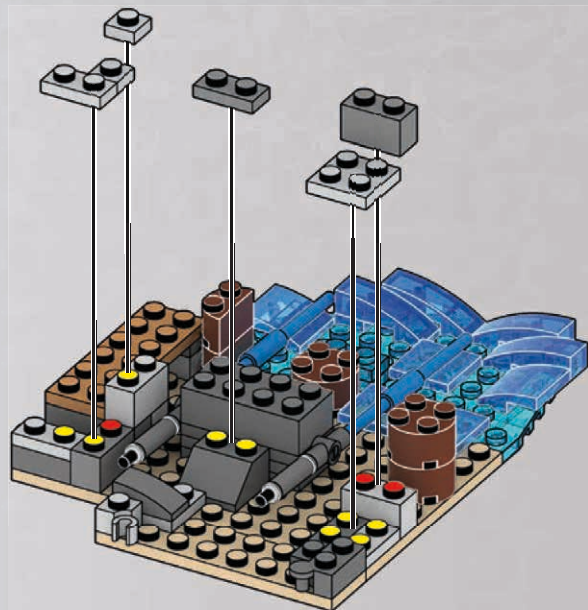

38



1x



1x



1x



1x

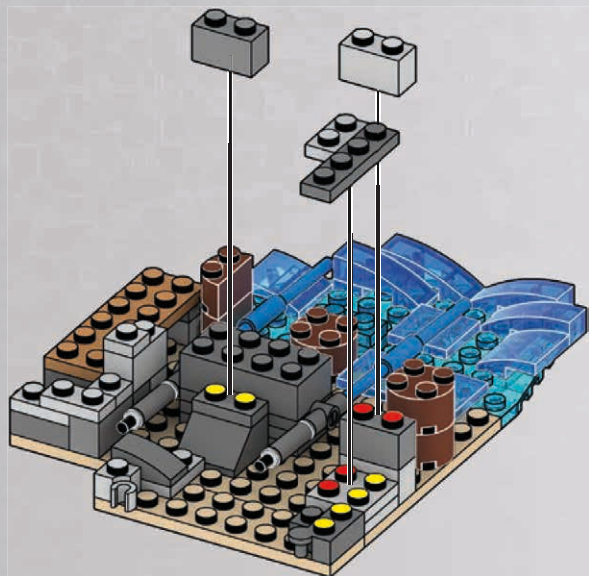

1

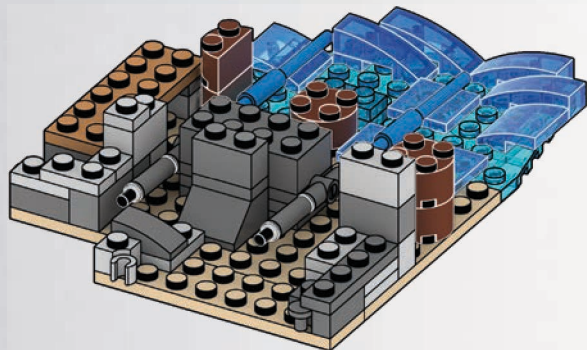

2

39

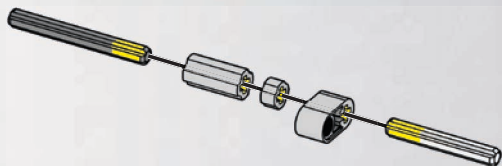
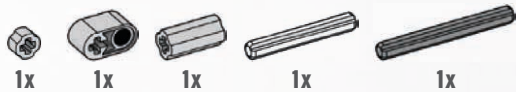

40

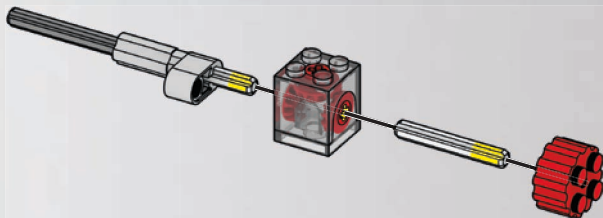
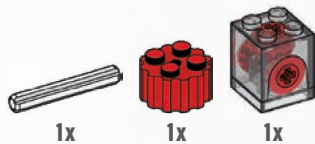

41



1x



1x



1x

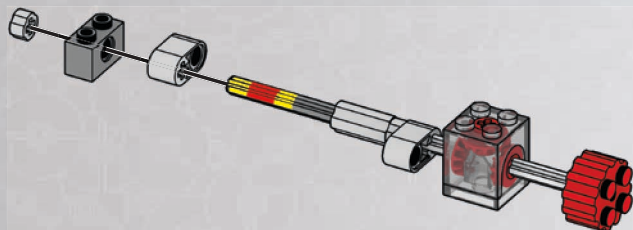

1

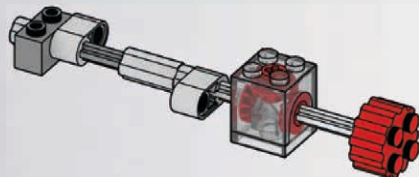

2

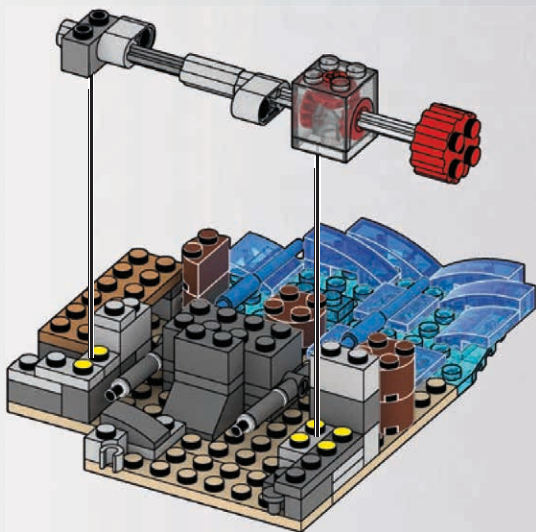

1

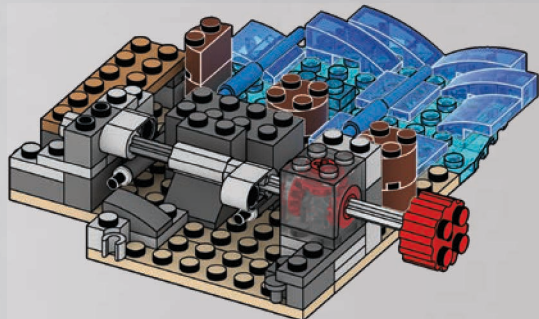

2

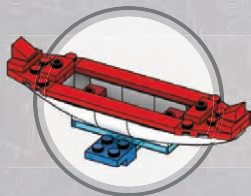

43

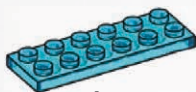

1x



2x

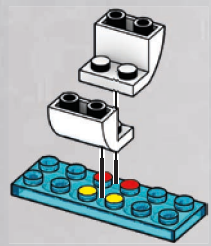

1

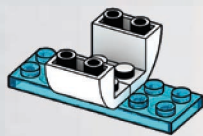

2

44

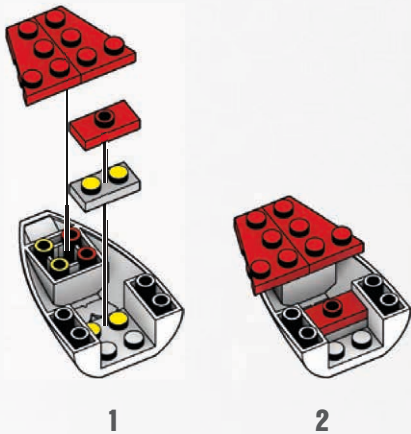
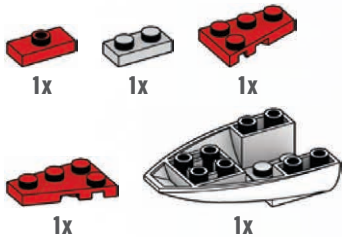

x2

45

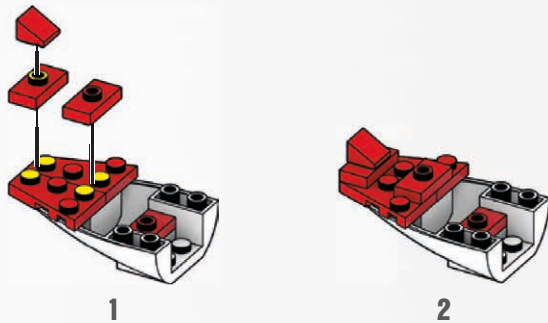
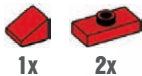

46

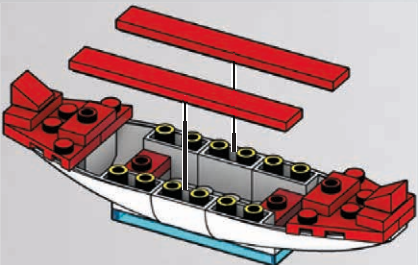
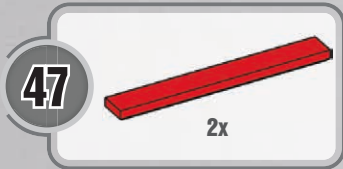
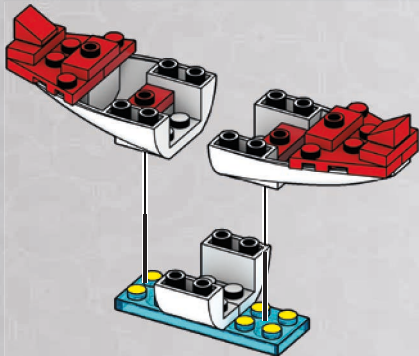

1

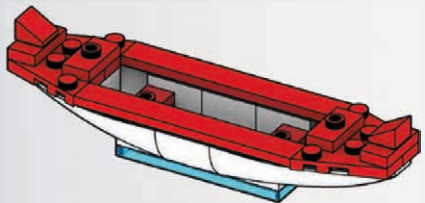

2

48



1x

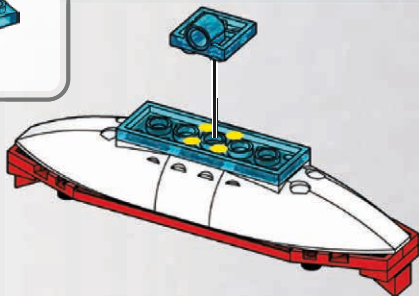

1

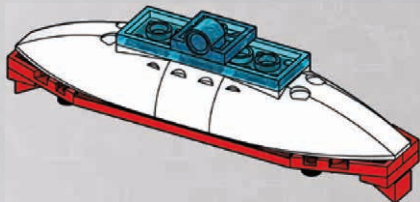

2

49



1x

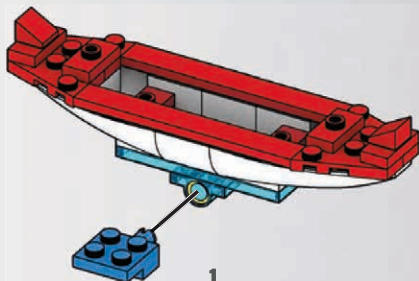

1

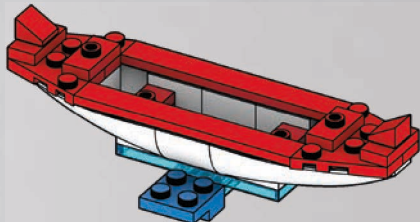

2

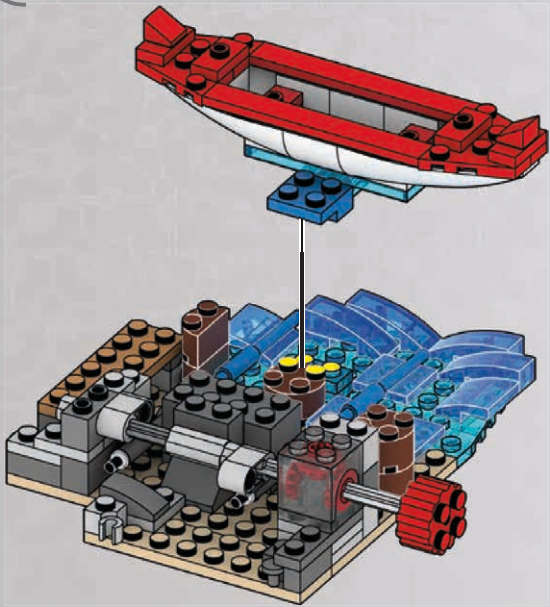

1

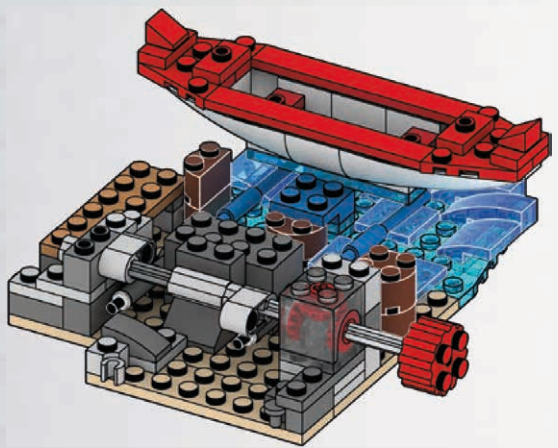

2

51



1x



2x

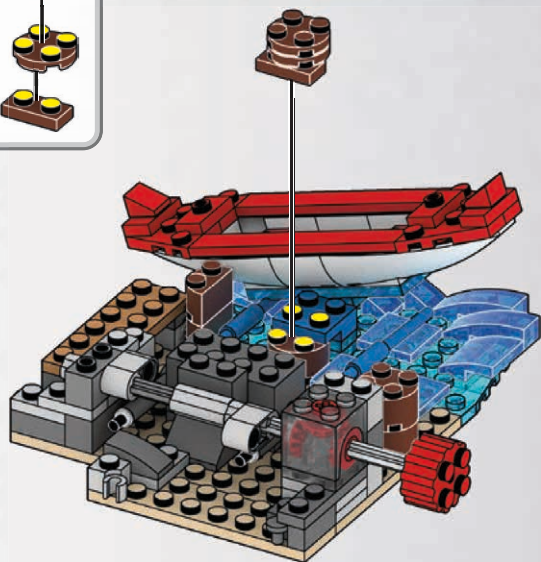
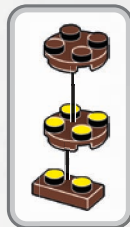

1

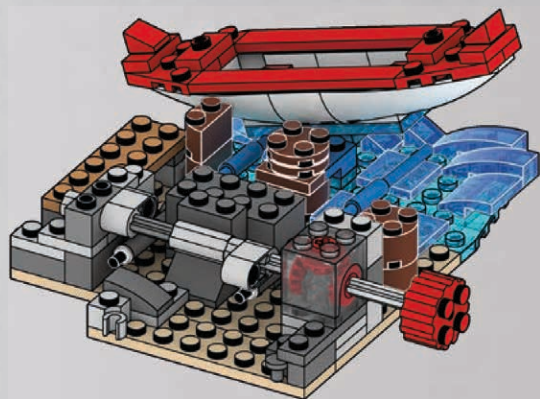

2

52

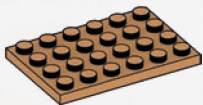

1x



1x

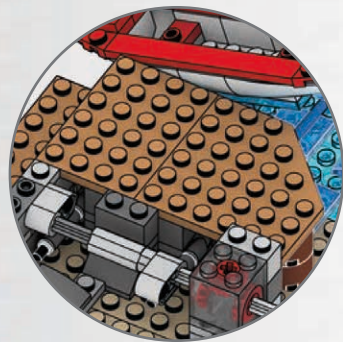
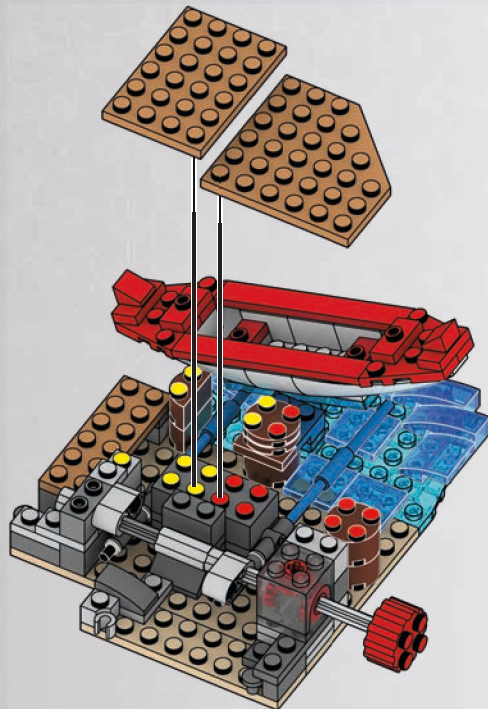

53



1x



1x



1x



1x

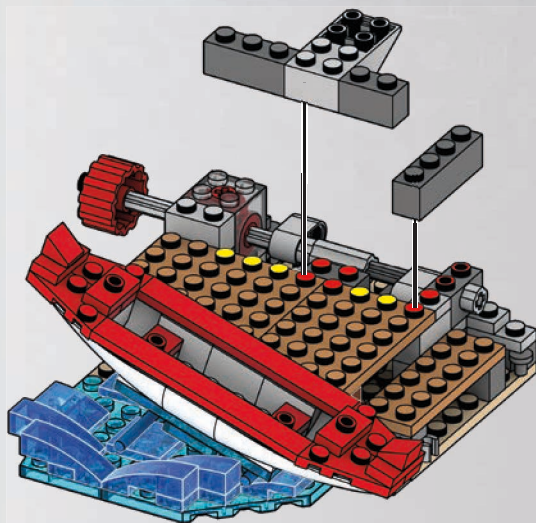

54



1x

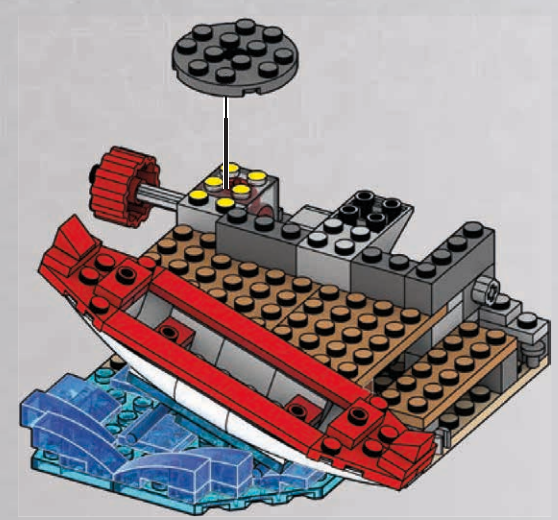

55

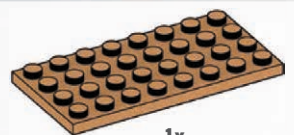

1x

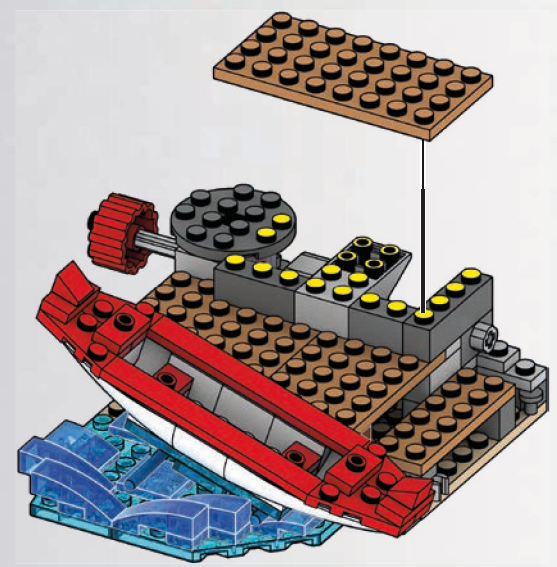

56



2x



1x



1x

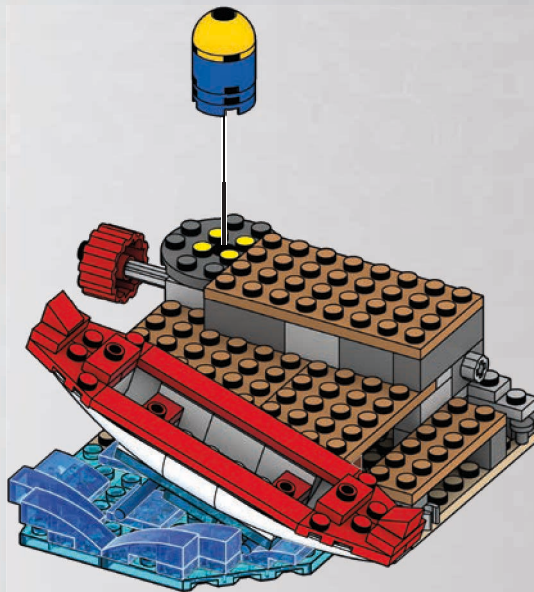
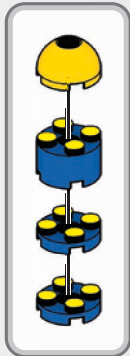

57



2x



1x



3x



3x



x3

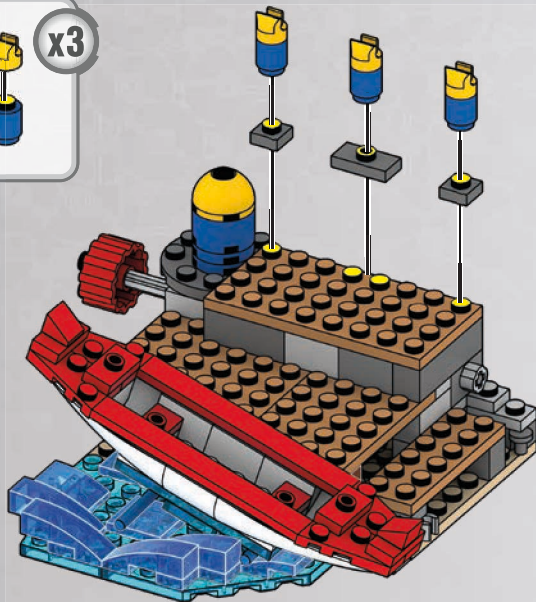

58



1x

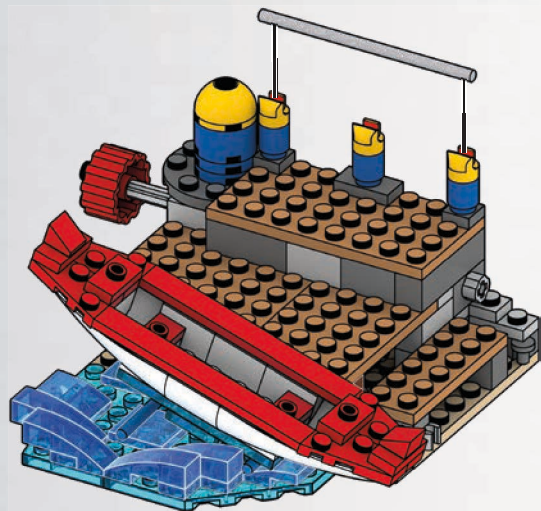

59



1x



1x



1x



1x

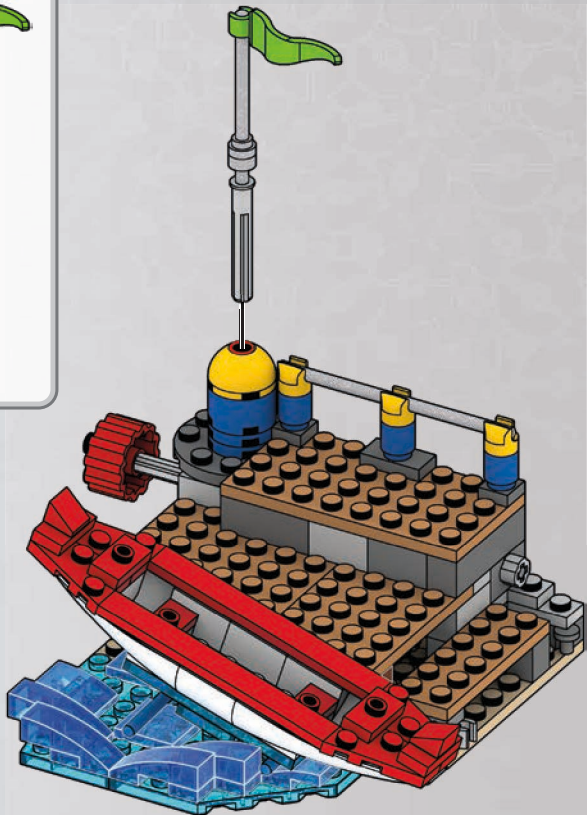
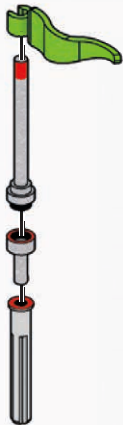

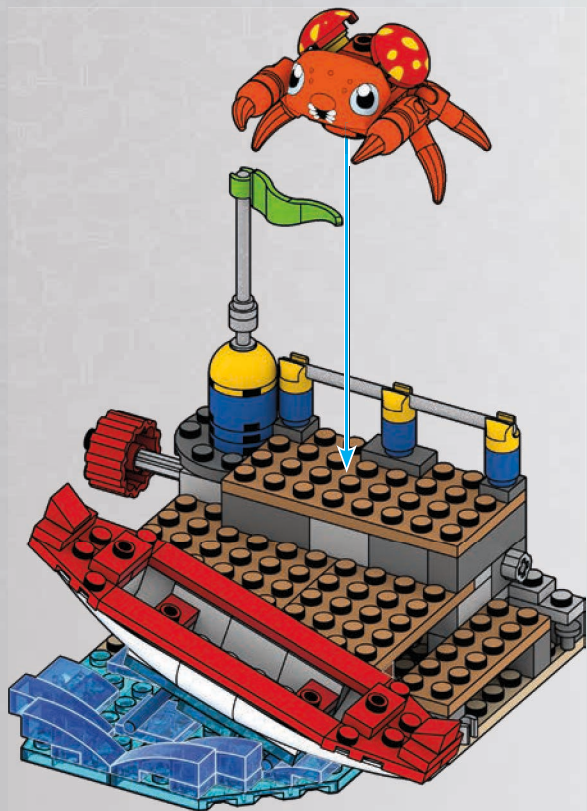

61

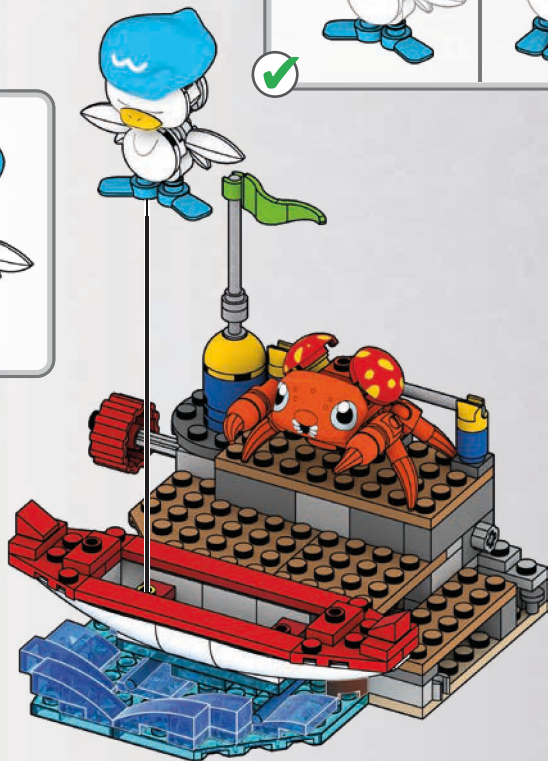
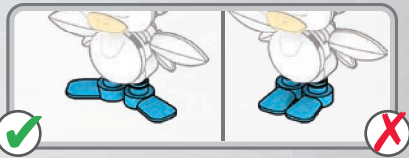
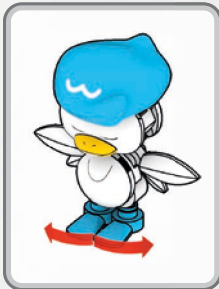

1

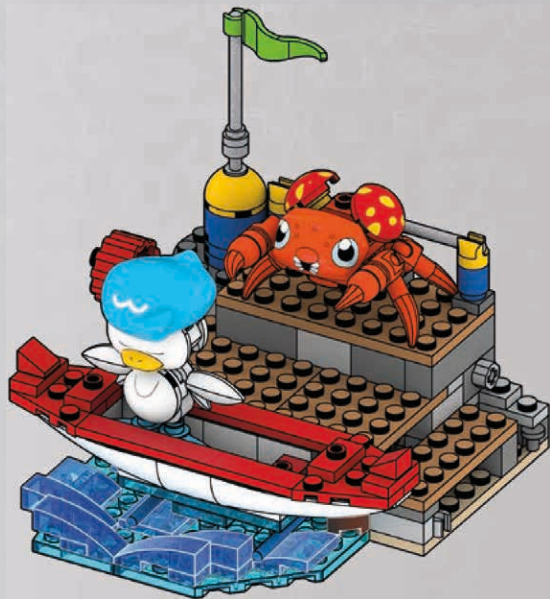

2



Quaxly and Paras's Sea Splash / Le Plongeon de Coiffeon et Paras / Kwaks und Paras Wasserspaß / Quaxly e Paras Tuffò tra le Onde / Waterpret met Quaxly en Para / El chapuzón marino de Quaxly y Paras / Diversão Aquática do Quaxly e Paras / Quaxly och Paras vattenlek / Quaxlys og Paras' havplask / Morska przygoda Quaxly'ego i Parasa / Špliechanie vln Quaxly a Para / Quaxly és Paras tengeri kalandja / Морские приключения Quaxly и Paras / Quaxly και Paras - Περιπέτεια στη Θάλασσα / Quaxly ve Paras'ın Deniz Maceraları / Quaxly and Paras's Sea Splash طرشة البحر

⚠ WARNING:
CHOKING HAZARD – Small parts.
Not for children under 3 years.

ATTENTION :
DANGER D'ÉTOUFFEMENT –
PETITS ÉLÉMENTS. NE
CONVIENT PAS AUX ENFANTS
DE MOINS DE 36 MOIS.

WARNING: Small parts, ATTENTION : PETITS ÉLÉMENTS, ACHTUNG: Kleine Teile, AVVERTENZA: Piccole parti, WAARSCHUWING: Kleine onderdelen, ADVERTENCIA: PELIGRO DE ATRAGANTAMIENTO. Juguete no recomendado para menores de 3 años, porque contiene piezas pequeñas que podrían provocar asfixia en caso de ser ingeridas o inhaladas por el/la niño/a, VARNING: Små delar, VAROITUS: Pieniä osia, ADVARSEL: Små dele, ADVARSEL: Små deler, OSTRZEŻENIE: Małe części, UPOZORNĚNÍ: Malé části, UPOZORNENIE: Malé časti, FIGYELMEZTETÉS: Kis alkatrészek, ПРЕДУПРЕЖДЕНИЕ: Мелкие детали, ΠΡΟΕΙΔΟΠΟΙΗΣΗ: Μικρά κομμάτια, UYARI: Küçük parçalar.



تحذير : قطع صغيرة.
警告: のどにつまる危険 小さな部品が含まれています 3歳以下の子供には与えないで下さい。

警告! 不适合3岁以下儿童使用。内含小零件。

ATENÇÃO: NÃO INDICADO / NÃO RECOMENDÁVEL PARA CRIANÇAS MENORES DE 3 (TRÊS) ANOS POR CONTER PARTE(S) PEQUENA(S) QUE PODE(M) SER ENGOLIDA(S) OU ASPIRADA(S) PODENDO PROVOCAR ASFIXIA.

2x
 AMO113HQ



2x
 AM79915BLG



2x
 AM78802MCX



2x
 AM76558MCX



4x
 AMO3328HJ



2x
 AMO3328BDG



2x
 AMO3328BLG



2x
 AM17003GD



4x
 AM17003F



1x
 AS-HRL52-03



2x
 AM79425MCX



1x
 AM81890E



3x
 AM78297BYE



2x
 AM78274MCX



3x
 AMO0910B



2x
 AM79487E



2x
 AM17127AMC



1x
 AM75318APG



4x
 AM80485MCX



2x
 AM80950E



2x
 AM79684GD



1x
 AM78291E



2x
 AM80010E



2x
 AM78289MCX



2x
 AM76867BDG



2x
 AM17506BDG



2x
 AM17506HP



1x
 AMO1086BLG



4x
 AM72384MCX



6x
 AMO7590AMC



1x
 AMO7590BDG



2x
 AMO9393ANJ



7x
 AMO9393BLG



1x
 AMO9393DH



6x
 AMO9393BDG



2x
 AM18221BDG



1x
 AM80011E



1x
 AS-HPX92-09



2x
 AS-HRL52-01



1x
 AM79982E



2x
 AM74677DH



2x
 AM79815B



1x
 AM17835MCX



1x
 AM73989MCX



1x
 AM78486BDG



1x
 AM18266BYE



2x
 AM81428BLG



1x
 AM81438BLG



2x
 AMO3325DH



2x
 AM76559BLG



2x
 AM76560BDG



4x
 AMO9013BDG



3x
 AMO9013BLG



1x
 AM79877BDG



1x
 AM74060MCX



3x
 AMO1320DH



1x
 AMO4217B



3x
 AMO0948HJ



1x
 AMO3773BLG



2x
 AM74106HJ



1x
 AM79952ANJ



1x
 AM81613AMC



1x
 AM10273BDG



1x
 AM81385HP



1x
 AS-HRL52-02



1x
 AM78286E



1x
 AM78286MCX



2x
 AM78282E



1x
 AS-HRL52-04





2x
AM08482E



1x
AS-HKT19-01



3x
AM78412MCX



1x
AM01314BDG



2x
AM17073AMC



2x
AM17074AMC



1x
AS-HPX92-08



1x
AM03772MCX



2x
AM16384BDG



4x
AM07230HJ



4x
AM76521HP



2x
AM80223BLG



1x
AM80483BLG



1x
AM16450JS



1x
AM09593BDG



1x
AM16764APG



1x
AM80260BDG



1x
AM76367BDG



1x
AM01087BDG



1x
AM72654BLG



1x
AM09033BDG

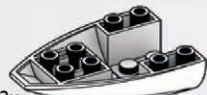

2x
AM76217E



1x
AM01480VL



1x
AM01480ANJ



1x
AM03771ANJ

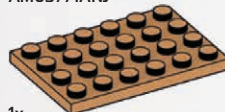

1x
AM17055VL



1x
AM18259APG



2x
AM09922AMC



1x
AM08483BTN



1x
AM18544VL



1x
AM18544ANJ

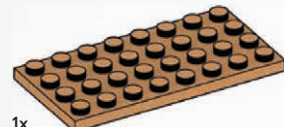

1x
AM17845VL

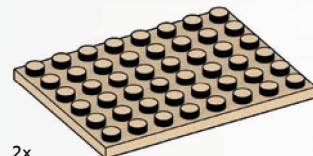

2x
AM74678BTN

Missing pieces? Pièces manquantes?

¿Partes faltantes? • Perdus peças?
Fehlen Teile? • Не хватает деталей?

support.megabrands.com

BUILD YOUR WORLD OF POKÉMON WITH MOTION CONSTRUIS TON MONDE POKÉMON EN MOUVEMENT



Construye tu mundo de Pokémon con movimiento
Constrói o teu mundo de Pokémon com movimento
Eine eigene, bewegliche Pokémon Welt bauen
Построй свой мир Pokémon с движением



HRL52*



HPB59*



GFC85: GVK60, GVK61, GVK62, GVK63, GVK64, GVK65 / FPM00: HKT09, HKT10, HKT11, HKT12, HKT13, HKT14 / HPX92 / GWY77 / HKT25 / HKT26 / HPB59 / HKT21 / HNT93 / HHN61 / HKT23 / HFG06 / HDH93 / HNT95 / HHM17

Set(s) sold separately and subject to availability. / Ensemble(s) vendu(s) séparément. Certains produits peuvent ne pas être commercialisés. / Se vende(n) por separado y está(n) sujeto(s) a disponibilidad. / Conjunto(s) vendido(s) em separado e sujeito(s) à disponibilidade. / Set in vendita separatamente, secondo disponibilità. / Das/Die Set(s) sind separat erhältlich. / Zestaw(ly) sprzedawane(ę) oddzielnie w zależności od dostępności. / Set(s) apart verkrijgbaar en afhankelijk van beschikbaarheid. / Набор(-ы) продаются отдельно, при наличии. / Set sælges separat og så længe lager haves. / Seten säljs separat så länge lagret räcker. / Settet/ settene selges separat så langt lageret rekker. / Pakkaus/pakkaukset myydään erikseen, saatavuus voi vaihdella. / Το(α) σετ πουλονται ξεχωριστά και ανάλογα με τη διαθεσιμότητα. / Setler ayrı olarak satılır ve stoklara sınırlıdır. / Set (sety) se prodává (prodávají) samostatně dle aktuální nabídky. / Súpava/-y sa predáva(jú) samostatne a podľa dostupnosti. / A készlet(ek) külön kapható(k), az elérhetőség változhat. /

セット商品は別売りになります。在庫状況は別途ご確認をお願いします。 /
تباع المجموعة أو المجموعات على حدة وتخص لتوافرها.
每套单独发售，按供货情况决定。

Mattel Europa B.V., Gondel 1, 1186 MJ Amstelveen, Nederland. Mattel U.K. Limited, The Porter Building, 1 Brunel Way, Slough SL1 1FQ, UK. Mattel France, Parc de la Cerisaie, 1/3/5 allée des Fleurs, 94260 Fresnes Cedex. N° Cristal 0969 36 99 99 (Numéro non surtaxé) ou www.lesjouetsmattel.fr Mattel Belgium N.V. De Kleeftaan 4, 1831 Machelen (Diegem) Belgium. Deutschland : Mattel GmbH, Solmsstraße 83, D-60486 Frankfurt am Main. Schweiz: Mattel AG, Kirchstrasse 24, CH-3097 Liebefeld. Österreich: Mattel Ges.m.b.H., Campus 21, Liebermannstraße A01 404, A - 2345 Brunn/Gebirge. Mattel Italy Srl, Via Turati 4, 20121 Milano, Italy. Servizio assistenza clienti: Customersrv.italia@mattel.com - Numero verde 800 11 37 11. Mattel España, S. A., Arriba 200 pl. 9, 08036 Barcelona. c.servicio.spain@mattel.com - Tel: +34 933 06 79 00 http://www.servicio.mattel.com/es. Hong Kong: Kids Kingdom Limited, Room 1908-9, Gala Place, 56 Dundas Street, Mongkok, Kowloon, Hong Kong. Customer Care line: (852)2782-0766. Taiwan: Chickabiddy Company Limited, 5/F, No. 186, Section 4, Nanjing East Road, Taipei 10595, Taiwan. Customer Care line: (02)2578-1188. Mainland China: Mattel Barbie (Shanghai) Trading Co., Ltd. Units 4701-4711, 47F, 2 Grand Gateway, 3 Hong Qiao Road, Shanghai, 200030, P.R.C. Customer Care line: 400-819-8658. Diimport & Diedarkan Oleh: Mattel Continental Asia Sdn Bhd. Level 19, Tower 3, Avenue 7, No. 8 Jalan Kerinchi, Bangsar South, 59200 Kuala Lumpur, Malaysia. Mattel South Africa (PTY) Ltd, Office 102 I3, 30 Melrose Boulevard, Johannesburg 2196. Dysturbitor: Mattel Poland Sp. z o.o., Warsaw Trade Tower 34 p., ul. Chłodna 51, 00-867 Warszawa. Mattel Australia Pty. Ltd., 658 Church St., Richmond, Victoria, 3121. Consumer Advisory Service - 1300 135 312. Mattel AEBE, Евбъргоу Макарпиу 1, Ктпиро К-2, Тк 17561, Пловдив Фолпиро. Mattel Oyuncakçılık Tic. Ltd. Şti. İçerenköy Mah., Umut Sokak No: 10 - 12, Quick Tower kat:2 İçkari no:15 Ataşehir 34752, İstanbul, Türkiye. Tel: 0216 570 75 00. Импортёр/Уполномоченная организация: ООО "МАТТЕЛ" Российская Федерация, 105120 Москва, 2-й Сыромятинский переулок, 1; +7 495 287 79 39. Mattel Czech Republic s.r.o., The Forum, Václavské nám. 19, 11000 Praha1, Mattel, 333 Continental Boulevard, El Segundo, CA 90245, USA. Consumer Services: 1-800-465-MEGA (6342). Mattel Canada Inc., Mississauga, Ontario L5R 3Z0. Consumer Services: You may call us free at / Composez sans frais le 1-800-524-8697. Importado y distribuido por Mattel de México, S.A. de C.V., Miguel de Cervantes Saavedra No. 193, Pisos 10 y 11, Col. Granada, Alcaldía Miguel Hidalgo, CP. 11520, México, Ciudad de México. R.F.C. MME-920701-NB3. Tel.: 59-05-51-00 Ext. 5206 ó 01-800-463-59-89. Mattel Chile, S.A., Avenida Américo Vespucio 501-B, Quilicura, Santiago. Tel.: 1230-020-6213. Servicio al consumidor Venezuela: Tel.: 0-800-100-9123. Mattel Argentina, S.A., Av. Libertador 1000, Piso 11 - Oficinas 109 y 111, Vicente López - Prov. Buenos Aires. Tel.: 0800-666-3373. Mattel Colombia, S.A., Calle 12347-07 P5, Bogotá. Tel.: 01800-710-2069. Mattel Perú, S.A., Av. Juan de Arona # 151, Centro Empresarial Juan de Arona, Torre C, Piso 7, Oficina 704, San Isidro, Lima 27, Perú. RUC: 20425863865. Reg. Importador: 02350-12-JUE-DI-GESA. Tel.: 0800-54744. E-mail Latinoamérica: servicio.clientes@mattel.com. Mattel do Brasil Ltd. - CNPJ: 54.558.002/0001-20 - Rua Verbo Divino, 1488 - 2º. Andar - 04719-904 - Chácara Santo Antônio - São Paulo - SP - Brasil. Serviço de Atendimento ao Consumidor: fone 0800 575 0780. E-mail: sac.matteldobrazil@mattel.com

©2023 Pokémon. ©1995–2023 Nintendo / Creatures Inc. / GAME FREAK inc. TM, ®, and character names are trademarks of Nintendo.

©2023 Pokémon. ©1995–2023 Nintendo/Creatures Inc./GAME FREAK inc. TM, ® et les noms des personnages sont des marques de Nintendo.



BUILD A WORLD OF POKÉMON CRÉEZ VOTRE UNIVERS POKÉMON



CONSTRUYE UN MUNDO DE POKÉMON
CONSTRÓI UM MUNDO DE POKÉMON EINE
POKÉMON WELT ERSCHAFFEN
ПОСТРОЙТЕ МИР POKÉMON

Mattel Canada Inc. Mississauga, Ontario L5R 3W2.
MADE IN CHINA. FABRIQUÉ EN CHINE. FABRICADO NA CHINA. HECHO EN CHINA.
ИЗГОТОВЛЕНО В КИТАЕ. ÇIN'DE ÜRETİLMİŞTİR. صنع في الصين

©2023 MEGA Brands &™ MEGA Brands.
Printed in China / Imprimé en Chine

AD-HRL52-01

© D799,608, D834,105

1186 MJ, 1, NL

