



**HHL95**

'64 CORVETTE®  
GRAND SPORT™



## Build Construisez

Construye | Constrói  
Bauen | Стройте



## Share Partagez

Comparte | Partilha  
Teilen | Делитесь

Devices not included | Appareils non inclus  
Dispositivos no incluido | Dispositivos não incluídos  
Geräte nicht enthalten | Устройства не входят в комплект



## Get creative! Soyez créatif!

¡Sé creativo! • seja criativo!  
werde kreativ! • проявите  
творческий подход!



Build ideas may use pieces from multiple sets (sold separately).  
Les idées de construction peuvent nécessiter des pièces issues de  
différents coffrets (vendus séparément).  
Las ideas de construcción pueden utilizar piezas de varios conjuntos  
(se venden por separado).  
As ideias de construção podem utilizar peças de vários  
conjuntos (vendidas em separado).  
Für Bauideen sind möglicherweise Teile von mehreren  
Sets nötig (separat erhältlich).  
В идеях конструкций могут быть использованы детали  
из разных наборов (продаются отдельно).

[megaunboxed.com](http://megaunboxed.com)



1



1



2



'64 CORVETTE<sup>®</sup>  
GRAND SPORT<sup>™</sup>

2



2x

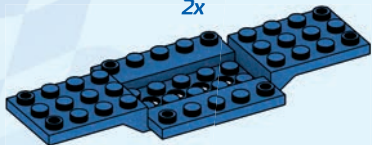

1x

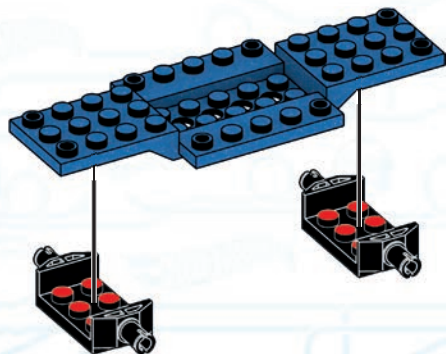

3



1x

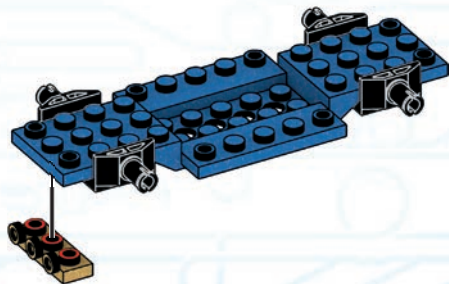

4



1x

5



2x

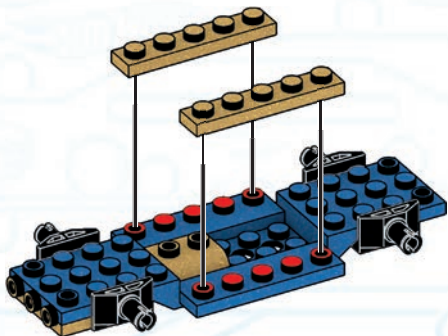
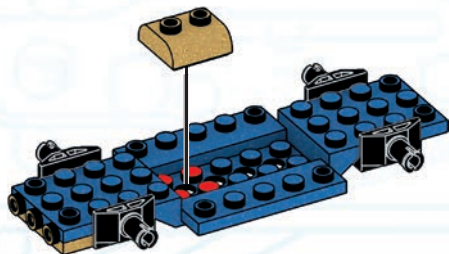



'64 CORVETTE<sup>®</sup>  
GRAND SPORT™

6



1x

2x

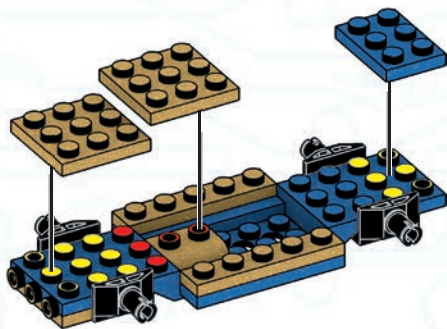

7



1x

1x

1x

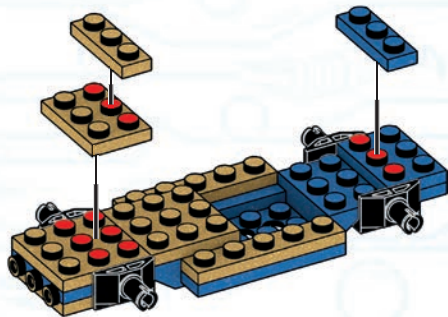

8



1x



1x



1x

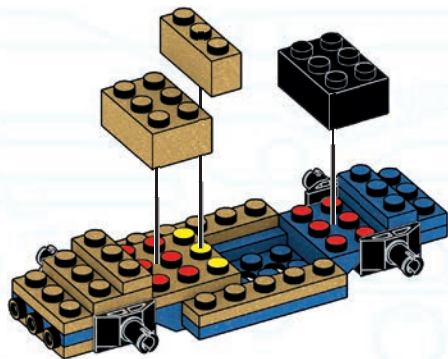



'64 CORVETTE<sup>®</sup>  
GRAND SPORT™

9



1x

2x

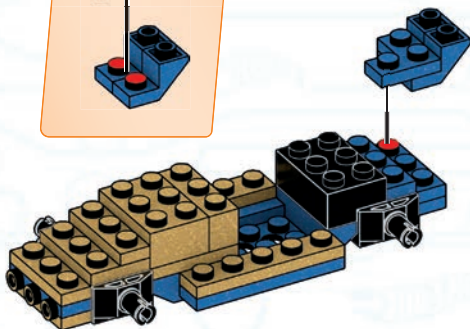
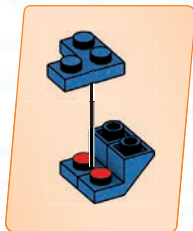



10



1x



1x

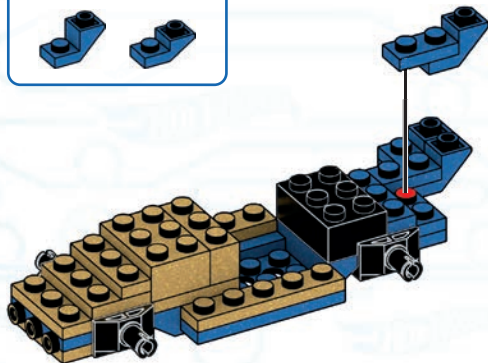
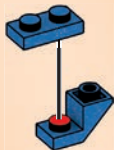

11



1x



2x

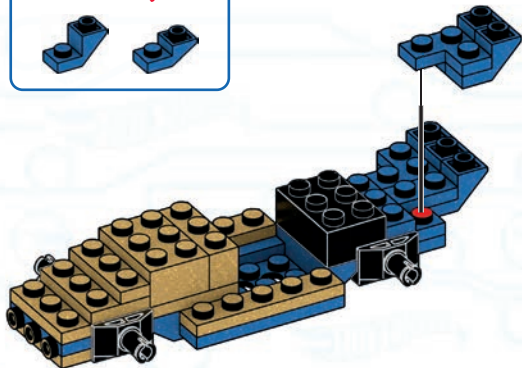
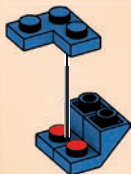



'64 CORVETTE<sup>®</sup>  
GRAND SPORT™

12



1x



1x

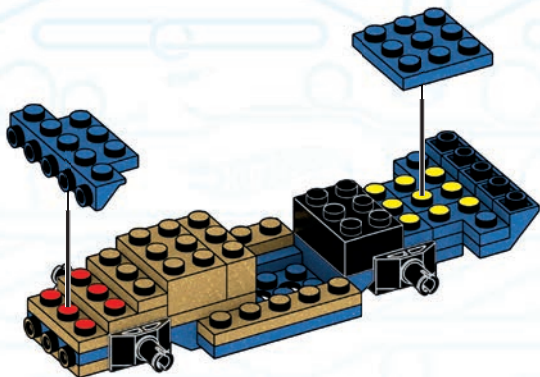

13



1x



1x

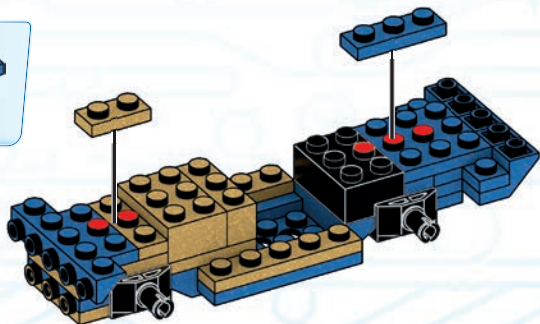

14



2x

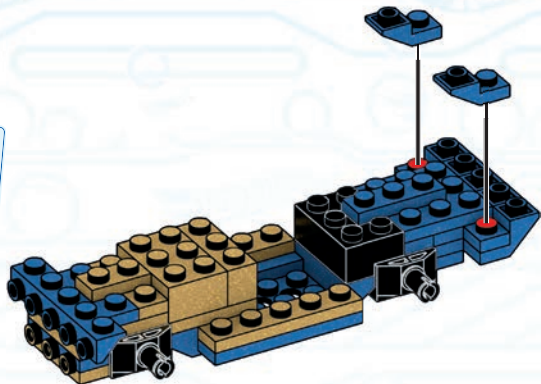

15



1x



1x

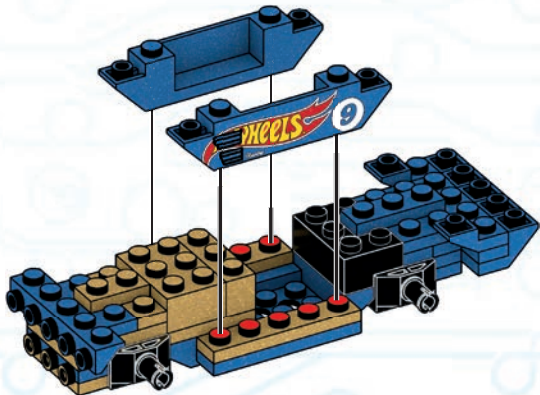



'64 CORVETTE<sup>®</sup>  
GRAND SPORT™

16



2x



1x

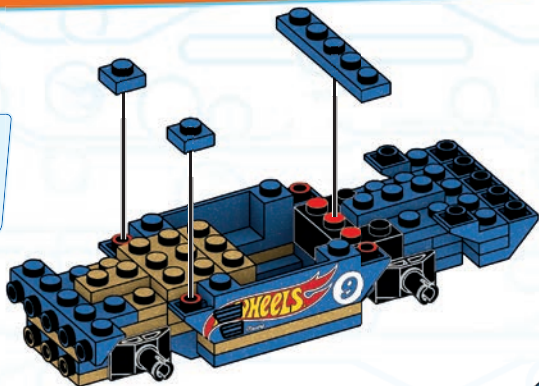

17



2x



2x

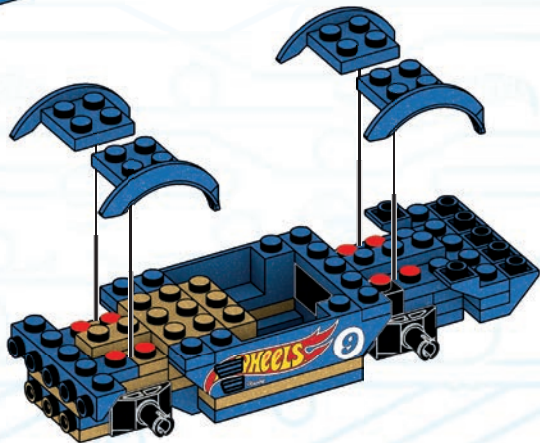

18



1x



1x

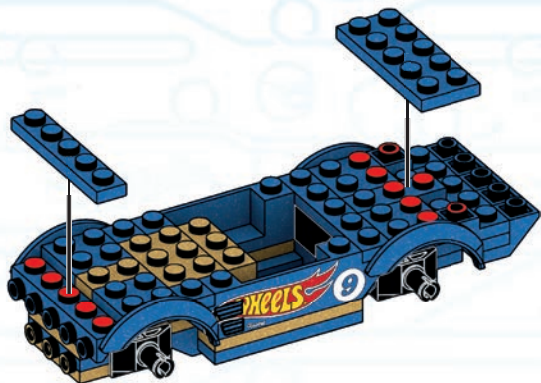

19



1x

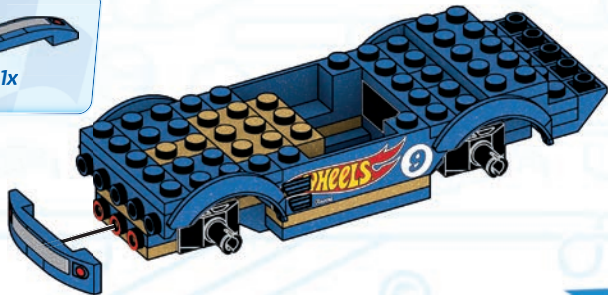



'64 CORVETTE<sup>®</sup>  
GRAND SPORT™

20



1x



2x

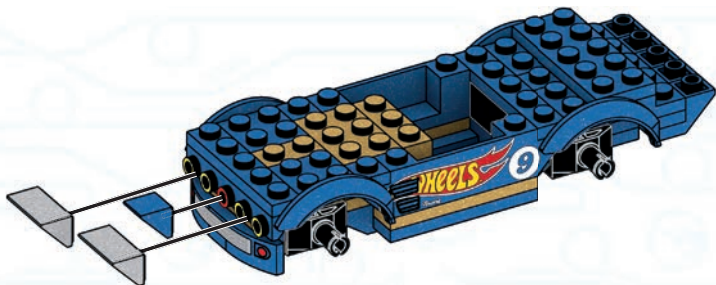

21



5x

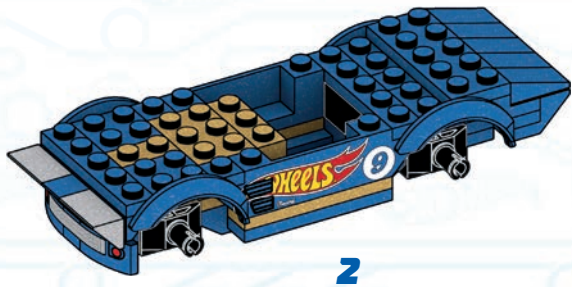
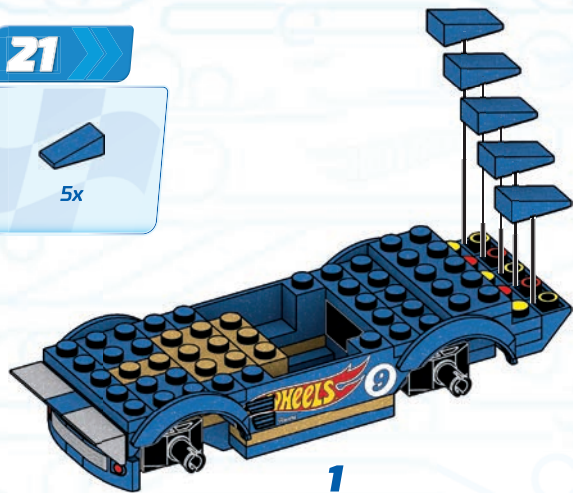



'64 CORVETTE<sup>®</sup>  
GRAND SPORT™

22



1x



1x



1x



1



2

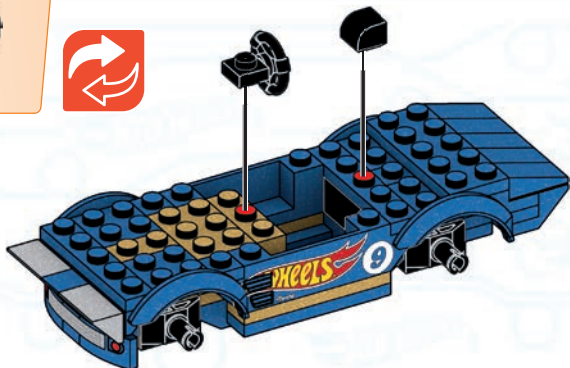



23



1x



1x

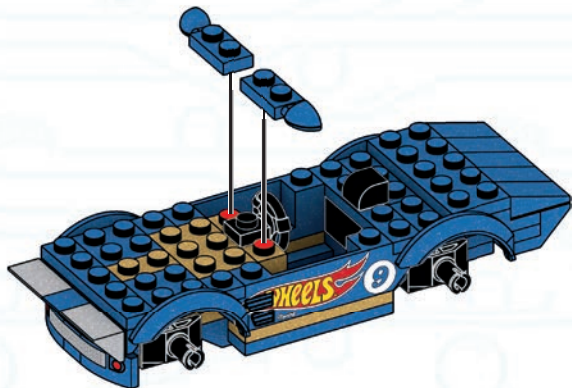



'64 CORVETTE<sup>®</sup>  
GRAND SPORT<sup>™</sup>

24



3x

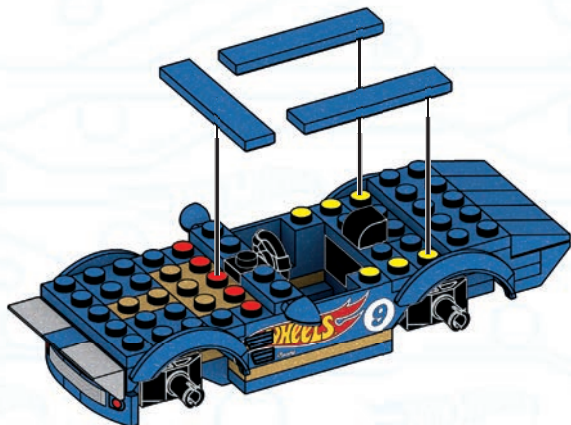

25



1x



1x

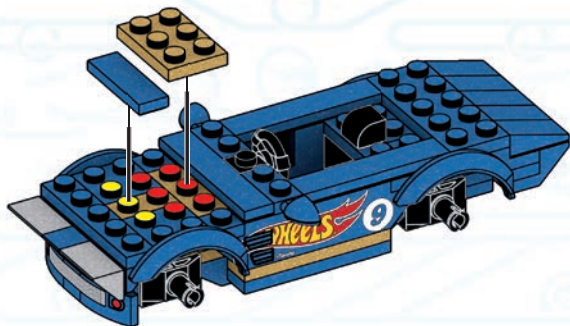

26



2x

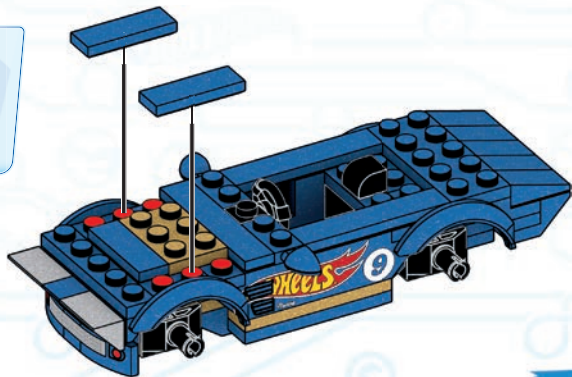



'64 CORVETTE<sup>®</sup>  
GRAND SPORT<sup>™</sup>

27



1x



1x



1x

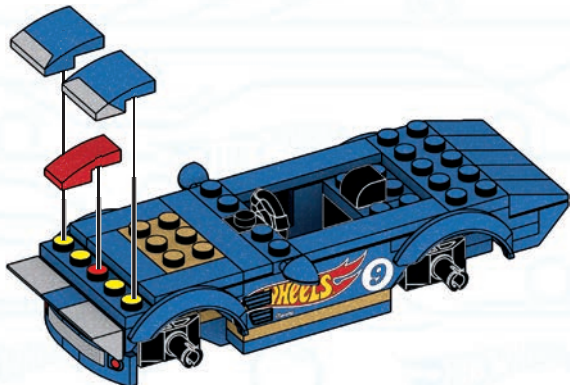

28



1x

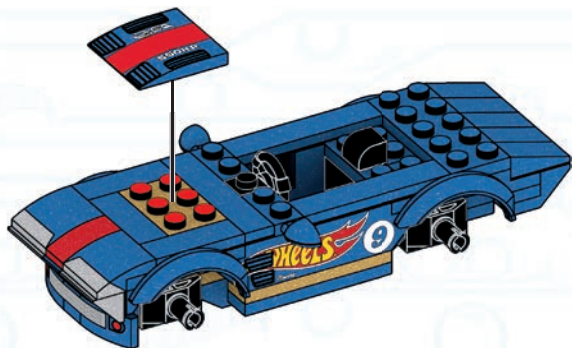



'64 CORVETTE<sup>®</sup>  
GRAND SPORT™

29



1x



1x

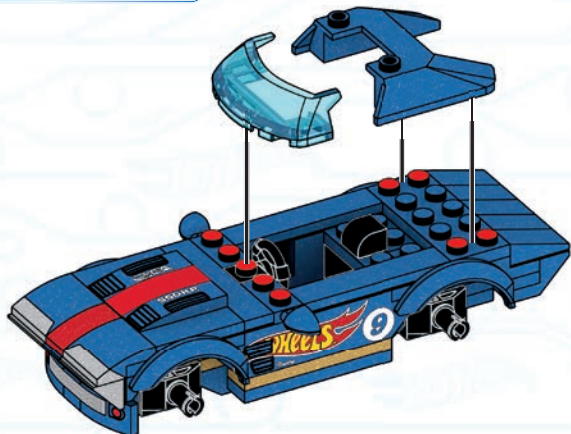

30



1x

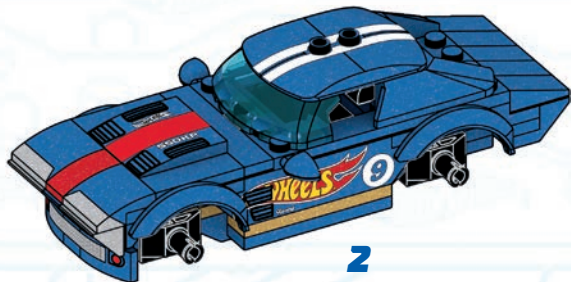
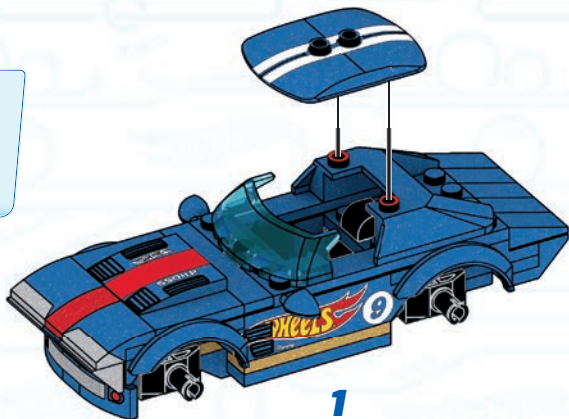



'64 CORVETTE<sup>®</sup>  
GRAND SPORT™

31

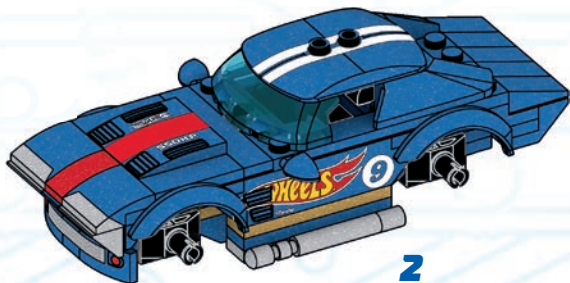
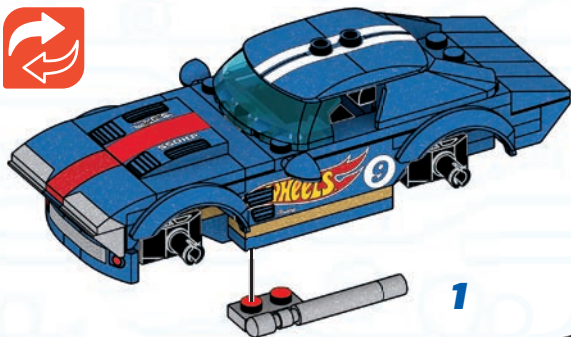
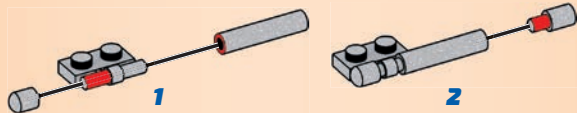



32



1x



1x



1x



1x

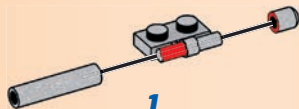



'64 CORVETTE<sup>®</sup>  
GRAND SPORT™

33



4x

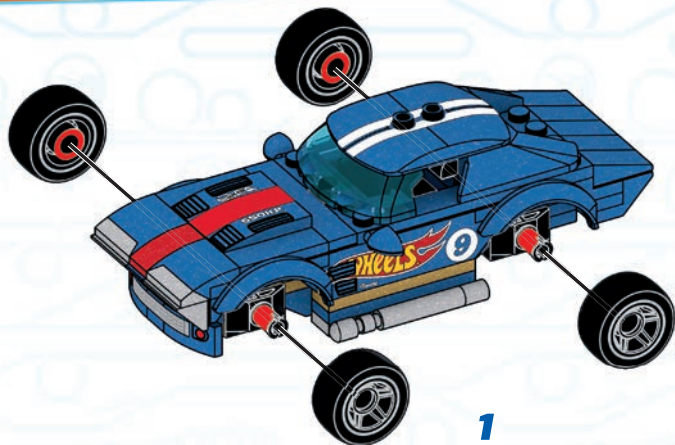

1

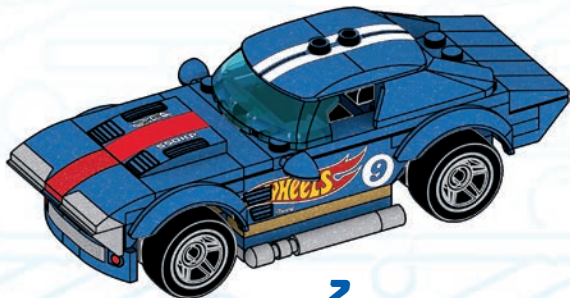

2

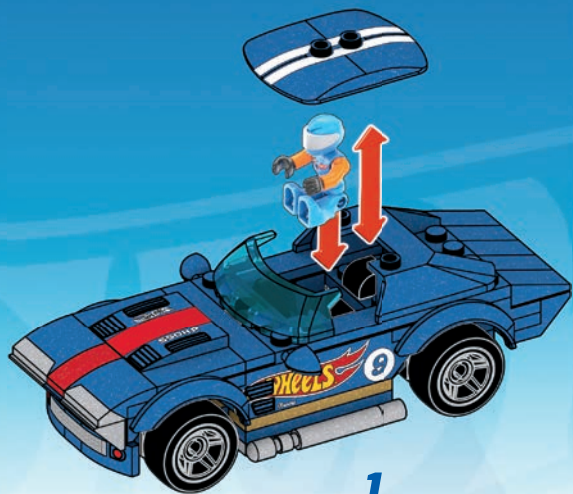

# MIX & MATCH! COMBINE-LES!

MEZCLA Y COMBINA! · MISTURA E COMBINA!  
ZUM KOMBINIEREN! · СОЧЕТАЙ И ПОДБИРАЙ!

HH018\*



Set(s) sold separately and subject to availability. / Ensemble(s) vendu(s) séparément. Certains produits peuvent ne pas être commercialisés. / Se vende(n) por separado y está(n) sujeto(s) a disponibilidad. / Conjunto(s) vendido(s) em separado e sujeito(s) à disponibilidade. / Set in vendita separatamente, secondo disponibilità. / Das/Die Set(s) sind separat erhältlich. / Zestaw(y) sprzedawany(e) oddzielnie w zależności od dostępności. / Set(s) apart verkrijgbaar en afhankelijk van beschikbaarheid. / Набор(ы) продаются отдельно, при наличии. / Sæt sælges separat og så længe lager haves. / Seten säljs separat så länge lagret räcker. / Settet/settene selges separat så langt lageret rekker. / Pakkaus/pakkaukset myydään erikseen, saatavuus voi vaihdella. / Το(α) σετ πωλούνται ξεχωριστά και ανάλογα με τη διαθεσιμότητα. / Setler ayrı olarak satılır ve stoklarla sınırlıdır. / Set (sety) se prodává (prodávají) samostatně dle aktuální nabídky. / Súprava-/y sa predáva(jú) samostatne a podľa dostupnosti. / A készlet(ek) külön kapható(k), az elérhetőség változhat. / セット商品は別売りになります。在庫状況は別途ご確認をお願いします。 / بیاع المجموعه أو المجموعات علی حدة وتخصم لتوافرها. 每套单独发售，按供货情况决定。

Additional purchase required. / Achat additionnel requis. / Zusätzlicher Kauf erforderlich. / Richiede acquisto addizionale. / Aanvullende aankoop vereist. / Requiere compra adicional. / Requer compra adicional. / Ytterligere kjøp kreves. / Edellyttää lisäosien ostamista. / Supplerende kjøb nødvendig. / Ekstra kjøp kreves. / Wymagany dodatkowy zakup. / Vyžaduje dodatečný nákup. / Vyžaduje sa dokúpenie. / További vásárlás szükséges. / Необходима дополнительная покупка. / Απαιτείται επιπλέον αγορά. / Ek ürünü satın alması gerekir. / تتطلب شراء القطع الإضافية.

# REBUILD YOUR CARS INTO MONSTER TRUCKS! RÉASSEMBLE TES VOITURES POUR EN FAIRE DES MONSTER TRUCKS!

CONVIERTE TUS COCHES EN "MONSTER TRUCKS!" · TRANSFORMA OS SEUS CARROS EM MONSTER TRUCKS!  
FAHRZEUGE IN MONSTER TRUCKS UMBAUEN! · ПЕРЕСТРАИВАЙ СВОИ МАШИНКИ В МОHCТР-ТРАКИ!



HDJ95\*



HDJ93\*



HDJ94\*



HHD17\*



HHD18\*



TIGER SHARK™  
GVM26\*



HW 5 ALARM™  
HHD19\*



'83 CHEVY™ SILVERADO™  
HHL97\*



1



2



3

Most models can be built one at a time. La plupart des modèles peuvent être construits un à la fois. La mayoría de modelos se pueden construir de uno en uno. A maioria dos modelos pode ser construída separadamente. La maggior parte dei modelli possono essere realizzati uno per volta. Die meisten Modelle können eines nach dem anderen gebaut werden. Większości modeli nie da się budować jednocześnie z innymi. De meeste modellen kunnen één voor één gebouwd worden. Большинство моделей могут быть собраны по одной за раз. De fleste modeller kan bygges enkeltvis. De flesta modeller kan byggas en i taget. De fleste modellene kan bygges en om gangen. Useimmat mallit voidaan rakentaa yksi kerrallaan. Τα περισσότερα μοντέλα μπορούν να κατασκευασθούν ένα ένα. Modellerin çoğu ayrı ayrı inşa edilmeyi gerektirebilir. Většinou lze najednou sestavit pouze jeden model. Väčšina modelov môže byť zostavená iba raz. A modellek többségéből egyszerre csak egy építhető.ほとんどのモデルは、一度に一つを組み立てることができます。

يمكن تركيب التصميم الواحد تلو الآخر.  
大多數型號可一次性建構

2x  
AM77583APG



2x  
AM74397APG



2x  
AM03328KZ



1x  
AM11787F



1x  
AM15258KZ



1x  
AM80546F



1x  
AM81383F



1x  
AM09393KZ



1x  
AM09393ATT



5x  
AM17128KZ



1x  
AM78486AXW



2x  
AM72002KZ



5x  
AM17522KZ



2x  
AM03019APG



2x  
AM16843APG



2x  
AM15484KZ



1x  
AM03018ATT



1x  
AS-HHL95-05



1x  
AS-HHL95-04



4x  
AS-HHL95-09



2x  
AM72233APG



1x  
AM81259ATT



2x  
AM01314KZ



1x  
AM01314ATT



3x  
AM80966KZ



1x  
AM81382KZ



1x  
AM81381KZ



1x  
AM03772KZ



2x  
AM03772ATT



1x  
AM16384ATT



1x  
AM03873ATT



1x  
AM03873F



2x  
AM74399KZ



2x  
AM74398KZ



1x  
AS-HHL95-03



1x  
AM81163KZ



2x  
AM81163ATT



2x  
AM07475KZ



2x  
AM07475ATT



3x  
AM17793KZ



1x  
AS-HHL95-07



2x  
AM80971F



1x  
AM80538AAV



1x  
AM80969KZ



1x  
AM80965KZ



1x  
AS-HHL95-06



1x  
AM80968KZ



1x  
AS-HHL95-01



1x  
AS-HHL95-02



1x  
AS-HHL95-08



1x  
FIG-HHL95-A



1x  
AS-HHL95-09



**Missing pieces? • Pièces manquantes?**

¿Partes faltantes? • Perdeu peças?  
 Fehlen Teile? • Не хватает деталей?

[support.megabrand.com](http://support.megabrand.com)

Mattel Europa B.V., Gondel 1, 1186 MJ Amstelveen, Nederland. Mattel U.K. Limited, The Porter Building, 1 Brunel Way, Slough SL1 1FQ, UK. Mattel France, Parc de la Cerisaie, 1/3/5 allée des Fleurs, 94260 Fresnes Cedex. N° Cristal 0969 36 99 99 (Numéro non surtaxé) ou www.lesjouetsmattel.fr Mattel Belgium, Trade Mart, Atomiumsquare, Bogota 202 – B 275, 1020 Brussels. Gratis nummer België: 0800 – 16 936 - Gratis nummer Luxemburg: 800 - 22 784 - Gratis nummer Nederland: 0800 - 262 88 35. Deutschland : Mattel GmbH, Solmsstraße 83, D-60486 Frankfurt am Main. Schweiz: Mattel AG, Kirchstrasse 24, CH-3097 Liebefeld. Österreich: Mattel Ges.m.b.H., Campus 21, Liebermannstraße A01 404, A- 2345 Brunn/Gebrige. Mattel Italy Srl, Via Turati 4, 20121 Milano, Italy. Servizio assistenza clienti: Customersrvitalia@mattel.com - Numero verde 800 11 37 11. Mattel España, S.A. Aribau 200 pl. 9, 08036 Barcelona. cservice.spain@mattel.com Tel.: +34 933 06 79 00 http://www.service.mattel.com/evs. Mattel East Asia Ltd., Room 503-09, North Tower, World Finance Centre, Harbour City, Tsimshatsui, HK, China. Tel.: (852) 3185-6500. Diimport & Diedarkan Oleh: Mattel Continental Asia Sdn Bhd. Level 19, Tower 3, Avenue 7, No. 8 Jalan Kerinchi, Bangsar South, 59200 Kuala Lumpur, Malaysia. Mattel South Africa (PTY) Ltd. Office 10213, 30 Melrose Boulevard, Johannesburg 2196. Dystrybutor: Mattel Poland Sp. z o.o., Warsaw Trade Tower 34 p., ul. Chłodna 51, 00-867 Warszawa. Mattel Australia Pty. Ltd., 658 Church St., Richmond, Victoria, 3121. Consumer Advisory Service - 1300 135 312. Mattel AEBE, Εθνικού Μακρικού 1, Κτήριο Κ-2, ΤΚ 17561, Πλακιά Φάληρο. Mattel Oyuncakçılık Tic. Ltd. Şti. İçerenköy Mah. Umut Sok. No:10-12 Quick Tower Kat:2/15 34752 Ataşehir İstanbul Tel: 0216 570 75 00. Импортёр/Уполномоченная организация: ООО "МАТТЕЛ" Российская Федерация, 105120 Москва, 2-й Сыромятинский переулочк 1; +7 495 287 79 39. Mattel Czech Republic s.r.o., The Forum, Václavské nám. 19, 11000 Praha 1. Mattel, 333 Continental Boulevard, El Segundo, CA 90245, USA. Consumer Services: 1-800-465-MEGA (6342). Mattel Canada Inc., Mississauga, Ontario L5R 3W2. Consumer Services: You may call us free at/ Composez sans frais le 1-800-524-8697. Importado y distribuido por Mattel de México, S.A. de C.V., Miguel de Cervantes Saavedra No. 193, Pisos 10 y 11, Col. Granada, Alcaldía Miguel Hidalgo, C.P. 11520, México, Ciudad de México. R.F.C. MME-920701-NB3. Tels: 59-05-51-00 Ext. 5206 ó 01-800-463-59-89. Mattel Chile, S.A., Avenida América Vespuccio 501-B, Quilicura, Santiago. Tel.: 1230-020-6213. Servicio al consumidor Venezuela: Tel: 0-800-100-9123. Mattel Argentina, S.A., Av. Libertador 1000, Piso 11 – Oficinas 109 y 111, Vicente López – Prov. Buenos Aires. Tel: 0800-666-3373. Mattel Colombia, S.A., Calle 123#7-07 P5, Bogotá. Tel: 01800-710-2069. Mattel Perú, S.A., Av. Juan de Arona # 151, Centro Empresarial Juan de Arona, Torre C, Piso 7, Oficina 704, San Isidro, Lima 27, Perú. RUC: 20425853865. Reg. Importador: 02350-12-JUE-DIGESA. Tel: 0800-54744. E-mail Latinoamérica: servicio.clientes@mattel.com. Mattel do Brasil Ltda.- CNPJ : 54.558.002/0001-20 - Rua Verbo Divino, 1488 - 2º Andar - 04719-904 - Chácara Santo Antônio - São Paulo - SP - Brasil. Serviço de Atendimento ao Consumidor: fone 0800 575 0780. E-mail: sac.matteldobrazil@mattel.com

**ATTENTION : DANGER**  
D'ÉTOUFFEMENT. - PRÉSENCE DE PETITS  
ÉLÉMENTS. NE CONVIENT PAS AUX ENFANTS DE  
MOINS DE 3 ANS.

**ATENÇÃO!** NÃO INDICADO / NÃO  
RECOMENDÁVEL PARA CRIANÇAS MENORES DE 3  
(TRÊS) ANOS POR CONTER PARTE(S) PEQUENA(S)  
QUE PODE(M) SER ENGOLIDA(S) OU ASPIRADA(S)  
PODENDO PROVOCAR ASFIXIA.

警告:

のどにつまる危険 小さな部品が含まれています  
3歳以下の子供には与えないで下さい。

**警告!**

不适合3岁以下儿童使用。  
内含小零件。

⚠ **WARNING : CHOKING HAZARD.** - Small parts.

Not for children under 3 years.

**ADVERTENCIA: PELIGRO DE ATRAGANTAMIENTO.** Jugue no recomendado  
para menores de 3 años, porque contiene piezas pequeñas que podrían  
provocar asfixia en caso de ser ingeridas o inhaladas por el/la niño/a.

**AVVERTENZA:** Contiene pezzi di piccole dimensioni.

**ACHTUNG:** Kleine Teile.

**OSTRZEŻENIE:** Małe części. Niebezpieczeństwo zadławienia.

**WAARSCHUWING:** Kleine onderdelen

**ПРЕДУПРЕЖДЕНИЕ:** Мелкие детали.

**ADVARSSEL:** Indeholder små dele.

**WARNING:** Små delar

**ADVARSSEL:** Små deler

**VAROITUS:** Pieniä osia

**ΠΡΟΣΟΧΗ:** Περιλαμβάνονται μικρά κομμάτια.

**UYARI:** Küçük parçalar.

**UPOZORNĚNÍ:** Malé díly

**UPOZORNENIE:** Malé časti

**FİGyelmeztetés:** Kis alkatrészek.



تحذير:

غير مناسبة للأطفال دون 36 شهرًا - قطع صغيرة.

# BUILD YOUR WAY BY COMBINING MEGA™ HOT WHEELS® SETS CRÉEZ VOTRE UNIVERS EN ASSOCIANT LES COFFRETS HOT WHEELS® MEGA™



HHD18

HHL97

HDJ95

HHL98

HHL96

HHL95

CONSTRUYE EL RETO COMBINANDO LOS CONJUNTOS DE HOT WHEELS® DE MEGA™  
CONSTRUA O DESAFIO COMBINANDO OS CONJUNTOS MEGA™ HOT WHEELS®  
EIGENE STRECKEN BAUEN DURCH DAS KOMBINIEREN VON MEGA HOT WHEELS SETS  
СТРОИТЕ ПО-СВОЕМУ, ОБЪЕДИНЯЯ НАБОРЫ MEGA™ HOT WHEELS®

Set(s) sold separately and subject to availability. / Ensemble(s)  
vendu(s) séparément. Certains produits peuvent ne pas être  
commercialisés. / Se vende(n) por separado y está(n) sujeto(s) a disponibilidad. / Conjunto(s)  
vendido(s) em separado e sujeito(s) à disponibilidade. / Set(in) vendita separatamente, secondo disponibilità.  
/ Das/Die Set(s) sind separat erhältlich. / Zestaw(y) sprzedawany(e) oddzielnie w zależności od dostępności.  
/ Set(s) apart verkrijgbaar en afhankelijk van beschikbaarheid. / Набор(-ы) продаются отдельно, при  
наличии. / Sæt sælges separat og så længe lager haves. / Seten säljs separat så länge lagret räcker. /  
Settet/settene selges separat så langt lageret rekker. / Pakkaus/pakkukset myydään erikseen, saatavuus  
voi vaihdella. / Το(α) σετ πωλούνται ξεχωριστά και ανάλογα με τη διαθεσιμότητα. / Setler ayrı olarak satılır  
ve stoklarla sınırlıdır. / Set (sety) se prodává (prodávají) samostatně dle aktuální nabídky. / Súprava/-y sa  
predáva(jú) samostatne a podľa dostupnosti. / A készlet(ek) külön kapható(k), az elérhetőség változhat.  
/ セット商品は別売りになります。在庫状況は別途ご確認をお願いします。 /  
تباع المجموعة أو المجموعات على حدة وتخضع لظروفها.  
每套单独发售，按供货情况决定。

©2021 MEGA Brands &™ MEGA Brands.  
Printed in China / Imprimé en Chine

1186 MJ, 1, NL  
AD-HHL95-01A



OFFICIAL  
LICENSED

General Motors Trademarks used  
under license to Mattel, Inc.

HOT WHEELS® and associated trademarks  
and trade dress are owned by, and used  
under license from, Mattel. ©2021 Mattel.

**Mattel Canada Inc.** Mississauga,  
Ontario L5R 3W2.

MADE IN CHINA. FABRIQUÉ EN CHINE. **FABRICADO NA CHINA.**  
HECHO EN CHINA. ИЗГОТОВЛЕНО В КИТАЕ. ÇIN'DE  
ÜRETİLMİŞTİR. صنع في الصين.

Ⓟ D714,887

