

MEGA™

POKÉMON™



HXF80

**FERRIS WHEEL FUN
UN TOUR DANS LA GRANDE ROUE**

DIVERSIÓN EN LA NORIA / DIVERSÃO NA RODA-GIGANTE
SPASS AUF DEM RIESENRAD / КОЛЕСО ОБЪЗРЕНИЯ



BUILD WITH MOTION

CONSTRUIS UN MONDE EN MOUVEMENT

CONSTRUYE CON MOVIMIENTO
CONSTRUÇÃO COM MOVIMENTO
BAUEN MIT AKTION
СТРОЙ С ДВИЖЕНИЕМ



GET INSTRUCTIONS ONLINE INSTRUCTIONS DISPONIBLES EN LIGNE

CONSULTA LAS INSTRUCCIONES EN LÍNEA
OBTEN INSTRUÇÕES ONLINE
ANWEISUNGEN ONLINE ERHÄLTICH
ИНСТРУКЦИИ ДОСТУПНЫ ОНЛАЙН



megaunboxed.com

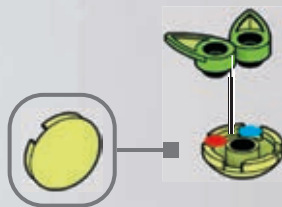
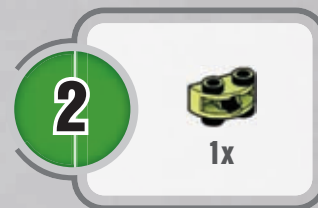
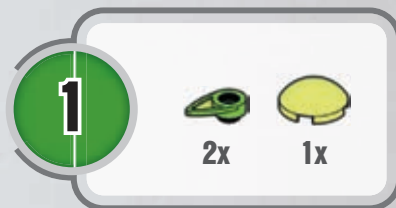

3

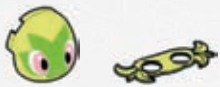

1x 1x



1 2

4



1x 1x 1x

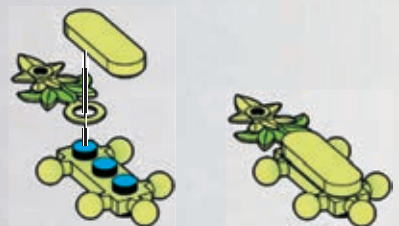

1 2

5



1x 1x

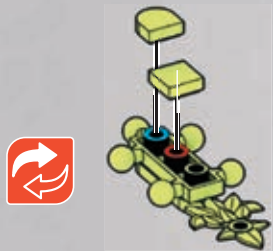

6



1x



1 2 3

7



4x



4x



1

2

x4

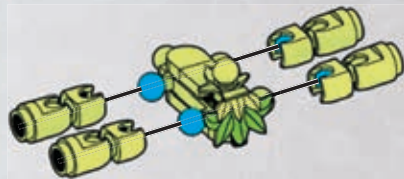

1



2



3

8



1x



1x



1x



1



2

9



1x



1x



1



2

10

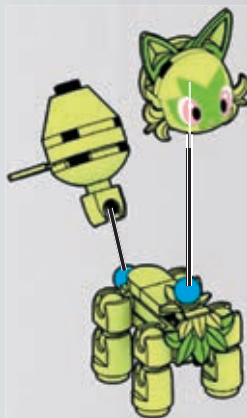

1



2



11

3x 2x 1x 1x

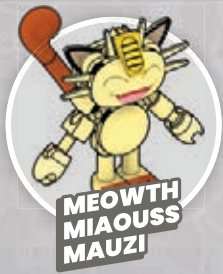

x2

1 2

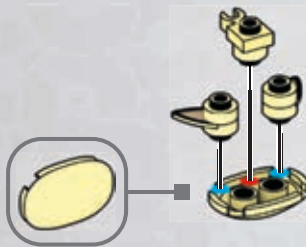

12

1x

13

1x 1x

14

1x

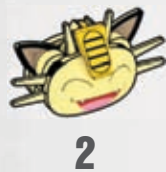

15

2x 1x 1x

16

1x



17



2x

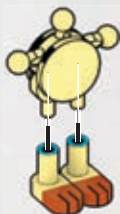

18



2x

2x



1



2



3

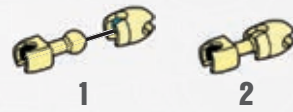

1

2

x2

19

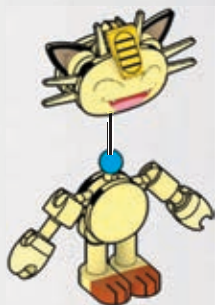

1



2

20

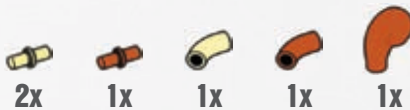

2x

1x

1x

1x

1x

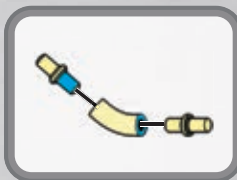

1



2

21



1



2



3



**PALDEAN WOOPER
AXOLOTO DE PALDEA
FELINO-PALDEA**

22

2x 1x

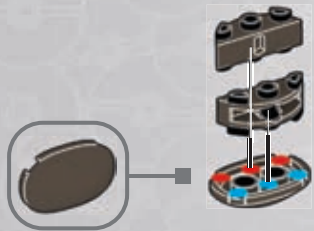

23

1x 1x

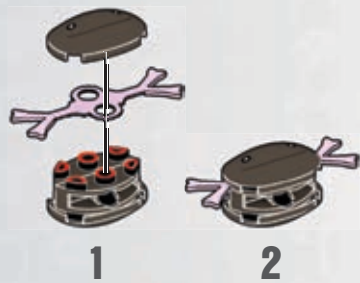

24

2x 1x 1x

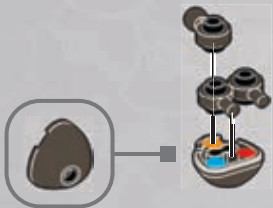

25

1x



26

2x



27

1x 1x 1x

1 2

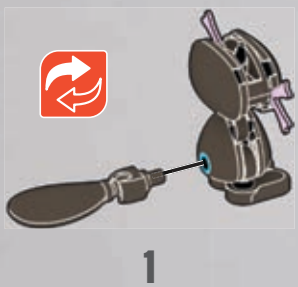



28

1x 1x 1x

29

1x

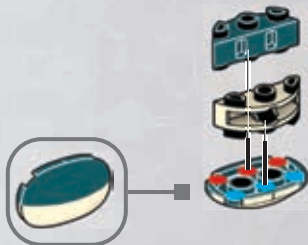

30

2x 2x

31

2x 1x 1x 1x

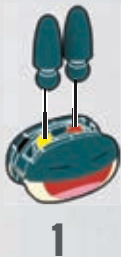

32

2x 2x

33

2x 2x

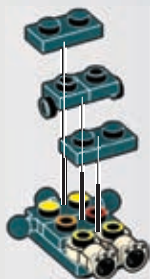

1 2

x2



34

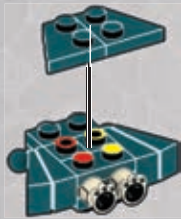

35

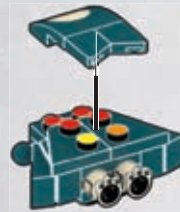

36

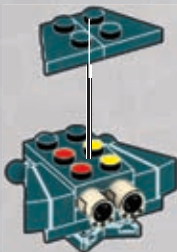

37



38



39





40

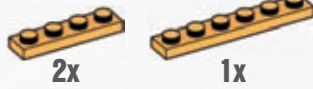

2x

1x

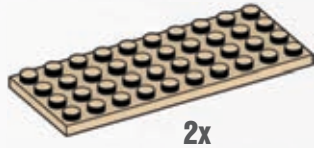

2x

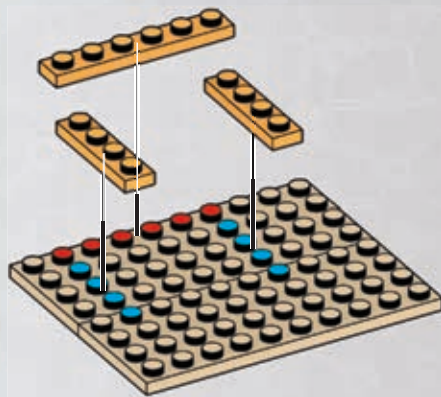

41



1x

2x

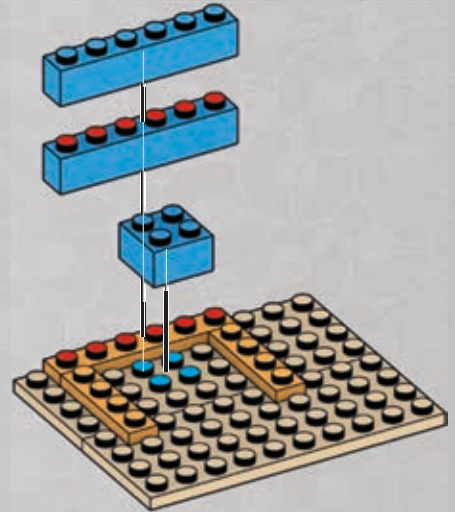

42



2x

2x

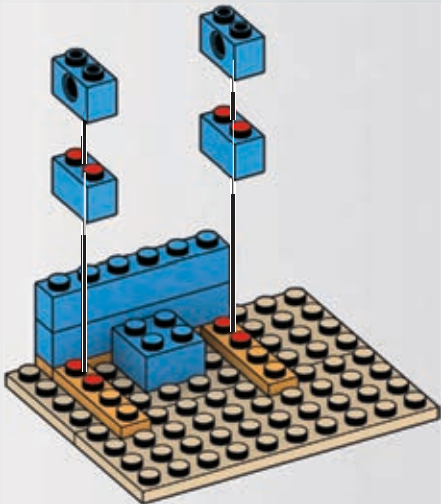

43



1x

1x

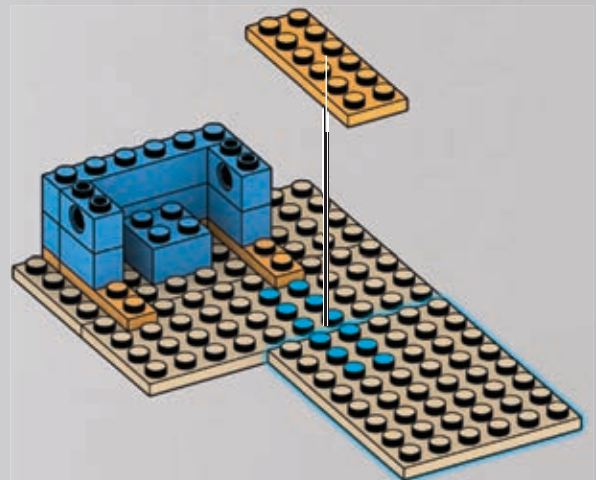

44



2x

1x

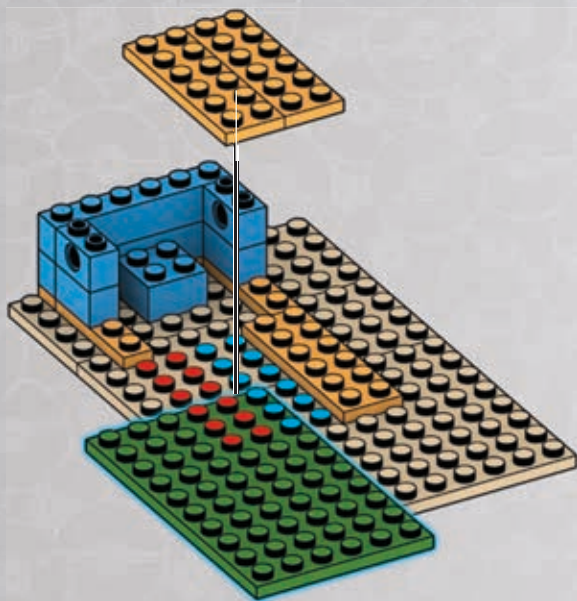

45



2x

1x

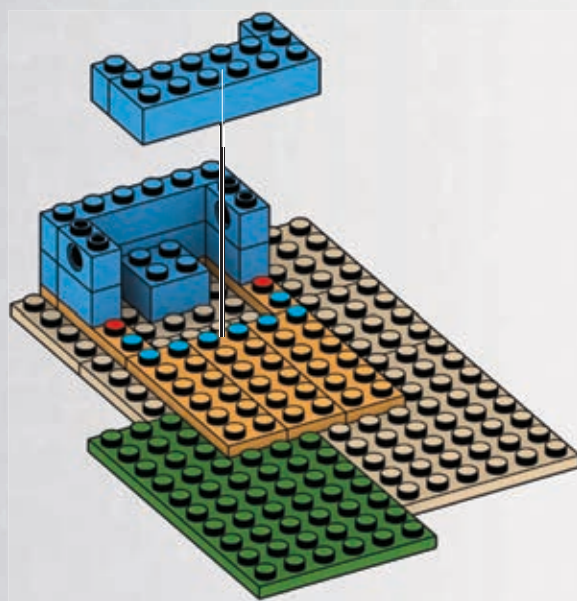

46



1x

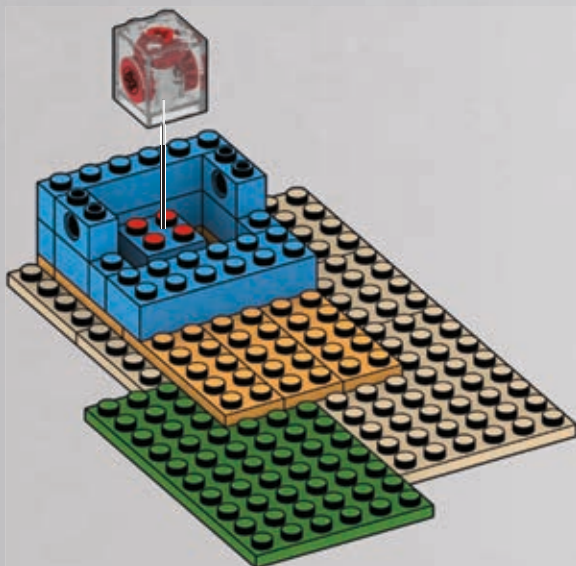

47



3x

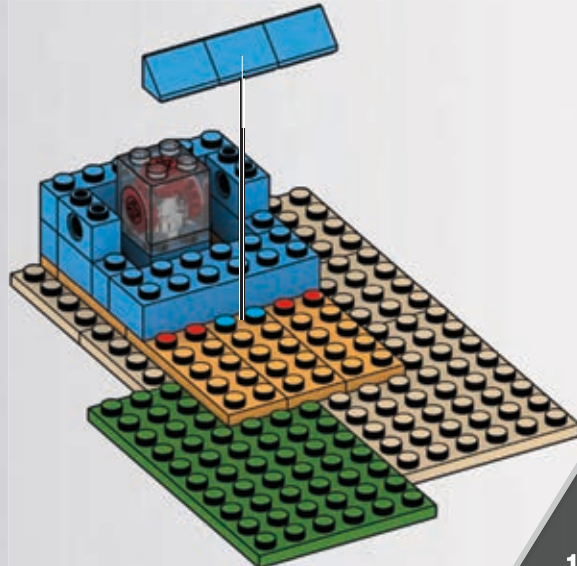

48

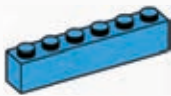

1x



1x

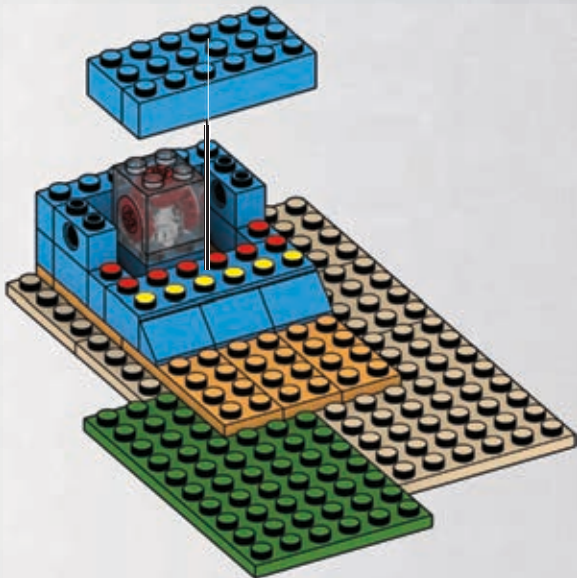

49



2x



2x

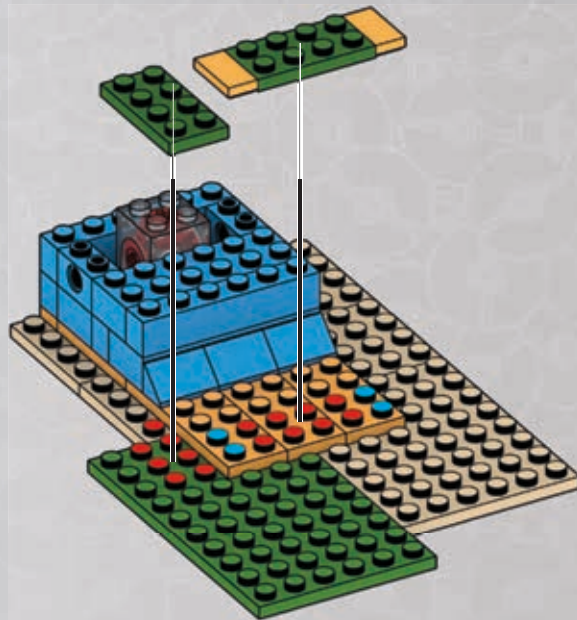

50



2x

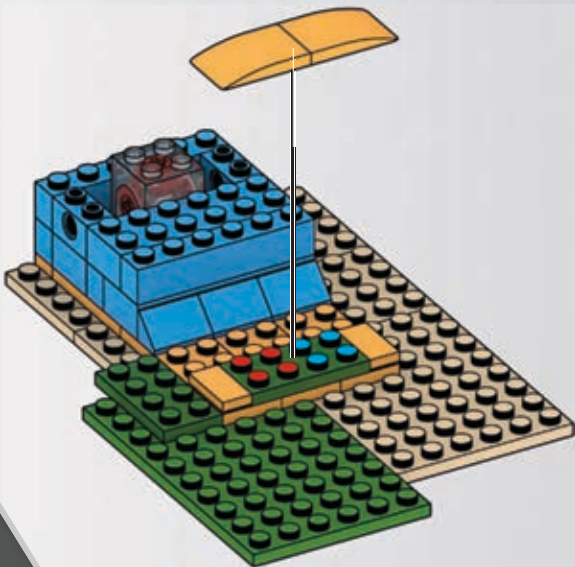

51



2x



2x

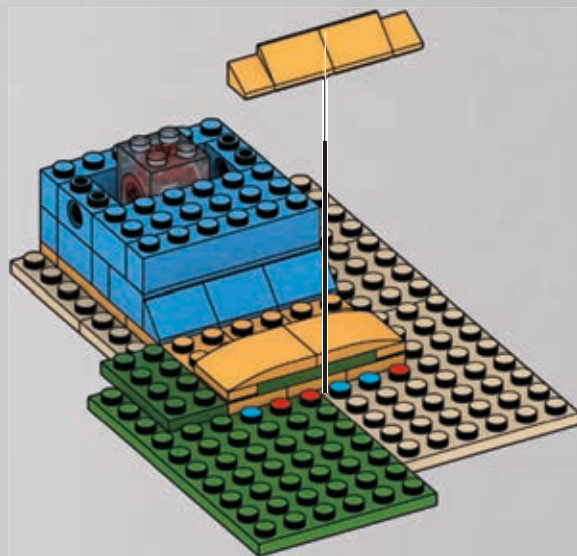

52



2x

1x

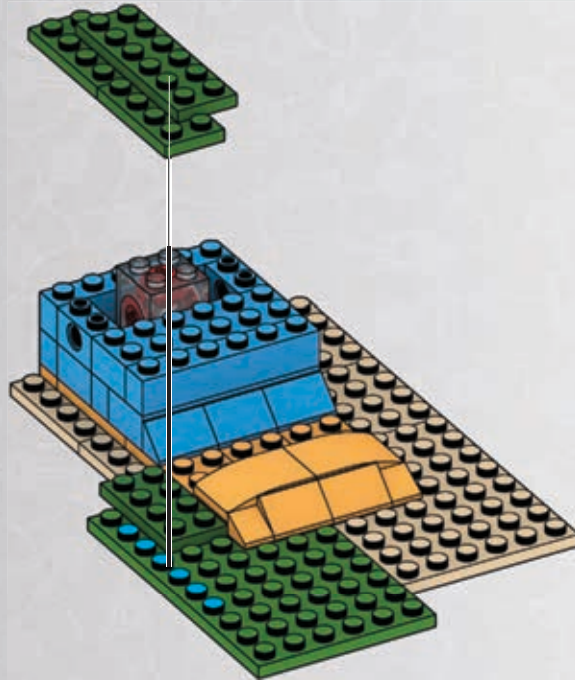
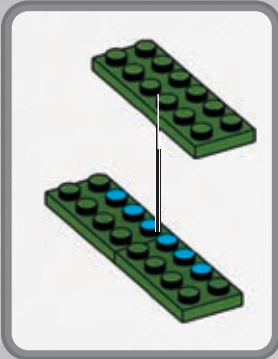

53



1x

1x

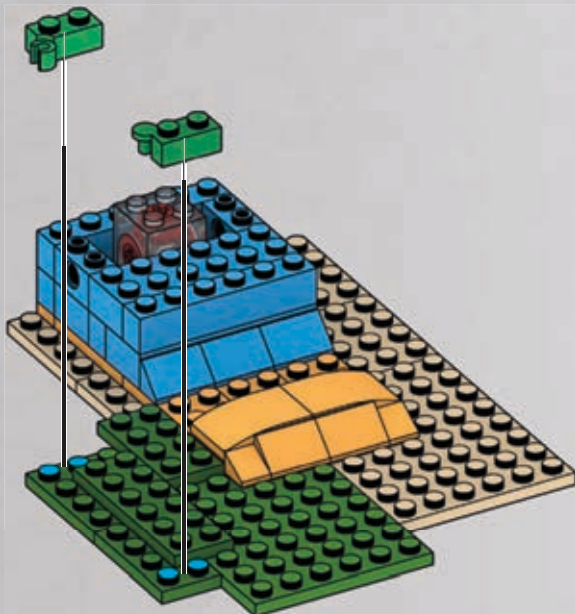

54



1x

1x

1x

1x

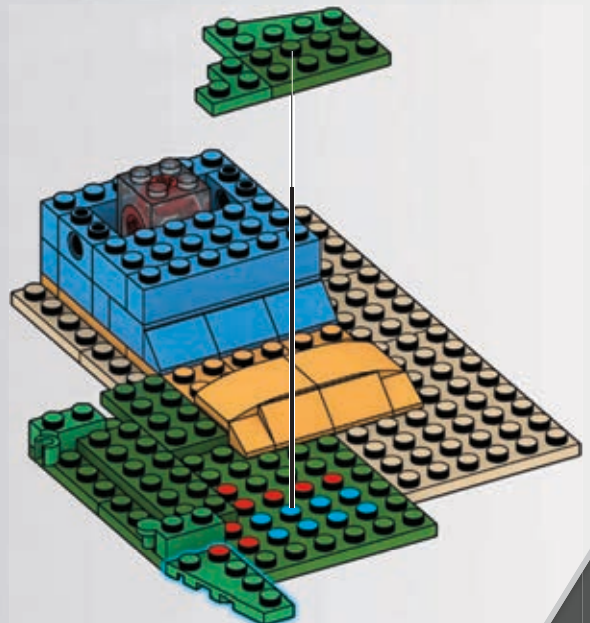

55
2x

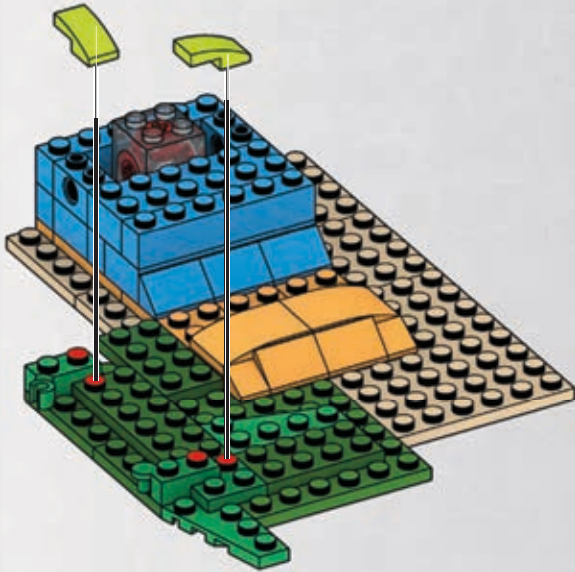

56
1x 1x 1x

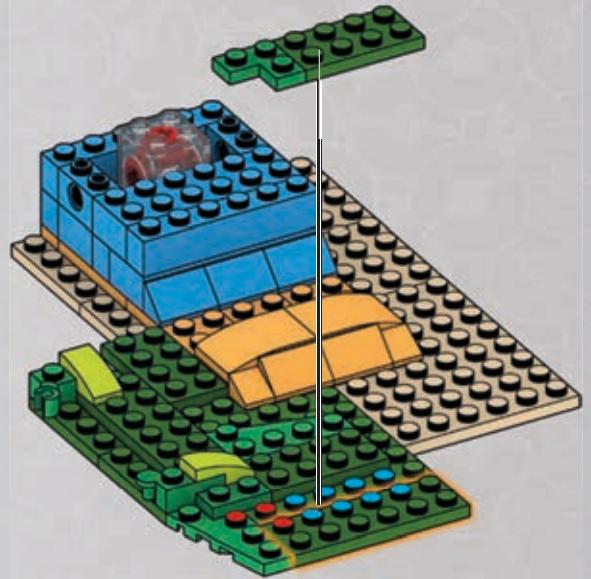

57
1x 1x 1x 1x

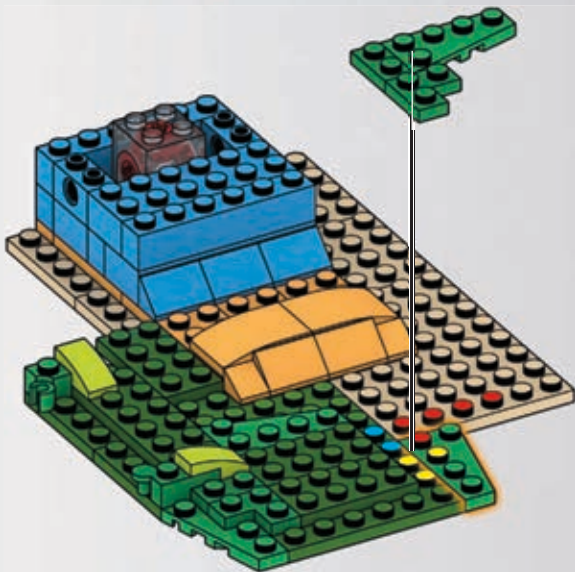

58
1x 1x

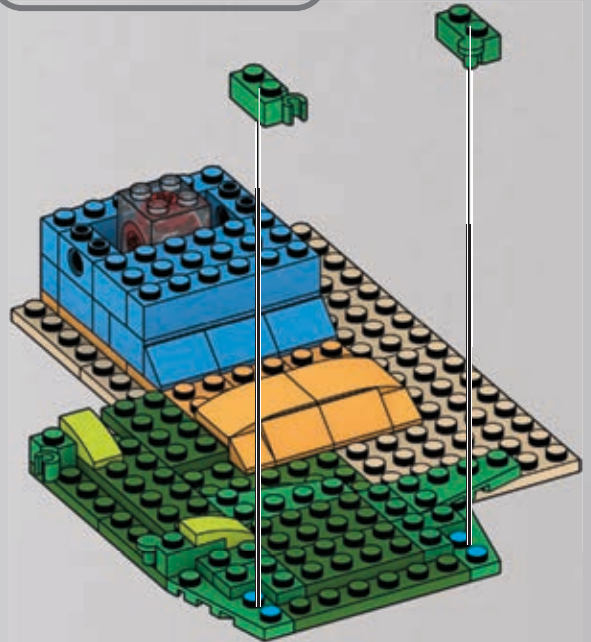

59



3x

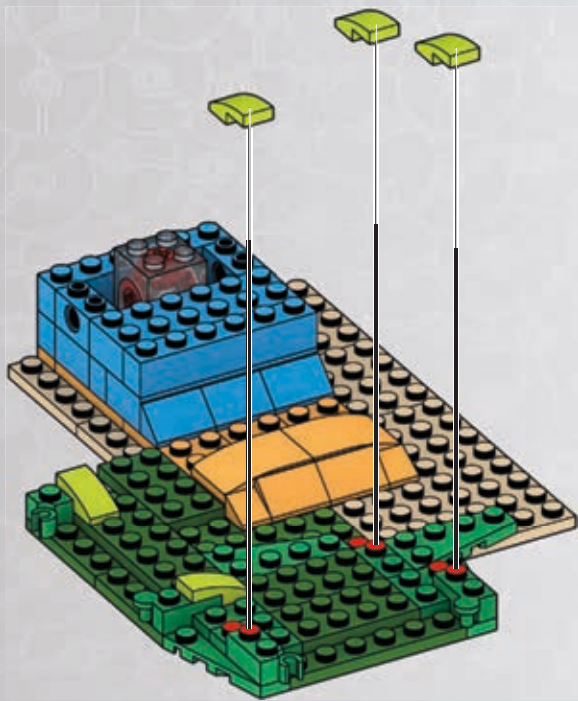

60

2x 1x 1x 1x

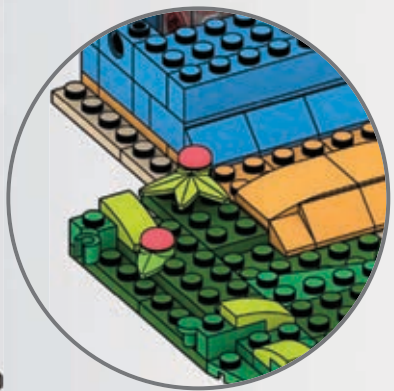
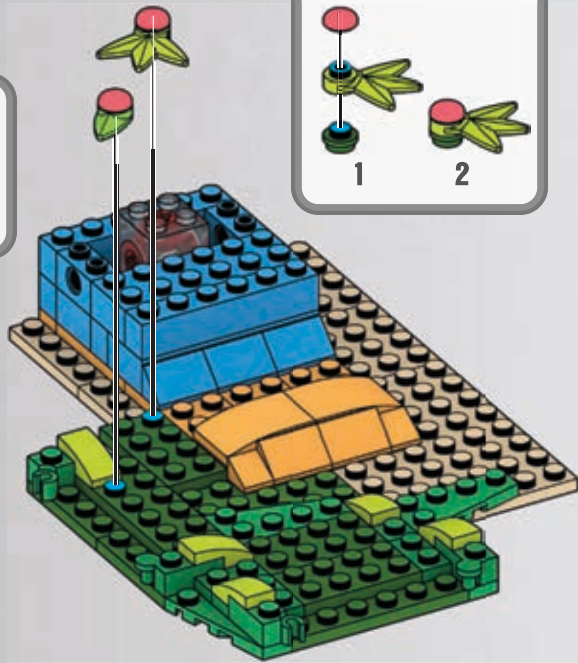
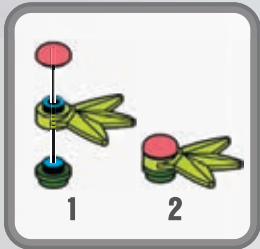
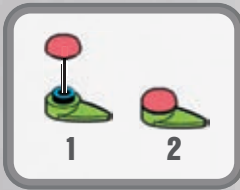

61



1x



1x

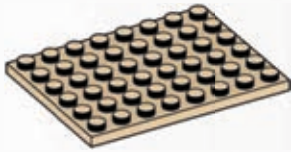

1x

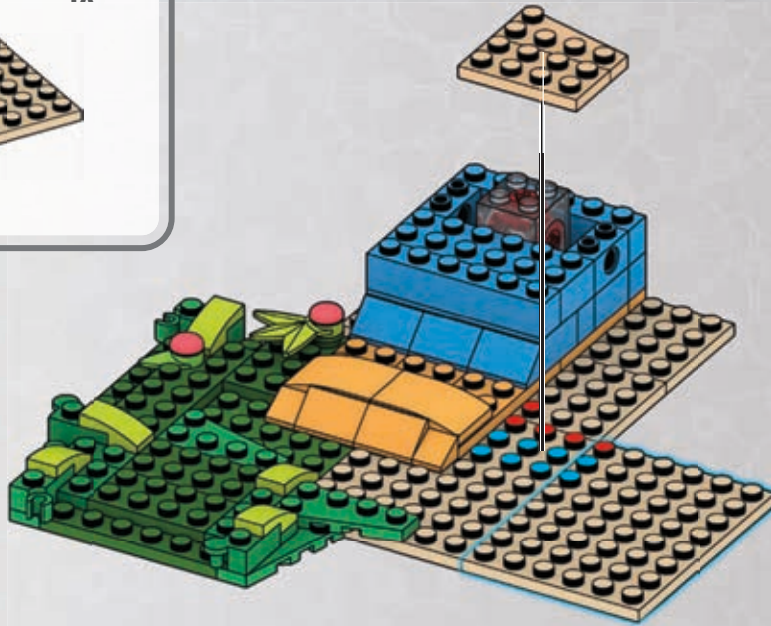

62



2x



1x

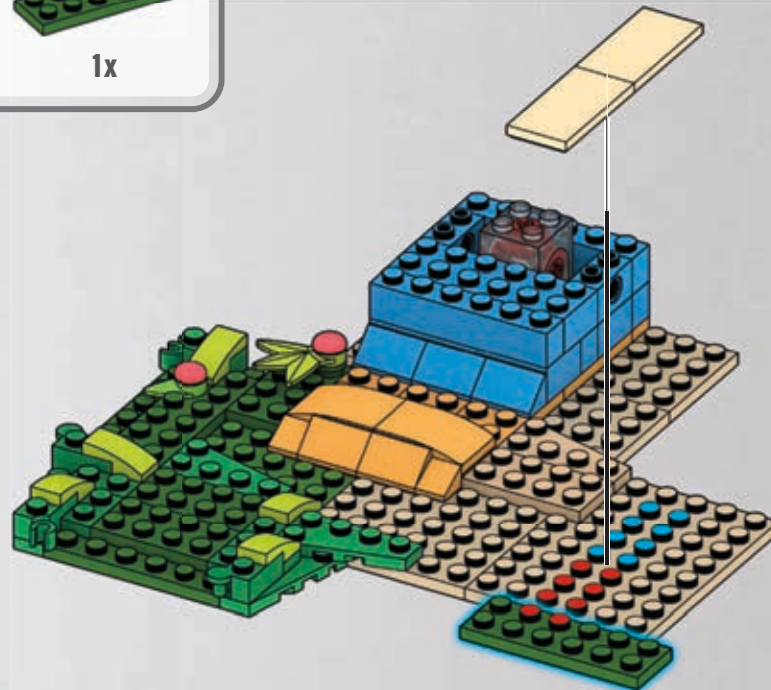

63



2x



1x

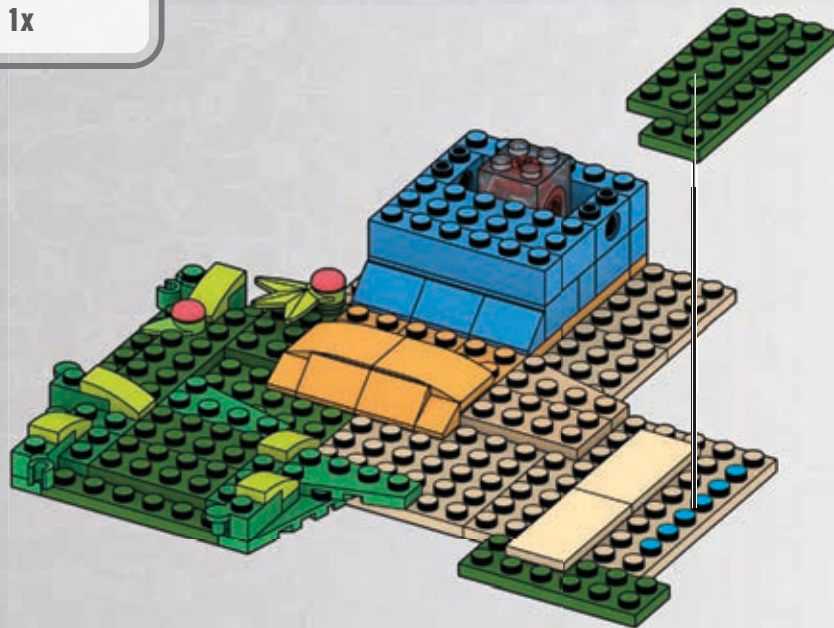
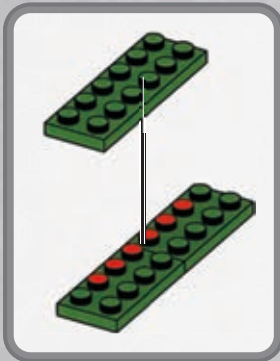

64



1x



1x

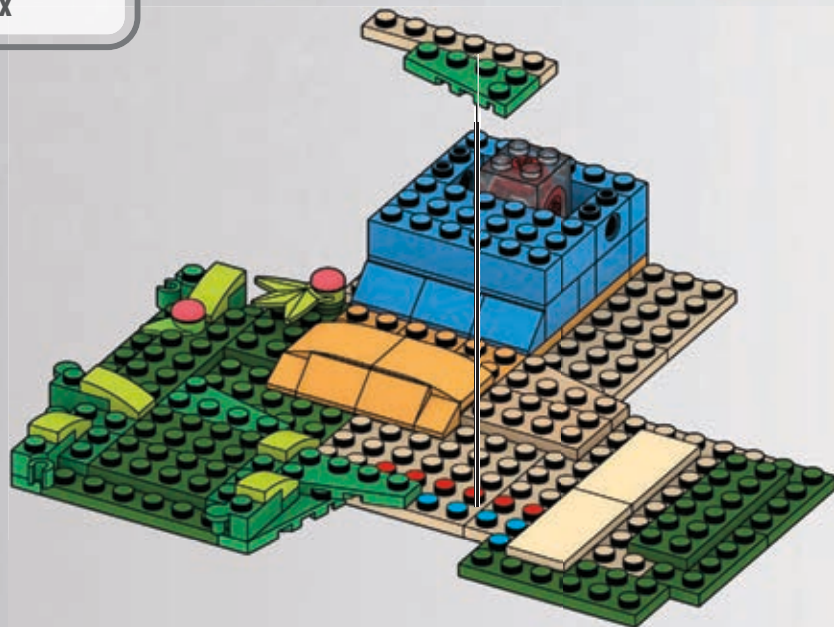

65



2x



1x



1



2

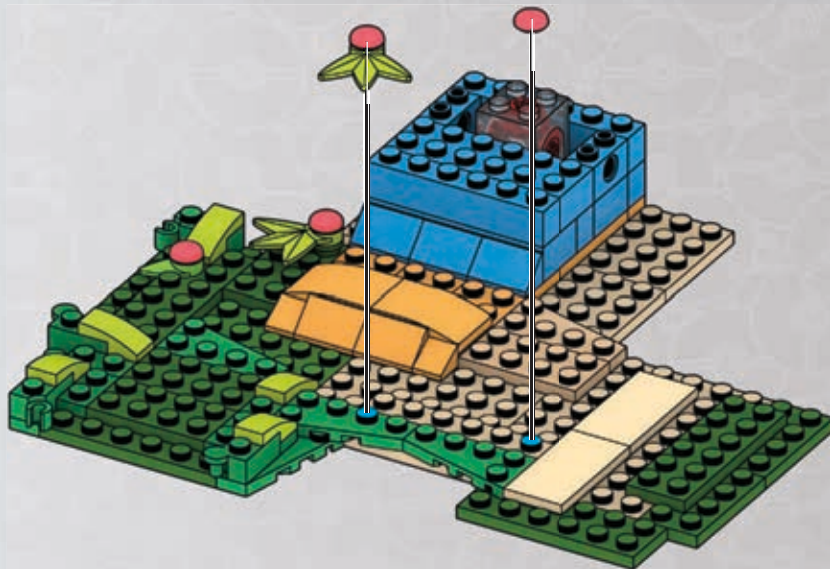

66



1x



1x



1x

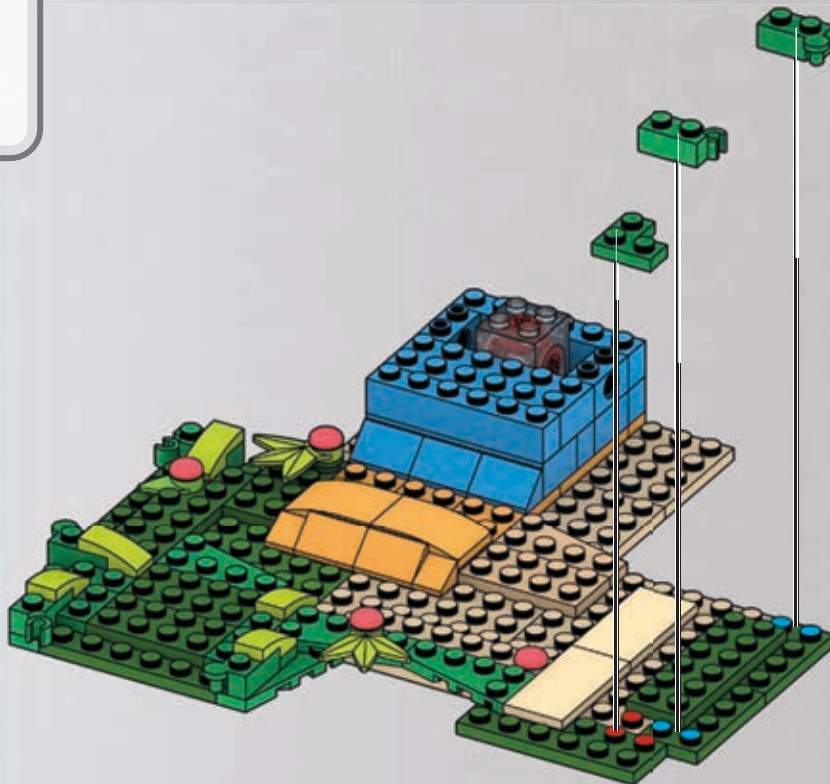

67



3x

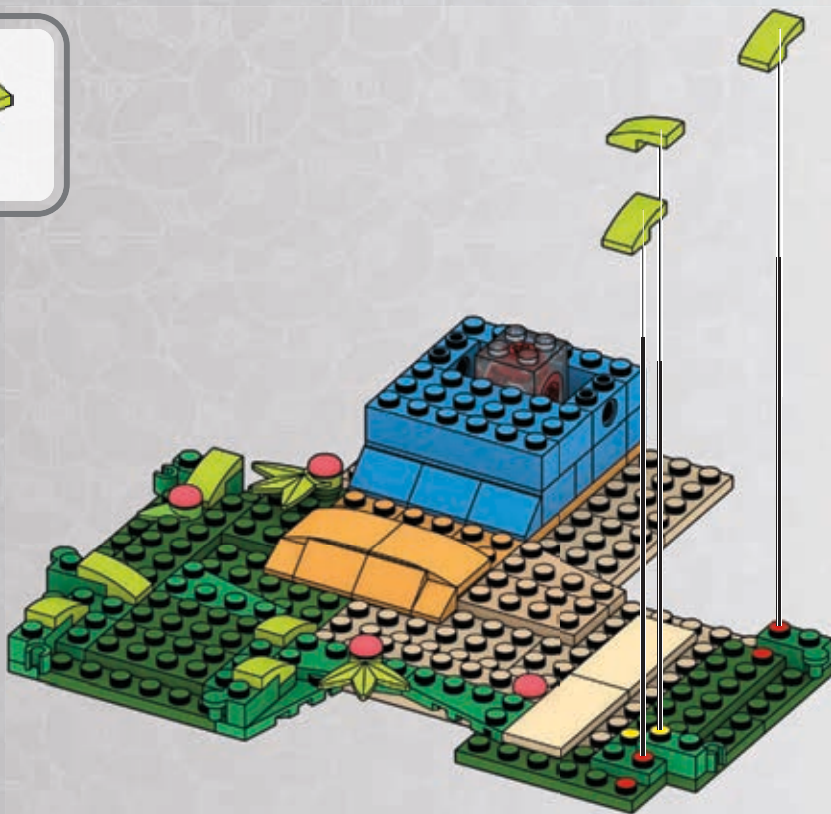

68



2x



2x



1x

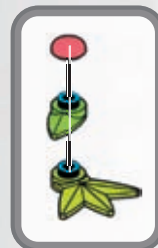
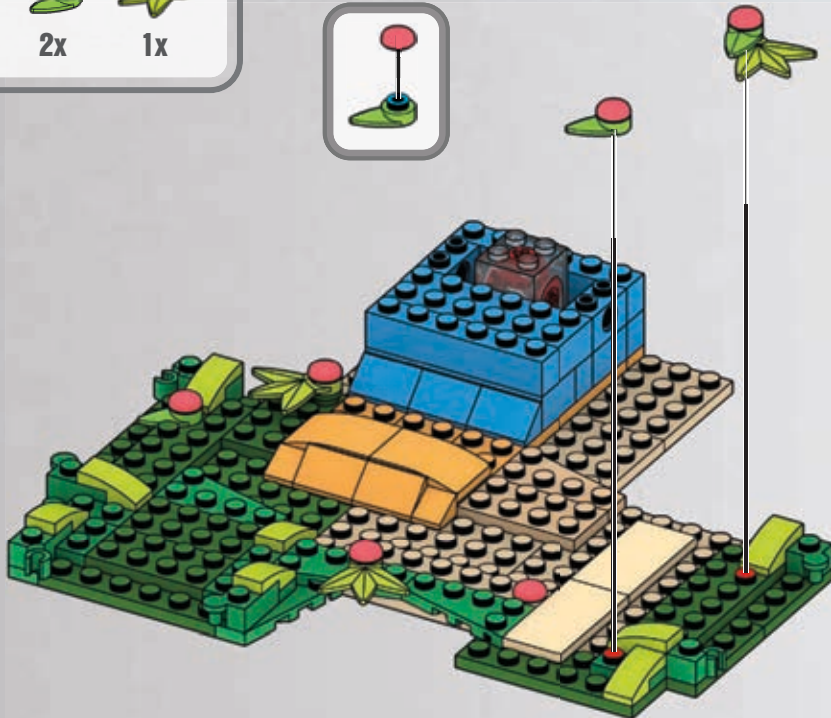

69



1x



2x



1x

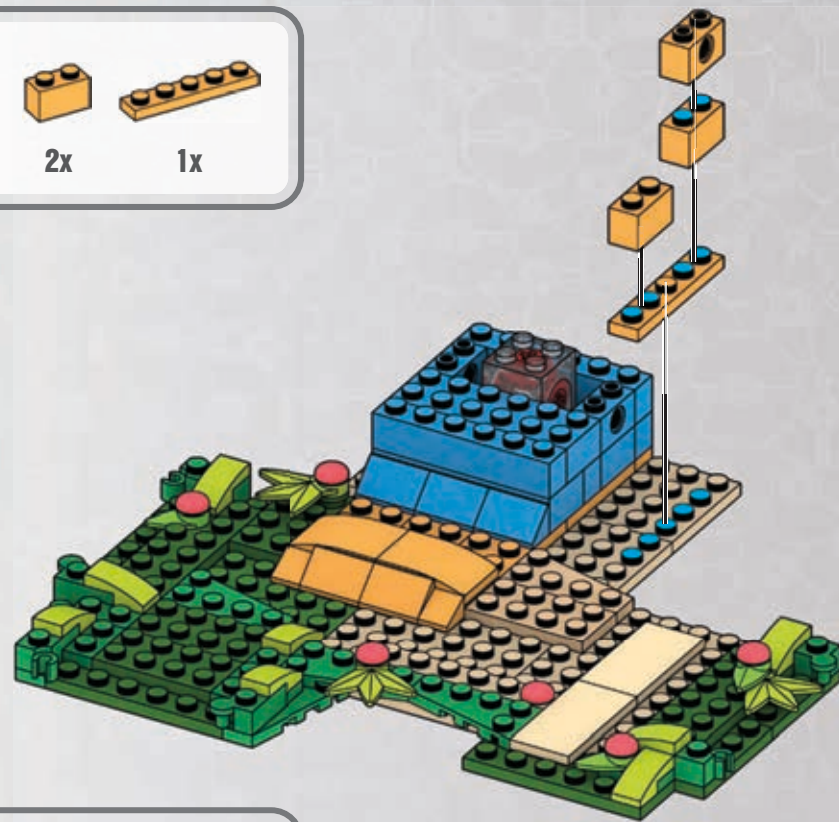

70



1x



1x

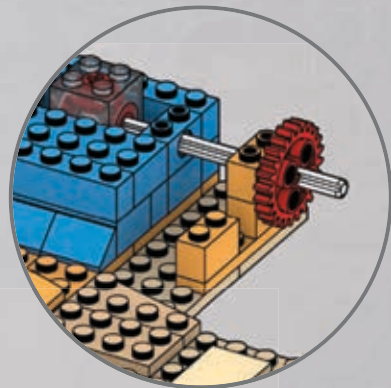
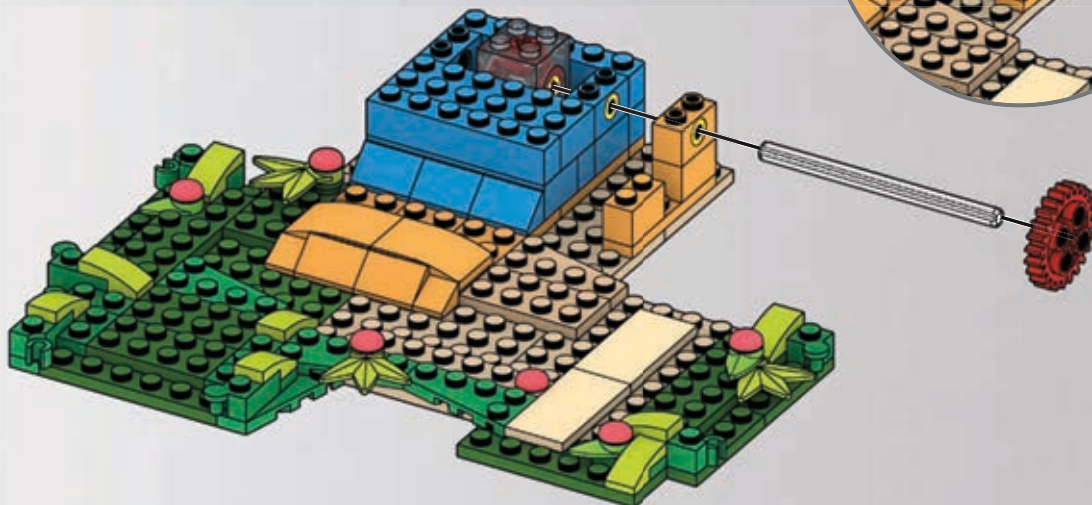

71

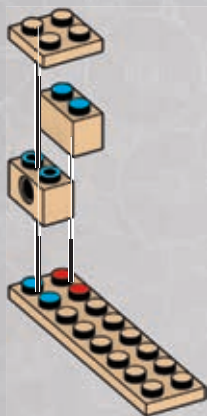

72

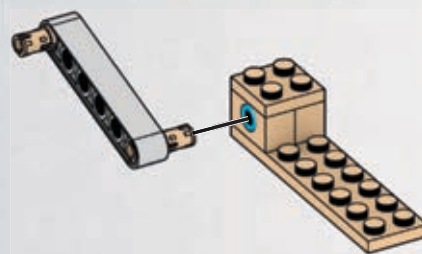
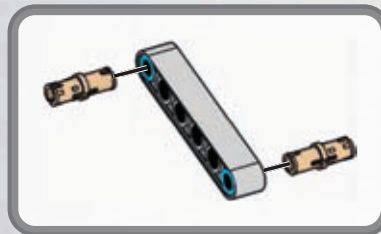

73

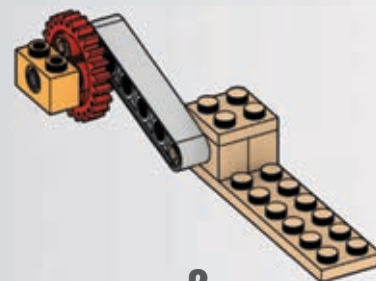
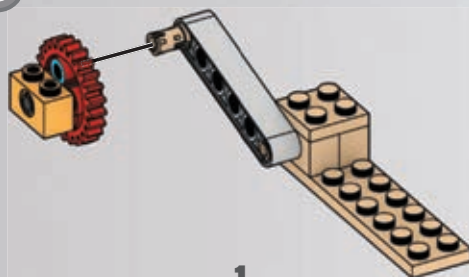
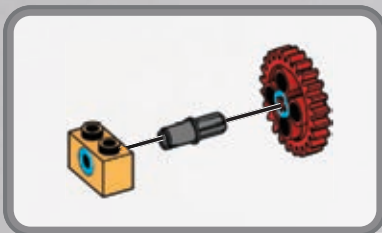
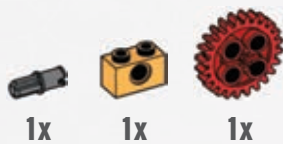

74

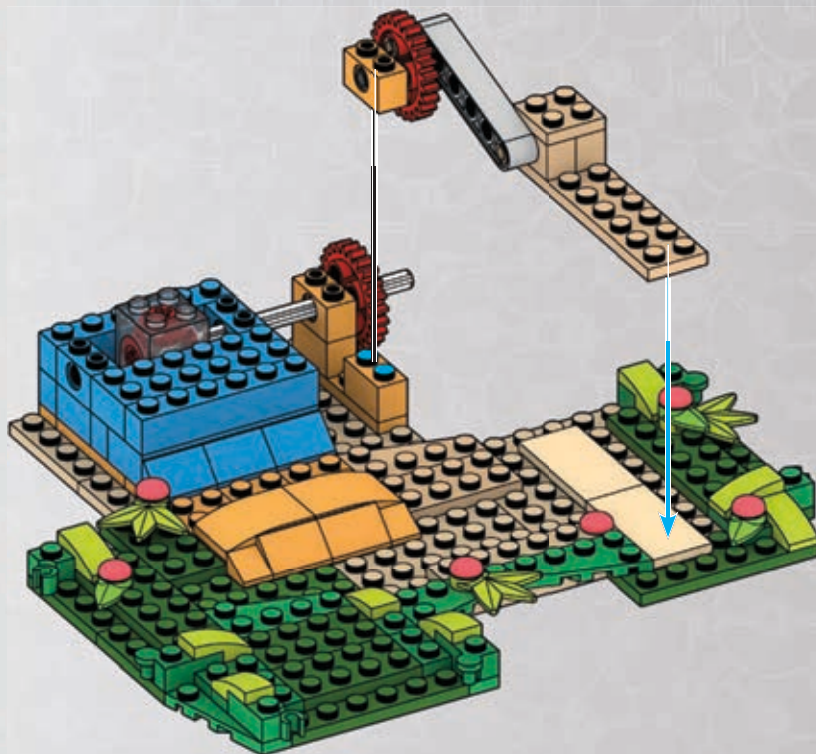

75



1x

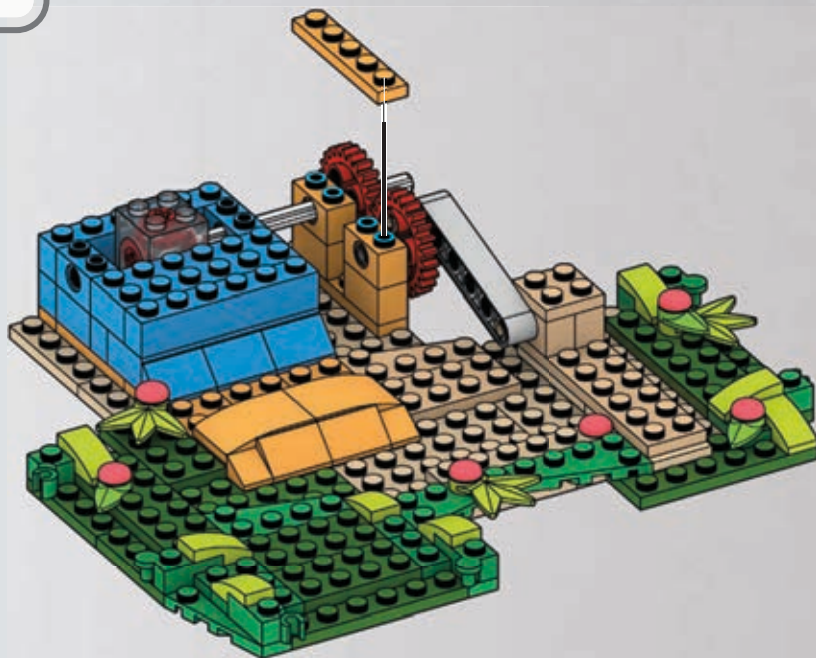

76



2x



1x



77

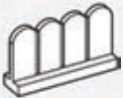

1x

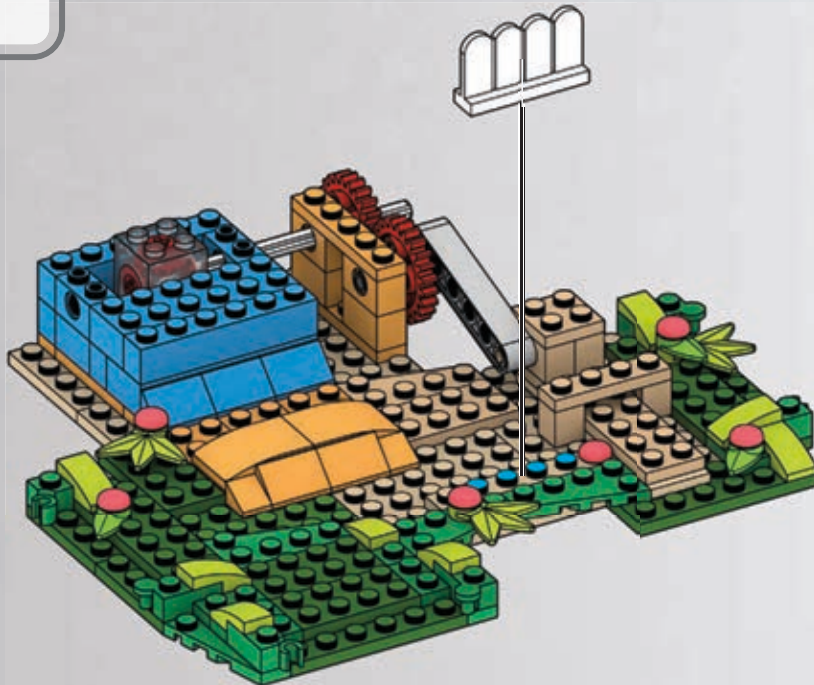

78



4x

1x

1x

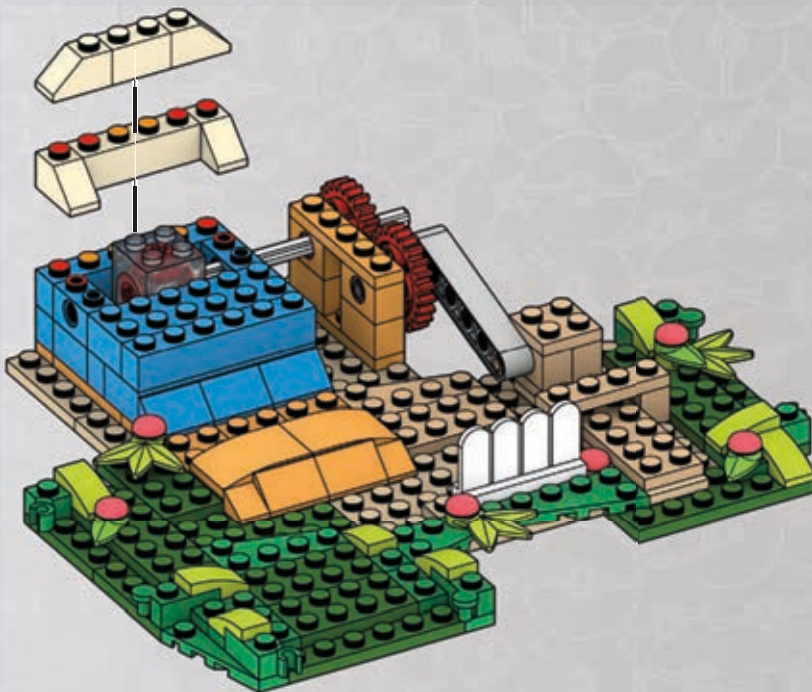

79



2x

2x

1x

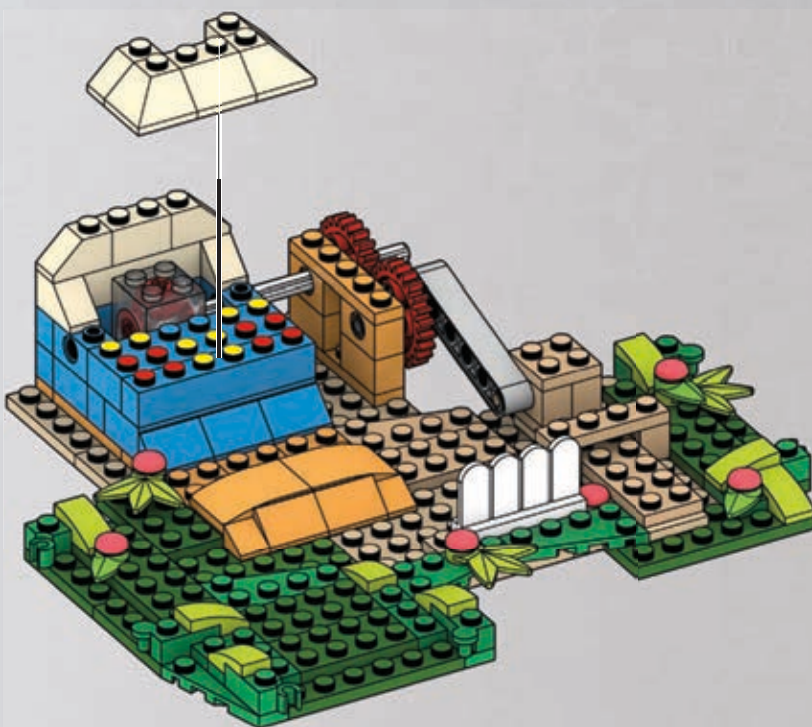

80

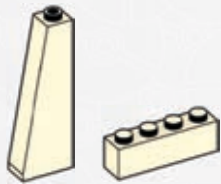

2x

1x

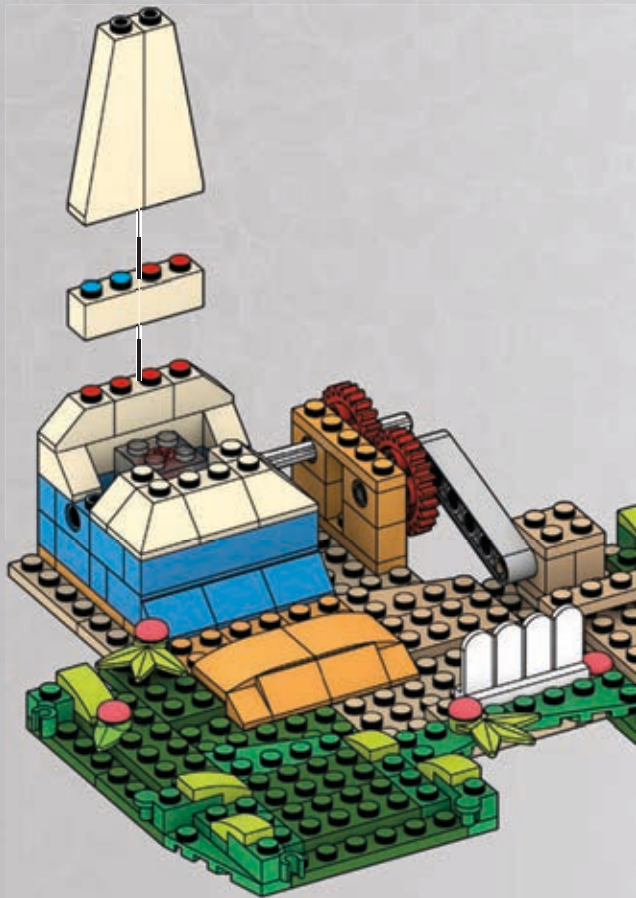

81



1x

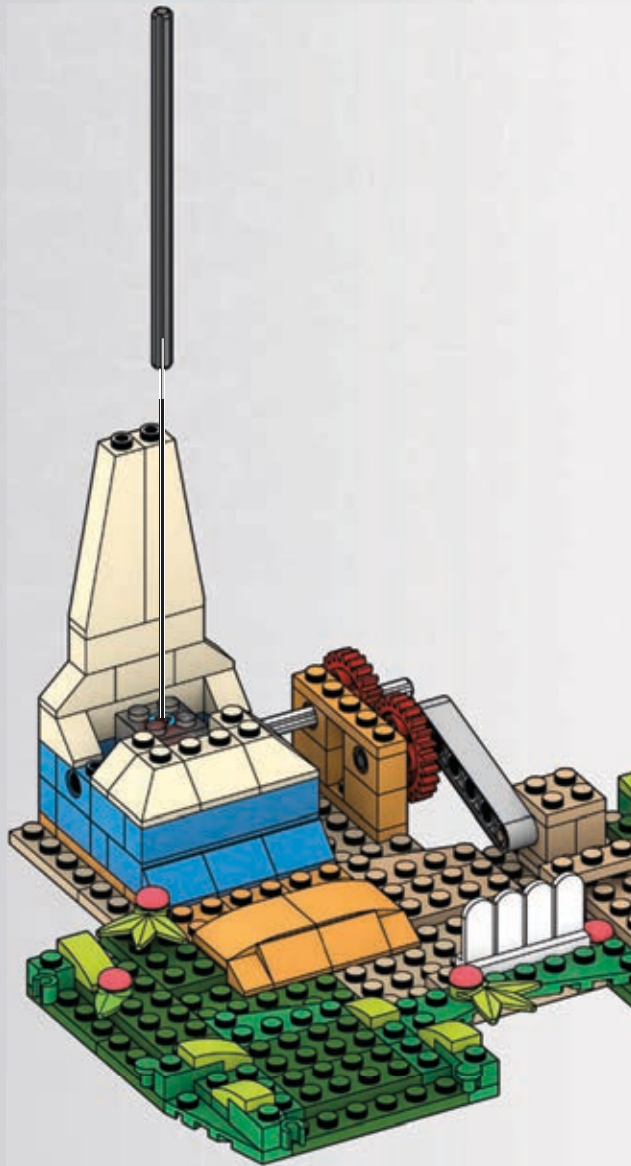

82



2x

2x

83



4x

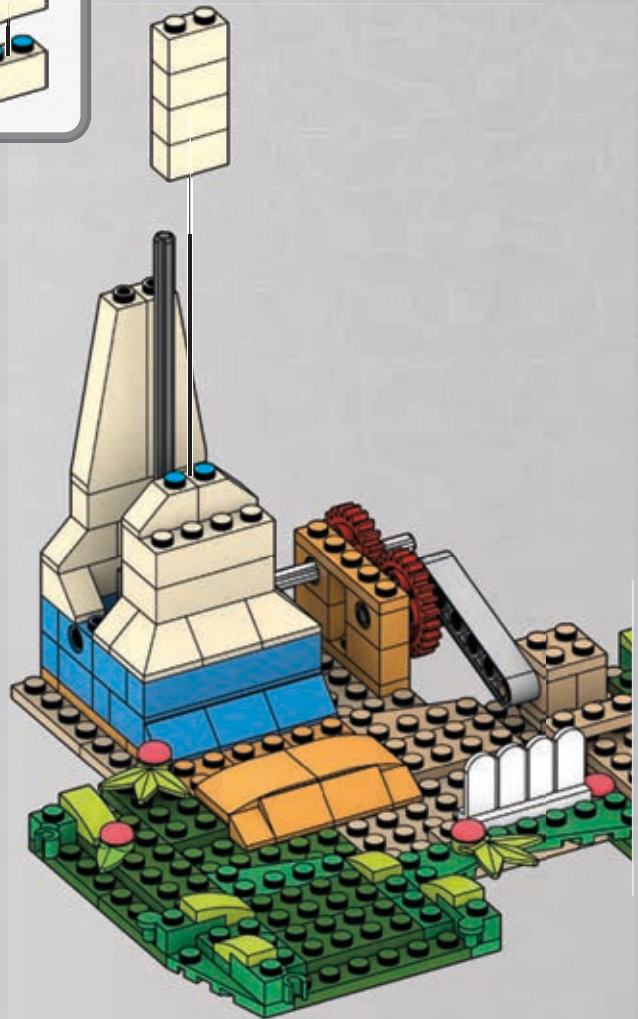
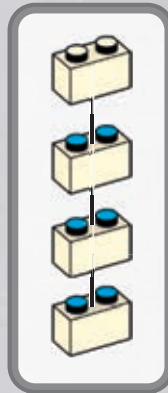
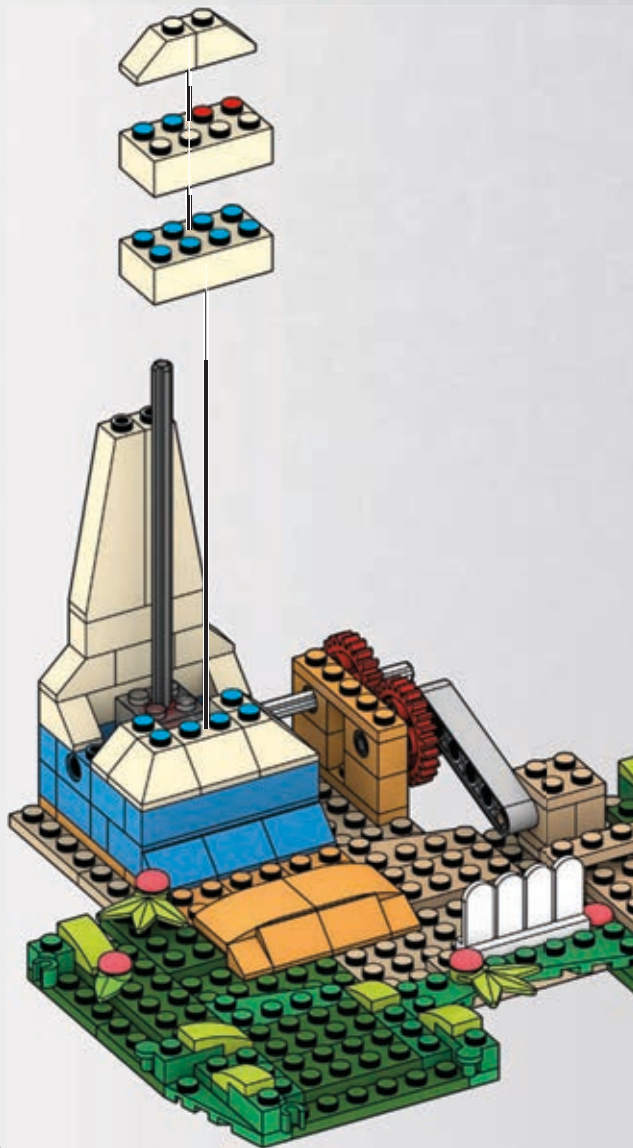

84



2x

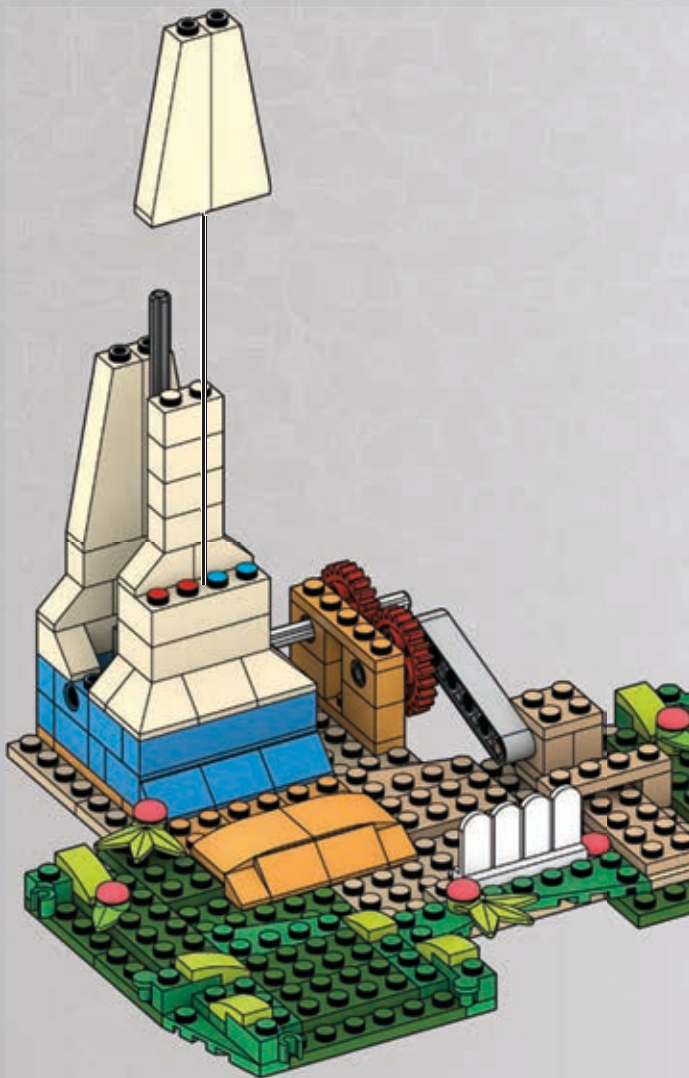

1

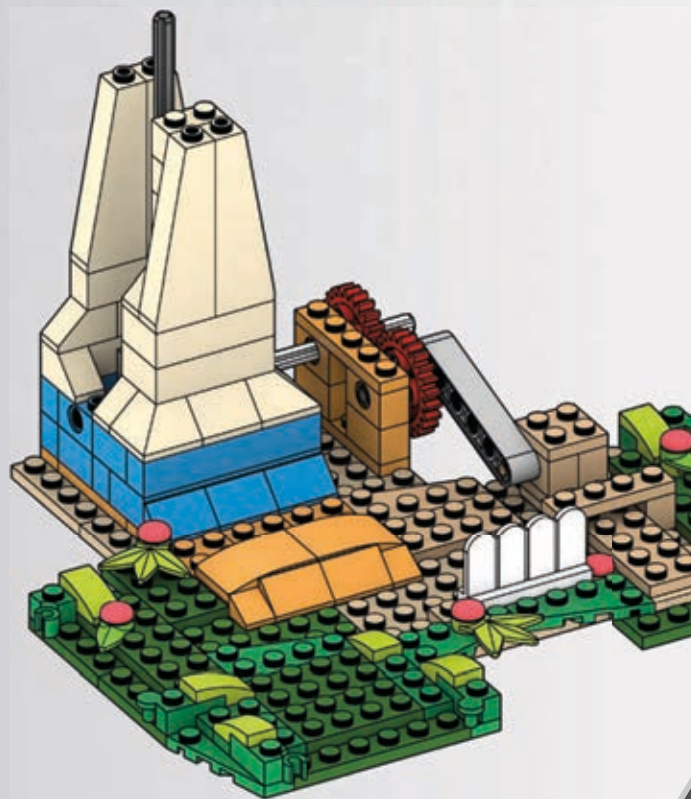

2

85

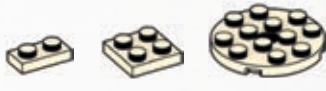

1x

1x

1x

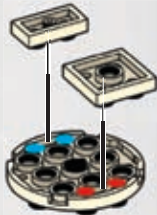

1



2

86



2x

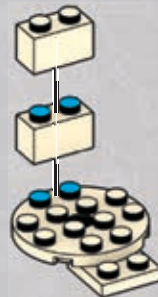

87



2x

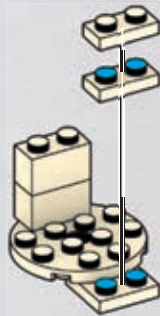

1



2

88



1x

1x

1x

1x

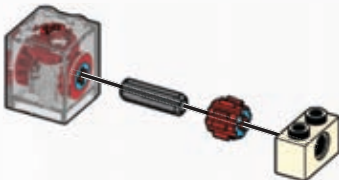

1

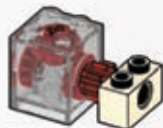

2



89



2x



1

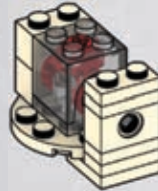

2

90

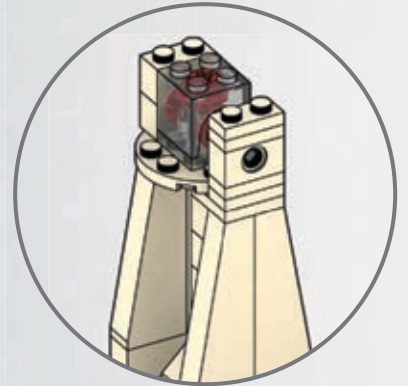
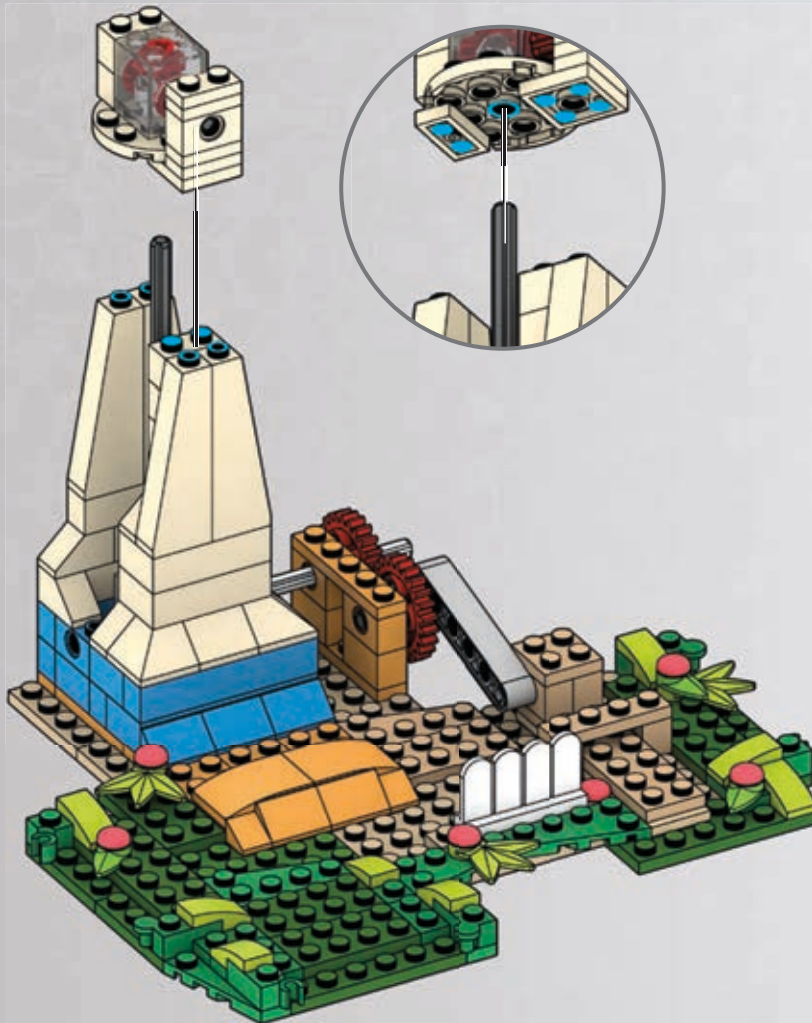

91



92

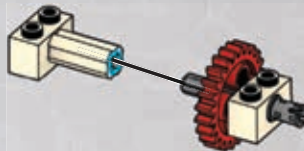
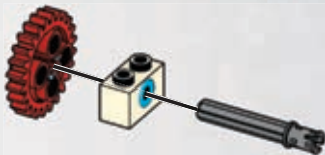
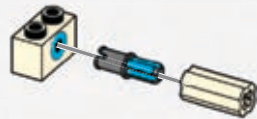

1

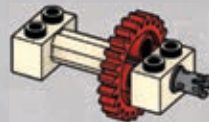

2

93



94



2x

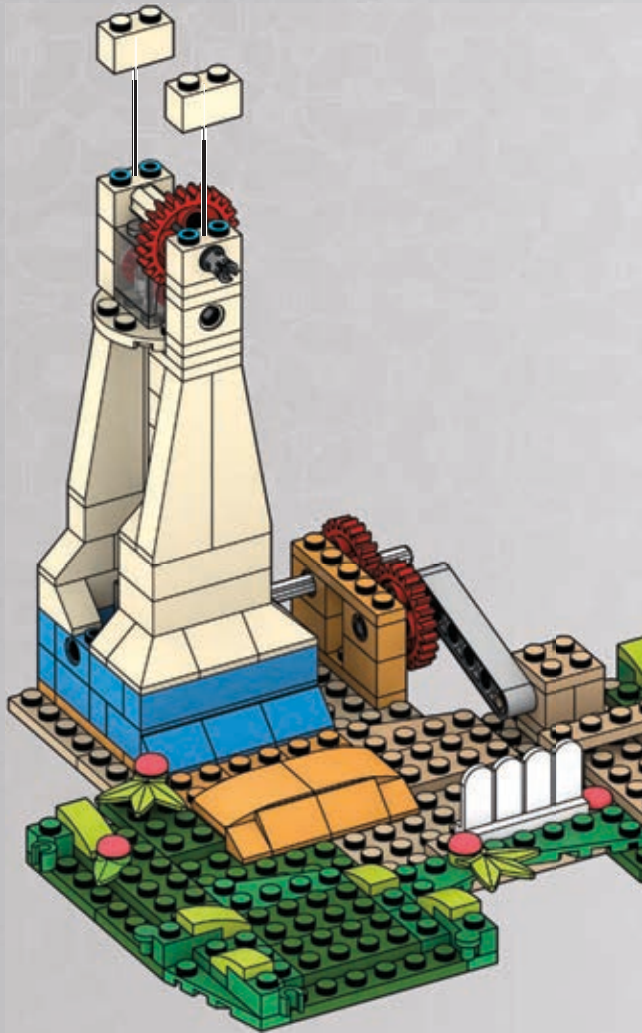

95



1x



1x

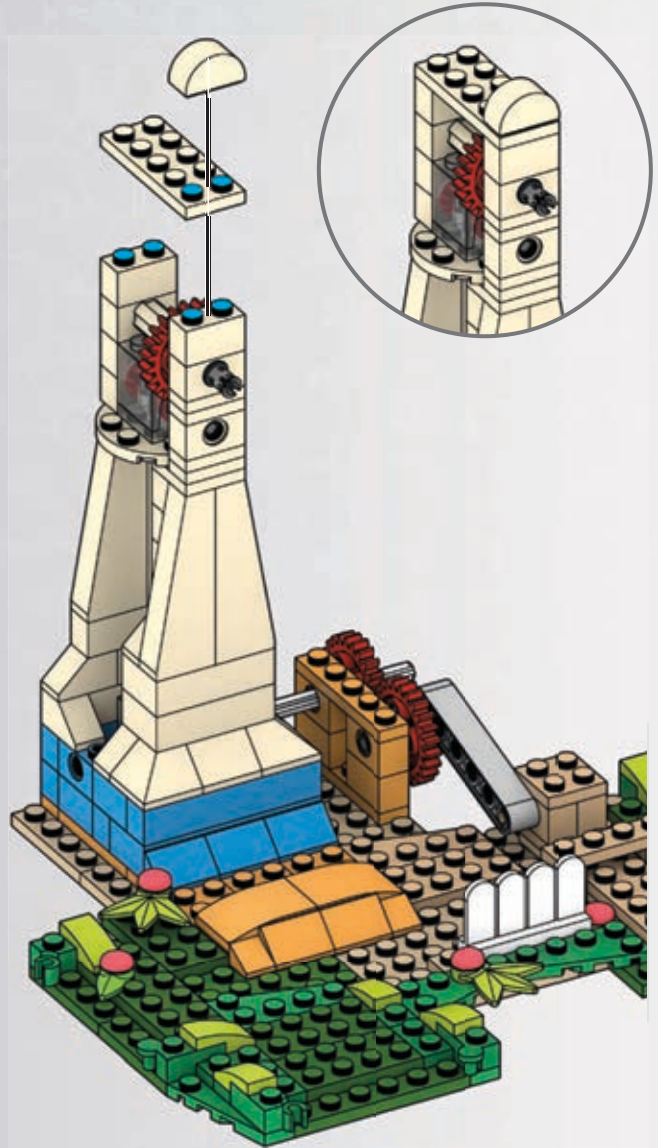



96

1x 1x 2x 1x

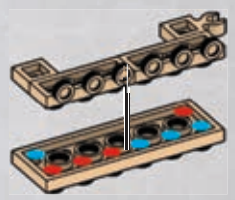

97

4x

98

2x 1x

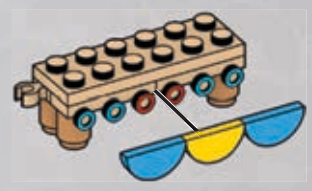
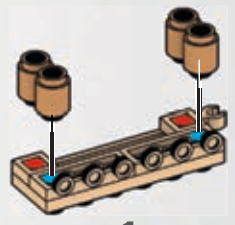

1

2

99

2x 1x

100

2x 1x

101

3x 1x

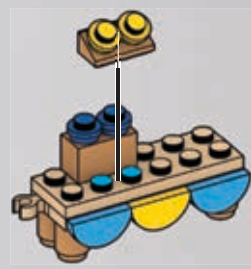
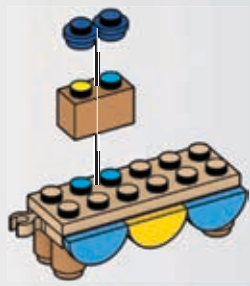

102



1x



1



2

103

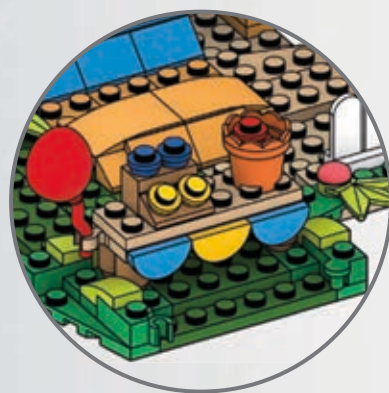
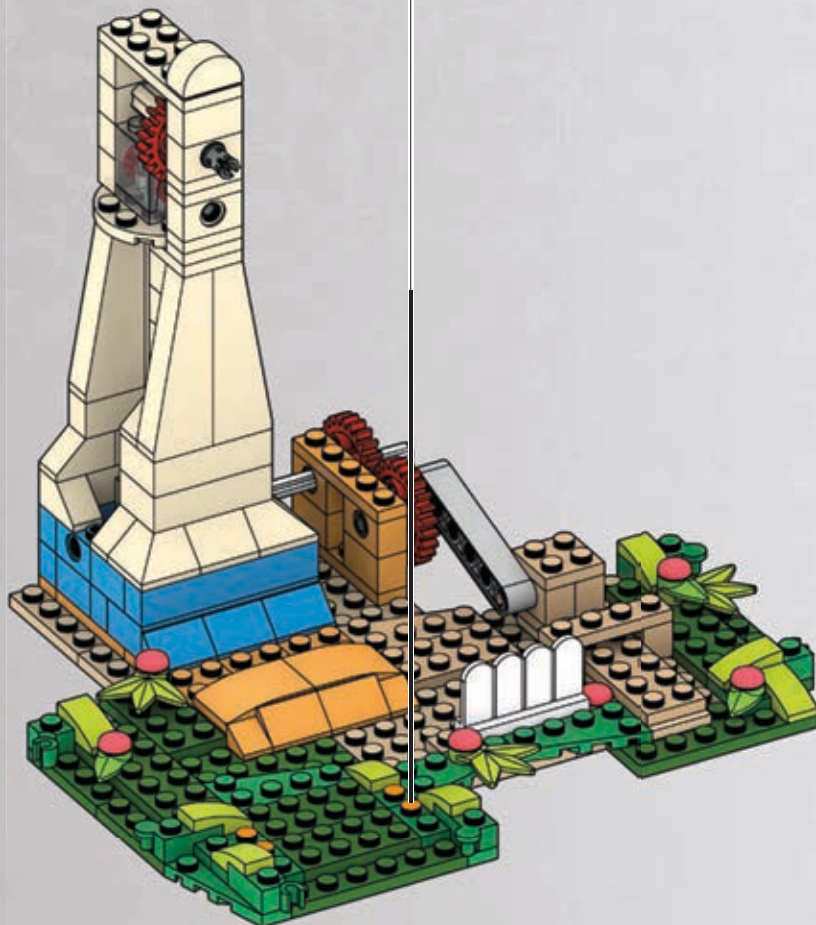

104



2x



1x

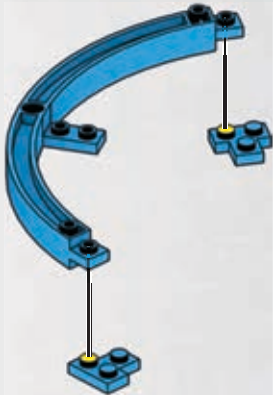

105



1x



1x

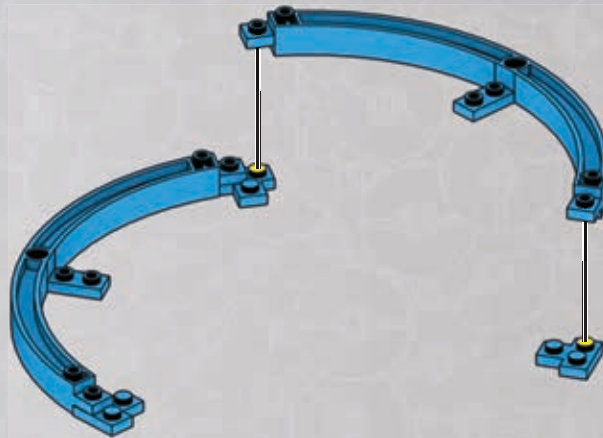

106



1x

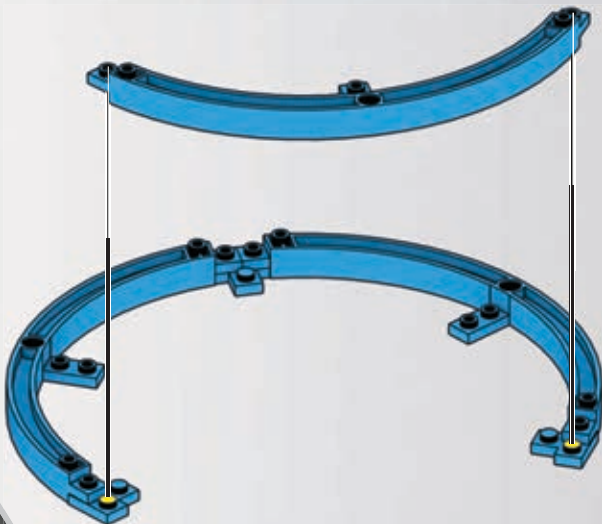

107



3x



1x

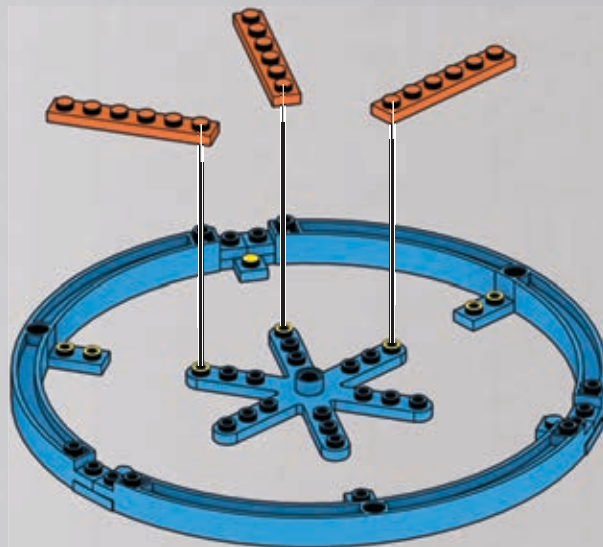

108



3x

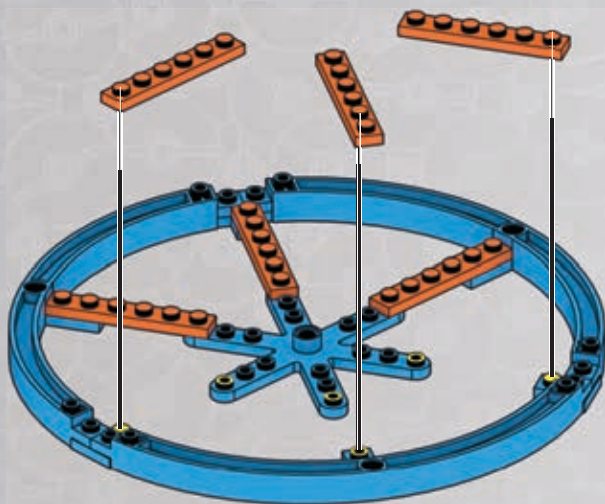

109



3x

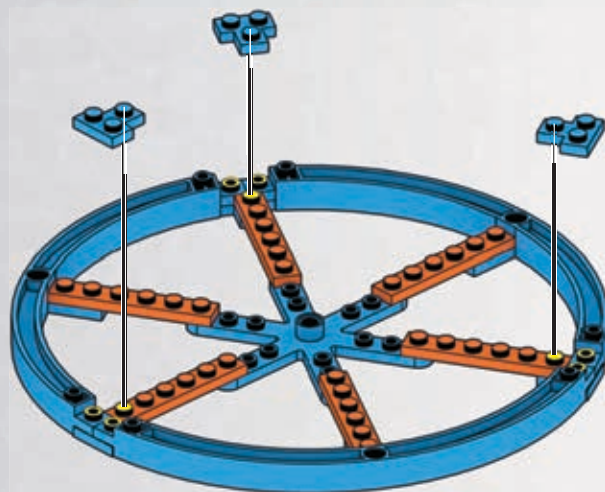

110



6x

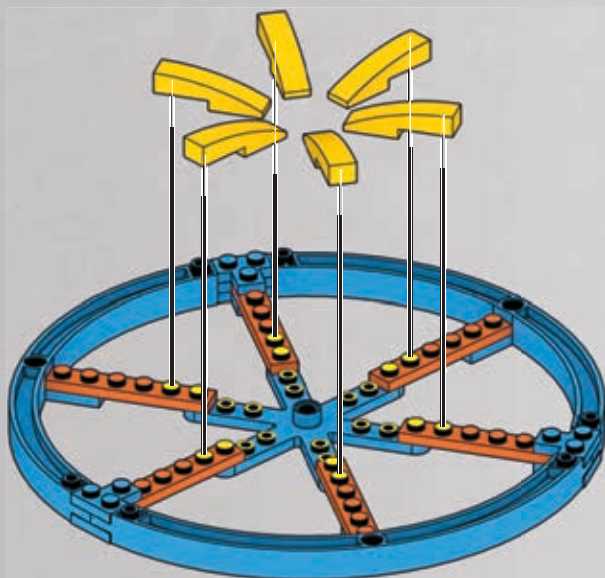

111



6x

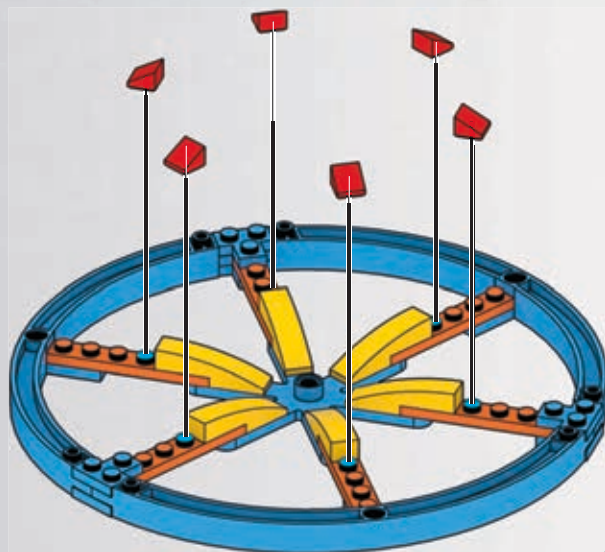

112



3x



3x

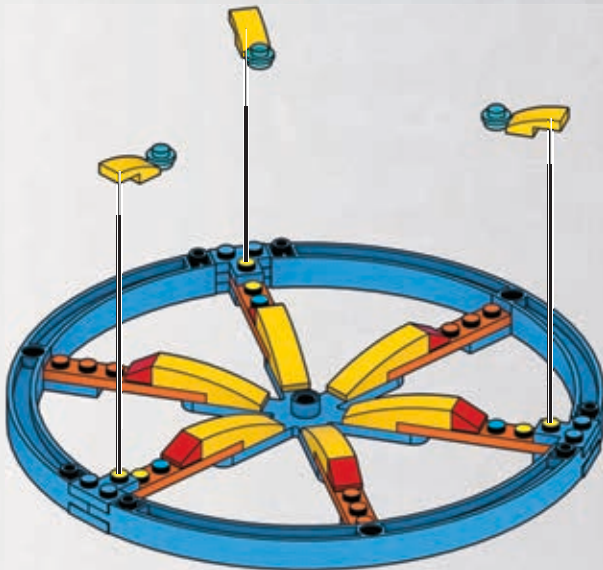

113



3x



3x



3x

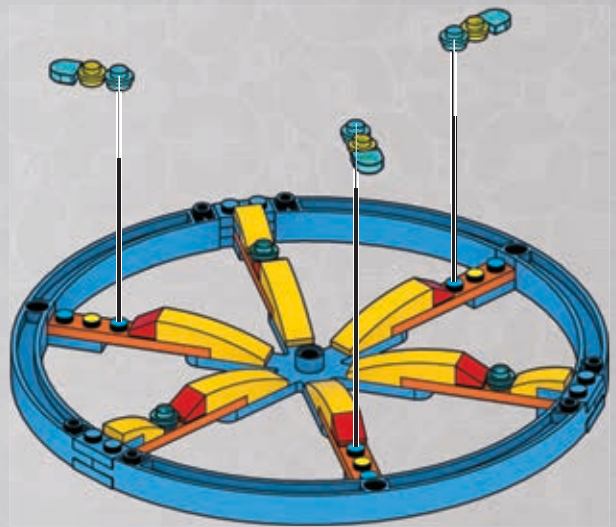

114



3x



3x



3x



1



2

x3

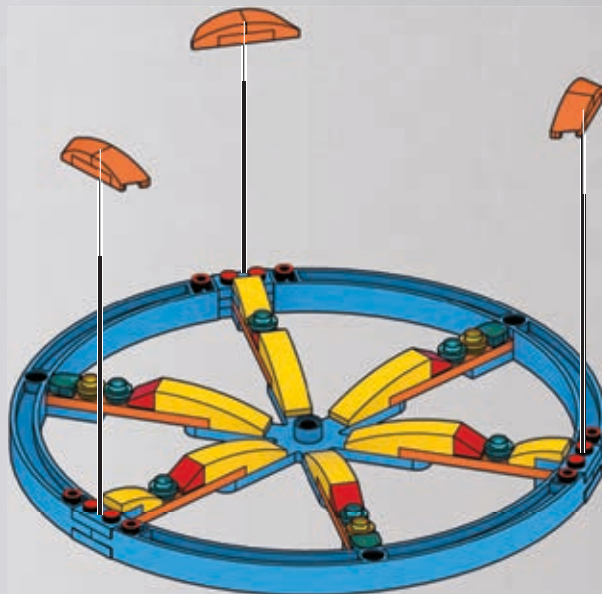

115



3x

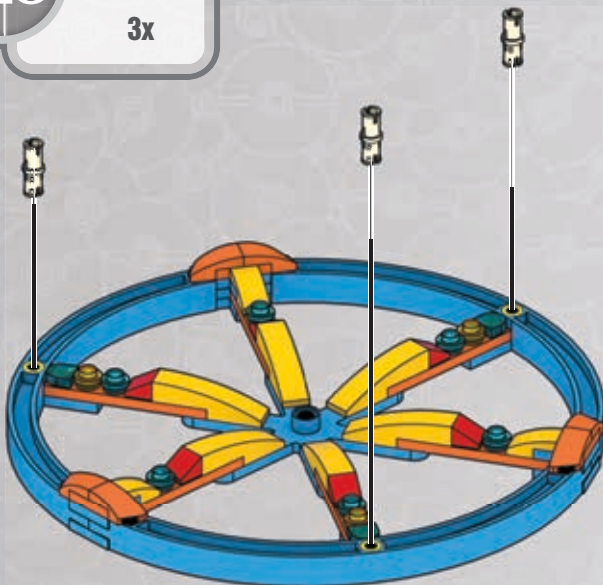

1

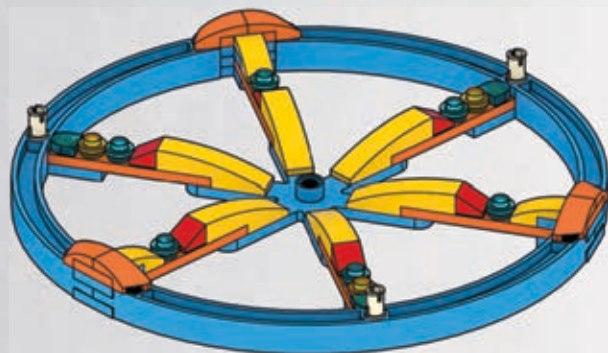

2

116



1x



2x



1x



4x

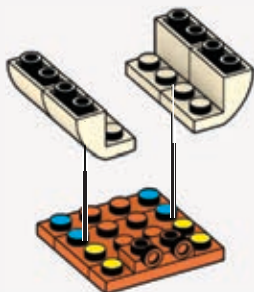
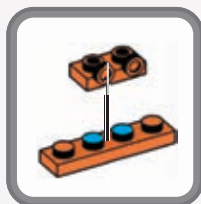

117



1x

x3



1



2

118



4x



2x

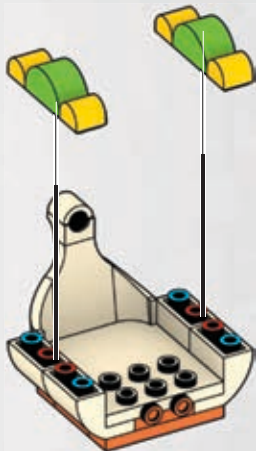

119



1x



2x

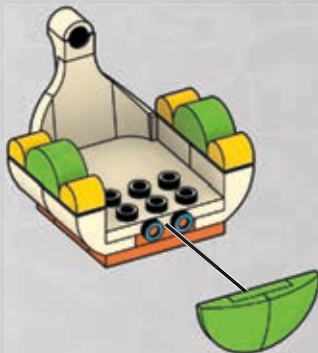

1

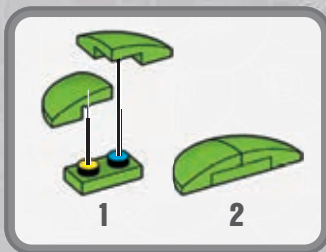

1

2

120



4x



2x



121



1x



2x



1

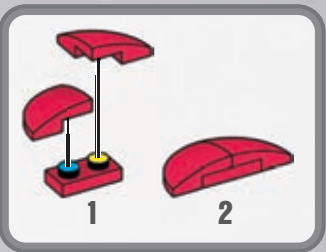

1

2



2

122



123

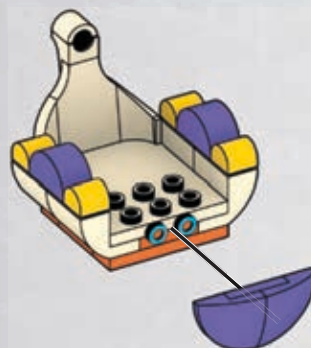

1

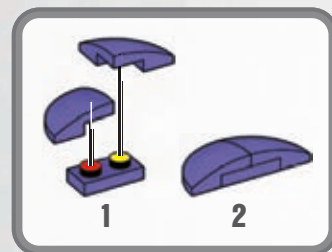

2

124

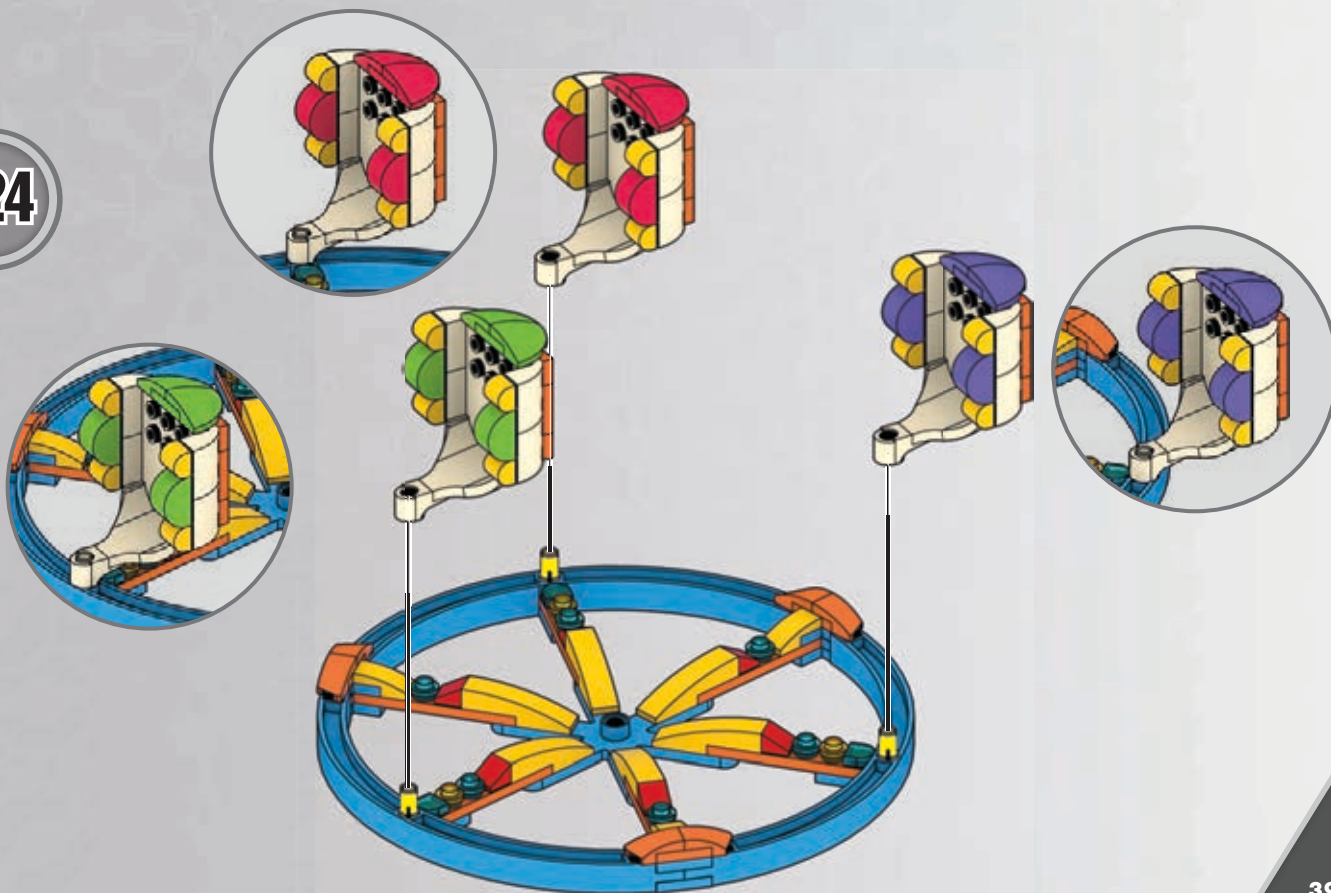

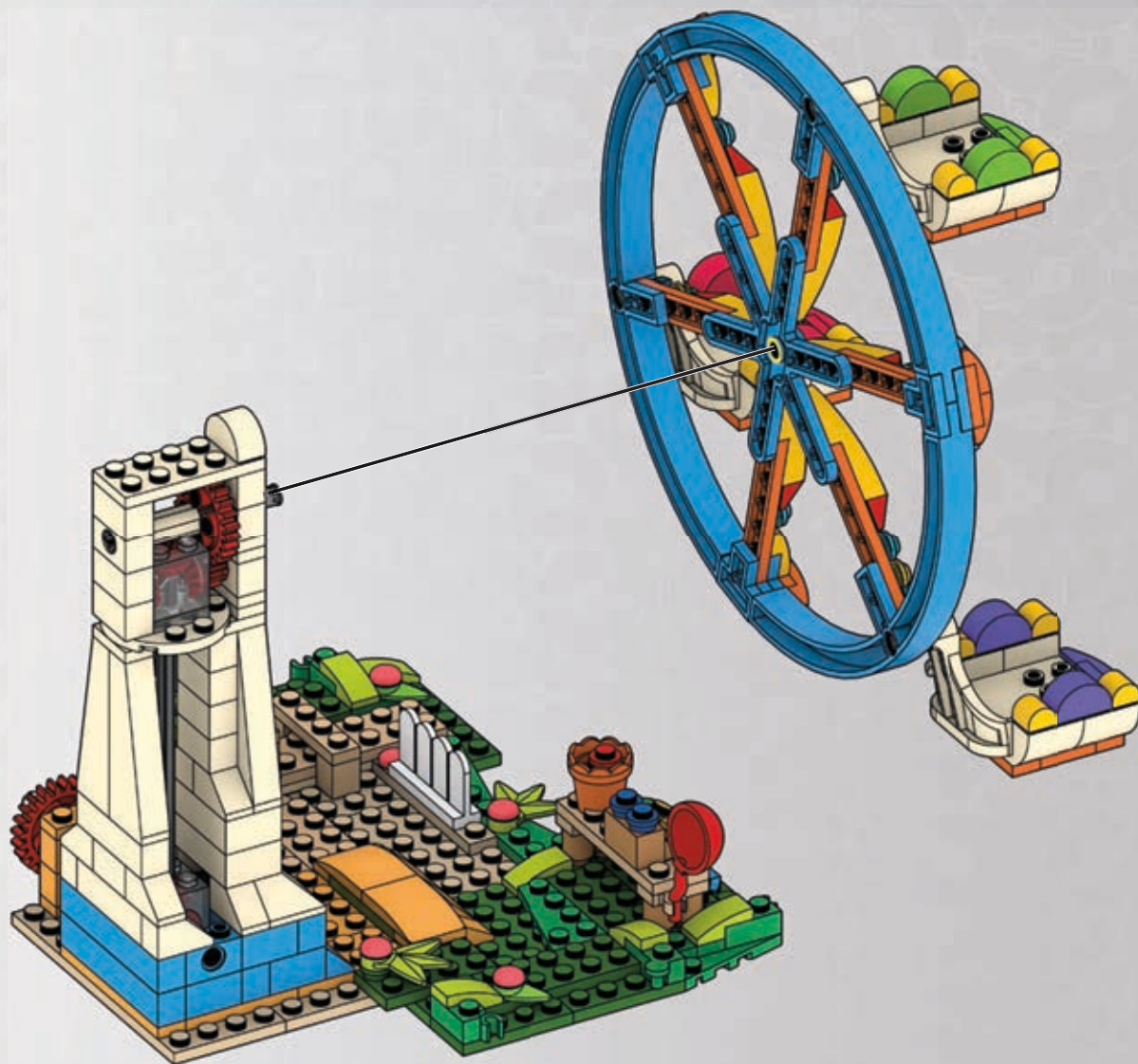

126



1x



1x



1



2

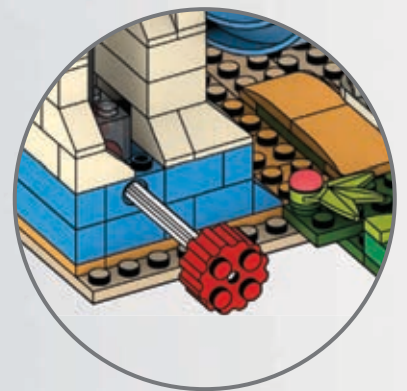
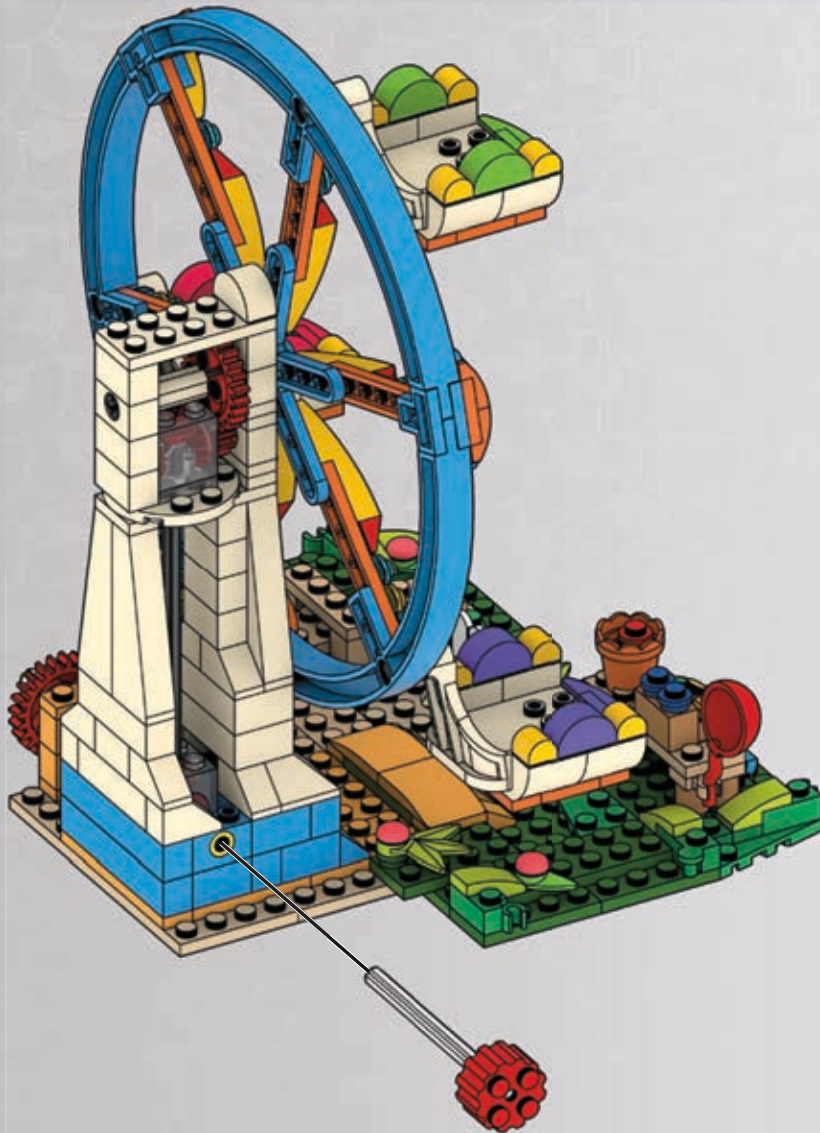

127

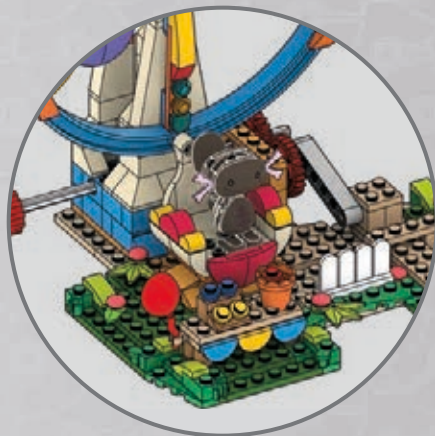

128

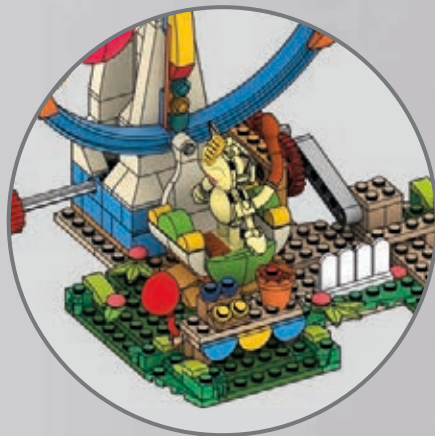

129

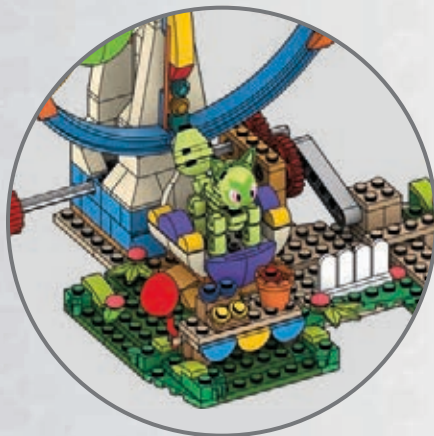

130

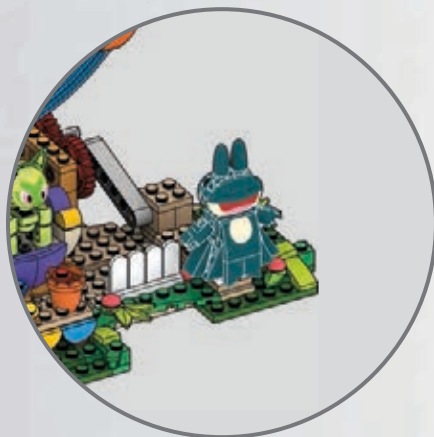



Ferris Wheel Fun / Un Tour dans la Grande Roue / Spaß auf dem Riesenrad / Reuzenradplezier / Diversión en la noria / Diversão na Roda-Gigante / Kul med pariserhjulet / En tur i pariserhjulet
 Diabelski mlyn Zestaw / Zábava na ruském kole / Óriáskerekes buli / Колесо обозренияРόδα Λούνα Парк / Dönme Dolap Eğlencesi / Ferris Wheel Fun
 مرح دولاب الهواء

**CONNECT SETS TO BUILD YOUR
POKÉMON WORLD
CONNECTEZ LES COFFRETS POUR CRÉER
VOTRE UNIVERS POKÉMON**

*Conecta los conjuntos para crear tu mundo Pokémon
Una os conjuntos para construir o seu mundo Pokémon
Verbinde Sets und erschaffe deine eigene Pokémon-Welt
Соединяйте наборы, чтобы построить свой мир Покемонов*



**Parents, scan to see the full
MEGA collection.
Parents, numériser pour voir la
collection complète de MEGA.**

Padres: Escaneen para ver la colección completa de MEGA.
Pais, digitalizem para ver a coleção MEGA completa.
Liebe Eltern, bitte scannen, damit Sie die gesamte MEGA-Kollektion sehen können.
Родители, отсканируйте QR-код, чтобы посмотреть полную коллекцию MEGA.

Set(s) sold separately and subject to availability. / Ensemble(s) vendu(s) séparément. Certains produits peuvent ne pas être commercialisés. Se vende(n) por separado y está(n) sujeto(s) a disponibilidad. / Conjunto(s) vendido(s) em separado e sujeito(s) a disponibilidade. / Set in vendita separatamente, secondo disponibilità. / Das/Die Set(s) sind separat erhältlich. / Zestaw(y) sprzedawany(e) oddzielnie w zależności od dostępności. / Set(s) apart verkrijgbaar en afhankelijk van beschikbaarheid. / Набор(-ы) продаются отдельно, при наличии. Sæt sælges separat og så længe lager haves. / Seten såljs separat så länge lagret räcker. / Settet/settene selges separat så langt lageret rekker. / Pakkaus/pakkaukset myydään erikseen, saatavuus voi vaihdella. / Το(α) σετ πωλούνται ξεχωριστά και ανάλογα με τη διαθεσιμότητα. / Setler ayrı olarak satılır ve stoklarla sınırlıdır. / Set (sety) se predává (prodávaji) samostatně dle aktuální nabídky. Súprava/-y sa predáva(jú) samostatne a podľa dostupnosti. A készlet(ek) külön kapható(k), az elérhetőség változhat. セット商品は別売りになります。在庫状況は別途ご確認お願いします。 / تباع المجموعة أو المجموعات على حدة وتخضع لتوافرها. 每套单独发售，按供货情况决定。

6x
AM75332RQ

1x
AM01113ARD

2x
AM01113B

3x
AM01113AMC

3x
AM01113ZD

2x
AM01113BYE

6x
AM01113AAV

3x
AM76558CS

3x
AM76204AAV

1x
AM76204AWD

1x
AM07223AWD

1x
AM03328AMR

2x
AM77574VF

12x
AM16980BYE

6x
AM17127AMC

2x
AM17127FM

1x
AM17003PH

2x
AM17003CS

1x
AM79403CS

1x
AM79403PH

4x
AM78274AWD

2x
AS-HKT24-09

2x
AM79432VF

1x
AM80170AMC

4x
AM00910VL

2x
AM01086AMR

2x
AM01086GX

1x
AS-DYF08-02

2x
AM78291VF

1x
AM78291AWD

1x
AM78291AAZ

1x
AM80155AWD

2x
AM80010CS

2x
AM80010AAZ

3x
AM78279HT

2x
AS-FVR55-03

2x
AS-HPX92-11

1x
AM18591AMR

1x
AM18591CS

2x
AM74299VF

2x
AM74300VF

2x
AM79977CS

4x
AM78289AWD

1x
AM78296AWD

1x
AM78296AAZ

1x
AM82114AAZ

2x
AM78396VF

2x
AS-GFC90-02

2x
AM79704BDG

2x
AM78290CS

2x
AM80164AAZ

2x
AM79288GX

1x
AM79288BYE

2x
AM22501FM

2x
AM09393VF

1x
AM09393BMG

1x
AM09393HT

5x
AM09393WC

1x
AM09393AMP

1x
AM09393AML

3x
AM09393BOR

1x
AM16680VF

3x
AM79070BOR

1x
AM18272VL

2x
AM80573VF

3x
AM74427BOR

3x
AM74426BOR

2x
AM17128VF

1x
AM81433BDG

2x
AM72534AMR

3x
AM72534WC

1x
AM81438WC

2x
AM18665VF

2x
AM18666VF

1x
AM78285CS

1x
AM78285AWD

1x
AM79982CS

1x
AM79679AWD

1x
AM19380AWD

1x
AM01404AWD

12x
AM08482WC

1x
AS-HPX92-10

8x
AM78486BBG

3x
AM78486BYE

1x
AM78281AWD

3x
AM76559BMG

3x
AM76560BMG

2x
AM03019FM

3x
AM03019GX

8x
AM01322WC

2x
AM17834HT

2x
AM17834AML

1x
AM17834WC

2x
AM17834AMP

2x
AM79877FM

1x
AM79877AMR

3x
AM79877WC

2x
AM79877GX

1x
AM09013VL

1x
AM09013AMR

2x
AM09013FM

9x
AM09013WC

2x
AM09013GX

1x
AM17672BOR

3x
AM78382BBG

4x
AM15484BMG

6x
AM18293GX

1x
AM03773AMR

1x
AM03773WC

1x
AM80560PH

1x
AM17711AMC

2x
AM16641WC

1x
AM10273WC

1x
AM09023GX

1x
AM81613AMC

1x
AM81610AAZ

1x
AS-HXF80-04

1x
AM81727AWD

1x
AM80565AAZ

2x
AM76525HT

2x
AM76525AML

2x
AM76525AMP

1x
AS-HKT24-08

1x
AM74106VF

2x
AS-HKT19-01

1x
AS-HXF80-02

1x
AS-HKT24-07

1x
AS-HXF80-01

1x
AM78286CS

1x
AS-HXF80-03

1x
AM78286AAZ

1x
AS-HPX92-12

1x
AM80940AWD

1x
AM78282WC

1x
AM78282CS

2x
AM78282AAZ

1x
AM79378VF

2x
AM81260AMR

1x
AM79978CS

1x
AM78398VF

1x
AM78283AWD

1x
AM03772VF

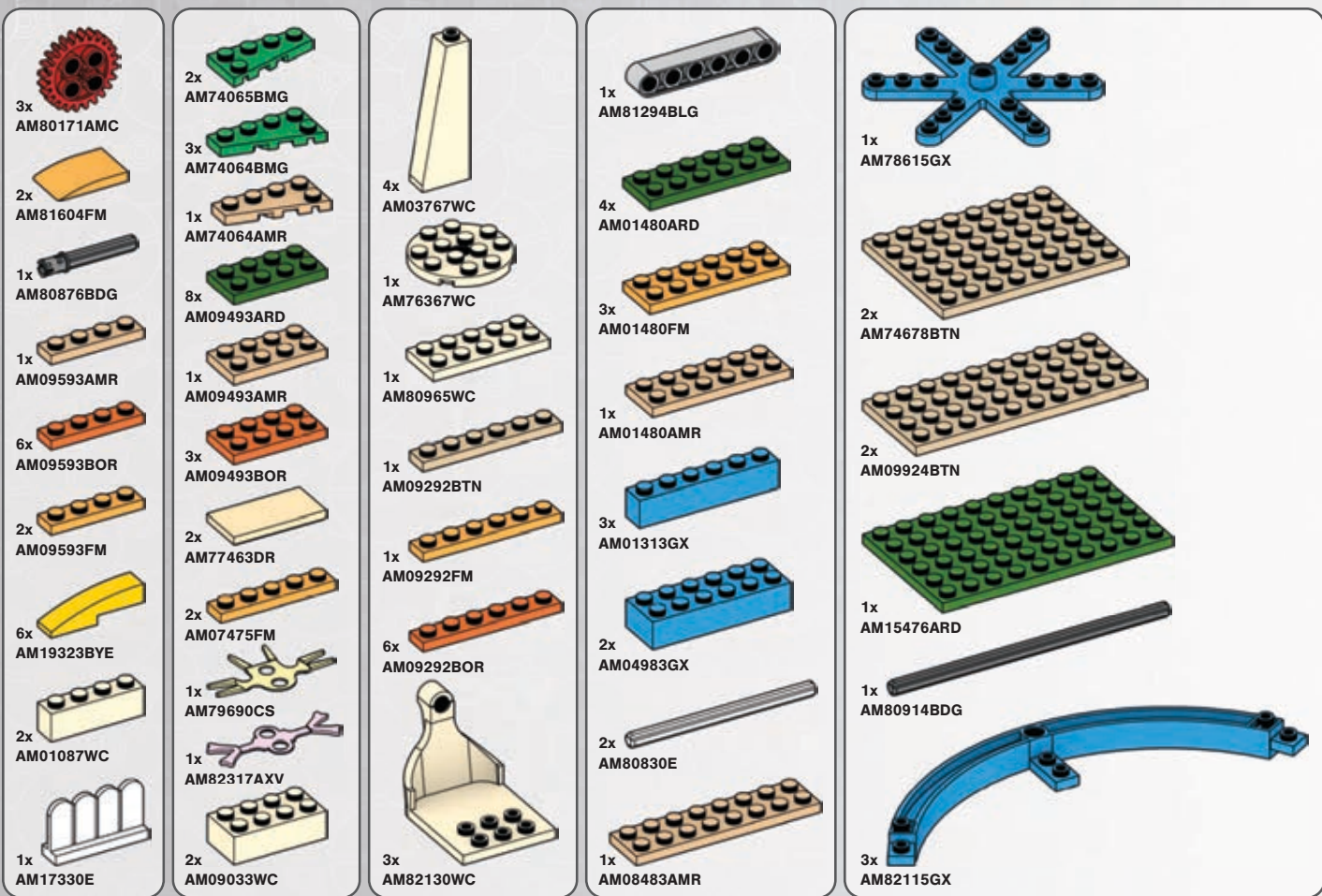

WARNING:
CHOKING HAZARD – Small parts.
 Not for children under 3 years.

ATTENTION :
DANGER D'ÉTOUFFEMENT –
PETITS ÉLÉMENTS. NE
CONVIENT PAS AUX ENFANTS
DE MOINS DE 36 MOIS.

ATENÇÃO: NÃO INDICADO / NÃO RECOMENDÁVEL PARA CRIANÇAS MENORES DE 3 (TRÊS) ANOS POR CONTER PARTE(S) PEQUENA(S) QUE PODE(M) SER ENGOLIDA(S) OU ASPIRADA(S) PODENDO PROVOCAR ASFIXIA.

WARNING: Small parts, **ATTENTION :** PETITS ÉLÉMENTS, **ACHTUNG:** Kleine Teile, **AVVERTENZA:** Piccole parti, **WAARSCHUWING:** Kleine onderdelen, **ADVERTENCIA:** PELIGRO DE ATAGANTAMIENTO. Juguete no recomendado para menores de 3 años, porque contiene piezas pequeñas que podrían provocar asfixia en caso de ser ingeridas o inhaladas por el/la niño/a, **VARNING:** Små delar, **VAROITUS:** Pieniä osia, **ADVVARSEL:** Små dele, **ADVVARSEL:** Små deler, **OSTRZEZENIE:** Małe części, **UPOZORNĚNÍ:** Malé části, **UPOZORNENIE:** Malé části, **FIGYELMEZTETÉS:** Kis alkatrészek, **ПРЕДУПРЕЖДЕНИЕ:** Мелкие детали, **ΠΡΟΕΙΔΟΠΟΙΗΣΗ:** Μικρά κομμάτια, **UYARI:** Küçük parçalar.
 تحذیر: قطع صغيرة.

警告:
 のどにつまる危険 小さな部品が含まれています 3歳以下の子供には与えないで下さい。

警告! 不适合3岁以下儿童使用。内含小零件。



Missing pieces?
Pièces manquantes?
 ¿Partes faltantes? • Perdeu peças?
 Fehlen Teile? • Не хватает деталей?

? support.megabrands.com

Mattel Europa B.V., Gondel 1, 1186 MJ Amstelveen, Nederland. Mattel U.K. Limited, The Porter Building, 1 Brunel Way, Slough SL1 1FQ, UK. Mattel France, Parc de la Cerisaie, 1/3/5 allée des Fleurs, 94260 Fresnes Cedex. N° Cristal 0969 36 99 99 (Número non surtaxe) ou www.lesjouetsmattel.fr Mattel Belgium N.V. De Kleetlaan 4, 1831 Machelen (Diegem) Belgium. Deutschland : Mattel GmbH, Solmsstraße 83, D-60486 Frankfurt am Main. Schweiz: Mattel AG, Kirchstrasse 24, CH-3097 Liebefeld. Österreich: Mattel Ges.m.b.H., Campus 21, Liebermannstraße A01 404, A-2345 Brunn/Gebrige. Mattel Italy Srl, Via Turati 4, 20121 Milano, Italy. Servizio assistenza clienti: Customersrvitalia@mattel.com - Numero verde 800 11 37 11. Mattel España, S. A. Aribau 200 pl. 9, 08036 Barcelona. cservice.spain@mattel.com Tel: +34 933 06 79 00 http://www.service.mattel.com/es. Chinese mainland: Mattel Barbie (Shanghai), Trading Co., Ltd. Room 2005, 20th Floor, 899 Ruining Road, Xuhui District, Shanghai, 200232, P.R.C. Customer Care Line: 400-819-9658. Hong Kong SAR: Kids Kingdom Limited, Room 1908-9, Gala Place, 56 Dundas Street, Mongkok, Kowloon, Hong Kong, P.R.C. Customer Care Line: (852)2782-0766. Taiwan region: CHICKABIDDY CO., LTD, F5, No. 186, Sec. 4, Nanjing E. Rd., Taipei 10595, Taiwan region. Customer Care Line: 0800 001 256. Diimport & Diedarkan Oleh: Mattel Continental Asia Sdn Bhd. Level 19, Tower 3, Avenue 7, No. 8 Jalan Kerinchi, Bangsar South, 59200 Kuala Lumpur, Malaysia. Mattel South Africa (PTY) LTD, Office 102 I3, 30 Melrose Boulevard, Johannesburg 2196. Dystrybutor: Mattel Poland Sp. z o.o., Budynek Skyliner 31 p., ul. Prosta 67, 00-838 Warszawa, Polska. Mattel Australia Pty. Ltd., 658 Church St., Richmond, Victoria, 3121. Consumer Advisory Service - 1300 135 312. Mattel AEBE, Еввърону Макариу 1, Кръгю К2, ТК 17561, Палою Флорно, Mattel Oyuncakçılık Tic. Ltd. Şti. İçerenköy Mah. Umut Sokak No: 10 - 12, Quick Tower kat:2 İçkapı no:15 Ataşehir 34752, İstanbul, Türkiye. Tel: 0216 570 75 00. Импортёр/Упоиночяная организация: ООО "МАТТЕЛ" Российская Федерация, 105120 Москва, 2-й Сыромитинский переулок, 1; +7 495 287 79 39. Mattel Czech Republic s.r.o., The Forum, Václavské nám. 19, 11000 Praha. Mattel, 333 Continental Boulevard, El Segundo, CA 90245, USA. Consumer Services: 1-800-465-MEGA (6342). Mattel Canada Inc., Mississauga, Ontario L5R 3W2. Consumer Services: You may call us free at/ Composez sans frais le 1-800-524-8697. Importado y distribuido por Mattel de México, S.A. de C.V., Miguel de Cervantes Saavedra No. 193, Pisos 10 y 11, Col. Granada, Alcaldía Miguel Hidalgo, C.P. 11520, México, Ciudad de México. R.F.C. MME-920701-NB3. Tels.: 59-05-51-00 Ext. 5206 ó 01-800-463-59-89. Mattel Chile S.A., P.dte. Riesco 5561, Of. 203-204 PS2, Las Condes, Santiago. Servicio al consumidor Venezuela: Tel: 0-800-100-9123. Mattel Argentina, S.A., Av. Libertador 1000, Piso 11 - Oficinas 109 y 111, Vicente López - Prov. Buenos Aires. Tel.: 0800-666-3373. Mattel Colombia, S.A., Calle 123#7-07 P.5, Bogotá. Mattel Perú, S.A., Av. Juan de Arona # 151, Centro Empresarial Juan de Arona, Torre C, Piso 7, Oficina 704, San Isidro, Lima 27, Perú. RUC: 20425853865. Reg. Importador: 02350-12-JUE-DIGESA. Tel.: 0800-54744. E-mail Latinoamérica: servicio.clientes@mattel.com. Mattel do Brasil Ltda. - CNPJ : 54.558.002/0001-20 - Rua Verbo Divino, 1488 - 2º. Andar - 04719-904 - Chácara Santo Antônio - São Paulo - SP - Brasil. Serviço de Atendimento ao Consumidor: Contato: <https://faleconosco.mattel.com.br/> Contato. E-mail: sac.matteldobrazil@mattel.com

MEGA

POKÉMON

YOU CAN BUILD YOUR TEAM
VOUS POUVEZ CRÉER VOTRE ÉQUIPE



PUEDES CREAR TU PROPIO EQUIPO
PODES CONSTRUIR A TUA EQUIPA
DU KANNST DEIN TEAM ZUSAMMENSTELLEN
ТЫ МОЖЕШЬ СОБРАТЬ СВОЮ КОМАНДУ

Set(s) sold separately and subject to availability. / Ensemble(s) vendu(s) séparément. Certains produits peuvent ne pas être commercialisés. Se vende(n) por separado y está(n) sujeto(s) a disponibilidad. / Conjunto(s) vendido(s) em separado e sujeito(s) à disponibilidade. / Set in vendita separatamente, secondo disponibilità. / Das/Die Set(s) sind separat erhältlich. / Zestaw(y) sprzedawany(e) oddzielnie w zależności od dostępności. / Set(s) apart verkrijgbaar en afhankelijk van beschikbaarheid. / Набор(-ы) продаются отдельно, при наличии. Sæt sælges separat og så længe lager haves. / Seten säljs separat så länge lagret räcker. / Settet/settene selges separat så langt lageret rekker. / Pakkaus/pakkaukset myydään erikseen, saatavuus voi vaihdella. / Το(α) σετ πωλούνται ξεχωριστά και ανάλογα με τη διαθεσιμότητα. / Setler ayrı olarak satılır ve stoklarla sınırlıdır. / Set (sety) se prodává (prodávavj) samostatně dle aktuální nabídky. Súprava/-y sa predáva(jú) samostatne a podľa dostupnosti. A készlet(ek) külön kapható(k), az elérhetőség változhat.

セツト商品は別売りになります。在庫状況は別途ご確認をお願いします。 / بيع المجموعة أو المجموعات على حدة وتخضع لتوافرها. / 每套单独发售，按供货情况决定。

™ & © 2023 Mattel.

© 2023 MEGA Brands & ™ MEGA Brands.
Printed in China / Imprimé en Chine

Ⓜ D781,964, D797,203, D799,607, D799,608,
D841,101, D834,104, D857,115, D834,105, D977,027
AD-HXF80-01

Mattel Canada Inc. Mississauga, Ontario L5R 3W2.
MADE IN CHINA. FABRIQUÉ EN CHINE. FABRICADO NA CHINA. HECHO EN CHINA.
ИЗГОТОВЛЕНО В КИТАЕ. ÇIN'DE ÜRETİLMİŞTİR. صنع في الصين.

MEGAUNBOXED.COM

MATTEL
Empowering the next generation through play.
Inspirer les futures générations par le jeu.

1186 MJ, 1, NL



FR
DONNEZ
OU
RECYCLEZ
ASSOCIATION OU MAGASIN OU DÉCHÈTERIE
Adresses sur www.fairedemesdechets.fr

QUIET ZONE - PAS D'ÉLÉMENTS / PAS DE TEXTE - QUIET ZONE
F.P.O.
Packaging in responsible sources
Emballage issu de sources responsables
www.fsc.org FSC C000100
QUIET ZONE - PAS D'ÉLÉMENTS / PAS DE TEXTE - QUIET ZONE