

**MEGA™  
CONSTRUX**

# POKÉMON™



Build Them!  
Construis-les!  
¡constrúyelos!

**GALARIAN  
MIAOUSS  
DE GALAR  
GALAR-MAUZI**

**VS TOXEL  
TOXIZAP**



**WONDER  
BUILDERS™**  
GYG96





Fuel their imagination with building toys that support creative thinking and problem solving.

Stimulez leur imagination avec des jouets de construction qui encouragent l'esprit créatif et la résolution de problèmes.

Alimenta su imaginación con juguetes de construcción que ayudan a desarrollar el ensamblaje creativo y la resolución de problemas. / Abasteça a imaginação dele com brinquedos de montar que suportam o pensamento criativo e a resolução de problemas. / Dieses Bauspielzeug beflügelt nicht nur die Phantasie, sondern unterstützt auch kreatives und lösungsorientiertes Denken. / Разжигайте воображение детей с помощью конструктора, развивающего творческие способности и логическое мышление.



### Authentic Details Détails Authentiques

Detalles auténticos  
Detalhes autênticos  
Authentische Details  
Реалистичные детали



### Different sizes to build Différentes tailles à construire

Tamanhos diferentes para construir  
Verschiedene Größen zum Bauen  
Se pueden crear en distintos tamaños  
Модели для сборки разных размеров



Learn more  
Pour en savoir plus

Más información · Sabe mais · Weitere  
Infos gibt es auf · Узнать больше



[play.megaconstrux.com](http://play.megaconstrux.com)



MEGA  
UNBOXED



## Build Construisez

Construye | Constrói  
Bauen | Стройте

Devices not included | Appareils non inclus | Dispositivos no incluído | Dispositivos não incluídos  
Geräte nicht enthalten | Устройства не входят в комплект

Easy-to-follow steps!

Des instructions  
faciles à suivre !

¡Pasos fáciles de seguir!  
Passos fáceis de seguir!  
Einfache Schritte!  
Простые действия!



megaunboxed.com



1



3x



2x



1x



1x



1x

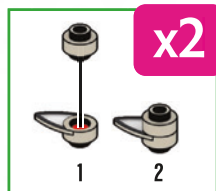

x2

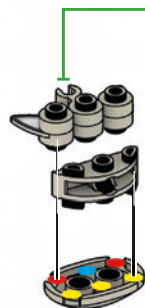
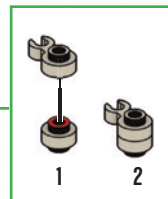

2



1x



1x

3



1x



1



2



1



2

4



2x

1x



1x

5



1x

1x



1x

6



2x

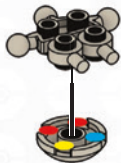

1

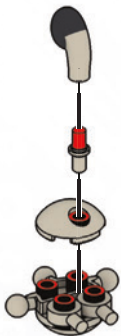

2

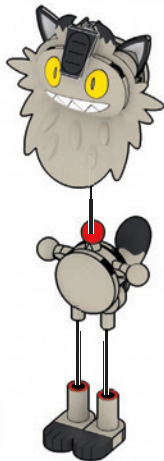

1



2

7



2x



2x

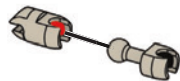

1



2

x2



1



2



3

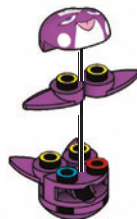
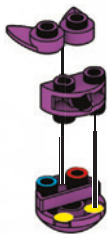
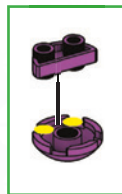
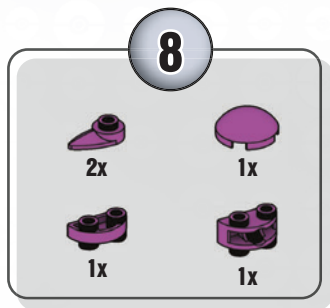

1



2

10

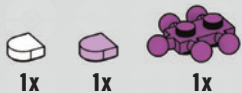

11



12

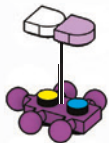

1



2



1



2

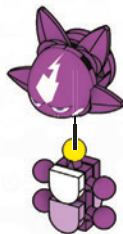



13



2x



2x



1



2

x2

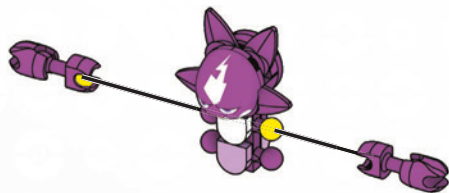

14



2x



2x

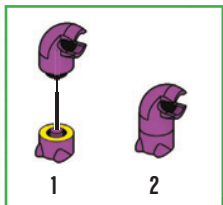

1

2

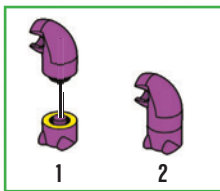

1

2

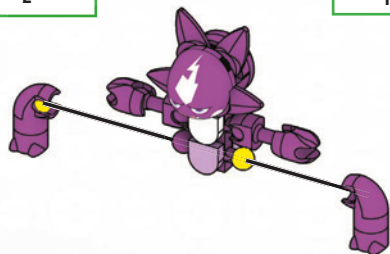

1



2

15



1x



1x



1



2



1



2



3



4

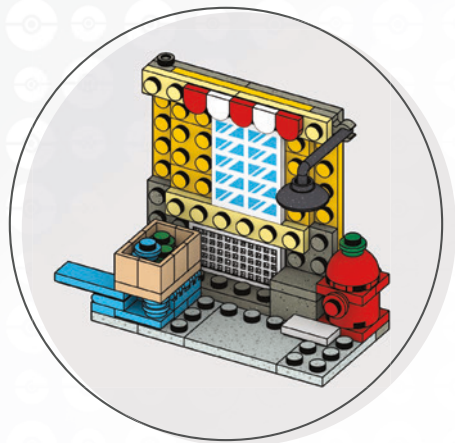

16



1x



1x



1x

17



1x



2x



1x

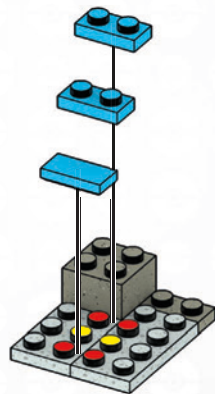
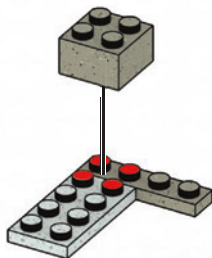

18



1x



1x



1x

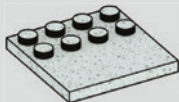

1x

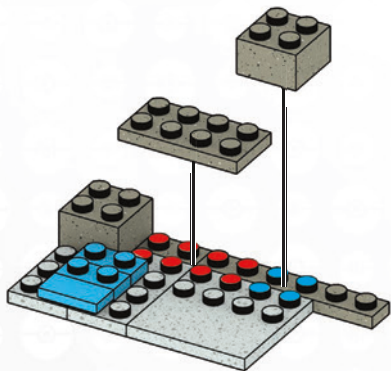

19



1x



1x



1x

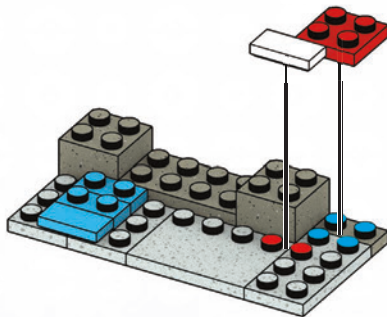
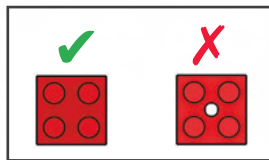

20



1x

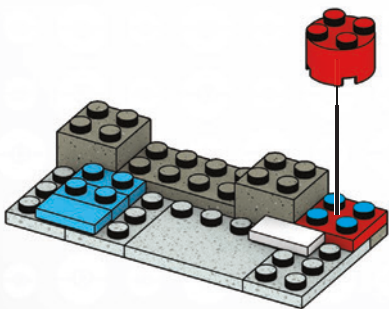

21



2x



1x

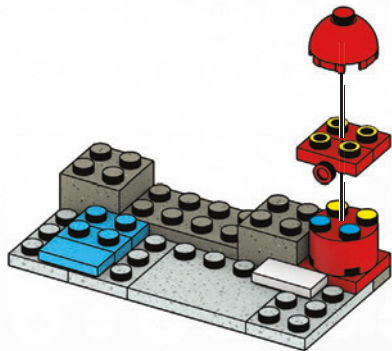

22



2x



1x

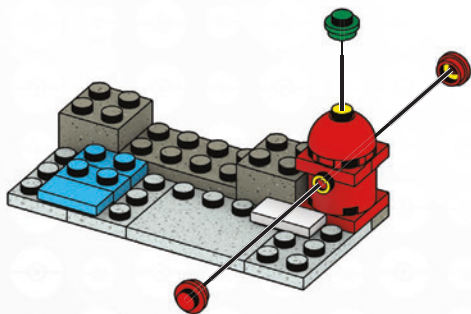

23



1x



1x

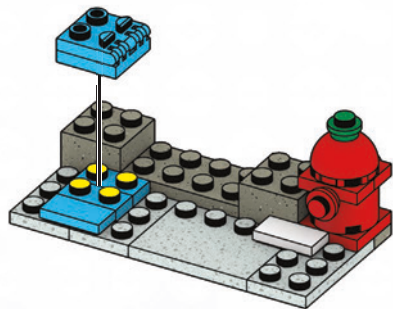
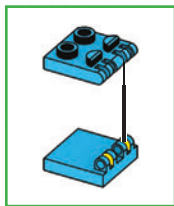

24



1x



1x



1x

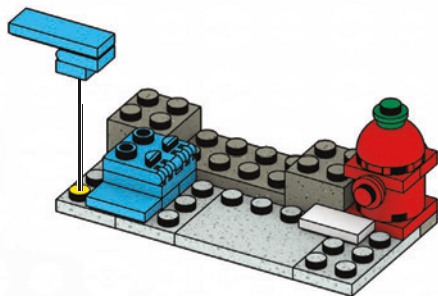
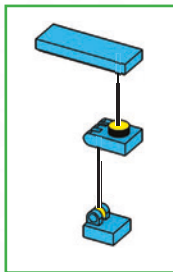

1

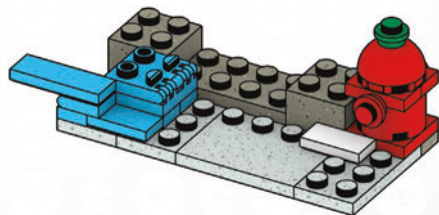

2



25



1x

3x

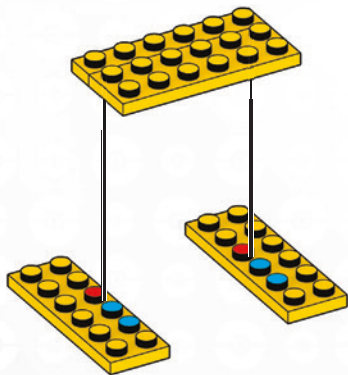

26



2x

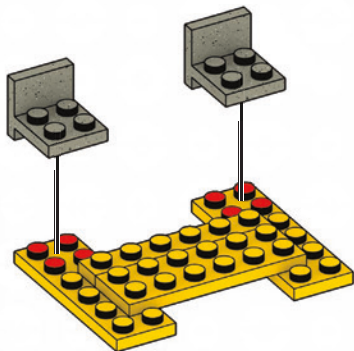

27



2x



1x

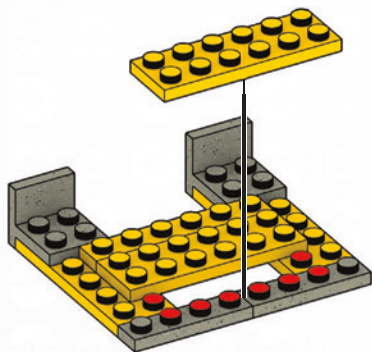

28



1x



1x

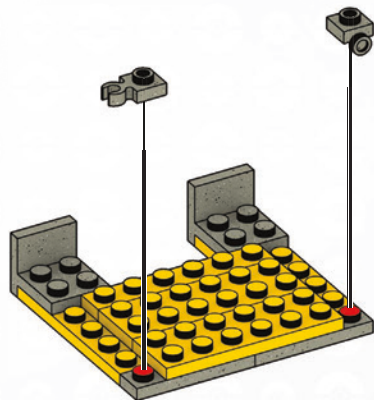



30



2x



3x

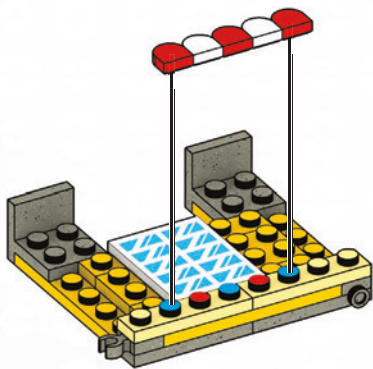

1

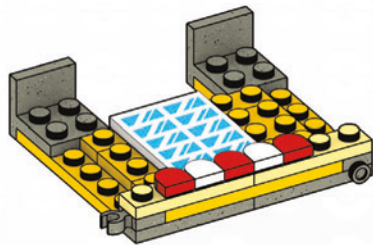

2

31



2x



1x



1x

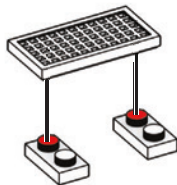

1

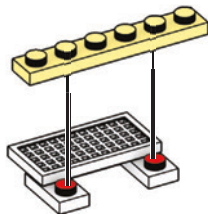

2

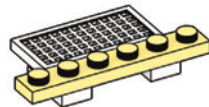

3

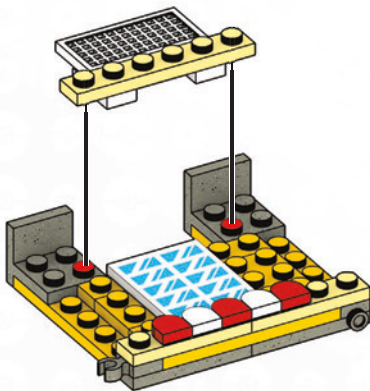

1

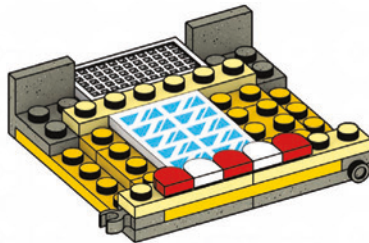

2

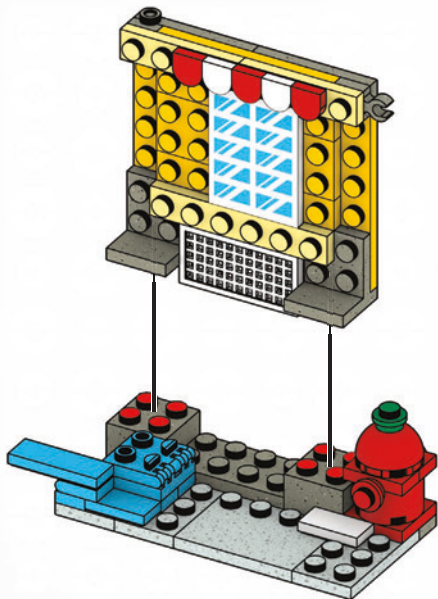

1

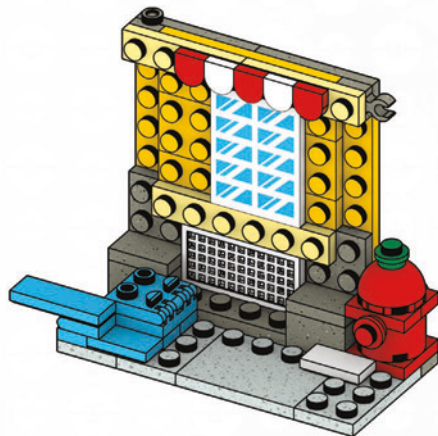

2

**33**



2x



1x

**34**



2x

**35**



2x

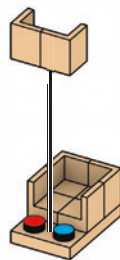
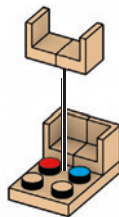
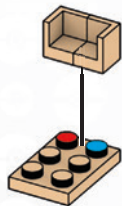

1

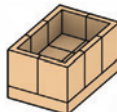

2

36



2x

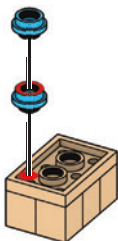

1



2

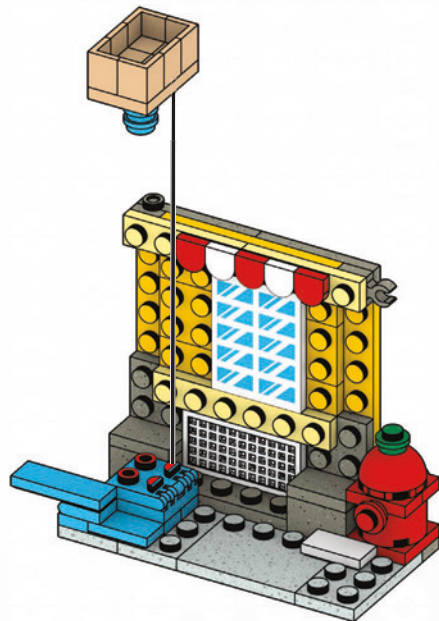



37



1x



1x



1



2

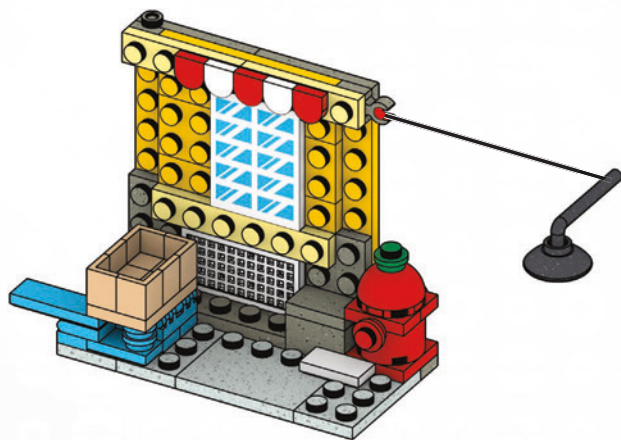

38



2x



2x

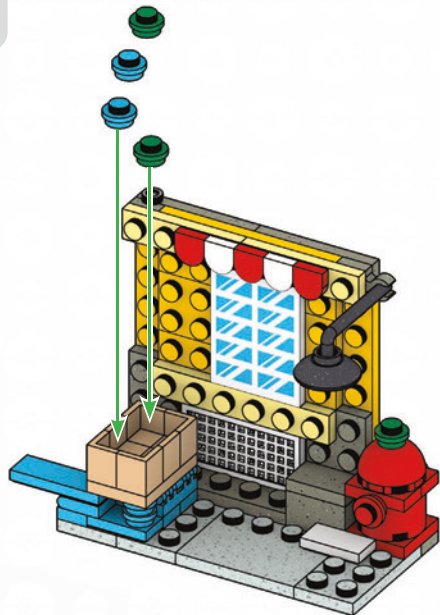

1

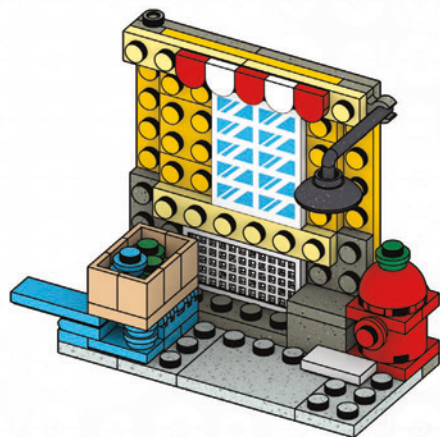

2

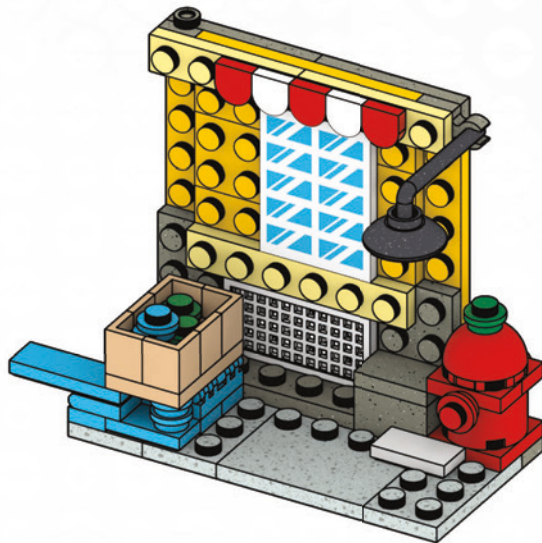

**GALARIAN  
MEOWTH  
MIAOUSS  
DE GALAR  
GALAR-MAUZI**



**TOXEL  
TOXIZAP**

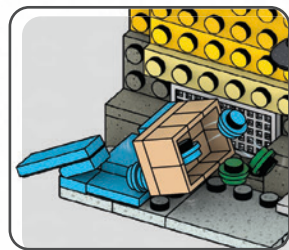
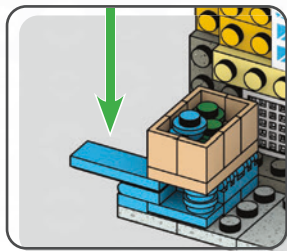

*Galarian Meowth Vs. Toxel / Meowth de Galar vs. Toxel / Meowth di Galar vs Toxel / Galar-Mauzi vs. Toxel / Meowth z Galaru vs. Toxel / Galarian Meowth против Toxel / Galariah Meowth ile Toxel / Galari Meowth Toxel ellen / Galarian Meowth mot Toxel / Meowth z Galárie Vs. Toxel / Toxel 🐱 Galarian Meowth*



1



2



\*Not included / Non inclus / No incluido  
não incluido / Nicht enthalten / не входит



**BUILD THEM!  
CONSTRUIS-LES!  
¡CONSTRUYELOS!  
ΚΑΤΑΣΚΕΥΗ! • ПОСТРОИ!**



**GYH00**



**GYH06**



**FPM00**



**GYG94**



**GYG96**



**GYG98**

**Set(s) sold separately and subject to availability. / Ensemble(s) vendu(s) séparément. Certains produits peuvent ne pas être commercialisés.**

/ Se vende(n) por separado y está(n) sujeto(s) a disponibilidad. / Conjunto(s) vendido(s) em separado e sujeito(s) à disponibilidade. / Set in vendita separatamente, secondo disponibilità. / Das/Die Set(s) sind separat erhältlich. / Zestaw(y) sprzedawany(e) oddzielnie w zależności od dostępności. / Set(s) apart verkrijgbaar en afhankelijk van beschikbaarheid. / Набор(-ы) продаются отдельно, при наличии. / Sæt sælges separat og så længe lager haves. / Seten säljs separat så länge lagret räcker. / Settet/settene selges separat så langt lageret rekker. / Pakkaus/pakkaukset myydään erikseen, saatavuus voi vaihdella. / Το(α) σετ πωλούνται ξεχωριστά και ανάλογα με τη διαθεσιμότητα. / Setler ayrı olarak satılır ve stoklarla sınırlıdır. / Set (sety) se prodává (prodávají) samostatně dle aktuální nabídky. / Súprava/-y sa predáva(jú) samostatne a podľa dostupnosti. / A készlet(ek) külön kapható(k), az elérhetőség változhat. / セット商品は別売りになります。在庫状況は別途ご確認をお願いします。 /

تباع المجموعة أو المجموعات على حدة وتخضع لتوافرها.  
每套单独发售，按供货情况决定。

4x  
AM0113GD



2x  
AM0113AMC



1x  
AM1856ONL



3x  
AM0113BMG



3x  
AM76558DO



3x  
AM76204E



1x  
AM76204NL



3x  
AM76204AMC



1x  
AM77574AGQ



1x  
AM09104GD



1x  
AM09105GD



1x  
AS-GYG96-08



2x  
AM80557AEN



1x  
AM72001NL



1x  
AM17003DO



2x  
AS-GYG96-02



4x  
AM78279AEN



2x  
AM80010DO



1x  
AM12251DO



1x  
AM18591AGQ



2x  
AM79977AEN



2x  
AM78396DO



2x  
AM80060AEN



1x  
AS-GYG96-03



2x  
AM15485AMR



4x  
AM76959AMR



2x  
AM78290DO



2x  
AM78290AEN



2x  
AS-GYG96-06



1x  
AM7234ONL



1x  
AS-GYG96-05



1x  
AM78391AEN



1x  
AM74016MM



1x  
AM022501GD



1x  
AM022501E



2x  
AM09393GD



2x  
AM09393E



2x  
AM78926AMC



2x  
AM78926AMC



1x  
AM78285DO



1x  
AM78285AEN



1x  
AM79982DO



1x  
AS-GYG96-07



1x  
AM09023AGQ



1x  
AM09023AGQ



1x  
AM79018E



1x  
AM04245AMC



1x  
AM78281AEN



1x  
AM01320AMC



1x  
AM09267GD



1x  
AM03773AMC



1x  
AM09268GD



1x  
AM79017AMC



1x  
AM79017AMC



1x  
AM79017AMC



2x  
AM09023AGQ



2x  
AM09023AGQ



1x  
AM78286DO



1x  
AS-GYG96-01



1x  
AM78282DO



1x  
AM79575AEN



1x  
AM79978DO



1x  
AM80966GD



1x  
AM77738MM



1x  
AM03772AMR



3x  
AM09593AGQ



2x  
AM09593CS



1x  
AM18276E



1x  
AM09493AGQ



3x  
AM09493LW



1x  
AM09292BYE

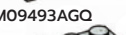

1x  
AM09292CS



1x  
AM09292AGQ



1x  
AM01480BYE

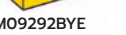



1x  
AS-GYG96-10



1x  
AS-GYG96-04

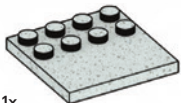

1x  
AM18617LW



2x  
AM80958AGQ

Mattel Europa B.V., Gondel 1, 1186 MJ Amstelveen, Nederland. Mattel U.K. Limited, The Porter Building, 1 Brunel Way, Slough SL1 1FQ, UK. Mattel France, Parc de la Cerisaie, 1/3/5 allée des Fleurs, 94260 Fresnes Cedex. Nr. Cristal 0969 36 99 99 (Numéro non surtaxé) ou www.lesjouetsmattel.fr Mattel Belgium, Trade Mart, Atomiumsquare, Bogota 202 - B 275, 1020 Brussels. Gratis nummer België: 0800 - 16 936 - Gratis nummer Luxemburg: 800 - 22 784 - Gratis nummer Nederland: 0800 - 262 88 35. Deutschland : Mattel GmbH, Solmsstraße 83, D-60486 Frankfurt am Main, Schweiz: Mattel AG, Kirchstrasse 24, CH-3097 Liebefeld, Österreich: Mattel Ges.m.b.H., Campus 21, Liebermannstraße A01 404, A- 2345 Brunn/Gebirge. Mattel Italy Srl, Via Turati 4, 20121 Milano, Italy. Servizio assistenza clienti: Customerservice.italy@mattel.com - Numero verde 800 11 37 11. Mattel España, S.A, Anibau 200 pl. 9, 08036 Barcelona. cservice.spain@mattel.com Tel.: +34 933 06 79 00 http://www.servicio.mattel.com/es. Mattel East Asia Ltd., Room 503-09, North Tower, World Finance Centre, Harbour City, Tsingshatsui, HK, China. Tel.: (852) 3185-6500. Diimport & Diedarkan Oleh: Mattel Continental Asia Sdn Bhd. Level 19, Tower 3, Avenue 7, No. 8 Jalan Kerinchi, Bangsar South, 59200 Kuala Lumpur, Malaysia. Mattel South Africa (PTY) LTD, Office 102 13, 30 Melrose Boulevard, Johannesburg 2196. Dystrybutor: Mattel Poland Sp. z o.o., Warsaw Trade Tower 34 p., ul. Chłodna 51, 00-867 Warszawa. Mattel Australia Pty. Ltd., 658 Church St., Richmond, Victoria, 3121. Consumer Advisory Service - 1300 135 312. Mattel AEBE, ΕΒνάρყო Μακαρίου 1, Κτήριο Κ-2, ΤΚ 17561, Παλαιό Φάληρο. Mattel Oyuncakçılık Tic. Ltd. Şti. İçerenköy Mah. Umut Sok. No:10-12 Quick Tower Kat:2/15 34752 Ataşehir İstanbul Tel: 0216 570 75 00. Импортёр/Уполномоченная организация: ООО "МАТТЕЛ" Российская Федерация, 105120 Москва, 2-й Сыромятинский переулок 1; +7 495 287 79 39. Mattel Czech Republic s.r.o., The Forum, Václavské nám. 19, 11000 Praha 1. Mattel, 333 Continental Boulevard, El Segundo, CA 90245, USA. Consumer Services: 1-800-465-MEGA (6342). Mattel Canada Inc., Mississauga, Ontario L5R 3W2. Consumer Services: You may call us free at/ Composez sans frais le 1-800-524-8697. Importado y distribuido por Mattel de México, S.A. de C.V., Miguel de Cervantes Saavedra No. 193, Pisos 10 y 11, Col. Granada, Alcaaldia Miguel Hidalgo, C.P. 11520, México, Ciudad de México. R.F.C. MME-920701-NB3. Tels.: 59-05-51-00 Ext. 5206 ó 01-800-463-59-89. Mattel Chile, S.A., Avenida Américo Vespucio 501-B, Quilicura, Santiago. Tel.: 1230-020-6213. Servicio al consumidor Venezuela: Tel.: 0-800-100-9123. Mattel Argentina, S.A., Av. Libertador 1000, Piso 11 - Oficinas 109 y 111, Vicente López - Prov. Buenos Aires. Tel.: 0800-666-3373. Mattel Colombia, S.A., Calle 123#07 P.5, Bogotá. Tel.: 01800-710-2069. Mattel Perú, S.A., Av. Juan de Arona # 151, Centro Empresarial Juan de Arona, Torre C, Piso 7, Oficina 704, San Isidro, Lima 27, Perú. RUC: 20425853865. Reg. Importador: 02350-12-JUE-DIGESA. Tel.: 0800-54744. E-mail Latinoamérica: servicio.clientes@mattel.com. Mattel do Brasil Ltda. - CNPJ : 54.558.002/0001-20 - Rua Verbo Divino, 1488 - 2º. Andar - 04719-904 - Chácara Santo Antônio - São Paulo - SP - Brasil. Serviço de Atendimento ao Consumidor: fone 0800 575 0780. E-mail: sac.mattel@brasil.mattel.com

**ATTENTION :** DANGER  
D'ÉTOUFFEMENT. - PRÉSENCE DE PETITS  
ÉLÉMENTS. NE CONVIENT PAS AUX ENFANTS DE  
MOINS DE 3 ANS.

**ATENÇÃO!** NÃO INDICADO / NÃO  
RECOMENDÁVEL PARA CRIANÇAS MENORES DE 3  
(TRÊS) ANOS POR CONTER PARTE(S) PEQUENA(S)  
QUE PODE(M) SER ENGOLIDA(S) OU ASPIRADA(S)  
PODENDO PROVOCAR ASFIXIA.

警告:  
のどにつまる危険 小さな部品が含まれています  
3歳以下の子供には与えないで下さい。

**警告!**  
不适合3岁以下儿童使用。  
内含小零件。

**⚠ WARNING : CHOKING HAZARD. - Small parts.**

Not for children under 3 years.  
ADVERTENCIA: PELIGRO DE ATRAGANTAMIENTO. Juguete no recomendado  
para menores de 3 años, porque contiene piezas pequeñas que podrían  
provocar asfixia en caso de ser ingeridas o inhaladas por el/la niño/a.  
AVVERTENZA: Contiene pezzi di piccole dimensioni.

ACHTUNG: Kleine Teile.  
OSTRZEŻENIE: Małe części. Niebezpieczeństwo zadławienia.

WAARSCHUWING: Kleine onderdelen  
ПРЕДУПРЕЖДЕНИЕ: Мелкие детали.

ADVASEL: Indeholder små dele.

WARNING: Små delar

ADVASEL: Små deler

VAROITUS: Pieniä osia

ΠΡΟΣΟΧΗ: Περιλαμβάνονται μικρά κομμάτια.

UVARI: Kūçük parçalar.

UPOZORNĚNÍ: Malé díly

UPOZORNENIE: Malé časti

FIGYELMEZTETÉS: Kis alkatrészek.



0-3

**Missing pieces?**

**Pièces manquantes?**

¿Partes faltantes? • Perdeu peças?  
Fehlende Teile? • Не хватает деталей?

[support.megabrands.com](http://support.megabrands.com)

©2020 The Pokémon Company International.  
©1995–2020 Nintendo / Creatures Inc. / GAME  
FREAK inc. TM, ®, and character names are  
trademarks of Nintendo.

© 2020 The Pokémon Company International.  
©1995–2020 Nintendo/Creatures Inc./GAME  
FREAK inc. TM, ® et les noms des personnage  
sont des marques de Nintendo.

تحذير:  
غير مناسبة للأطفال دون 36 شهراً - قطع صغيرة.

MEGA  
CONSTRUX

POKÉMON

MORE TO BUILD! // ENCORE PLUS À CONSTRUIRE! // MÁS PARA CONSTRUIR!  
MAIS PARA CONSTRUIR! // MEHR ZUM BAUEN! // СОБЕРИ ИХ ВСЕХ!



6900



6998

10+  
PRO  
BUILDERS

Are you ready for  
the next challenge?  
Prêt pour le prochain défi?

¿Estás listo para el siguiente desafío?  
Você está pronto para o próximo desafio?  
Bist du bereit für die nächste Herausforderung?  
Вы готовы к следующему испытанию?



Set(s) sold separately and subject to availability. / Ensemble(s) vendu(s) séparément. Certains produits peuvent ne pas être commercialisés. / Se vende(n) por separado y está(n) sujeto(s) a disponibilidad. / Conjunto(s) vendido(s) em separado e sujeito(s) à disponibilidade. / Set in vendita separatamente, secondo disponibilità. / Das/Die Set(s) sind separat erhältlich. / Zestaw(y) sprzedawany(e) oddzielnie w zależności od dostępności. / Set(s) apart verkrijgbaar en afhankelijk van beschikbaarheid. / Набор(-ы) продаются отдельно, при наличии. / Sæt sælges separat og så længe lager haves. / Seten säljs separat så länge lagret räcker. / Settett/settene selges separat så langt lageret rekker. / Pakkaus/pakkausset myydään erikseen, saatavuus voi vaihdella. / Το(α) σετ πωλούνται ξεχωριστά και ανάλογα με τη διαθεσιμότητα. / Setler ayrı olarak satılır ve stoklarla sınırlıdır. / Set (sety) se prodává (prodávají) samostatně dle aktuální nabídky. / Súprava/-y sa predávajú) samostatne a podľa dostupnosti. / A készlet(ek) külön kapható(k), az elérhetőség változhat. / セット商品は別売りになります。在庫状況は別途ご確認お願いします。 /

تباع المجموعة أو تخضع لتوافرها.  
每套单独发售，按供货情况决定。

Mattel Canada Inc. Mississauga, Ontario L5R 3W2.  
MADE IN CHINA. FABRIQUÉ EN CHINE. FABRICADO NA CHINA. HECHO EN CHINA.  
ИЗГОТОВЛЕНО В КИТАЕ. ÇİN'DE ÜRETİLMİŞTİR. صنع في الصين

©2020 MEGA Brands &™ MEGA Brands.  
Printed in China / Imprimé en Chine

AD-GYG96-01A

1186 MJ, 1, NL

P 0781,964, D797,203, D799,607,  
D799,608, D834,105

