

MEGATM

HotWheelsTM
MONSTER TRUCKS

1

HKF88

**TIGER SHARK CHOMP COURSE
PARCOURS TIGER SHARK**

PISTA DE DENTELLADAS DE TIGER SHARK / CIRCUITO DE DEVASTAÇÃO TIGER SHARK
TIGER SHARK CRASH WETTKAMPF / ИГРОВОЙ НАБОР TIGER SHARK

**SMASH
&
CRASH**TM



Build Construisez

Construye | Constrói
Bauen | Стройте



Share | Partagez

Comparte | Partilha
Teilen | Делитесь

Easy-to-follow steps! Des instructions faciles à suivre!

¡Pasos fáciles de seguir!
Passos fáceis de seguir!
Einfache Schritte!
Простые действия!



Devices not included | Appareils non inclus | Dispositivos no incluido | Dispositivos
não incluídos | Geräte nicht enthalten | Устройства не входят в комплект

megaunboxed.com



BUILDING TOOL OUTIL DE CONSTRUCTION

HERRAMIENTA DE CONSTRUCCIÓN
BAUWERKZEUG
FERRAMENTA DE MONTAGEM
ИНСТРУМЕНТ ДЛЯ КОНСТРУИРОВАНИЯ

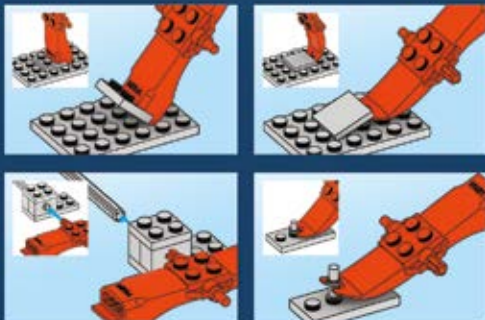



1



2

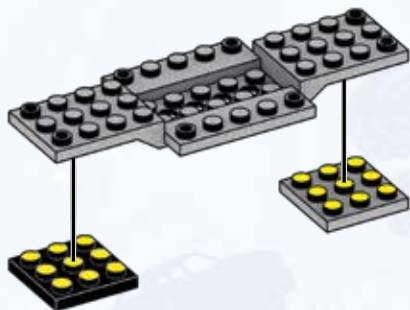
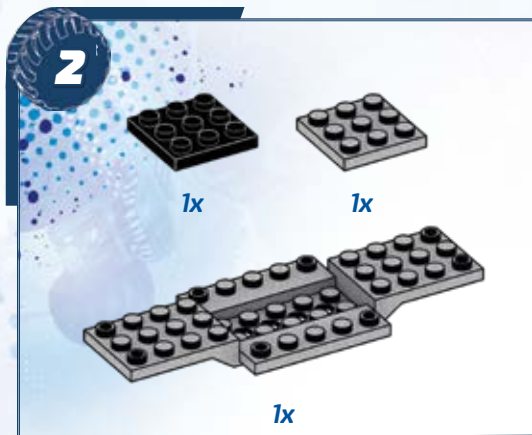

3



1x



1x

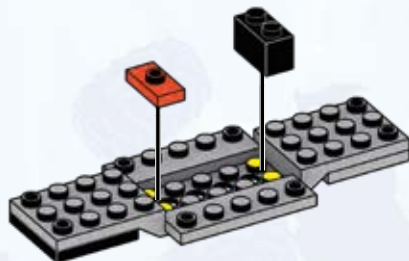

4

2x

1x

5

2x

1x

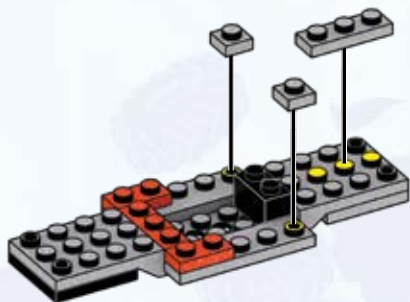
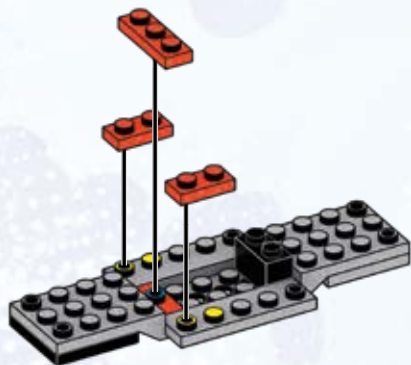

6



1x



1x

7



1x

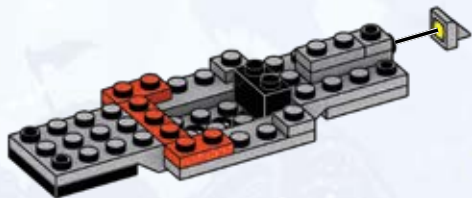
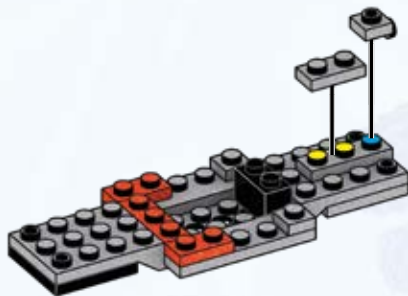

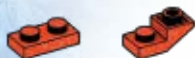
8

1x

1x

9

12x

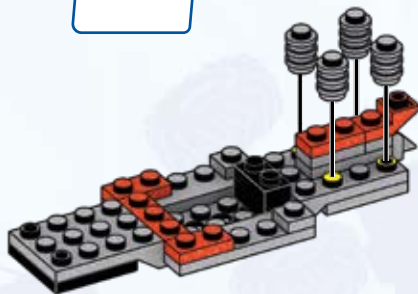
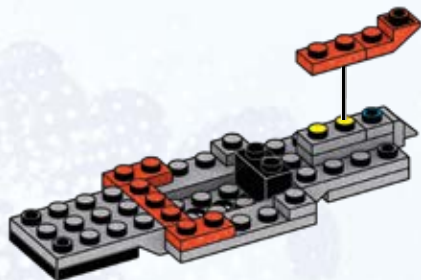
x4

10



1x

11



1x



1x

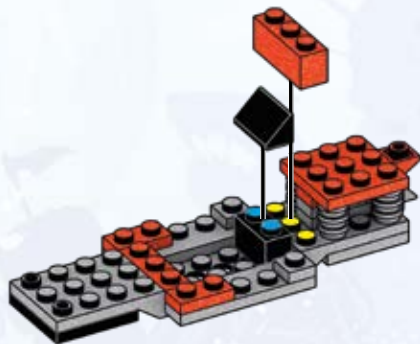
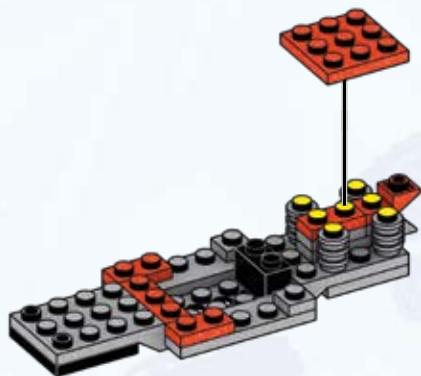

12



1x



1x

13



6x

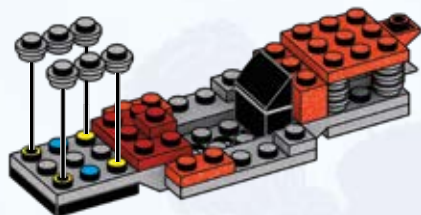
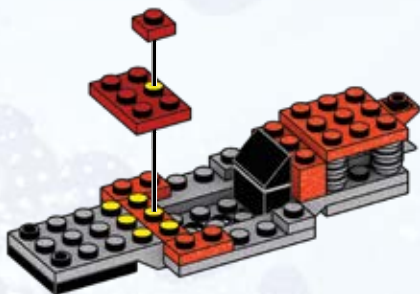

14



2x

15



2x



1x

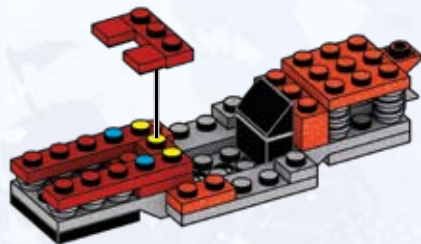
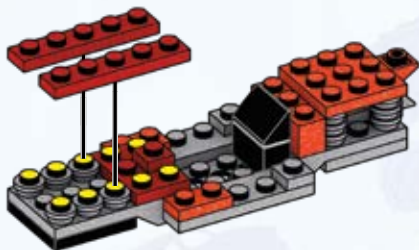

16



1x



1x

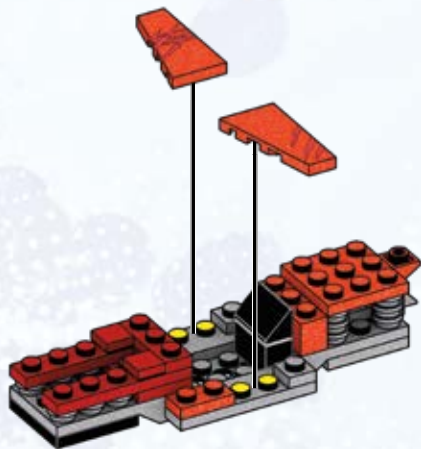

17



1x



1x

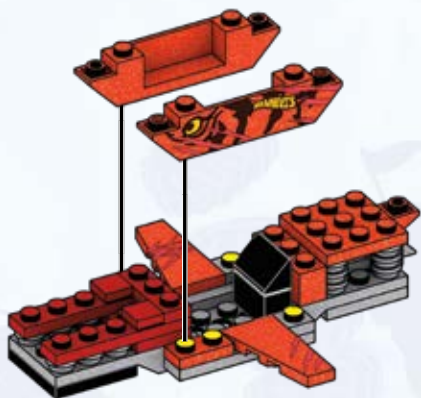

18



1x

19



1x



1x



1x

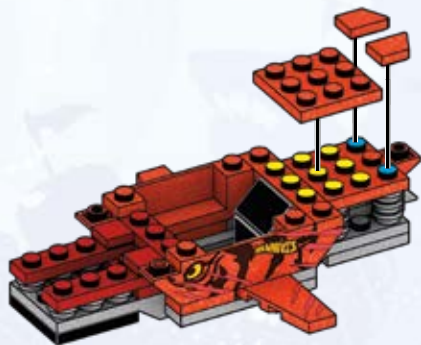
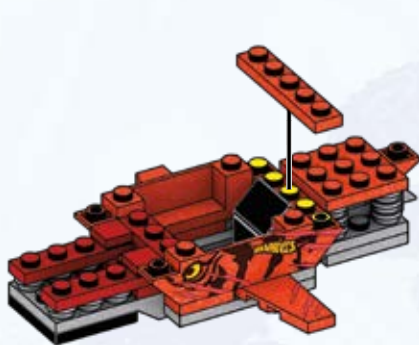

20



1x



1x

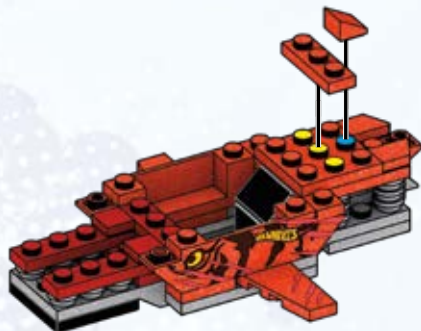

21



1x



1x



1x

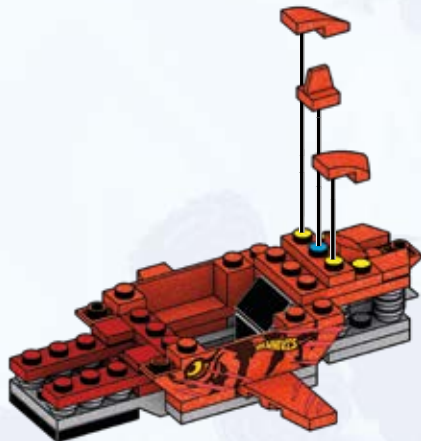

22



1x

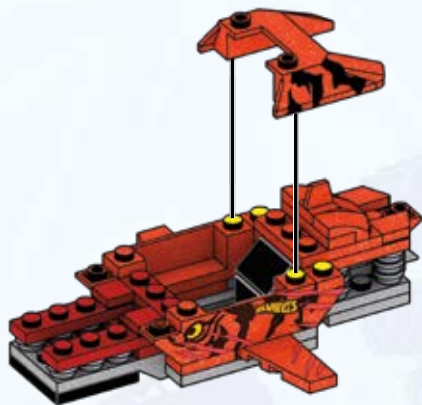

1

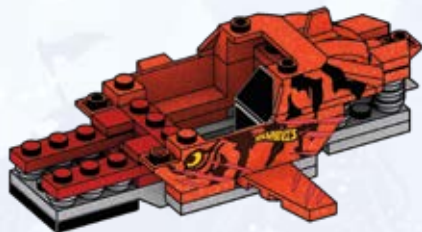

2

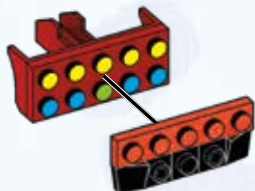
23*1x**1x***24***1x**1x**1x**1x*

25



1x



1x

26



2x



1x



1x

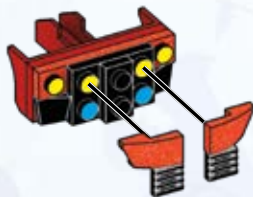
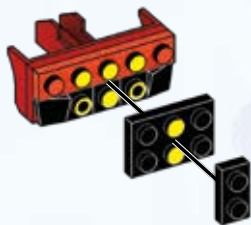

27



1x

28

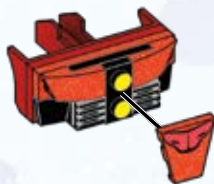

1



2

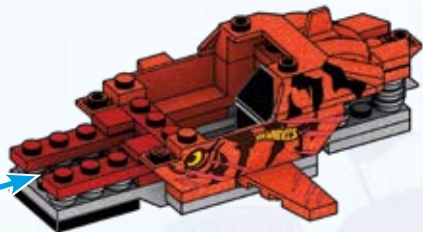

29



1x



1x



1x

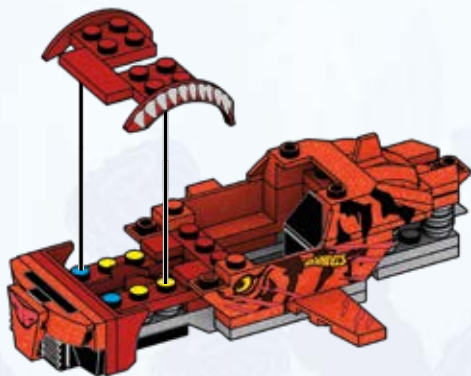

30



2x



1x

31



1x



1x

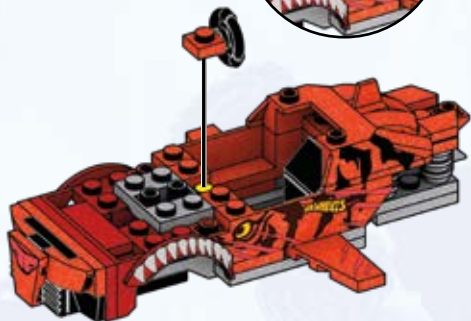
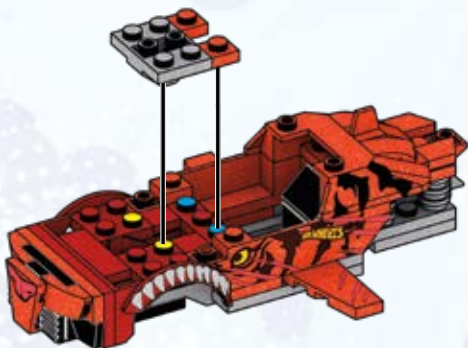
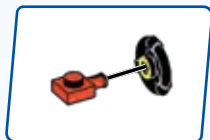

32



1x



1x



1x



1x



1x



1



2



3

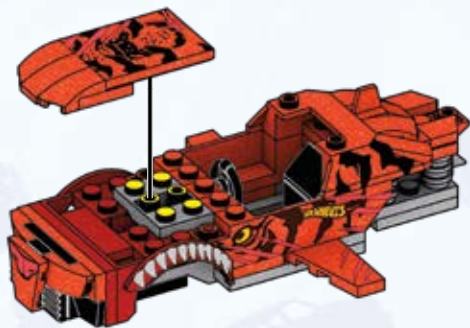

34



1x



1x



1x



1x

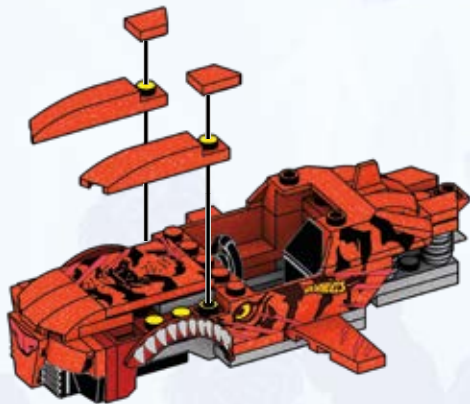

35



1x

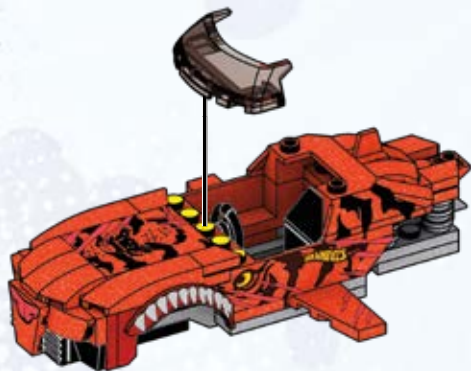

36



1x



1x



37



1x

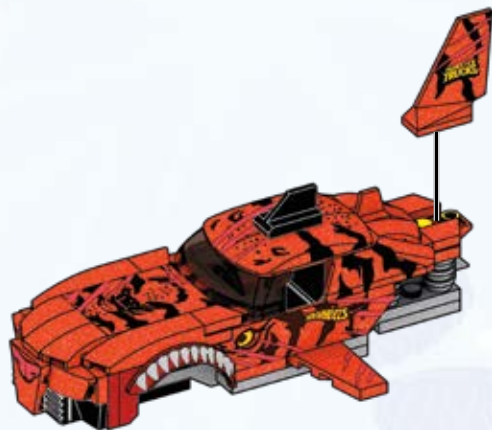

1



2

38



1x

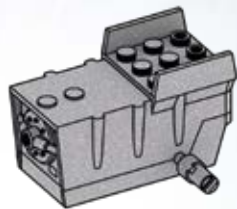

1x

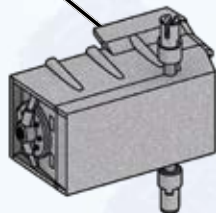
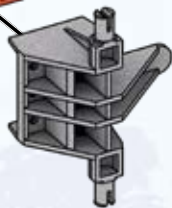
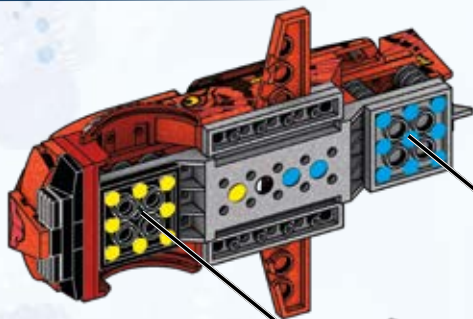

1

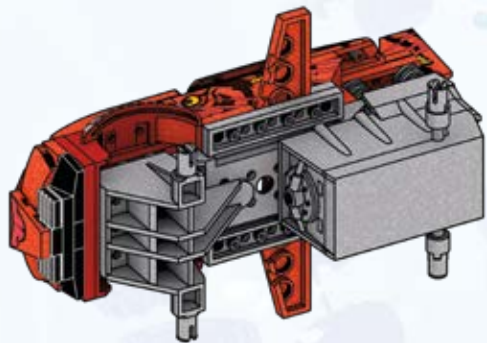

4

39



2x



2x

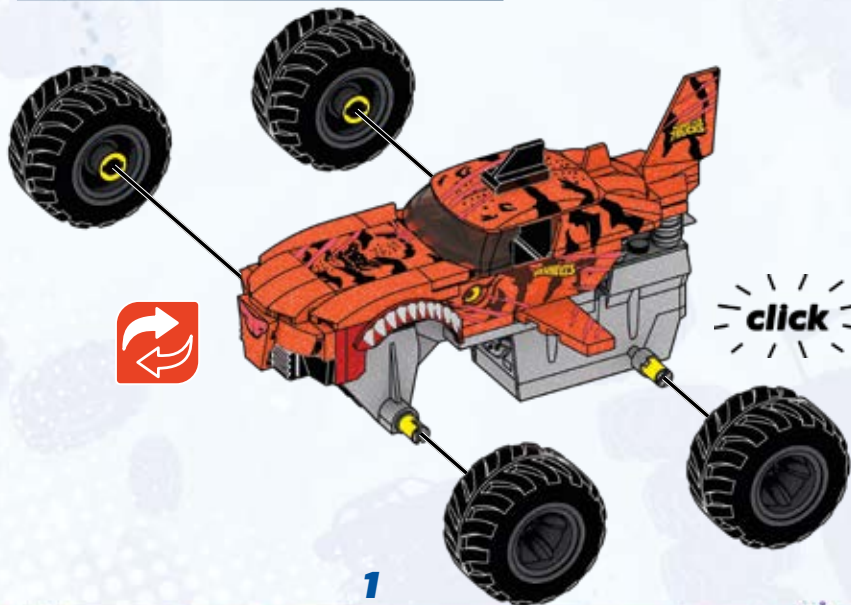





1



2

**SMASH
&
CRASH™**

**PULL BACK
AND GO!**

**TIREZ LE
VÉHICULE
VERS L'ARRIÈRE
ET PARTEZ !**

61 cm
(24 in)



**¡HAZLO RODAR HACIA ATRÁS Y SUÉLTALO!
PUXA PARA TRÁS PARA ARRANCAR!
ZURÜCKZIEHEN UND LOSS GEHT'S! ПОТЯНИ И ЗАПУСТИ!**

**HIT THE RAMP!
PRENEZ LA RAMPE !**

**¡SALTA POR LA RAMPA! • SOBRE A RAMPA!
AUF DIE RAMPE FAHREN! • ЗАЕЗЖАЙ ПО РАМПЕ!**



**HOOD POPS OFF!
LE CAPOT SAUTE !**

**¡EL CAPÓ SALE DESPEDIDO!
O CAPÓ SALTA! • DIE MOTORHAUBE
ÖFFNET SICH! • КАПОТ ОТКРЫВАЕТСЯ!**





Warning: Do not aim at eyes or face. Only use projectiles supplied with this toy. Do not fire at point blank range.

Advertencia: No apuntar a los ojos ni a la cara. Si adquirió un modelo con proyectil(es) incluido(s): Utilizar únicamente el(los) proyectil(es) incluido(s) en este juguete. No disparar a personas ni animales. No disparar a quemarropa.

ATTENTION : NE PAS VISER LES YEUX OU LE VISAGE. NE PAS UTILISER D'AUTRES PROJECTILES QUE CEUX FOURNIS AVEC CE JOUET. NE PAS TIRER À BOUT PORTANT.

ATENÇÃO!: NÃO APONTAR PARA OS OLHOS E PARA A FACE. NÃO UTILIZAR PROJÉTEIS DIFERENTES DOS PROVIDOS E DOS INDICADOS PELO FABRICANTE DO BRINQUEDO.

Avvertenza: Non mirare agli occhi o al viso. Usare solo i proiettili forniti con il giocattolo. Non sparare a distanza ravvicinata.

Achtung: Nicht auf Augen oder Gesicht zielen. Nur die zu diesem Spielzeug gehörenden Projektile verwenden. Nicht auf Menschen oder Tiere oder aus nächster Nähe zielen.

Ostrzeżenie: Nie celuj w oczy i twarz. Nie strzelaj pociskami innymi niż dostarczone z zabawką. Nie strzelaj z bliska.

Waarschuwing: niet op ogen of gezicht richten. Gebruik uitsluitend de bijgeleverde projectielen. Niet van te dichtbij afschieten.

Предупреждение: Не направляйте в глаза или лицо. Используйте только снаряды, входящие в комплект. Не стреляйте со слишком близкого расстояния.

Advarsel: Sigt ikke mod øjne eller ansigt. Brug kun de projektiler, som følger med legetøjet. Skyd ikke direkte på personer eller ting.

Varning: Sikta inte mot ögon eller ansikte. Använd endast projektiler som medföljer leksaken. Fyra inte av på mycket nära håll.

Advarsel: Du må ikke sikte mot øyne eller ansikt. Bruk bare prosjektilene som følger med leken. Ikke skyt på noe på kloss hold.

Varoitus: Älä tähtää silmiin äläkä kasvoihin. Käytä ainoastaan tämän tuotteen mukana tulleita ammuksia. Älä ammu lähietäisyydeltä.

Προσοχή: Μην στοχεύετε στα μάτια ή στο πρόσωπο. Χρησιμοποιείτε μόνο τα βλήματα που περιλαμβάνονται. Μην στοχεύετε όταν δεν έχετε ορατότητα.

Uyarı: Göze veya yüze nişan almayın. Fırlatmak için yalnızca bu oyuncakla birlikte verilen objeleri kullanın. İnsanlara ve hayvanlara nişan almayın.

Upozornění: Nemířte na oči nebo na obličej. Používejte pouze projektily dodávané s touto hračkou. Nestřílejte z bezprostřední blízkosti.

Upozornenie: Nemierťte do očí ani do tváre. Používajte iba strely dodané spolu s touto hračkou. Nestrieľajte z bezprostrednej blízkosti.

Figyelmeztetés: Tilos szemre és arcra célozni. Kizárólag a játékhöz mellékelt lövedékeket használja. A játékkal tilos közvetlen közelről löni.

警告: 目や顔に向けてのご使用、至近距離での発射はお控えください。このおもちゃの同梱物のみご使用ください。

تحذير: يجب عدم التصويب باتجاه العينين أو الوجه. يجب استخدام المقننات المزودة مع هذه اللعبة فقط. يجب عدم الإطلاق من مدى قريب.

警告: 请勿对着眼睛或脸部发射。仅使用本玩具自带的抛射物。请勿近距离射击。

18x
AM01113APG



2x
AM07223AXW



2x
AM79666F



1x
AM03328AXW



1x
AM03328F



2x
AM03328AYN



2x
AM03328APG



1x
AM80546AYN



1x
AM77574APG



2x
AM74299AYN



2x
AM74300AYN



1x
AM17127AYN



1x
AM76277APG



1x
AM80055AYN



1x
AM07590AYN



3x
AM09393AYN



1x
AM09393F



1x
AM09393APG



1x
AM81383F



1x
AM72494F



1x
AM72495F



1x
AM72002AYN



3x
AM74427AYN



3x
AM74426AYN



1x
AM78486AYN



1x
AS-HKF88-05



1x
AM18269F



1x
AM03019F



1x
AM09013F



1x
AM80966AXW



1x
AM01314APG



1x
AM01314AXW



2x
AM01314AYN



1x
AM16384AYN



1x
AM03772F



1x
AM03772AYN



1x
AM03772AXW



1x
AM81632APG



1x
AM81163F



1x
AM81163APG



2x
AM81163AYN



1x
AS-HKF88-09



1x
AS-HKF88-10



1x
AM19014AYN



1x
AM19013AYN



2x
AM07475AXW



2x
AM07475AYN



1x
AS-HKF88-04



1x
AM80965AXW





1x
AS-HKF88-20



1x
AS-HKF88-21



1x
AM80538AMD



1x
AM81631AXW



1x
AS-HKF88-06



1x
AS-HKF88-19



1x
AS-HKF88-11



1x
AS-HKF88-07



1x
AS-HKF88-08

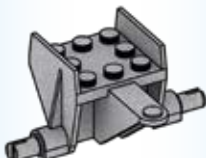

1x
AM81331APG

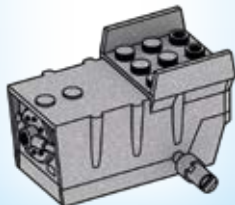

1x
AS-HKF88-01



2x
AS-HKF88-02



2x
AS-HKF88-03



1x
FIG-HKF88-A

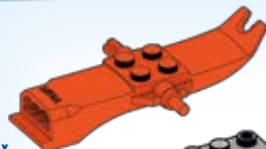

1x
AM80855MCX



1x
AM80975APG

Missing pieces? • Pièces manquantes?

¿Partes faltantes? • Perdeu peças?
Fehlen Teile? • Не хватает деталей?

support.megabrand.com

ATTENTION : DANGER
D'ÉTOUFFEMENT. - PRÉSENCE DE PETITS
ÉLÉMENTS. NE CONVIENT PAS AUX ENFANTS DE
MOINS DE 3 ANS.

ATENÇÃO! NÃO INDICADO / NÃO
RECOMENDÁVEL PARA CRIANÇAS MENORES DE 3
(TRÊS) ANOS POR CONTER PARTE(S) PEQUENA(S)
QUE PODE(M) SER ENGOLIDA(S) OU ASPIRADA(S)
PODENDO PROVOCAR ASFIXIA.

警告:

のどにつまる危険 小さな部品が含まれています
3歳以下の子供には与えないで下さい。

警告!
不适合3岁以下儿童使用。
内含小零件。

WARNING : CHOKING HAZARD. - Small parts. Not for children under 3 years.
ADVERTENCIA : PELIGRO DE ATRAGANTAMIENTO. Juguete no recomendado
para menores de 3 años, porque contiene piezas pequeñas que podrían
provocar asfixia en caso de ser ingeridas o inhaladas por el/la niño/a.

AVVERTENZA : Contiene pezzi di piccole dimensioni.

ACHTUNG : Kleine Teile.

OSTRZEŻENIE : Małe części. Niebezpieczeństwo zadławienia.

WAARSCHUWING : Kleine onderdelen

ПРЕДУПРЕЖДЕНИЕ : Мелкие детали.

ADVARSEL : Indeholder små dele.

VARNING : Smådelar

ADVARSEL : Små deler

VAROITUS : Pieniä osia

ΠΡΟΣΟΧΗ : Περιλαμβάνονται μικρά κομμάτια.

UYARI : Küçük parçalar.

UPOZORNĚNÍ : Malé díly

UPOZORNENIE : Malé časti

FIGYELMEZTETÉS : Kis alkatrészek.



تحذير:

غير مناسبة للأطفال دون 36 شهراً - قطع صغيرة.



Mattel Europa B.V., Gondel 1, 1186 MJ Amstelveen, Nederland. Mattel U.K. Limited, The Porter Building, 1 Brunel Way, Slough SL1 1FQ, UK. Mattel France, Parc de la Cerisaie, 1/3/5 allée des Fleurs, 94260 Fresnes Cedex. N° Cristal 0969 66 99 99 (Número non surtaxé) ou www.lesjouetsmattel.fr Mattel Belgium, Trade Mart, Atomiumsquare, Bogota 202 - B 275, 1020 Brussels. Gratis nummer België: 0800 - 16 9636 Gratis nummer Luxemburg: 800 - 22 784 - Gratis nummer Nederland: 0800 - 262 88 35. Deutschland : Mattel GmbH, Solmsstraße 4, D-60486 Frankfurt am Main. Schweiz: Mattel AG, Kirchstrasse 24, CH-3097 Liebefeld. Österreich: Mattel Ges.m.b.H., Campus 21, Liebermannstraße A01 404, A- 2345 Brunn/Gebirge. Mattel Italy Srl, Via Bracco, 6-MAC 6, 20159 Milano, Italy. Servizio assistenza clienti: Customersrv.it@mattel.com - Numero verde 800 11 37 11. Mattel España, S.A., Aribau 200. 08036 Barcelona. c.servicio.spain@mattel.com Tel: 900 102 390 <http://www.service.mattel.com/es>. Mattel East Asia Ltd., Room 503-09, North Tower, World Finance Center, Harbour City, Tsimsatsui, HK, China. Tel: (852) 3185-6500. Diimport & Diedarkan Oleh: Mattel Continental Asia Sdn Bhd. Level 19, Tower 3, Avenue 7, No. 8 Jalan Kerinchi, Bangsar South, 59200 Kuala Lumpur, Malaysia. Mattel South Africa (PTY) LTD, Office 102 B, 30 Melrose Boulevard, Johannesburg 2196. Dystributor: Mattel Poland Sp. z o.o., Warsaw Trade Tower 34 p., ul. Chłodna 51, 00-867 Warszawa. Mattel Australia Pty. Ltd., 658 Church St., Richmond, Victoria, 3121. Consumer Advisory Service - 1300 135 312. Mattel AEBE, Εθνάρχου Μακαρίου 1, Κτήριο Κ-2, ΤΚ 17561, Πολιούδι Φθέρου. Mattel Ouncakçılık Tic. Ltd. Şti. İçerenköy Mah., Erkut Sok. A Blok No:12 Üner Plaza Kat:9-10 34752 Ataşehir İstanbul. Tel: 0216 570 75 00. Импортёр/Уполномоченная организация: ООО "МАТТЕЛ" Российская Федерация, 105120 Москва, 2-й Сыромятинский переулок, 1; +7 495 287 79 39. Mattel Czech Republic s.r.o., The Forum, Václavské nám. 19, 11000 Praha1. Mattel, 333 Continental Boulevard, El Segundo, CA 90245, USA. Mattel Canada Inc., Mississauga, Ontario L5R 3W2. Consumer Services: You may call us free/at / Composez sans frais le 1-800-524-8697. Importado y distribuido por Mattel de México, S.A. de C.V., Miguel de Cervantes Saavedra No. 193, Pisos 10 y 11, Col. Granada, Alcatlida Miguel Hidalgo, C.P. 11520, México, Ciudad de México. R.F.C. MME-920701-NB3. Tels: 59-05-51-00 Ext. 5206 ó 01-800-463-59-89. Mattel Chile S.A., Avenida Américo Vespucio 501-B, Quilicura, Santiago. Tel.: 1230-020-6213. Servicio al consumidor Venezuela: Tel.: 0-800-100-9123. Mattel Argentina, S.A., Av. Libertador 1000, Piso 11 - Oficinas 109 y 111, Vicente López - Prov. Buenos Aires. Tel.: 0800-666-3373. Mattel Colombia, S.A., Calle 1237-07 P5, Bogotá. Tel: 01800-710-2069. Mattel Perú, S.A., Av. Juan de Arona # 151, Centro Empresarial Juan de Arona, Torre C, Piso 7, Oficina 704, San Isidro, Lima 27, Perú. RUC: 20425853865. Reg. Importador: 02350-12-JUE-DIGESA. Tel: 0800-54744. E-mail Latinoamérica: servicio.clientes@mattel.com. Mattel do Brasil Ltda. - CNPJ : 54.558.002/0001-20 - Rua Verbo Divino, 1488 - 2º. Andar - 04719-904 - Chácara Santo Antônio - São Paulo - SP - Brasil. Serviço de Atendimento ao Consumidor: fone 0800 575 0780. E-mail: sac.matteldobrazil@mattel.com

BUILD YOUR WAY CONSTRUIS TON UNIVERS

HMM49



HKF88



HKF87



Crea tu camino | Constrói à tua maneira
Bauen, wie es dir gefällt | Построй мир гонок

Set(s) sold separately and subject to availability. / Ensemble(s) vendu(s) séparément. Certains produits peuvent ne pas être commercialisés. / Se vende(n) por separado y está(n) sujeto(s) a disponibilidad. / Conjunto(s) vendido(s) em separado e sujeito(s) a disponibilidade. / Set in vendita separatamente, secondo disponibilità. / Das/Die Set(s) sind separat erhältlich. / Zestaw(y) sprzedawany(e) oddzielnie w zależności od dostępności. / Set(s) apart verkrijgbaar en afhankelijk van beschikbaarheid. / Набор(-ы) продаются отдельно, при наличии. / Sæt sælges separat og så længe lager haves. / Seten säljs separat så länge lagret räcker. / Settet/settene selges separat så langt lageret rekker. / Pakkaus/pakkaukset myydään erikseen, saatavuus voi vaihdella. / To(à) oer πωλούνται ξεχωριστά και ανάλογα με τη διαθεσιμότητα. / Setler ayrı olarak satılır ve stoklarla sınırlıdır. / Set (sety) se prodává (prodávají) samostatně dle aktuální nabídky. / Súprava/-y sa predáva(jú) samostatne a podľa dostupnosti. / A készlet(ek) külön kapható(k), az elérhetőség változhat. /

セット商品は別売りになります。在庫状況は別途ご確認お願いします。 / نباع المجموعة أو المجموعات على حدة وتخضع لتوافرها. /

每套单独发售，按供货情况决定。

©D714,887, D781,964, D797,203

Mattel Canada Inc. Mississauga, Ontario L5R 3W2.

MADE IN CHINA. FABRIQUÉ EN CHINE. FABRICADO NA / HECHO EN CHINA.

ИЗГОТОВЛЕНО В КИТАЕ. ÇIN'DE ÜRETİLMİŞTİR. صنع في الصين

HOT WHEELS™ and associated trademarks and trade dress are owned by, and used under license from, Mattel. ©2022 Mattel.

©2022 MEGA Brands &™ MEGA Brands.

Printed in China / Imprimé en Chine

AD-HKF88-01A



1186 MJ, 1, NL



MEGATM

HOT WHEELSTM
MONSTER TRUCKS

2

HKF88

**TIGER SHARK CHOMP COURSE
PARCOURS TIGER SHARK**

PISTA DE DENTELLADAS DE TIGER SHARK / CIRCUITO DE DEVASTAÇÃO TIGER SHARK
TIGER SHARK CRASH WETTKAMPF / ИГРОВОЙ НАБОР TIGER SHARK

**SMASH
&
CRASH**TM



Build Construisez

Construye | Constrói
Bauen | Стройте



Share | Partagez

Comparte | Partilha
Teilen | Делитесь



Easy-to-follow steps! Des instructions faciles à suivre !

¡Pasos fáciles de seguir!
Passos fáceis de seguir!
Einfache Schritte!
Простые действия!



Devices not included | Appareils non inclus | Dispositivos no incluido | Dispositivos não incluídos | Geräte nicht enthalten | Устройства не входят в комплект



megaunboxed.com



1



2

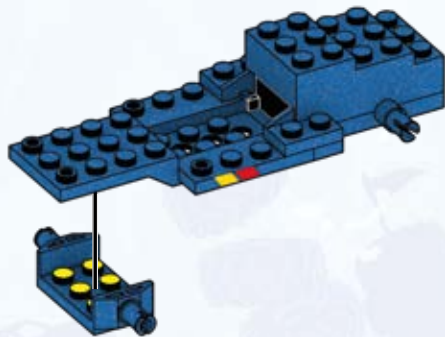

3



1x



1x

4



2x

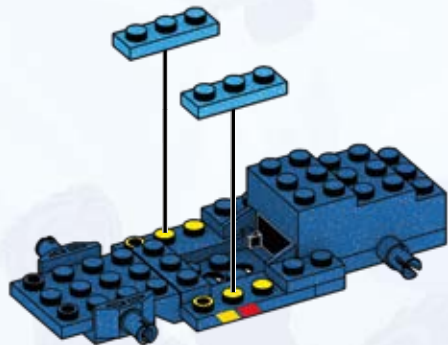
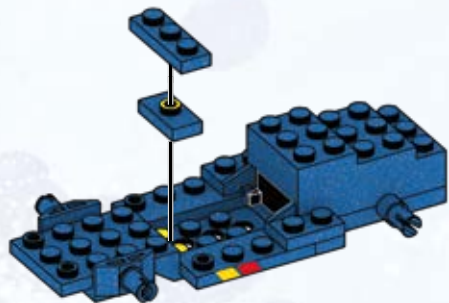

5

2x

1x

6

1x

2x

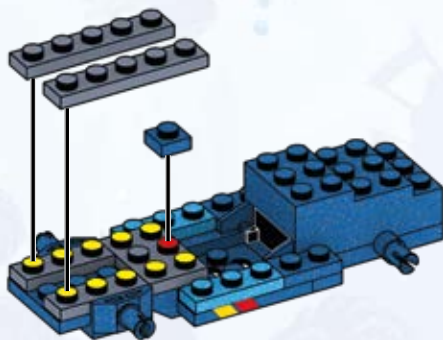
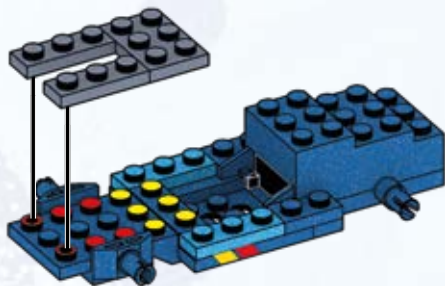

7



1x



1x



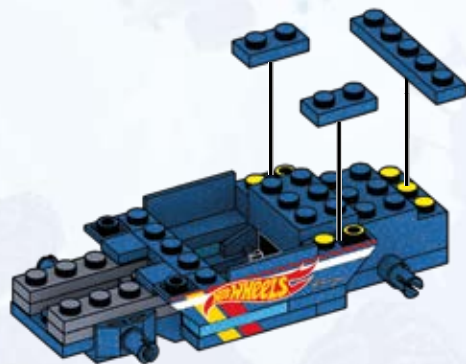
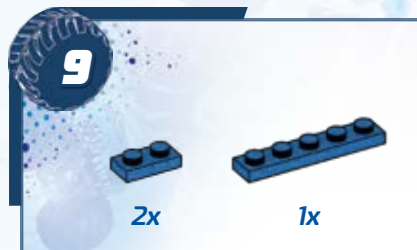
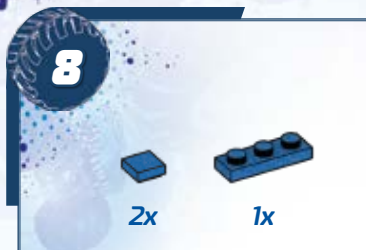

10



2x



2x

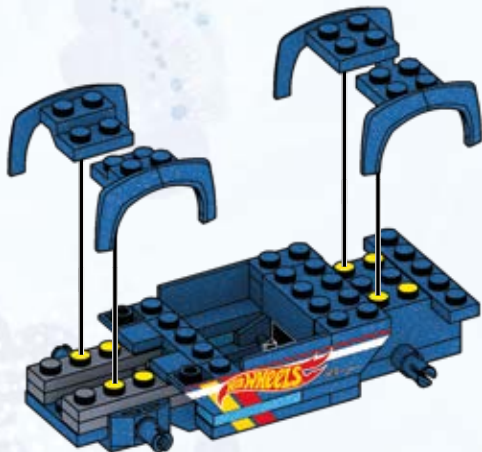

1



2

11



1x

1x



1x

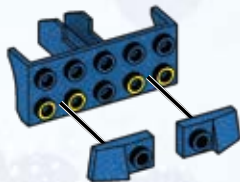

12



2x



1x

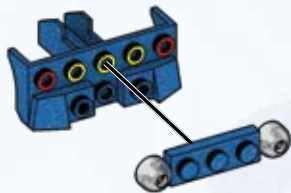

13



2x



1x

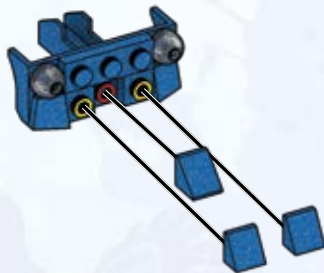

14



3x

15

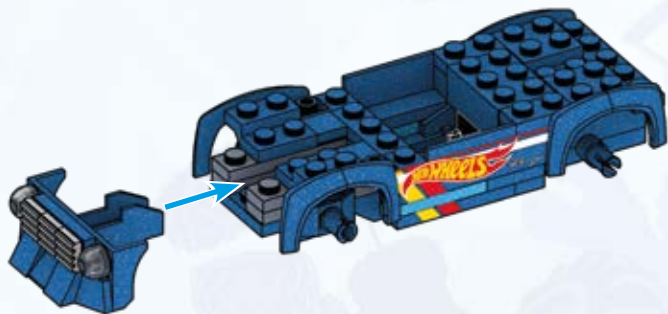
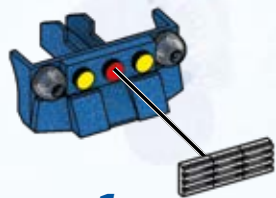

16



2x



1x

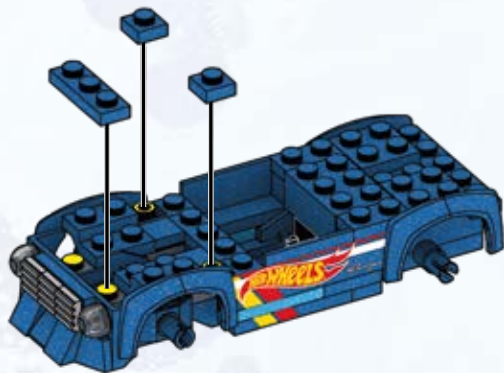

17



1x



1x



18

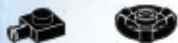

1x

1x

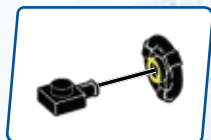

19



1x

1x



20



1x



1x



2x

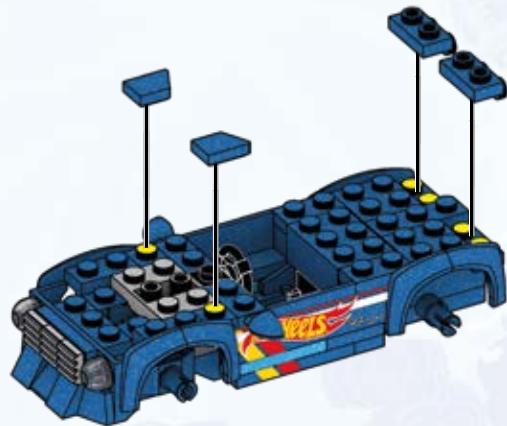

21



1x



1x



1x



1

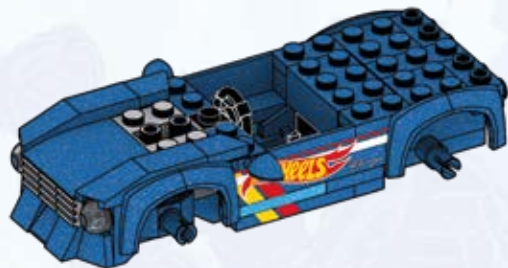

2

22



1x



1x

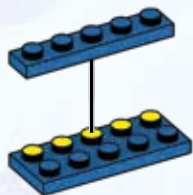

23



2x



1x

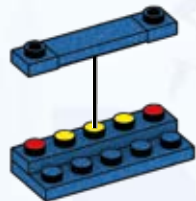

24



1x

2x

25



2x

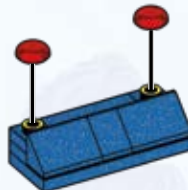
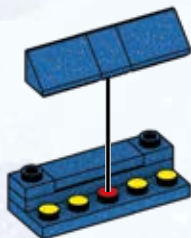

1

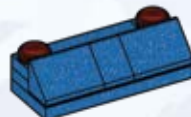

2

26

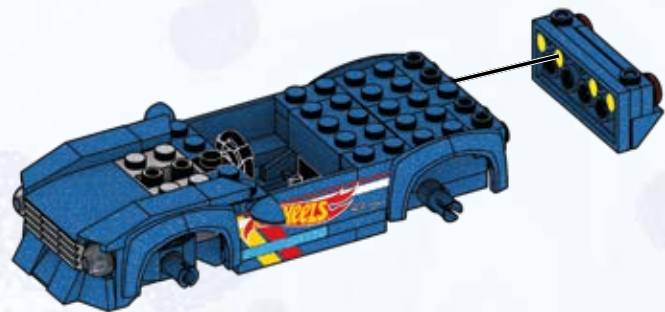

28



2x



1x



1x

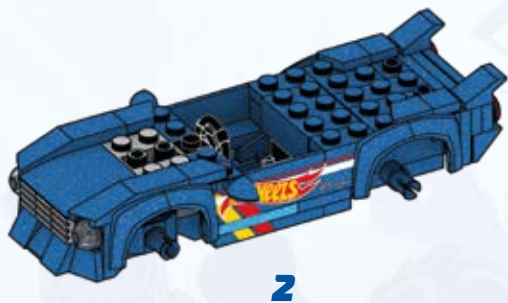
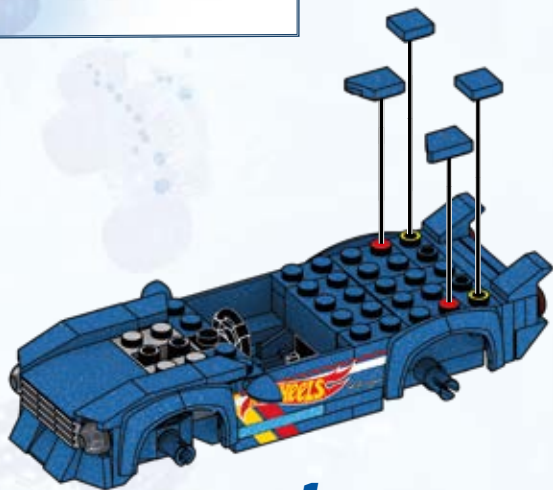

29

1x



1x



1x

**1****2****3****30**

1x



1x



1x

**1****2****3**

31

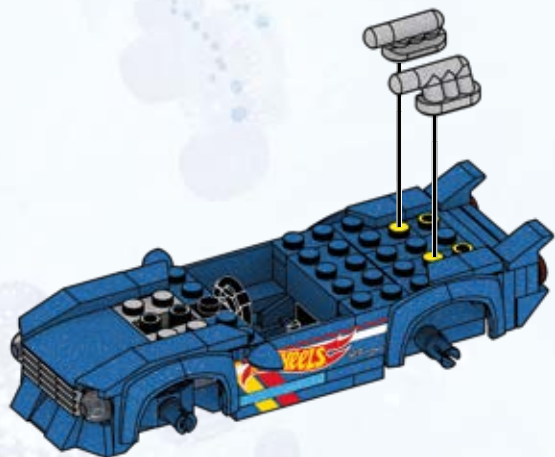

32



1x



1x

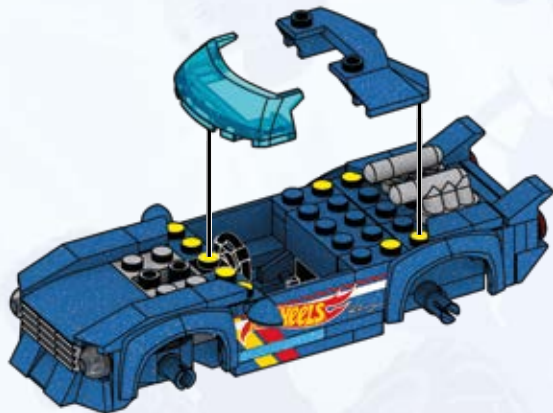

33



2x



1x

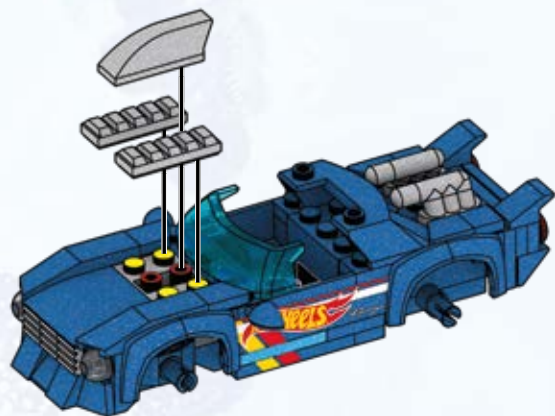

34



1x

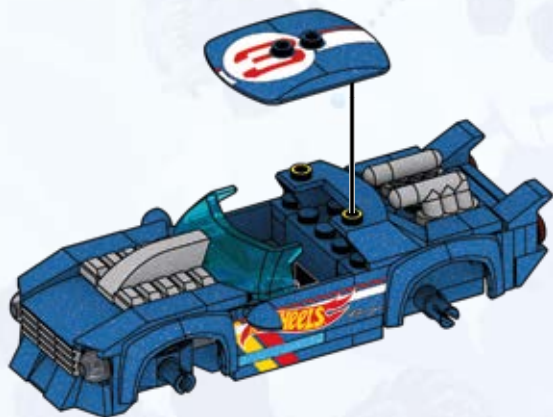

35



4x

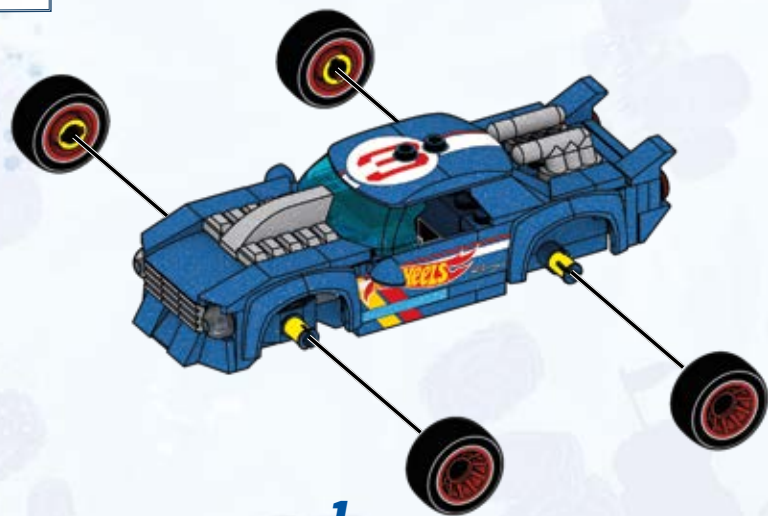

1



2



1



2

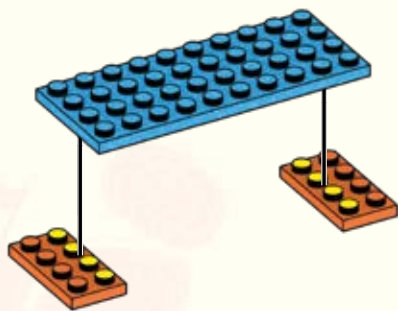
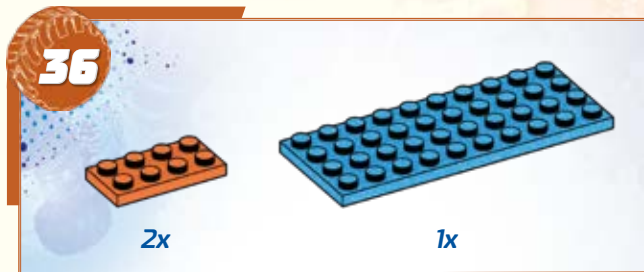

1

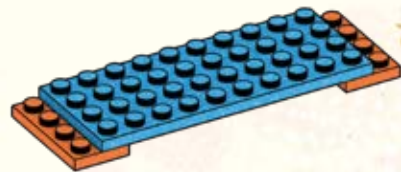

2

37



2x

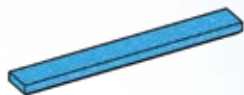

1x

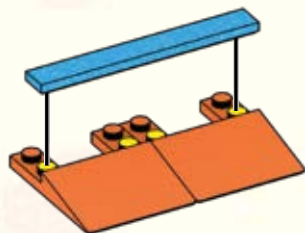

38

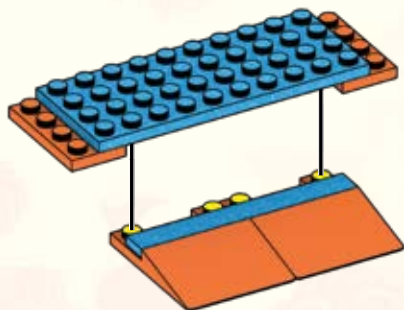

39



3x

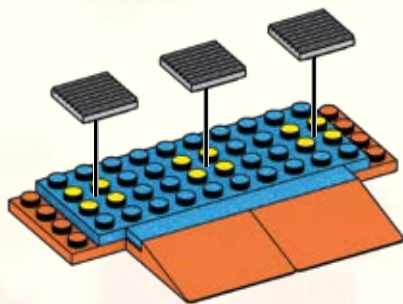

1

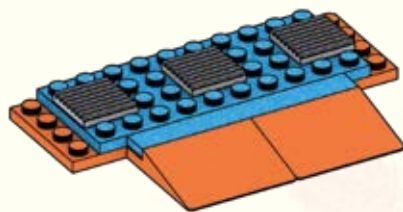

2

40



2x



1x

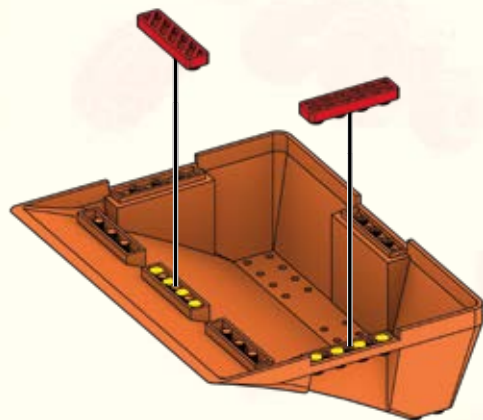

1

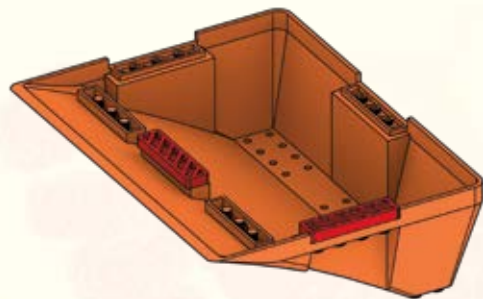

2

41



2x



1x

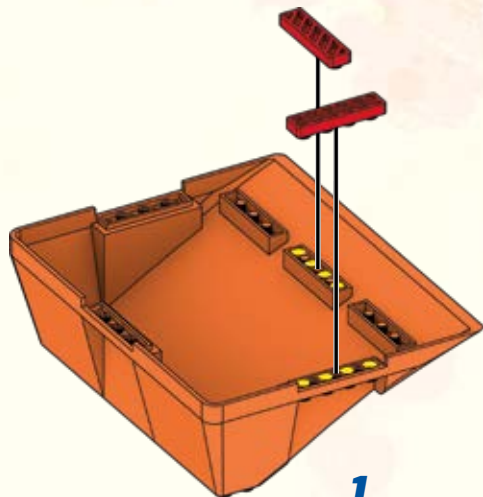

1

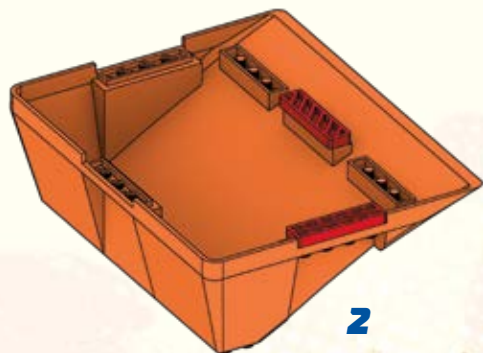

2

42

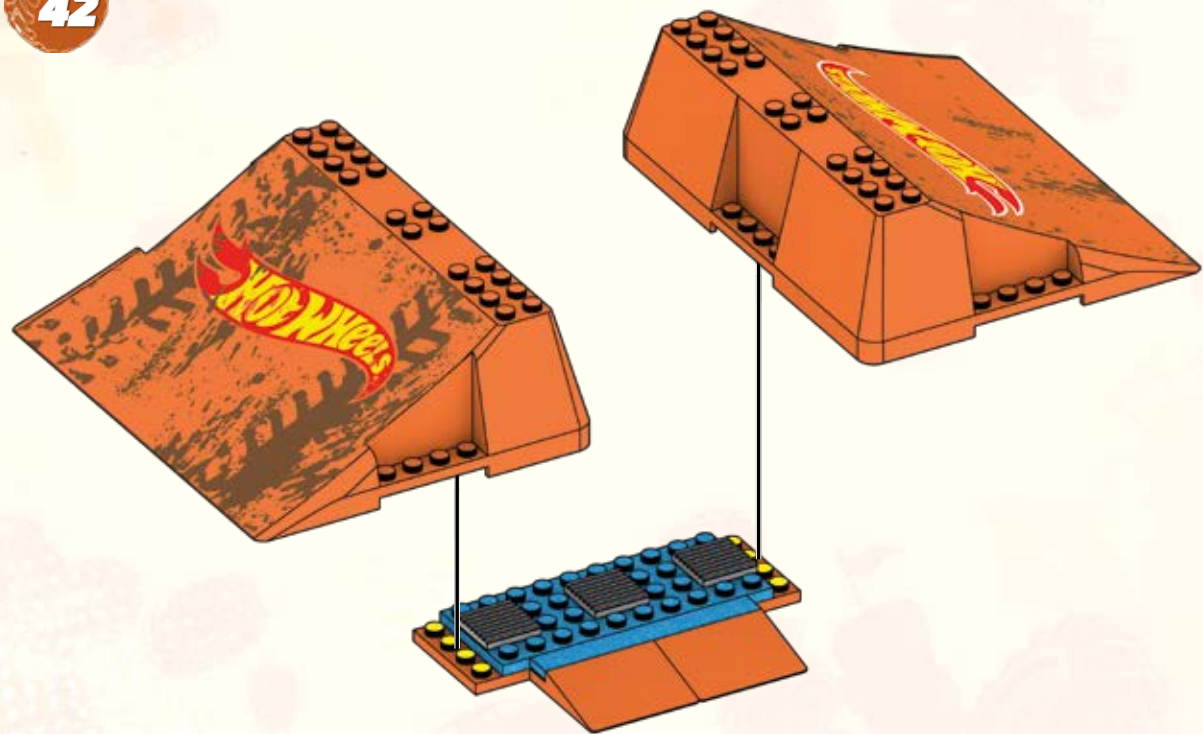

43



2x

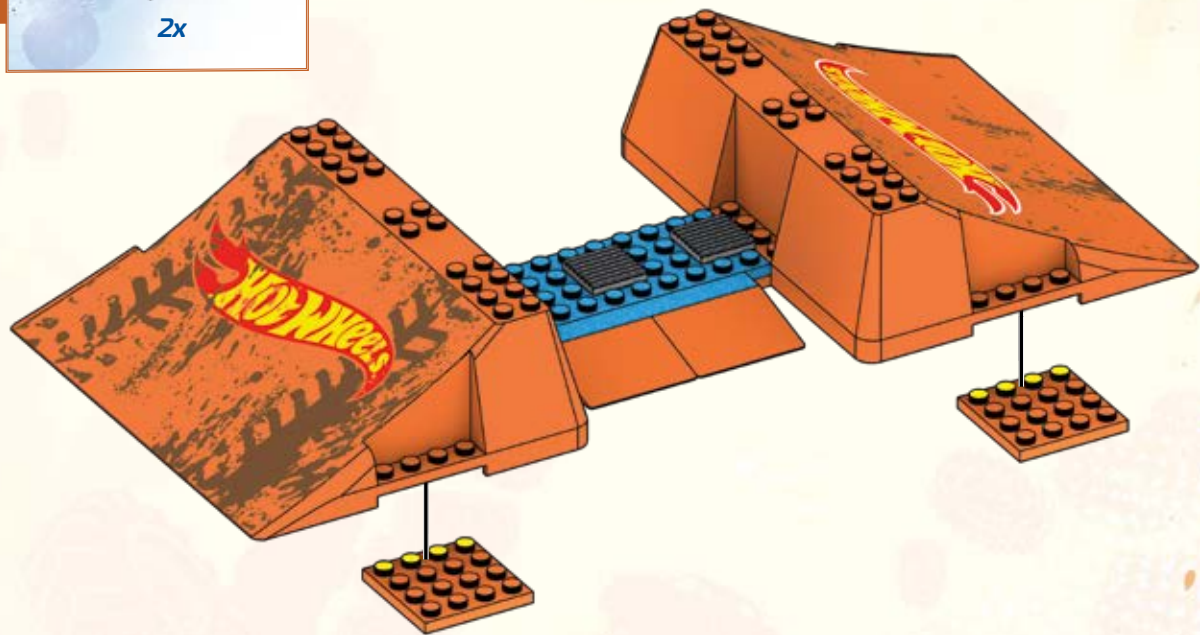

44



2x



2x

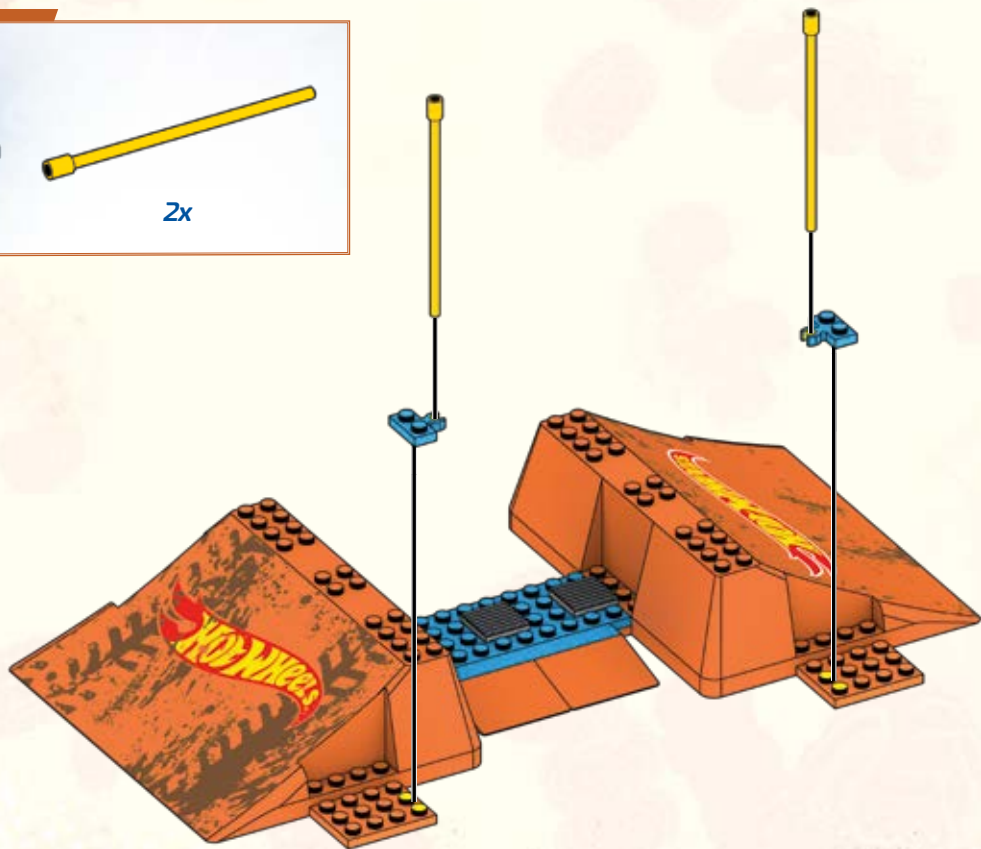

45



2x

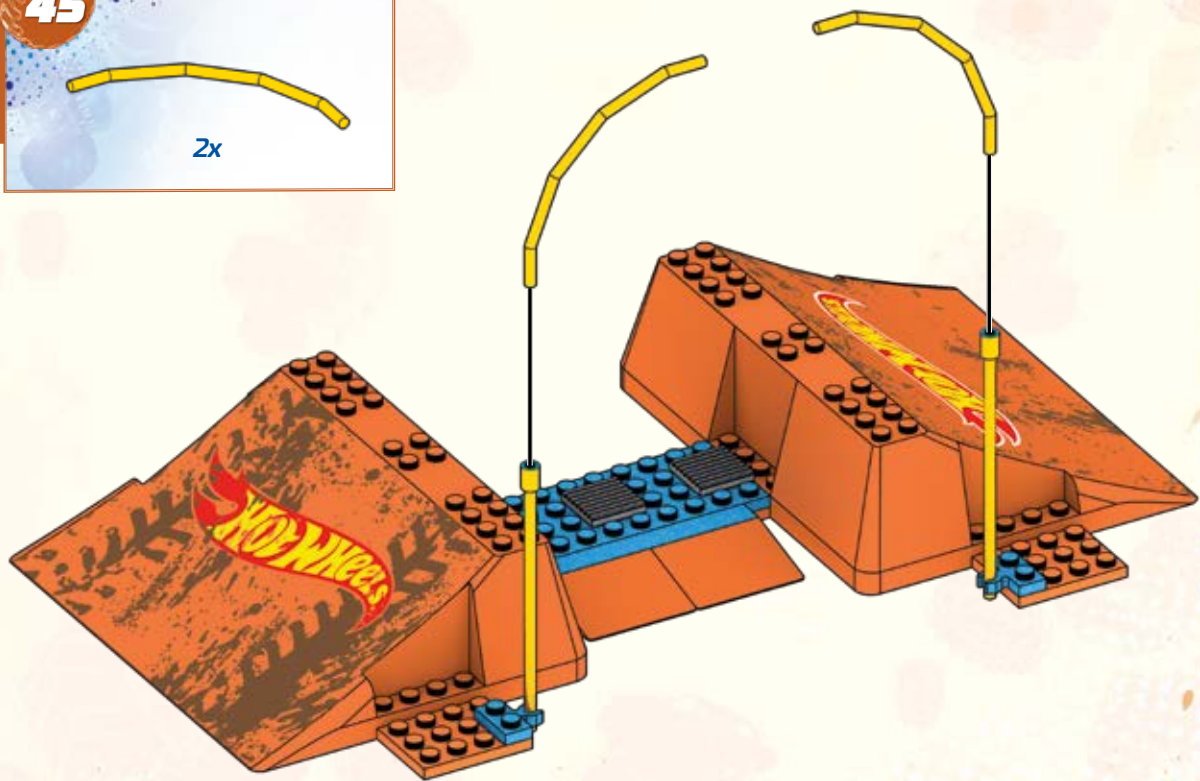

46



4x



4x

x4



1



2

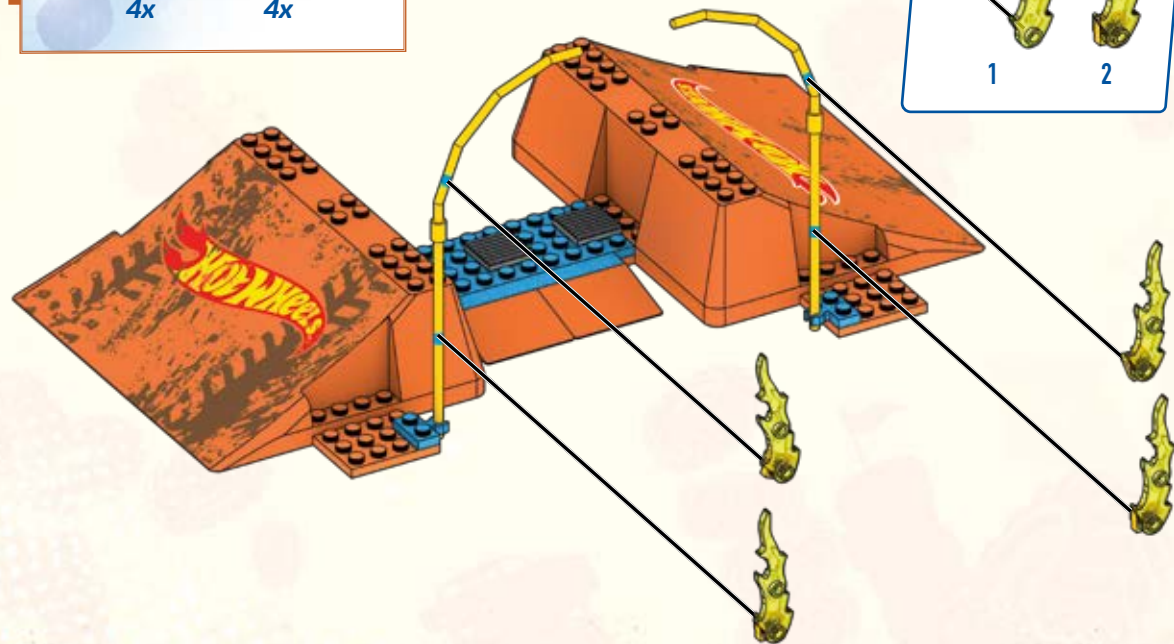

47



4x



4x

x4



1



2

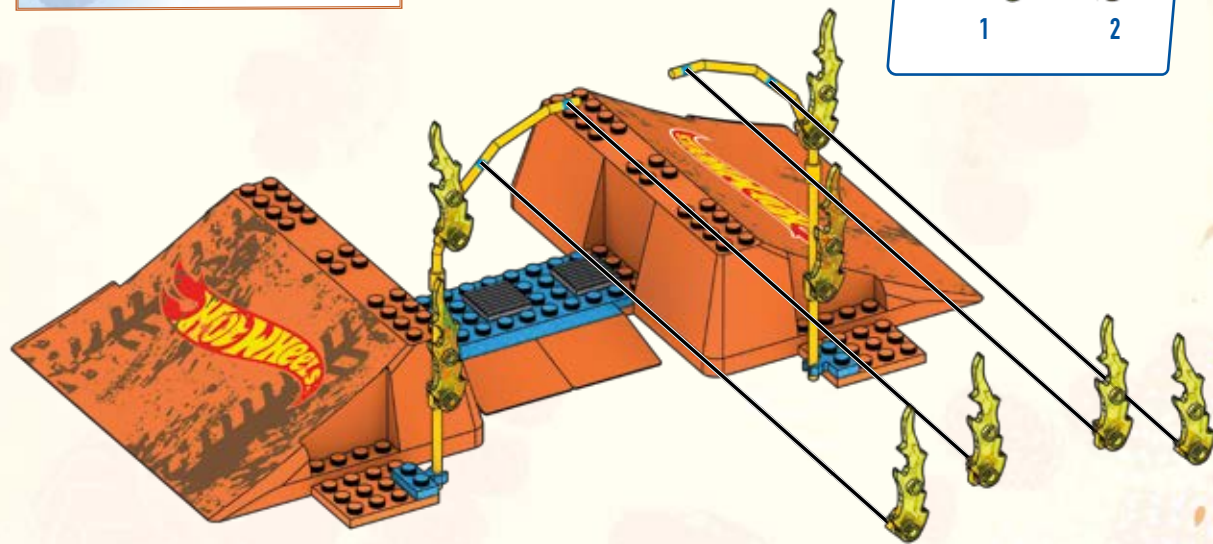

48



3x



3x



3x

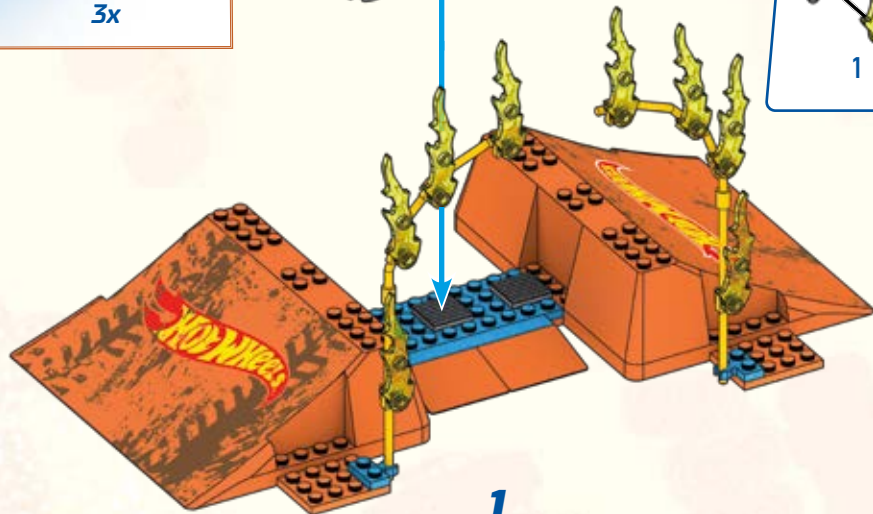

1

x3



1



2



3

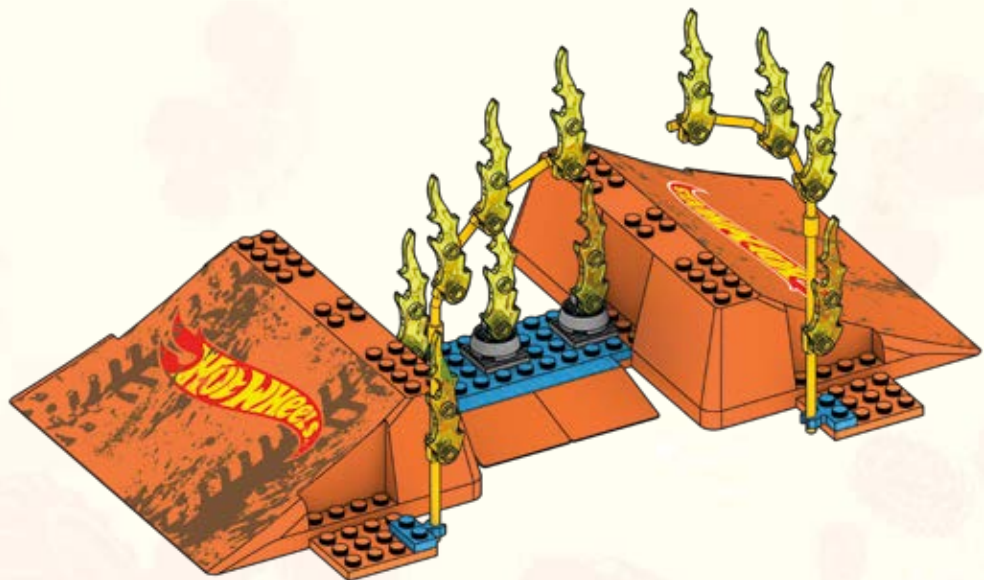

2



Tiger Shark Chomp Course / Parcours Tiger Shark / Pista de dentelladas de Tiger Shark / Circuito de Devastação Tiger Shark / Tiger Shark Super Scontri
Tiger Shark Crash Wettkampf / Tiger Shark Kaskaderski skok Zestaw kraks / Tiger Shark Bijtbaan / Игровой набор Tiger Shark / Tiger Shark Σετ
Tiger Shark Tehlikeli Pist / Tiger Shark harapó pálya / Tiger Shark tuggkurs / Tiger Shark Chomp Course / Tiger Shark-bidebane / Tiger Shark-jafskurs
Závodní dráha autička Tiger Shark / Brzdiaca dráha Tiger Shark / Tiger Shark

SMASH OF CRASH™

**PULL BACK
AND GO!**

**TIREZ LE
VÉHICULE
VERS L'ARRIÈRE
ET PARTEZ !**

61 cm
(24 in)



**¡HAZLO RODAR HACIA ATRÁS Y SUÉLTALO!
PUXA PARA TRÁS PARA ARRANCAR!
ZURÜCKZIEHEN UND LOSS GEHT'S! ПОТЯНИ И ЗАПУСТИ!**

**HIT THE RAMPA!
PRENEZ LA RAMPE !**

**¡SALTA POR LA RAMPA! • SOBRE A RAMPA!
AUF DIE RAMPE FAHREN! • ЗАЕЗЖАЙ ПО РАМПЕ!**



**HOOD POPS OFF!
LE CAPOT SAUTE !**

**¡EL CAPÓ SALE DESPEDIDO!
O CAPÓ SALTA! • DIE MOTORHAUBE
ÖFFNET SICH! • КАПОТ ОТКРЫВАЕТСЯ!**



2x
AM75332X



2x
AM78802W



2x
AM77583APG



3x
AM01312APG



4x
AM07223KZ



3x
AM79666APG



3x
AM03328KZ



1x
AM80546F



2x
AM77574KZ



8x
AM18623BYE



2x
AM74300KZ



2x
AM74299KZ



2x
AM17127KZ



2x
AM15258KZ



2x
AM17018KZ



2x
AM03019KZ



1x
AM72494KZ



1x
AM72495KZ



1x
AM81383F



3x
AM17010APG



2x
AM76469APG



2x
AM81020APG



1x
AM07590KZ



2x
AM09393KZ



2x
AM19660AYP



2x
AM76467KZ



1x
AM81382KZ



1x
AM81381KZ



1x
AM80966KZ



5x
AM01314KZ



2x
AM01314ATV



2x
AM01314AYP



2x
AM74103APG



3x
AM81476APG



4x
AS-HKF88-13



1x
AM74058APG



1x
AM03772ATV



1x
AM81632APG



1x
AM80980KZ



1x
AM80981KZ



1x
AM80982KZ





4x
AM81640AMC



2x
AM09493BOR



2x
AM80973KZ



2x
AM81628KZ



1x
AM80538AAV



1x
AM81250KZ



2x
AM07475KZ



2x
AM07475ATV



11x
AM78388AMZ



1x
AM80971KZ



1x
AM80965KZ



1x
AS-HKF88-15



1x
AS-HKF88-16



2x
AM17054BOR



1x
AS-HKF88-14



2x
AM01346BOR



1x
AM81631KZ

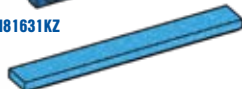

1x
AM09922AYP



2x
AM77466BYE



2x
AM76192BYE



1x
AS-HKF88-17



1x
AS-HKF88-18



1x
FIG-HKF88-B

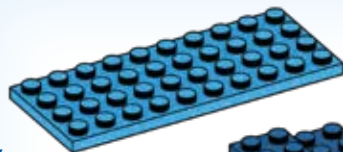

1x
AM0924AYP

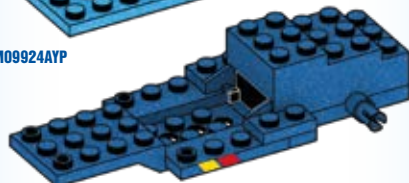

1x
AS-HKF88-12

Missing pieces? • Pièces manquantes?

¿Partes faltantes? • Perdeu peças?
Fehlen Teile? • Не хватает деталей?

support.megabrand.com

ATTENTION : DANGER
D'ÉTOUFFEMENT. - PRÉSENCE DE PETITS
ÉLÉMENTS. NE CONVIENT PAS AUX ENFANTS DE
MOINS DE 3 ANS.

ATENÇÃO! NÃO INDICADO / NÃO
RECOMENDÁVEL PARA CRIANÇAS MENORES DE 3
(TRÊS) ANOS POR CONTER PARTE(S) PEQUENA(S)
QUE PODE(M) SER ENGOLIDA(S) OU ASPIRADA(S)
PODENDO PROVOCAR ASFIXIA.

警告:
のどにつまる危険 小さな部品が含まれています
3歳以下の子供には与えないで下さい。

警告!
不适合3岁以下儿童使用。
内含小零件。

WARNING : CHOKING HAZARD. - Small parts. Not for children under 3 years.
ADVERTENCIA : PELIGRO DE ATRAGANTAMIENTO. Juguete no recomendado
para menores de 3 años, porque contiene piezas pequeñas que podrían
provocar asfixia en caso de ser ingeridas o inhaladas por el/la niño/a.

AVVERTENZA : Contiene pezzi di piccole dimensioni.

ACHTUNG : Kleine Teile.

OSTRZEŻENIE : Małe części. Niebezpieczeństwo zadławienia.

WAARSCHUWING : Kleine onderdelen

ПРЕДУПРЕЖДЕНИЕ : Мелкие детали.

ADVARSEL : Indeholder små dele.

VARNING : Smådelar

ADVARSEL : Små deler

VAROITUS : Pieniä osia

ΠΡΟΣΟΧΗ : Περιλαμβάνονται μικρά κομμάτια.

UYARI : Küçük parçalar.

UPOZORNĚNÍ : Malé díly

UPOZORNENIE : Malé časti

FİGYELMEZTETÉS : Kis alkatrészek.



تحذير:
غير مناسبة للأطفال دون 36 شهراً - قطع صغيرة.

Mattel Europa B.V., Gondel 1, 1186 MJ Amstelveen, Nederland. Mattel U.K. Limited, The Porter Building, 1 Brunel Way, Slough SL1 1FQ, UK. Mattel France, Parc de la Ceraisaie, 1/3/5 allée des Fleurs, 94260 Fresnes Cedex, N° Cristal 0969 36 99 99 (Numéro non surtaxé) ou www.lesjouetsmattel.fr Mattel Belgium, Trade Mart, Atomiumsquare, Bogota 202 - B 275, 1020 Brussels. Grátis nummer België: 0800 - 16 936 - Grátis nummer Luxembourg: 800 - 22 784 - Grátis nummer Nederland: 0800 - 262 88 35. Deutschland: Mattel GmbH, Solmsstraße 4, D-60486 Frankfurt am Main. Schweiz: Mattel AG, Kirchstrasse 24, CH-3097 Liebfeld. Österreich: Mattel Ges.m.b.H., Campus 21, Liebermannstraße A01 404, A-2345 Brunn/Gebirge. Mattel Italy Srl, Via Bracco, 6-MAC 6, 20159 Milano, Italy. Servizio assistenza clienti: Customerserv.italia@mattel.com - Numero verde 800 11 37 11. Mattel España, S.A., Aribau 200, 08036 Barcelona. cservice.spain@mattel.com Tel: 900 102 390 http://www.service.mattel.com/es. Mattel East Asia Ltd., Room 503-09, North Tower, World Finance Centre, Harbour City, Tsimshatsui, HK, China. Tel.: (852) 3185-6500. Diimport & Didarkan Oleh: Mattel Continental Asia Sdn Bhd. Level 19, Tower 3, Avenue 7, No. 8 Jalan Kerinchi, Bangsar South, 59200 Kuala Lumpur, Malaysia. Mattel South Africa (PTY) LTD, Office 102/13, 30 Melrose Boulevard, Johannesburg 2196. Distributor: Mattel Poland Sp. z o.o., Warsaw Trade Tower 34 p., ul. Chłodna 51, 00-867 Warszawa. Mattel Australia Pty. Ltd., 658 Church St., Richmond, Victoria, 3121. Consumer Advisory Service - 1300 135 312. Mattel ÁEBE, Εθνόρχη Μακαρίου 1, Κτήριο Κ-2, ΤΚ 17561, Παλιό Φάληρο. Mattel Oyuncakçılık Ltd. Tic. Şti. Çerçenköy Mah., Erkut Sok. A Blok No:12 Üner Plaza Kat:9-10 34752 Ataşehir İstanbul. Tel: 0216 570 75 00. Импортер/Уполномоченная организация: ООО "МАТЕЛ" Российская Федерация, 105120 Москва, 2-й Сыроматинский переулок, 1; +7 495 287 79 39. Mattel Czech Republic s.r.o., The Forum, Václavské nám. 19, 11000 Praha 1. Mattel, 333 Continental Boulevard, El Segundo, CA 90245, USA. Mattel Canada Inc., Mississauga, Ontario L5R 3W2. Consumer Services: You may call us free at/ Composez sans frais le 1-800-524-8697. Importado y distribuido por Mattel de México, S.A. de C.V., Miguel de Cervantes Saavedra No. 193, Pisos 10 y 11, Col. Granada, Alcaldía Miguel Hidalgo, C.P. 11520, México, Ciudad de México. R.F.C. MME-920701-NB3. Tels.: 59-05-51-00 Ext. 5206 ó 01-800-463-59-89. Mattel Chile, S.A., Avenida Américo Vespucio 501-B, Quilicura, Santiago. Tel.: 1230-020-6213. Servicio al consumidor Venezuela: Tel.: 0-800-100-9123. Mattel Argentina, S.A., Av. Libertador 1000, Piso 11 - Oficinas 109 y 111, Vicente López - Prov. Buenos Aires. Tel.: 0800-666-3373. Mattel Colombia, S.A., Calle 123#7-07 P5, Bogotá. Tel.: 01800-710-2069. Mattel Perú, S.A., Av. Juan de Arona # 151, Centro Empresarial Juan de Arona, Torre C, Piso 7, Oficina 704, San Isidro, Lima 27, Perú. RUC: 20425853865. Reg. Importador: 02350-12-JUE-DIGESA. Tel: 0800-54744. E-mail Latinoamérica: servicio.clientes@mattel.com. Mattel do Brasil Ltda. - CNPJ: 54.558.002/0001-20 - Rua Verbo Divino, 1488 - 2º. Andar - 04719-904 - Chácara Santo Antônio - São Paulo - SP - Brasil. Serviço de Atendimento ao Consumidor: fone 0800 575 0780. E-mail: sac.matteldobrazil@mattel.com

BUILD YOUR WAY CONSTRUIS TON UNIVERS



HMM49

HKF88



HKF87

Crea tu camino | Constrói à tua maneira
Bauen, wie es dir gefällt | Построй мир гонок

Set(s) sold separately and subject to availability. / Ensemble(s) vendu(s) séparément. Certains produits peuvent ne pas être commercialisés. / Se vende(n) por separado y está(n) sujeto(s) a disponibilidad. / Conjunto(s) vendido(s) em separado e sujeito(s) a disponibilidade. / Set in vendita separatamente, secondo disponibilità. / Das/Die Set(s) sind separat erhältlich. / Zestaw(y) sprzedawany(e) oddzielnie w zależności od dostępności. / Set(s) apart verkrijgbaar en afhankelijk van beschikbaarheid. / Набор(-ы) продаются отдельно, при наличии. / Sæt sælges separat og så længe lager havet. / Seten säljs separat så länge lagret räcker. / Settet/settene selges separat så langt lageret rekker. / Pakkaus/pakkaukset myydään erikseen, saatavuus voi vaihdella. / Το(α) σετ πωλούνται ξεχωριστά και ανάλογα με τη διαθεσιμότητα. / Setler ayrı olarak satılır ve stoklarla sınırlıdır. / Set (sety) se prodávaj (prodávaj) samostatně dle aktuální nabídky. / Súprava/-y sa predáva(jú) samostatne a podľa dostupnosti. / A készlet(ek) külön kapható(k), az elérhetőség változhat. /

セット商品は別売りになります。在庫状況は別途ご確認をお願いします。 / تباع المجموعة أو المجموعات على حدة وتخضع لتوافرها. / 每套单独发售，按供货情况决定。

Mattel Canada Inc. Mississauga, Ontario L5R 3W2.
MADE IN CHINA. FABRIQUÉ EN CHINE. FABRICADO NA / HECHO EN CHINA.
ИЗГОТОВЛЕНО В КИТАЕ. ÇIN'DE ÜRETİLMİŞTİR. صنع في الصين

©2022 MEGA Brands &™ MEGA Brands.
Printed in China / Imprimé en Chine

AD-HKF88-02A

1186 MJ, 1, NL

© D714,887, D781,964, D797,203



HOT WHEELS™ and associated trademarks and trade dress are owned by, and used under license from, Mattel. ©2022 Mattel.

