



POKÉMON™



PIKACHU'S BEACH SPLASH PIKACHU AVENTURE À LA PLAGE

DIVERSIÓN EN LA PLAYA DE PIKACHU
DIVERSÃO NA PRAIA DO PIKACHU

HDL76



Build Construisez

Construye | Constrói
Bauen | Стройте



Share | Partagez

Comparte | Partilha
Teilen | Делитесь

Easy-to-follow steps!

Des instructions faciles à suivre!

¡Pasos fáciles de seguir!
Passos fáceis de seguir!
Einfache Schritte!
Простые действия!



Devices not included | Appareils non inclus | Dispositivos no incluído | Dispositivos
não incluídos | Geräte nicht enthalten | Устройства не входят в комплект



megaunboxed.com



1



1x



1x



2

2x



1x

**3**

1x



1x



1



2

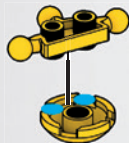

4



2x



1x

5



2x

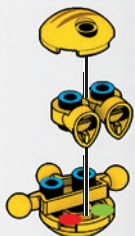

1



2

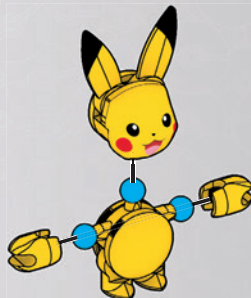

1



2



3

6



1x



1x

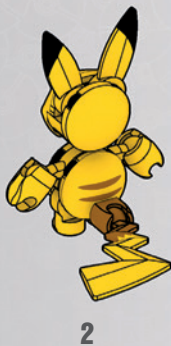
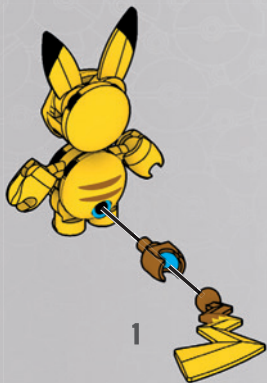

7



3x



1x



8



3x

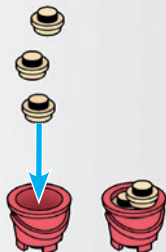

1

2

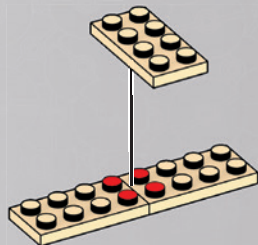

9

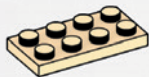

2x

10



1x

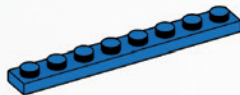

1x

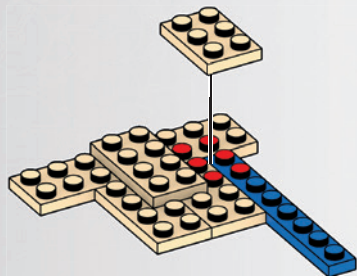
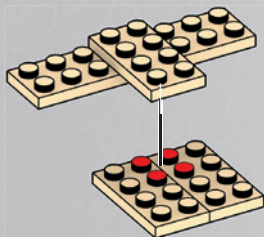

11



1x



1x

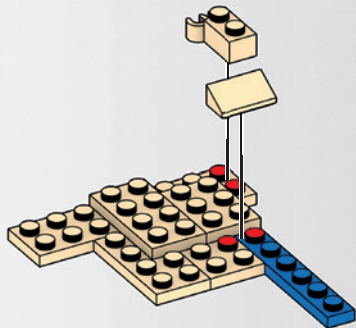

12



1x



1x



1x



1x

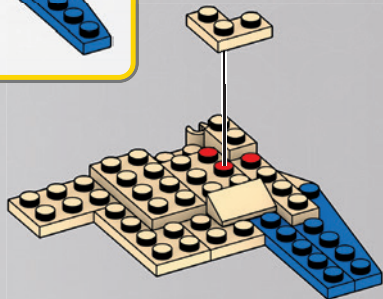
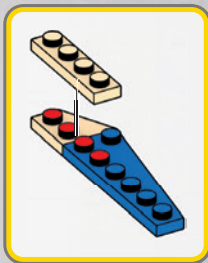

13

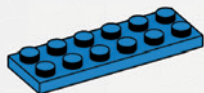

1x

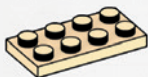

1x

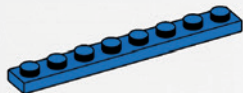

1x

14



1x



1x

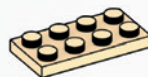

1x

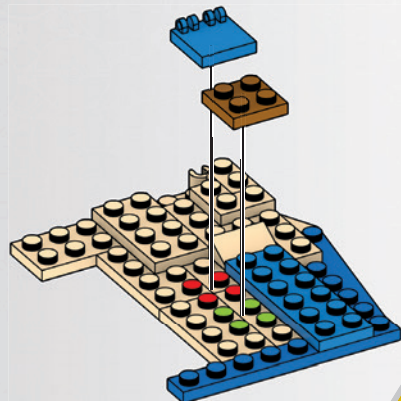
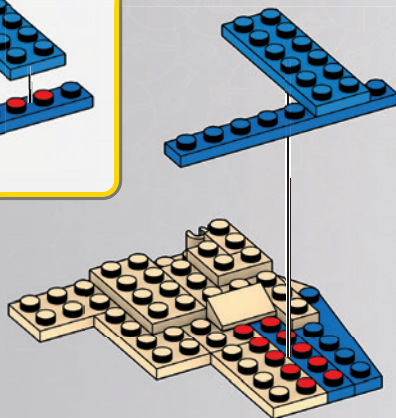
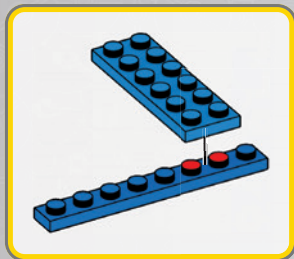

15

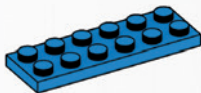

1x



1x

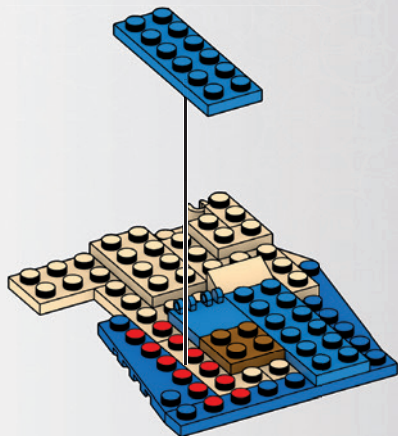

16



1x



1x

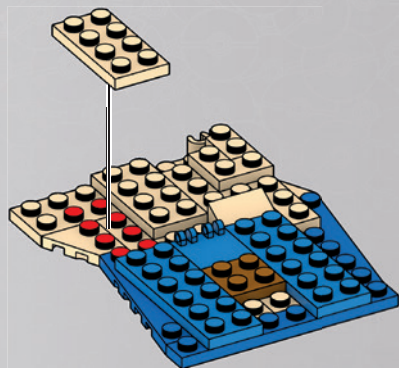

17



1x



1x

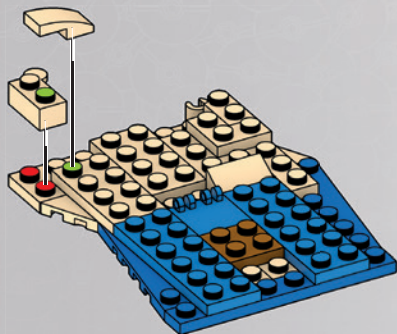

18



1x



1x

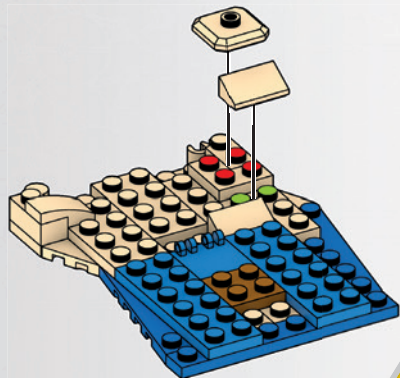

19



1x



1x

20



3x



3x



x3

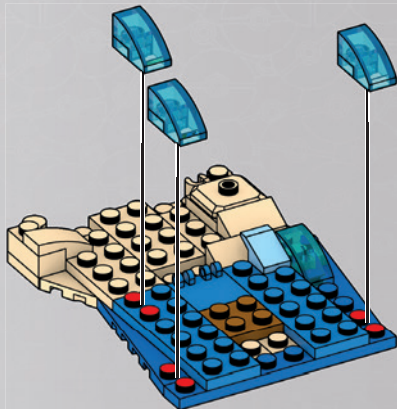
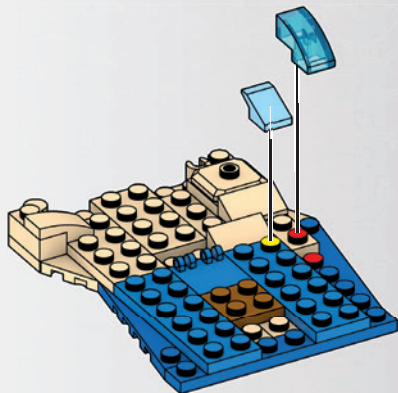

21



1x



1x

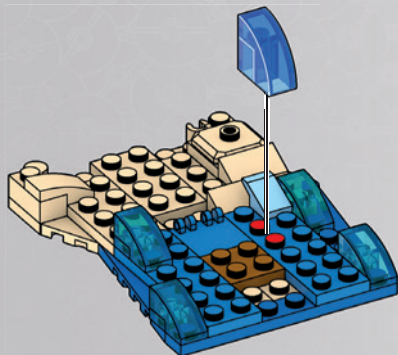

22



1x

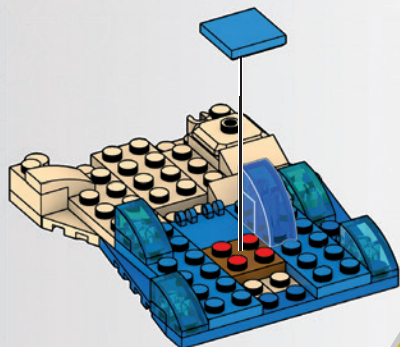

23



2x



1x

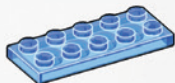

1x

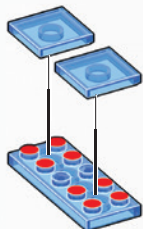

1

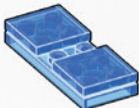

2

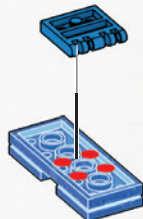

3

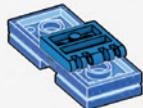

4

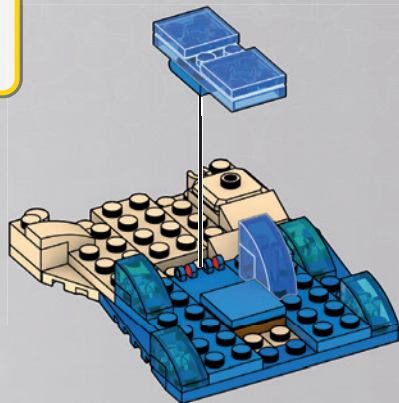

24



2x

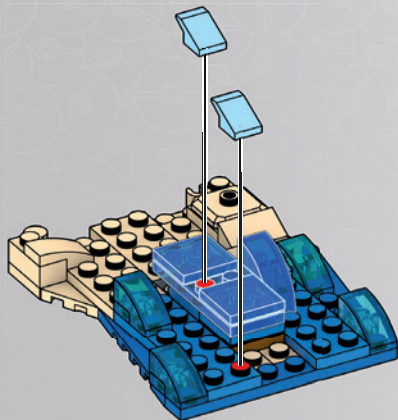

25



3x



3x

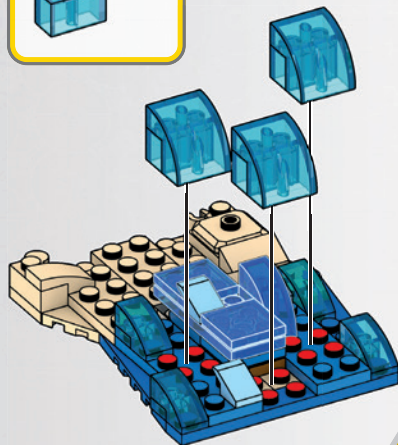
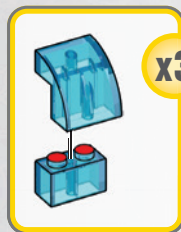

26



4x



1x



1



2



27

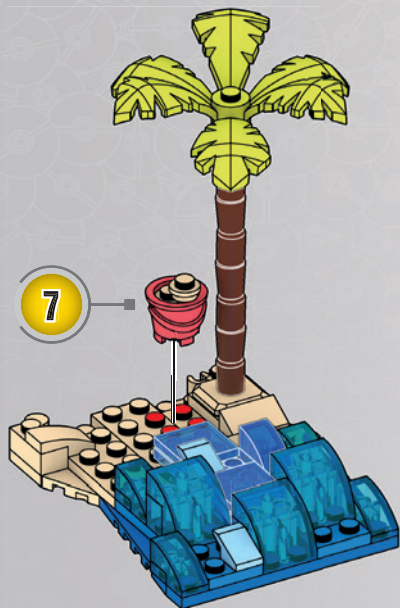

28



6x

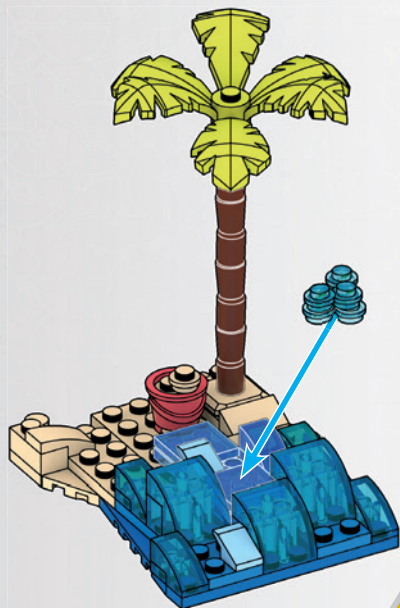

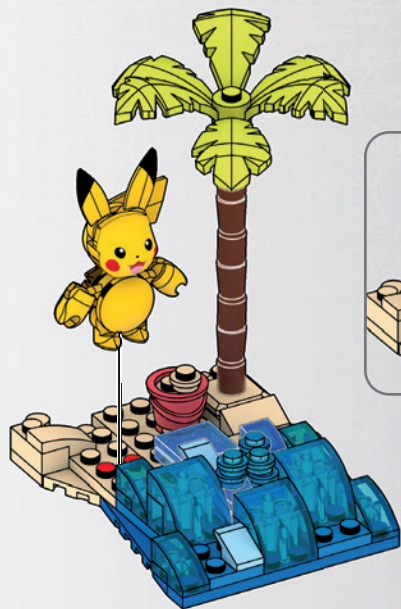

1



2





⚠ WARNING: DO NOT AIM AT EYES OR FACE. ONLY USE PROJECTILES SUPPLIED WITH THIS TOY. DO NOT FIRE AT POINT BLANK RANGE.
ADVERTENCIA: NO APUNTAR A LOS OJOS NI A LA CARA. SI ADQUIRIÓ UN MODELO CON PROYECTIL(ES) INCLUIDO(S): UTILIZAR ÚNICAMENTE EL(LOS) PROYECTIL(ES) INCLUIDO(S) EN ESTE JUGUETE. NO DISPARAR A PERSONAS NI ANIMALES. NO DISPARAR A QUEMARROPA.

ATTENTION : NE PAS VISER LES YEUX OU LE VISAGE. NE PAS UTILISER D'AUTRES PROJECTILES QUE CEUX FOURNIS AVEC CE JOUET. NE PAS TIRER À BOUT PORTANT.

ATENÇÃO!: NÃO APONTAR PARA OS OLHOS E PARA A FACE. NÃO UTILIZAR PROJÉTEIS DIFERENTES DOS PROVIDOS E DOS INDICADOS PELO FABRICANTE DO BRINQUEDO.

Avvertenza: Non mirare agli occhi o al viso. Usare solo i proiettili forniti con il giocattolo. Non sparare a distanza ravvicinata.

Achtung: Nicht auf Augen oder Gesicht zielen. Nur die zu diesem Spielzeug gehörenden Projektile verwenden. Nicht auf Menschen oder Tiere oder aus nächster Nähe zielen.

Ostrzeżenie: Nie celuj w oczy i twarz. Nie strzelaj pociskami innymi niż dostarczone z zabawką. Nie strzelaj z bliska.

Waarschuwing: niet op ogen of gezicht richten. Gebruik uitsluitend de bijgeleverde projectielen. Niet van te dichtbij afschieten.

Предупреждение: Не направляйте в глаза или лицо. Используйте только снаряды, входящие в комплект. Не стреляйте со слишком близкого расстояния.

Advarsel: Sigt ikke mod øjne eller ansigt. Brug kun de projektiler, som følger med legetøjet. Skyd ikke direkte på personer eller ting.

Varning: Sikta inte mot ögon eller ansikte. Använd endast projektiler som medföljer leksaken. Fyra inte av på mycket nära håll.

Advarsel: Du må ikke sikte mot øyne eller ansikt. Bruk bare prosjektilene som følger med leken. Ikke skyt på noe på kloss hold.

Varoitus: Älä tähtää silmiini äläkä kasvoihin. Käytä ainoastaan tämän tuotteen mukana tulleita ammuksia. Älä ammu lähietäisyydeltä.

Προσοχή: Μην στοχεύετε στα μάτια ή στο πρόσωπο. Χρησιμοποιείτε μόνο τα βλήματα που περιλαμβάνονται. Μην στοχεύετε όταν δεν έχετε ορατότητα.

Uyarı: Göze veya yüze nişan almayın. Fırlatmak için yalnızca bu oyuncakla birlikte verilen objeleri kullanın. İnsanlara ve hayvanlara nişan almayın.

Upozornění: Nemířte na oči nebo na obličej. Používejte pouze projektily dodávané s touto hračkou. Nestřílejte z bezprostřední blízkosti.

Upozornenie: Nemierite do očí ani do tváre. Používajte iba strely dodané spolu s touto hračkou. Nestrieľajte z bezprostrednej blízkosti.

Figyelmeztetés: Tilos szemre és arcra célozni. Kizárólag a játékhoz mellékelte lövedékeket használja. A játékkal tilos közvetlen közelről löni.

警告: 目や顔に向けてのご使用、至近距離での発射はお控えください。このおもちゃの同梱物のみご使用ください。

تحذير: يجب عدم التصويب باتجاه العينين أو الوجه. يجب استخدام المقذوفات المزودة مع هذه اللعبة فقط. يجب عدم الإطلاق من مدى قريب.

警告: 请勿对着眼睛或脸部发射。仅使用本玩具自带的抛射物。请勿近距离射击。

Connect sets to build your Pokémon world Connectez les coffrets pour créer votre univers Pokémon

Conecta los conjuntos para crear tu mundo Pokémon / Una os conjuntos para construir o seu mundo Pokémon
Verbinde Sets und erschaffe deine eigene Pokémon-Welt / Соединяйте наборы, чтобы построить свой мир Покемонов



HDL76 / HDL77 / HDL80 / HDL86 / HHN61 / Set(s) sold separately and subject to availability. / Ensemble(s) vendu(s) séparément. Certains produits peuvent ne pas être commercialisés. / Se vende(n) por separado y está(n) sujeto(s) a disponibilidad. / Conjunto(s) vendido(s) em separado e sujeito(s) à disponibilidade. / Set in vendita separatamente, secondo disponibilità. / Das/Die Set(s) sind separat erhältlich. / Zestaw(y) sprzedawany(e) oddzielnie w zależności od dostępności. / Set(s) apart verkrijgbaar en afhankelijk van beschikbaarheid. / Набор(-ы) продаются отдельно, при наличии. / Sæt sælges separat og så længe lager haves. /



+



HDL77

+



HDL80

+



HDL86

+



HHN61

=



Seten säljs separat så länge lagret räcker. / Settet/settene selges separat så langt lageret rekker. / Pakkaus/pakkaukset myydään erikseen, saatavuus voi vaihdella. / Το(α) σετ πωλούνται ξεχωριστά και ανάλογα με τη διαθεσιμότητα. / Setler ayrı olarak satılır ve stoklarla sınırlıdır. / Set (sety) se prodává (prodávají) samostatně dle aktuální nabídky. / Súprava/-y sa predáva(jú) samostatne a podľa dostupnosti. / A készlet(ek) külön kapható(k), az elérhetőség változhat. / セット商品は別売りになります。在庫状況は別途ご確認をお願いします。 /

تباع المجموعة أو المجموعات على حدة وتخضع لتوافرها.
每套单独发售，按供货情况决定。

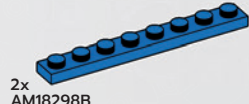
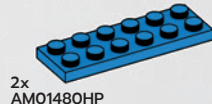
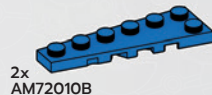
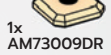
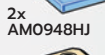
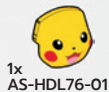
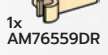
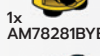
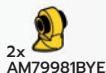

**Missing pieces?
Pièces manquantes?**

¿Partes faltantes? • Perdeu peças?
Fehlern Teile? • Не хватает деталей?

support.megabrands.com

ATTENTION : DANGER
D'ÉTOUFFEMENT - PRÉSENCE DE PETITS
ÉLÉMENTS. NE CONVIENT PAS AUX ENFANTS DE
MOINS DE 3 ANS.

ATENÇÃO! NÃO INDICADO / NÃO
RECOMENDÁVEL PARA CRIANÇAS MENORES DE 3
(TRÊS) ANOS POR CONTER PARTE(S) PEQUENA(S)
QUE PODE(M) SER ENGOLIDA(S) OU ASPIRADA(S)
PODENDO PROVOCAR ASFIXIA.

警告:

のどにつまる危険 小さな部品が含まれています
3歳以下の子供には与えないで下さい。

警告!

不适合3岁以下儿童使用。
内含小零件。

⚠ WARNING : CHOKING HAZARD. - Small parts.
Not for children under 3 years.
ADVERTENCIA: PELIGRO DE ATRAGANTAMIENTO. Juguete no recomendado
para menores de 3 años, porque contiene piezas pequeñas que podrían
provocar asfixia en caso de ser ingeridas o inhaladas por el/la niño/a.

AVVERTENZA: Contiene pezzi di piccole dimensioni.

ACHTUNG: Kleine Teile.

OSTRZEŻENIE: Małe części. Niebezpieczeństwo zadławienia.

WAARSCHUWING: Kleine onderdelen

ПРЕДУПРЕЖДЕНИЕ: Мелкие детали.

ADVARSEL: Indeholder små dele.

VARNING: Smådelar

ADVARSEL: Små deler

VAROITUS: Pieniä osia

ΠΡΟΣΟΧΗ: Περιλαμβάνονται μικρά κομμάτια.

UVARI: Kűcűk parçalar.

UPOZORNĚNÍ: Malé díly

UPOZORNENIE: Malé časti

FİGYELMEZTETÉS: Kis alkatrészek.



تحذير:

غير مناسبة للأطفال دون 36 شهراً - قطع صغيرة.

Pikachu's Beach Splash / Pikachu's Adventure à la Plage / Diversion en la playa de Pikachu / Diversão na Praia do Pikachu / Pikachu Divertimento in Spiaggia / Pikachu Strandtag / Pikachu na plaży / Pikachu's Strandpret / Набор "Пикачу на пляже" / Βόλτα στην Παραλία / Pikachu'nun Plaj Keyfi / Pikachu tengerparti kalandja / Pikachu strandhång / Pikachu's Beach Splash / Pikachu's strandfest / Pikachu's Beach Splash / Pikachu's Beach Splash / Pikachu - oddych na pláži / شاطئ وطرقتة

Mattel Europa B.V., Gonderl 1, 1186 MJ Amstelveen, Nederland. Mattel U.K. Limited, The Porter Building, 1 Brunel Way, Slough SL1 1FQ, UK. Mattel France, Parc de la Cerisaie, 1/3/5 allée des Fleurs, 94260 Fresnes Cedex. N° Cristal 0969 36 99 99 (Numéro non surtaxé) ou www.lesjouetsmattel.fr Mattel Belgium, Trade Mart, Atomiumsquare, Bogota 202 - B 275, 1020 Brussels. Gratis nummer België: 0800 - 16 936 - Gratis nummer Luxemburg: 800 - 22 784 - Gratis nummer Nederland: 0800 - 262 88 35. Deutschland : Mattel GmbH, Solmsstraße 83, D-60486 Frankfurt am Main. Schweiz: Mattel AG, Kirchstrasse 24, CH-3097 Liebefeld. Österreich: Mattel Ges.m.b.H., Campus 21, Liebermannstraße A01 404, A- 2345 Brunn/Gebrige. Mattel Italy Srl, Via Turati 4, 20121 Milano, Italy. Servizio assistenza clienti: Customers.vitalia@mattel.com - Numero verde 800 11 37 31. Mattel España, S.A, Aribau 200 pl. 9, 08036 Barcelona. cservice.spain@mattel.com Tel.: +34 933 06 79 00 http://www.service.mattel.com/es. Mattel East Asia Ltd., Room 503-09, North Tower, World Finance Centre, Harbour City, Tsimshatsui, HK, China. Tel.: (852) 3185-6500. Dimpport & Diedarkan Oleh: Mattel Continental Asia Sdn Bhd. Level 19, Tower 3, Avenue 7, No. 8 Jalan Kerinchi, Bangsar South, 59200 Kuala Lumpur, Malaysia. Mattel South Africa (PTY) LTD. Office 102 13, 30 Melrose Boulevard, Johannesburg 2196. Dystrybutor: Mattel Poland Sp. z o.o., Karsa Trade Tower 34 p., ul. Chłodna 51, 00-867 Warszawa. Mattel Australia Pty. Ltd., 658 Church St., Richmond, Victoria, 3121. Consumer Advisory Service - 1300 135 312. Mattel AEBE. Εβθάρυτο Μακρορίου 1, Κτήριο Κ-2, ΤΚ 17561, Παλαιό Φάληρο. Mattel Oyuncakçılık Tic. Ltd. Şti. İçerenköy Mah., Umut Sok. No:10-12 Quick Tower Kat:2/15 34752 Ataşehir İstanbul Tel: 0216 570 75 00. Импортёр/Уполномоченная организация: ООО "МАТТЕЛ" Российская Федерация, 105120 Москва, 2-й Сыроматинский переулок 1; +7 495 287 79 39. Mattel Czech Republic s.r.o., The Forum, Václavské nám. 19, 11000 Praha 1. Mattel, 333 Continental Boulevard, El Segundo, CA 90245, USA. Consumer Services: 1-800-465-MEGAS (6342). Mattel Canada Inc., Mississauga, Ontario L5R 3W2. Consumer Services: You may call us free at/ Composez sans frais le 1-800-524-8697. Importado y distribuido por Mattel de México, S.A. de C.V., Miguel de Cervantes Saavedra No. 193, Pisos 10 y 11, Col. Granada, Alcatdia Miguel Hidalgo, C.P. 11520, México, Ciudad de México. R.F.C. MME-920701-1NB3. Tels.: 59-05-51-00 Ext. 5206 ó 01-800-463-59-89. Mattel Chile, S.A., Avenida Américo Vespucio 501-B, Quilicura, Santiago. Tel.: 1230-020-6213. Servicio al consumidor Venezuela: Tel: 0-800-100-9123. Mattel Argentina, S.A., Av. Libertador 1000, Piso 11 - Oficinas 109 y 111, Vicente López - Prov. Buenos Aires. Tel.: 0800-666-3373. Mattel Colombia, S.A., Calle 123#7-07 PS, Bogotá. Tel.: 01-800-710-2069. Mattel Perú, S.A., Av. Juan de Arona # 151, Centro Empresarial Juan de Arona, Torre C, Piso 7, Oficina 704, San Isidro, Lima 27, Perú. RUC: 20425853865. Reg. Importador: 02350-12-JUE-DIGE-SA. Tel.: 0800-54744. E-mail Latinoamérica: service.clients@mattel.com. Mattel do Brasil Ltda. CNPJ: 54.558.002/0001-20 - Rua Verbo Divino, 1488 - 2º. Andar - 04719-904 - Chácara Santo Antônio - São Paulo - SP - Brasil. Serviço de Atendimento ao Consumidor: fone 0800 575 0780. E-mail: sac.mattelbrasil@mattel.com

BUILD A WORLD OF POKÉMON CRÉEZ VOTRE UNIVERS POKÉMON



CONSTRUYE UN MUNDO DE POKÉMON / CONSTRÓI UM MUNDO DE POKÉMON
EINE POKÉMON WELT ERSCHAFFEN / ПОСТРОЙТЕ МИР POKÉMON

Mattel Canada Inc. Mississauga, Ontario L5R 3W2.
MADE IN CHINA. FABRIQUÉ EN CHINE. FABRICADO NA CHINA. HECHO EN CHINA.
ИЗГОТОВЛЕНО В КИТАЕ. ÇİN'DE ÜRETİLMİŞTİR. صنع في الصين

©2022 MEGA Brands &™ MEGA Brands.
Printed in China / Imprimé en Chine

AD-HDL76-01A

© D799,607,
D834,105

1186 MJ, 1, NL

