



HHL98

'17 CHEVROLET®
CAMARO®



Build Construisez

Construye | Constrói
Bauen | Стройте



Share Partagez

Comparte | Partilha
Teilen | Делитесь

Devices not included | Appareils non inclus
Dispositivos no incluido | Dispositivos não incluídos
Geräte nicht enthalten | Устройства не входят в комплект



Get creative! Soyez créatif!

¡Sé creativo! • seja criativo!
werde kreativ! • проявите
творческий подход!



Build ideas may use pieces from multiple sets (sold separately).
Les idées de construction peuvent nécessiter des pièces issues de
différents coffrets (vendus séparément).
Las ideas de construcción pueden utilizar piezas de varios conjuntos
(se venden por separado).
As ideias de construção podem utilizar peças de vários
conjuntos (vendidas em separado).
Für Bauideen sind möglicherweise Teile von mehreren
Sets nötig (separat erhältlich).
В идеях конструкций могут быть использованы детали
из разных наборов (продаются отдельно).



megaunboxed.com

1

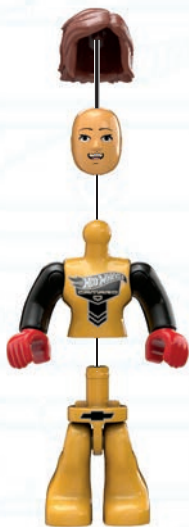

1



2



'17 CHEVROLET[®]
CAMARO[®]

2



2x

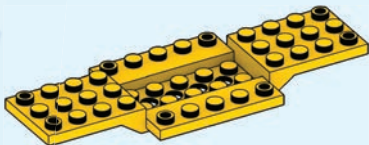

1x

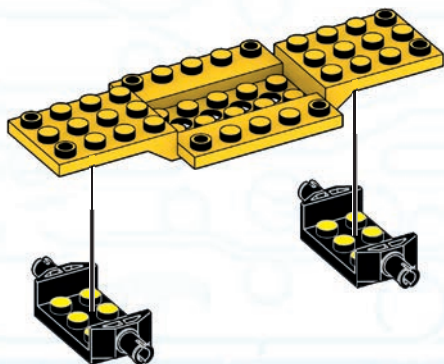

3



1x



1x

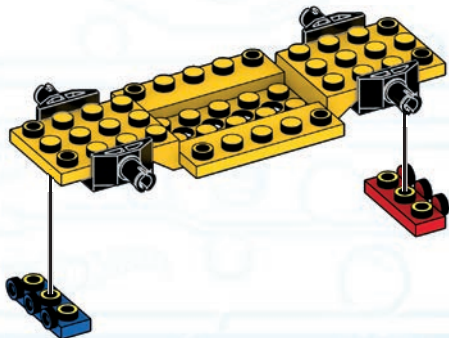

4

1x



1x

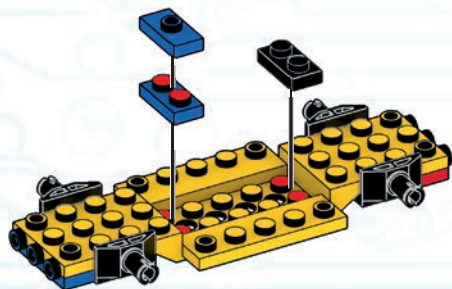

1x

**5**

1x



1x

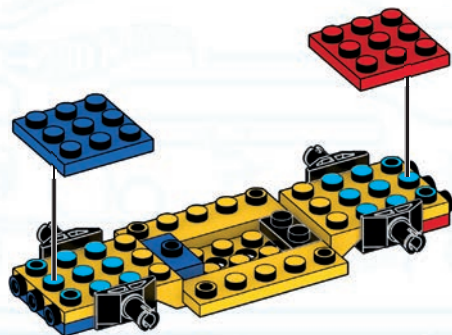



'17 CHEVROLET[®]
CAMARO[®]

6



2x

7



1x



1x

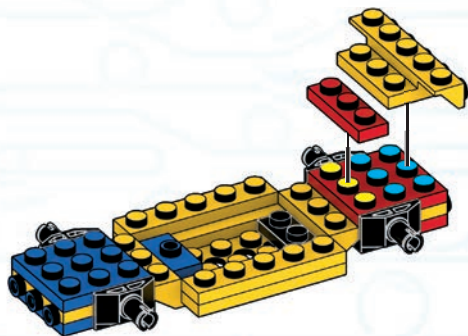
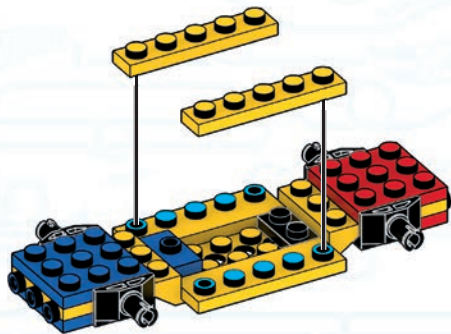

8



1x

9



1x



1x



1x

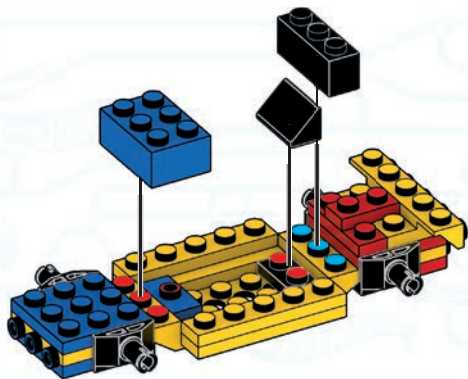
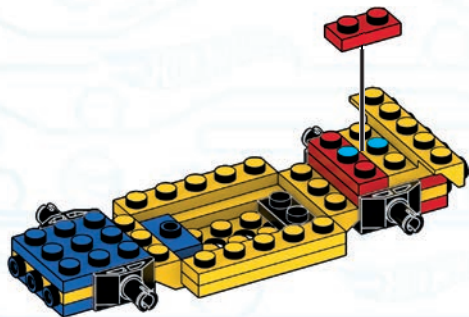



'17 CHEVROLET[®]
CAMARO[®]

10



1x



1x

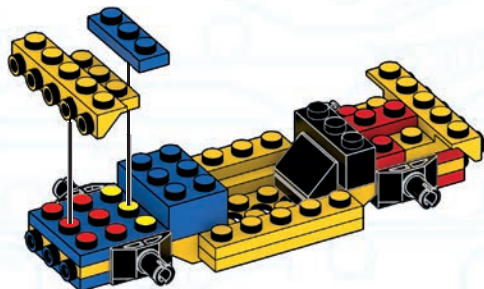

11



1x

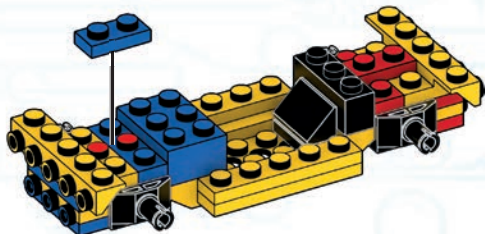

12

1x

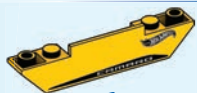

1x

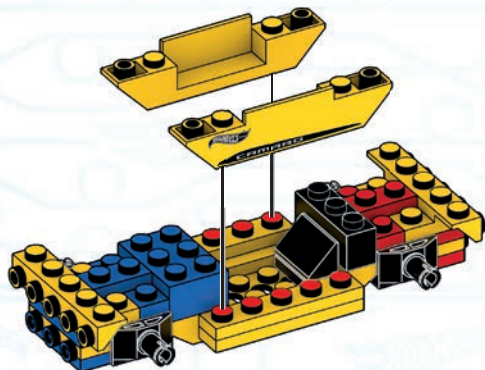
**13**

4x

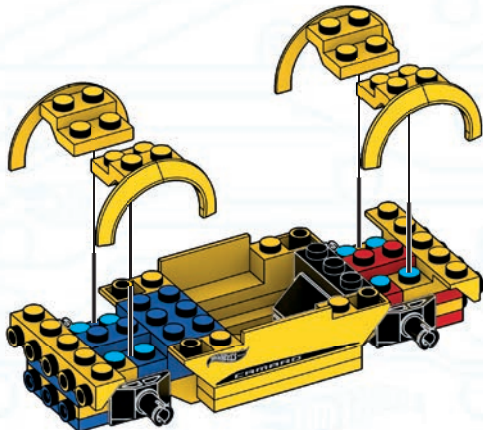



'17 CHEVROLET[®]
CAMARO[®]

14



1x



1x

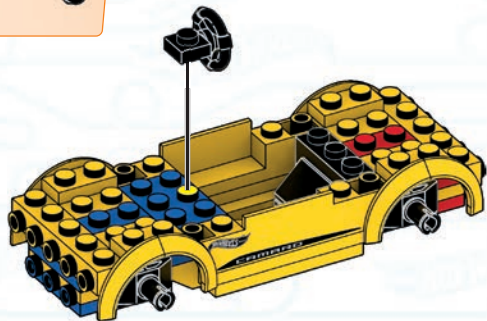

15

1x



1x

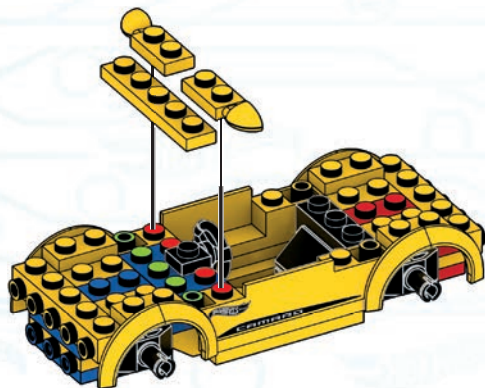

1x

**16**

1x



1x

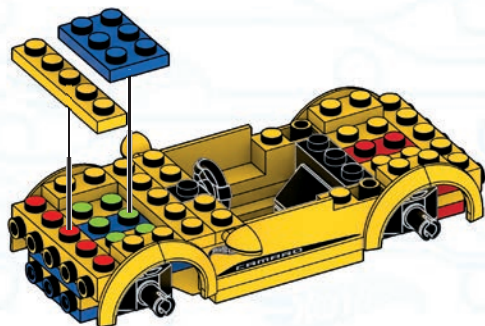



'17 CHEVROLET[®]
CAMARO[®]

17



1x



2x

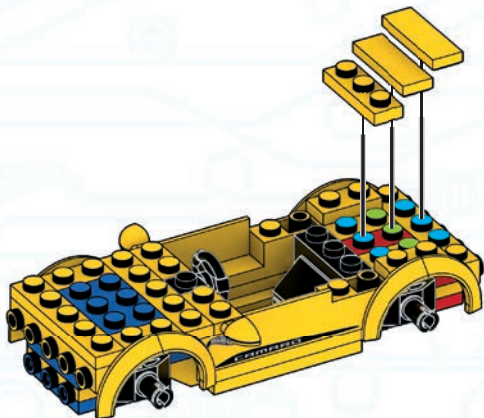

18



1x



1x

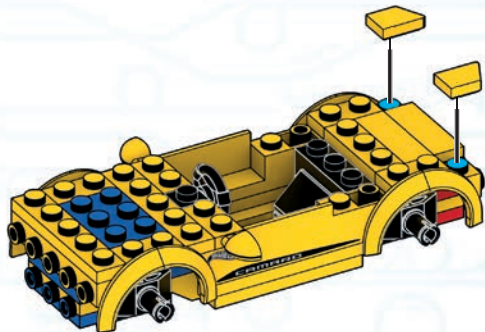

19



1x



2x

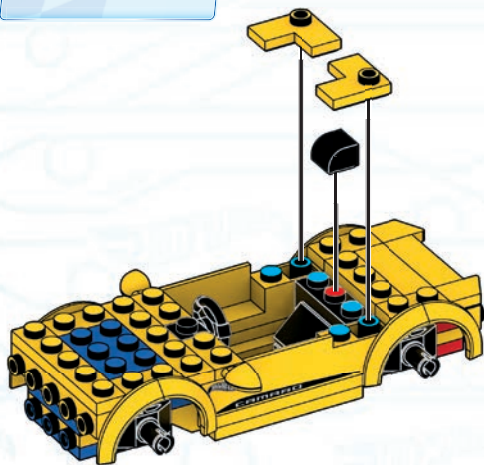

1

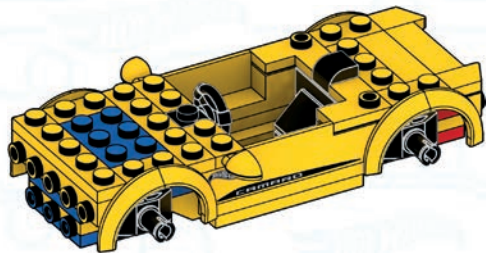

2



'17 CHEVROLET[®]
CAMARO[®]

20



3x



1x



1x

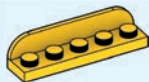

1x

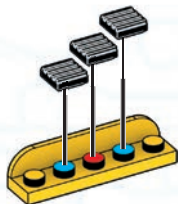

1



2



3

21

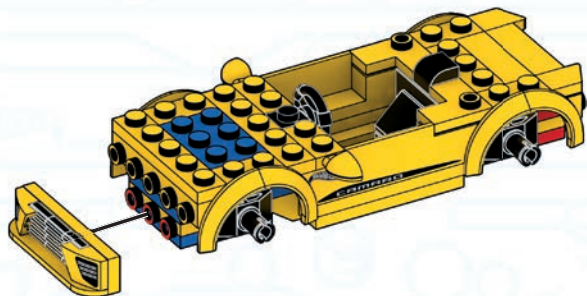



'17 CHEVROLET[®]
CAMARO[®]

22



1x



1x



1



2

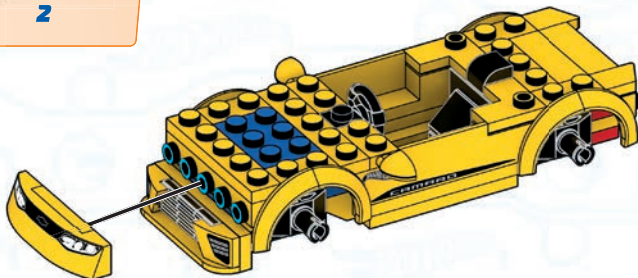

23

1x

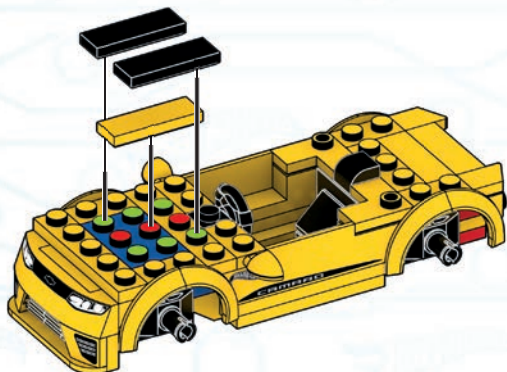

2x

**24**

1x



1x



2x

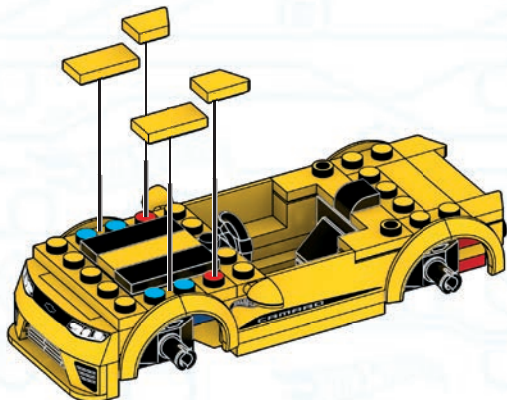



'17 CHEVROLET[®]
CAMARO[®]

25



1x



2x

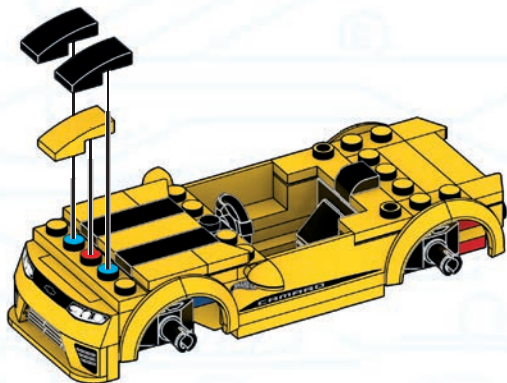

26



1x



1x

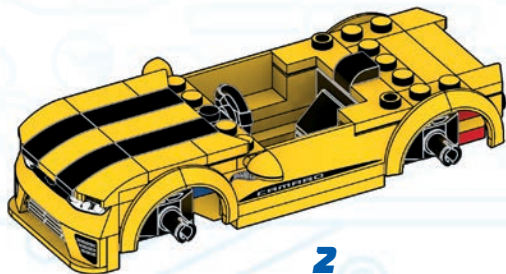
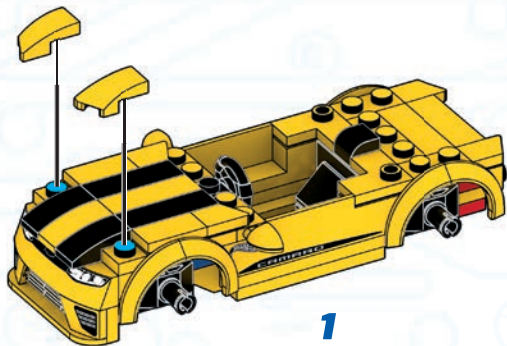



'17 CHEVROLET[®]
CAMARO[®]

27



1x



1x



1x



1x

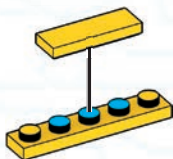

1

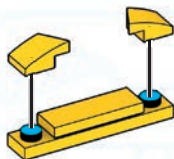

2

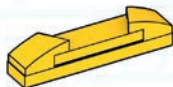

3

28

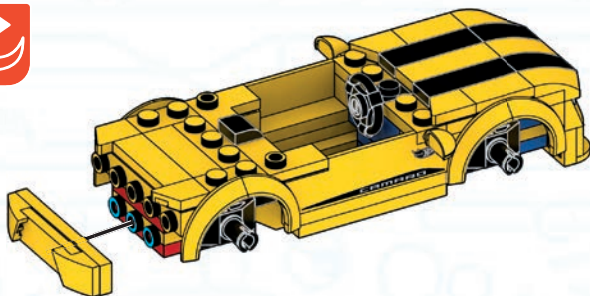



'17 CHEVROLET[®]
CAMARO[®]

29

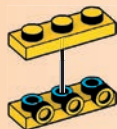

1

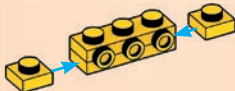

2

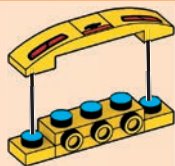

3



4

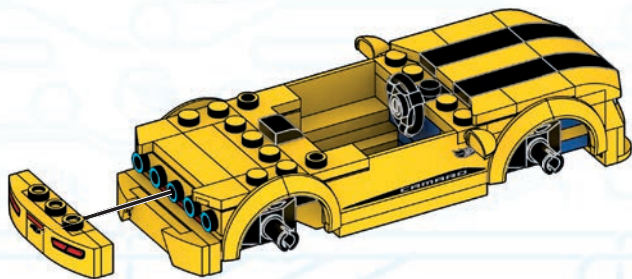

30



2x



1x

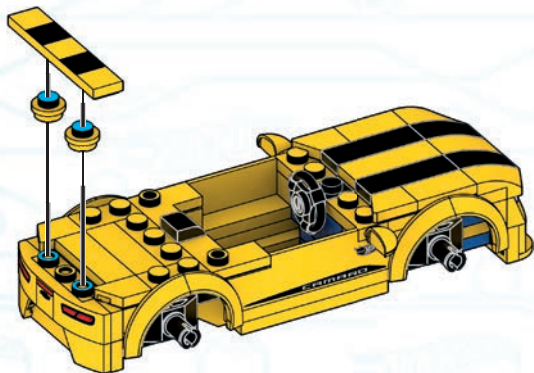

1

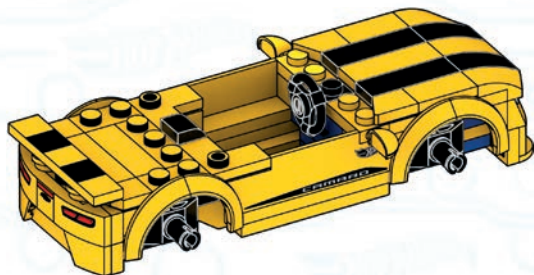

2



'17 CHEVROLET[®]
CAMARO[®]

31

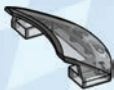

1x

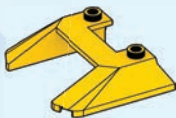

1x

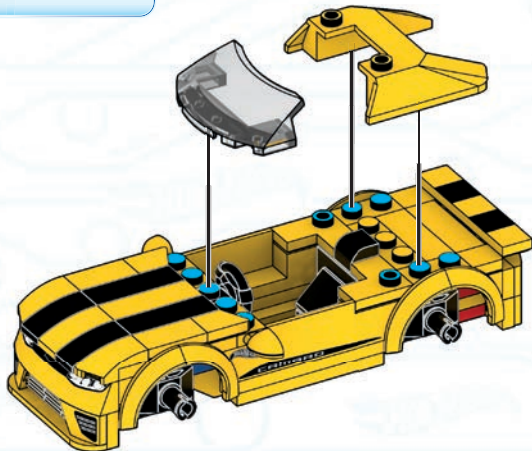

32



1x

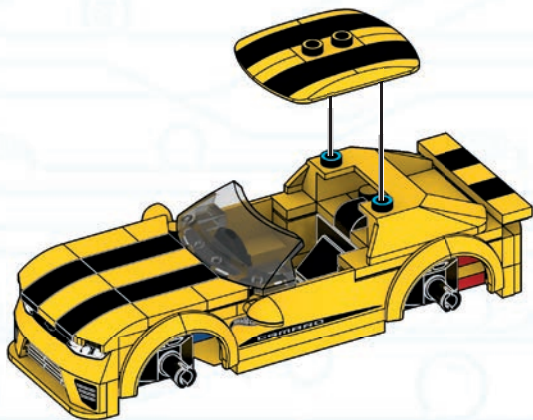



'17 CHEVROLET[®]
CAMARO[®]

33



4x

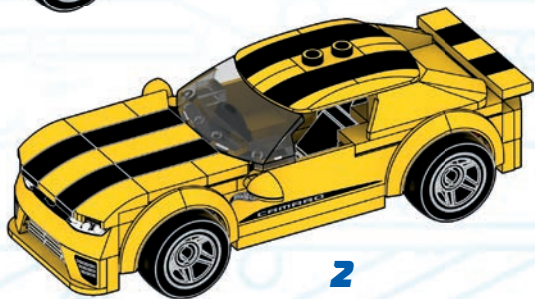
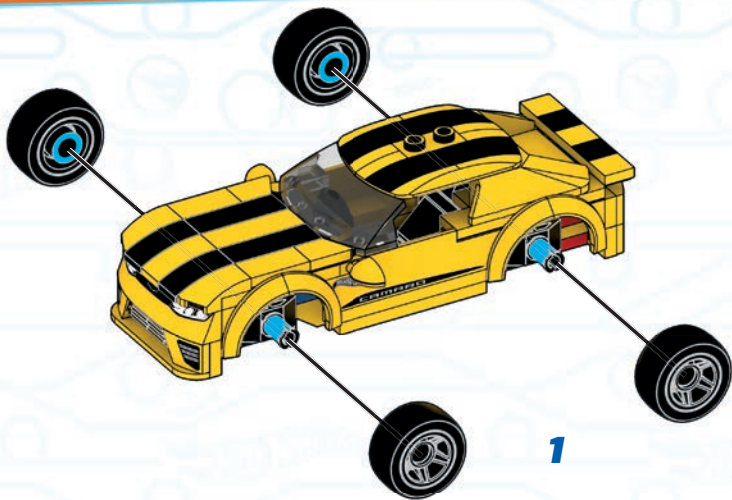

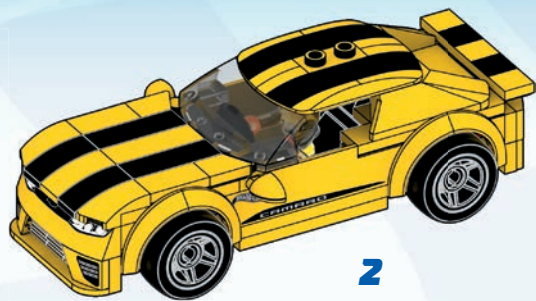

MIX & MATCH! COMBINE-LES!

MEZCLA Y COMBINA! · MISTURA E COMBINA!
ZUM KOMBINIEREN! · СОЧЕТАЙ И ПОДБИРАЙ!

HH018*



BONE SHAKER™ HOJ89*	TWIN MILL™ HDJ90*	HW40™ GYG32*	RODGER DODGER™ GYG33*
MEGA WREX™ HDJ95*	TIGER SHARK™ GVM26*	'83 CHEVY SILVERADO™ HHL97*	'64 CORVETTE GRAND SPORT™ HHL95*
TWINDUCTION™ GYG66*	RODGER DODGER™ GYG22*	'17 CAMARO™ HHL98*	'16 CADILLAC ATS-V™ HHL96*
RALLY CAT™ GVM13*	MOD ROD™ GVM13*	NIGHT SHIFTER™ GVM13*	BAWGZILLA™ GVM13*



Set(s) sold separately and subject to availability. / Ensemble(s) vendu(s) séparément. Certains produits peuvent ne pas être commercialisés. / Se vende(n) por separado y está(n) sujeto(s) a disponibilidad. / Conjunto(s) vendido(s) em separado e sujeito(s) à disponibilidade. / Set in vendita separatamente, secondo disponibilità. / Das/Die Set(s) sind separat erhältlich. / Zestaw(y) sprzedawany(e) oddzielnie w zależności od dostępności. / Set(s) apart verkrijgbaar en afhankelijk van beschikbaarheid. / Набор(ы) продаются отдельно, при наличии. / Sæt sælges separat og så længe lager haves. / Seten säljs separat så länge lagret räcker. / Settet/settene selges separat så langt lageret rekker. / Pakkaus/pakkaukset myydään erikseen, saatavuus voi vaihdella. / Το(α) σετ πωλούνται ξεχωριστά και ανάλογα με τη διαθεσιμότητα. / Setler ayrı olarak satılır ve stoklarla sınırlıdır. / Set (sety) se prodává (prodávají) samostatně dle aktuální nabídky. / Súprava-/y sa predáva(jú) samostatne a podľa dostupnosti. / A készlet(ek) külön kapható(k), az elérhetőség változhat. / セット商品は別売りになります。在庫状況は別途ご確認をお願いします。 / بیاع المجموعه أو المجموعات علی حدة وتخصم لتوافرها. 每套单独发售，按供货情况决定。

Additional purchase required. / Achat additionnel requis. / Zusätzlicher Kauf erforderlich. / Richiede acquisto addizionale. / Aanvullende aankoop vereist. / Requiere compra adicional. / Requer compra adicional. / Ytterligere kjøp kreves. / Edellyttää lisäosien ostamista. / Supplerende kjøb nødvendig. / Ekstra kjøp kreves. / Wymagany dodatkowy zakup. / Vyžaduje dodatečný nákup. / Vyžaduje sa dokúpenie. / További vásárlás szükséges. / Необходима дополнительная покупка. / Απαιτείται επιπλέον αγορά. / Ek ürünü satın alması gerekir. / تتطلب شراء القطع الإضافية.

REBUILD YOUR CARS INTO MONSTER TRUCKS! RÉASSEMBLE TES VOITURES POUR EN FAIRE DES MONSTER TRUCKS!

CONVIERTE TUS COCHES EN "MONSTER TRUCKS!" · TRANSFORMA OS SEUS CARROS EM MONSTER TRUCKS!
FAHRZEUGE IN MONSTER TRUCKS UMBAUEN! · ПЕРЕСТРАИВАЙ СВОИ МАШИНКИ В МОИСТР-ТРАКИ!

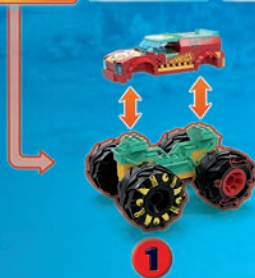

Most models can be built one at a time. La plupart des modèles peuvent être construits un à la fois. La mayoría de modelos se pueden construir de uno en uno. A maioria dos modelos pode ser construída separadamente. La maggior parte dei modelli possono essere realizzati uno per volta. Die meisten Modelle können eines nach dem anderen gebaut werden. Większości modeli nie da się budować jednocześnie z innymi. De meeste modellen kunnen één voor één gebouwd worden. Большинство моделей могут быть собраны по одной за раз. De fleste modeller kan bygges enkeltvis. De flesta modeller kan byggas en i taget. De fleste modellene kan bygges en om gangen. Useimmat mallit voidaan rakentaa yksi kerrallaan. Τα περισσότερα μοντέλα μπορούν να κατασκευασθούν ένα ένα. Modellerin çoğu ayrı ayrı inşa edilmeyi gerektirebilir. Většinou lze najednou sestavit pouze jeden model. Väčšina modelov môže byť zostavená iba raz. A modellek többségéből egyszerre csak egy építhető.ほとんどのモデルは、一度に一つを組み立てることができます。

يمكن تركيب التصميم الواحد تلو الآخر.
大多數型號可一次性建構

2x
AM011138YE

3x
AM79666F

2x
AM033288YE

1x
AM17787F

2x
AM742998YE

2x
AM743008YE

1x
AM80546F

1x
AM815458YE

1x
AM815468YE

1x
AS-HHL98-05

1x
AS-HHL98-06

1x
AM07590B

2x
AM0225018YE

1x
AM09393AMC

2x
AM09393B

1x
AM09393F

1x
AM744278YE

1x
AM744268YE

2x
AM78486F

1x
AM784868YE

1x
AM03019F

2x
AM744288YE

1x
AM81383F

1x
AM813828YE

1x
AM813818YE

4x
AM809668YE

2x
AM80966F

3x
AM013148YE

1x
AM01314AMC

1x
AM01314B

1x
AM81259AMC

1x
AM812598YE

1x
AM81259B

4x
AS-HHL98-10

1x
AM16384F

1x
AM03772B

1x
AM03873B

1x
AM81163B

1x
AM81163AMC

4x
AM809728YE

1x
AM815478YE

2x
AM809708YE

1x
AS-HHL98-04

1x
AS-HHL98-01

5x
AM074758YE

1x
AS-HHL98-08

1x
AM809688YE

1x
AM815438YE

1x
AS-HHL98-07

2x
AM80971F

1x
AS-HHL98-02

1x
AS-HHL98-03

1x
AS-HHL98-09

1x
FIG-HHL98-A



Missing pieces? • Pièces manquantes?

¿Partes faltantes? • Perdeu peças?
 Fehlen Teile? • Не хватает деталей?

support.megabrands.com

Mattel Europa B.V., Gondel 1, 1186 MJ Amstelveen, Nederland. Mattel U.K. Limited, The Porter Building, 1 Brunel Way, Slough SL1 1FQ, UK. Mattel France, Parc de la Cerisaie, 1/3/5 allée des Fleurs, 94260 Fresnes Cedex. N° Cristal 0969 36 99 99 (Numéro non surtaxé) ou www.lesjouetsmattel.fr Mattel Belgium, Trade Mart, Atomiumsquare, Bogota 202 – B 275, 1020 Brussels. Gratis nummer België: 0800 – 16 936 - Gratis nummer Luxemburg: 800 - 22 784 - Gratis nummer Nederland: 0800 - 262 88 35. Deutschland : Mattel GmbH, Solmsstraße 83, D-60486 Frankfurt am Main. Schweiz: Mattel AG, Kirchstrasse 24, CH-3097 Liebefeld. Österreich: Mattel Ges.m.b.H., Campus 21, Liebermannstraße A01 404, A- 2345 Brunn/Gebirge. Mattel Italy Srl, Via Turati 4, 20121 Milano, Italy. Servizio assistenza clienti: Customersrvitalia@mattel.com - Numero verde 800 11 37 11. Mattel España, S.A. Aribau 200 pl. 9, 08036 Barcelona. cservice.spain@mattel.com Tel.: +34 933 06 79 00 http://www.service.mattel.com/evs. Mattel East Asia Ltd., Room 503-09, North Tower, World Finance Centre, Harbour City, Tsimshatsui, HK, China. Tel.: (852) 3185-6500. Diimport & Diedarkan Oleh: Mattel Continental Asia Sdn Bhd. Level 19, Tower 3, Avenue 7, No. 8 Jalan Kerinchi, Bangsar South, 59200 Kuala Lumpur, Malaysia. Mattel South Africa (PTY) Ltd. Office 10213, 30 Melrose Boulevard, Johannesburg 2196. Dystrybutor: Mattel Poland Sp. z o.o., Warsaw Trade Tower 34 p., ul. Chłodna 51, 00-867 Warszawa. Mattel Australia Pty. Ltd., 658 Church St., Richmond, Victoria, 3121. Consumer Advisory Service - 1300 135 312. Mattel AEBE, Εθνόγιορ Μακρικού 1, Κτήριο Κ-2, ΤΚ 17561, Πλακιά Φθιάρο. Mattel Oyuncakçılık Tic. Ltd. Şti. İçerenköy Mah. Umut Sok. No:10-12 Quick Tower Kat:2/15 34752 Ataşehir İstanbul Tel: 0216 570 75 00. Импортёр/Уполномоченная организация: ООО "МАТТЕЛ" Российская Федерация, 105120 Москва, 2-й Сыромятинский переулочк 1; +7 495 287 79 39. Mattel Czech Republic s.r.o., The Forum, Václavské nám. 19, 11000 Praha 1. Mattel, 333 Continental Boulevard, El Segundo, CA 90245, USA. Consumer Services: 1-800-465-MEGA (6342). Mattel Canada Inc., Mississauga, Ontario L5R 3W2. Consumer Services: You may call us free at/ Composez sans frais le 1-800-524-8697. Importado y distribuido por Mattel de México, S.A. de C.V., Miguel de Cervantes Saavedra No. 193, Pisos 10 y 11, Col. Granada, Alcaldía Miguel Hidalgo, C.P. 11520, México, Ciudad de México. R.F.C. MME-920701-NB3. Tels: 59-05-51-00 Ext. 5206 ó 01-800-463-59-89. Mattel Chile, S.A., Avenida América Vespuccio 501-B, Quilicura, Santiago. Tel.: 1230-020-6213. Servicio al consumidor Venezuela: Tel: 0-800-100-9123. Mattel Argentina, S.A., Av. Libertador 1000, Piso 11 – Oficinas 109 y 111, Vicente López – Prov. Buenos Aires. Tel: 0800-666-3373. Mattel Colombia, S.A., Calle 123#7-07 P5, Bogotá. Tel: 01800-710-2069. Mattel Perú, S.A., Av. Juan de Arona # 151, Centro Empresarial Juan de Arona, Torre C, Piso 7, Oficina 704, San Isidro, Lima 27, Perú. RUC: 20425853865. Reg. Importador: 02350-12-JUE-DIGESA. Tel: 0800-54744. E-mail Latinoamérica: servicio.clientes@mattel.com. Mattel do Brasil Ltda.- CNPJ : 54.558.002/0001-20 - Rua Verbo Divino, 1488 - 2º Andar - 04719-904 - Chácara Santo Antônio - São Paulo - SP - Brasil. Serviço de Atendimento ao Consumidor: fone 0800 575 0780. E-mail: sac.matteldobrazil@mattel.com

ATTENTION : DANGER
D'ÉTOUFFEMENT. - PRÉSENCE DE PETITS
ÉLÉMENTS. NE CONVIENT PAS AUX ENFANTS DE
MOINS DE 3 ANS.

ATENÇÃO! NÃO INDICADO / NÃO
RECOMENDÁVEL PARA CRIANÇAS MENORES DE 3
(TRÊS) ANOS POR CONTER PARTE(S) PEQUENA(S)
QUE PODE(M) SER ENGOLIDA(S) OU ASPIRADA(S)
PODENDO PROVOCAR ASFIXIA.

警告：
のどにつまる危険 小さな部品が含まれています
3歳以下の子供には与えないで下さい。

警告!
不适合3岁以下儿童使用。
内含小零件。

⚠ WARNING : CHOKING HAZARD. - Small parts.
Not for children under 3 years.
ADVERTENCIA: PELIGRO DE ATRAGANTAMIENTO. Jugue no recomendado
para menores de 3 años, porque contiene piezas pequeñas que podrían
provocar asfixia en caso de ser ingeridas o inhaladas por el/la niño/a.
AVVERTENZA: Contiene pezzi di piccole dimensioni.
ACHTUNG: Kleine Teile.
OSTRZEŻENIE: Małe części. Niebezpieczeństwo zadławienia.
WAARSCHUWING: Kleine onderdelen
ПРЕДУПРЕЖДЕНИЕ: Мелкие детали.
ADVARSEL: Indeholder små dele.
WARNING: Små delar
ADVARSEL: Små deler
VAROITUS: Pieniä osia
ΠΡΟΣΟΧΗ: Περιλαμβάνονται μικρά κομμάτια.
UYARI: Küçük parçalar.
UPOZORNĚNÍ: Malé díly
UPOZORNENIE: Malé časti
FİGELMEZTETÉS: Kis alkatrészek.



تحذير:
غير مناسبة للأطفال دون 36 شهراً - قطع صغيرة.

BUILD YOUR WAY BY COMBINING MEGA™ HOT WHEELS® SETS CRÉEZ VOTRE UNIVERS EN ASSOCIANT LES COFFRETS HOT WHEELS® MEGA™



HHD18

HHL96

HHL95

HHL97

HHL98

HDJ95

CONSTRUYE EL RETO COMBINANDO LOS CONJUNTOS DE HOT WHEELS® DE MEGA™
CONSTRUA O DESAFIO COMBINANDO OS CONJUNTOS MEGA™ HOT WHEELS®
EIGENE STRECKEN BAUEN DURCH DAS KOMBINIEREN VON MEGA HOT WHEELS SETS
СТРОИТЕ ПО-СВОЕМУ, ОБЪЕДИНЯЯ НАБОРЫ MEGA™ HOT WHEELS®

Set(s) sold separately and subject to availability. / Ensemble(s)
vendu(s) séparément. Certains produits peuvent ne pas être
commercialisés. / Se vende(n) por separado y está(n) sujeto(s) a disponibilidad. / Conjunto(s)
vendido(s) em separado e sujeito(s) à disponibilidade. / Set(in) vendita separatamente, secondo disponibilità.
/ Das/Die Set(s) sind separat erhältlich. / Zestaw(y) sprzedawany(e) oddzielnie w zależności od dostępności.
/ Set(s) apart verkrijgbaar en afhankelijk van beschikbaarheid. / Набор(-ы) продаются отдельно, при
наличии. / Sæt sælges separat og så længe lager haves. / Seten säljs separat så länge lagret räcker. /
Settet/settene selges separat så langt lageret rekker. / Pakkaus/pakkukset myydään erikseen, saatavuus
voi vaihdella. / Το(α) σετ πωλούνται ξεχωριστά και ανάλογα με τη διαθεσιμότητα. / Setler ayrı olarak satılır
ve stoklarla sınırlıdır. / Set (sety) se prodává (prodávají) samostatně dle aktuální nabídky. / Súprava/-y sa
predáva(jú) samostatne a podľa dostupnosti. / A készlet(ek) külön kapható(k), az elérhetőség változhat. /
セット商品は別売りになります。在庫状況は別途ご確認をお願いします。 /
تباع المجموعة أو المجموعات على حدة وتخضع لظروفها.
每套单独发售，按供货情况决定。

©2021 MEGA Brands &™ MEGA Brands.
Printed in China / Imprimé en Chine

1186 MJ, 1, NL
AD-HHL98-01A



OFFICIAL
LICENSEE

General Motors Trademarks used
under license to Mattel, Inc.

HOT WHEELS® and associated trademarks
and trade dress are owned by, and used
under license from, Mattel. ©2021 Mattel.

Mattel Canada Inc. Mississauga,
Ontario L5R 3W2.

MADE IN CHINA. FABRIQUÉ EN CHINE. **FABRICADO NA CHINA.**
HECHO EN CHINA. ИЗГОТОВЛЕНО В КИТАЕ. ÇIN'DE
ÜRETİLMİŞTİR. صنع في الصين.

Ⓟ D714,887

