

**MEGA**<sup>TM</sup>  
CONSTRUX

# MASTERS OF THE UNIVERSE



LAND SHARK  
TIBURÓN TERRESTRE





**MEGA**  
**UNBOXED**

## Build | Construisez

Construye | Constrói  
Bauen | Стройте

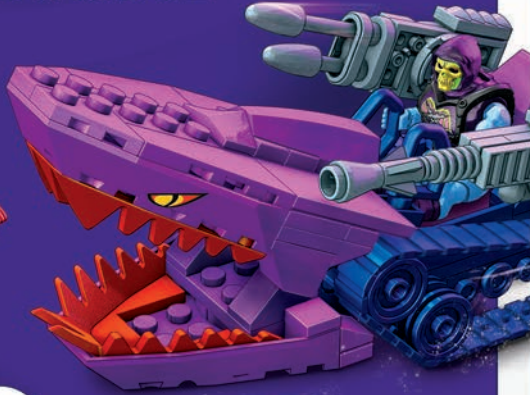

## Share Partagez

Comparte | Partilha  
Teilen | Делитесь



Devices not included | Appareils non inclus | Dispositivos no  
incluído | Dispositivos não incluídos | Geräte nicht enthalten  
Устройства не входят в комплект

[unboxed.megaconstrux.com](http://unboxed.megaconstrux.com)



1

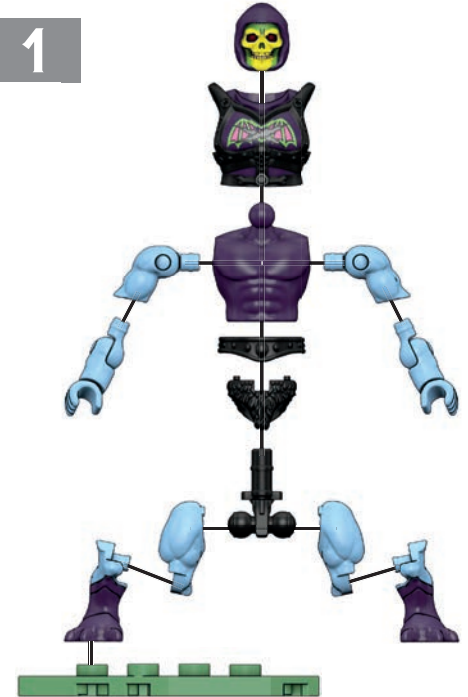

1



2



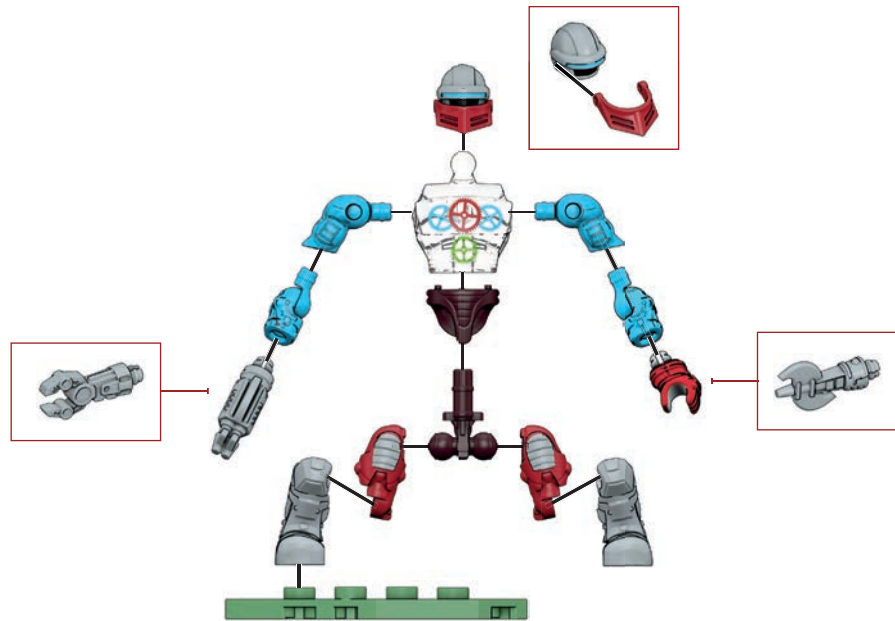

1



2

or / ou / o



2



3





2

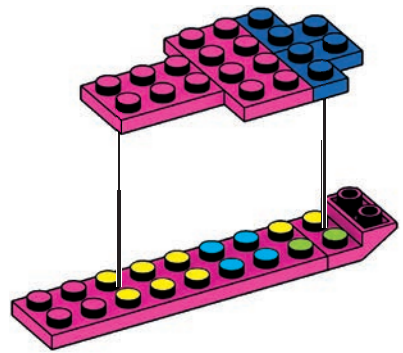
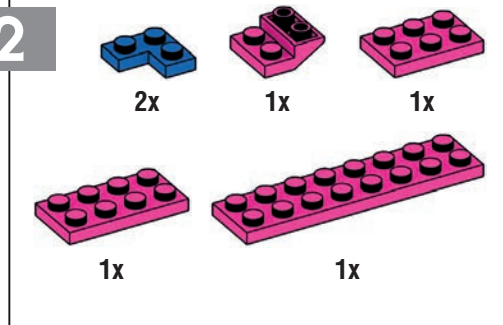

3

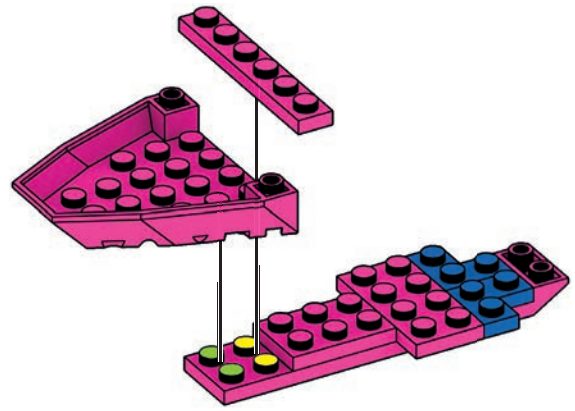
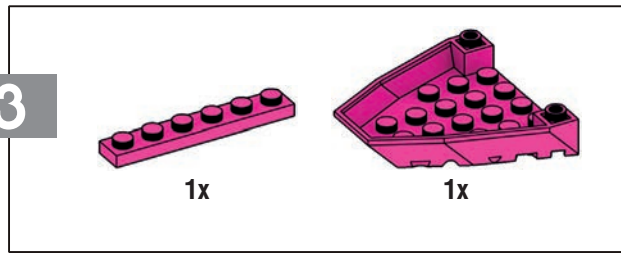



4

2x

2x

2x

1x

x2

5

2x

1x

1x

5

6

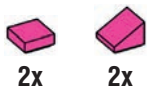

2x

2x

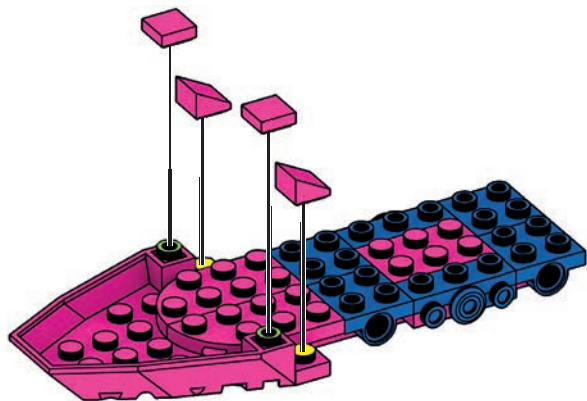

7



1x

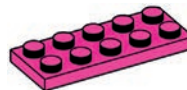

1x

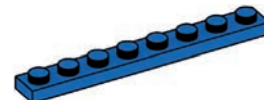

2x

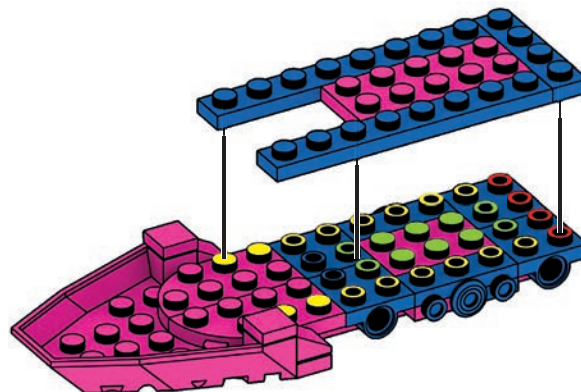

8



2x

2x



1x

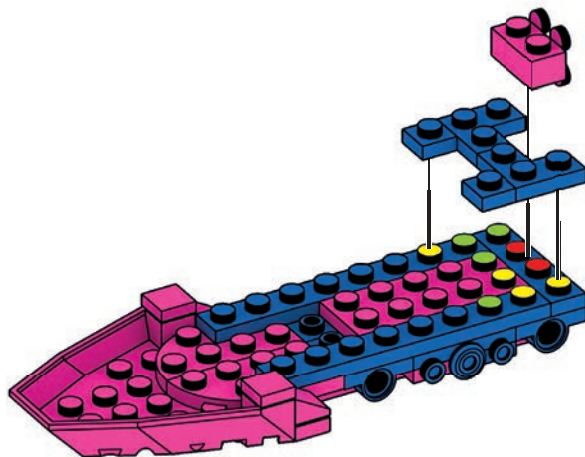



9



1x



2x

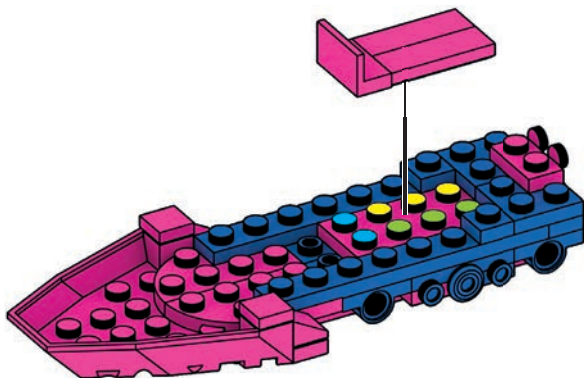

10



1x



2x

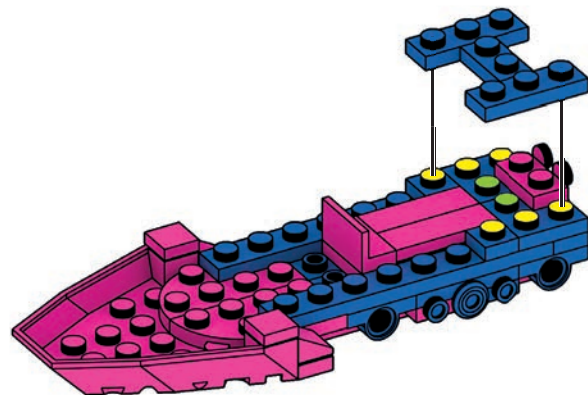

11



2x

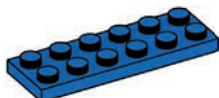

1x

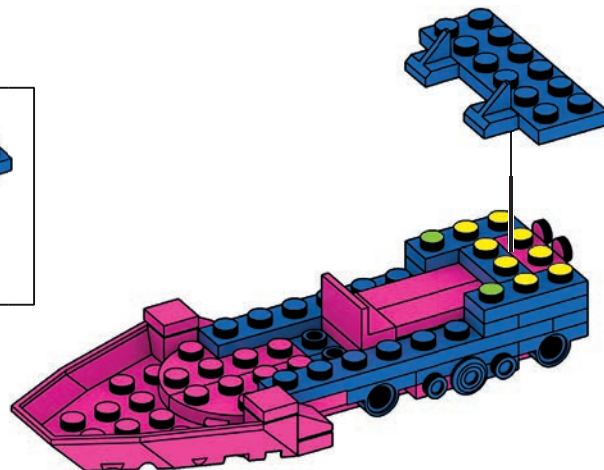

12

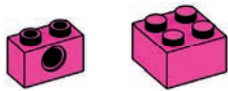

2x

1x

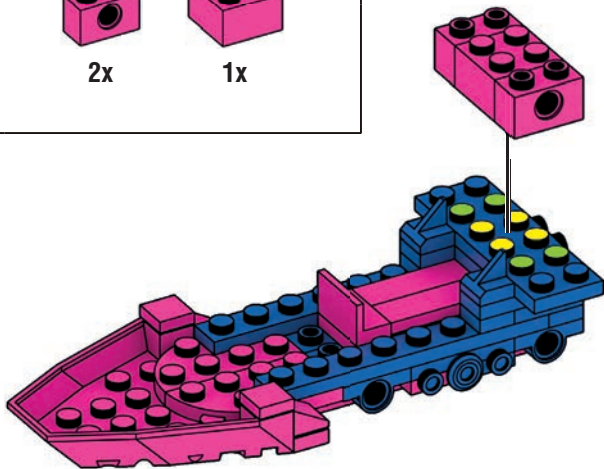

13



1x

1x

1x

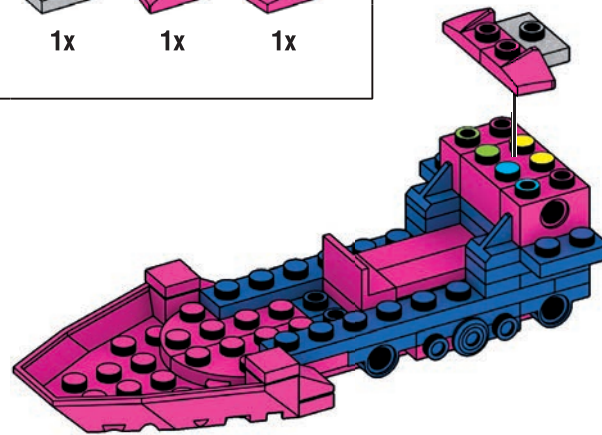

14



1x

1x

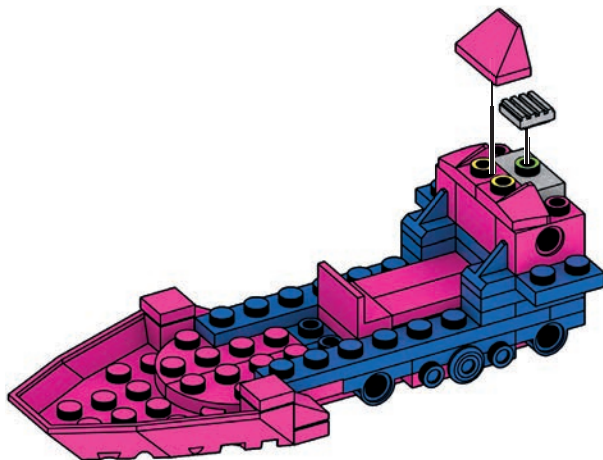



15



2x

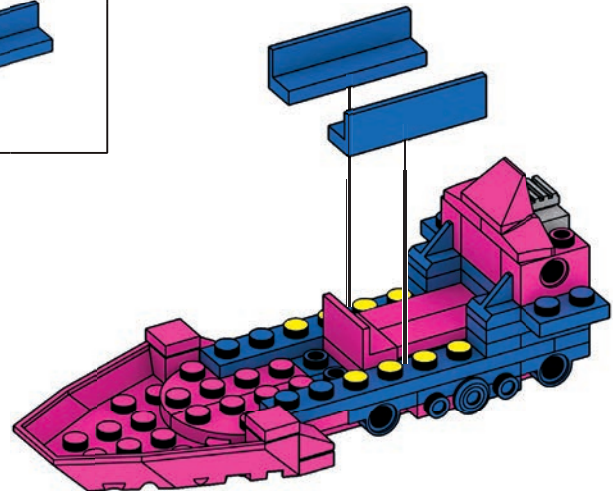

1

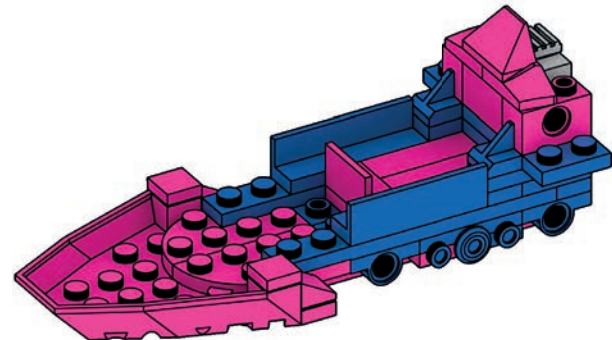

2



3

16

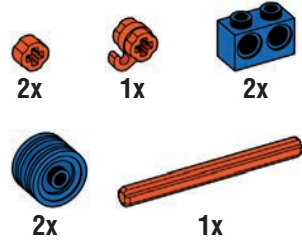

2x

1x

2x

2x

1x

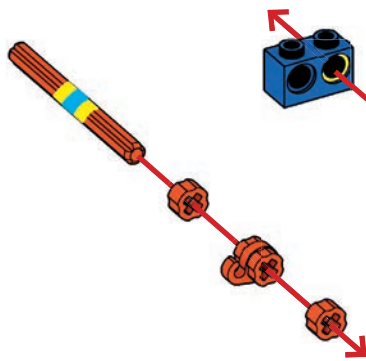

1

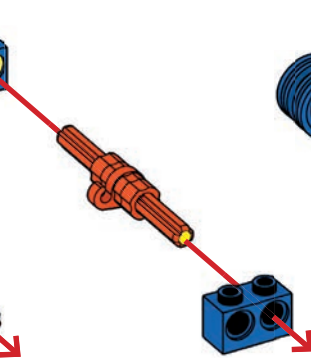

2

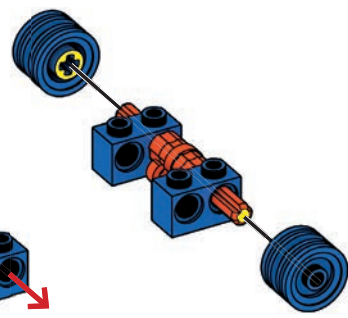

3



17

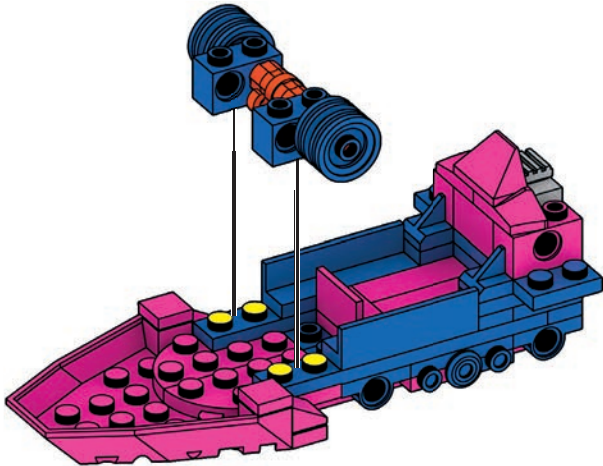

18

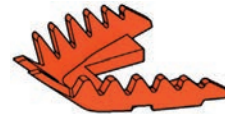

1x

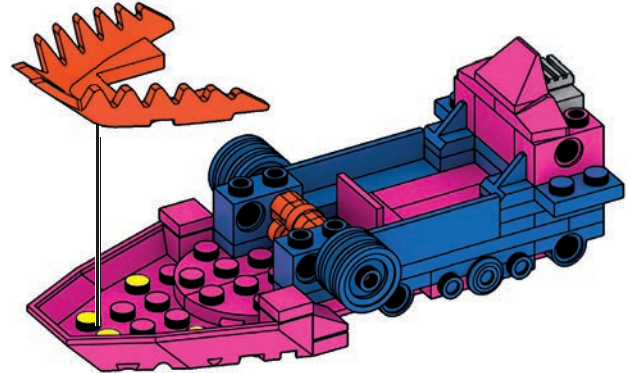

19



2x

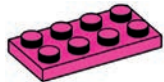

1x

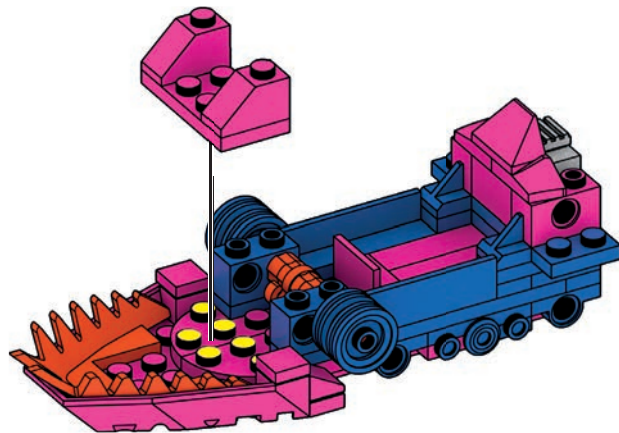
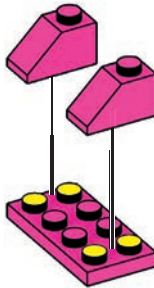



20

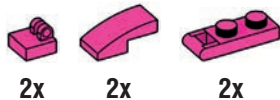

2x

2x

2x

x2

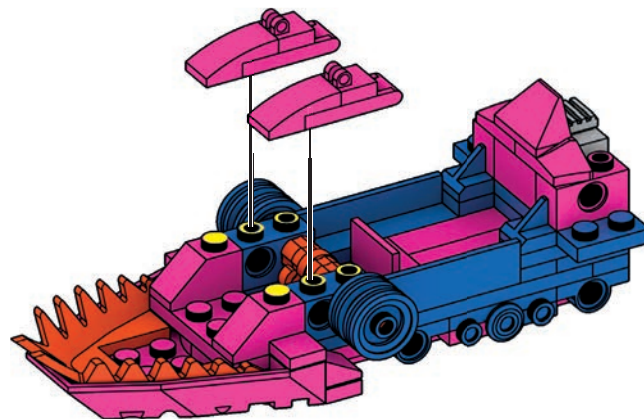

21



2x

2x

x2

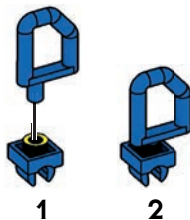

1

2

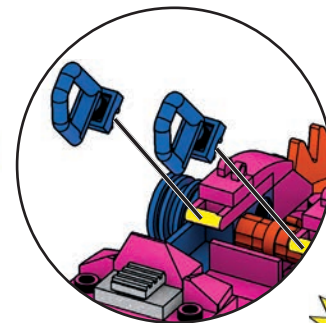
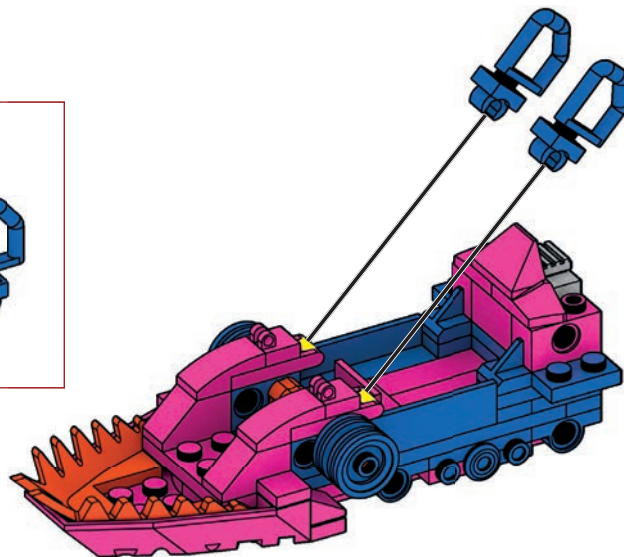

22

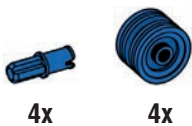

x4

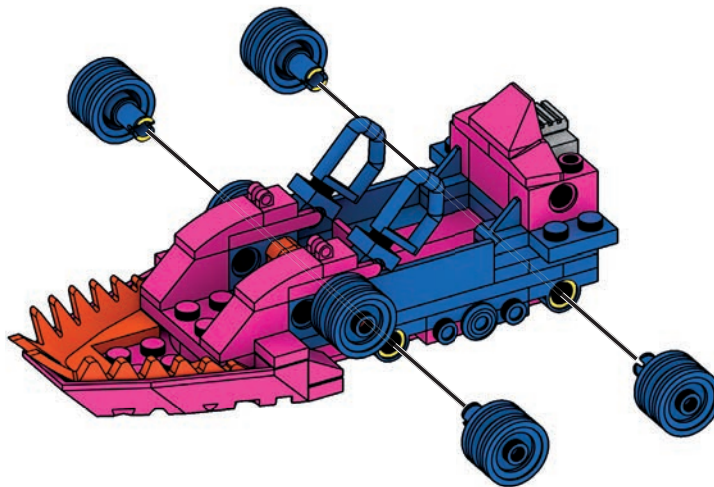
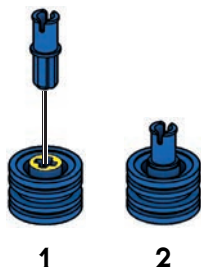

23

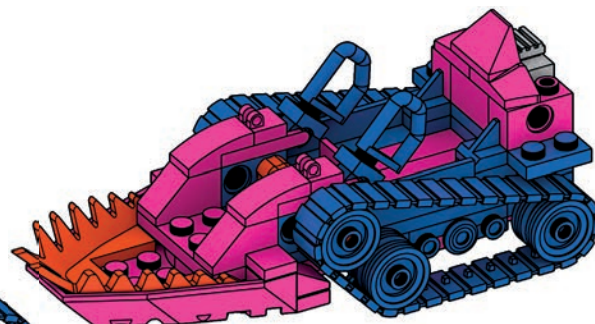
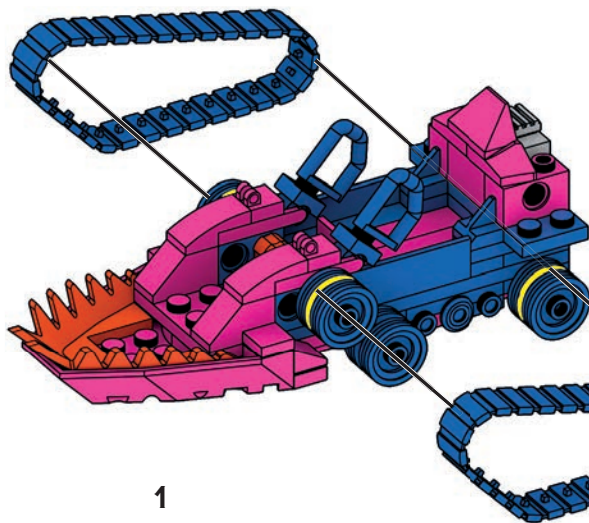

1

2





24



1x



1x

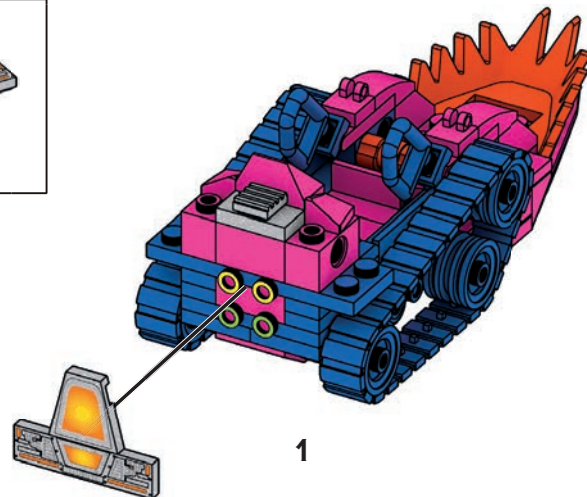

1

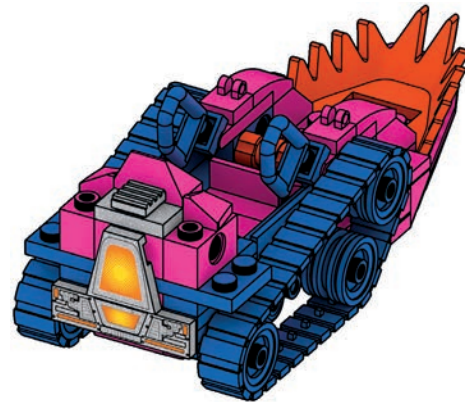

2

25



1x

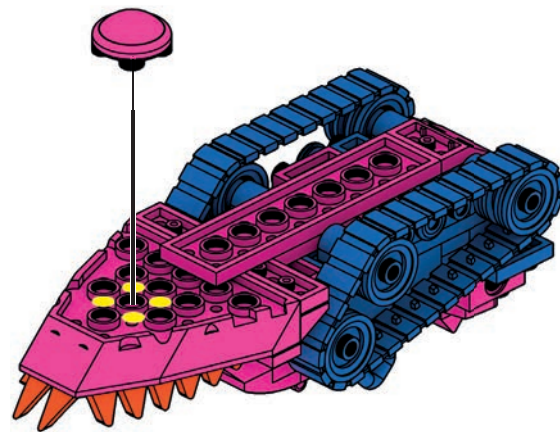

1

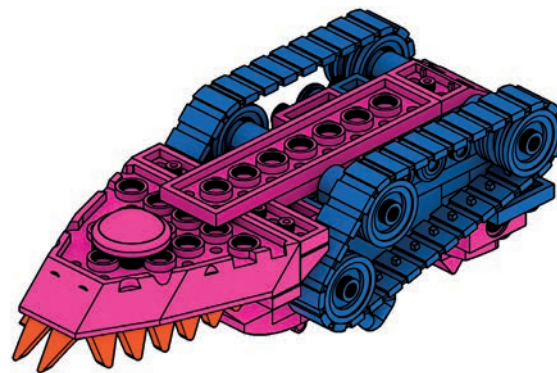

2

26

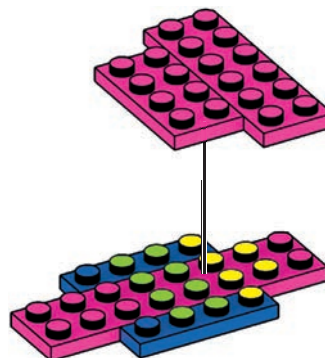
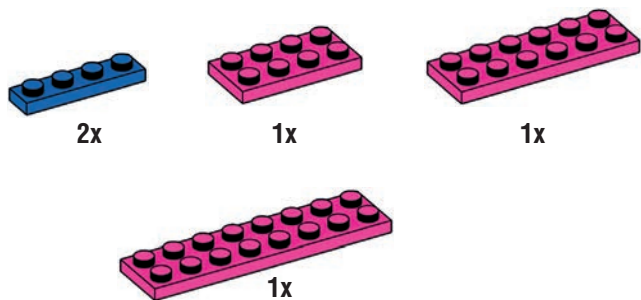

27

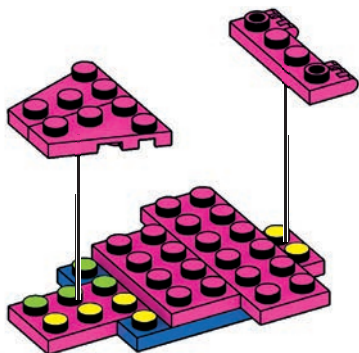
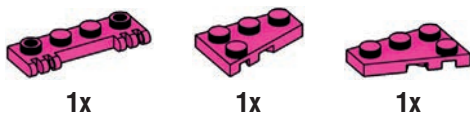

28

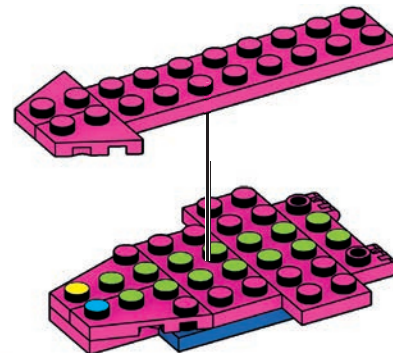
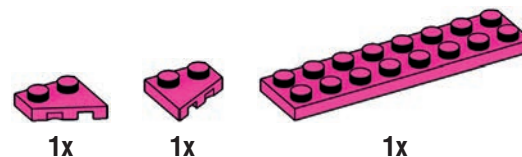

14



29

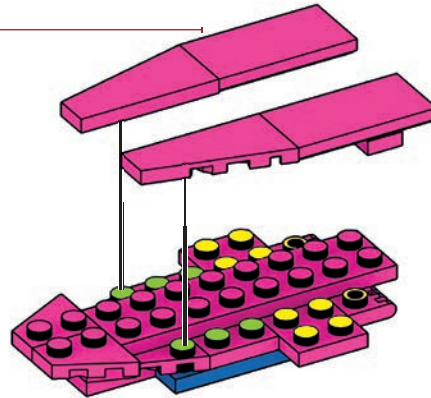
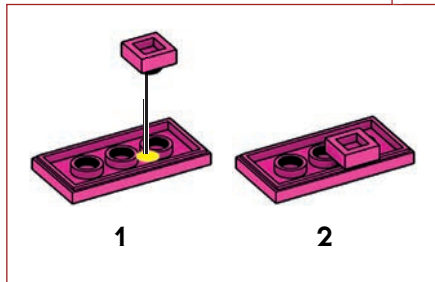
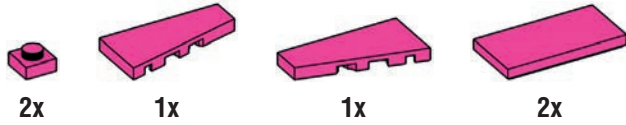

1

2

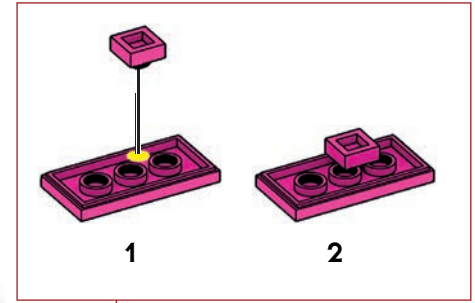

1

2

30

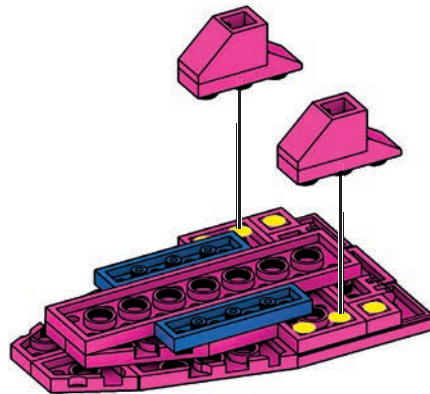
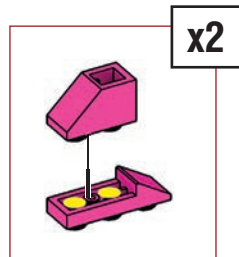
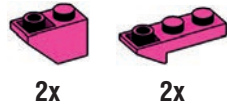

cc

31



1x

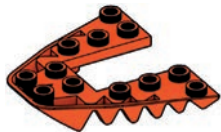

1x



1x

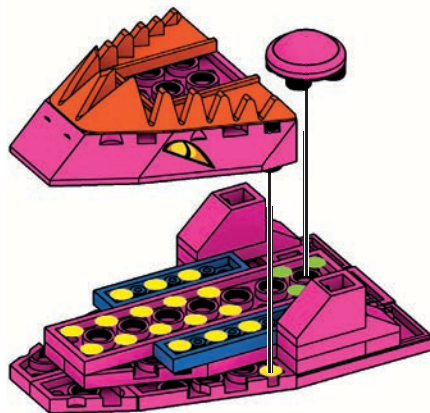
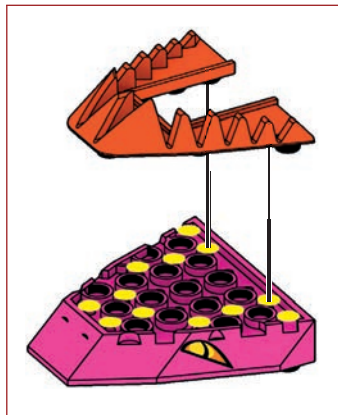

1

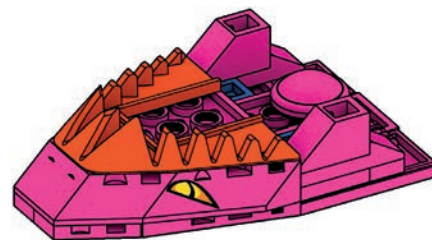

2

32



2x

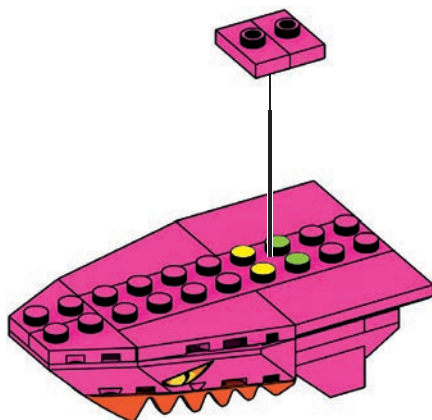

33



1x



1x

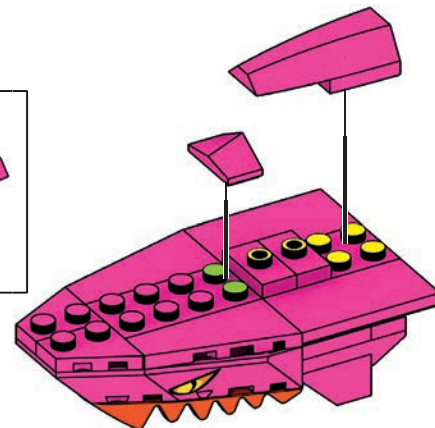



34

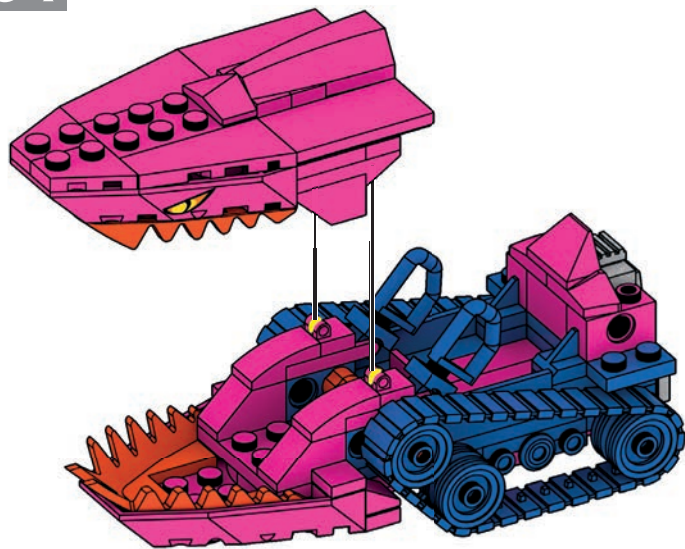

1

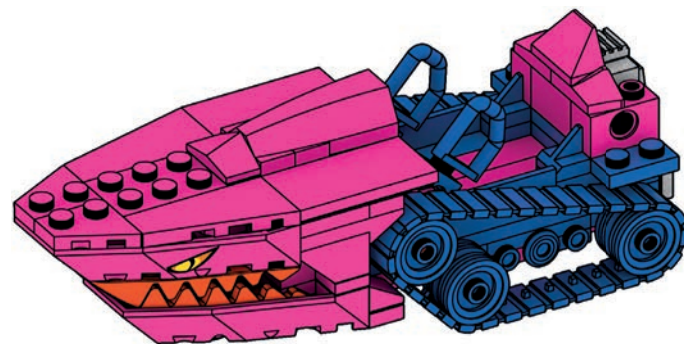
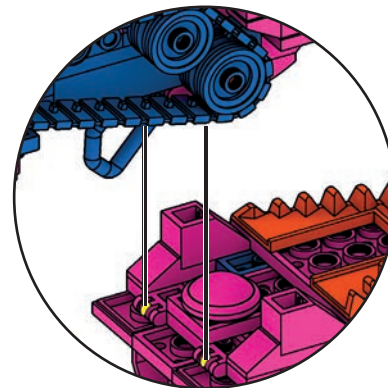

2





35



1x



1x



1x



1x

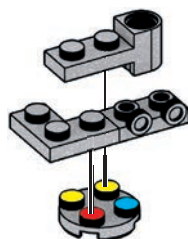

36



1x



1x



1x

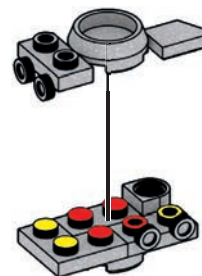

37



1x

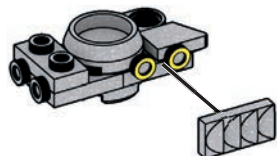

1

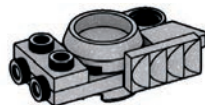

2

38



2x



2x



1x



1x

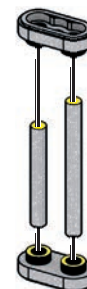

1

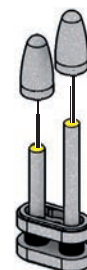

2

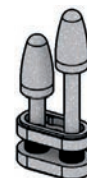

3



39

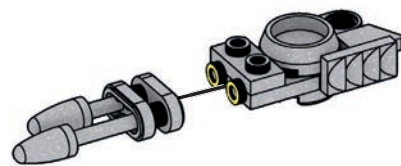

1

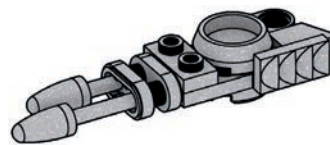

2

40



1x

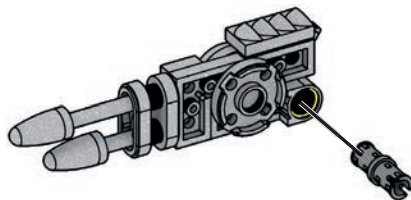

1

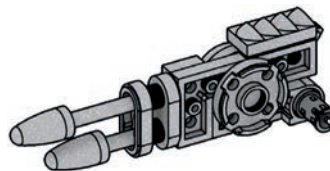

2

41

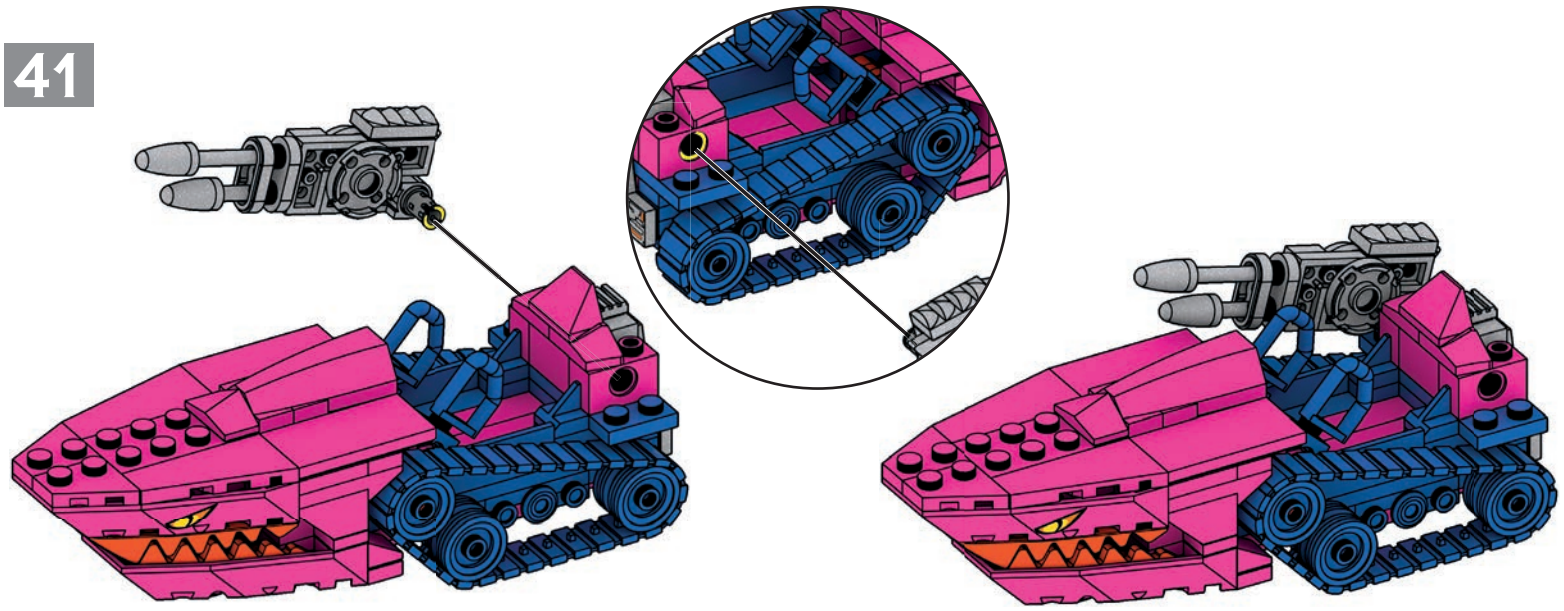

1

2

42

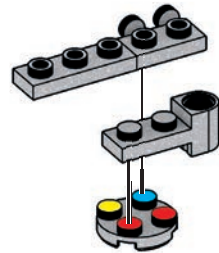
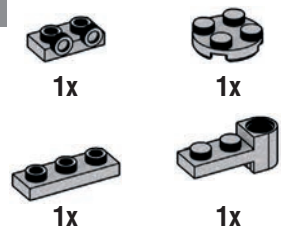

43

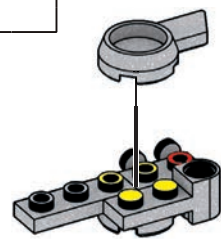
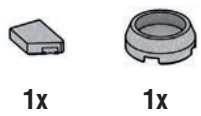



44



1x

1x

1x



1x

1x

1x



1x

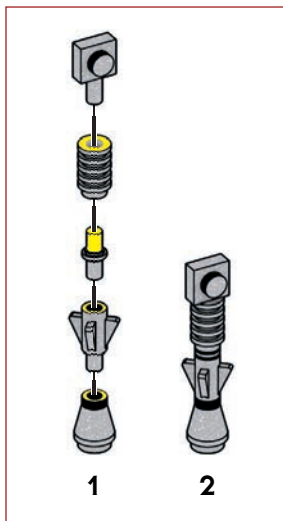

1

2

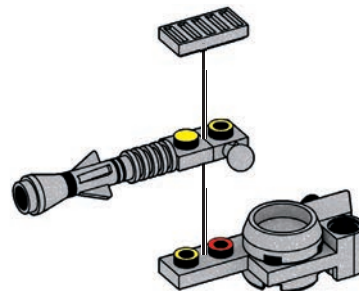

1

2

45



1x

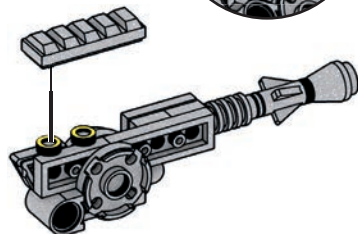

46



1x

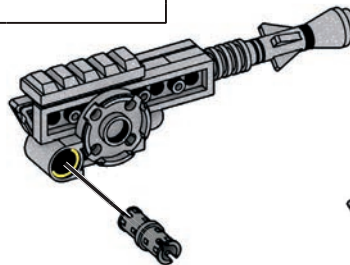

1

2

21

47

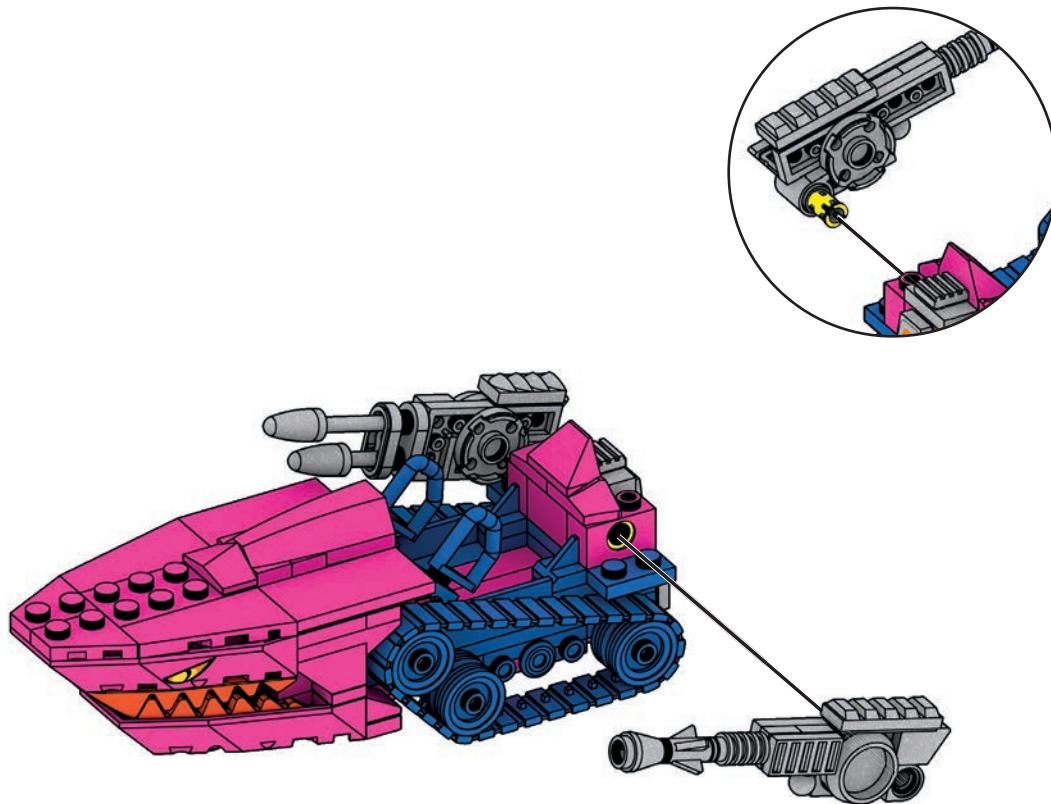

1

22



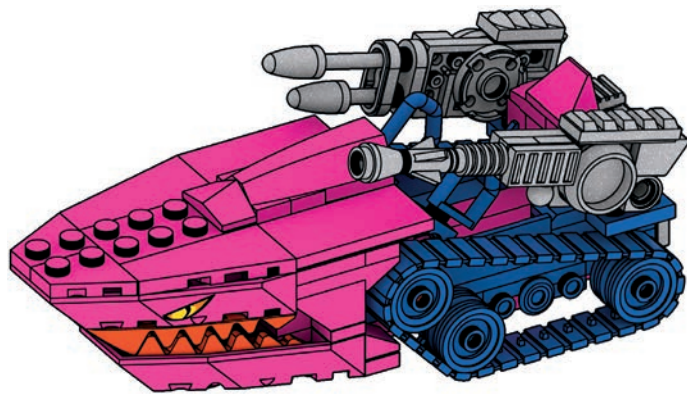

2

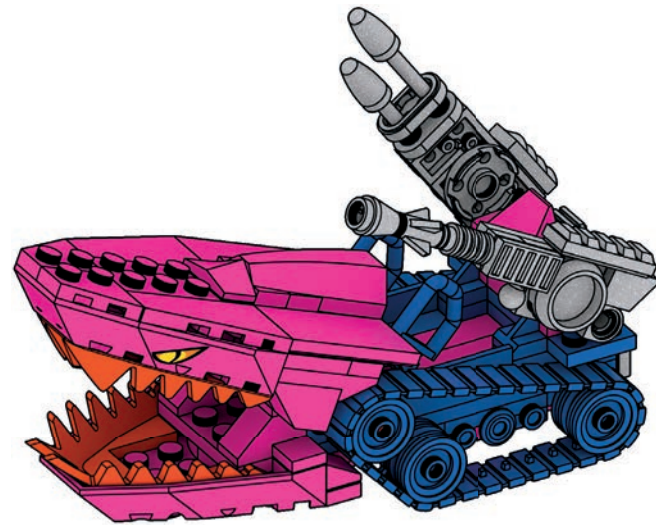

3



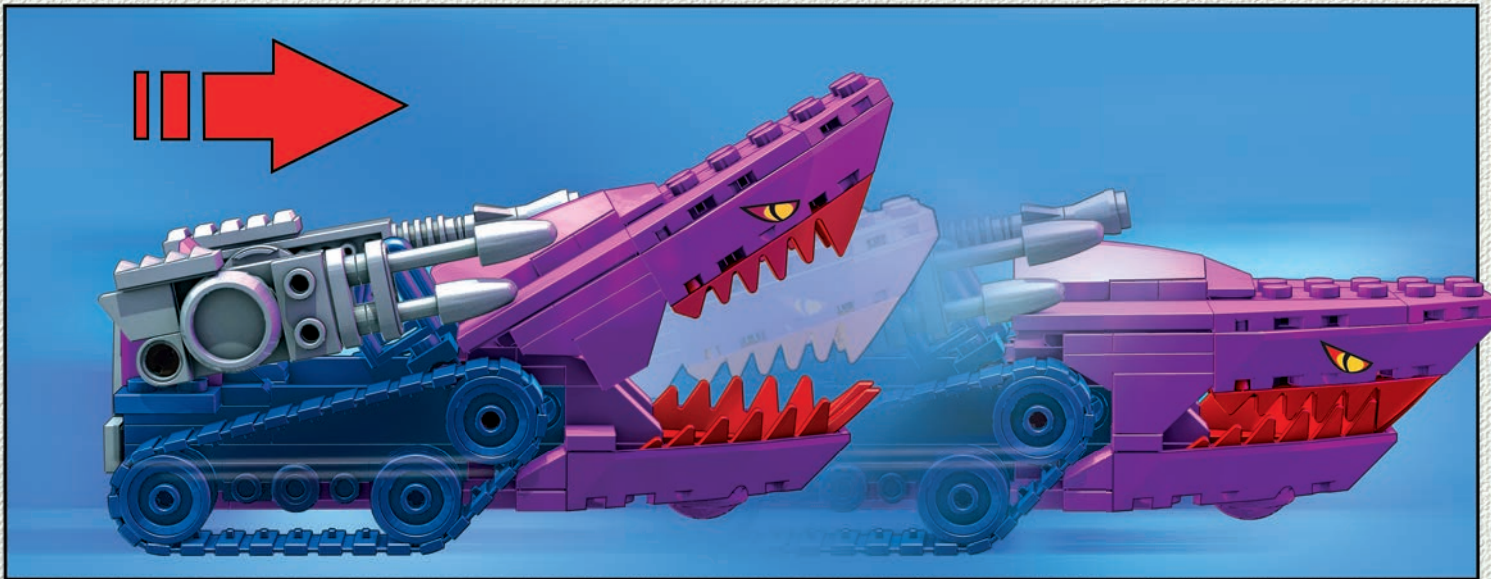





Land Shark / Tiburón terrestre / Pojazd Rekin / Haai op het droge / Танк-акула  
Τανκ Καρχαρίας / Landhaj / Hajtank / مركبة أرض القرش



1x  
AM79666APG

2x  
AM77341B

1x  
AM17003APG

1x  
AM80877MCX

2x  
AM79432APG

2x  
AM79915MCX

2x  
AM07223ACJ

2x  
AM03328B

2x  
AM03328ACJ

2x  
AM09104ACJ

2x  
AM17127ACJ

2x  
AM76277B

1x  
AM79377APG

1x  
AM81215APG

1x  
AM74214APG

2x  
AM18623B

1x  
AM01140APG

1x  
AM74299APG

1x  
AM74300APG

1x  
AM75498APG

2x  
AM73534BDG

4x  
AM79704B

1x  
AM17131ACJ

2x  
AM80174APG

1x  
AM09393B

1x  
AM09198APG

1x  
AM01166APG

1x  
AM07590APG

2x  
AM07590ACJ

1x  
AM76467APG

2x  
AM79070APG

1x  
AM07228ACJ

1x  
AM72494ACJ

1x  
AM72495ACJ

1x  
AM18665ACJ

1x  
AM18666ACJ

2x  
AM17057ACJ

2x  
AM74677APG

2x  
AM72972APG

2x  
AM78486ACJ

1x  
AM19061ACJ

2x  
AM01417ACJ

2x  
AM01322ACJ

1x  
AM81353ACJ

2x  
AM79877ACJ

2x  
AM79878B

2x  
AM19162B

4x  
AM15484B

1x  
AM15484APG

1x  
AS-HDK07-01

4x  
AM79952B

6x  
AM79765B

1x  
AM18223ACJ

1x  
AM09023ACJ

2x  
AM16954ACJ

2x  
AM80966ACJ

1x  
AM74103APG

2x  
AM01314B

2x  
AM19326ACJ

1x  
AM72600APG

2x  
AM81260B

1x  
AM79355APG

2x  
AM78107APG

1x  
AM17073ACJ

1x  
AM17074ACJ

2x  
AM03772ACJ

1x  
AM76521APG

2x  
AM17521B

1x  
AM01390ACJ

3x  
AM09593B

1x  
AS-HDK07-02

1x  
AM03324ACJ



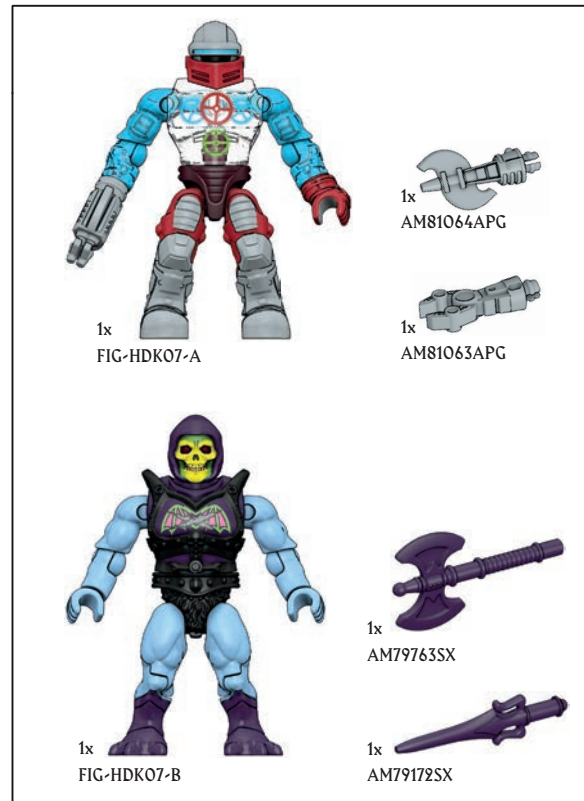
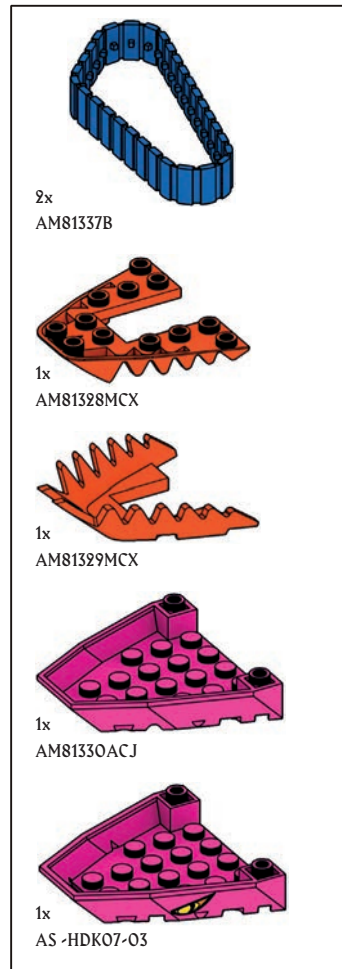
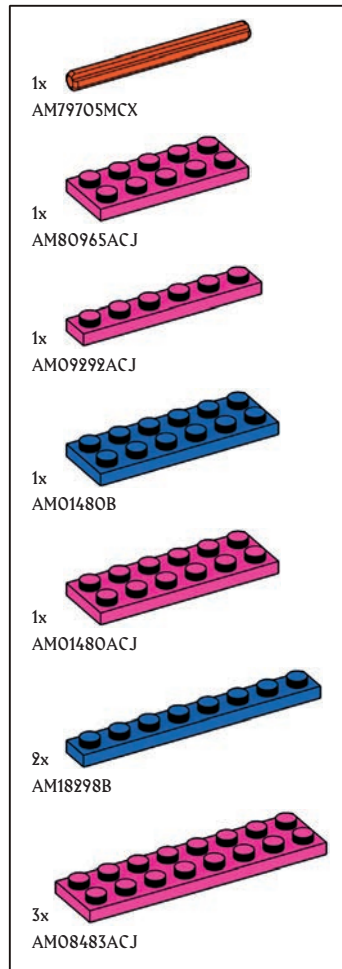
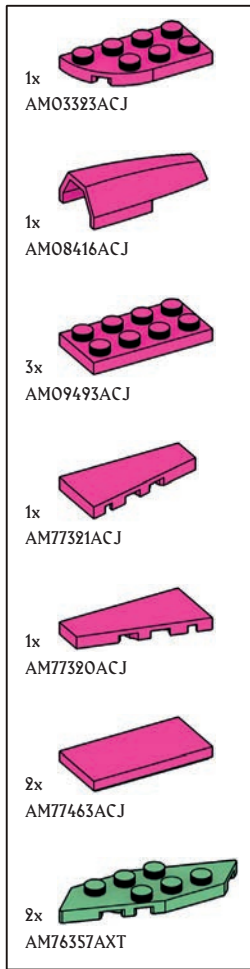

**Missing pieces?  
Pièces manquantes?**  
¿Partes faltantes? · Perdeu peças?  
Fehlen Teile? · Не хватает деталей?

[support.megabrand.com](http://support.megabrand.com)

Mattel Europa B.V., Gondel 1, 1186 MJ Amstelveen, Nederland. Mattel U.K. Limited, The Porter Building, 1 Brunel Way, Slough SL1 1FQ, UK. Mattel France, Parc de la Cerisaie, 1/3/5 allée des Fleurs, 94260 Fresnes Cedex. N° Cristal 0969 36 99 99 (Numéro non surtaxé) ou www.lesjouetsmattel.fr Mattel Belgium, Trade Mart, Atomiumsquare, Bogota 202 - B 275, 1020 Brussels. Gratis nummer België: 0800 - 16 936 - Gratis nummer Luxemburg: 800 - 22 784 - Gratis nummer Nederland: 0800 - 262 88 35. Deutschland : Mattel GmbH, Solmsstraße 4, D-60486 Frankfurt am Main, Schweiz: Mattel AG, Kirchstrasse 24, CH-3097 Liebefeld. Österreich: Mattel Ges.m.b.H., Campus 21, Liebermannstraße A01 404, A- 2345 Brunn/Geirgite, Mattel Italy Srl, Via Bracco, 6-MAC 6, 20159 Milano, Italy. Servizio assistenza clienti: Customersrvitalia@mattel.com - Numero verde 800 11 37 11. Mattel España, S.A., Aribau 200. 08036 Barcelona. cservice.spain@mattel.com Tel: 900 102 390 http://www.service.mattel.com/es. Mattel East Asia Ltd., Room 503-09, North Tower, World Finance Centre, Harbour City, Tsimshatsui, HK, China. Tel: (852) 3185-6500. Diimport & Diedarkan Oleh: Mattel Continental Asia Sdn Bhd. Level 19, Tower 3, Avenue 7, No. 8 Jalan Kerinchi, Bangsar South, 59200 Kuala Lumpur, Malaysia. Mattel South Africa (PTY) LTD, Office 102 I3, 30 Melrose Boulevard, Johannesburg 2196. Dystrybutor: Mattel Poland Sp. z o.o., Warsaw Trade Tower 34 p., ul. Chlodna 51, 00-867 Warszawa. Mattel Australia Pty. Ltd., 658 Church St., Richmond, Victoria, 3121. Consumer Advisory Service - 1300 135 312. Mattel AEBE, Εθνάρχου Μακαρίου 1, Κτήριο Κ-2, ΤΚ 17561, Παλαιό Φάληρο. Mattel Oyuncakçılık Tic. Ltd. Şti. İçerenköy Mah., Erkut Sok. A Blok No:12 Üner Plaza Kat:9-10 34752 Ataşehir İstanbul. Tel: 0216 570 75 00. Импортёр/полномочная организация: ООО "МАТТЕЛ" Российская Федерация, 105120 Москва, 2-й Сыромятинский переулок, 1; +7 495 287 79 39, Mattel Czech Republic s.r.o., The Forum, Václavské nám. 19, 11000 Praha1. Mattel, 333 Continental Boulevard, El Segundo, CA 90245, USA. Consumer Services: 1-800-465-MEGA (6342). Importado y distribuido por Mattel de México, S.A. de C.V., Miguel de Cervantes Saavedra No. 193, Pisos 10 y 11, Col. Granada, Alcaldía Miguel Hidalgo, C.P. 11520, México, Ciudad de México. R.F.C. MME-920701-NB3. Tels: 59-05-51-00 Ext. 5206 ó 01-800-463-59-89. Mattel Chile, S.A., Avenida Américo Vespucio 501-B, Quilicura, Santiago. Tel: 1230-020-6213. Servicio al consumidor Venezuela: Tel: 0-800-100-9123. Mattel Argentina, S.A., Av. Libertador 1000, Piso 11 - Oficinas 109 y 111, Vicente López - Prov. Buenos Aires. Tel: 0800-666-3373. Mattel Colombia, S.A., Calle 12347-07 P5, Bogotá. Tel: 01800-710-2069. Mattel Perú, S.A., Av. Juan de Arona # 151, Centro Empresarial Juan de Arona, Torre C, Piso 7, Oficina 704, San Isidro, Lima 27, Perú. RUC: 20425853865. Reg. Importador: 02350-12-JUE-DIGESA. Tel: 0800-54744. E-mail Latinoamérica: servicio.clientes@mattel.com. Mattel do Brasil Ltda. - CNPJ: 54.558.002/0001-20 - Rua Verbo Divino, 1488 - 2º. Andar - 04719-904 - Chácara Santo Antônio - São Paulo - SP - Brasil. Serviço de Atendimento ao Consumidor: fone 0800 575 0780. E-mail: sac.matteldobrazil@mattel.com





**MORE TO COLLECT! / ENCORE PLUS À COLLECTIONNER!  
 ¡MÁS PARA COLECCIONAR! / MAIS PARA COLECIONAR!  
 MEHR ZUM SAMMELN! / СОБЕРИ БОЛЬШЕ!**



**GVY14**



**HFF27**

Set(s) sold separately and subject to availability. / Ensemble(s) vendu(s) séparément. Certains produits peuvent ne pas être commercialisés. / Se vende(n) por separado y está(n) sujeto(s) a disponibilidad. / Conjunto(s) vendido(s) em separado e sujeito(s) à disponibilidade. / Set in vendita separatamente, secondo disponibilità. / Das/Die Set(s) sind separat erhältlich. / Zestaw(y) sprzedawany(e) oddzielnie w zależności od dostępności. / Set(s) apart verkrijgbaar en afhankelijk van beschikbaarheid. / Набор(-ы) продаются отдельно, при наличии. / Sæt sælges separat og så længe lager haves. / Seten säljs separat så länge lagret räcker. / Settet/settene selges separat så langt lageret rekker. / Pakkaus/pakkaukset myydään erikseen, saatavuus voi vaihdella. / Το(α) σετ πωλούνται ξεχωριστά και ανάλογα με τη διαθεσιμότητα. / Setler ayrı olarak satılır ve stoklarla sınırlıdır. / Set (sety) se prodává (prodávají) samostatně dle aktuální nabídky. / Súprava/-y sa predáva(jú) samostatne a podľa dostupnosti. / A készlet(ek) külön kapható(k), az elérhetőség változhat. / セット商品は別売りになります。在庫状況は別途ご確認お願いします。 / تباع المجموعة أو المجموعات على حدة وتخضع لتوافرها.

© D714,887, D781,964, D797,203, D841,101

HE-MAN™, MASTERS OF THE UNIVERSE™ and associated trademarks and trade dress are owned by, and used under license from Mattel, Inc. ©2021 Mattel.

Mattel Canada Inc. Mississauga, Ontario L5R 3W2.  
 MADE IN CHINA. FABRIQUÉ EN CHINE. FABRICADO NA / HECHO EN CHINA.  
 ИЗГОТОВЛЕНО В КИТАЕ. ÇIN'DE ÜRETİLMİŞTİR. صنع في الصين



1186 MJ, 1, NL

©2021 MEGA Brands & ™ MEGA Brands. CONSTRUX™ is owned by Mattel and used under license. CONSTRUX™ appartient à Mattel et est utilisée sous licence.  
 Printed in China / Imprimé en Chine AD-HDK07-01

