



CADILLAC



HR18

CADILLAC ATS-V R

2

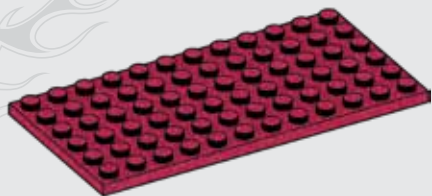

1x

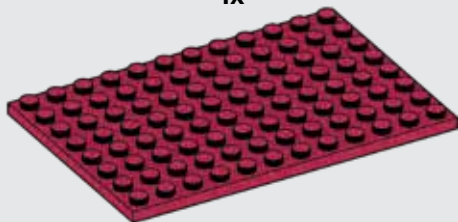

1x

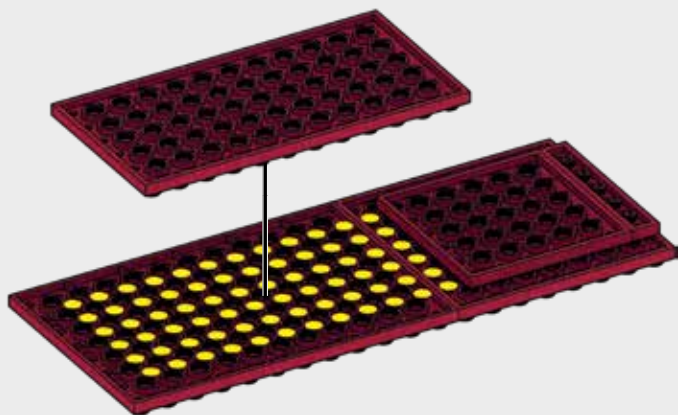

3



2x



2x



2x

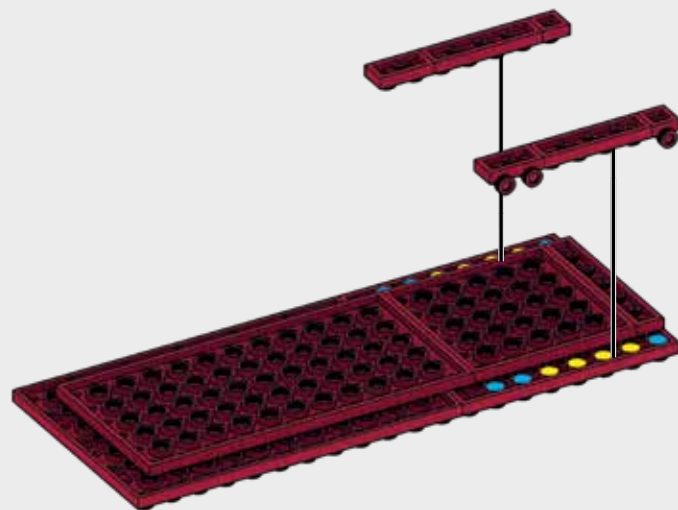

4



4x

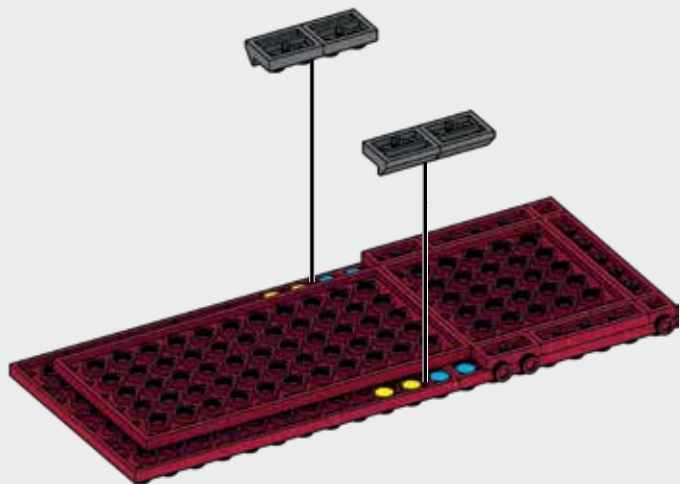

5



2x



1x



1x



2x

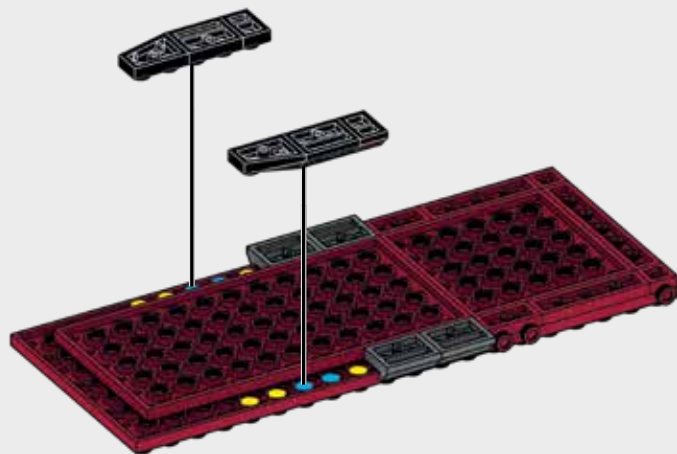

6



2x

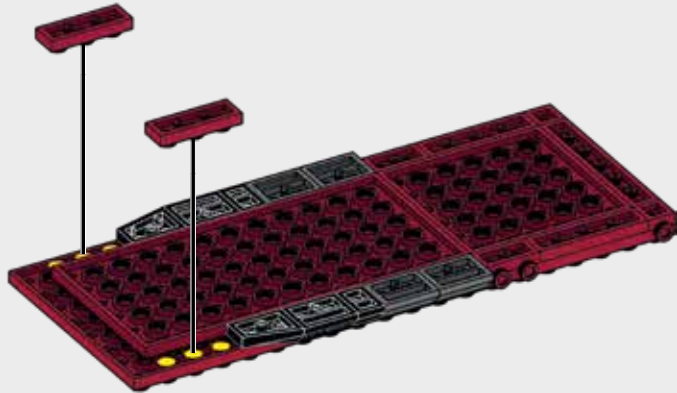

7



1x



1x



1x

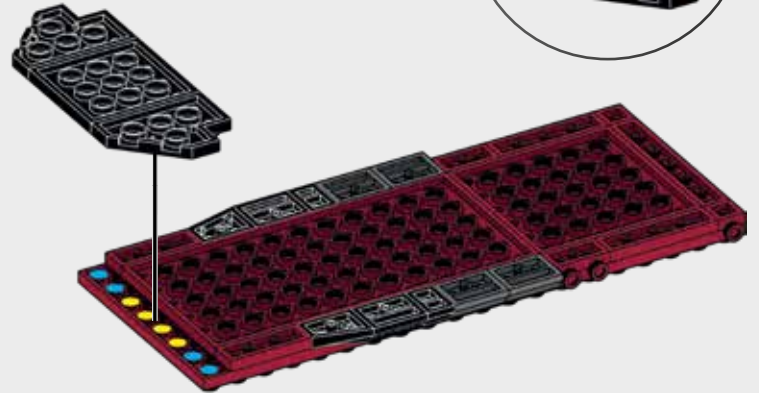

8



1x

9



1x



1x



1x

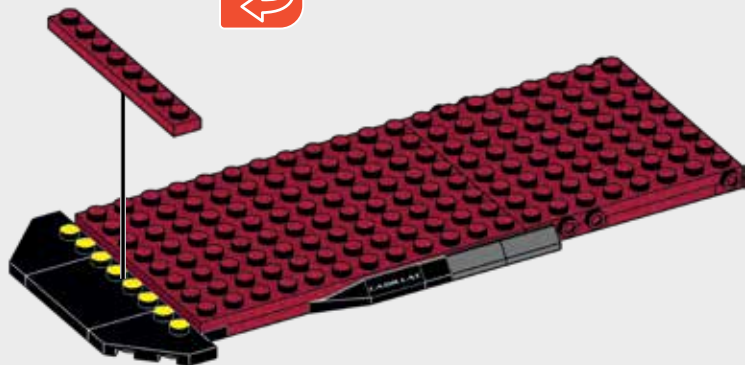

10



1x



2x



11



1x



2x



12



1x



13



1x



1x



1x



2x



1x



1

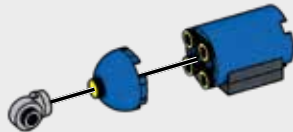

2

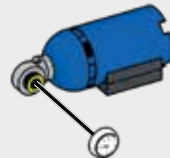

3

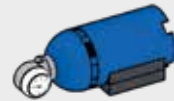

4

14



15

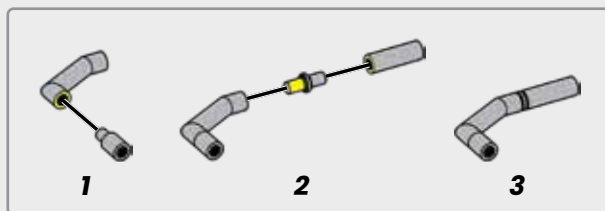
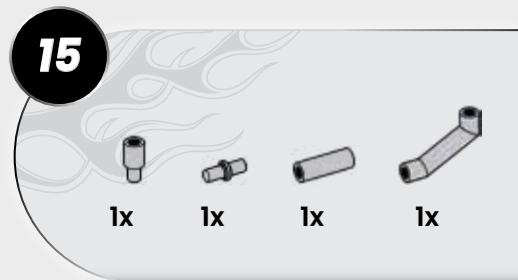

16



1x

1x

17



1x

1x

1x

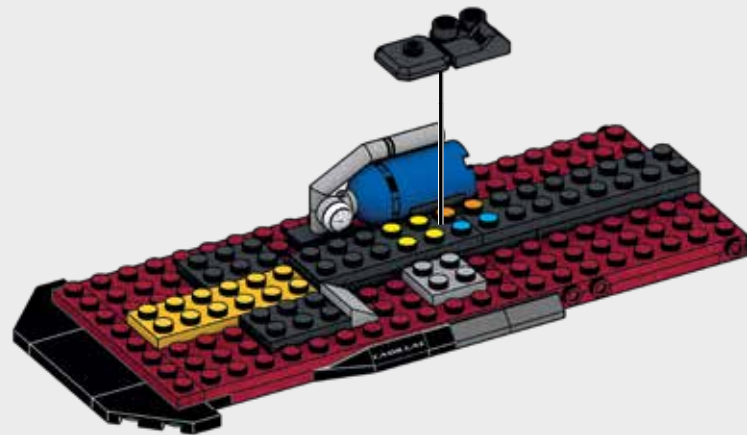
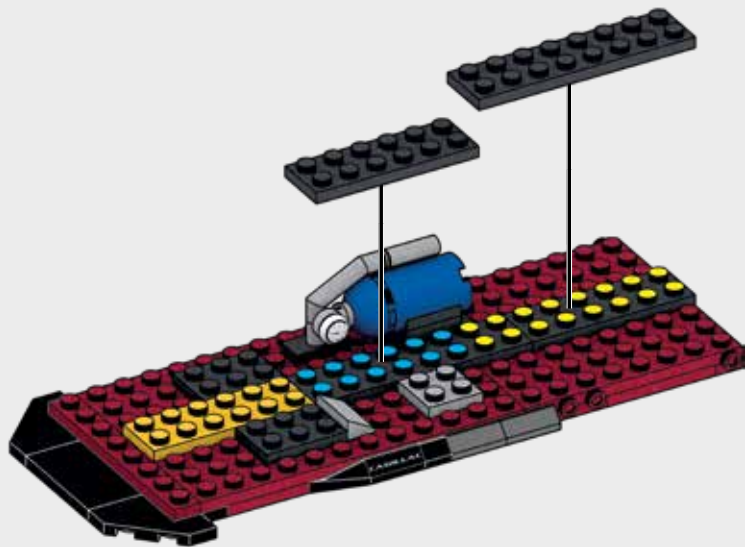

18



1x



1x

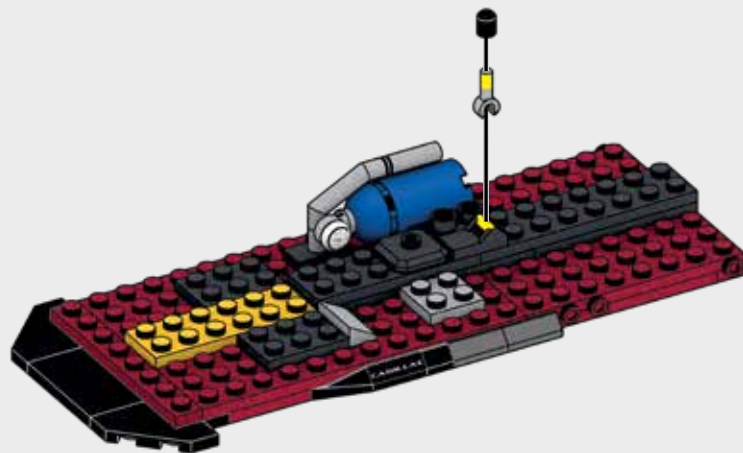

1

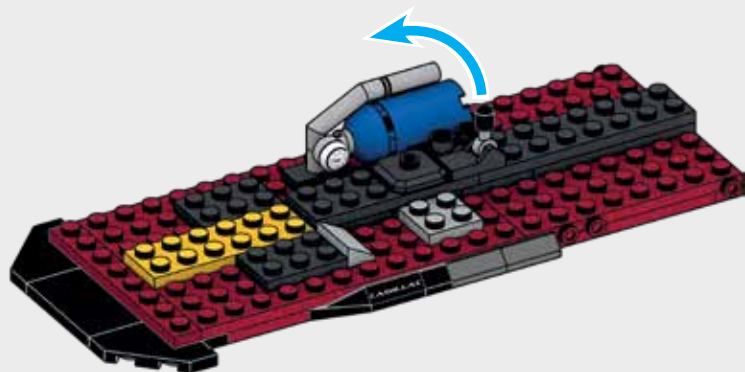

2



3

19



1x

1x

1x

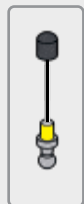

20



2x

1x



1

2

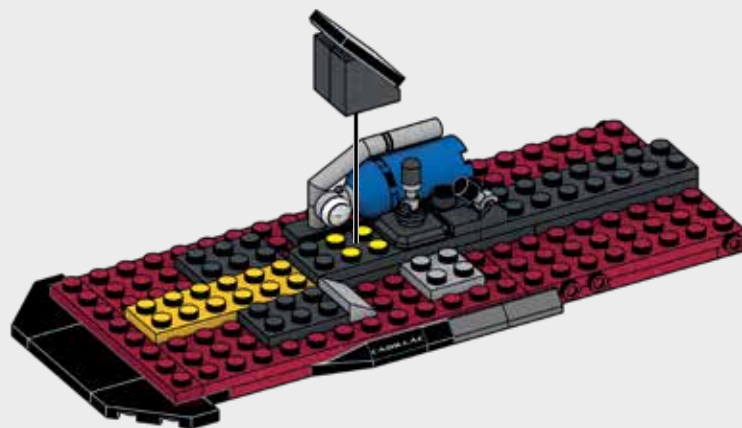
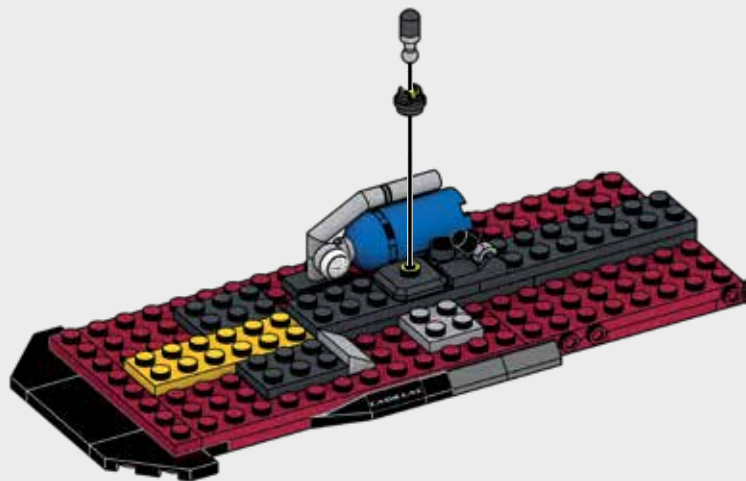

21



1x

1x

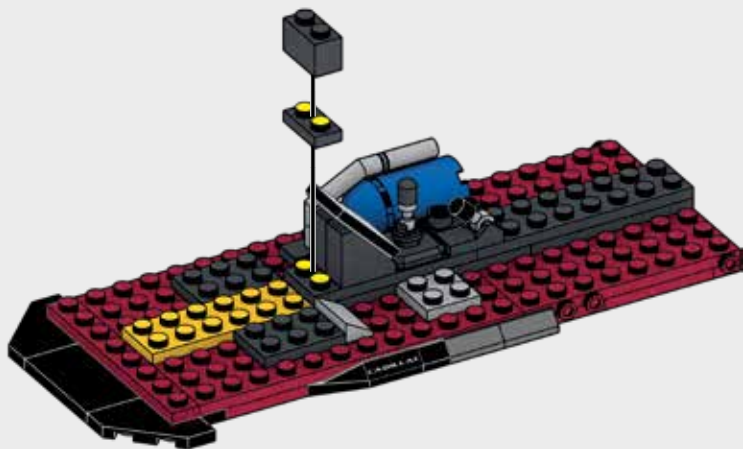

22



1x

2x

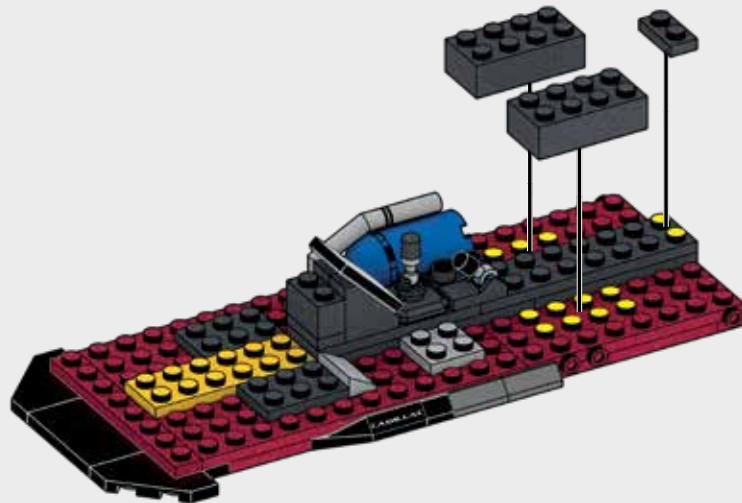

23



2x

2x

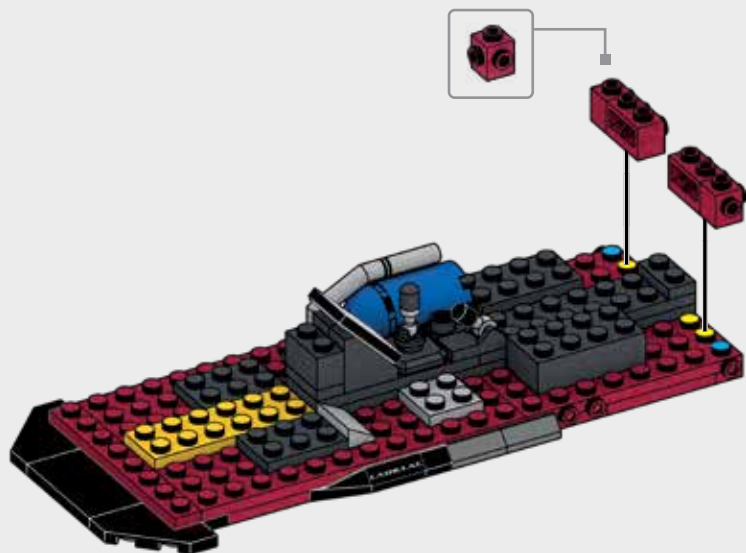

24



2x

2x



25



2x

2x

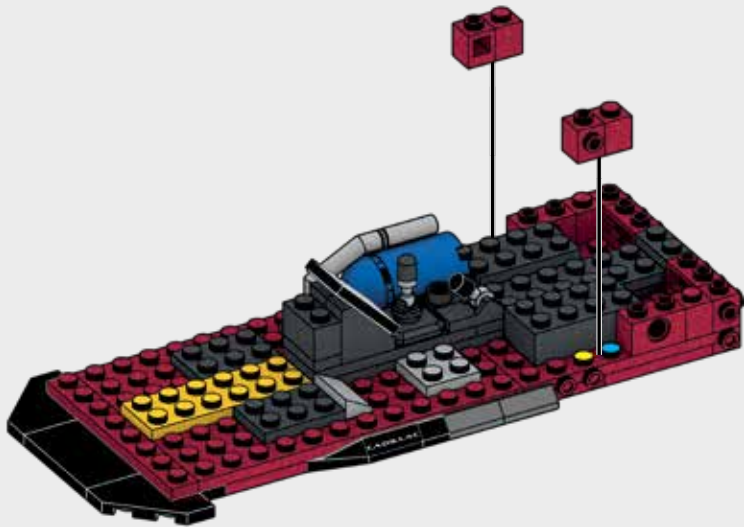

26



2x

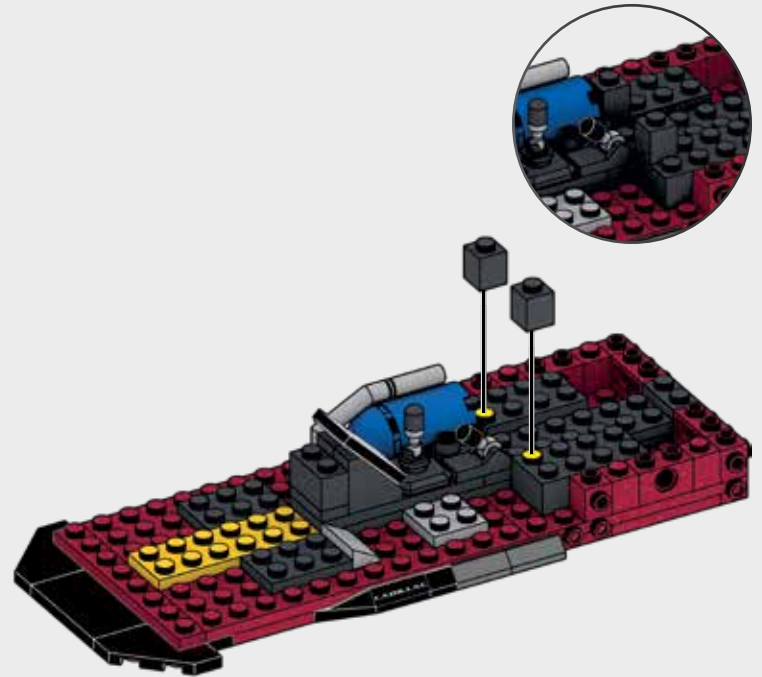

27

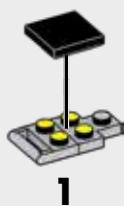
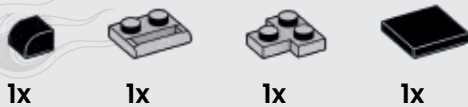

28

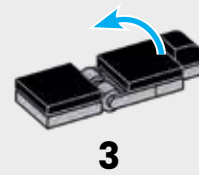
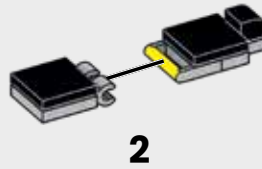

29



30



1x



1x

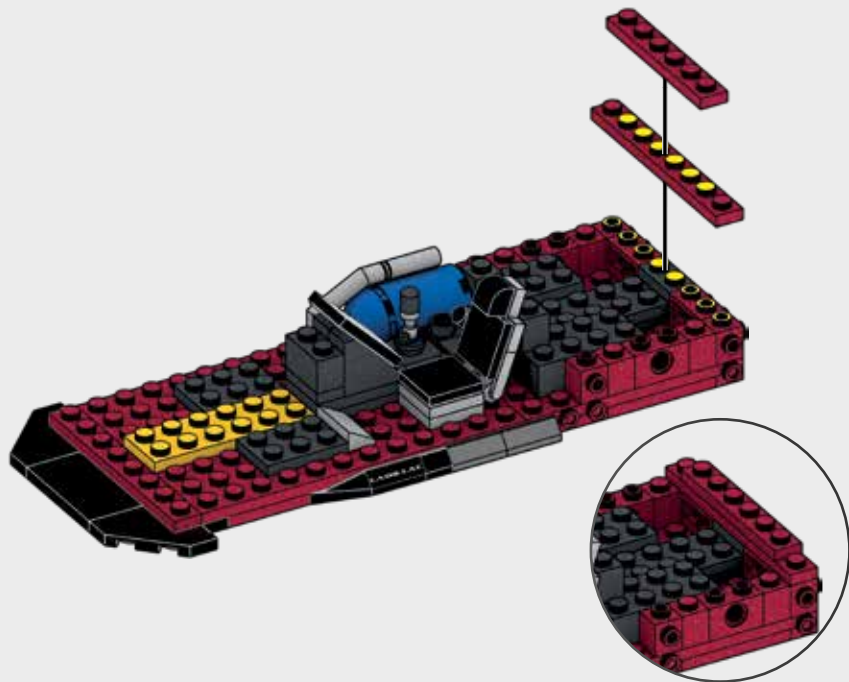

31



2x



1x



1x

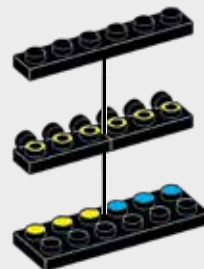

32



3x



33



2x



1x



34



2x

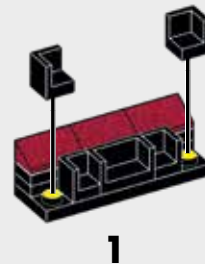

1

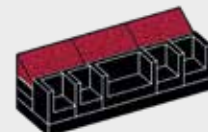

2

35

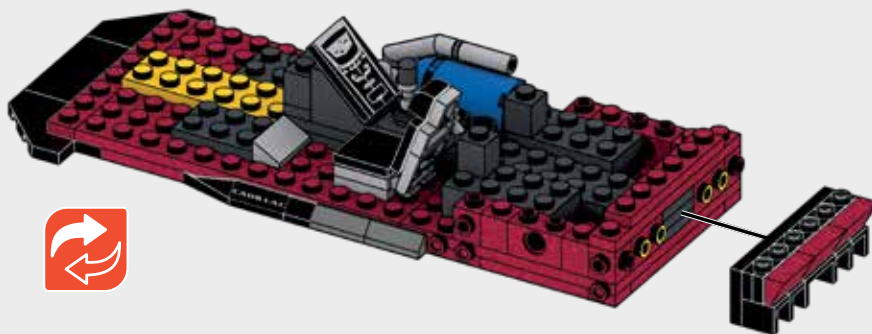

36



2x

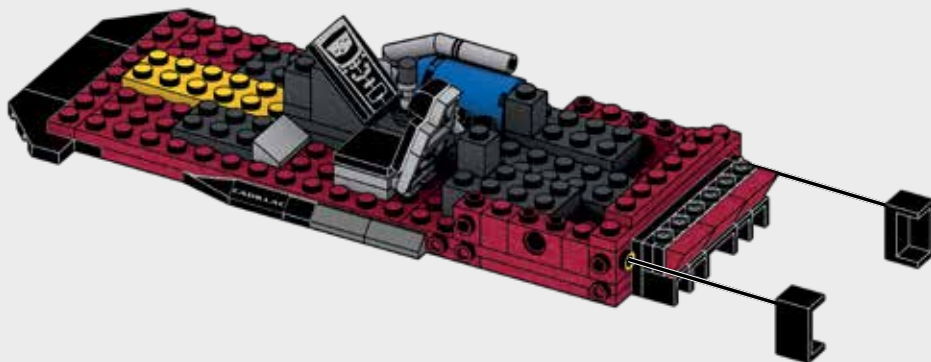

37



2x



1x



1x

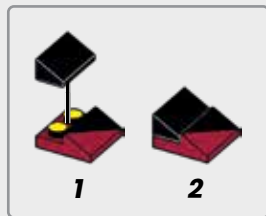

2

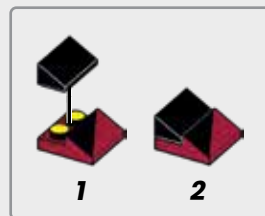

38



3x

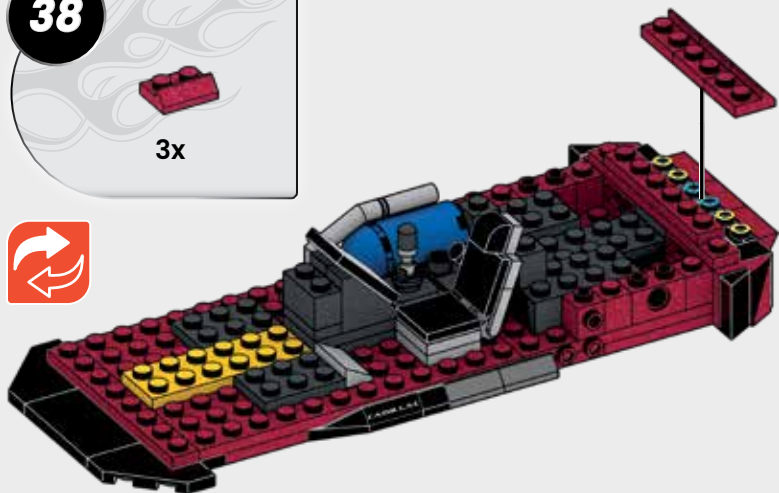

39



1x

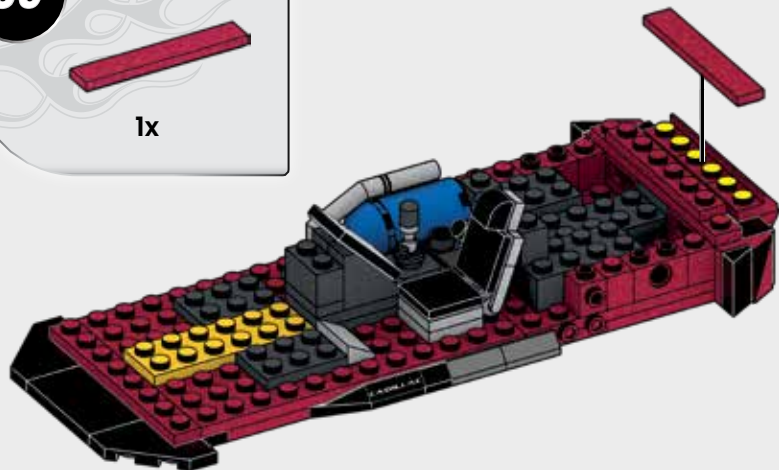

40



2x



2x



x2

41



1x

2x



42



2x

2x



43



2x

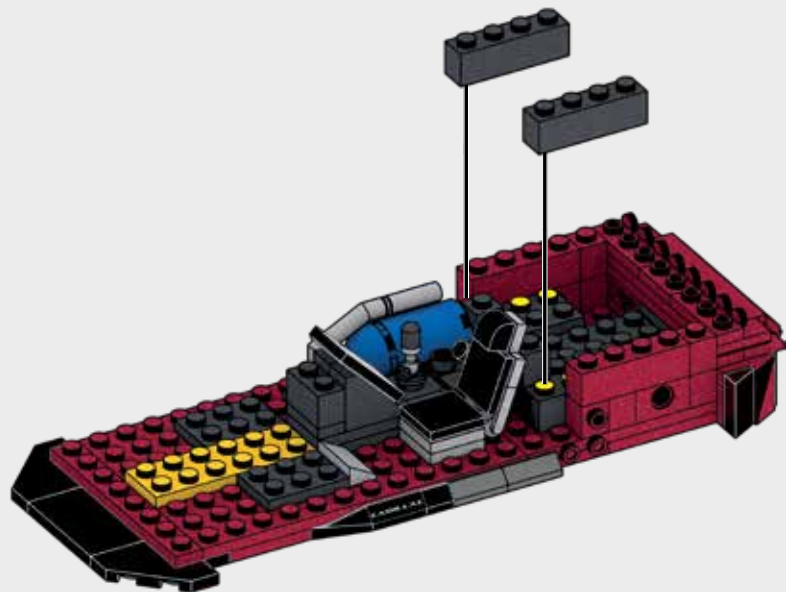

44



1x



2x

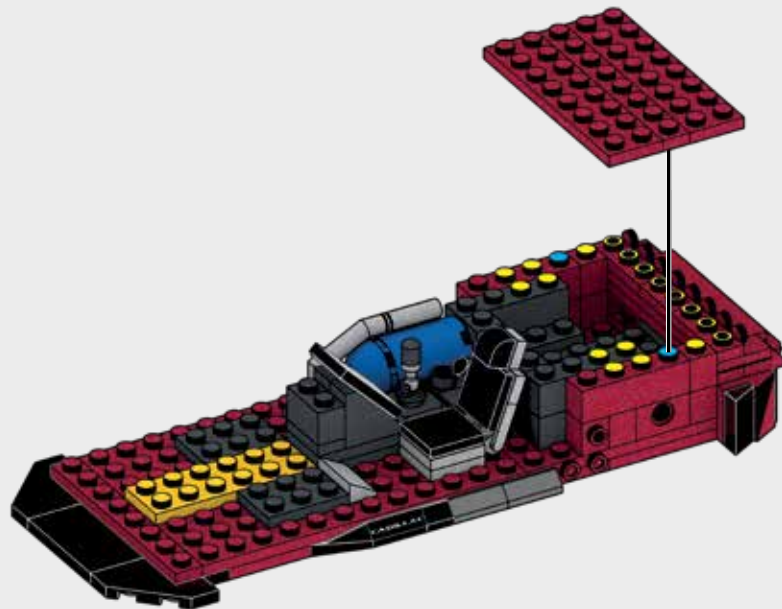

45



1x



1x

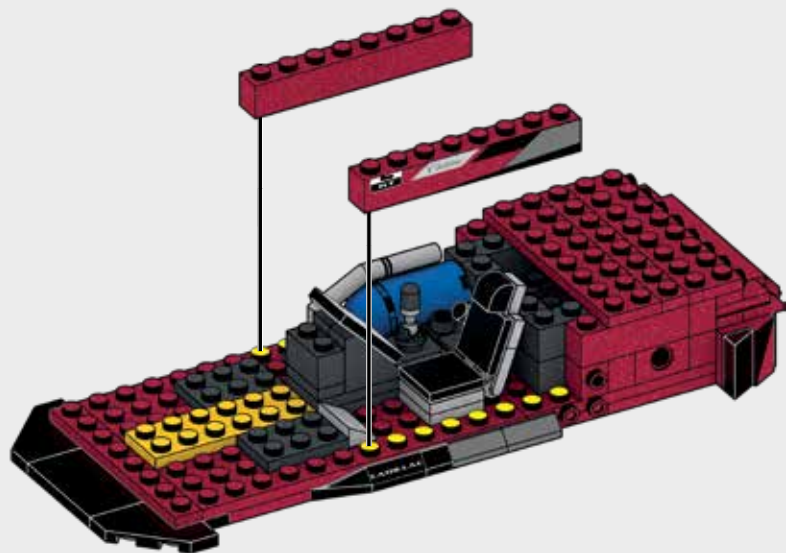

46



1x



1x

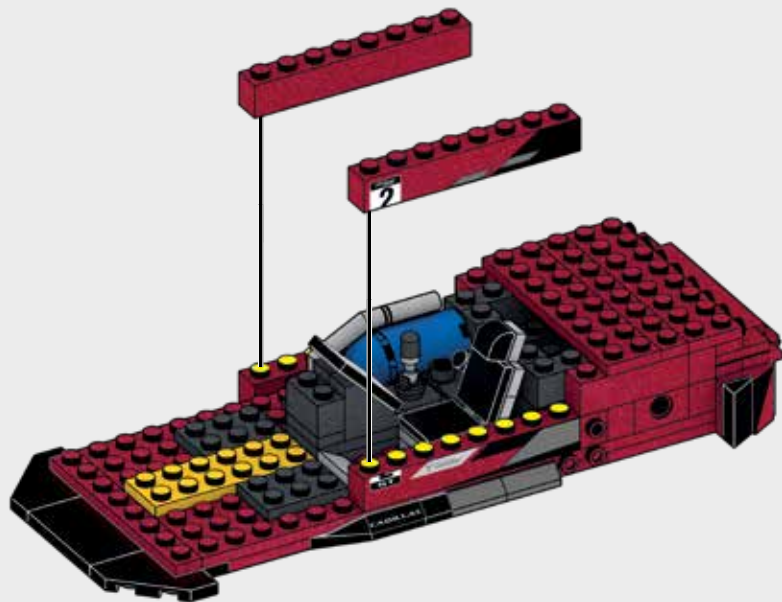

47



2x

2x

2x

48



1x

x2



1



2



3



49



1x



1x



1x



1x



1x



1



2



3



4

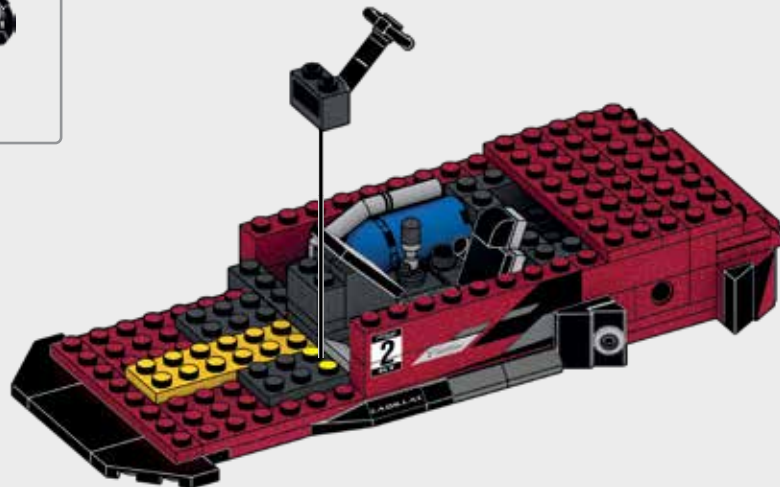

50



2x

51



1x

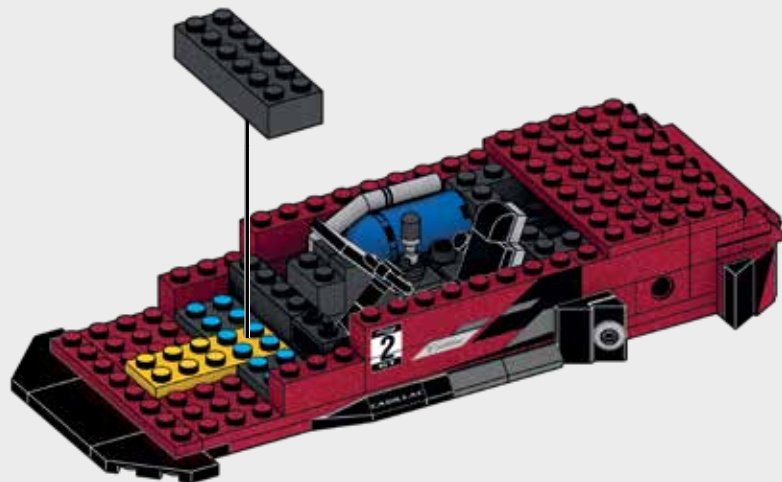
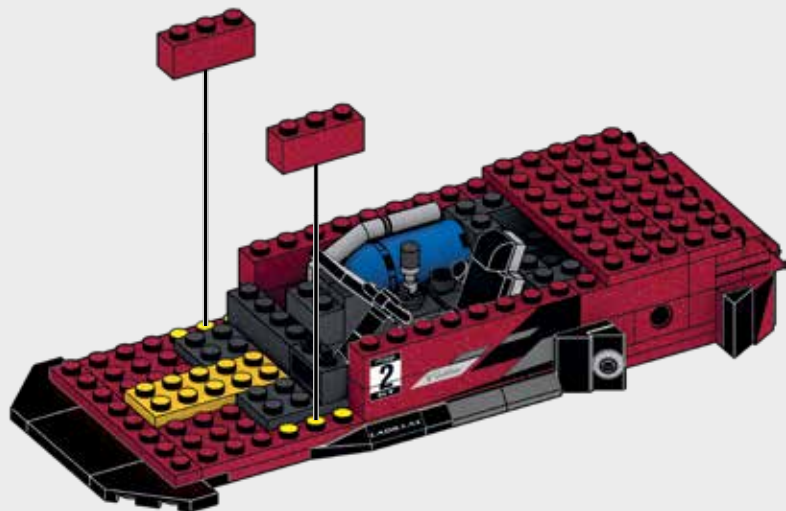

52



2x

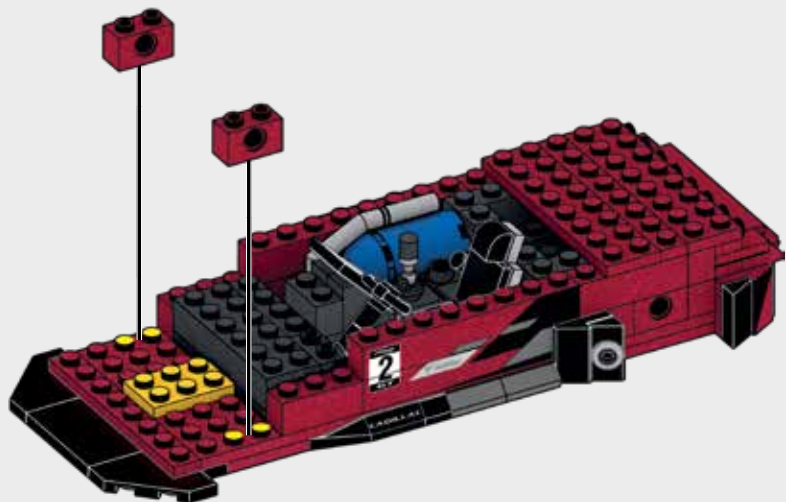

53



1x



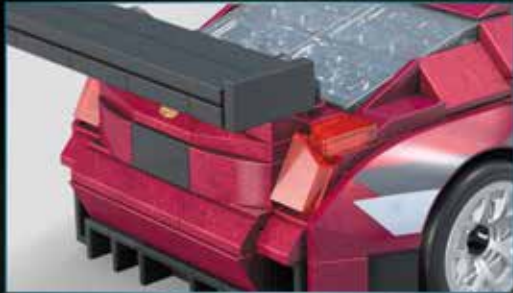



CADILLAC ATS-V R

54



2x

2x

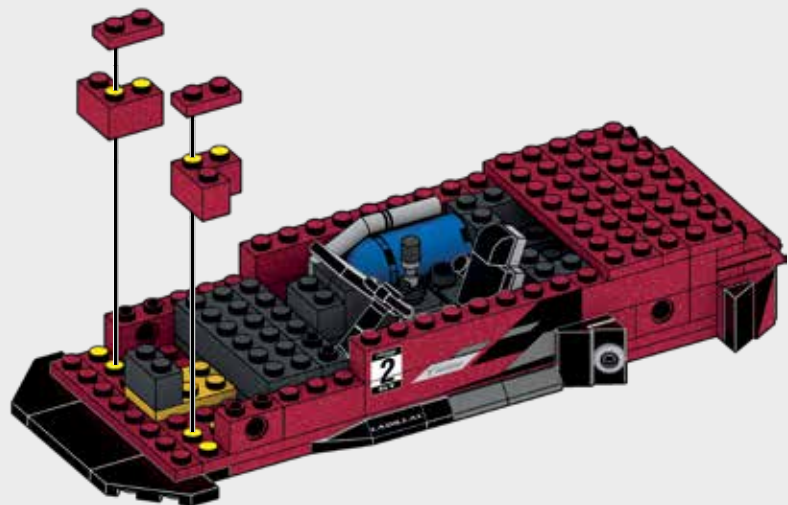

55



1x

2x

1x

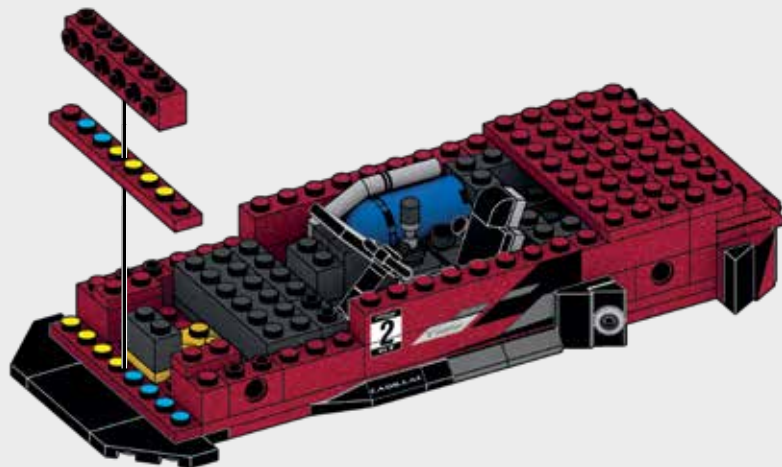

56



2x



57



1x



1x



58



1x



2x

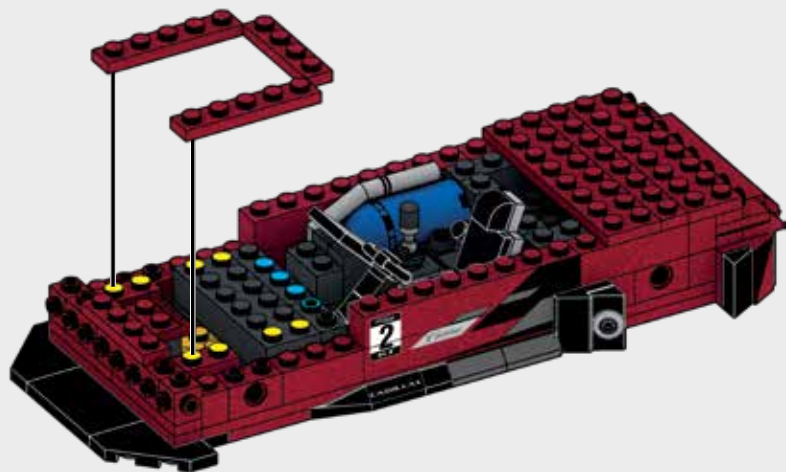

59



1x



60



2x

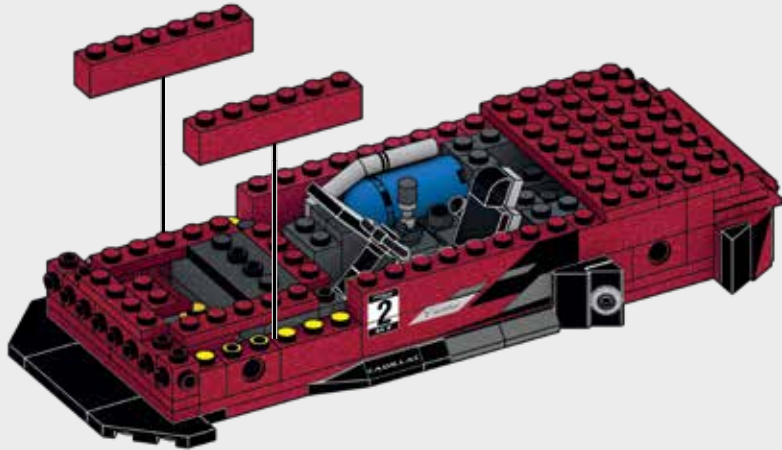

61



1x



2x



1x



62



2x

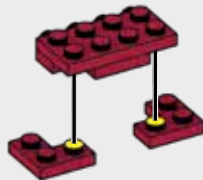

63



1x



1x



1x



1



2

64



65



1x



1x



66



1x

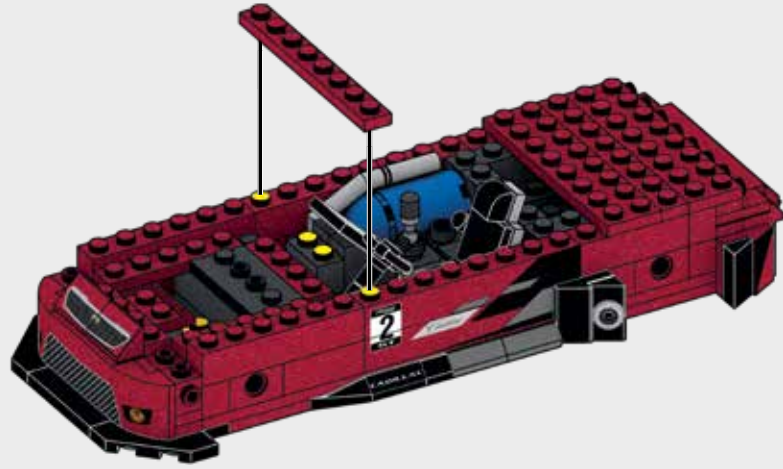

67



1x

1x

2x

2x

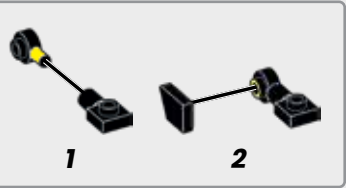

1



2

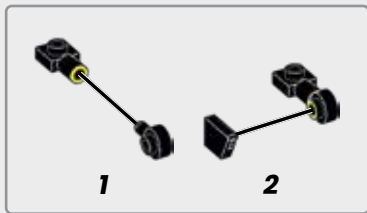

1



2

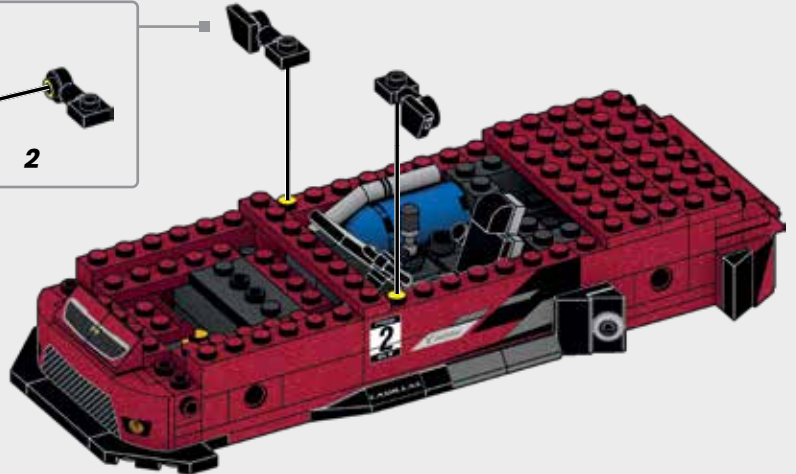

68



2x



2x

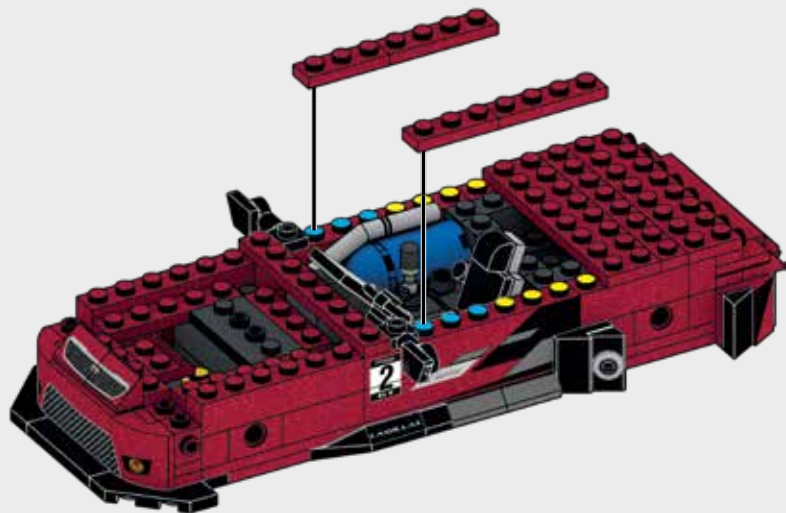

69



1x



1x



2x



70



2x



1x



2x



1



2

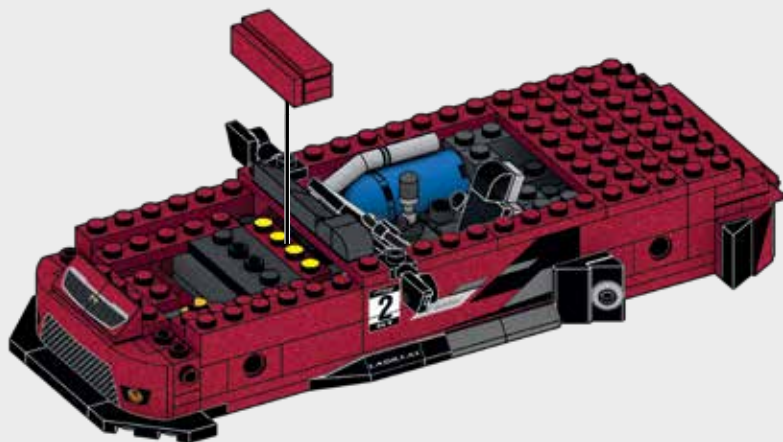
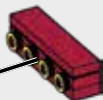

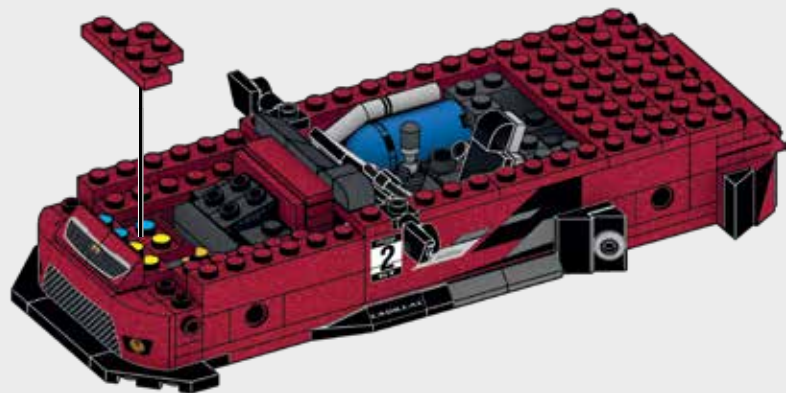
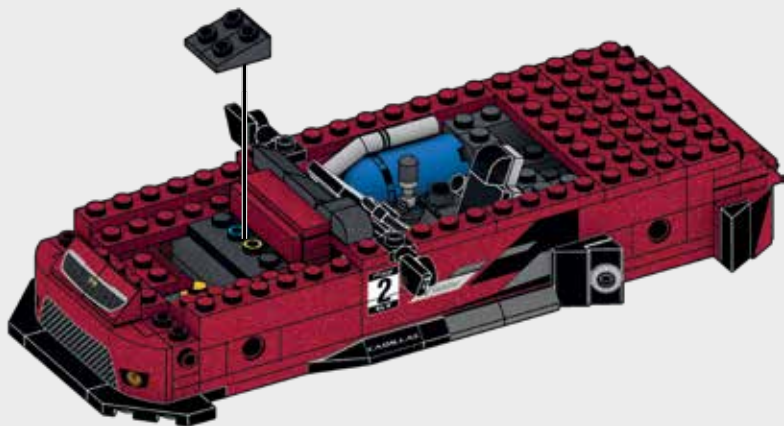
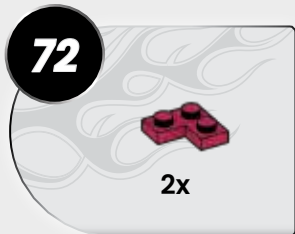
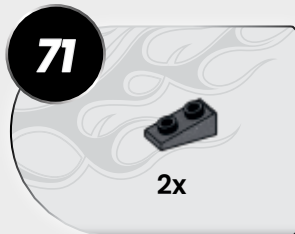

73



2x

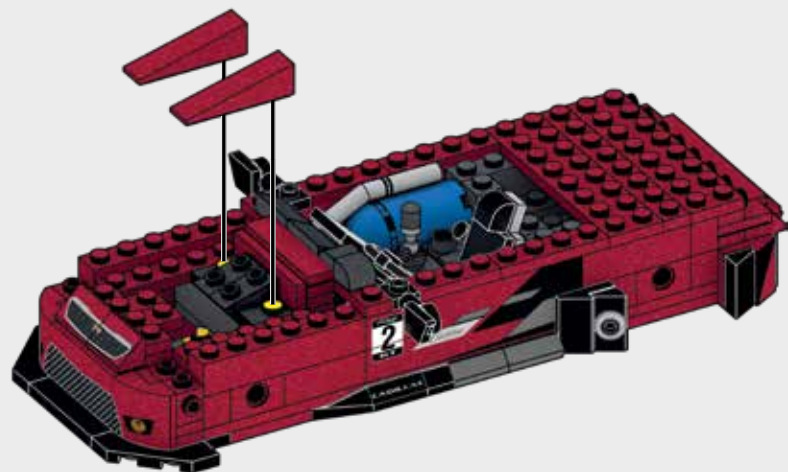

74



2x



2x

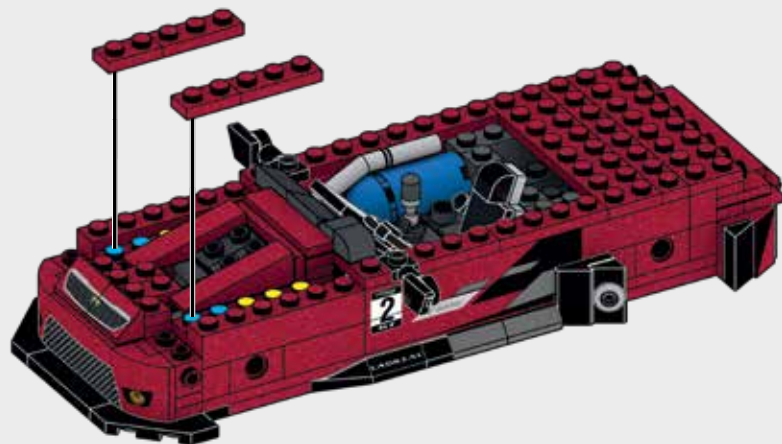

75

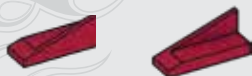

1x

1x

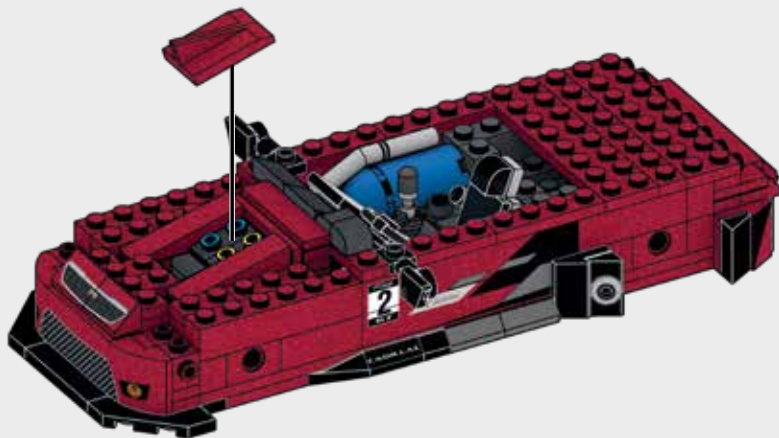

76



2x

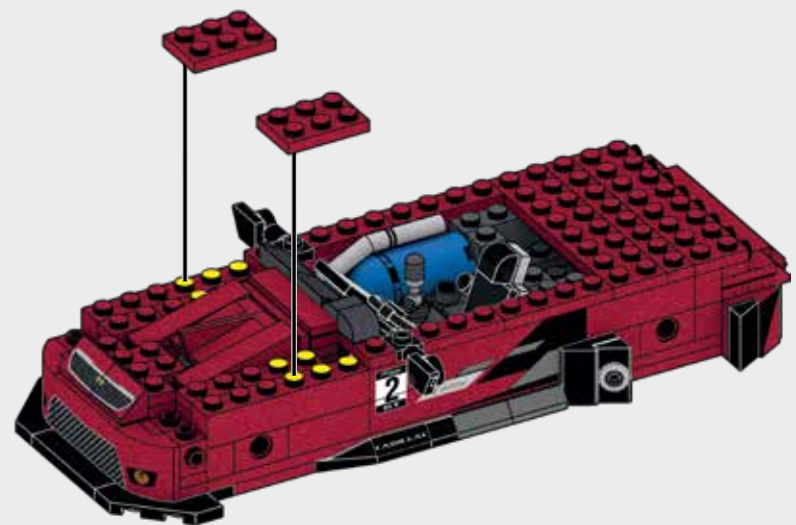

77



1x



1x

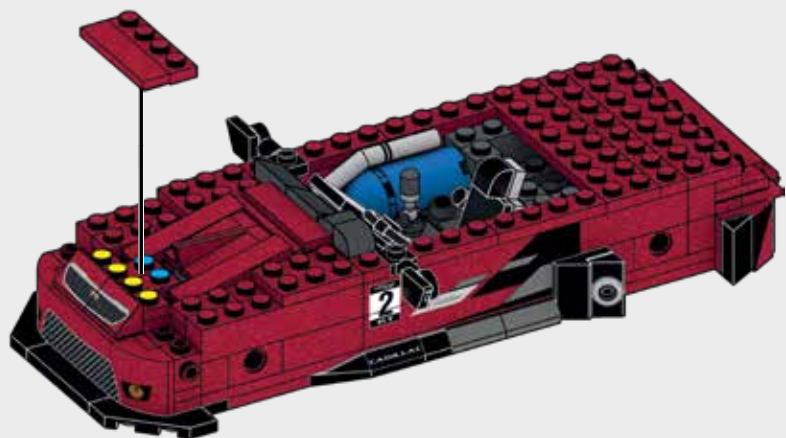

78



1x



1x

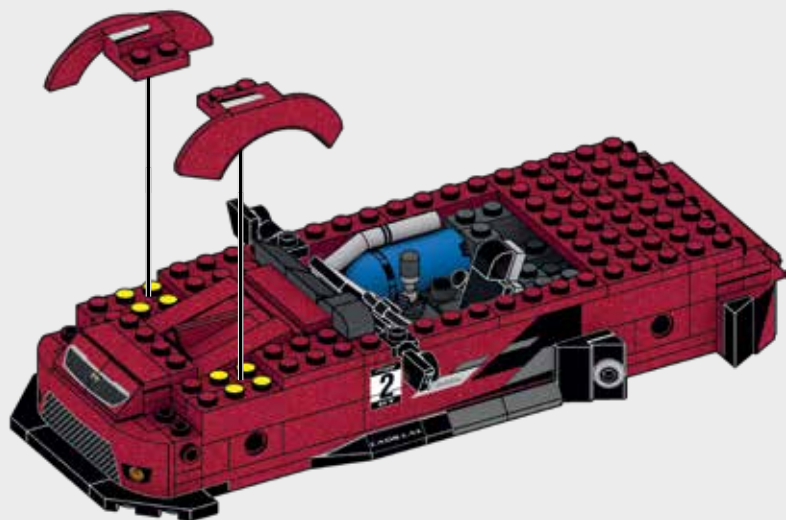

79



1x

1x

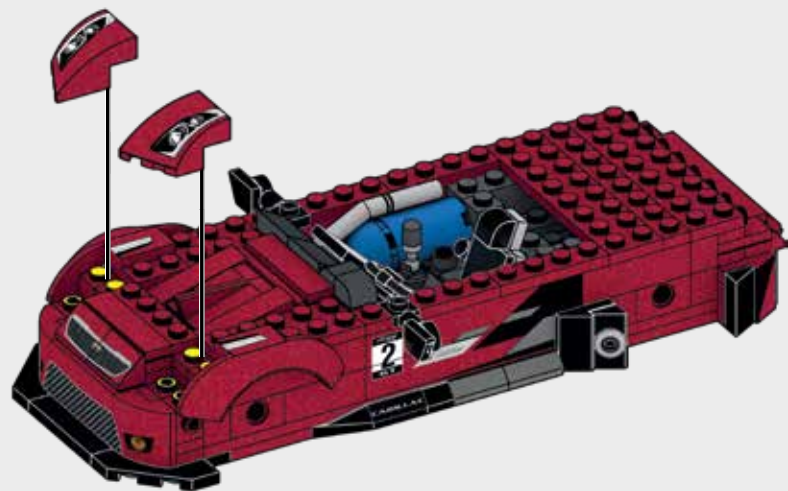

80



2x

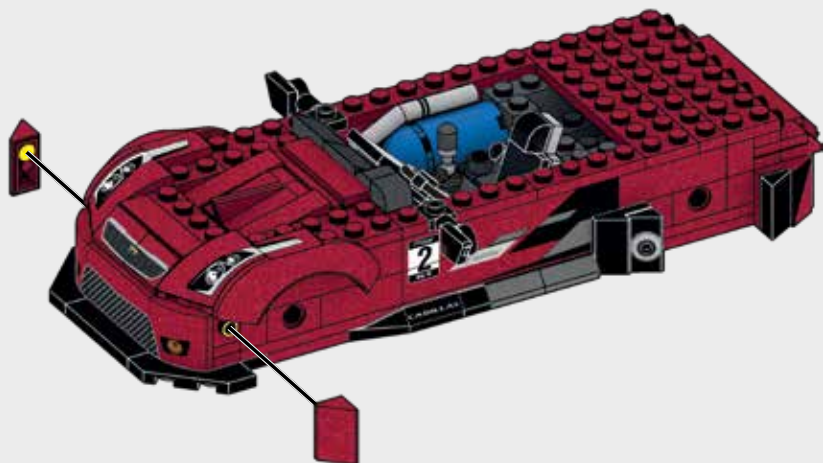

81



2x

2x

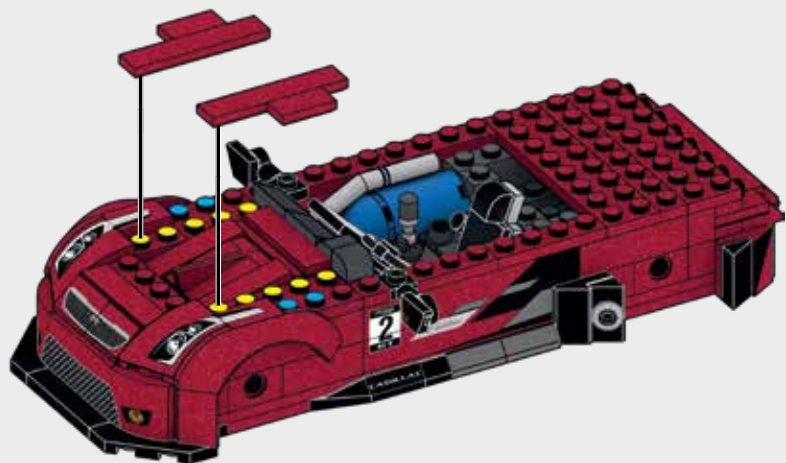

82



1x

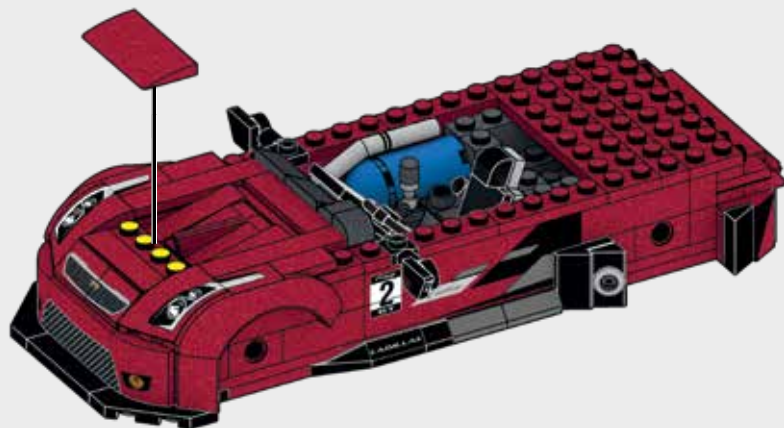

83



2x

1x

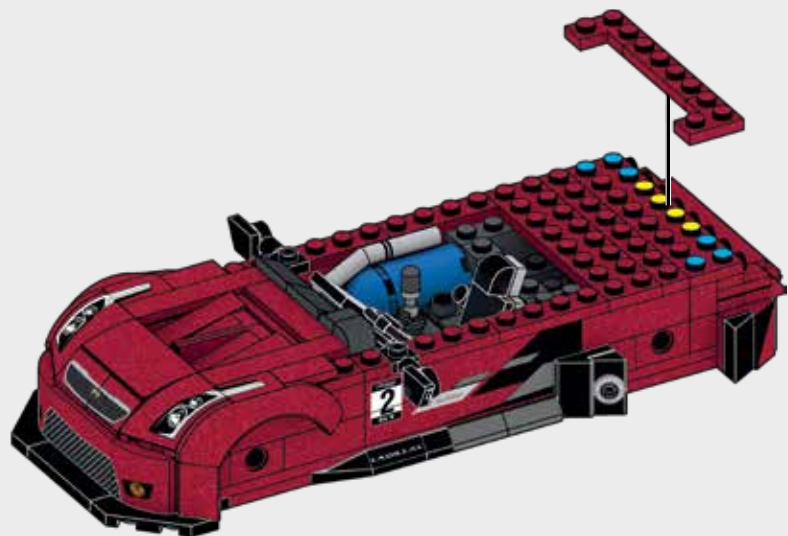

84



1x

1x

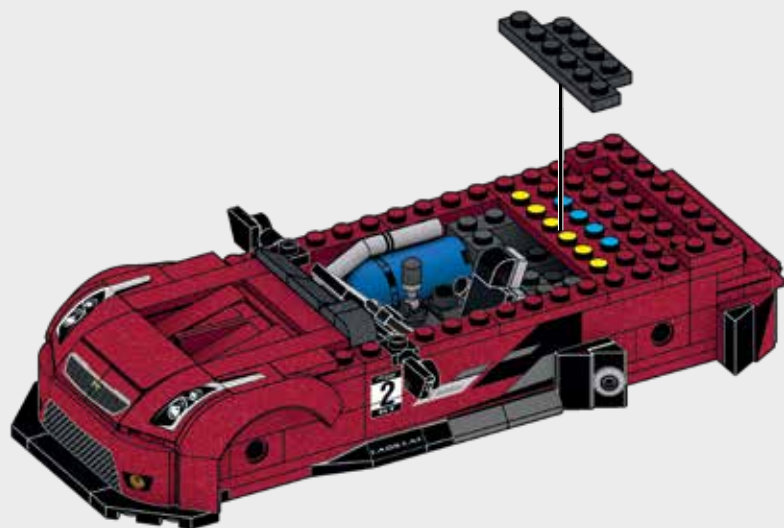

85



2x

1x

1x

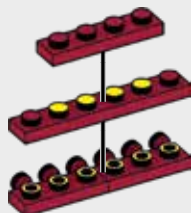

87



1x

1x

1x



1



2



88

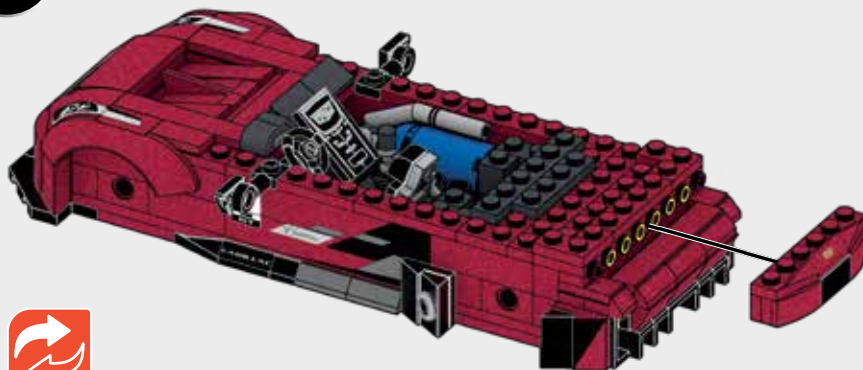

86



1x

2x



1



2

89

4x



90

1x

1x

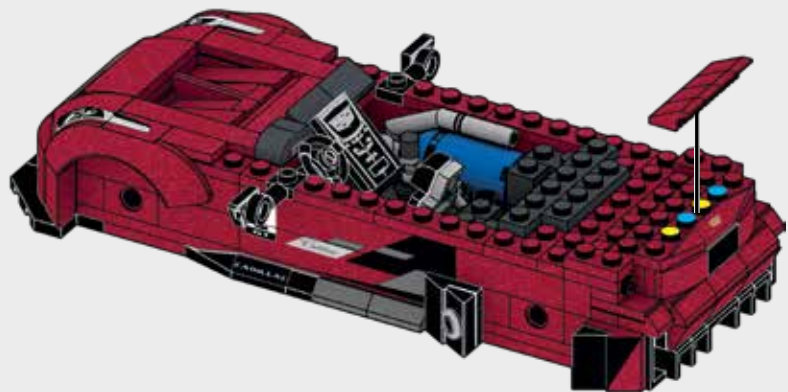

91



1x



1x



2x

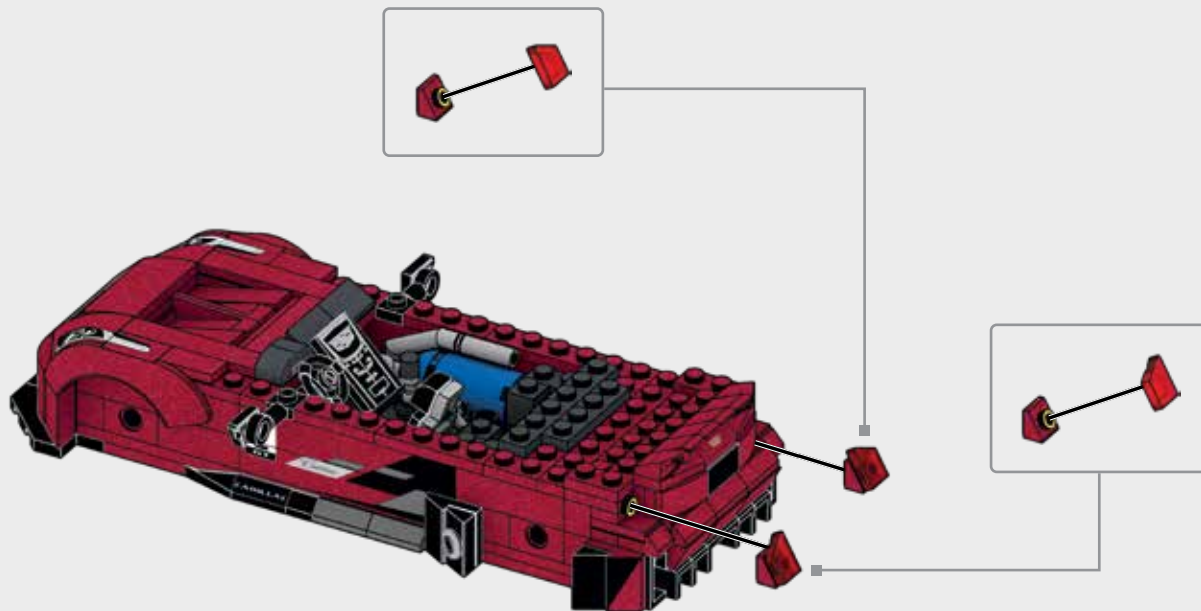

92



1x



2x

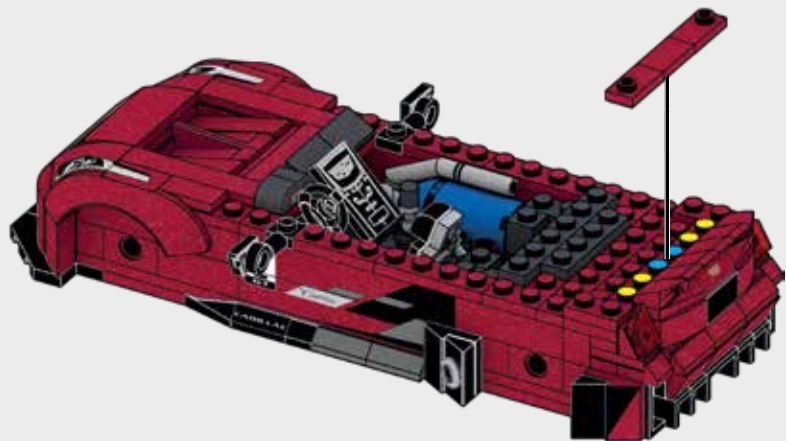

93



1x



1x

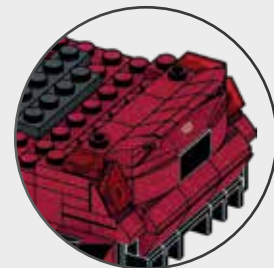

94



1x



1x

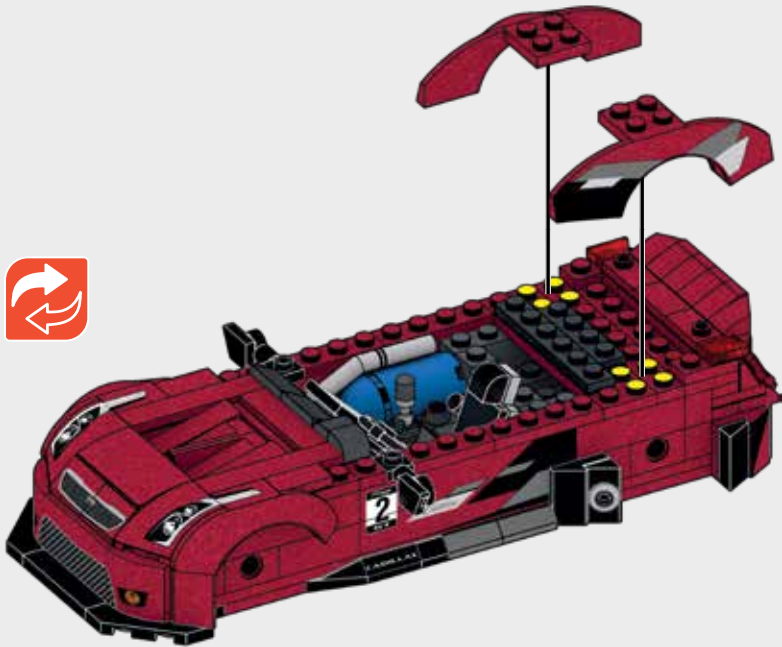

95



2x



2x

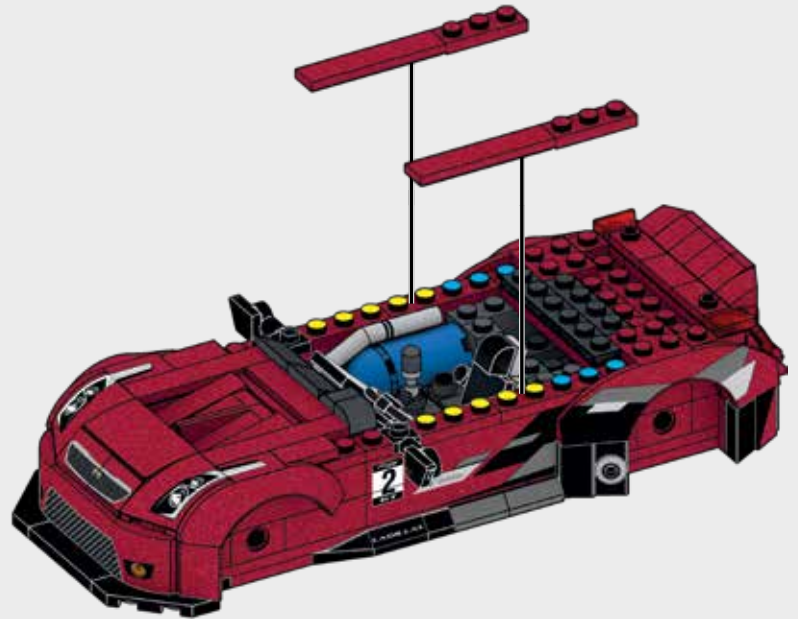

96



2x



2x

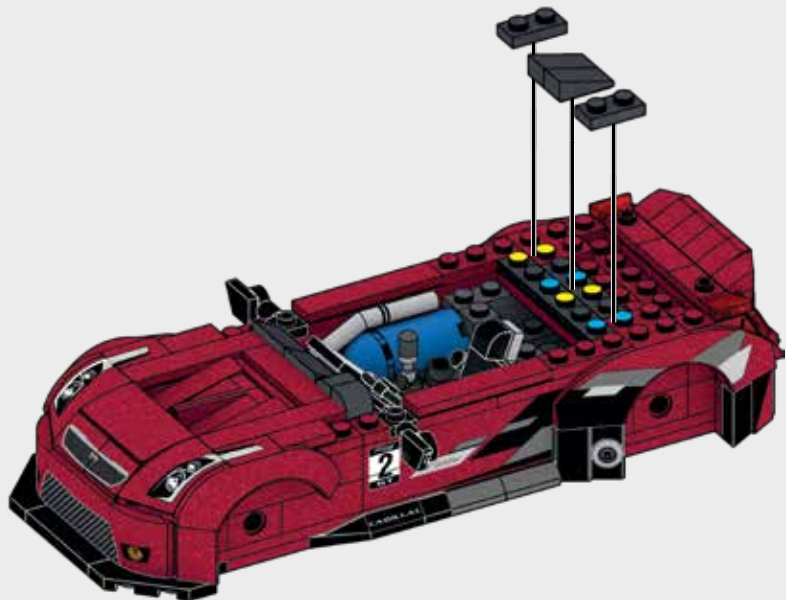

97



2x



1x



1x

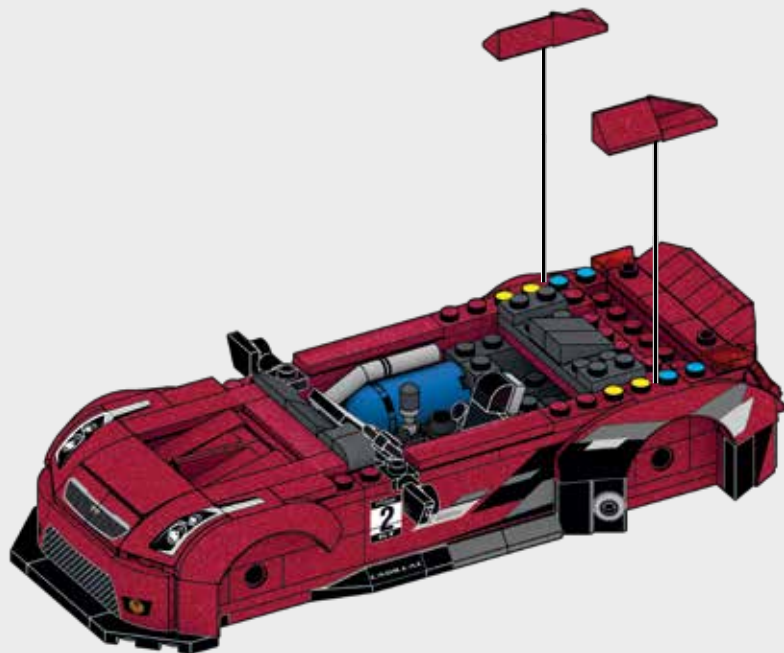

98



2x

2x

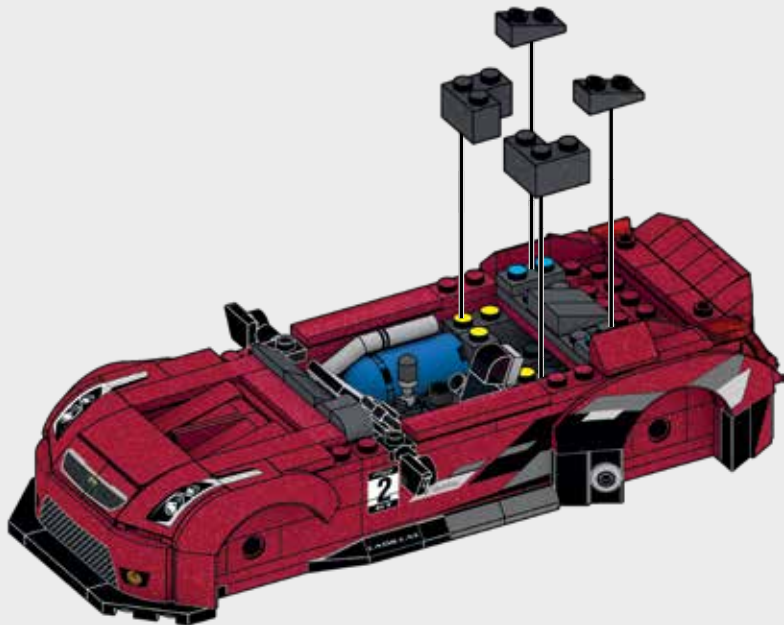

99



2x

2x

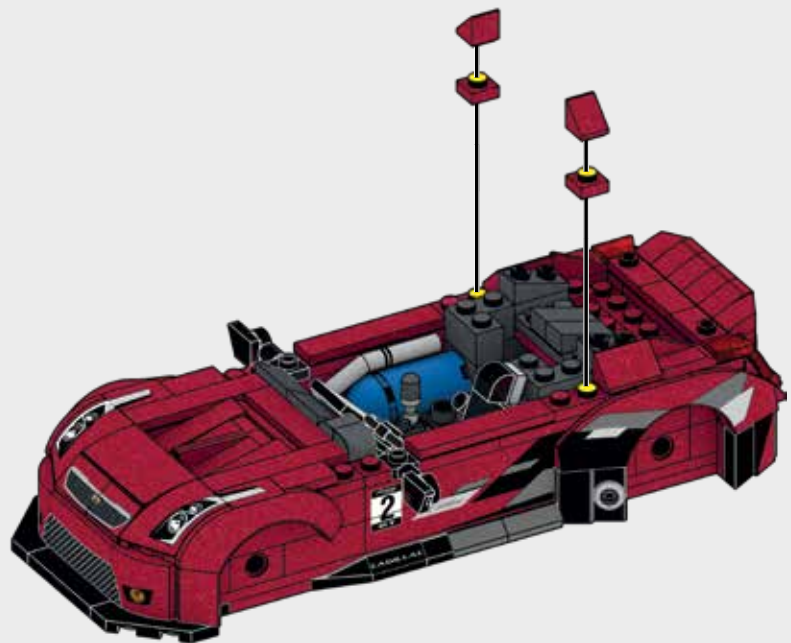

100



1x

1x



101



2x



102



2x



2x



1x



1



2

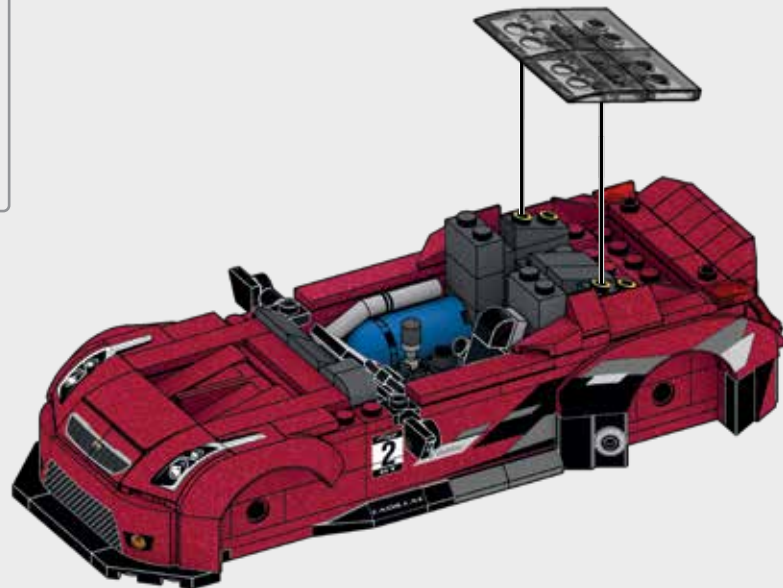

103



1x



1x



104



4x



1x



1x

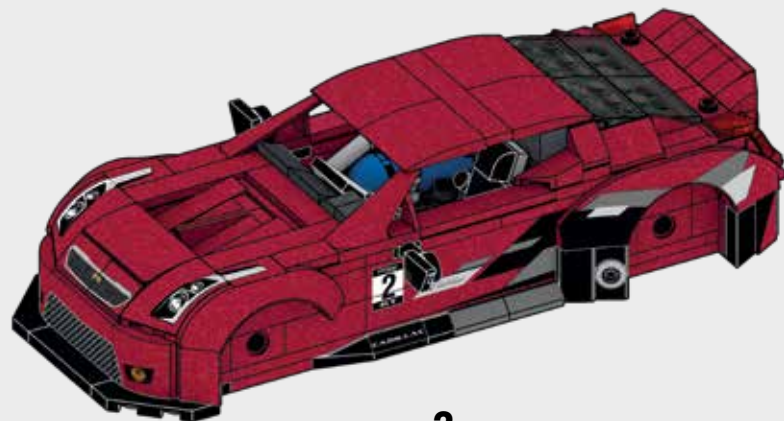
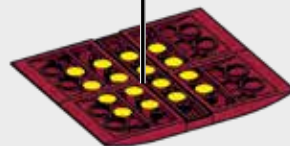
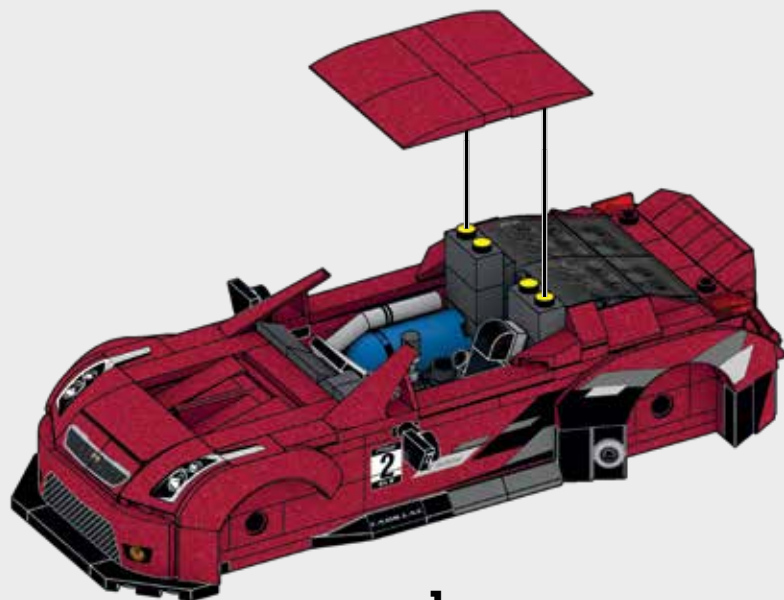

105



2x



1x



2x



106



2x



2x

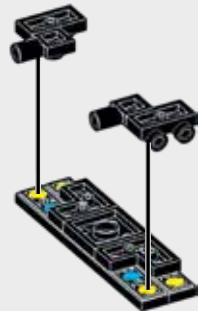

107



2x

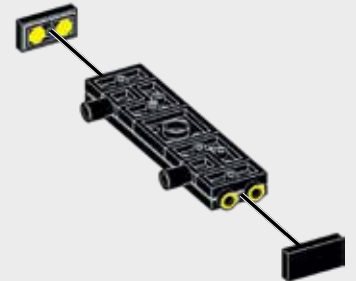

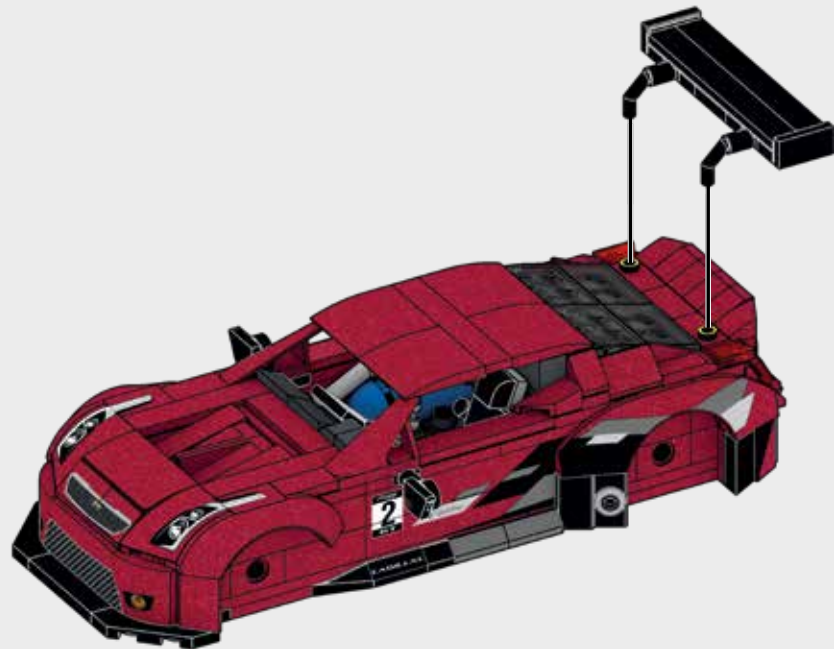
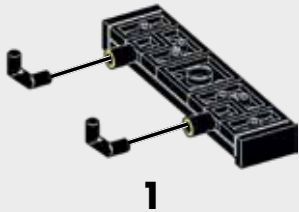

110



4x

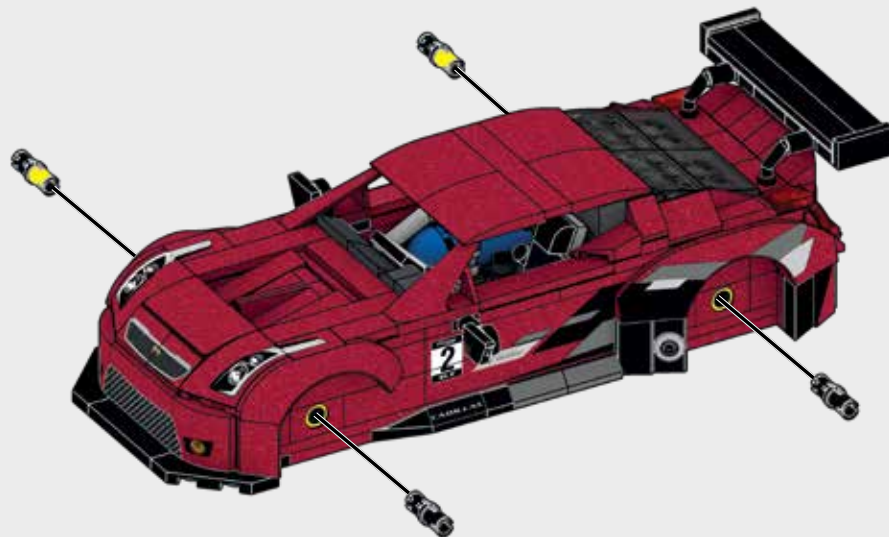

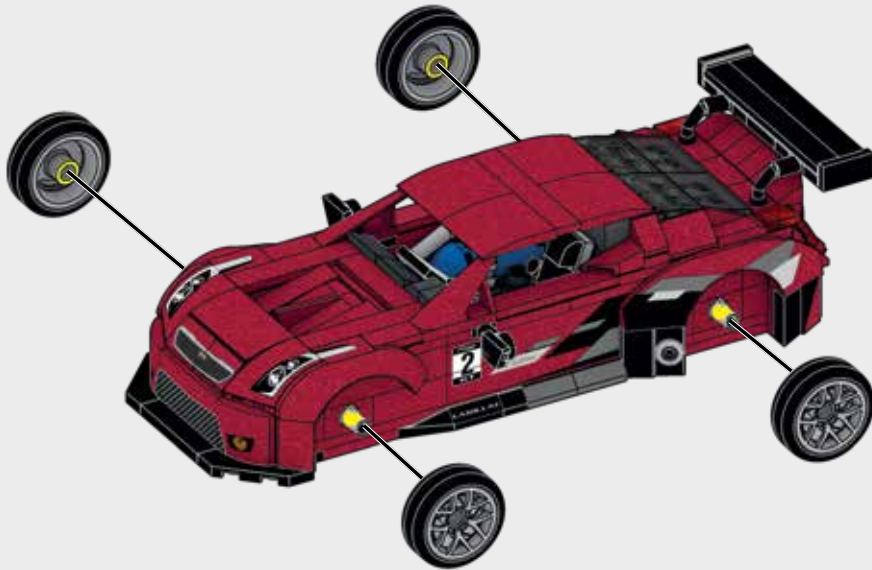

1



2



1x
AM77583F

1x
AM77583MM

2x
AM77341APG

1x
AS-HHL99-30

1x
AM15026MM

1x
AM74397APG

1x
AM74397F

1x
AM81964F

1x
AM74648F

1x
AM17003APG

1x
AM19319APG

1x
AM19617APG

2x
AM76052F

4x
AM72534F

1x
AM17506APG

2x
AM01312F

1x
AM78395APG

4x
AM76058F

2x
AM03328AKM

2x
AM79590AKM

2x
AM74299X

1x
AM74299F

2x
AM74300X

1x
AM74300F

2x
AM72001AKM

2x
AM15258AKM

1x
AM17787F

1x
AS-HRY18-21

1x
AS-HRY18-22

1x
AM81545AKM

1x
AM81546AKM

4x
AM17018AKM

2x
AM19530F

2x
AM19530AKM

4x
AM76959F

6x
AM01086AKM

2x
AM01086MM

2x
AM07629AKM

4x
AM18286AKM

1x
AM16649MM

1x
AM81383F

3x
AM22501F

3x
AM22501AKM

4x
AM73758AKM

5x
AM09393AKM

4x
AM09393MM

2x
AM79070F

7x
AM79070AKM

1x
AM15480AKM

1x
AM15480F

1x
AM15481AKM

1x
AM15481F

1x
AM17130AKM

1x
AM17129AKM

4x
AM80573MM

2x
AM17128MM

1x
AM17070MM

1x
AM18901MM

2x
AM73989F

2x
AM18549F

3x
AM18549AKM

2x
AM18549MM

1x
AM18549APG

4x
AM03019AKM

1x
AS-HRY18-02

1x
AS-HRY18-03

4x
AM098358DG

4x
AM09835AKM

2x
AS-HRY18-11

1x
AS-HRY18-18

1x
AM18601MM

4x
AM79877AKM

4x
AM09013MM

3x
AM17502AKM

1x
AM72000APG

3x
AM81095F

1x
AM81256AKM

1x
AM81255AKM

2x
AM78486AKM

6x
AM15484AKM

2x
AM15484F

1x
AM18293APG

1x
AM73009MM

2x
AM00948F

2x
AM03773MM

1x
AM03773APG

1x
AM03773F

2x
AM78189F

1x
AS-HRY18-19

1x
AS-HRY18-20

1x
AM18328APG

2x
AM17153AKM

2x
AM17153MM









- 2x  AM74298MM
- 8x  AM01314AKM
- 2x  AM81259F
- 4x  AM81259AKM
- 1x  AM81519AKM
- 1x  AM81518AKM
- 2x  AM16384AKM
- 1x  AS-HRY18-04
- 1x  AS-HRY18-06
- 2x  AM04218MM

- 1x  AM04245B
- 1x  AS-HRY18-10
- 1x  AS-HRY18-08
- 2x  AM81639AGY
- 1x  AS-HRY18-23
- 2x  AM03772AKM
- 2x  AM03772MM
- 1x  AM82048AKM
- 4x  AM80980AKM
- 2x  AM80980AGY

- 1x  AM74657APG
- 1x  AM17601B
- 1x  AM81516AKM
- 1x  AM81517AKM
- 3x  AM09838AKM
- 12x  AM09593AKM
- 1x  AM09593MM
- 2x  AM16959AKM
- 4x  AS-HRY18-01

- 2x  AM01087AKM
- 3x  AM01087MM
- 1x  AM17503AKM
- 1x  AM01531MM
- 1x  AM09493AGY
- 1x  AM09493AKM
- 1x  AS-HRY18-09
- 2x  AM09033MM
- 1x  AM82020F
- 1x  AM82019F

- 4x  AM17793AKM
- 2x  AM07475AKM
- 2x  AM16331AKM
- 1x  AM09292MM
- 3x  AM09292AKM
- 1x  AM09292F
- 2x  AM01313AKM
- 1x  AM18617F
- 1x  AM17054MM

- 1x  AM01480BYE
- 1x  AM01480F
- 2x  AM01480MM
- 1x  AM04983MM
- 1x  AS-HRY18-12
- 1x  AS-HRY18-13
- 1x  AS-HRY18-14
- 1x  AS-HRY18-15
- 2x  AM09922F



1x
AS-HRY18-05



1x
AS-HRY18-07



1x
AS-HRY18-16



1x
AS-HRY18-17



4x
AM18298AKM



2x
AM08483MM

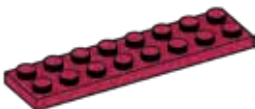

2x
AM08483AKM



1x
AM74681AKM

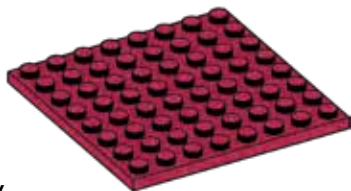

1x
AM18556AKM

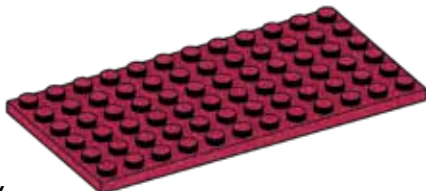

1x
AM78540AKM

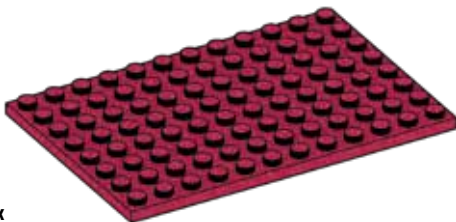

1x
AM73755AKM

Missing pieces? Pièces manquantes?

¿Partes faltantes? • Perdeu peças?
Fehlen Teile? • Не хватает деталей?



support.megabrands.com



1x
HCW49-7BK1

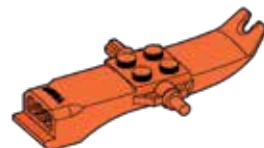

1x
AM80855MCK



1



2

Mattel Europa B.V., Gondel 1, 1186 MJ Amstelveen, Nederland. Mattel U.K. Limited, The Porter Building, 1Brunel Way, Slough SL1 1FQ, UK. Mattel France, Parc de la Cerisaie, 1/3/5 allée des Fleurs, 94260 Fresnes Cedex. N° Cristal 0969 36 99 99 (Numéro non surtaxé) ou www.lesjouetsmattel.fr Mattel Belgium N.V. De Kleetlaan 4, 1831 Machelen (Diegem) Belgium. Deutschland : Mattel GmbH, Solmsstraße 83, D-60486 Frankfurt am Main. Schweiz: Mattel AG, Kirchstrasse 24, CH-3097 Liebefeld. Österreich: Mattel Ges.m.b.H., Campus 21, Liebermannstraße A01 404, A- 2345 Brunn/Gebirge. Mattel Italy Srl, Via Turati 4, 20121 Milano, Italy. Servizio assistenza clienti: Customersrv. italia@mattel.com - Numero verde 800 11 37 11. Mattel España, S. A, Aribau 200 pl. 9, 08036 Barcelona. cservice.spain@mattel.com Tel: +34 933 06 79 00 <http://www.service.mattel.com/es>. Hong Kong: Kids Kingdom Limited, Room 1908-9, Gala Place, 56 Dundas Street, Mongkok, Kowloon, Hong Kong. Customer Care line: (852)2782-0766. Taiwan: Chickabiddy Company Limited, 5/F, No. 186, Section 4, Nanjing East Road, Taipei 10595, Taiwan. Customer Care line: (02)2578-1188. Mainland China: Mattel Barbie (Shanghai) Trading Co., Ltd. Units 4701-4711, 47F, 2 Grand Gateway, 3 Hong Qiao Road, Shanghai, 200030, P.R.C. Customer Care line: 400-819-9658. Dimpört & Diedarkan Oleh: Mattel Continental Asia Sdn Bhd. Level 19, Tower 3, Avenue 7, No. 8 Jalan Kerinchi, Bangsar South, 59200 Kuala Lumpur, Malaysia. Mattel South Africa (PTY) LTD, Office 10213, 30 Melrose Boulevard, Johannesburg 2196. Dystrybutor: Mattel Poland Sp. z o.o. Budynek Skyliner 31 p., ul. Prosta 67, 00-838 Warszawa, Polska. Mattel Australia Pty Ltd., 658 Church St., Richmond, Victoria, 3121. Consumer Advisory Service - 1300 135 312. Mattel AEBE, Εβθώρου Μακροπίου 1, Κτήριο Κ-2, ΤΚ 17561, Παλαιό Φάληρο, Mattel Oyuncakçılık Tic. Ltd. Şti. Çerçenköy Mah., Umut Sokak No: 10 - 12, Quick Tower kat:2 içkapı no:15 Ataşehir 34752, İstanbul, Türkiye. Tel: 0216 570 75 00. Импортёр/Уполномоченная организация: ООО "МАТЕЛ" Российская Федерация, 105120 Москва, 2-й Сыромятинский переулок, 1; +7 495 287 79 39. Mattel Czech Republic s.r.o., The Forum, Václavské nám. 19, 11000 Praha 1. Mattel, 333 Continental Boulevard, El Segundo, CA 90245, USA. Consumer Services: 1-800-465-MEGA (6342). Mattel Canada Inc., Mississauga, Ontario L5R 3W2. Consumer Services: You may call us free at/ Composez sans frais le 1-800-524-8697. Importado y distribuido por Mattel de México, S.A. de C.V., Miguel de Cervantes Saavedra No. 193, Pisos 10 y 11, Col. Granada, Alcatlida Miguel Hidalgo, C.P. 11520, México, Ciudad de México. R.F.C. MME-920701-NB3. Tels.: 59-05-51-00 Ext. 5206 ó 01-800-463-59-89. Mattel Chile S.A., Pdtte. Riesco 5561, Of. 203-204 P52, Las Condes, Santiago. Servicio al consumidor Venezuela: Tel.: 0-800-100-9123. Mattel Argentina, S.A., Av. Libertador 1000, Piso 11 – Oficinas 109 y 111, Vicente López - Prov. Buenos Aires. Tel.: 0800-666-3373. Mattel Colombia, S.A., Calle 123#7-07 P5, Bogotá. Mattel Perú, S.A., Av. Juan de Arona # 151, Centro Empresarial Juan de Arona, Torre C, Piso 7, Oficina 704, San Isidro, Lima 27, Perú. RUC: 20425853865. Reg. Importador: 02350-12-JUE-DIGESA. Tel.: 0800-54744. E-mail Latinoamérica: servicio_clientes@mattel.com. Mattel do Brasil Ltda. - CNPJ: 54.558.002/0001-20 - Rua Verbo Divino, 1488 - 2º - Andar - 04719-904 - Chácara Santo Antônio - São Paulo - SP - Brasil. Serviço de Atendimento ao Consumidor: Contato: <https://faleconosco.mattel.com.br/> Contato. E-mail: sac.matteldobrazil@mattel.com.

BUILD YOUR COLLECTION CONSTRUISEZ VOTRE COLLECTION



CONSTRUYE TU COLECCIÓN. / CONSTRUA A SUA COLEÇÃO.
ERWEITERE DEINE SAMMLUNG. / ПОСТРОЙТЕ СВОЮ КОЛЛЕКЦИЮ.

Mattel Canada Inc. Mississauga, Ontario L5R 3W2

MEGA CONSTRUCTION TOY MADE IN CHINA - HOT WHEELS DIE-CAST CAR MADE IN MALAYSIA. JOUET DE CONSTRUCTION MEGA FABRIQUÉ EN CHINE - VOITURE HOT WHEELS EN MÉTAL FABRIQUÉE EN MALAISIE. MEGA BRINQUEDO DE CONSTRUÇÃO FABRICADO NA CHINA - CARRO METALIZADO HOT WHEELS FABRICADO NA MALÁSIA. JUGUETE DE CONSTRUCCIÓN DE MEGA FABRICADO EN CHINA - VEHÍCULO METÁLICO DE HOT WHEELS FABRICADO EN MALASIA. ИГРУШКА-КОНСТРУКТОР MEGA ИЗГОТОВЛЕНА В КИТАЕ - ЛИТАЯ МАШИНКА HOT WHEELS ИЗГОТОВЛЕНА В МАЛАЙЗИИ. MEGA YAPÍ BLOKLARI, ÇIN'DE ÜRETİLMİŞTİR. - METAL HOT WHEELS ARAÇ, MALEZYA'DA ÜRETİLMİŞTİR. صنعت لعبة البناء MEGA في الصين. - صنعت سيارة HOT WHEELS المصنوعة من المعدن في ماليزيا.



General Motors
Trademarks used under
license to Mattel, Inc.

P 0841,101

1186 MJ, 1, NL

MEGASHOWCASE.com



HOT WHEELS®, MATTEL and associated trademarks and trade dress are owned by, and used under license from Mattel. ©2023 Mattel.

©2023 MEGA Brands &™ MEGA Brands.
Printed in China / Imprimé en Chine
AD-HRY18-02B



Adresses sur quefairedemesdechets.fr

