



HHD17

HW V8 BOMBER™
MONSTER TRUCK

САМИОН ДЕ КАРРЕРАС/МАШИНКА МОНОСТР-ТРАК / SZÖRNYJÁRGÁNY / MONSTER شاحنة



Build Construisez

Construye | Constrói
Bauen | Стройте



Share Partagez

Comparte | Partilha
Teilen | Делитесь

Devices not included | Appareils non inclus
Dispositivos no incluído | Dispositivos não incluídos
Geräte nicht enthalten | Устройства не входят в комплект



Get creative! Soyez créatif!

¡Sé creativo! • seja criativo!
werde kreativ! • проявите
творческий подход!



Build ideas may use pieces from multiple sets (sold separately).
Les idées de construction peuvent nécessiter des pièces issues de
différents coffrets (vendus séparément).
Las ideas de construcción pueden utilizar piezas de varios conjuntos
(se venden por separado).
As ideias de construção podem utilizar peças de vários
conjuntos (vendidas em separado).
Für Bauiden sind möglicherweise Teile von mehreren
Sets nötig (separat erhältlich).
В идеях конструкций могут быть использованы детали
из разных наборов (продаются отдельно).

megaunboxed.com





1



1



2



HW VB BOMBER™
MONSTER TRUCK · CAMIÓN DE CARRERAS

2



2x

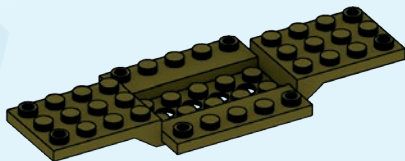

1x

3



2x



1x

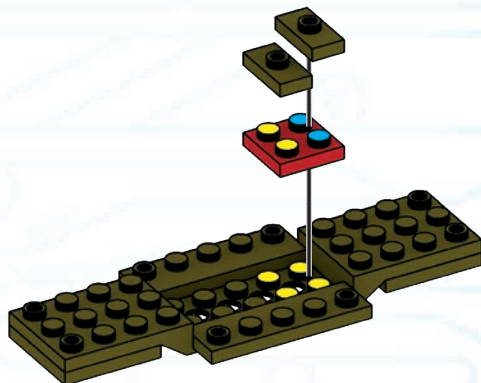
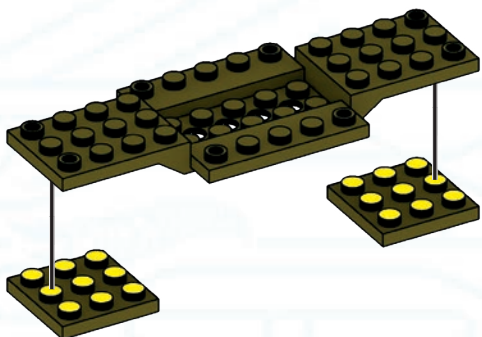

4



2x



1x

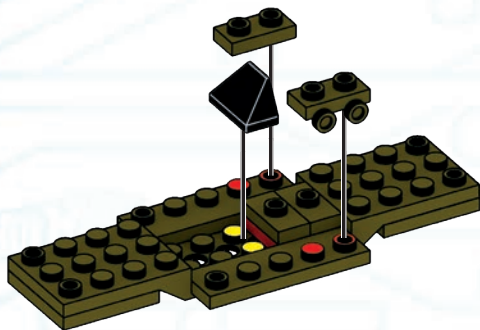

5



2x

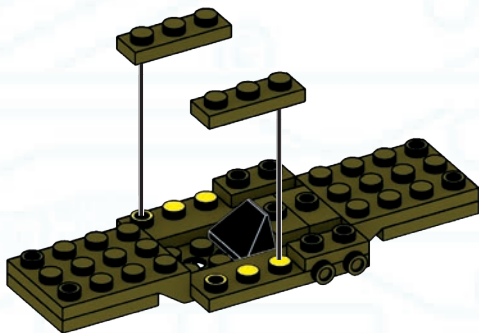



HW VB BOMBER™
MONSTER TRUCK · CAMIÓN DE CARRERAS

6



1x

1x

7



1x



1x

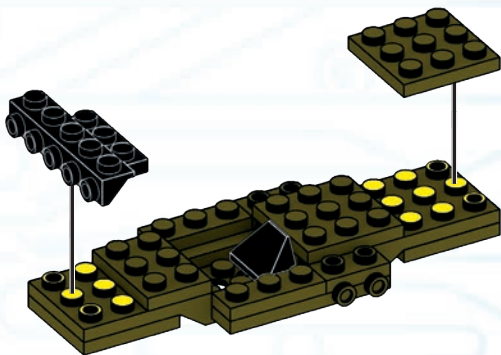
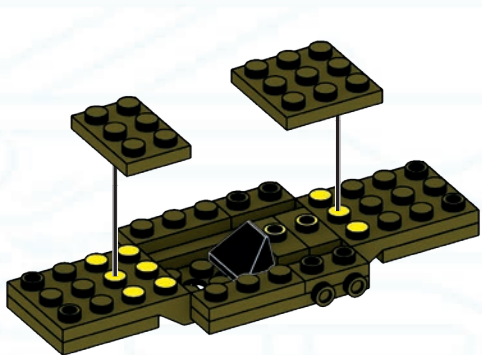

8



1x

1x

9



1x



1x



1x

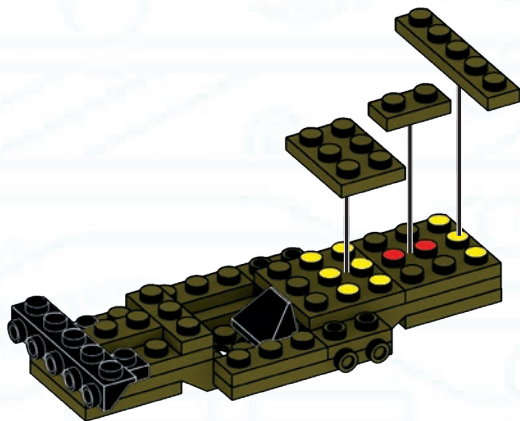
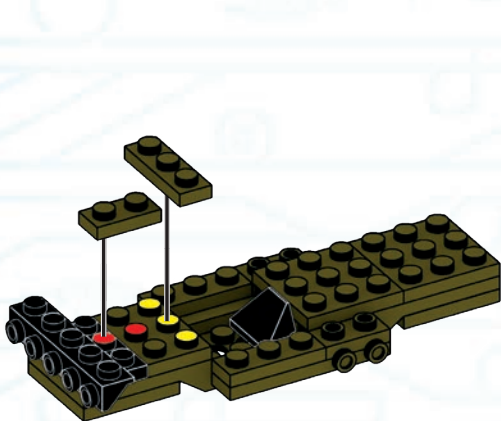



HW VB BOMBER™
MONSTER TRUCK · CAMIÓN DE CARRERAS

10



1x

1x

11



1x

1x

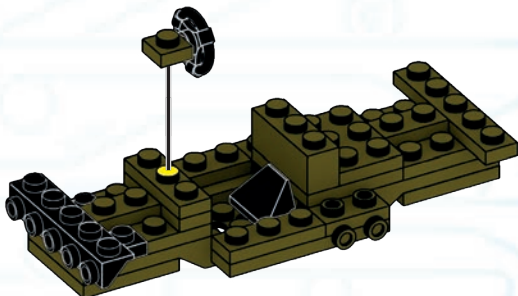
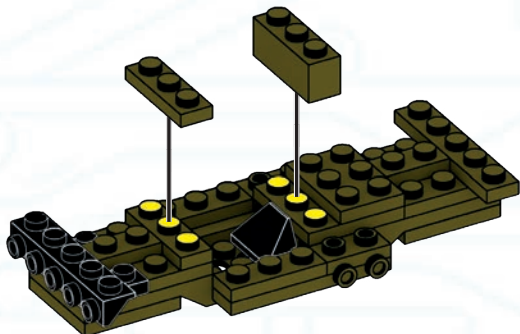
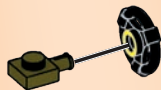

12



1x



1x

13



1x



1x



1x



1x

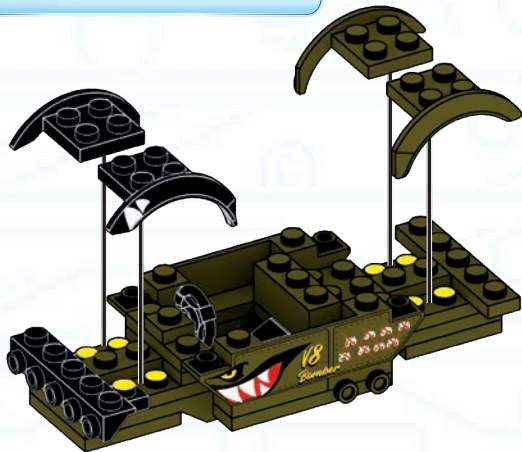
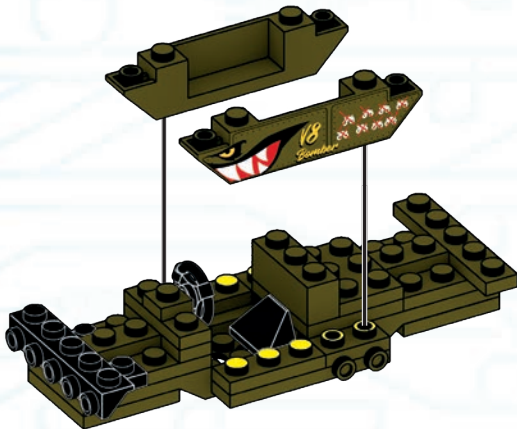



HW VB BOMBER™
MONSTER TRUCK · CAMIÓN DE CARRERAS

14



2x

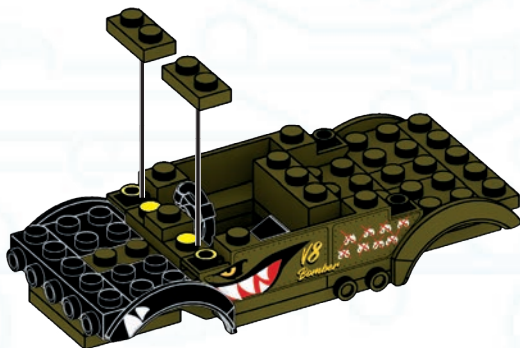

15



1x



1x

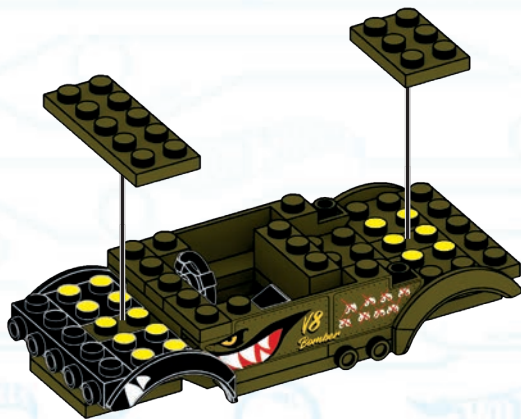

16



2x

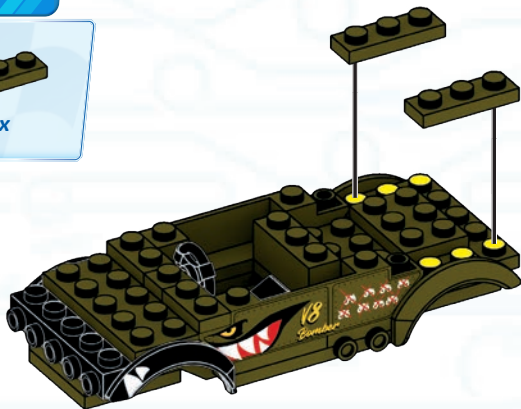

17

2



1x

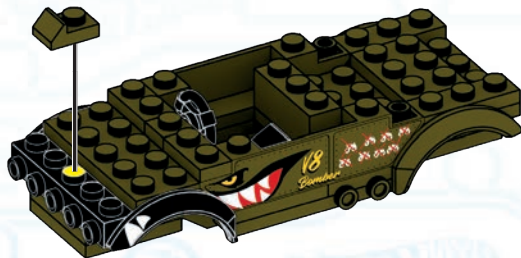



HW V8 BOMBER™
MONSTER TRUCK · CAMIÓN DE CARRERAS

18



2x

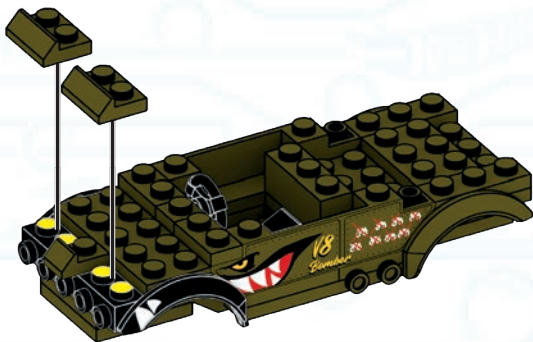

19



2x



1x

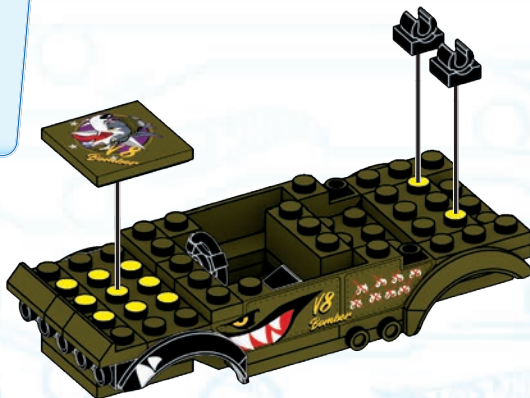

20



1x

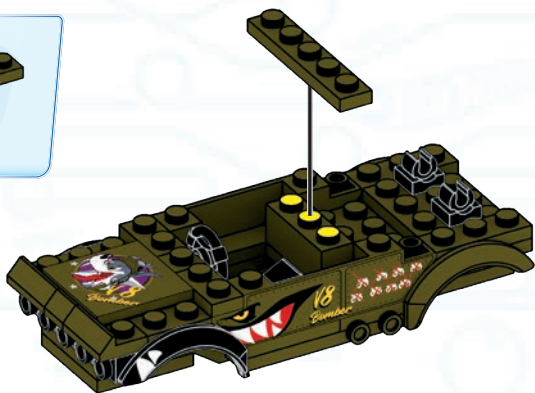

21



4x

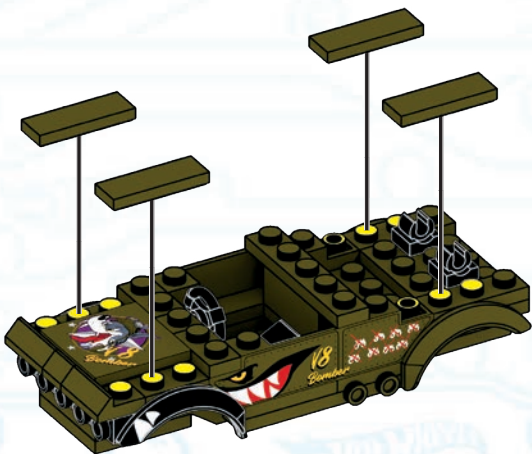



HW V8 BOMBER™
MONSTER TRUCK · CAMIÓN DE CARRERAS

22



2x

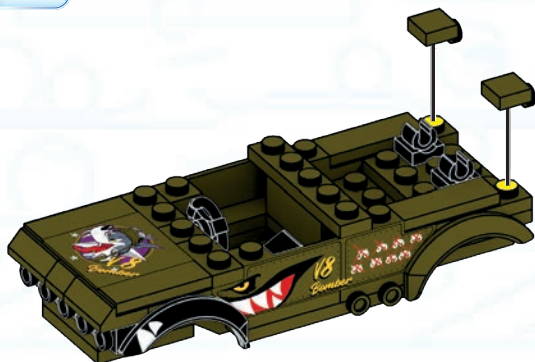

1

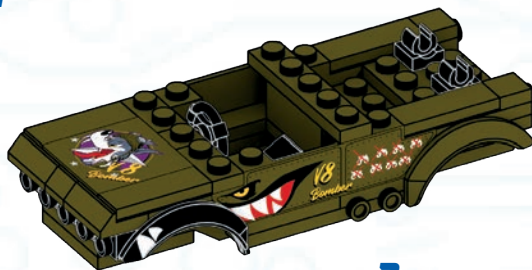

2

23



1x



2x



1x

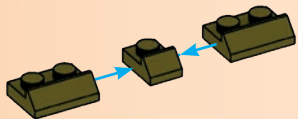

1



2



3

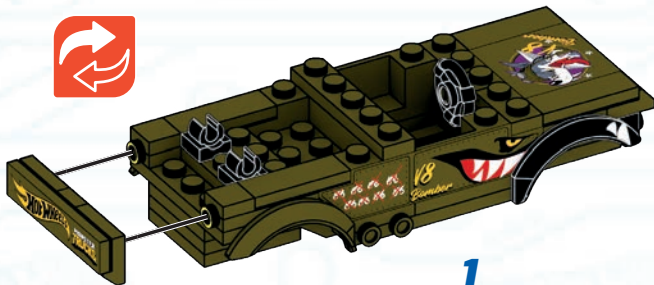

1

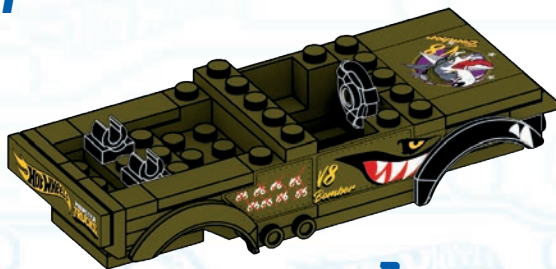

2



HW VB BOMBER™ MONSTER TRUCK · CAMIÓN DE CARRERAS

24



2x



1x

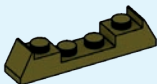

1x

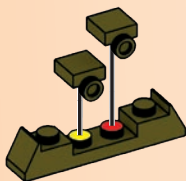

1

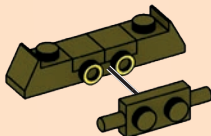

2



3

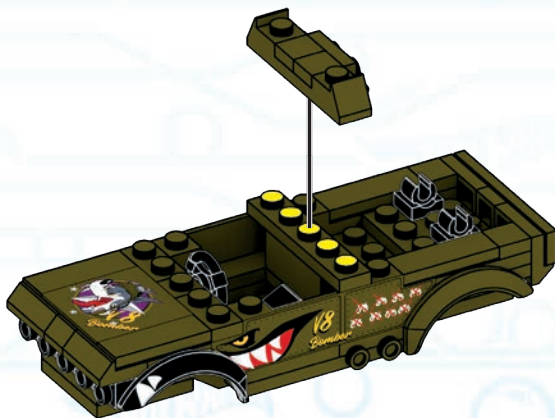

25



1x

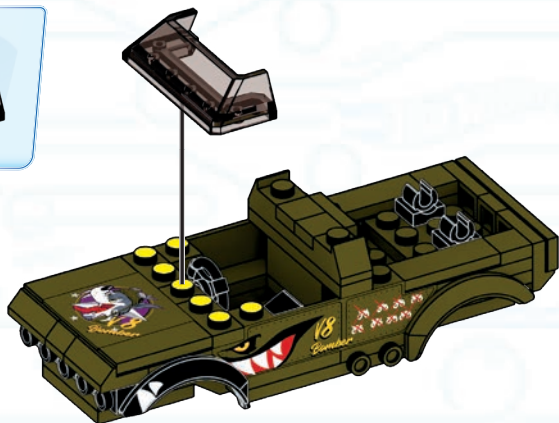

26



1x

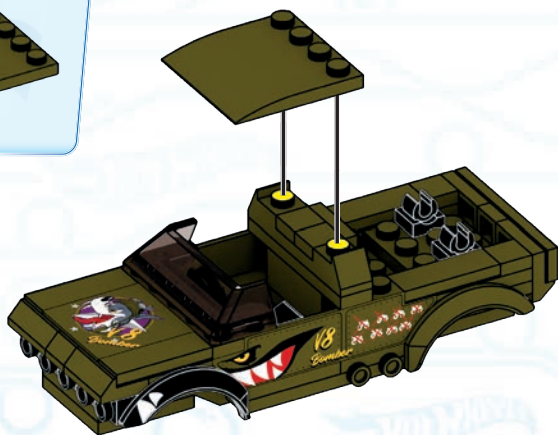



HW V8 BOMBER™
MONSTER TRUCK · CAMIÓN DE CARRERAS

27



1x

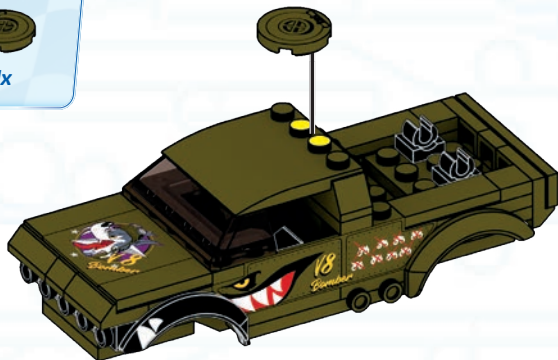

28



2x

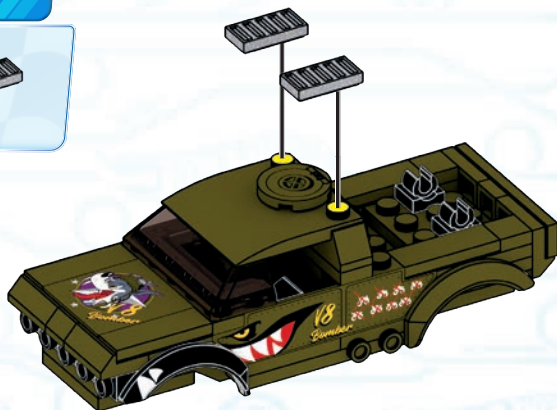

29



2x

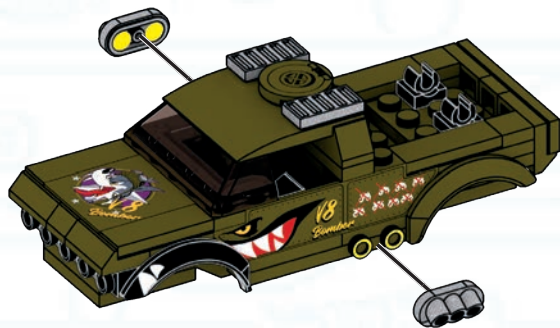



HW VB BOMBER™ MONSTER TRUCK · CAMIÓN DE CARRERAS

30



2x

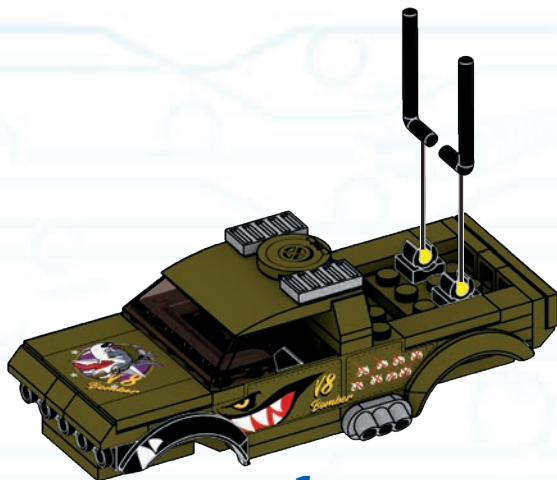

1

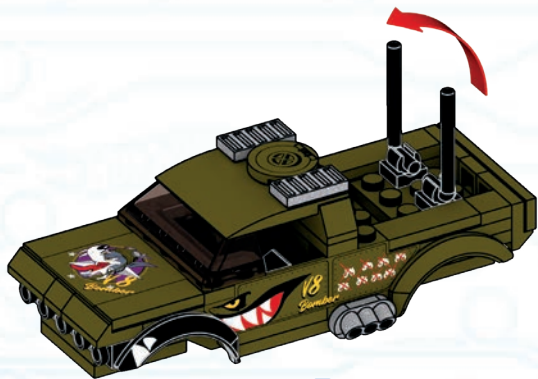

2



3

31

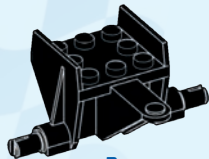

2x

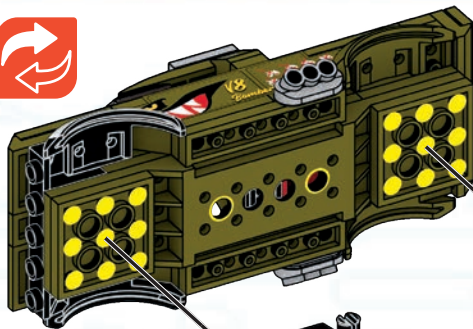

1

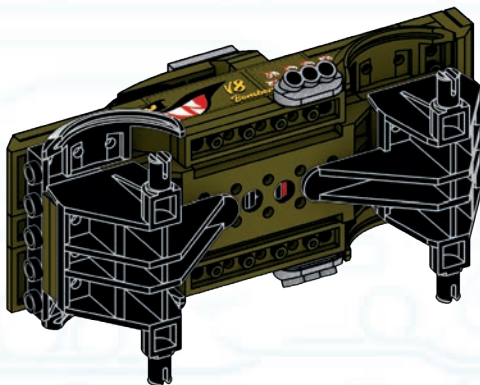

2



HW VB BOMBER™
MONSTER TRUCK · CAMIÓN DE CARRERAS



32



2x

2x

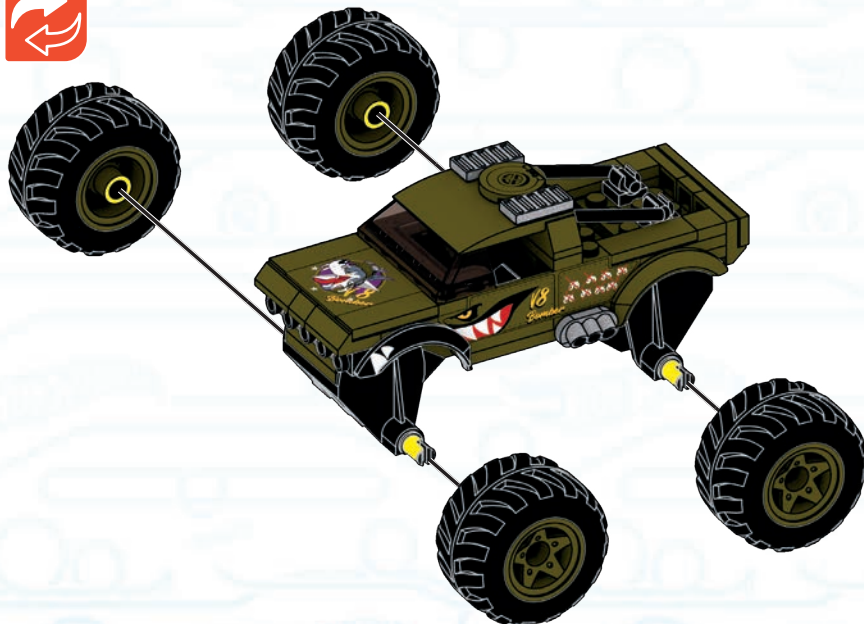

1

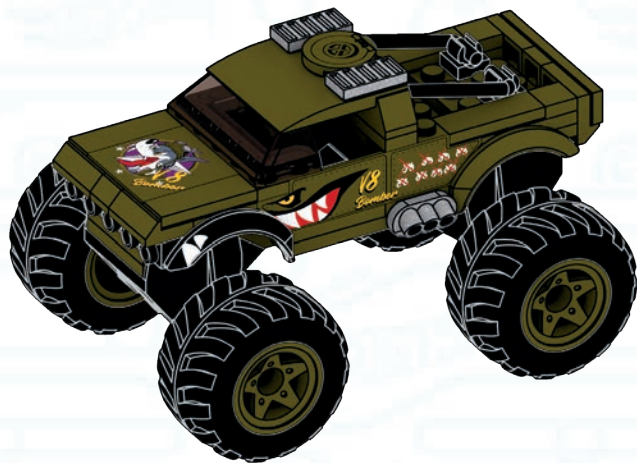



33



2x



1x



1x



1x



1



2

34



1x



1x



1

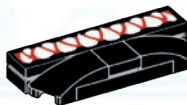

2

35

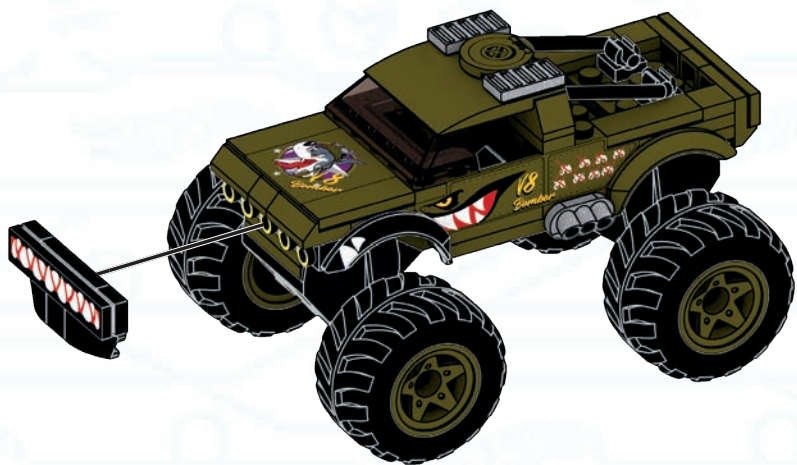



HW VB BOMBER™
MONSTER TRUCK · CAMIÓN DE CARRERAS

36

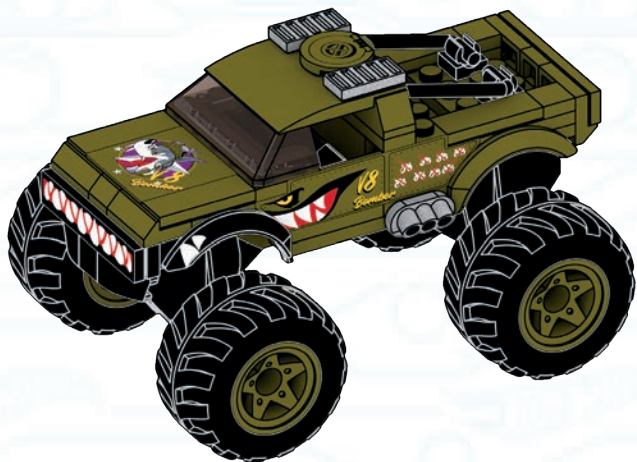

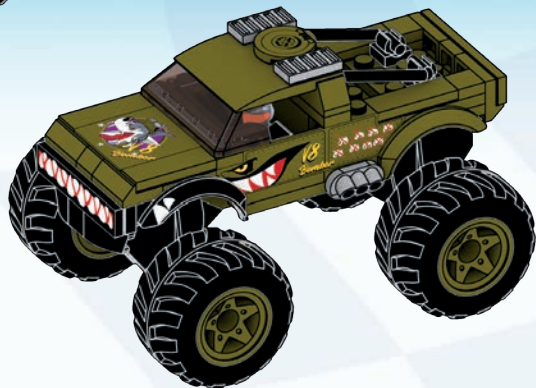

MIX & MATCH! COMBINE-LES!

MEZCLA Y COMBINA! · MISTURA E COMBINA!
ZUM KOMBINIEREN! · СОЧЕТАЙ И ПОДБИРАЙ!

HHD18*



TWIN MILL™ HDJ90*	HW40™ GVG32*	RODGER DODGER™ GYG33*	BONE SHAKER™ HDJ89*	MEGA WREK™ HDJ95*	RALLY CAT™ GVM13*
TIGER SHARK™ GVM26*	'83 CHEVY® SILVERADO™ HHL97*	64 CORVETTE® GRAND SPORT™ HHL95*			TWINDUCTION™ GYG66*
RODGER DODGER™ GYG22*	'17 CAMARO® HHL98*	'16 CADILLAC® ATS-V™ HHL96*			
MOD ROD™ GVM13*	NIGHT SHIFTER™ GVM13*	DAWGZILLA™ GVM13*			

Set(s) sold separately and subject to availability. / Ensemble(s) vendu(s) séparément. Certains produits peuvent ne pas être commercialisés. / Se vende(n) por separado y está(n) sujeto(s) a disponibilidad. / Conjunto(s) vendido(s) em separado e sujeito(s) à disponibilidade. / Set in vendita separatamente, secondo disponibilità. / Das/Die Set(s) sind separat erhältlich. / Zestaw(y) sprzedawany(e) oddzielnie w zależności od dostępności. / Set(s) apart verkrijgbaar en afhankelijk van beschikbaarheid. / Набор(-ы) продаются отдельно, при наличии. / Sæt sælges separat og så længe lager haves. / Seten säljs separat så länge lagret räcker. / Settet/settene selges separat så langt lageret rekker. / Pakkaus/pakkaukset myydään erikseen, saatavuus voi vaihdella. / Το(α) σετ πωλούνται ξεχωριστά και ανάλογα με τη διαθεσιμότητα. / Setler ayrı olarak satılır ve stoklarla sınırlıdır. / Set (sety) se prodává (prodávají) samostatně dle aktuální nabídky. / Súprava/-y sa predáva(jú) samostatne a podľa dostupnosti. / A készlet(ek) külön kapható(k), az elérhetőség változhat. / セット商品は別売りになります。在庫状況は別途ご確認をお願いします。每套单独发售，按供货情况决定。

Additional purchase required. / Achat additionnel requis. / Zusätzlicher Kauf erforderlich. / Richiede acquisto addizionale. / Aanvullende aankoop vereist. / Requiere compra adicional. / Requier compra adicional. / Ytterligere kjøp krevs. / Edellyttää lisäosien ostamista. / Supplerende køb nødvendigt. / Ekstra kjøp kreves. / Wymagany dodatkowy zakup. / Vyžaduje dodatečný nákup. / Vyžaduje sa dokúpenie. / További vásárlás szükséges. / Необходимо дополнительная покупка. / Αναπείρειται επιπλέον αγορά. / Ek ürünü satın almanız gerekir. / تتطلب شراء القطع الإضافية.

REBUILD YOUR CARS INTO MONSTER TRUCKS! RÉASSEMBLE TES VOITURES POUR EN FAIRE DES MONSTER TRUCKS!

CONVIERTE TUS COCHES EN "MONSTER TRUCKS!"
TRANSFORMA OS SEUS CARRDS EM MONSTER TRUCKS!

FAHRZEUGE IN MONSTER TRUCKS UMBAUEN! · ПЕРЕСТРАИВАЙ СВОИ МАШИНКИ В МОНСТР-ТРАКИ!



HDJ95*

V8 BOMBER™



HH017*

HW 5 ALARM™



HH019*

RACE ACE™



HDJ93*

GUNKSTER™



HDJ94*

HW DEMO
DERBY™



HH018*

TIGER SHARK™



GVM25*

'83 CHEVY® SILVERADO™



HHL97*

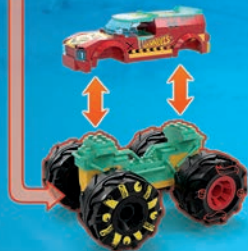

1



2



3

Most models can be built one at a time. / La plupart des modèles peuvent être construits un à la fois. / La mayoría de modelos se pueden construir de uno en uno. / A maioria dos modelos pode ser construída separadamente. / La maggior parte dei modelli possono essere realizzati uno per volta. / Die meisten Modelle können eines nach dem anderen gebaut werden. / Większość modeli nie da się budować jednocześnie z innymi. / De meeste modellen kunnen één voor één gebouwd worden. / Большинство моделей могут быть собраны по одной за раз. / De fleste modeller kan bygges enkeltvis. / De flesta modeller kan byggas en i taget. / De fleste modellene kan bygges en om gangen. / Useimmat mallit voidaan rakentaa yksi kerrallaan. / Τα περισσότερα μοντέλα μπορούν να κατασκευασθούν ένα ένα. / Modellerin çoğu ayrı ayrı inşa edilmeyi gerektirebilir. / Väčšina lize najednou sestavit pouze jeden model. / Väčšina modelov môže byť zostavená iba raz. / A modellek többségéből egyszerre csak egy építhető. /ほとんどのモデルは、一度に一つを組み立てることができます。 /

يمكن تركيب التصميم الواحد تلو الآخر.

大多數型號可一次性建構

1x
AM07223F



2x
AM03328F



2x
AM19999F



2x
AM19530AXU



4x
AM79665AXU



1x
AM80546AXU



2x
AM09198APG



2x
AM07590AXU



4x
AM09393AXU



2x
AM76467AXU



2x
AM76469APG



1x
AS-HHD17-05



1x
AM81383F



1x
AM74427F



1x
AM74426F



1x
AM19061F



4x
AM09835AXU



1x
AM03773AXW



4x
AM80966AXU



1x
AM18705AXU



6x
AM01314AXU



3x
AM03772AXU



1x
AM03772F



1x
AM16384AXU



1x
AS-HHD17-04



4x
AM81163AXU



1x
AS-HHD17-07



1x
AS-HHD17-08



1x
AM74398AXU



1x
AM74399AXU



2x
AM77738F



2x
AM07475AXU



1x
AS-HHD17-03



1x
AS-HHD17-06



1x
AM80965AXU



1x
AM81336AXU



1x
AS-HHD17-02



1x
AS-HHD17-01



1x
AM80970F



1x
AM81482AXU



2x
AS-HHD17-09



2x
AS-HHD17-10



2x
AM81331F



1x
AM80975AXU



1x
AM81481AMD





1x
FIG-HHD17-A

Missing pieces? • Pièces manquantes?

¿Partes faltantes? • Perdeu peças?
Fehlende Teile? • Не хватает деталей?

support.megabrand.com

Mattel Europa B.V., Gondel 1, 1186 MJ Amstelveen, Nederland. Mattel U.K. Limited, The Porter Building, 1 Brunel Way, Slough SL1 1FQ, UK. Mattel France, Parc de la Cerisaie, 1/3/5 allée des Fleurs, 94260 Fresnes Cedex. N° Cristal 0969 36 99 99 (Numéro non surtaxé) ou www.lesjoutetsmattel.fr Mattel Belgium, Trade Mart, Atomiumsquare, Bogota 202 - B 275, 1020 Brussels. Gratis nummer België: 0800 - 16 936 - Gratis nummer Luxemburg: 800 - 22 784 - Gratis nummer Nederland: 0800 - 262 88 35. Deutschland : Mattel GmbH, Solmsstraße 4, D-60486 Frankfurt am Main. Schweiz: Mattel AG, Kirchstrasse 24, CH-3097 Liebefeld. Österreich: Mattel Ges.m.b.H., Campus 21, Liebermannstraße A01 404, A- 2345 Brunn/Gebirge. Mattel Italy Srl, Via Bracco, 6-MAC 6, 20159 Milano, Italy. Servizio assistenza clienti: Customersv.italia@mattel.com - Numero verde 800 11 37 11. Mattel España, S.A., Aribau 200, 08036 Barcelona. cservice.spain@mattel.com Tel: 900 102 390 <http://www.service.mattel.com/es>. Mattel East Asia Ltd., Room 503-09, North Tower, World Finance Centre, Harbour City, Tsimshatsui, HK, China. Tel: (852) 3185-6500. Diimport & Diedarkan Oleh: Mattel Continental Asia Sdn Bhd. Level 19, Tower 3, Avenue 7, No. 8 Jalan Kerinchi, Bangsar South, 59200 Kuala Lumpur, Malaysia. Mattel South Africa (PTY) LTD, Office 102 13, 30 Melrose Boulevard, Johannesburg, 2196. Dystrybutor: Mattel Poland Sp. z o.o., Warsaw Trade Tower 34 p., ul. Chłodna 51, 00-867 Warszawa. Mattel Australia Pty. Ltd., 658 Church St., Richmond, Victoria, 3121. Consumer Advisory Service - 1300 135 312. Mattel AEBE, Εθνάρχου Μικαηλίου 1, Κτήριο Κ-2, ΤΚ 17561, Παλαιό Φάληρο. Mattel Oyuncakçılık Tic. Ltd. Şti. İçerenköy Mah., Erku Sok. A Blok No:12 Üner Plaza Kat:9 34752 Ataşehir İstanbul. Tel: 0216 570 75 00. Импортёр/Уполномоченная организация: ООО "МАТТЕЛ" Российская Федерация, 105120 Москва, 2-й Сыромятинский переулок, 17; +7 495 287 79 39. Mattel Czech Republic s.r.o., The Forum, Václavské nám. 19, 11000 Praha1. Mattel, 333 Continental Boulevard, El Segundo, CA 90245, USA. Mattel Canada Inc., Mississauga, Ontario L5R 3W2. Consumer Services: You may call us free at/ Composez sans frais le 1-800-524-8697. Importado y distribuido por Mattel de México, S.A. de C.V., Miguel de Cervantes Saavedra No. 193, Pisos 10 y 11, Col. Granada, Alcaaldia Miguel Hidalgo, C.P. 11520, México, Ciudad de México. R.F.C. MME-920701-NB3. Tels: 59-05-51-00 Ext. 5206 ó 01-800-463-59-89. Mattel Chile, S.A., Avenida Américo Vespucio 501-B, Quilicura, Santiago. Tel.: 1230-020-6213. Servicio al consumidor Venezuela. Tel.: 0-800-100-9123. Mattel Argentina, S.A., Av. Libertador 1000, Piso 11 - Oficinas 109 y 111, Vicente López - Prov. Buenos Aires. Tel.: 0800-666-3373. Mattel Colombia, S.A., Calle 123#7-07 P5, Bogotá. Tel.: 01800-710-2069. Mattel Perú, S.A., Av. Juan de Arona # 151, Centro Empresarial Juan de Arona, Torre C, Piso 7, Oficina 704, San Isidro, Lima 27, Perú. RUC: 20425853865. Reg. Importador: 02350-12-JUE-DIGESA. Tel.: 0800-54744. E-mail Latinoamérica: servicio.clientes@mattel.com. Mattel do Brasil Ltda. - CNPJ : 54.558.002/0001-20 - Rua Verbo Divino, 1488 - 2º. Andar - 04719-904 - Chácara Santo Antônio - São Paulo - SP - Brasil. Serviço de Atendimento ao Consumidor: fone 0800 575 0780. E-mail: sac.matteldobrazil@mattel.com

ATTENTION : DANGER
D'ÉTOUFFEMENT. - PRÉSENCE DE PETITS
ÉLÉMENTS. NE CONVIENT PAS AUX ENFANTS DE
MOINS DE 3 ANS.

ATENÇÃO! NÃO INDICADO / NÃO
RECOMENDÁVEL PARA CRIANÇAS MENORES DE 3
(TRÊS) ANOS POR CONTER PARTE(S) PEQUENA(S)
QUE PODE(M) SER ENGOLIDA(S) OU ASPIRADA(S)
PODENDO PROVOCAR ASFIXIA.

警告:
のどにつまる危険 小さな部品が含まれています
3歳以下の子供には与えないで下さい。

警告!
不适合3岁以下儿童使用。
内含小零件。

WARNING : CHOKING HAZARD. - Small parts. Not for children under 3 years.
ADVERTENCIA : PELIGRO DE ATRAGANTAMIENTO. Juguete no recomendado
para menores de 3 años, porque contiene piezas pequeñas que podrían
provocar asfixia en caso de ser ingeridas o inhaladas por el/la niño/a.

AVVERTENZA : Contiene pezzi di piccole dimensioni.

ACHTUNG : Kleine Teile.

OSTRZEŻENIE : Małe części. Niebezpieczeństwo zadławienia.

WAARSCHUWING : Kleine onderdelen

ПРЕДУПРЕЖДЕНИЕ : Мелкие детали.

ADVASEL : Indeholder små dele.

VAROITUS : Pieniä osia

ΠΡΟΣΟΧΗ : Περιλαμβάνονται μικρά κομμάτια.

UYARI : Küçük parçalar.

UPOZORNĚNÍ : Malé díly

UPOZORNENIE : Malé časti

FIGYELMEZTETÉS : Kis alkatrészek.



0-3

تحذير:
غير مناسبة للأطفال دون 36 شهراً - قطع صغيرة.

BUILD YOUR WAY BY COMBINING MEGA™ HOT WHEELS® SETS CRÉEZ VOTRE UNIVERS EN ASSOCIANT LES COFFRETS HOT WHEELS® MEGA™



HHD19



HDJ93



HHD18



HHL95



HHL96



HHD17

CONSTRUYE EL RETO COMBINANDO LOS CONJUNTOS DE HOT WHEELS® DE MEGA™
CONSTRUA O DESAFIO COMBINANDO OS CONJUNTOS MEGA™ HOT WHEELS®
EIGENE STRECKEN BAUEN DURCH DAS KOMBINIEREN VON MEGA HOT WHEELS SETS
СТРОЙТЕ ПО-СВОЕМУ, ОБЪЕДИНЯЯ НАБОРЫ MEGA™ HOT WHEELS®

Set(s) sold separately and subject to availability. / Ensemble(s) vendu(s) séparément. Certains produits peuvent ne pas être commercialisés. / Se vende(n) por separado y está(n) sujeto(s) a disponibilidad. / Conjunto(s) vendido(s) em separado e sujeito(s) à disponibilidade. / Set in vendita separatamente, secondo disponibilità. / Das/Die Set(s) sind separat erhältlich. / Zestaw(y) sprzedawany(e) oddzielnie w zależności od dostępności. / Set(s) apart verkrijgbaar en afhankelijk van beschikbaarheid. / Набор(ы) продаются отдельно, при наличии. / Sæt sælges separat og så længe lager haves. / Seten säljs separat så länge lagret räcker. / Settet/settene selges separat så lang lageret rekker. / Pakkaus/pakkaukset myydään erikseen, saatavuus voi vaihdella. / To(a) οετ πωλούνται ξεχωριστά και ανάλογα με τη διαθεσιμότητα. / Setler ayrı olarak satılır ve stoklarla sınırlıdır. / Set (sety) se prodává (prodávají) samostatně dle aktuální nabídky. / Súprava/-y sa predávajú (jú) samostatne a podľa dostupnosti. / A készlet(ek) külön kapható(k), az elérhetőség változhat. / セット商品は別売りになります。在庫状況は別途ご確認をお願いします。/ تباع المجموعة أو المجموعات على حدة وتخضع لتوافرها.

每套单独发售，按供货情况决定。

Mattel Canada Inc. Mississauga, Ontario L5R 3W2.

MADE IN CHINA. FABRIQUÉ EN CHINE. FABRICADO NA / HECHO EN CHINA.

ИЗГОТОВЛЕНО В КИТАЕ. ÇIN'DE ÜRETİLMİŞTİR. صنع في الصين.

1186 MJ, 1, NL

Ⓟ D714,887, D781,964, D797,203

©2021 MEGA Brands & ™ MEGA Brands. HOT WHEELS™ and associated trademarks and trade dress are owned by and used under license from Mattel. HOT WHEELS™ ainsi que les marques et designs y afférents appartiennent à, et sont utilisés sous licence de Mattel. ©2021 Mattel.

Printed in China / Imprimé en Chine

AD-HHD17-01

UK
CA

