

MEGA

Barbie



HPN79

**MALIBU DREAM BOAT™
BATEAU DE RÊVE À MALIBU**

BOTE DE LOS SUEÑOS MALIBÚ / BARCO DOS SONHOS MALIBÚ
MALIBU TRAUM-BOOT / ЛОДКА МАЛИБУ



**Build
Construisez**
Construye | Constrói
Bauen | Стройте



Share | Partagez

Comparte | Partilha
Teilen | Делитесь

Devices not included | Appareils non inclus | Dispositivos não incluído
Dispositivos não incluídos | Geräte nicht enthalten | Устройства не входят в комплект

**Play as you build!
Jouez en construisant!**

Juega mientras construyes!
Construção e brincadeira simultâneas!
Gleichzeitig bauen und spielen!
Строй и играй!



megaunboxed.com

**CHOOSE WHAT YOU
WANT TO BUILD FIRST!
CHOISISSEZ CE QUE VOUS
VOULEZ CONSTRUIRE EN PREMIER!**

¡ELIGE QUÉ QUIERES CONSTRUIR PRIMERO! • ESCOLHA O QUE VOCÊ QUER CONSTRUIR PRIMEIRO! KINDER
KÖNNEN AUSSUCHEN, WAS SIE ZUERST BAUEN WOLLEN! • ВЫБЕРИ, ЧТО ТЫ ХОЧЕШЬ СОБРАТЬ СНАЧАЛА!



P.4



P.37



BUILD & CUSTOMIZE YOUR BARBIE® MICRO-DOLLS! ASSEMBLEZ ET PERSONNALISEZ VOS MINI-POUPÉES BARBIE!

¡CREA Y PERSONALIZA TU MICROMUÑECA BARBIE! • CONSTRÓI E PERSONALIZA AS TUAS MICROBONECAS BARBIE!
DIE BARBIE MIKROPUPPEN LASSEN SICH ZUSAMMENBAUEN UND NEU GESTALTEN!
СОБИРАЙТЕ И УКРАШАЙТЕ МИКРОКУКОЛ БАРБИ!

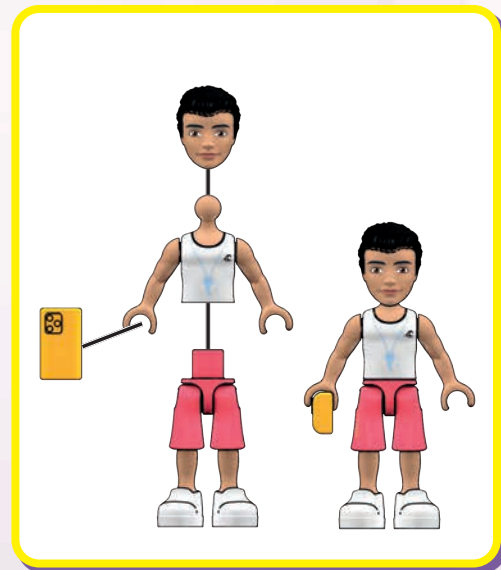
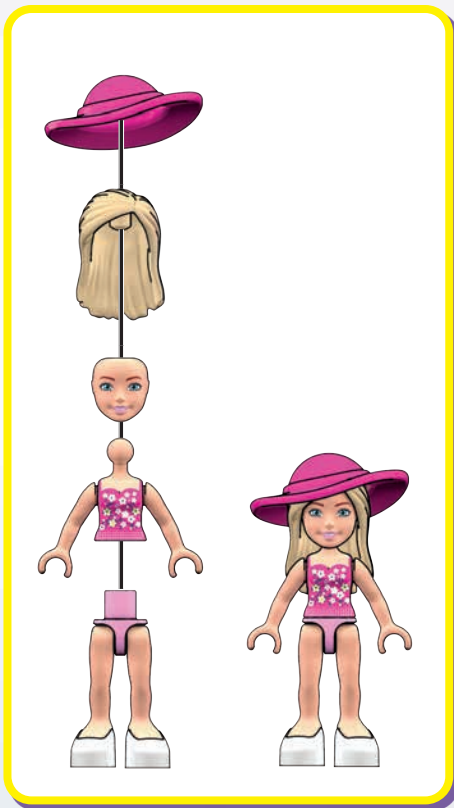

LET'S BUILD THE MALIBU LIFEGUARD STATION!

CONSTRUISONS LA CABANE DE NAGEURS-SAUVETEURS DE MALIBU!

¡VAMOS A CONSTRUIR EL PUESTO DE SALVAVIDAS DE MALIBÚ!

VAMOS CONSTRUIR A ESTAÇÃO DE NADADORES-SALVADORES DE MALIBU!

DIE STATION DER MALIBU-RETTUNGSSCHWIMMER BAUEN!

ПОСТРОИМ ВЫШКУ СПАСАТЕЛЕЙ МАЛИБУ!

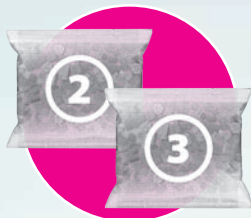

2x



1x

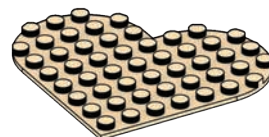

1x

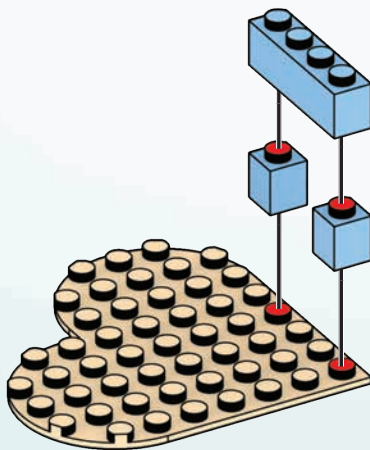

1

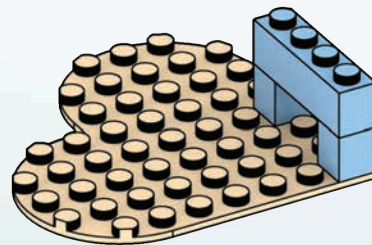

2

2



2x

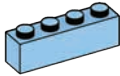

1x

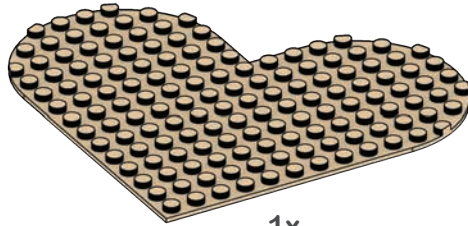

1x

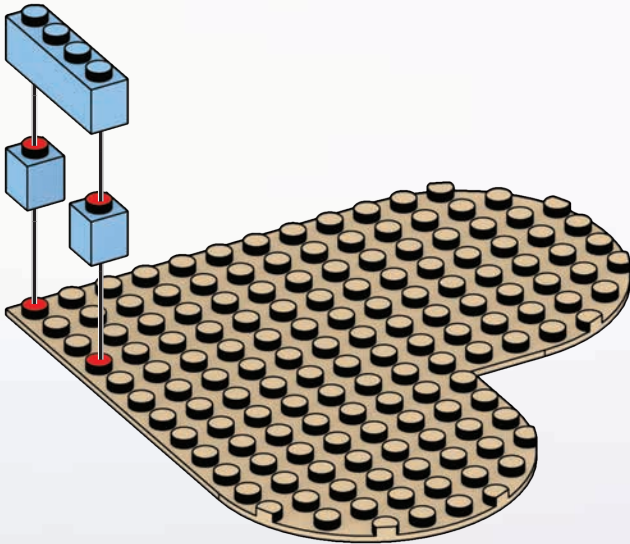

1

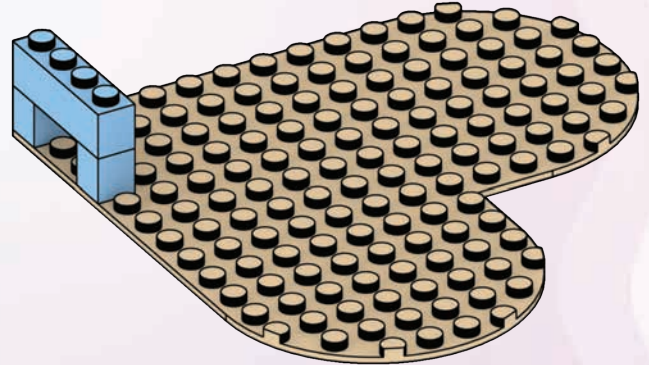

2

3

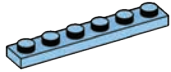

1x

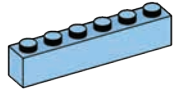

1x

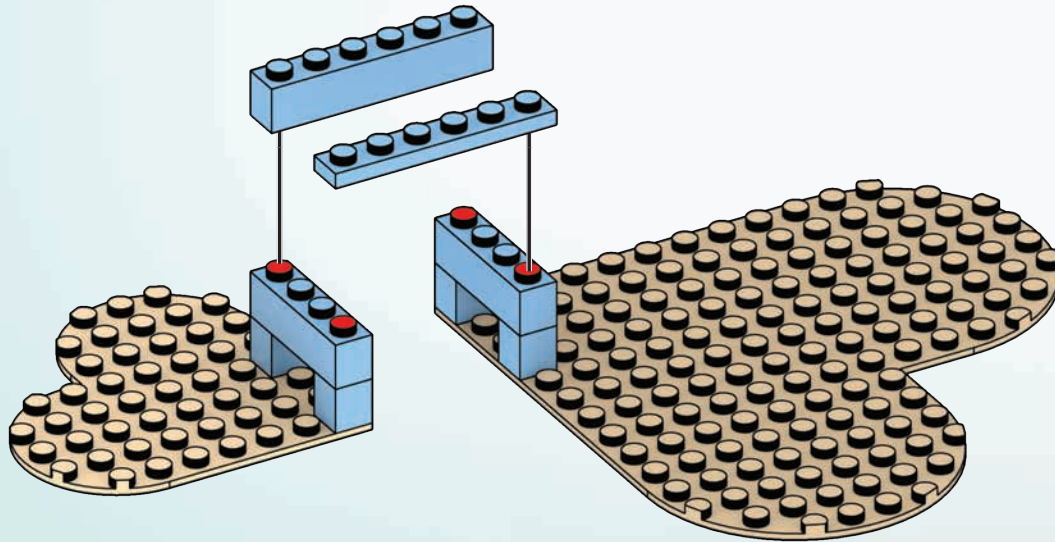

4



2x



1x

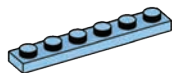

1x

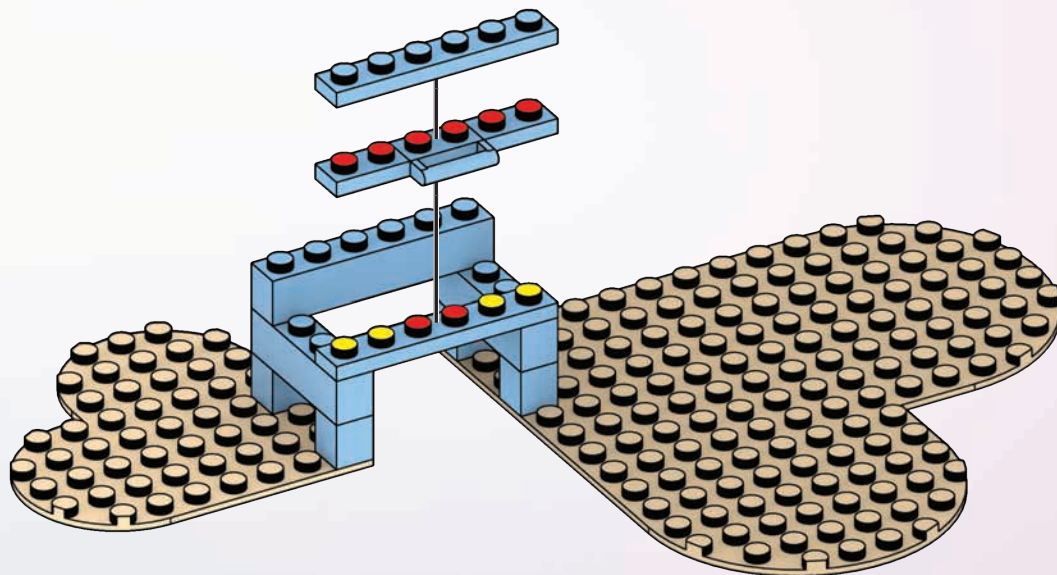

5



1x

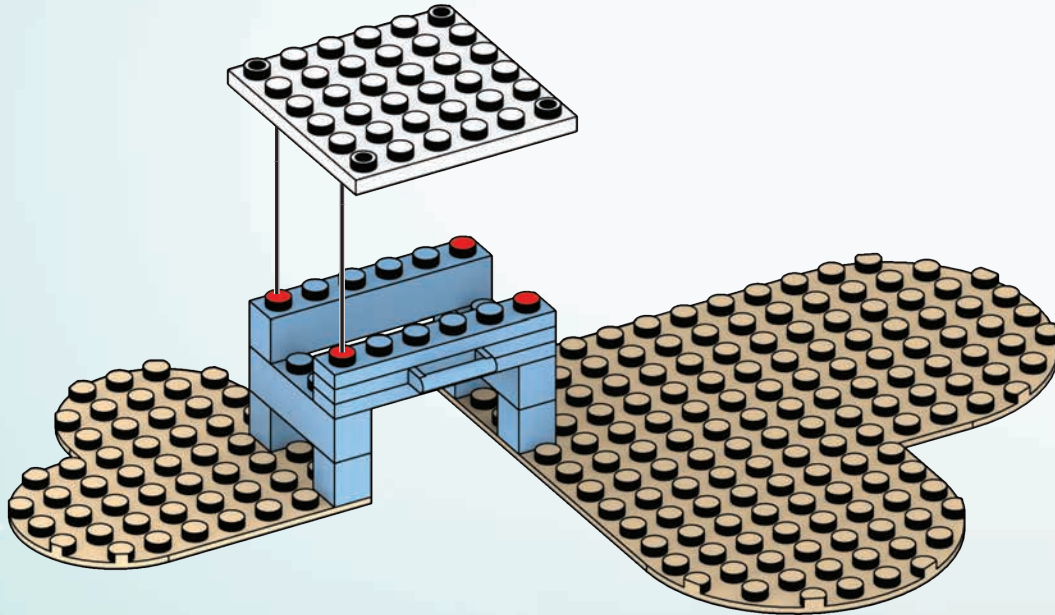

6



4x

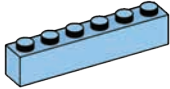

1x

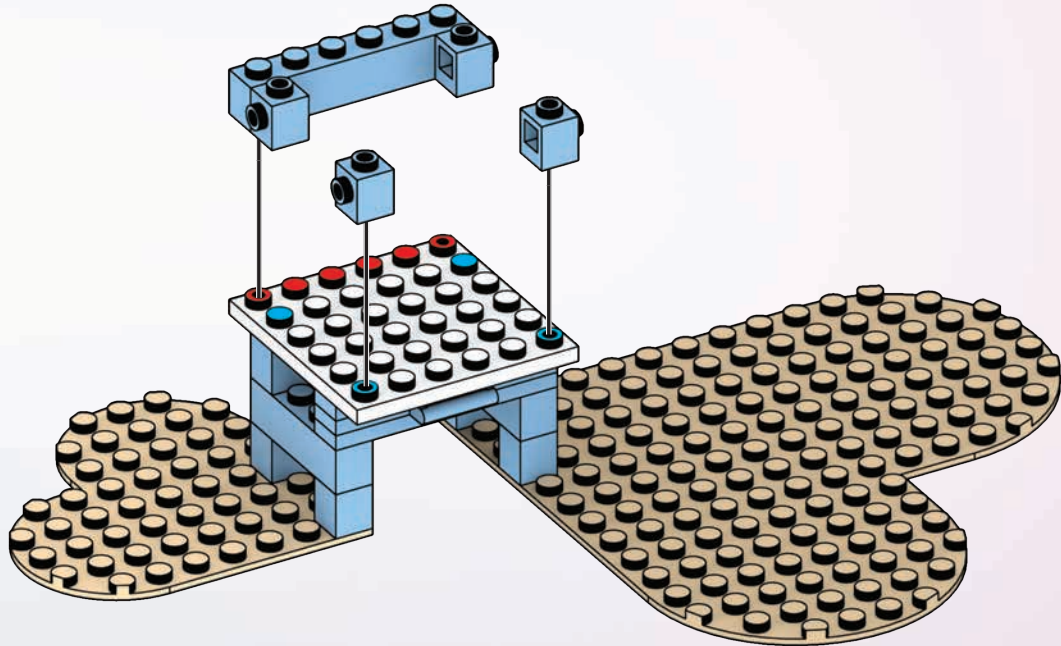

7

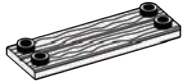

1x

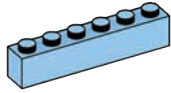

1x

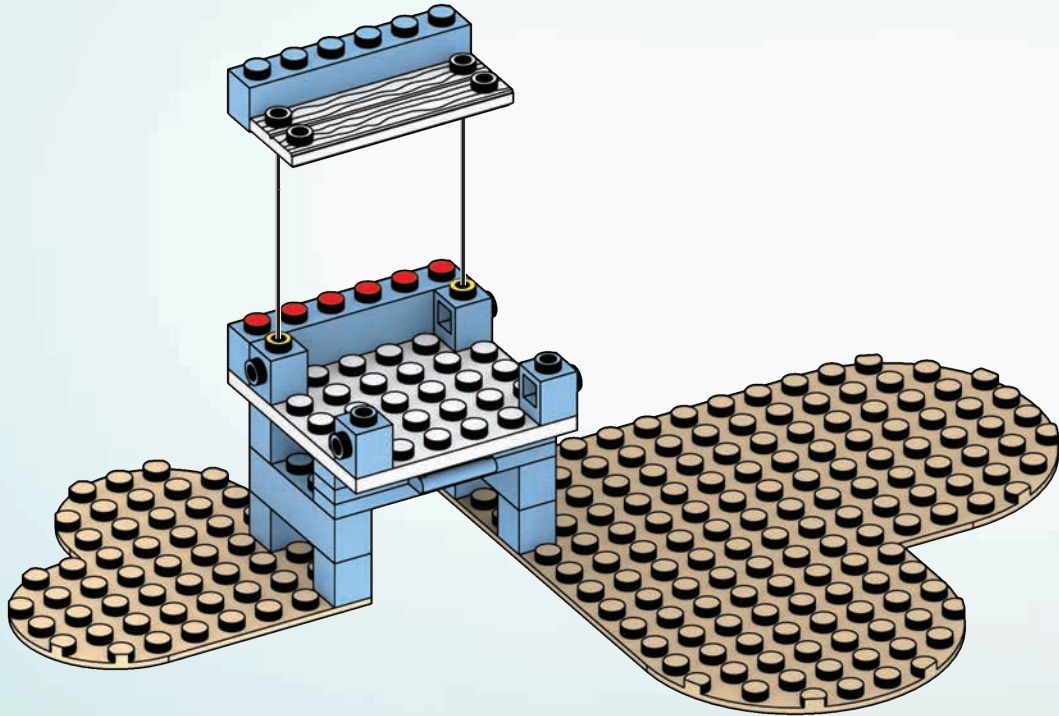

8



4x

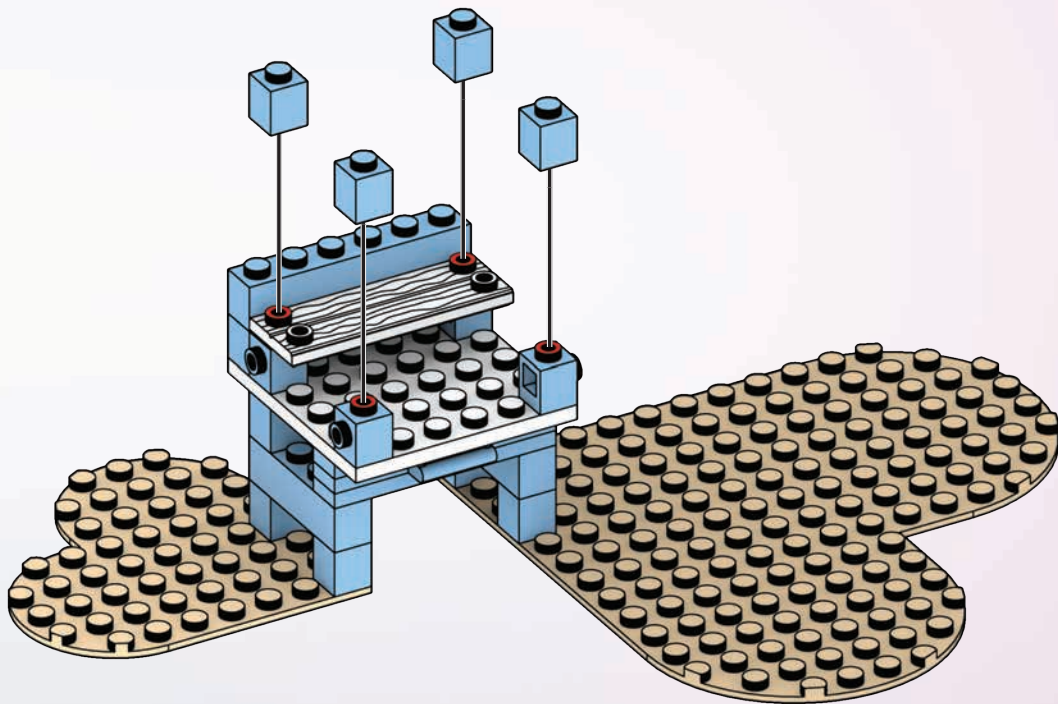

9



4x

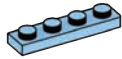

1x

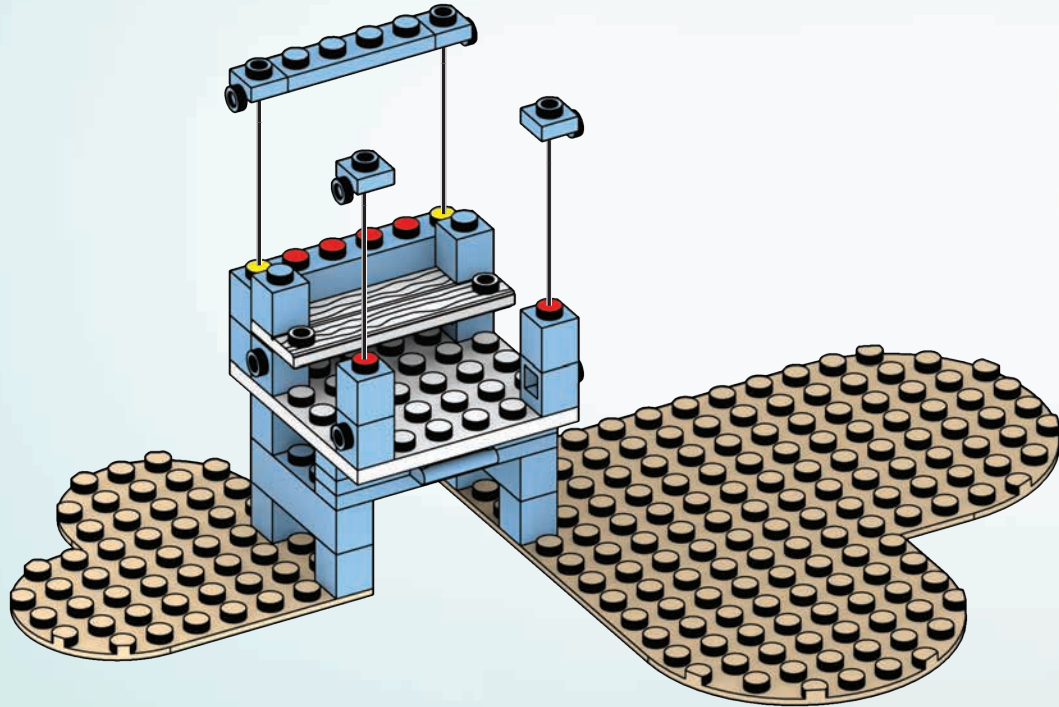

10

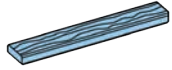

4x

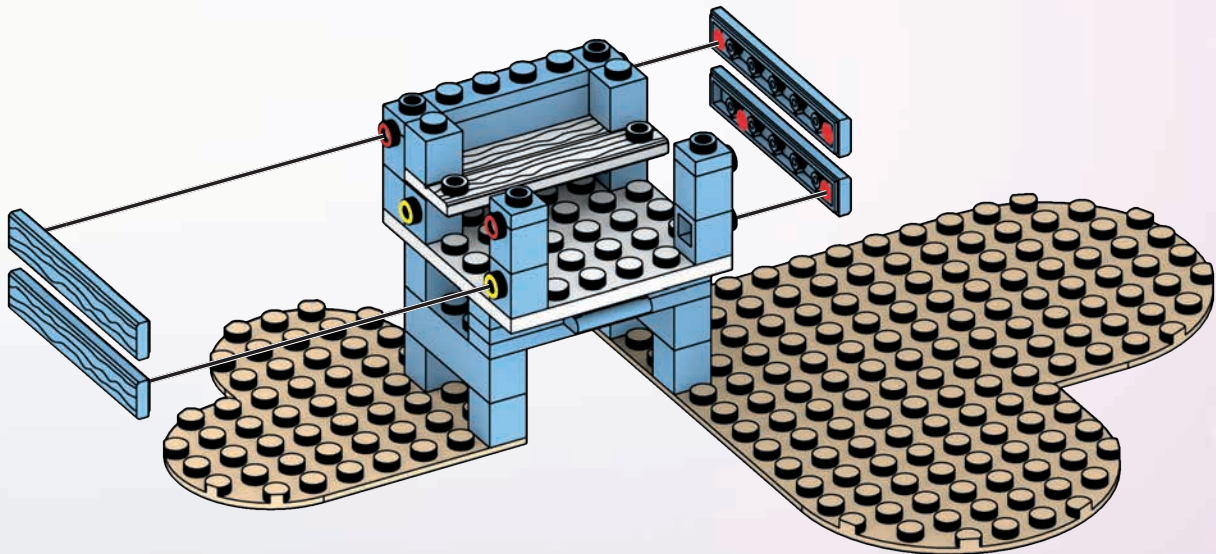

11



1x



2x

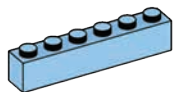

1x

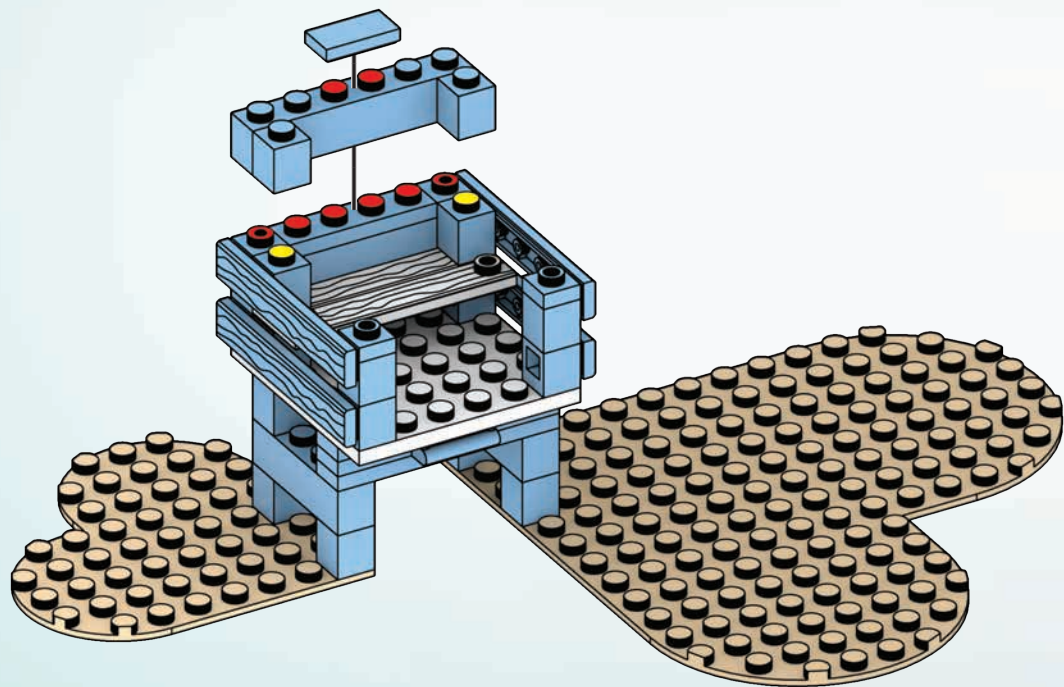

12



2x



4x

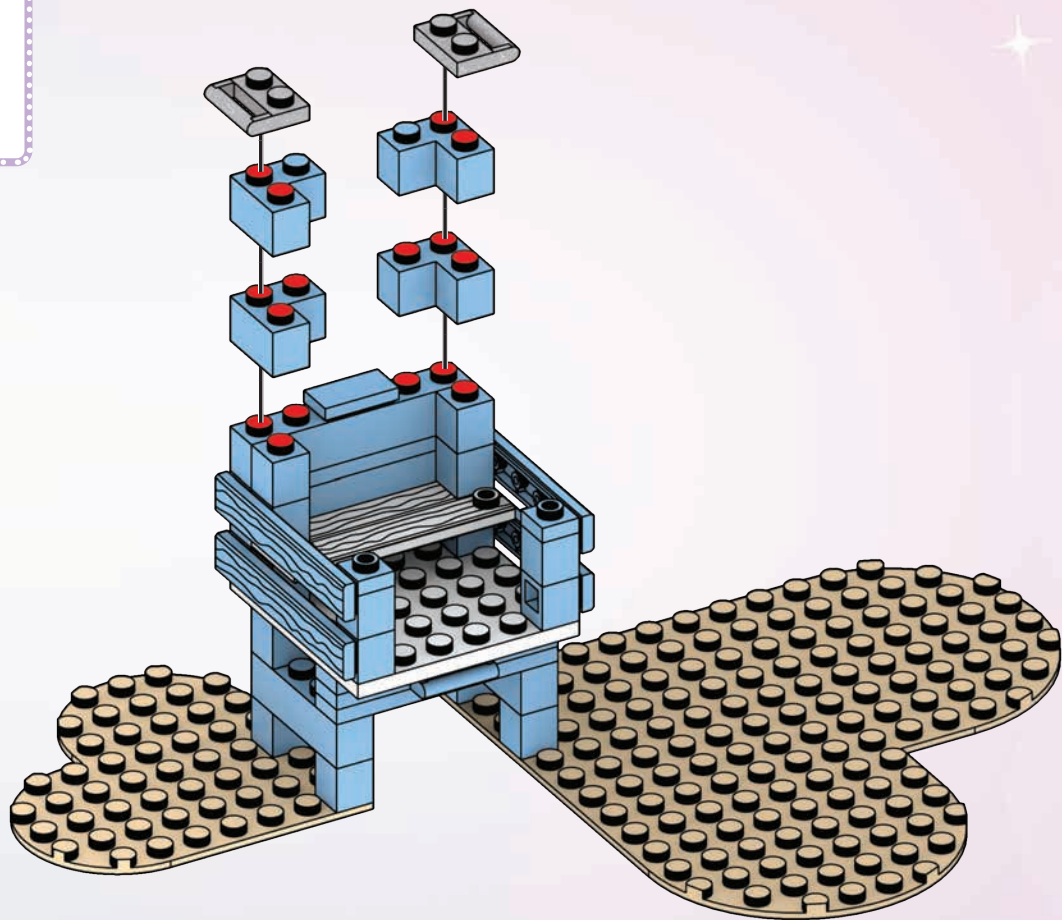

13



2x



2x

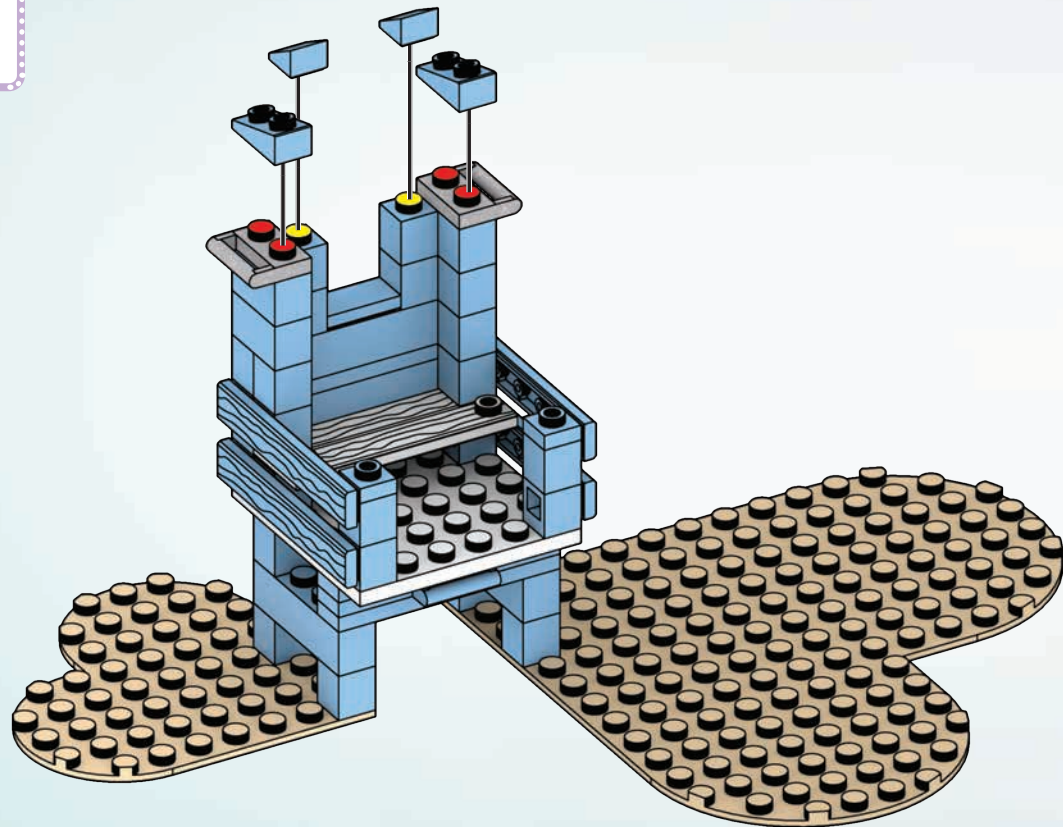

14



2x

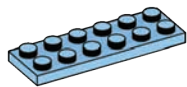

1x

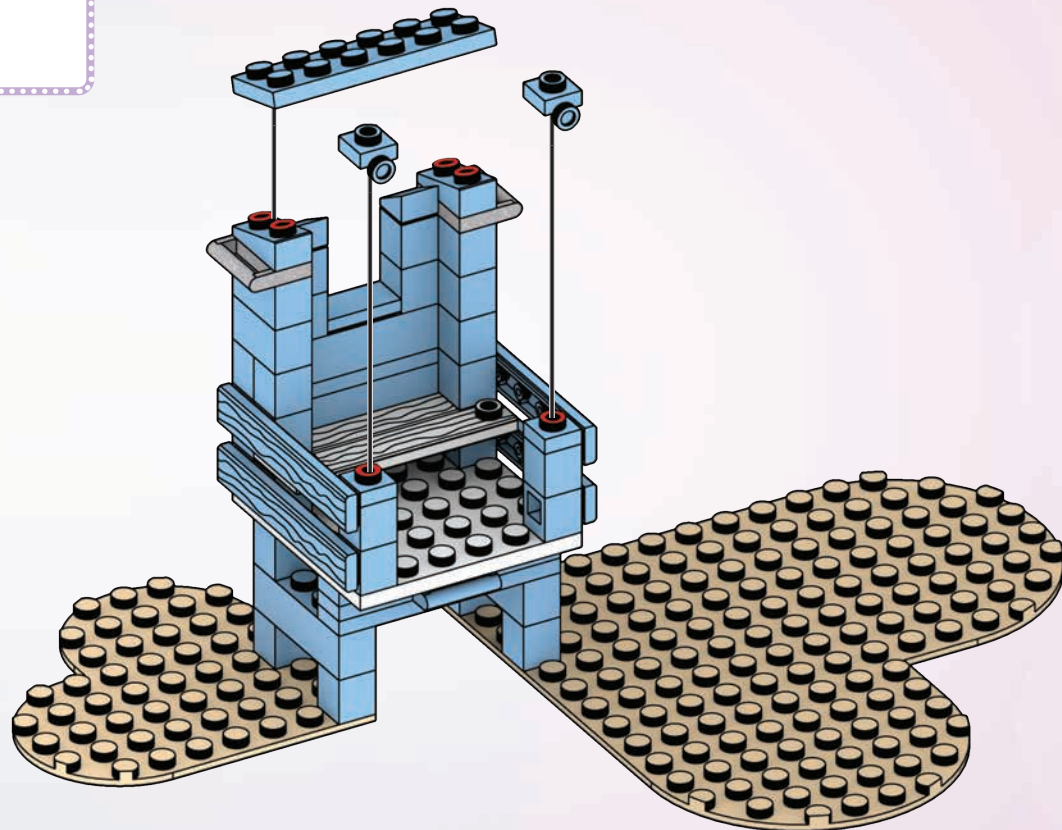

15



1x

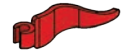

1x

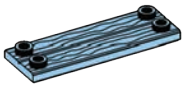

4x

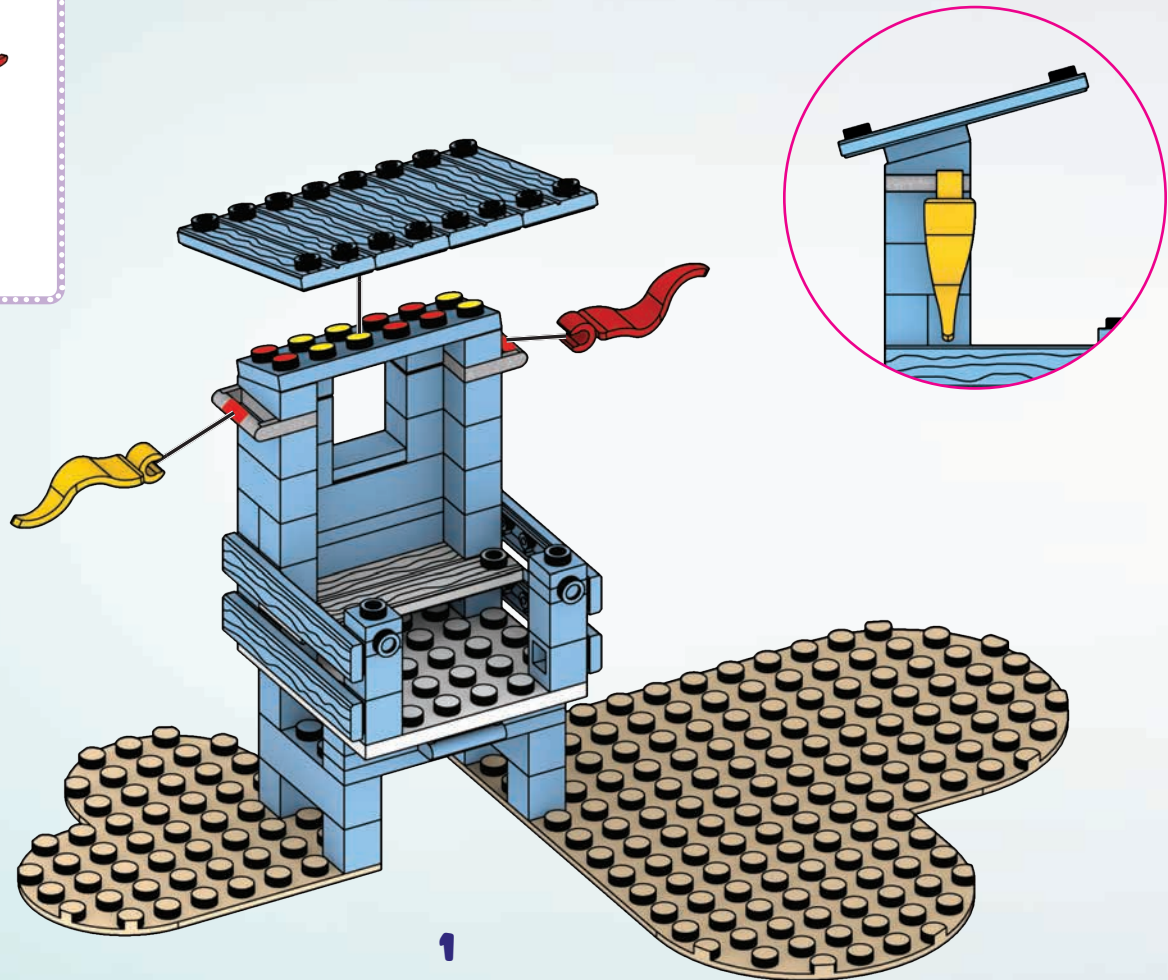

1

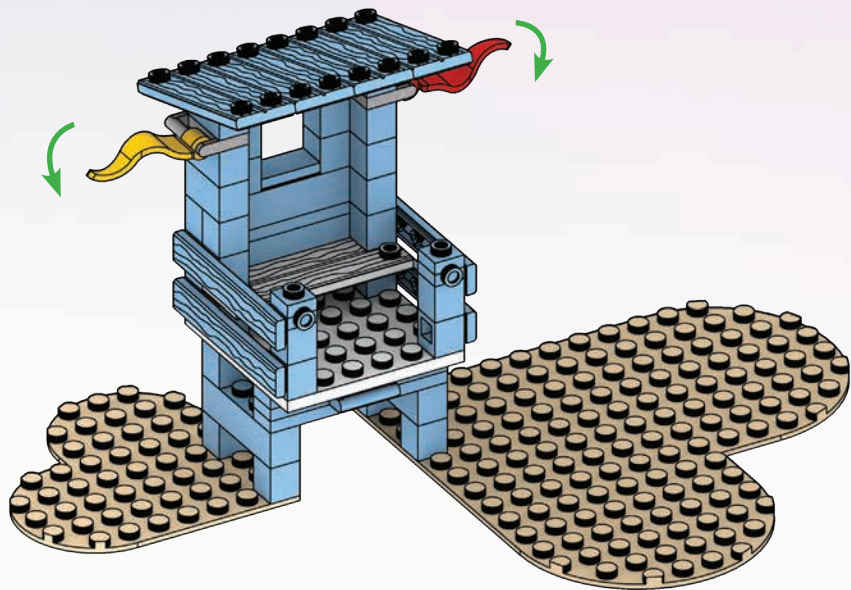

2

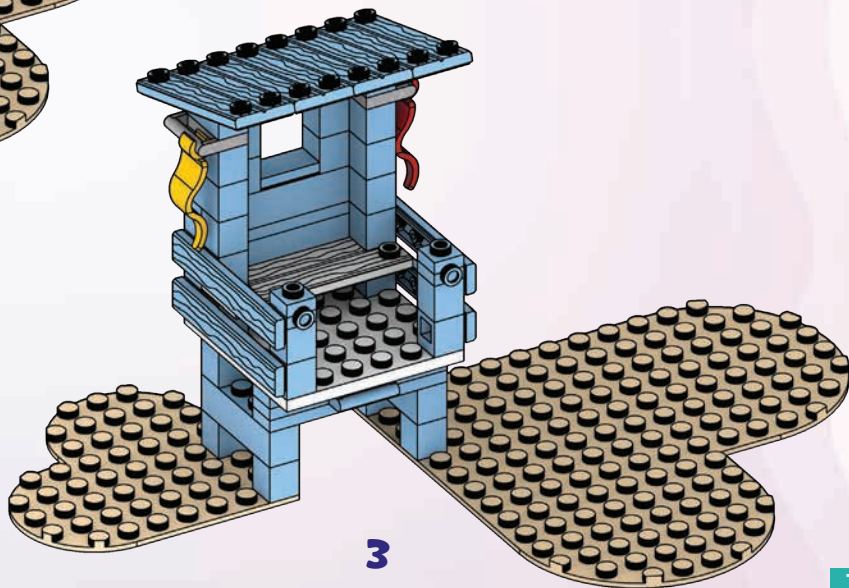

3

16

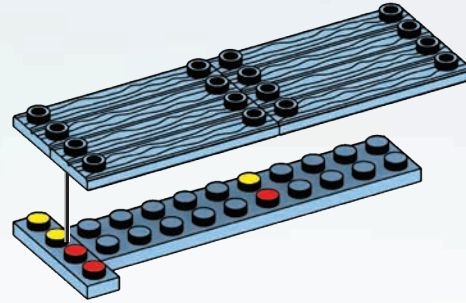
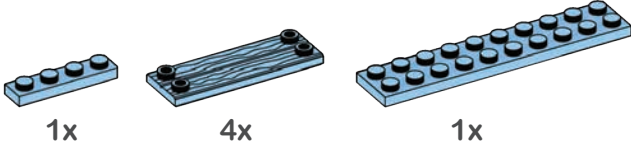

17

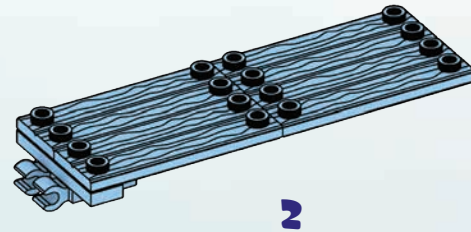
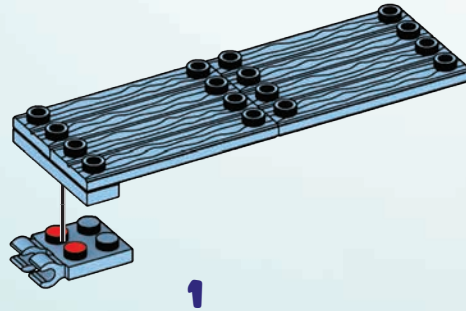
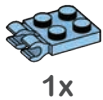

18

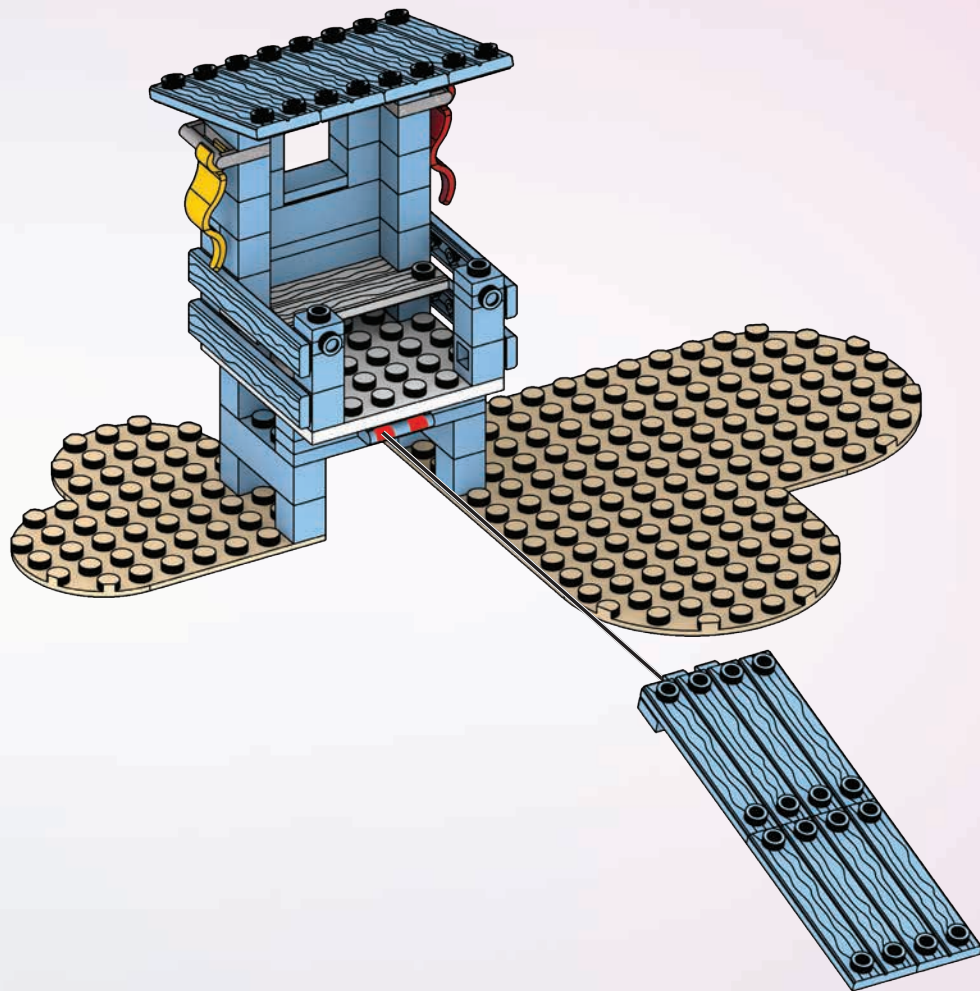

19



1x



2x

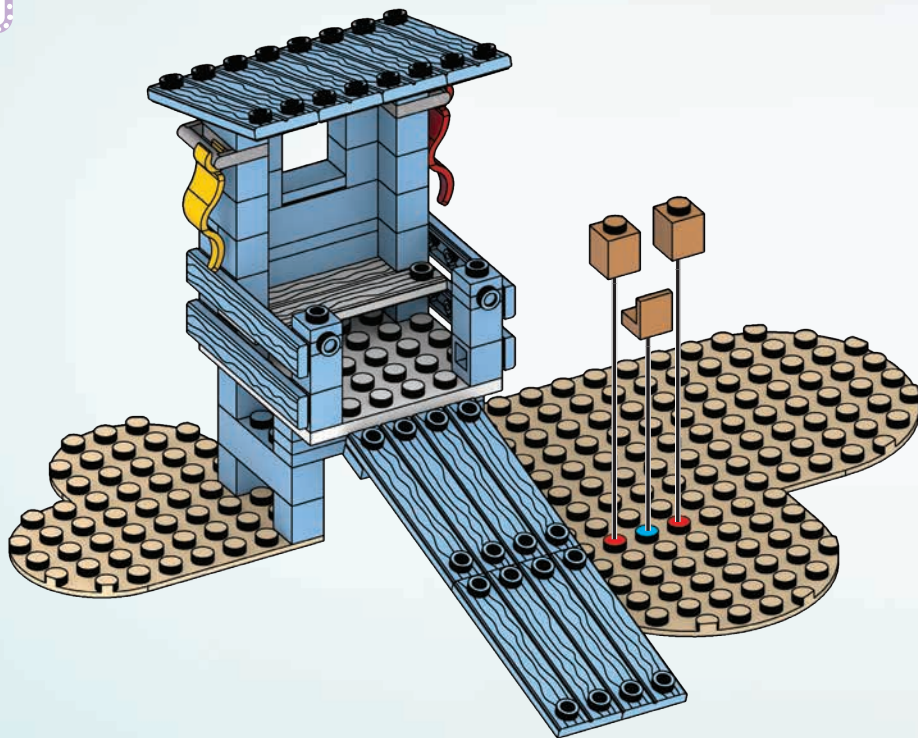

20



2x

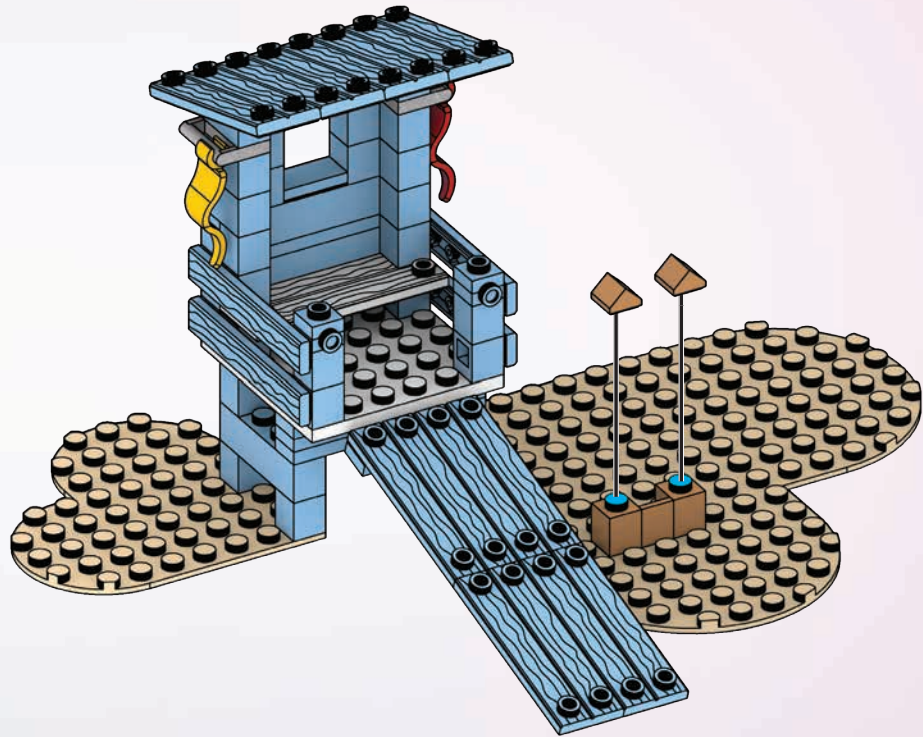

21



1x



1x



1x



2x

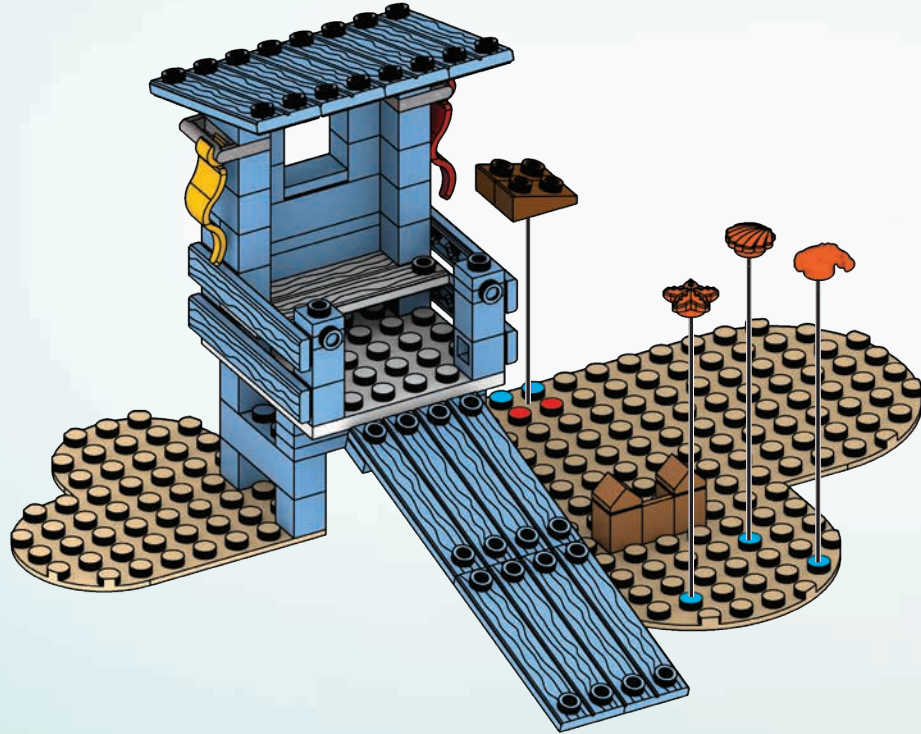

22



1x



5x

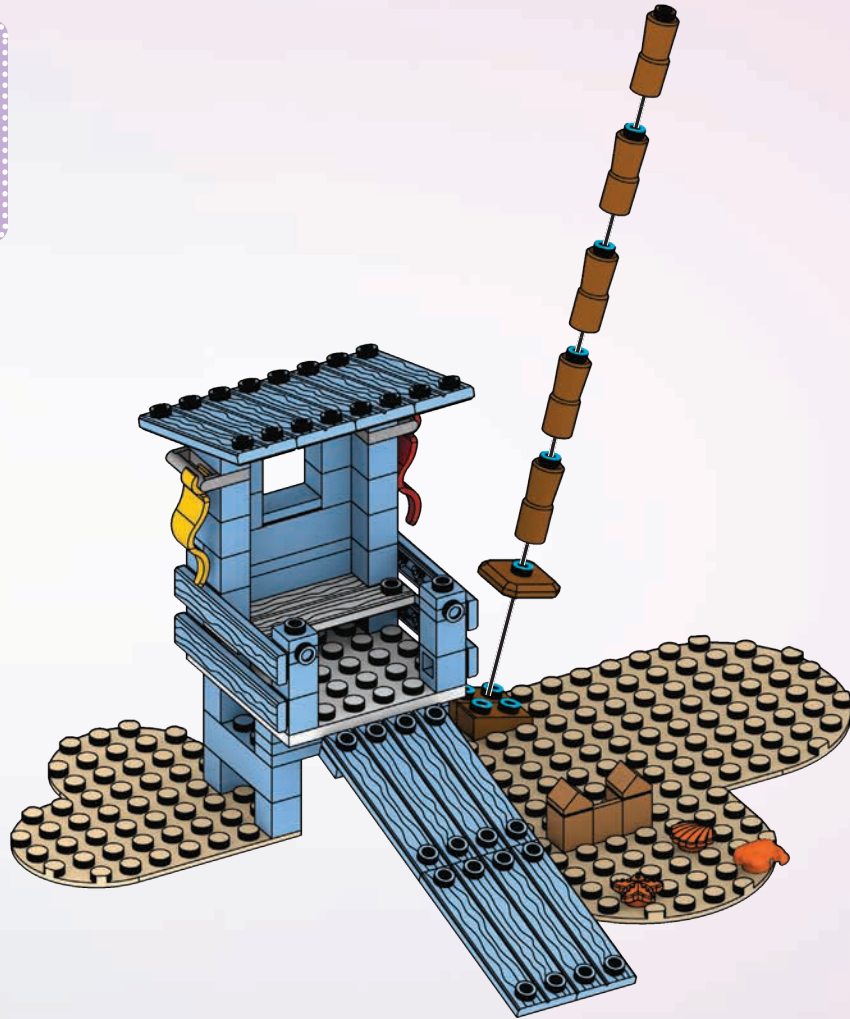

23



2x



1x



1x



4x

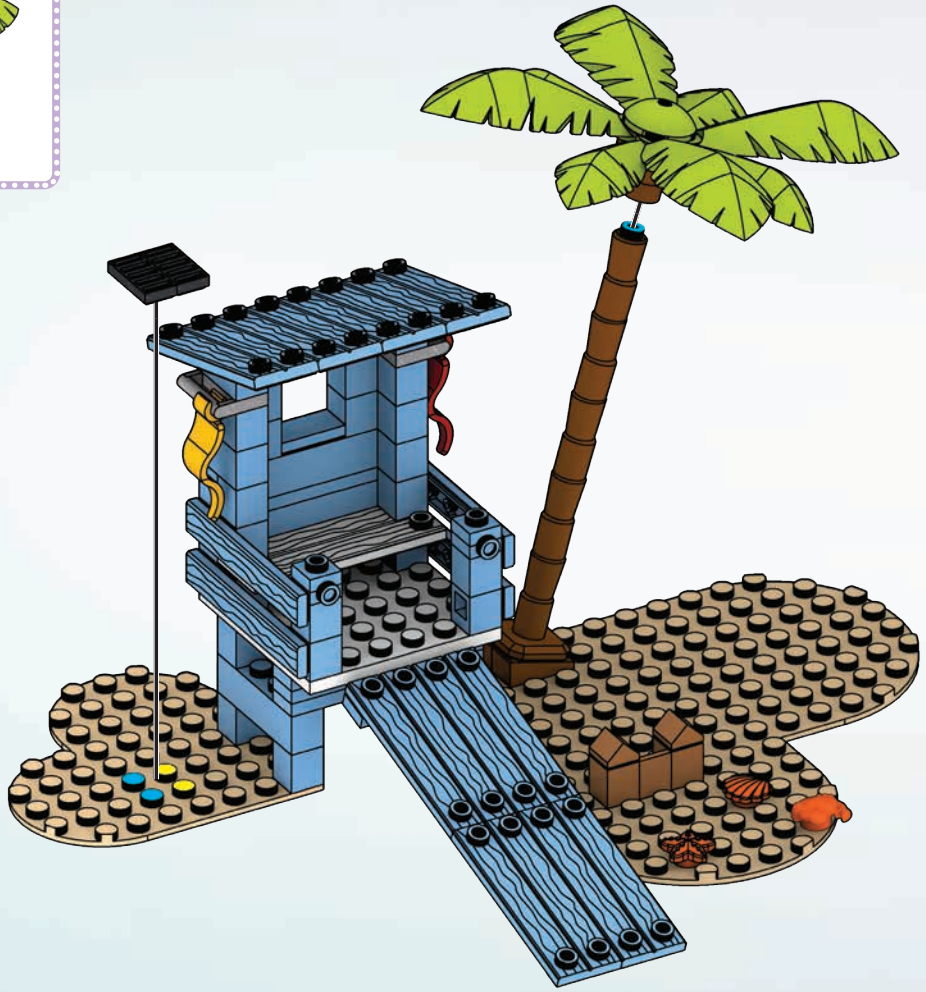
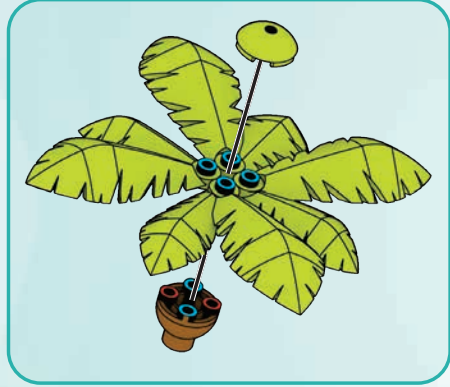

24



4x



1x

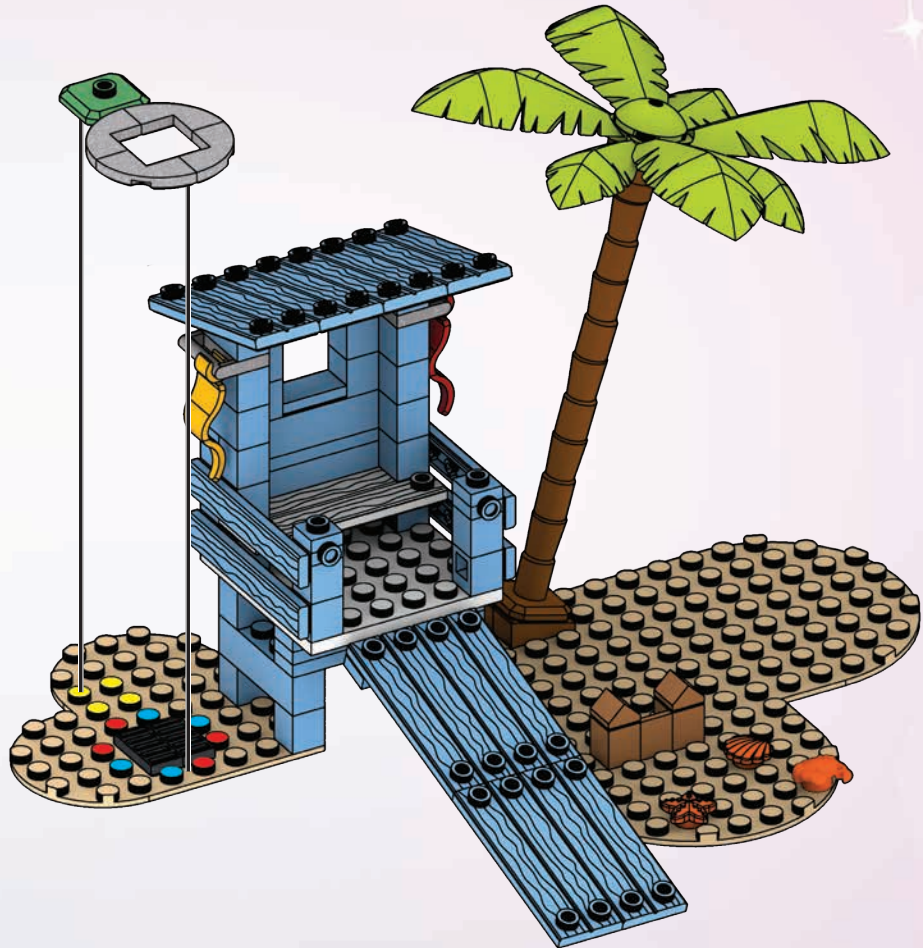

25

- 1x [green dot]
- 1x [green bush]
- 1x [green square base]

- 1x [green L-shaped pin]
- 1x [green long pin]

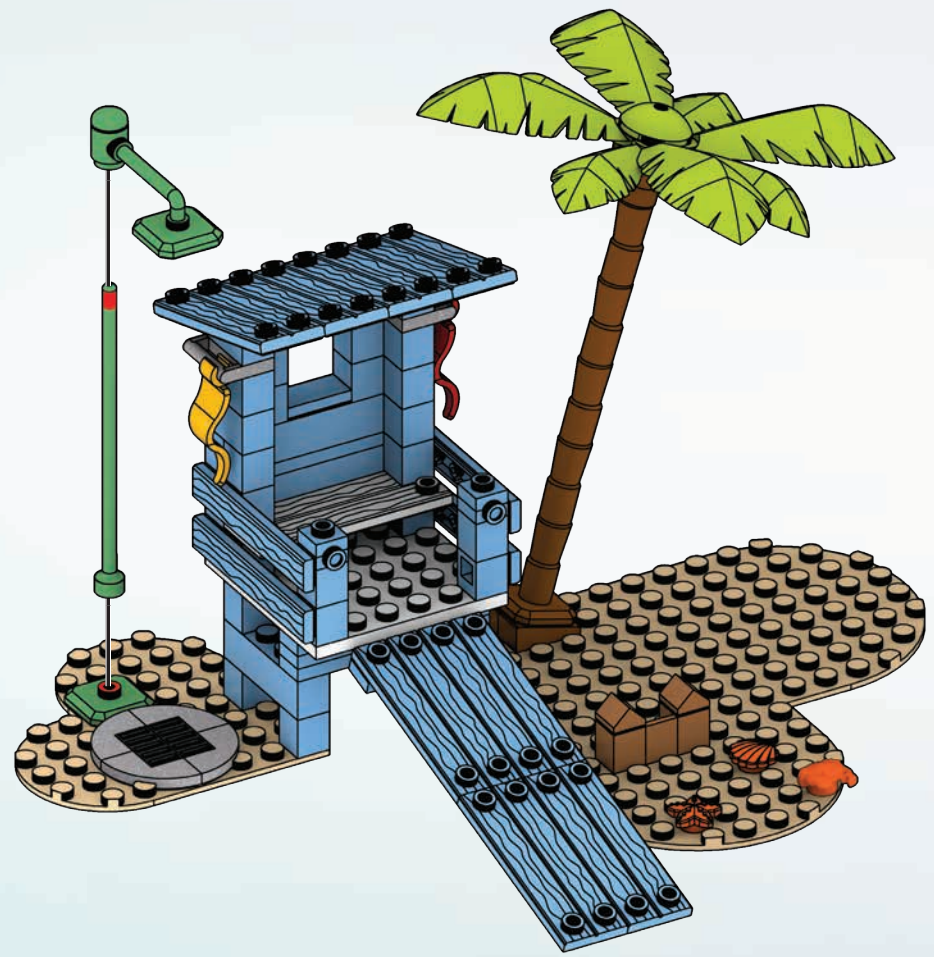
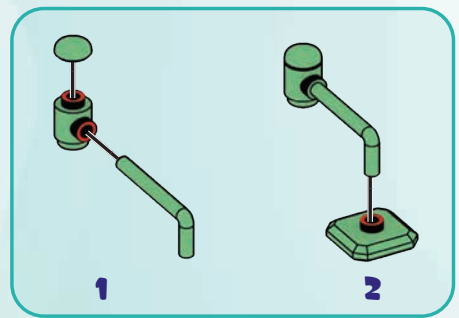

26



2x



1x



1x

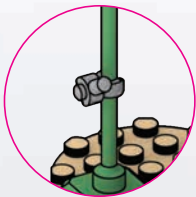
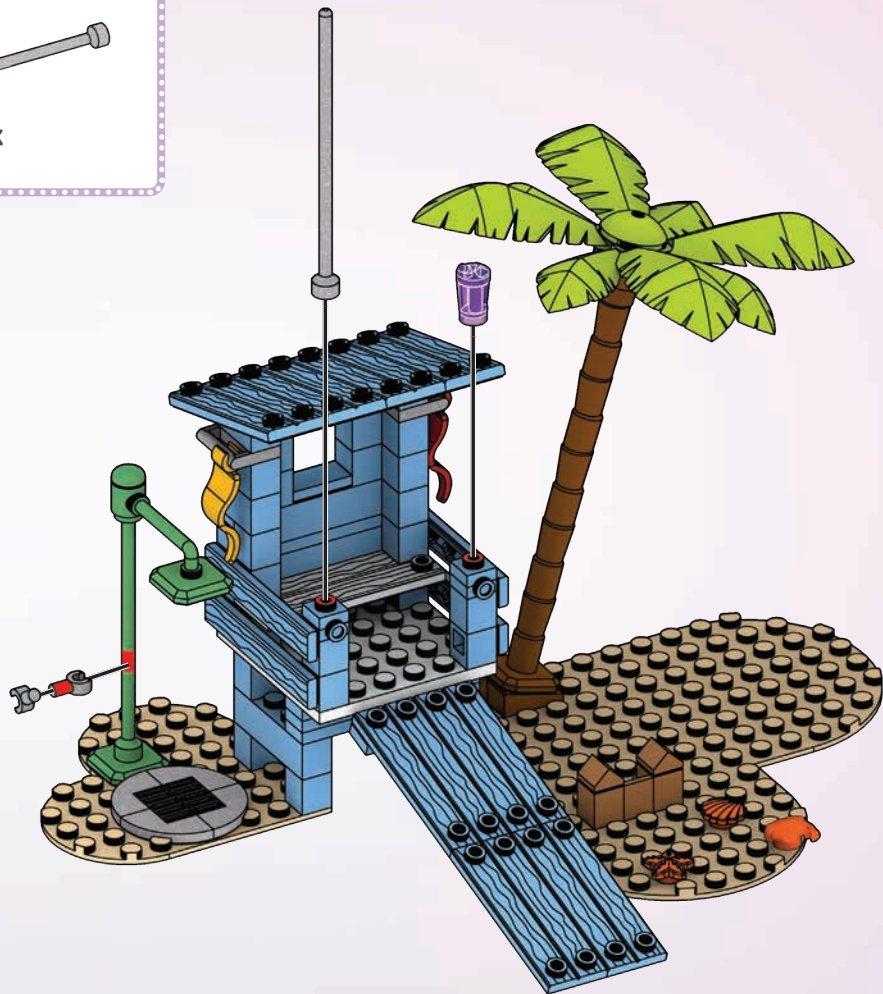

27



1x



1x



1x



1x

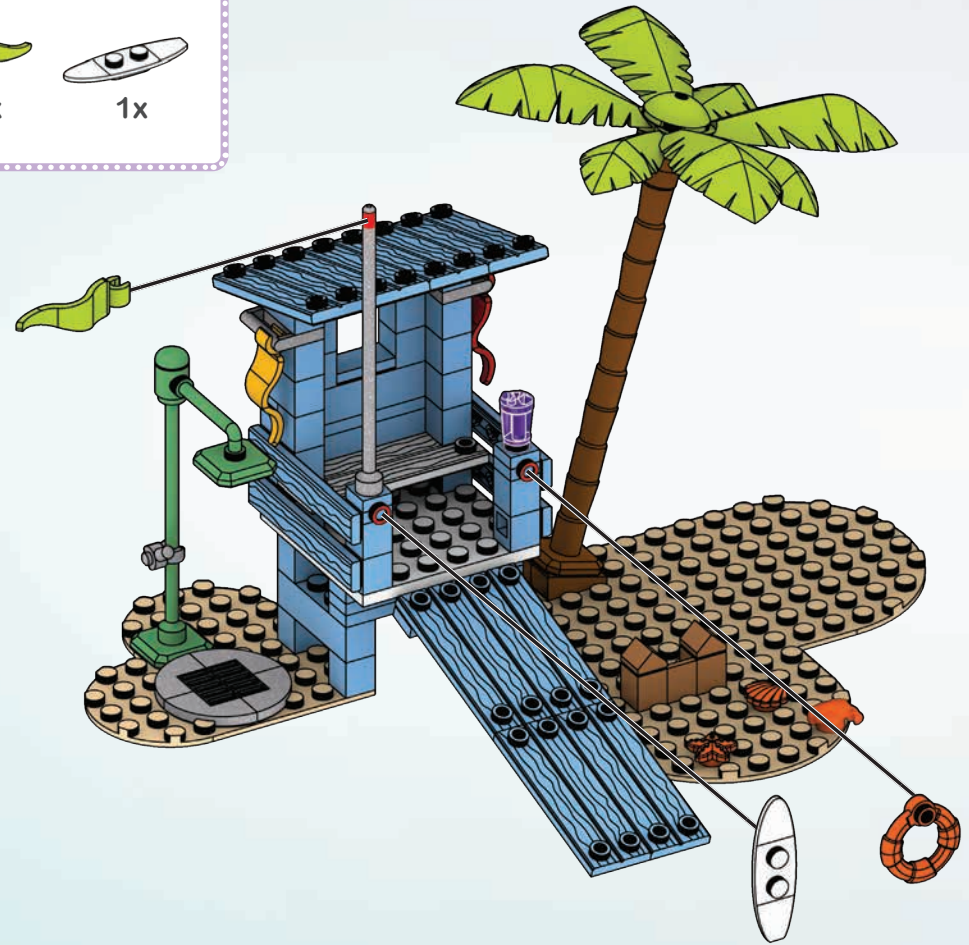

28



1x



1x

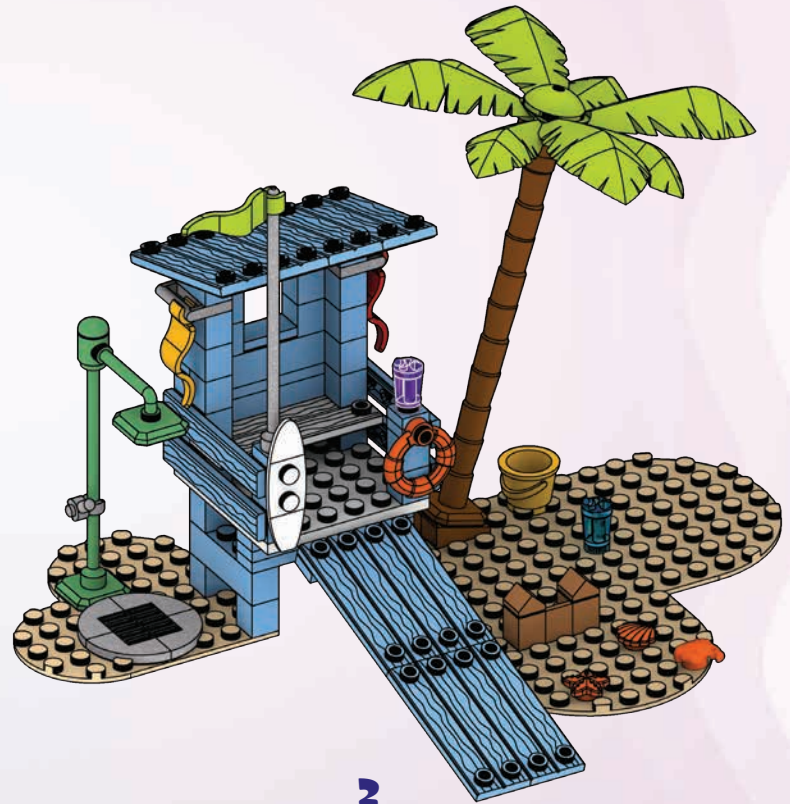
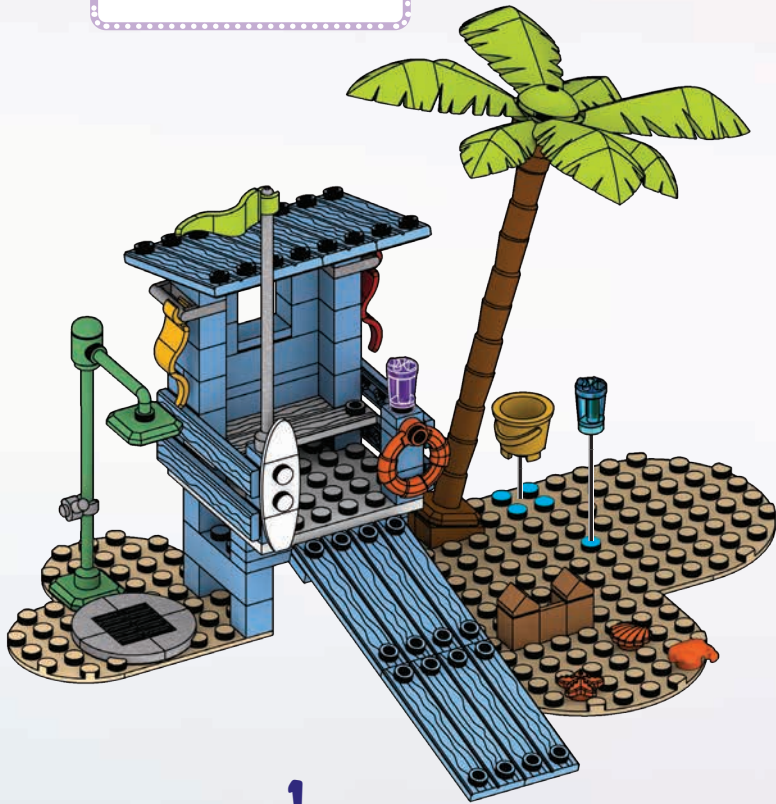



29

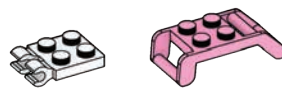

1x

1x

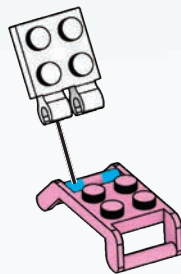

30



1x



1x

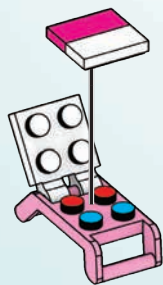

31



1x



1x

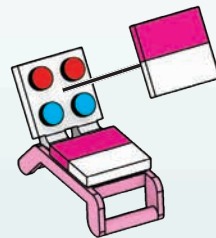

1



2

32

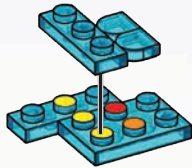
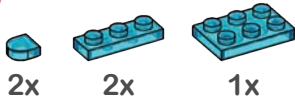

33

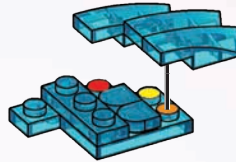

34

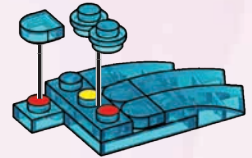

35

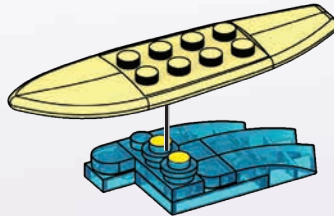
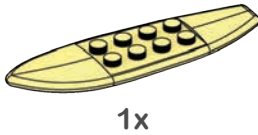

1

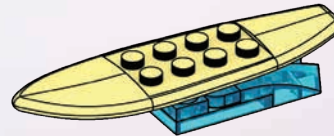

2

36



1x



1x



1x



1x

37



1x



1



2

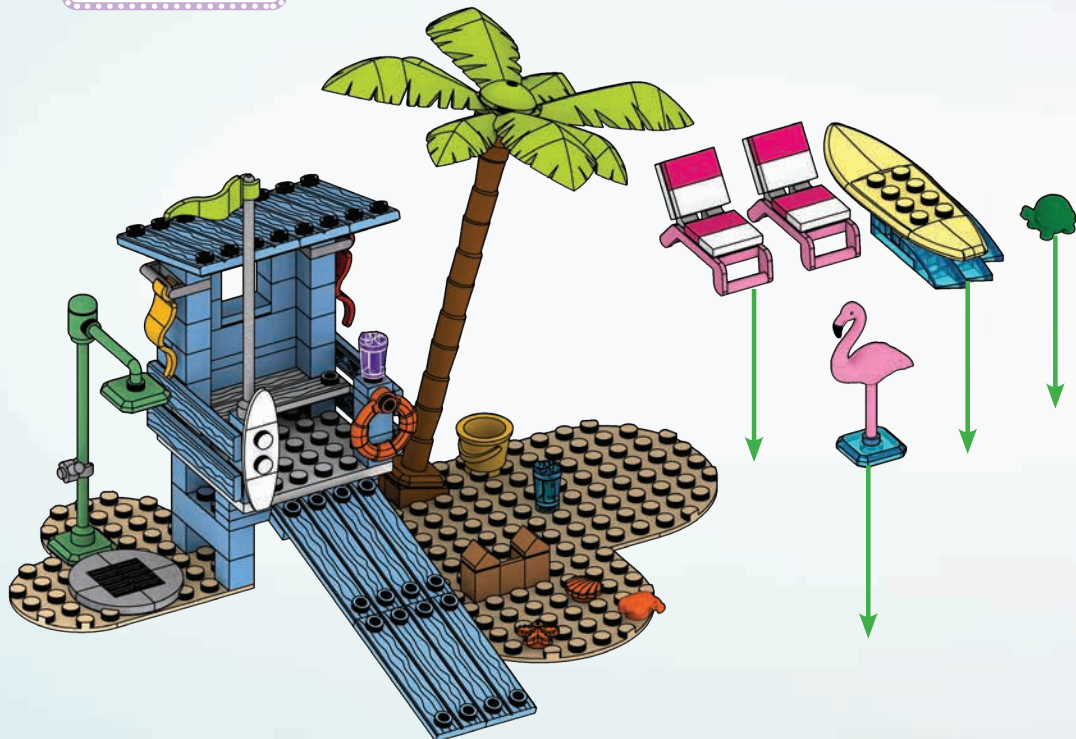

1

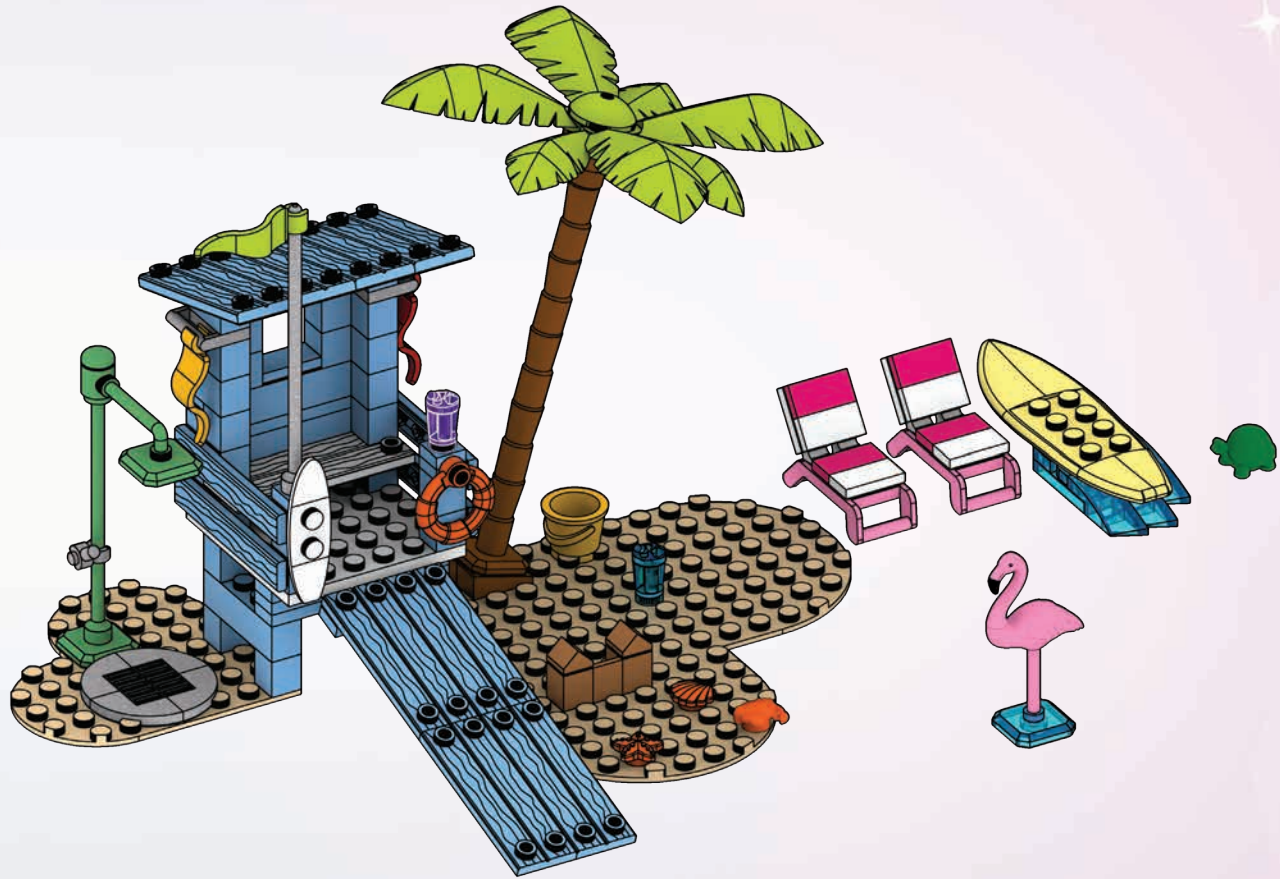

2



LET'S PLAY!
AMUSONS-NOUS!
ІАЖУГАРІ!-А ВРІНГАРІ!
LASS UNS SPIELEN!-НАЧІНАЕМ ІГРУ!



LET'S BUILD THE
DREAM BOAT™!

CONSTRUIRONS LE
BATEAU DE RÊVE!

¡VAMOS A CONSTRUIR EL BOTE
DE LOS SUEÑOS!

VAMOS CONSTRUIR O BARC
DOS SONHOS!

DAS TRAUMBOOT BAUEN!

ПОСТРОИМ ЛОДКУ МЕЧТЫ!

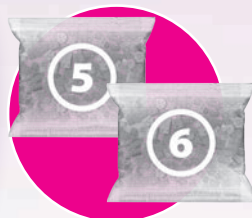

38



1x

1x

2x

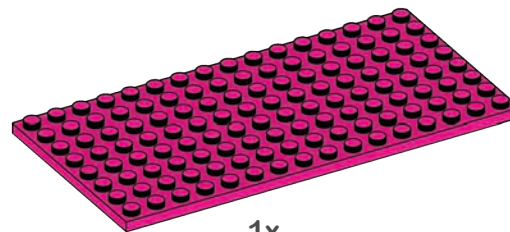

1x

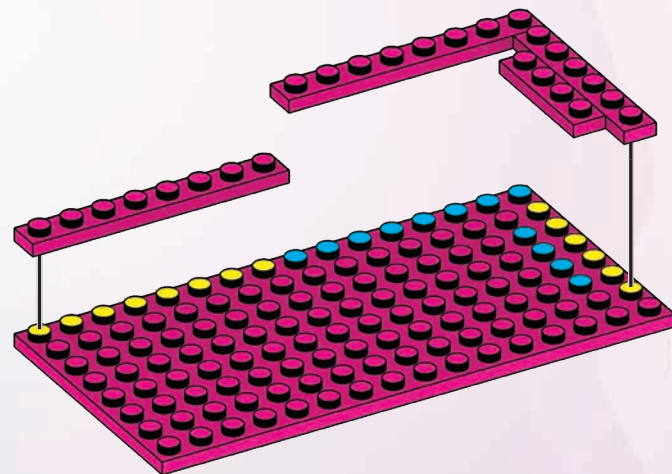

39



1x



1x

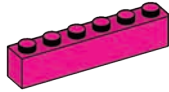

2x

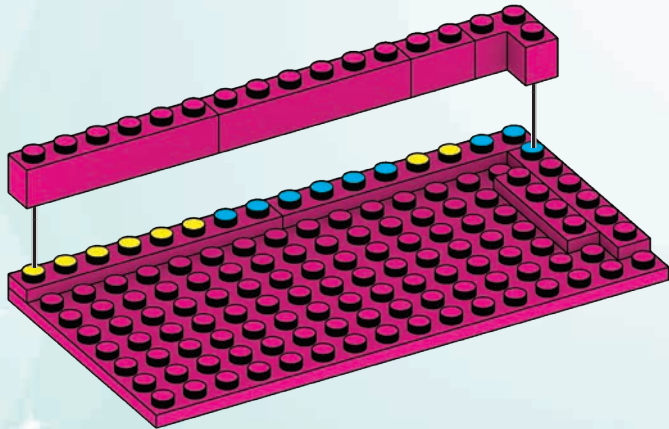

40



1x



1x



3x

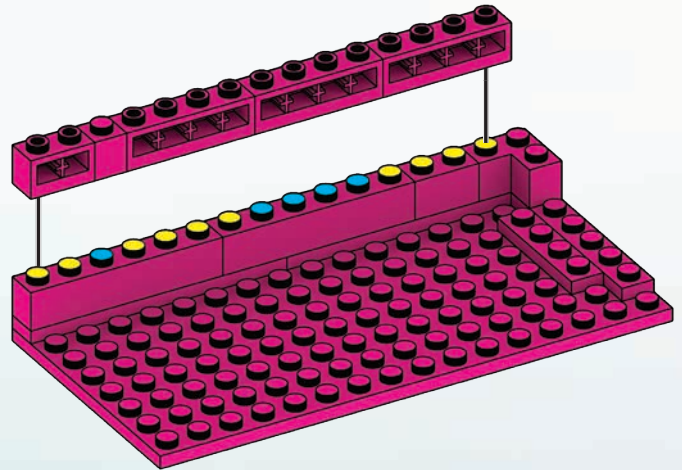

41

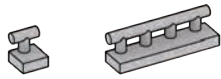

4x

1x

42

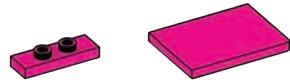

4x

1x

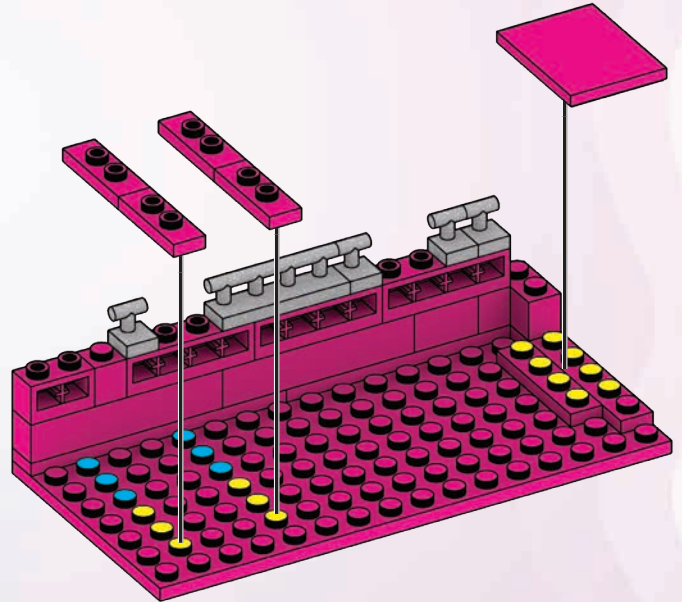
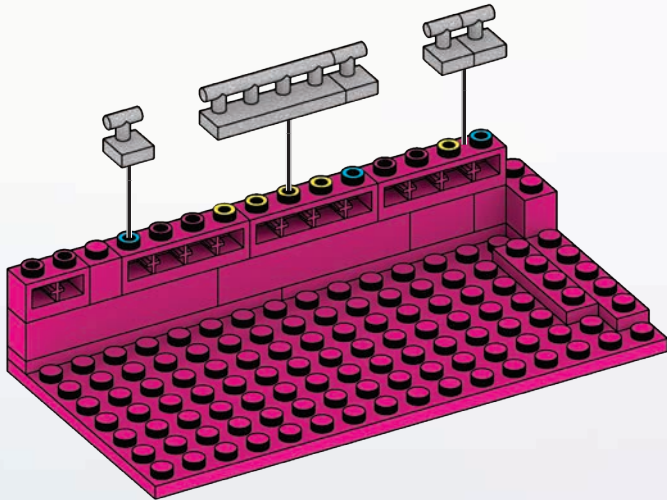

43



3x

44



2x



2x



2x

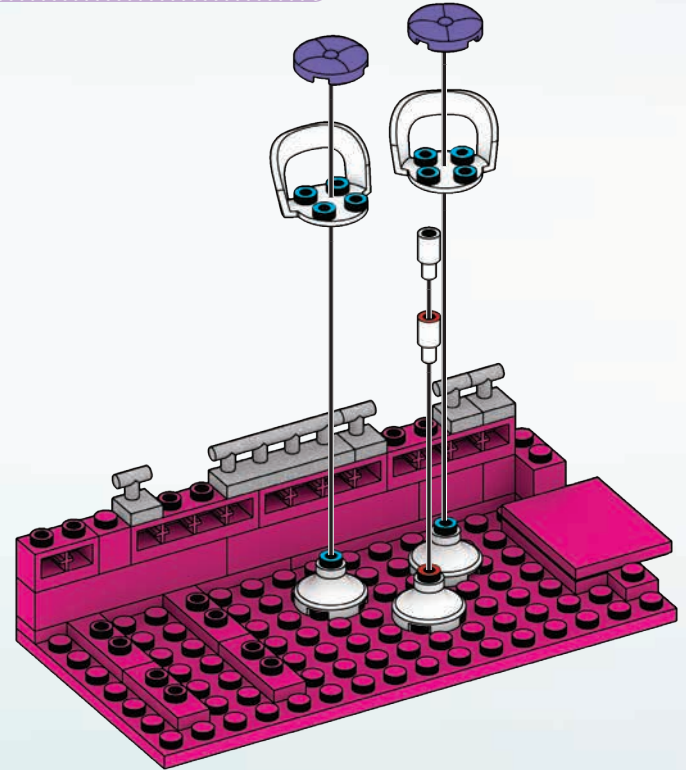
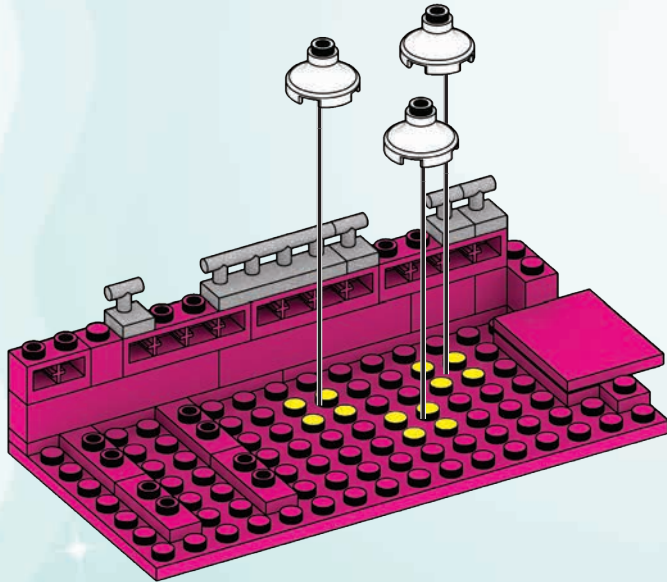

45



1x



1x

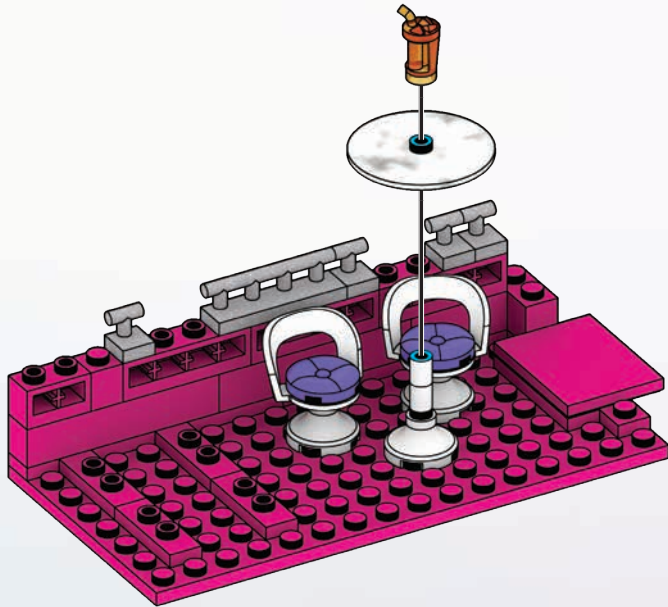

46



1x



2x

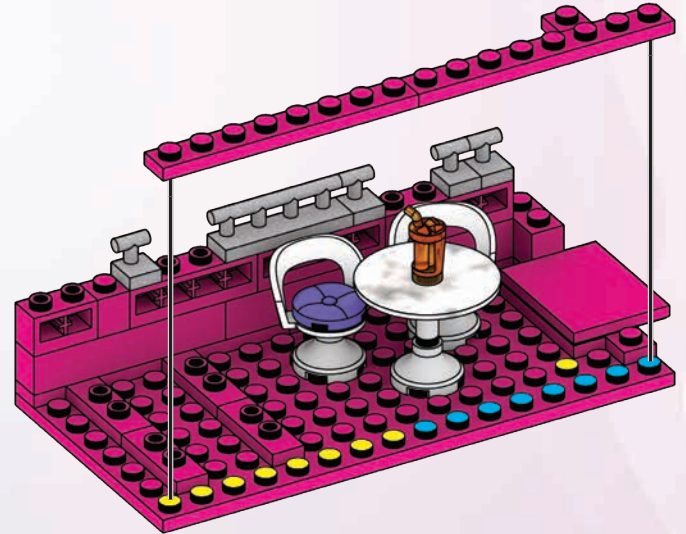

47



2x

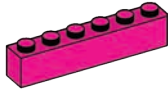

2x

48



1x



1x



3x

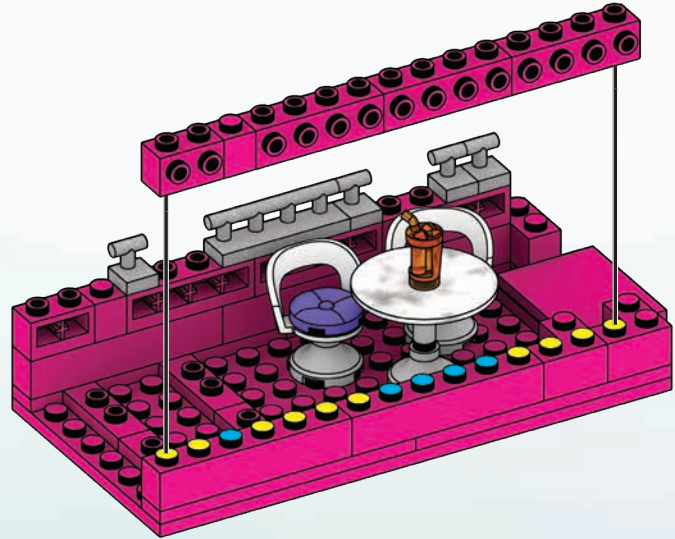
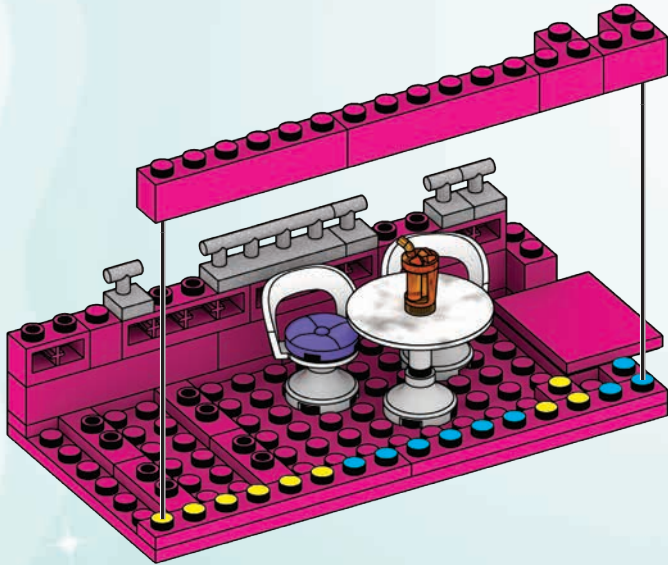

49

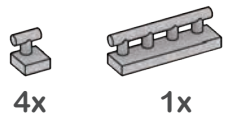

50

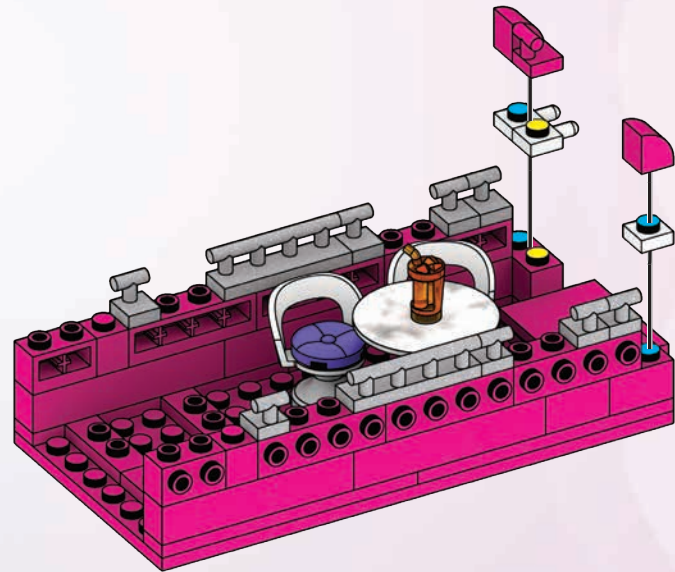
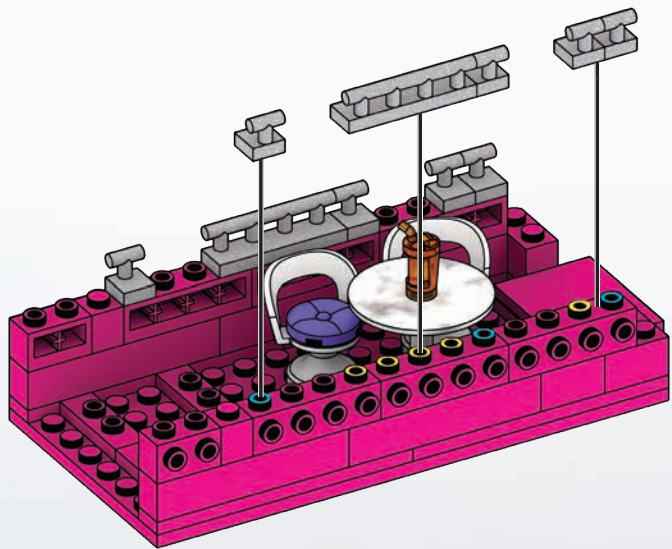
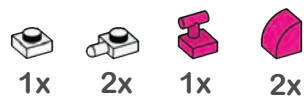

51

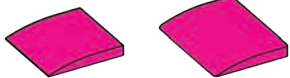

2x

6x

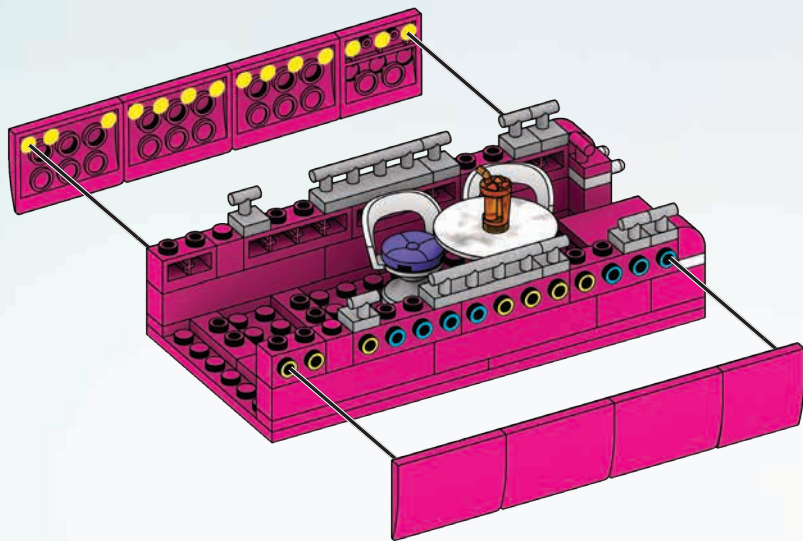

52



1x

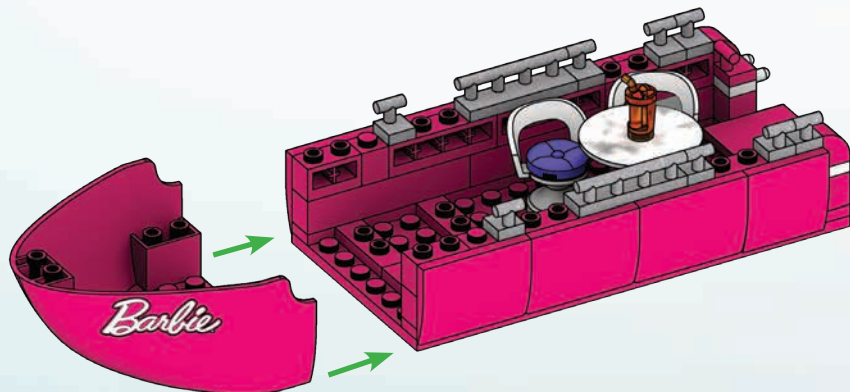

53



1x



2x



1x

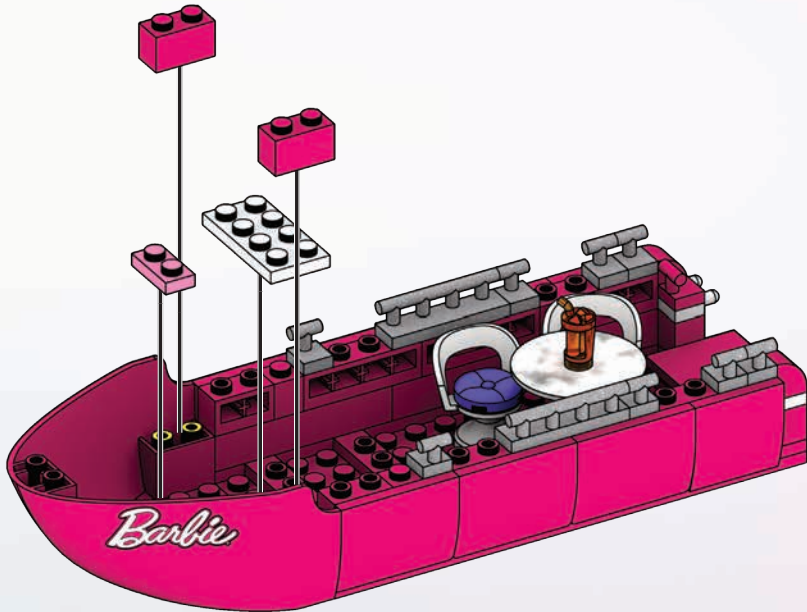

54



2x

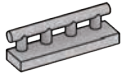

2x

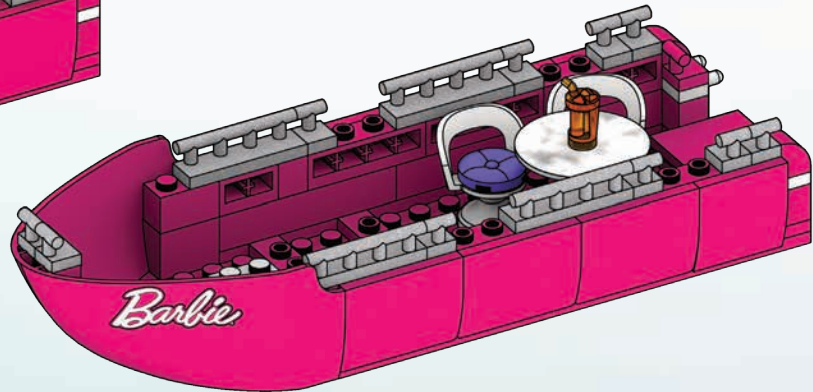
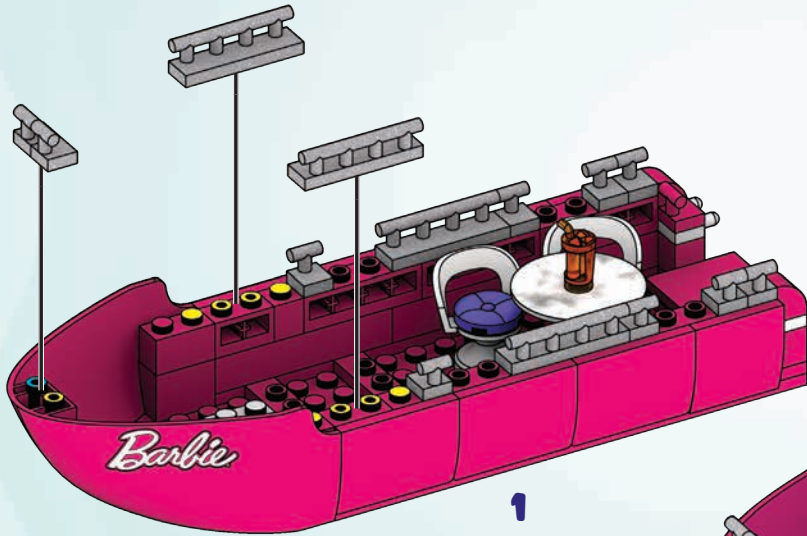

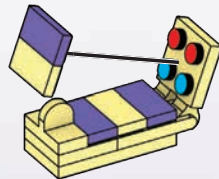
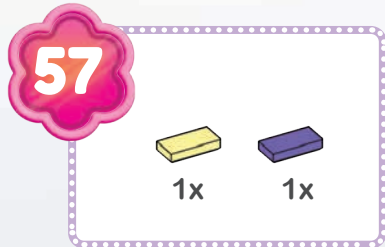
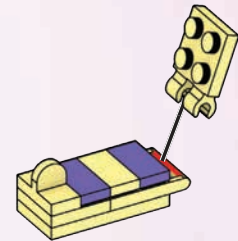
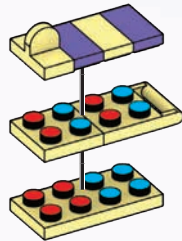
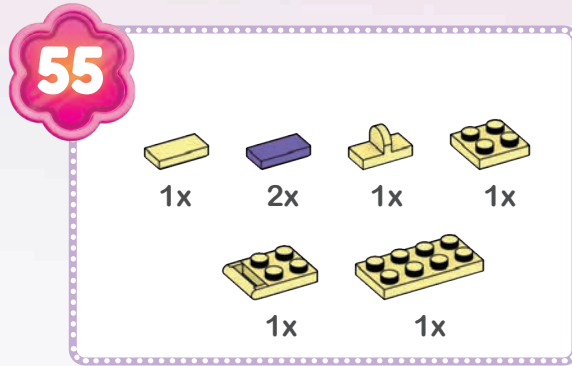

1

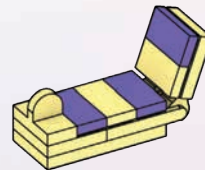

2

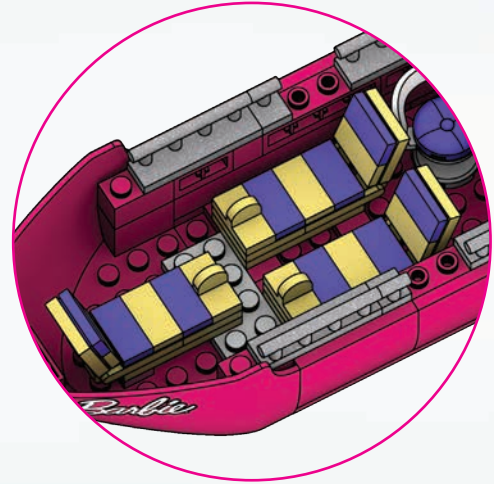
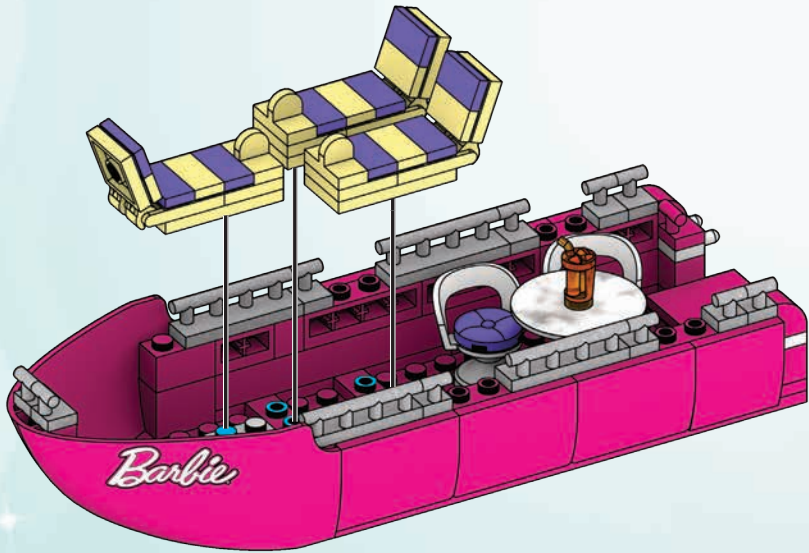

59

2x



1x



4x

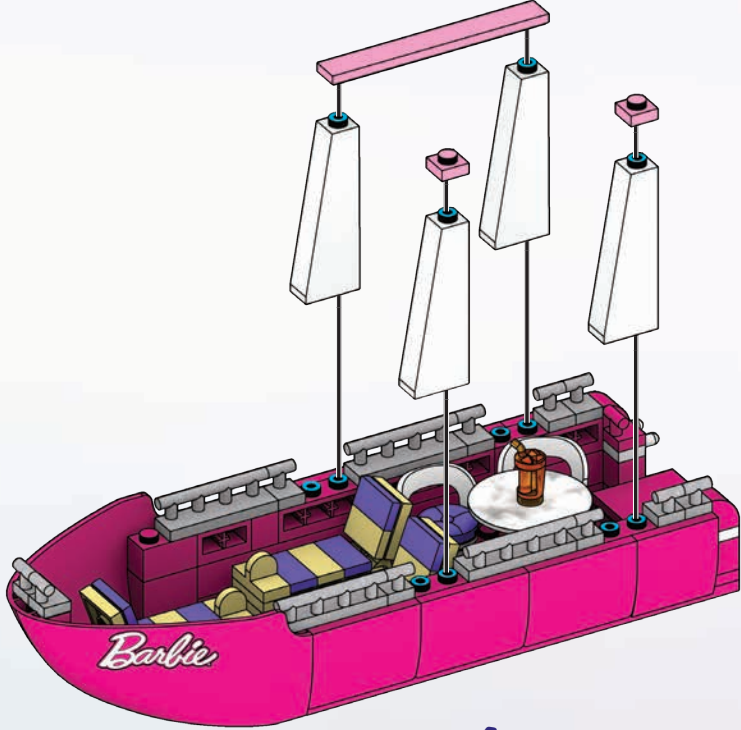

1



2

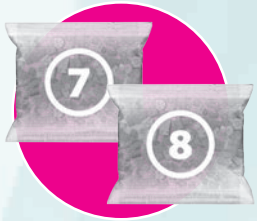

60

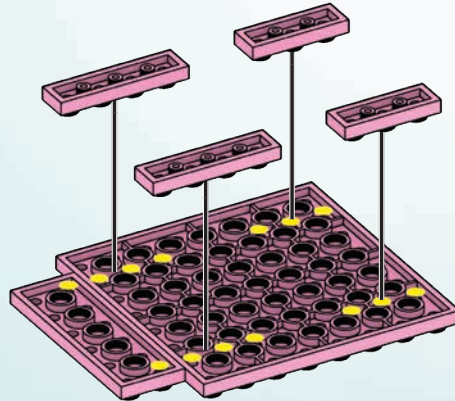
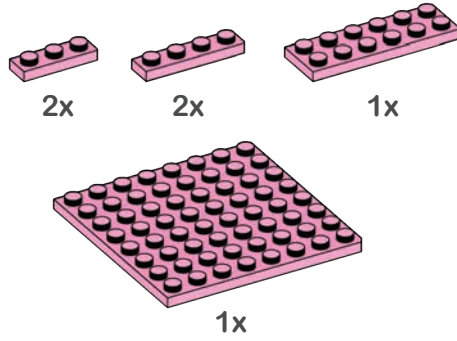

1

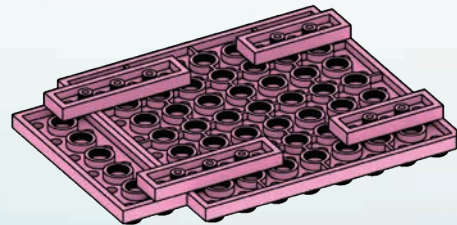

2

61

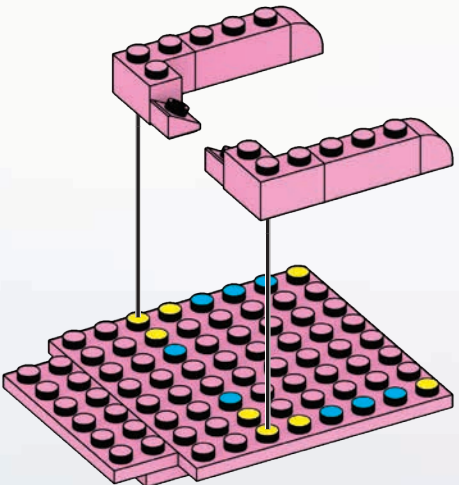
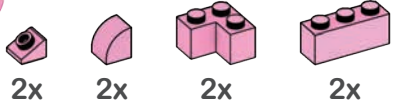

62

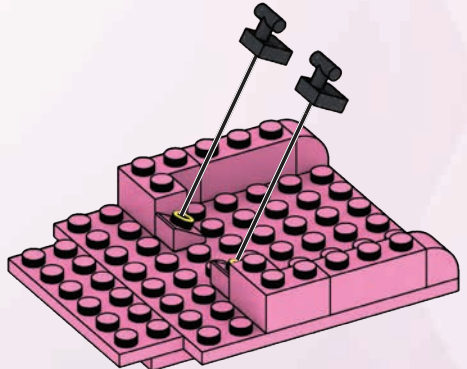

63



2x

1x

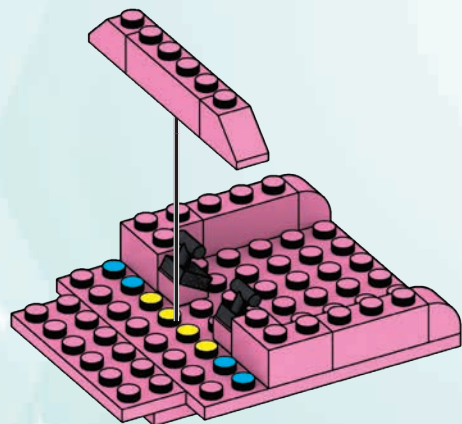

64



2x

1x

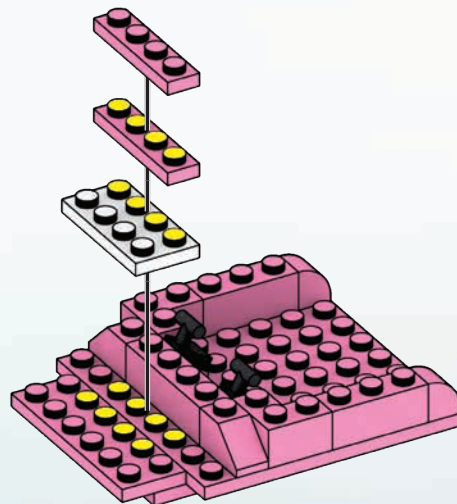

65



1x



1x



2x

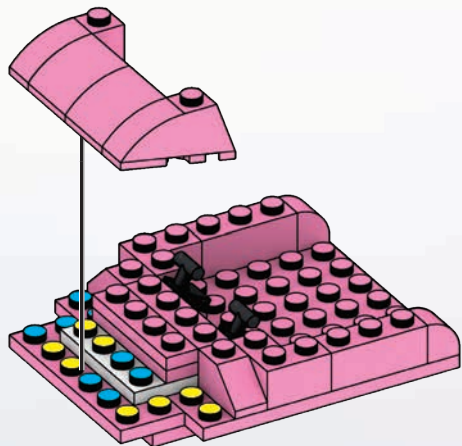

66



1x

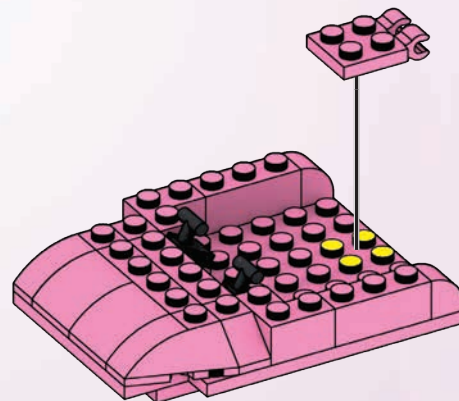

67



2x



1x



1x

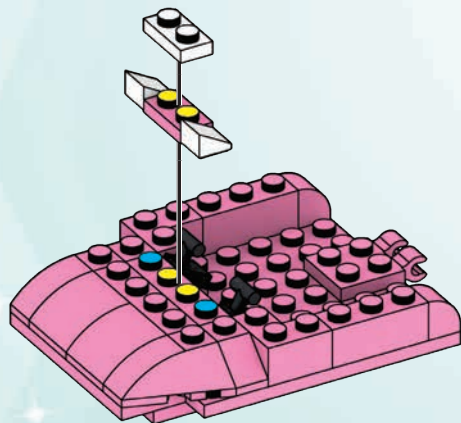

68

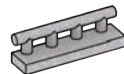

2x

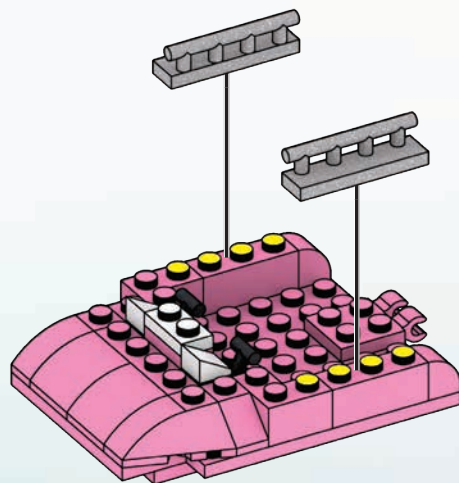

69

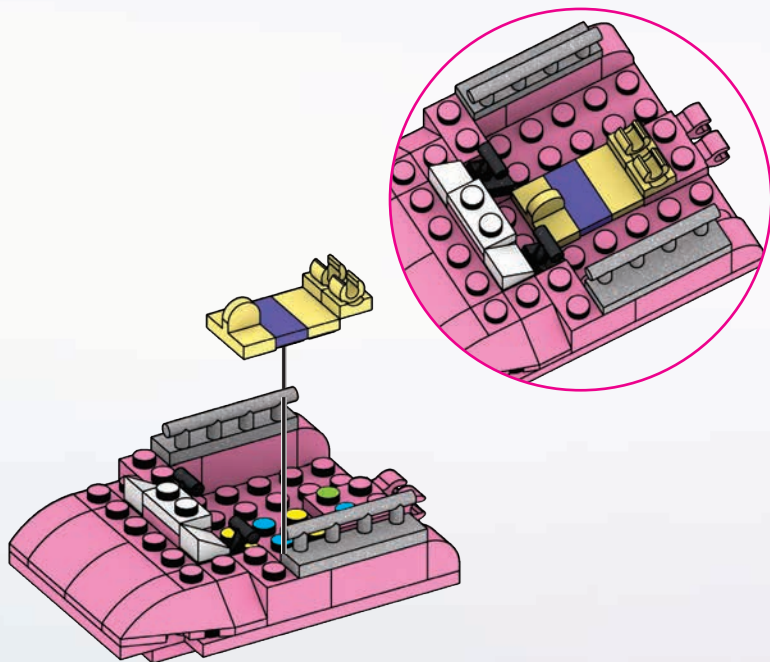
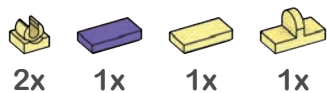

70

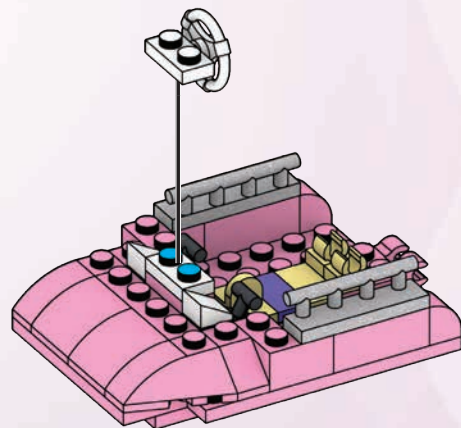
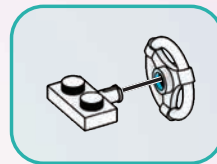
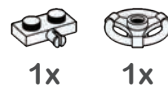

71



1x

72



1x



1x



1x

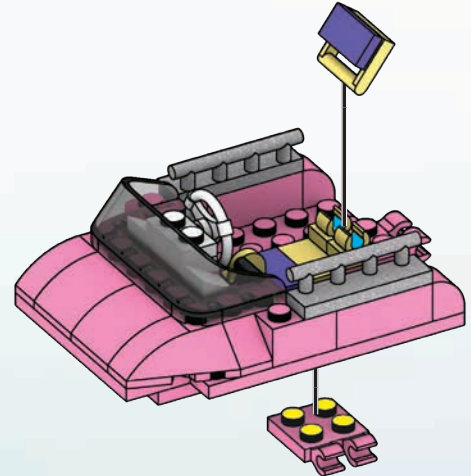
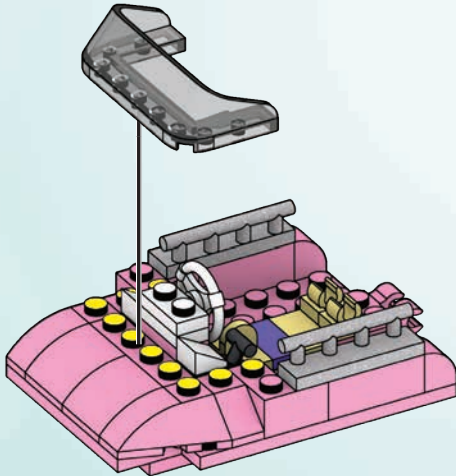
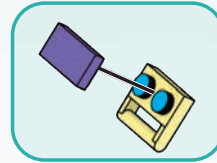

73



1x

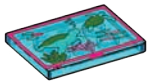

1x



1

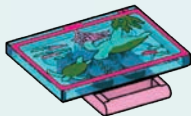

2

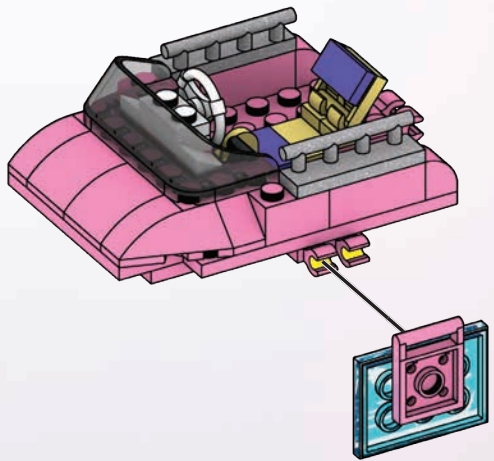

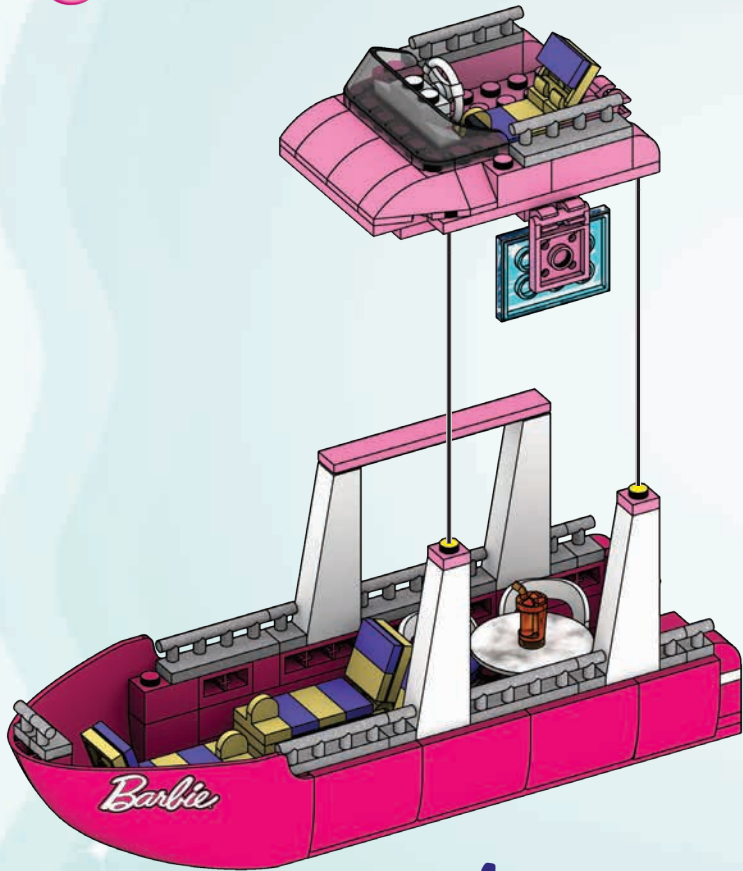

1

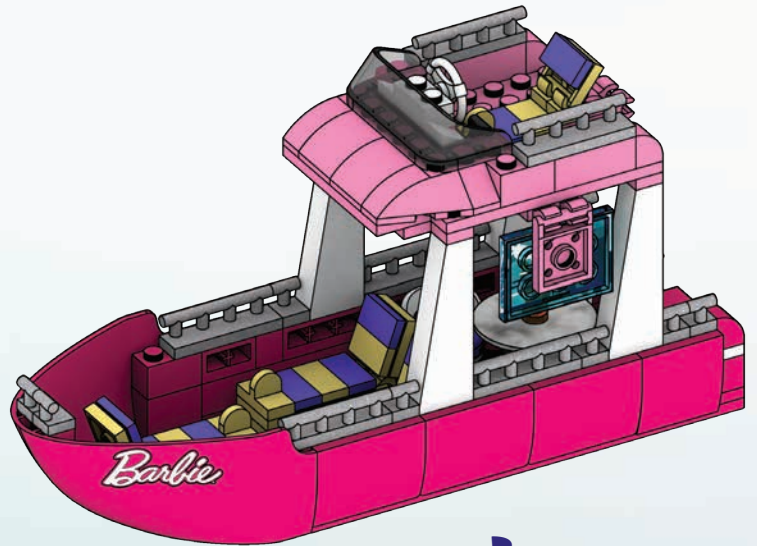

2

75



1x

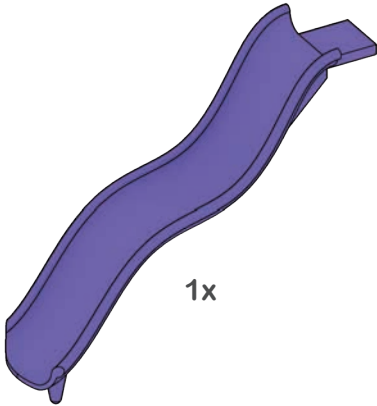

1x

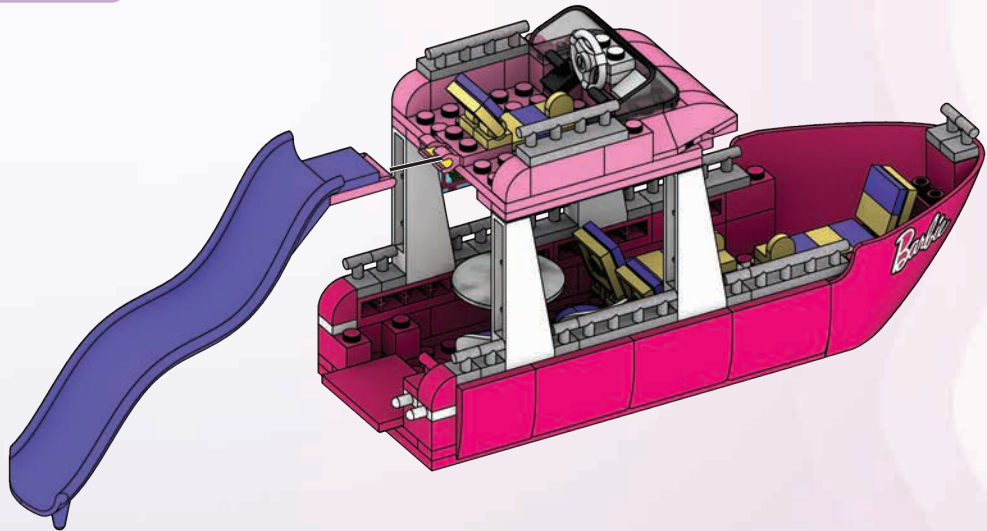
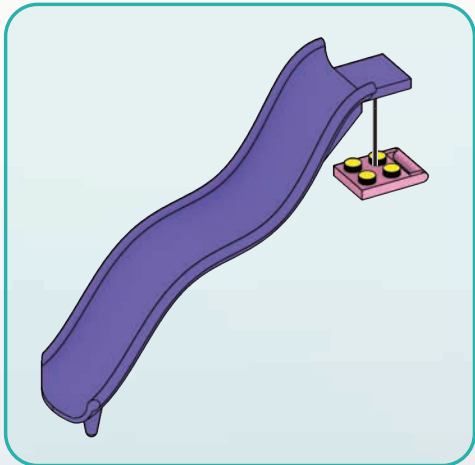

76



2x



2x

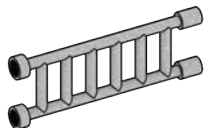

1x

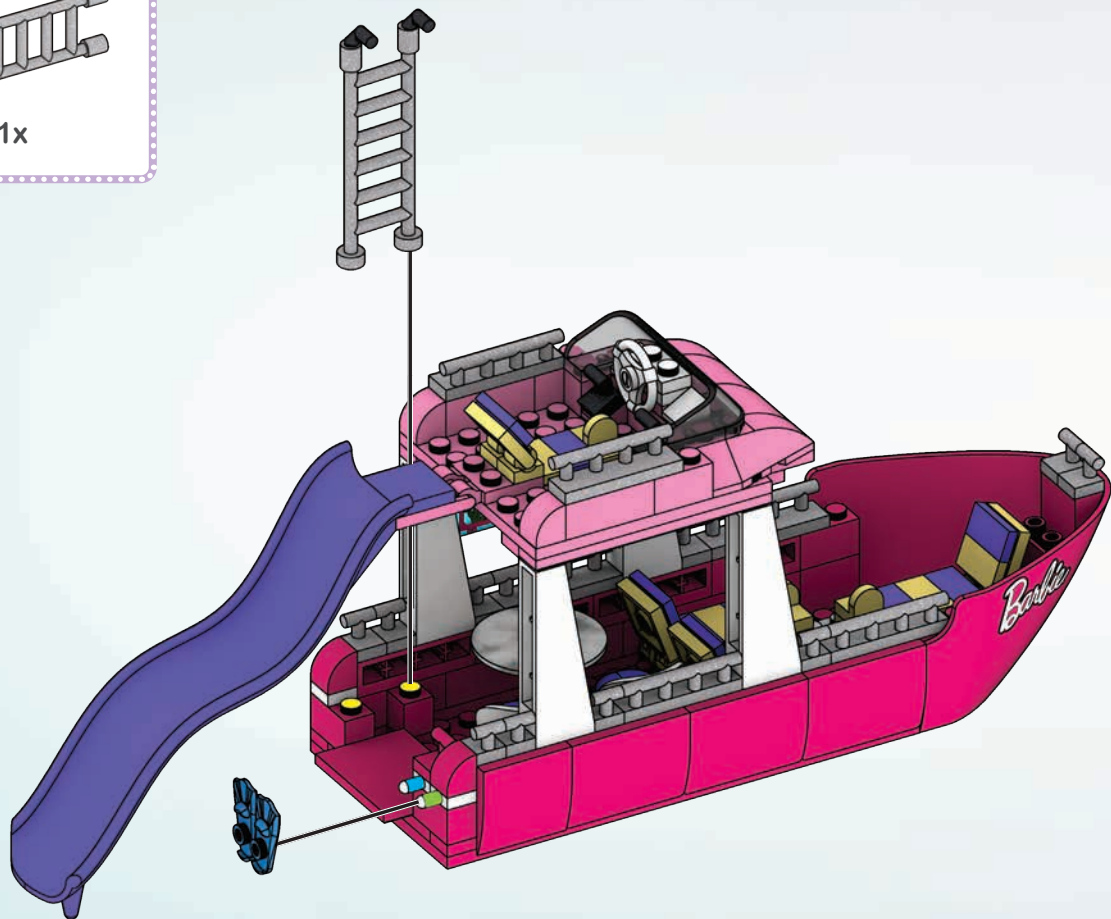
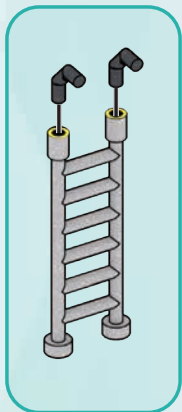

1

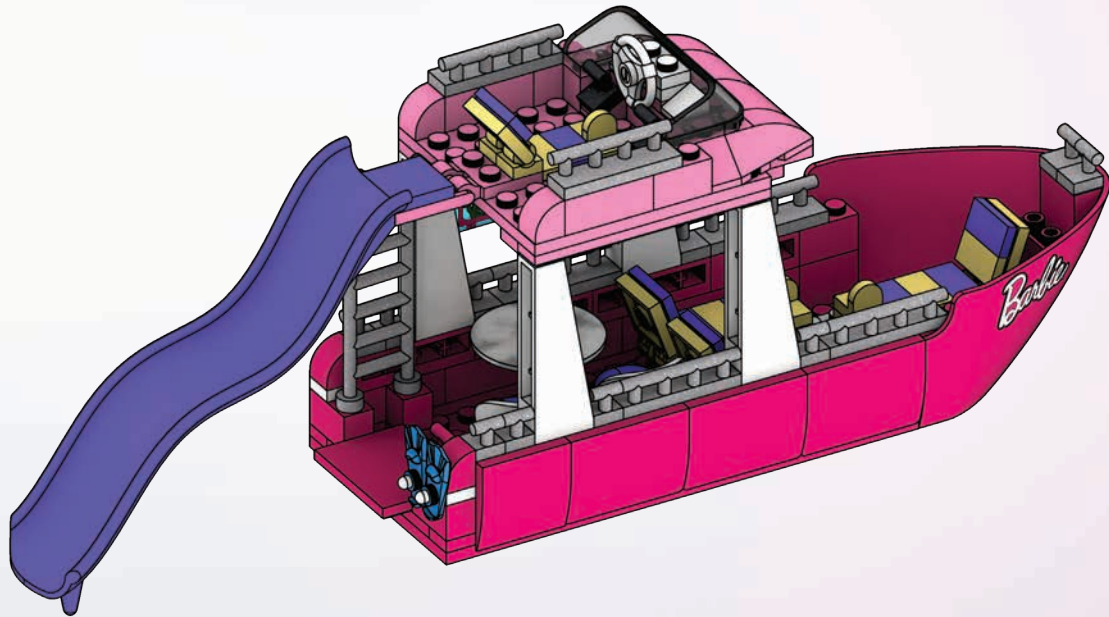

2

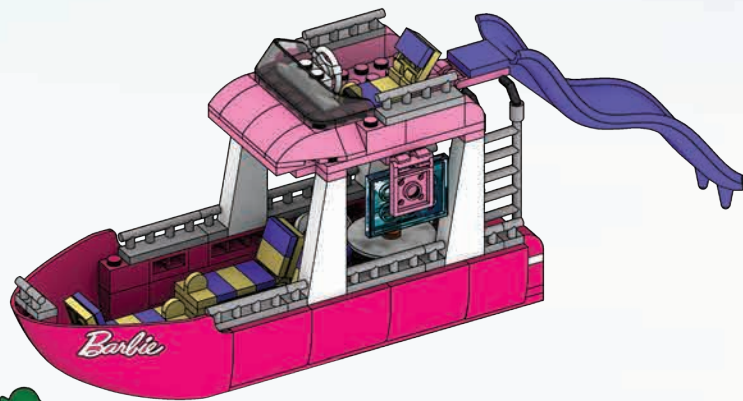
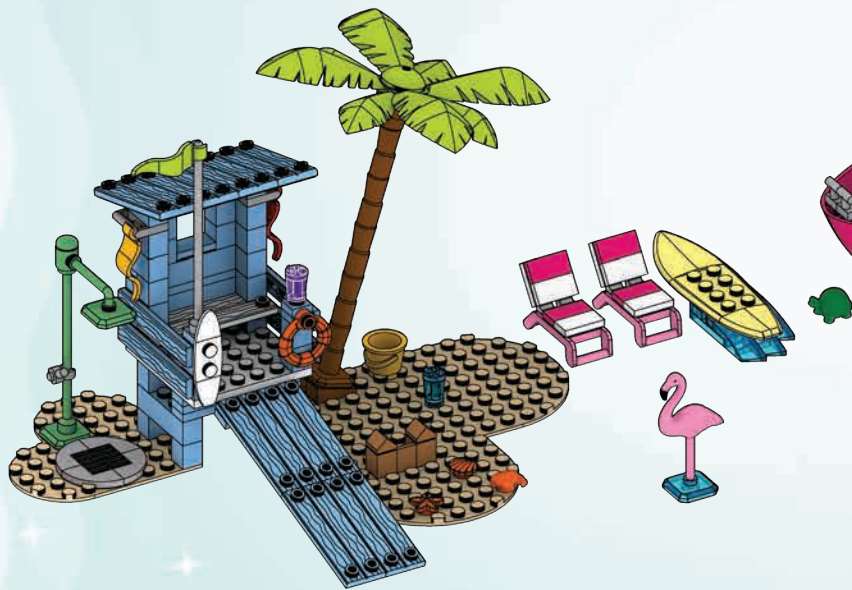

2x AM74397E	1x AM75173BOR	1x AM15485VL	2x AM76052MM	4x AM18667APG	2x AM73433GX	3x AM72908E	2x AM72909E	2x AM72957AMP
1x AM75332AXT	2x AM77901VL	2x AM07659ATC	2x AM01140E	4x AM22501ATC	2x AM72000APG	1x AM77377BMG	3x AM03773CS	1x AM19413BOR
2x AM01113AAV	2x AM19999CS	2x AM07659ASX	1x AM73035AAV	4x AM22501E	1x AM72000I	1x AM77377BMG	1x AM03773CS	1x AM19649BOR
2x AM17062APG	6x AM77574I	2x AM01086VL	1x AM73035KF	11x AM22501AMP	1x AM72000CS	1x AS-HPN79-03	2x AM18328E	4x AM74298ATC
3x AM76204AAV	1x AM15486ATC	10x AM01086I	1x AM73035KC	1x AM22501I	2x AM01322ASX	1x AM81384E	1x AM18328I	2x AM01314AAV
1x AM75172BOR	10x AM15486APG	2x AM01086I	2x AM80573MY	7x AM22501CS	2x AM17502ATC	1x AM73974BYE	3x AM18328CS	2x AM01314ASX
1x AM75171BOR	2x AM15486MM	4x AM07629I	2x AM80573I	2x AM09393I	3x AM09013ATC	4x AM17153I	2x AM18328ASX	2x AM16384ASX
2x AM03328ASX	2x AM72001ASX	1x AM80722AXT	4x AM81861CS	2x AM09393ASX	1x AM73009MY	3x AM17153ATC	2x AM18328ASX	1x AM18776ASX
1x AM03328E	2x AM17127E	5x AM78953MY	1x AM79679BBG	1x AM09393E	2x AM73009AXT	3x AM17153ATC	3x AM18329CS	1x AM18775ASX
1x AM03328ATC	2x AM17127I			1x AM18221E	1x AM73009AAV	2x AM17153ASX	2x AM18329ASX	



1x AM03772AAV



1x AM76521ASX

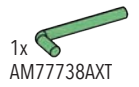

1x AM77738AXT



1x AM81848MY



1x AM81883ASX



1x AM16450BYE



1x AM16450BBG



1x AM16450AMC



2x AM81484ASX

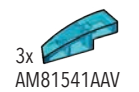

3x AM81541AAV



1x AM72051E

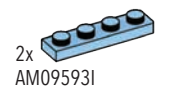

2x AM09593I

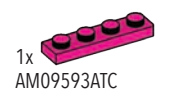

1x AM09593ATC

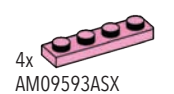

4x AM09593ASX

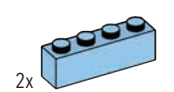

2x AM01087I

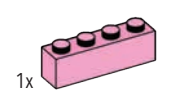

1x AM01087ASX

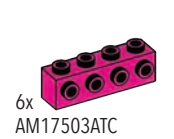

6x AM17503ATC



3x AM09493CS



2x AM09493E

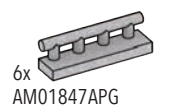

6x AM01847APG



1x AM72904AKQ

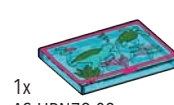

1x AS-HPN79-02



1x AM72025ATC



2x AM80980ATC



6x AM81605ATC



2x AM73184ASX

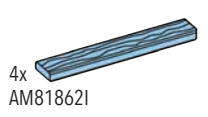

4x AM81862I

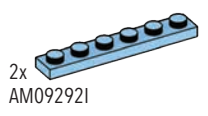

2x AM09292I

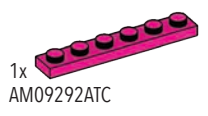

1x AM09292ATC

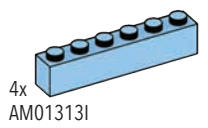

4x AM01313I

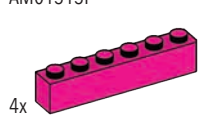

4x AM01313ATC

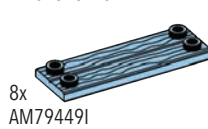

8x AM79449I

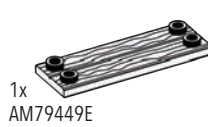

1x AM79449E

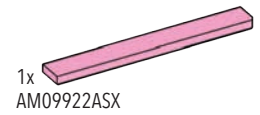

1x AM09922ASX

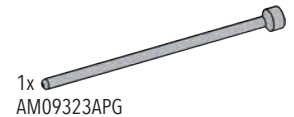

1x AM09323APG

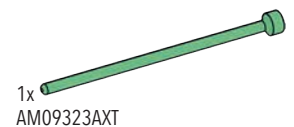

1x AM09323AXT

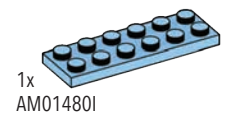

1x AM01480I

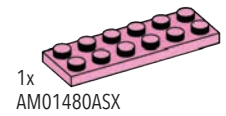

1x AM01480ASX



4x AM81847BBG



1x AM81341AGY

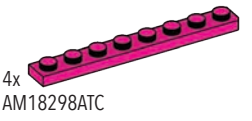

4x AM18298ATC

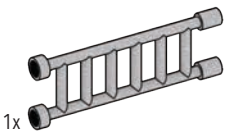

1x AM80741APG

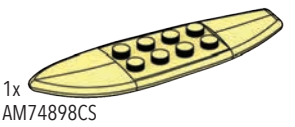

1x AM74898CS

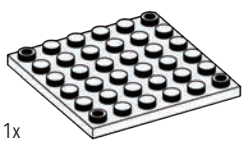

1x AM74681E



4x
AM03767E

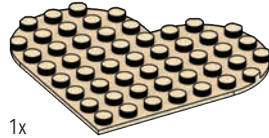

1x
AM81104BTN

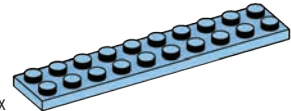

1x
AM09923I

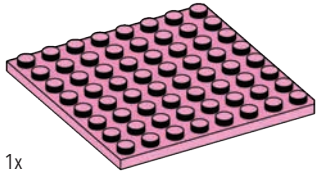

1x
AM18556ASX

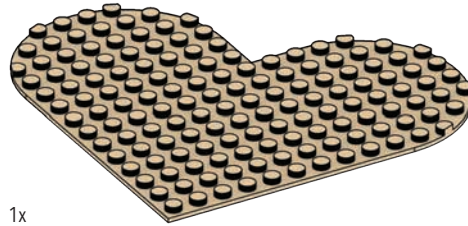

1x
AM81105BTN

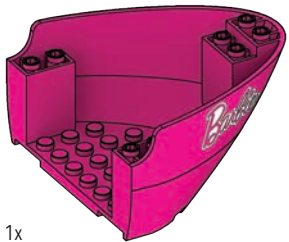

1x
AS-HPN79-01

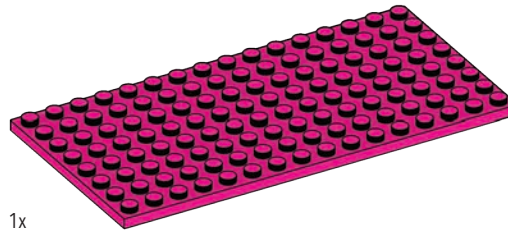

1x
AM18567ATC

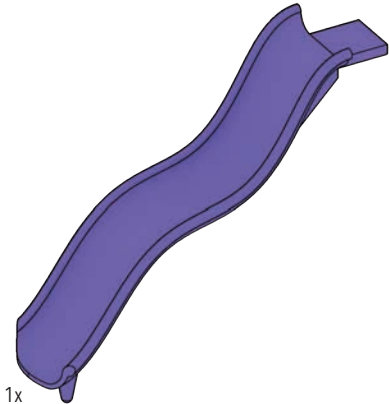

1x
AM81497AMP



1x
FIG-HPN79-A



1x
AM81872FM



1x
FIG-HPN79-B



1x
AM81842ATC



1x
FIG-HPN79-C



1x
AM81873ATC

Missing pieces? Pièces manquantes?

¿Partes faltantes? • Perdeu peças?
Fehlen Teile? • Не хватает деталей?

support.megabrands.com

Mattel Europa B.V., Gondel 1, 1186 MJ Amstelveen, Nederland.
Mattel U.K. Limited, The Porter Building, 1 Brunel Way, Slough
SL1 1FQ, UK. Mattel France, Parc de la Cerisaie, 113/9 allée des
Fleurs, 94260 Fresnes Cedex. N° Cristal 0969 36 99 99 (Numéro
non surtaxé) ou www.lesjouetsmattel.fr Mattel Belgium, Trade
Mart, Atomiumsquare, Bogota 202 - B 275, 1020 Brussels, Gratis
nummer België: 0800 - 16 936 - Gratis nummer Luxemburg: 800
- 22 784 - Gratis nummer Nederland: 0800 - 262 88 35. Deutsch-
land: Mattel GmbH, Solmsstraße 83, D-60486 Frankfurt am Main.
Schweiz: Mattel AG, Kirchstrasse 24, CH-3097 Liebefeld. Österreich:
Mattel Ges.m.b.H., Campus 21, Liebermannstraße A01 404, A- 2345
Brunn/Gebrige. Mattel Italy Srl, Via Turati 4, 20121 Milano, Italy.
Servizio assistenza clienti: Customersrv.it@mattel.com - Numere
verde 800 11 37 11. Mattel España, S.A. Arbau 200 pl. 9, 08036
Barcelona. c.service.spain@mattel.com Tel. +34 933 06 79 00 <http://www.service.mattel.com/es>. Mattel East Asia Ltd., Room 503-09,
North Tower, World Finance Centre, Harbour City, Tsimshatsui, HK, China. Tel.: (852) 3185-6500. Dlimport & Diedardank
Oleh: Mattel Continental Asia Sdn Bhd. Level 19, Tower 3, Avenue 7, No. 8 Jalan Kerinci, Bangsar South, 59200 Kuala
Lumpur, Malaysia. Mattel South Africa (PTY) LTD, Office 102 13, 30 Melrose Boulevard, Johannesburg 2196. Dystyrbout:
Mattel Poland Sp. z o.o., Warsaw Trade Tower 34 p., ul. Chłódna 51, 00-867 Warszawa. Mattel Australia Pty. Ltd., 658 Church
St., Richmond, Victoria, 3121. Consumer Advisory Service - 1300 135 312. Mattel AEBE, Εθνικού Μαοαρίου 1, Κηφισό
Κ-2, ΤΚ 17561, Ποσειά Φάληρο. Mattel Oynacaklık Tic. Ltd. Şti. İczerköy Mah. Umut Sokak No: 10 - 12, Quick Tower
kat:2 İçkapı no:15 Ataşehir 34752, İstanbul, Türkiye. Tel: 0216 570 75 00. Импортёр/полномоченная организация: ООО
"МАТТЕЛ" Российская Федерация, 105120 Москва, 2-й Сыромятинский переулок 1; +7 495 287 79 39. Mattel Czech
Republic s.r.o., The Forum, Václavské nám. 19, 11000 Praha 1. Mattel, 333 Continental Boulevard, El Segundo, CA 90245,
USA. Consumer Services: 1-800-465-MEGA (6342). Mattel Canada Inc., Mississauga, Ontario L5R 3W2. Consumer Services:
You may call us free at/ Composez sans frais le 1-800-524-8697. Importador y distribuido por Mattel de México, S.A. de C.V.,
Miguel de Cervantes Saavedra No. 193, Pisos 10 y 11, Col. Granada, Alcañala Miguel Hidalgo, C.P. 11520, México, Ciudad
de México. R.F.C. MIME-920701-NB3. Tels: 59-05-51-00 Ext. 5206 ó 01-800-465-59-89. Mattel Chile, S.A., Avenida Americo
Vespucio 501-B, Quilicura, Santiago. Tel: 1230-020-6213. Servicio al consumidor Venezuela. Tel: 0-800-100-9123. Mattel
Argentina, S.A., Av. Libertador 1000, Piso 11 - Oficinas 109 y 111, Vicente López - Prov. Buenos Aires. Tel: 0800-666-3373.
Mattel Colombia, S.A., Calle 123#7-07 P.5, Bogotá. Tel.: 01800-710-2069. Mattel Perú, S.A., Av. Juan de Arona # 151, Centro
Empresarial Juan de Arona, Torre C, Piso 7, Oficina 704, San Isidro, Lima 27, Perú. RUC: 20425853865. Reg. Importador:
02350-12-JUE-DIGESA. Tel.: 0800-54744. E-mail Latinoamerica.servicio.clientes@mattel.com. Mattel do Brasil Ltda. - CNPJ
: 54.558.002/0001-20 - Rua Verbo Divino, 1488 - 2º - Andar - 04719-904 - Chácara Santo Antônio - São Paulo - SP - Brasil.
Serviço de Atendimento ao Consumidor: fone 0800 575 0780. E-mail: sac.matteldobrazil@mattel.com.

⚠ WARNING: Small parts, ADVERTENCIA: PELIGRO DE ATRAGANTAMIENTO. Juguete no recomendado para menores de 3 años, porque contiene piezas pequeñas que podrían provocar asfixia en caso de ser ingeridas o inhaladas por el/la niño/a, AVVERTENZA: Piccole parti, ACHTUNG: Kleine Teile, OSTRZEŻENIE: Małe części, WAARSCHUWING: Kleine onderdelen, ПРЕДУПРЕЖДЕНИЕ: Мелкие детали, ADVARSEL: Små dele, ADVARSEL: Små deler, VAROITUS: Pieniä osia, ΠΡΟΕΙΔΟΠΟΙΗΣΗ: Μικρά κομμάτια, UYARI: Küçük parçalar, UPOZORNĚNÍ: Malé části, UPOZORNENIE: Malé části, FIGYELMEZTETÉS: Kis alkatrészek.



ATTENTION : PETITS ÉLÉMENTS. ATENÇÃO!

NÃO INDICADO / NÃO RECOMENDÁVEL PARA CRIANÇAS MENORES DE 3 (TRÊS) ANOS POR CONTER PARTE(S) PEQUENA(S) QUE PODE(M) SER ENGOLIDA(S) OU ASPIRADA(S) PODENDO PROVOCAR ASFIXIA.

警告: のどにつまる危険 小さな部品が含まれています 3歳以下の子供には与えないで下さい。

警告! 不适合3岁以下儿童使用。内含小零件。

تحذير: قطع صغيرة.

This toy does not float. Ce jouet ne flotte pas. / Este juguete no flota. / Este brinquedo não flutua. / Questo giocattolo non galleggia. / Dieses Spielzeug schwimmt nicht. / Та забавка не плыва / nie unosi się na wodzie. / Dit speelgoed kan niet drijven. / Этра игрушка не держится на воде. / Dette legetøj kan ikke flyde. / Leksaken flyter inte. / Denne leken flyter ikke. / Tämä lelu ei kellu. / Αυτό το παιχνίδι δεν επιπλέει. / Bu oyuncak suda yüzmeyiz. / Tato hračka neplave. / Tätö hračka nepláva na vode. / A játék nem marad fenn a víz felszínén. / このおもちゃは水に浮かびません / هذه اللعبة لا تطفو على الماء. / 本产品不会漂浮于水面。

© P781,964, D797,203

**DISCOVER A WORLD OF UNLIMITED STORYTELLING
WITH BARBIE® BUILDING SETS**

**DÉCOUVREZ UN MONDE DE POSSIBILITÉS INFINIES
AVEC LES COFFRETS DE CONSTRUCTION BARBIE**



**DESCUBRE UN MUNDO DE AVENTURAS SIN FIN CON LOS CONJUNTOS DE CONSTRUCCIÓN DE BARBIE
DESCOBRER UM MUNDO DE HISTÓRIAS ILIMITADAS COM OS CONJUNTOS DE CONSTRUÇÃO DA BARBIE
MIT DEN BARBIE BAUSET EINE WELT VOLLER UNBEGRENZTEM SPIELSPAß ENTDECKEN
ОТКРОЙТЕ ДЛЯ СЕБЯ МИР БЕЗГРАНИЧНЫХ ИСТОРИЙ ВМЕСТЕ С НАБОРАМИ КОНСТРУКТОРА БАРБИ**

BARBIE® and associated trademarks and trade dress are owned by, and used under license from Mattel.
©2022 Mattel.

©2022 MEGA Brands &™ MEGA Brands.
Printed in China / Imprimé en Chine AD-HPN79-01A

Mattel Canada Inc. Mississauga, Ontario L5R 3W2.
MADE IN CHINA. FABRIQUÉ EN CHINE. FABRICADO NA CHINA. HECHO EN CHINA.
ИЗГОТОВЛЕНО В КИТАЕ. ÇIN'DE ÜRETİLMİŞTİR. صنع في الصين



HPN78



HPN79



HPN80

Set(s) sold separately and subject to availability. / Ensemble(s) vendu(s) séparément. Certains produits peuvent ne pas être commercialisés. / Se vende(n) por separado y está(n) sujeto(s) a disponibilidad. / Conjunto(s) vendido(s) em separado e sujeito(s) à disponibilidade. / Set in vendita separatamente, secondo disponibilità. / Das/Die Set(s) sind separat erhältlich. / Zestaw(y) sprzedawany(e) oddzielnie w zależności od dostępności. / Set(s) apart verkrijgbaar en afhankelijk van beschikbaarheid. / Набор(-ы) продаются отдельно, при наличии. / Set sælges separat og så længe lager haves. / Seten säljs separat så länge lagret räcker. / Settet/settene selges separat så langt lageret rekker. / Pakkaus/pakkukset myydään erikseen, saatavuus voi vaihdella. / Το(α) σετ πωλούνται ξεχωριστά και ανάλογα με τη διαθεσιμότητα. / Setler ayrı olarak satılır ve stoklarla sınırlıdır. / Set (sety) se prodává (prodávají) samostatně dle aktuální nabídky. / Súprava/-y sa predáva(jú) samostatne a podľa dostupnosti. / A készlet(ek) külön kapható(k), az elérhetőség változhat. / セット商品は別売りになります。在庫状況は別途ご確認をお願いします。

تباع المجموعة أو المجموعات على حدة وتخضع لتوافرها.
每套单独发售，按供货情况决定。

