



# Barbie



HDJ87

HORSE STABLES

LES ÉCURIES

PFERDESTÄLLE | SCUDERIE | PAARDENSTALLEN | ESTABLOS DE CABALLOS | ESTÁBULOS DE CAVALOS | HÄSTSTALL | HESTESTALD | HESTESTALLER  
СТАЈИЈА СТАЈЕ | KONSKÉ STAJNE | ΙΣΤΆΛΛΟΚ | ΚΟΗΥΩΗΝ | ΣΤΑΒΛΟΣ ΜΕ ΆΛΟΓΑ | AT AHIRI | اسطبلات الخيل

# PLAY AS YOU BUILD! JOUÉZ EN CONSTRUISANT!

JUEGA MIENTRAS CONSTRUYES • CONSTRUÇÃO E BRINCADEIRA SIMULTÂNEAS  
GLEICHZEITIG BAUEN UND SPIELEN • СТРОЙ И ИГРАЙ



# CHOOSE WHAT YOU WANT TO BUILD FIRST! CHOISISSEZ CE QUE VOUS VOULEZ CONSTRUIRE EN PREMIER!

¡ELIGE QUÉ QUIERES CONSTRUIR PRIMERO! • ESCOLHA O QUE VOCÊ QUER CONSTRUIR PRIMEIRO! KINDER KÖNNEN AUSSUCHEN, WAS SIE ZUERST BAUEN WOLLEN! • ВЫБЕРИ, ЧТО ТЫ ХОЧЕШЬ СОБРАТЬ СНАЧАЛА!

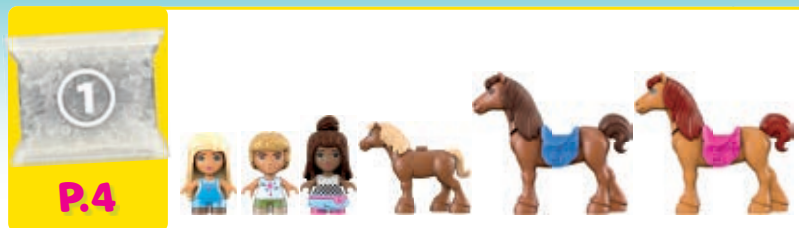

## Build Construisez

Construye | Constrói  
Bauen | Стройте



## Share | Partagez

Comparte | Partilha  
Teilen | Делитесь

Devices not included | Appareils non inclus | Dispositivos no incluido  
Dispositivos não incluídos | Geräte nicht enthalten | Устройства не входят в комплект

## Play as you build! Jouez en construisant!

Juega mientras construyes!  
Construção e brincadeira simultâneas!  
Gleichzeitig bauen und spielen!  
Строй и играй!



[megaunboxed.com](http://megaunboxed.com)





# CUSTOMIZE YOUR BARBIE FIGURE! PERSONNALISEZ VOTRE FIGURINE BARBIE!

PERSONALIZA TU BARBIE! • PERSONALIZE SUA BARBIE!  
DIE BARBIE-FIGUREN INDIVIDUELL GESTALTEN! • СДЕЛАЙ СВОЮ ФИГУРКУ БАРБИ УНИКАЛЬНОЙ!



1



2



1



2







1



2

# LET'S BUILD THE BARN! CONSTRUIßONS LA GRANGE!

¡CONSTRUYAMOS EL GRANERO!  
CONSTRUAMOS O CELEIRO!  
EINE SCHEUNE BAUEN!  
ПОСТРОИМ КОНИШНЮ!

2

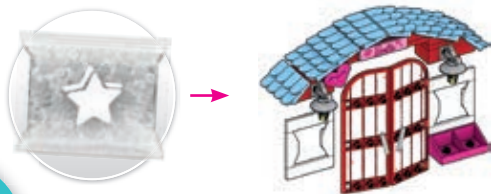
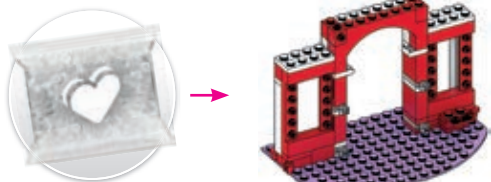

# BUILDING TOOL OUTIL DE CONSTRUCTION

HERRAMIENTA DE CONSTRUCCIÓN  
BAUWERKZEUG  
FERRAMENTA DE MONTAGEM  
ИНСТРУМЕНТ ДЛЯ  
КОНСТРУИРОВАНИЯ

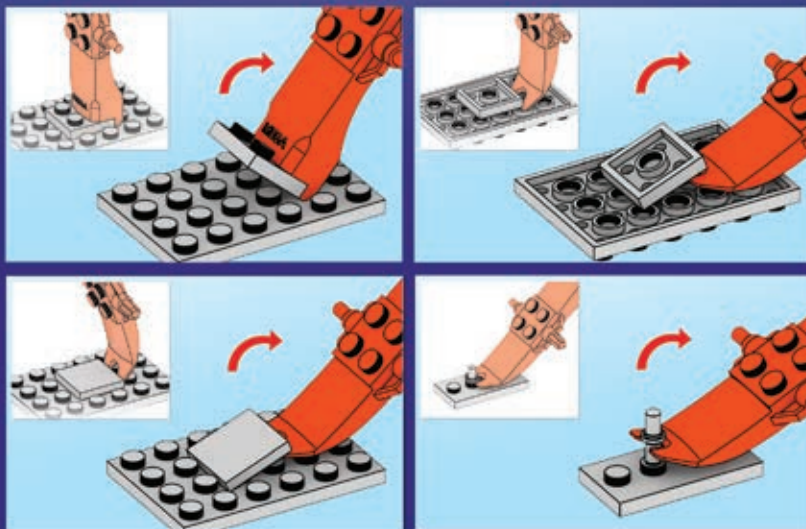



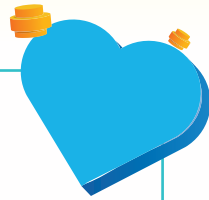

1



2

1

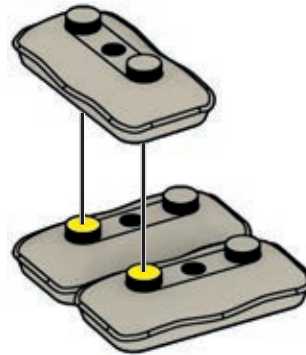

1



2

2

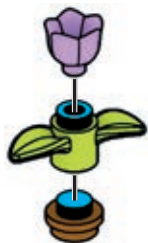

1



2

3



1



2

4

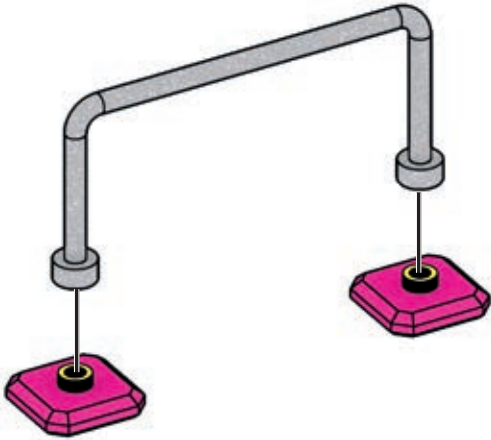
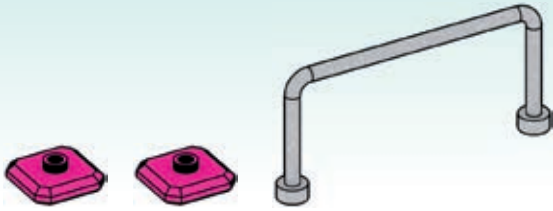

5

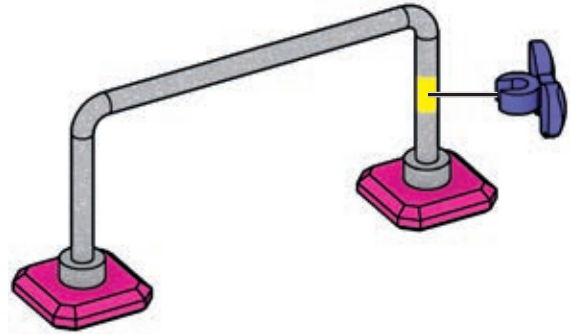

6

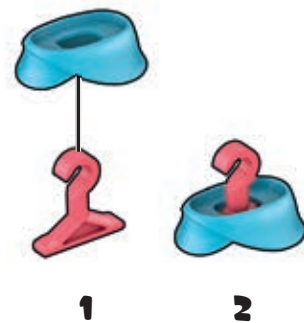
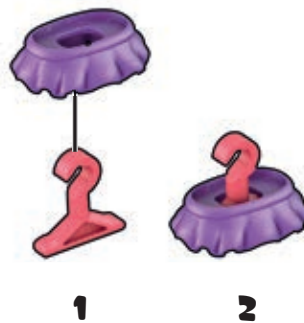
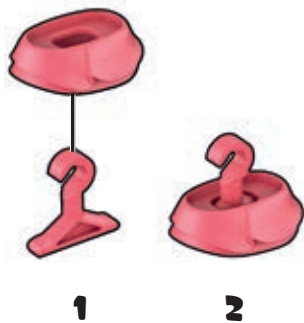

7

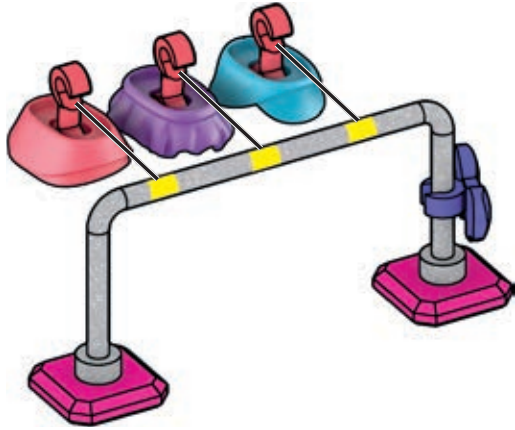

1



2



8

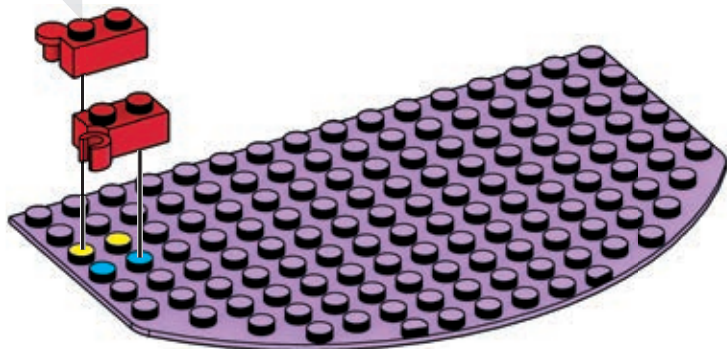
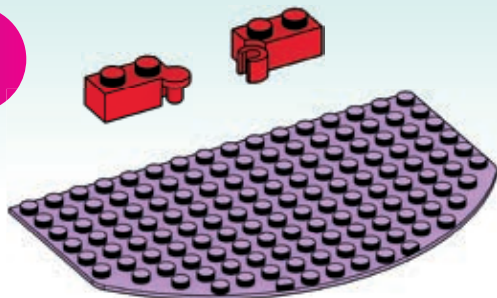

9

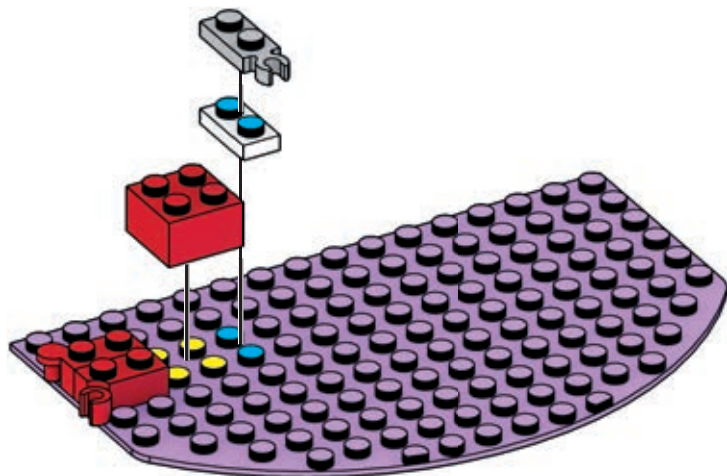
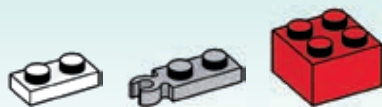

10

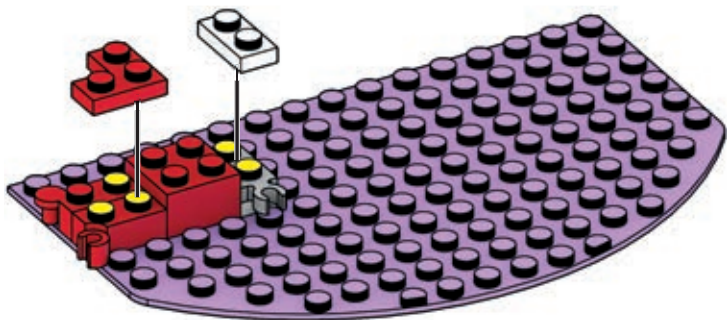

11

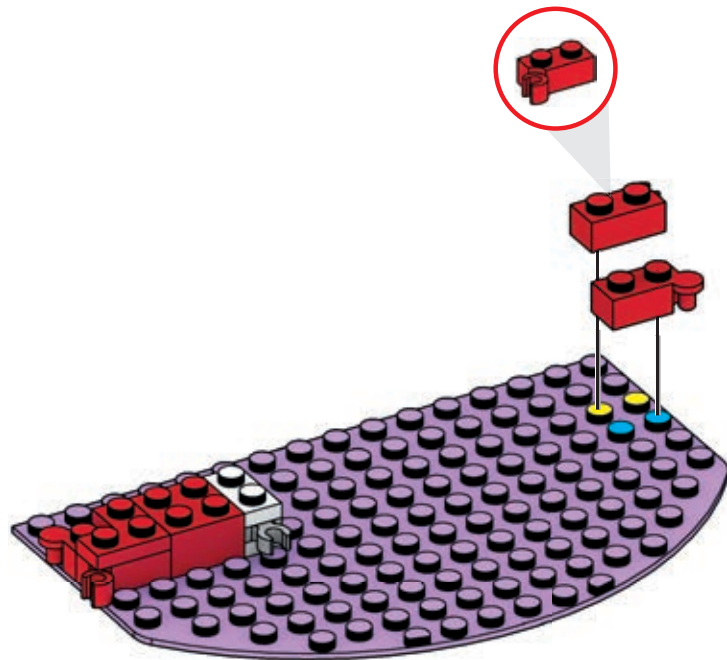

12

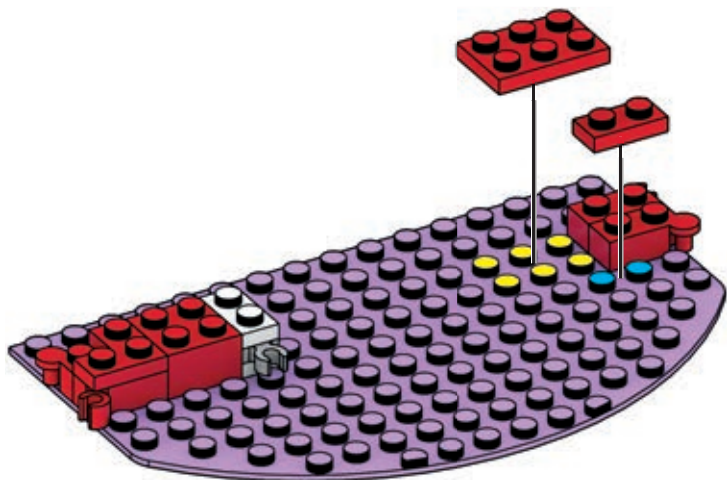

13

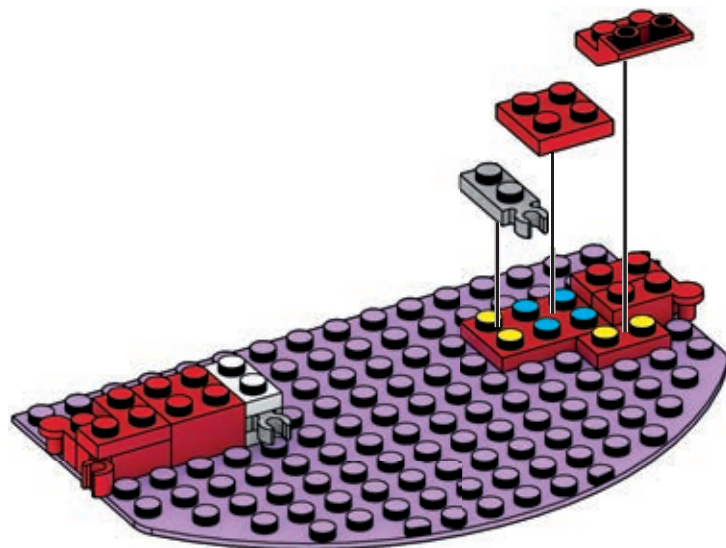



14

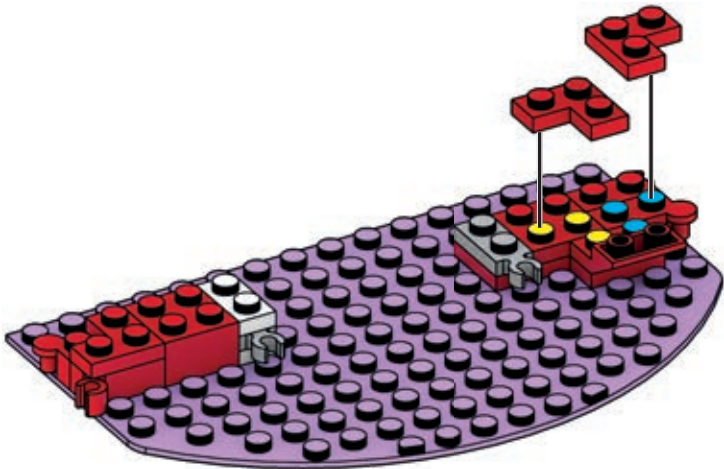

15

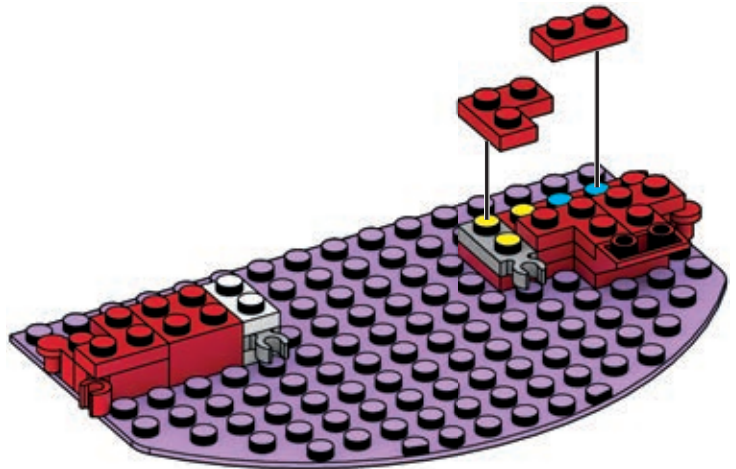

16

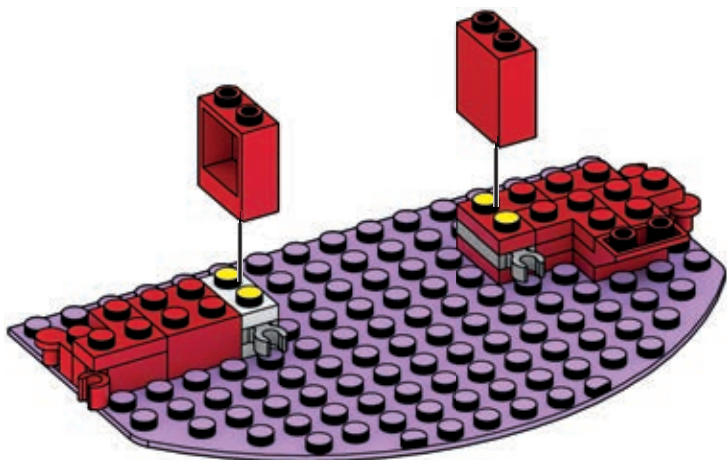

17

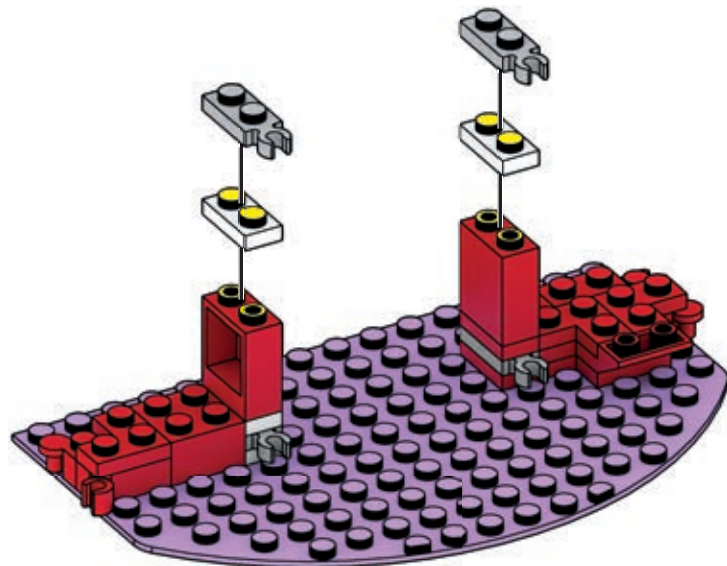

18

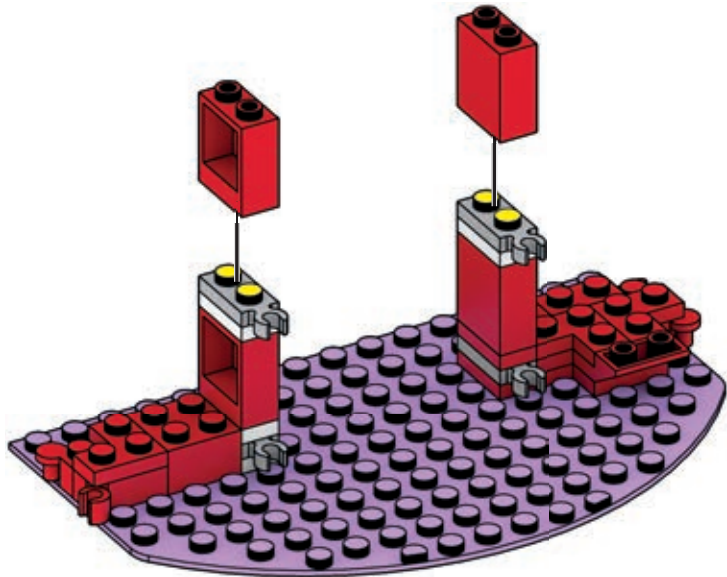

19

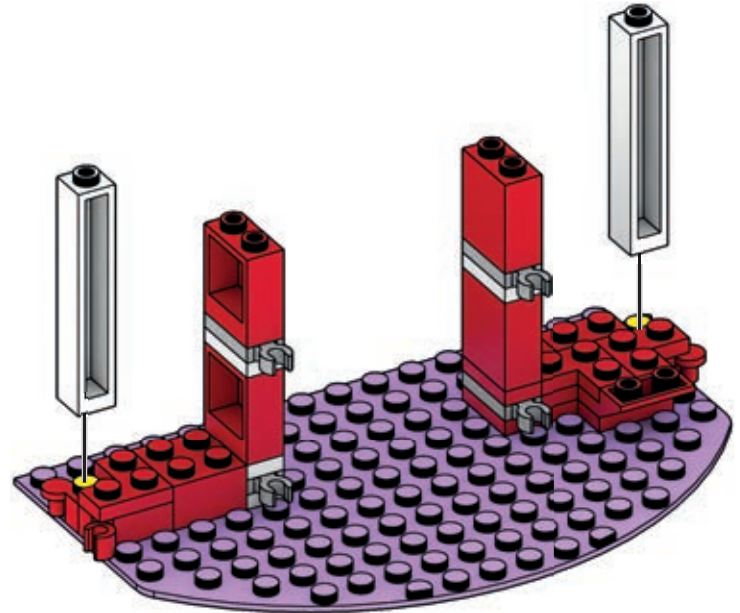
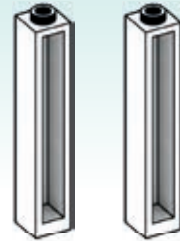

20



21

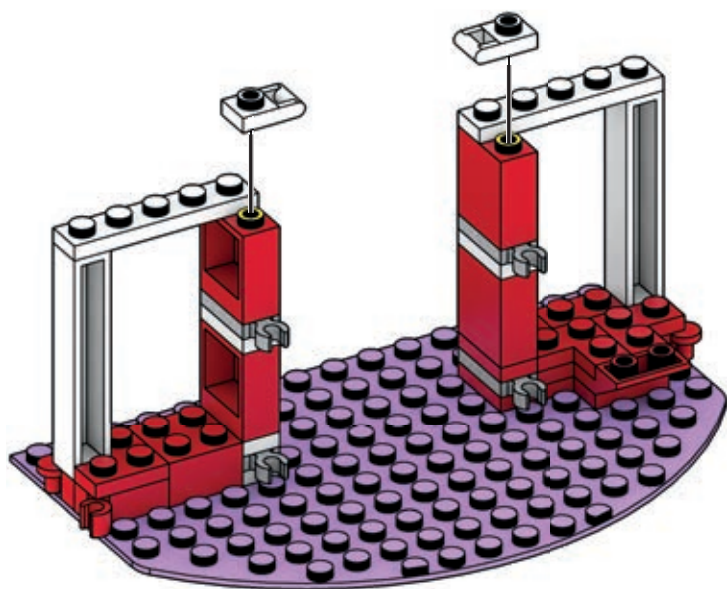
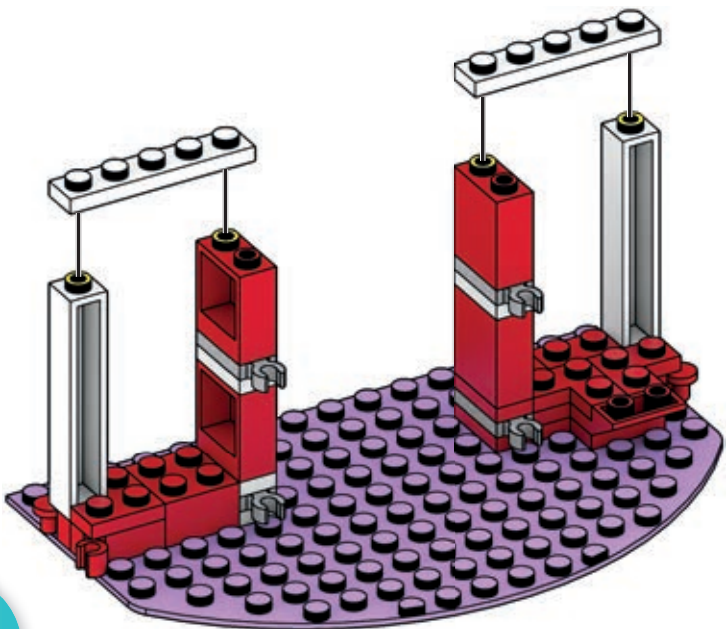

22

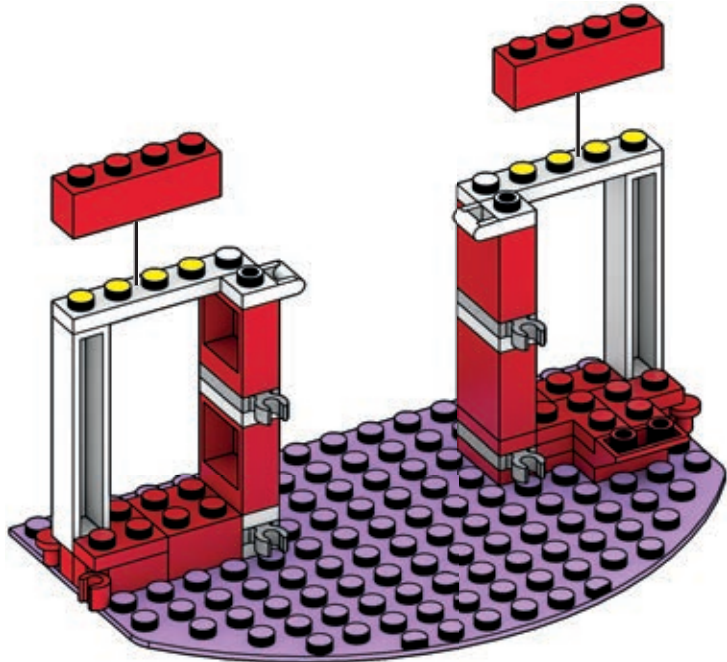
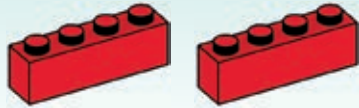

23

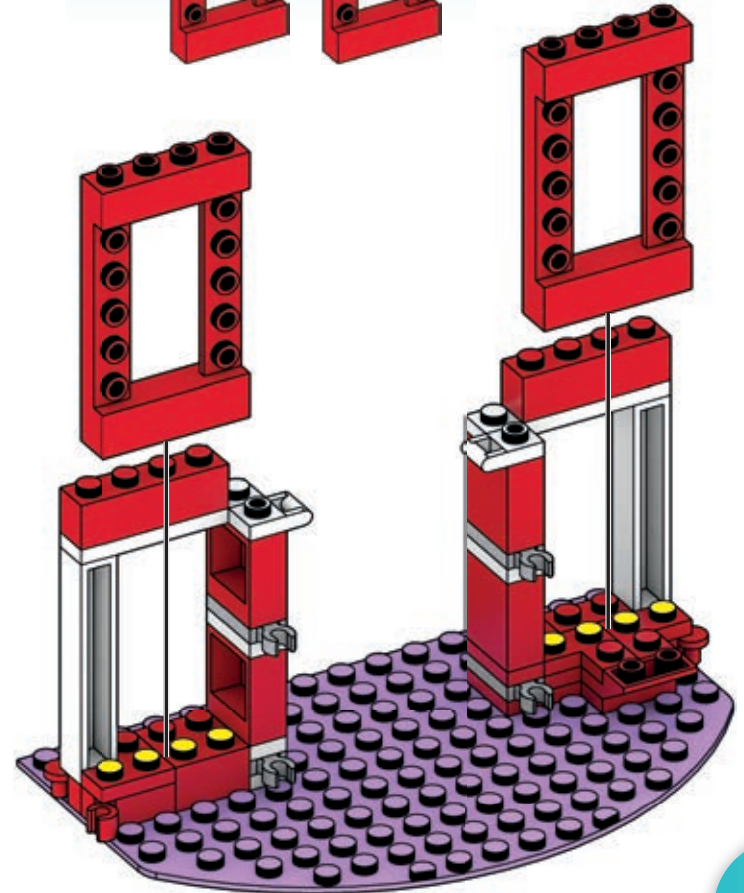
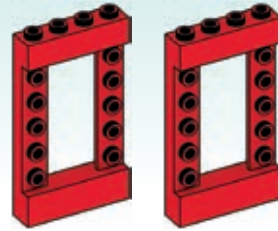

24

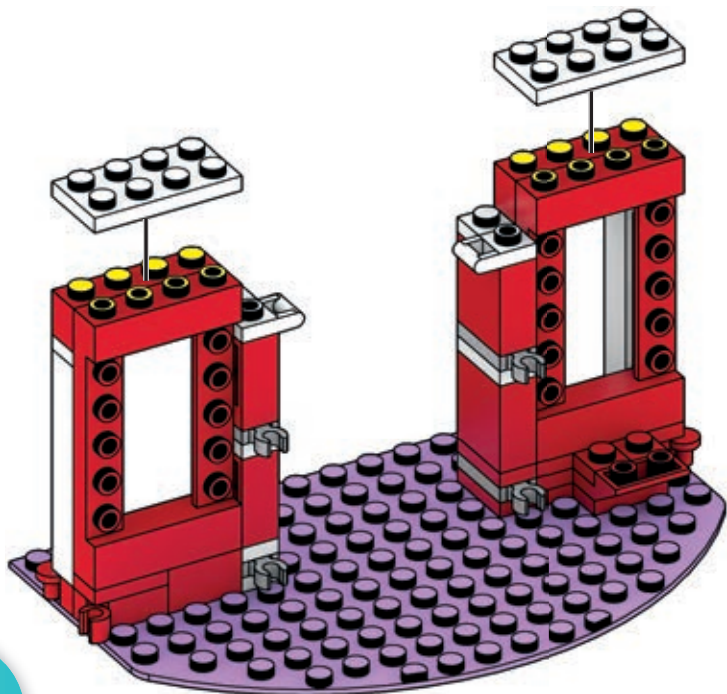

25

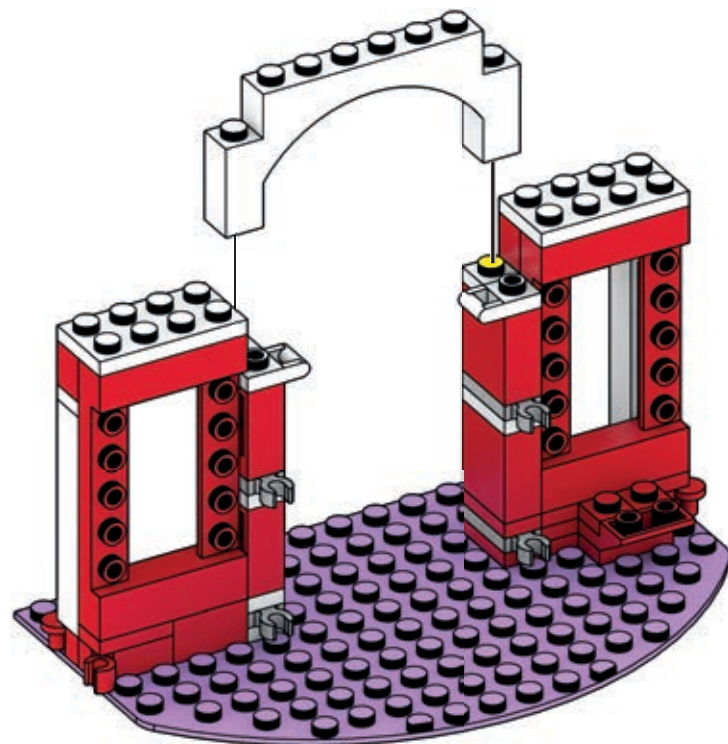
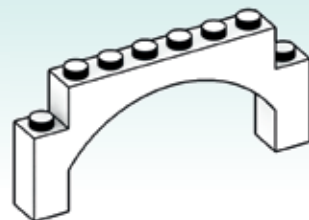

26

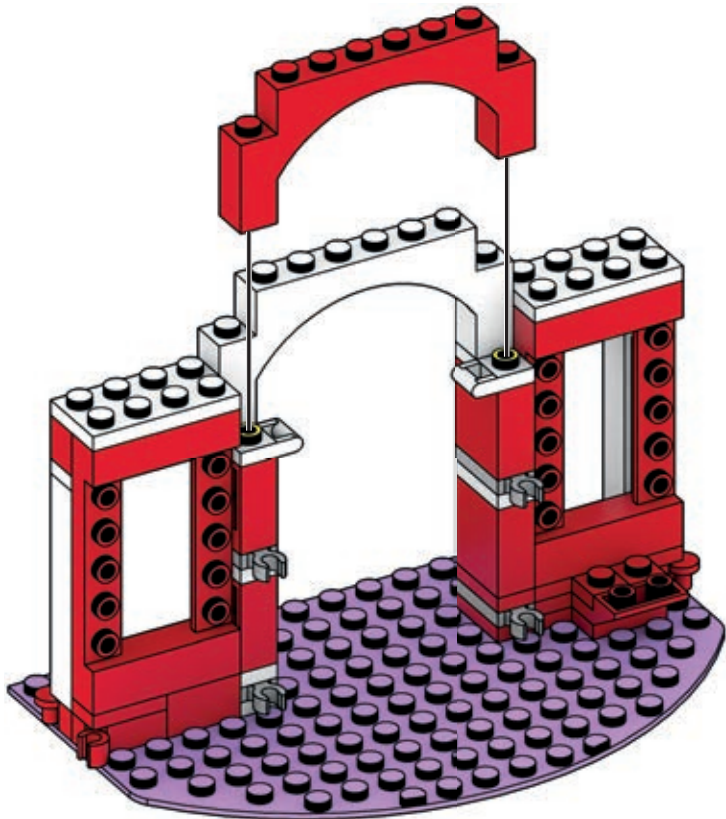
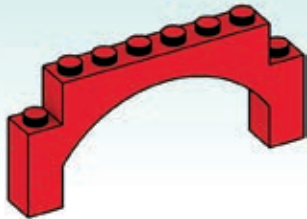

27

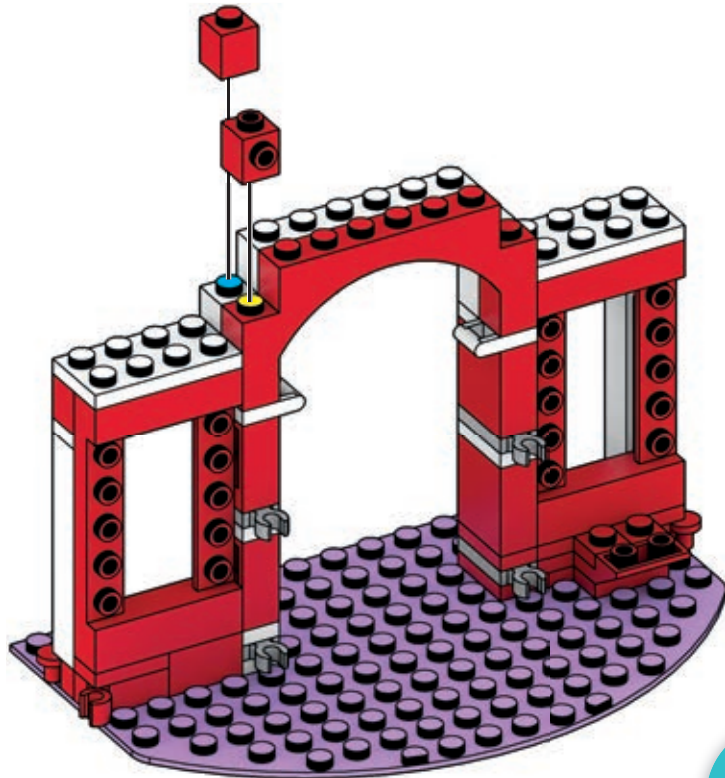

28

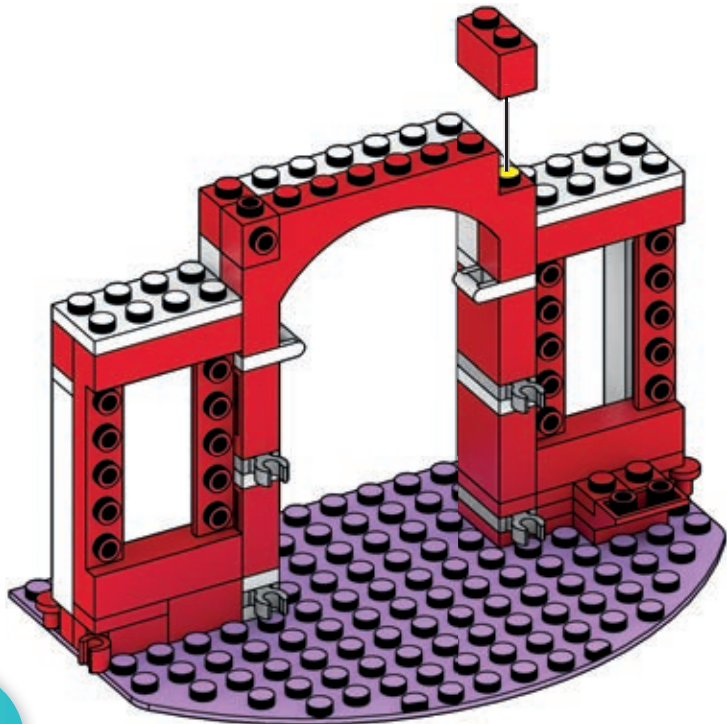

29

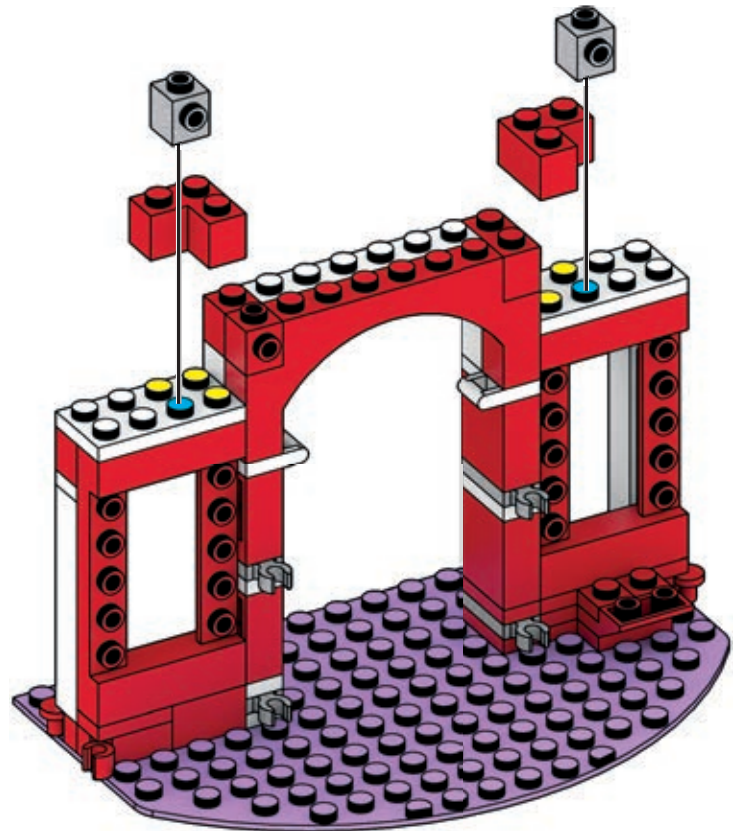



30

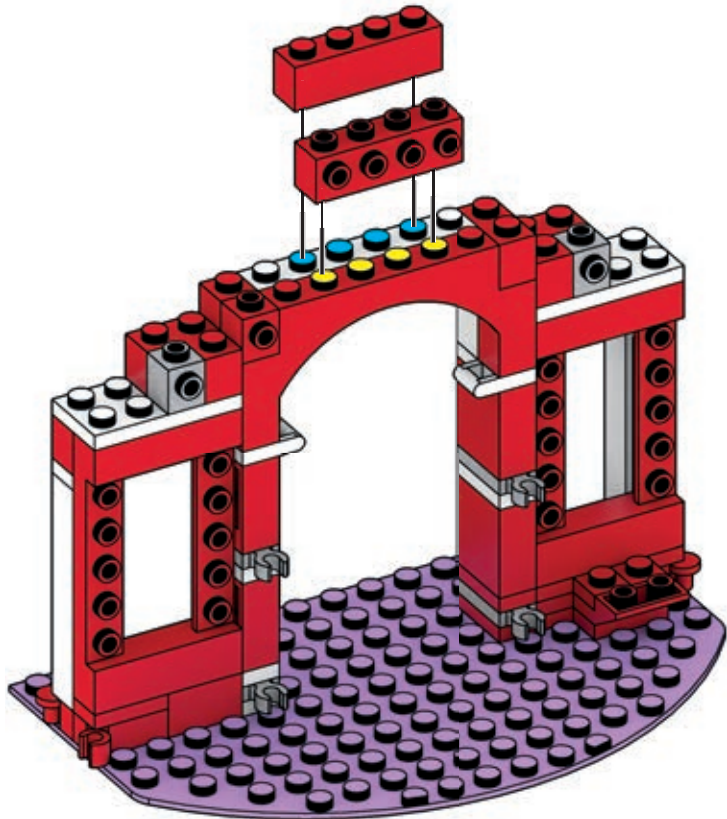
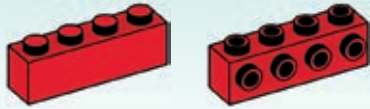

31

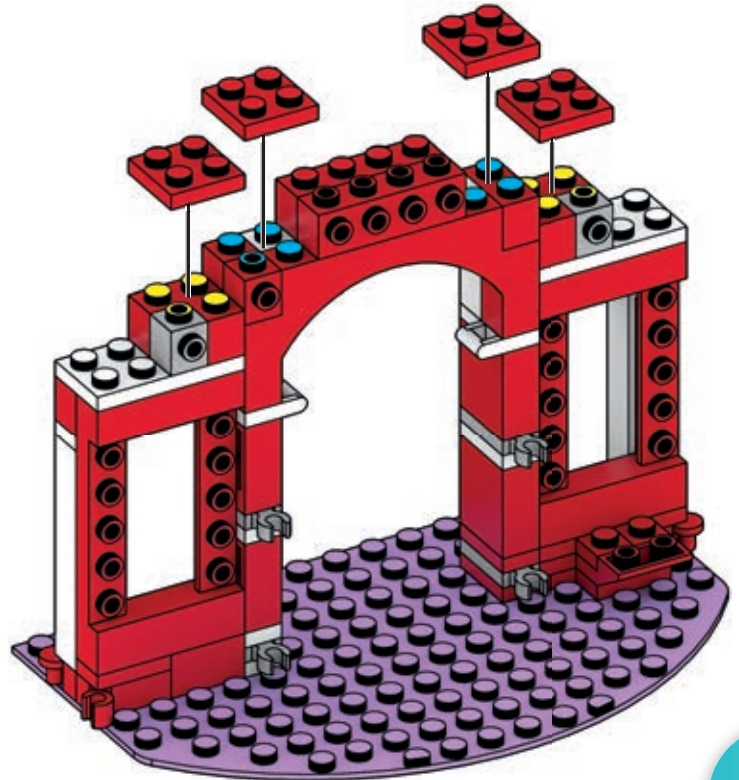

32

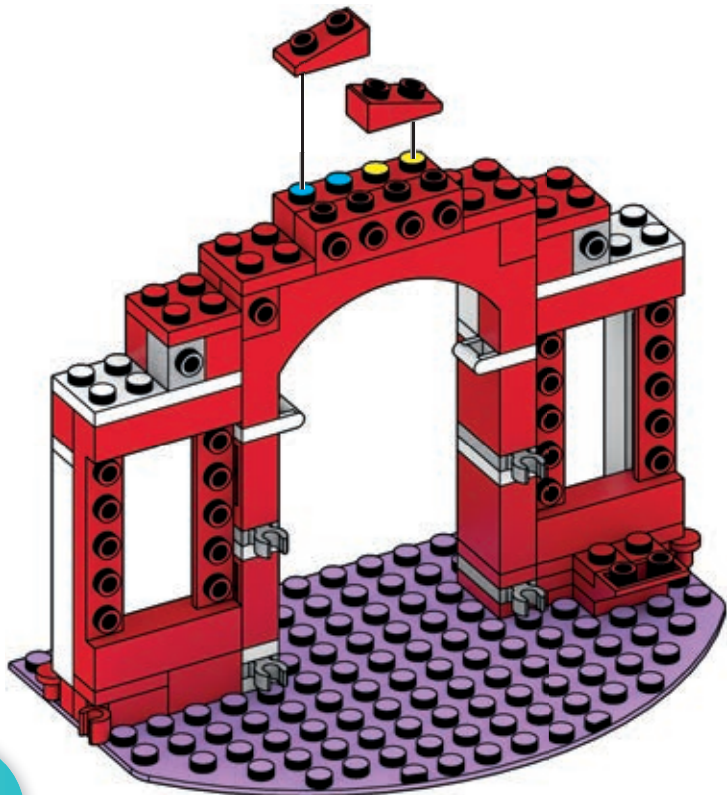

33

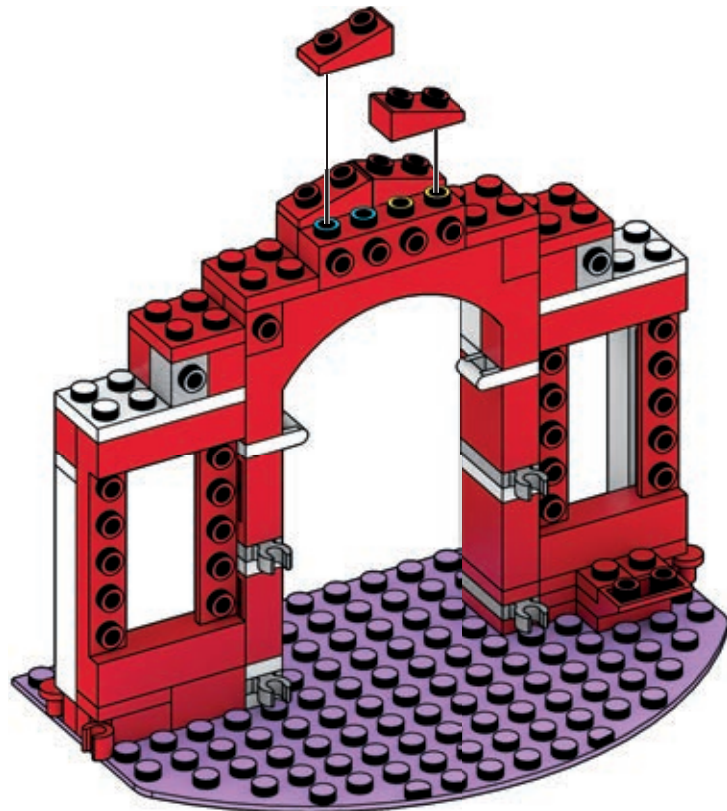

34

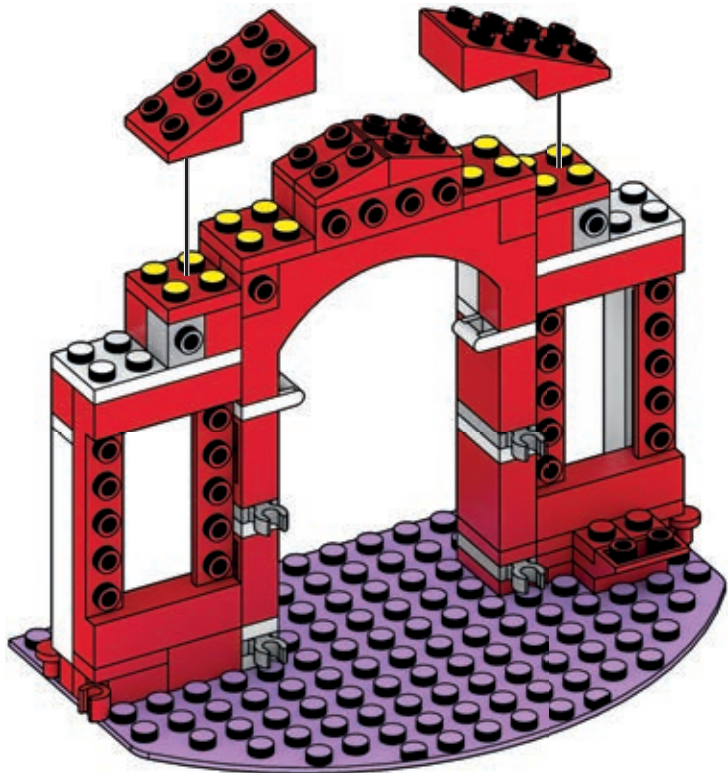
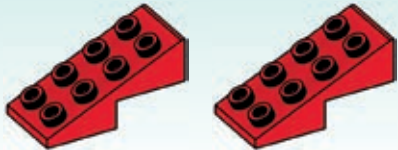

35

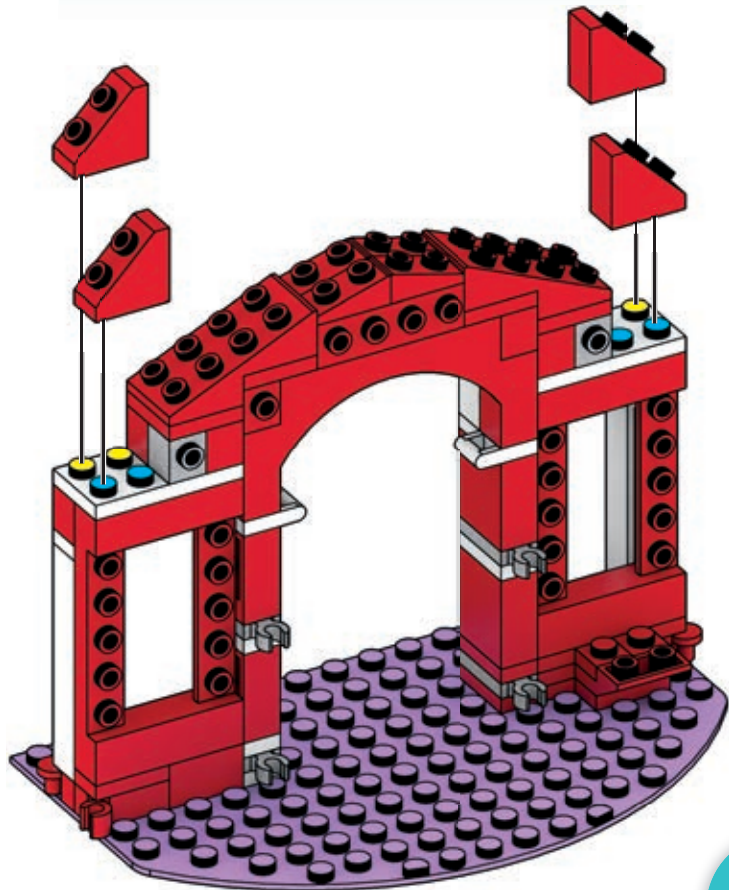
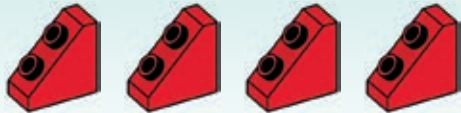

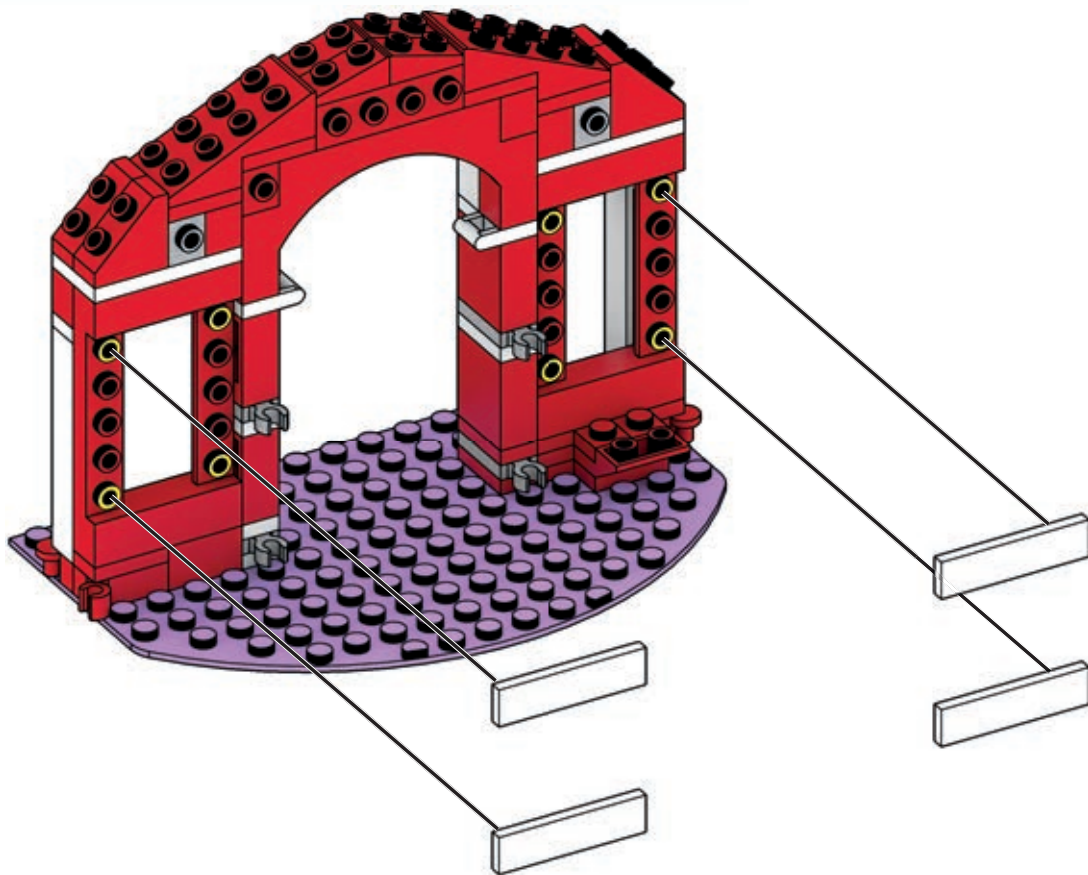

37

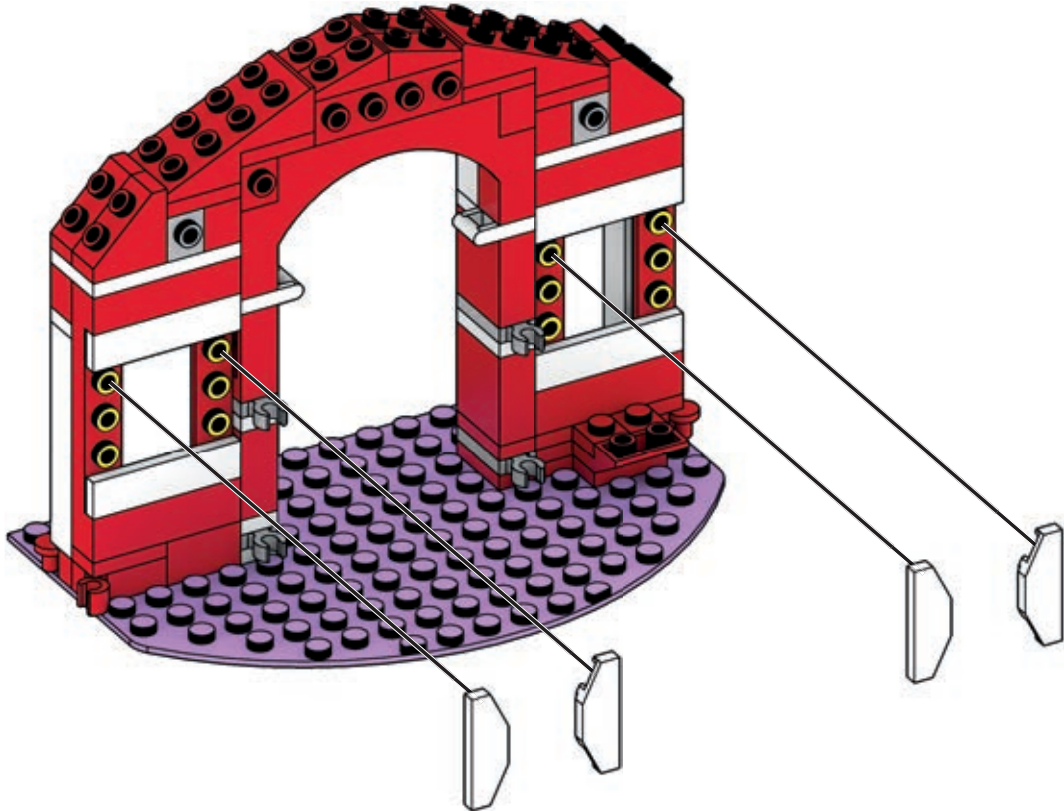

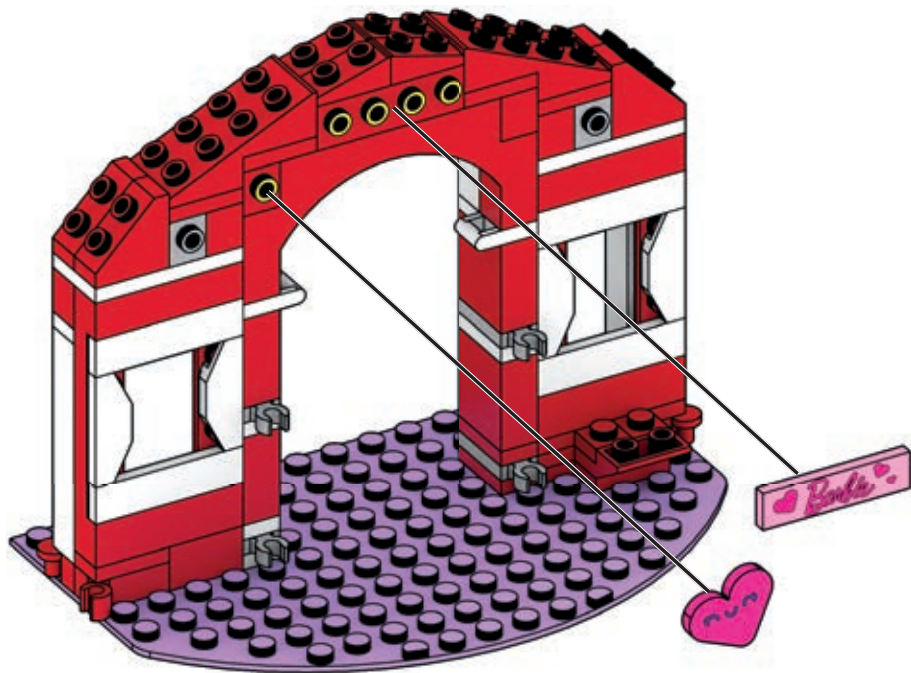

39



X2

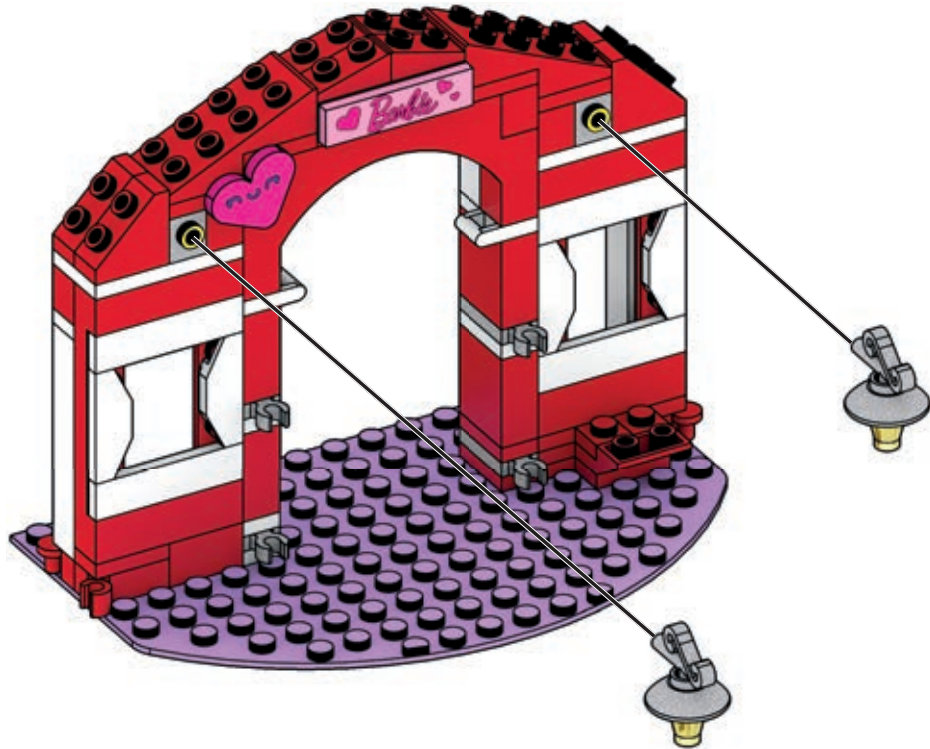

40

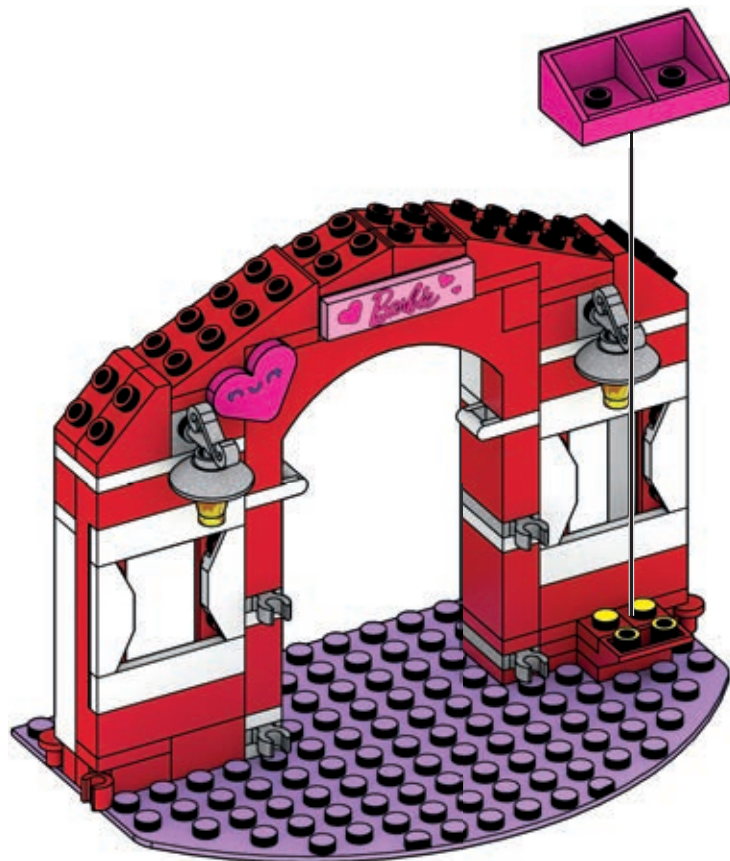



41

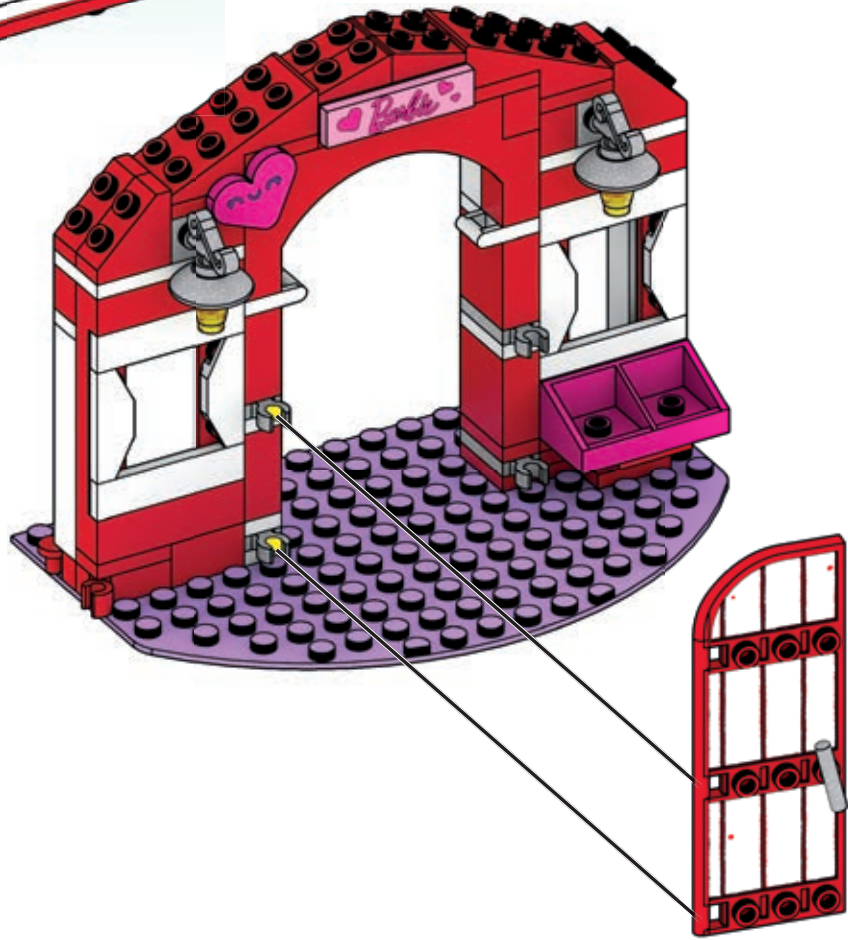
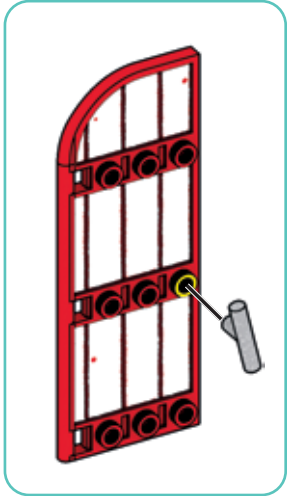
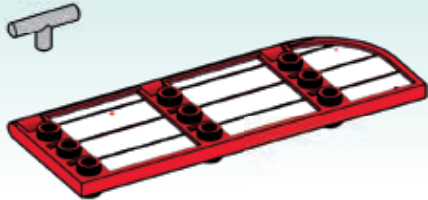

42

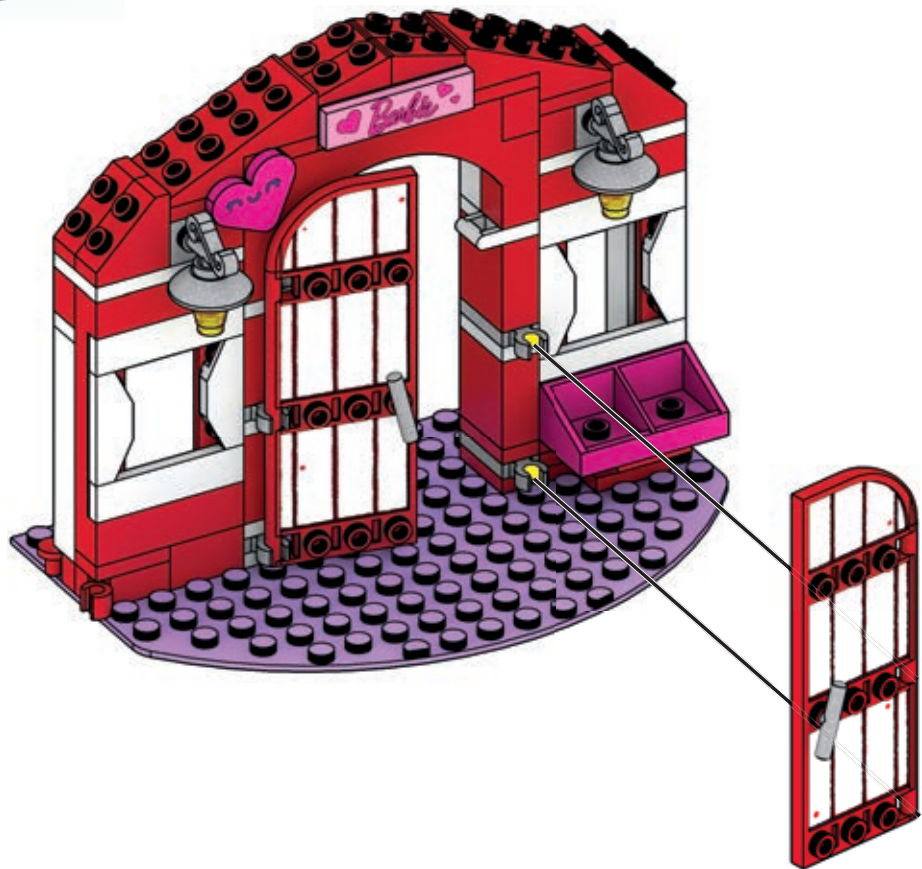
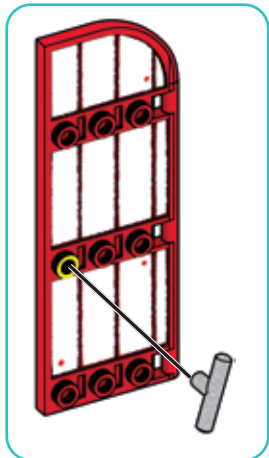
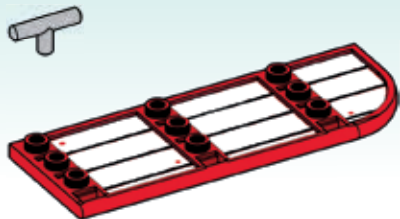

43

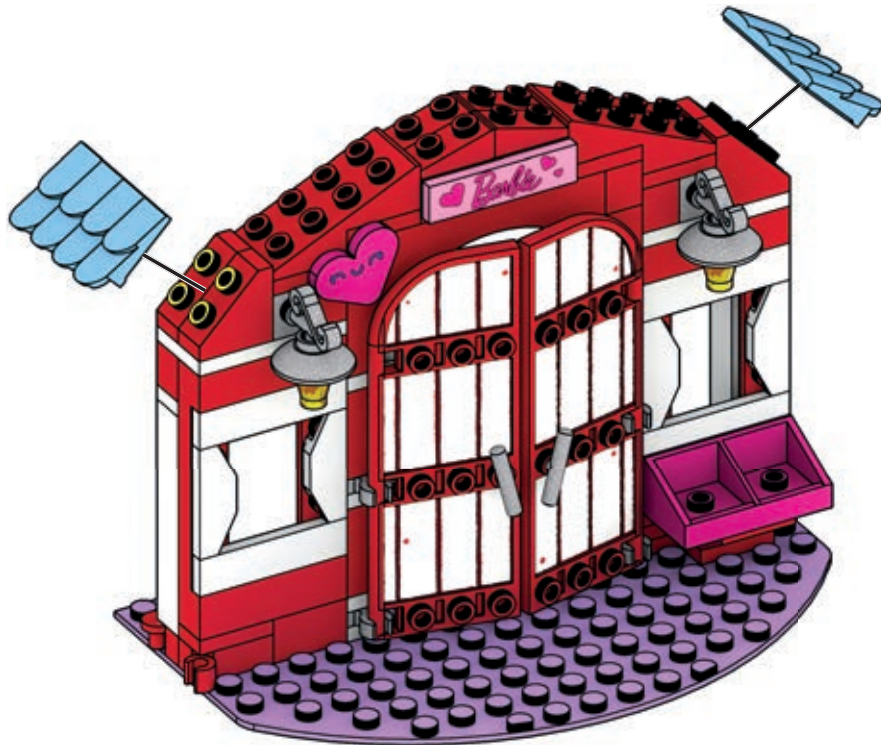

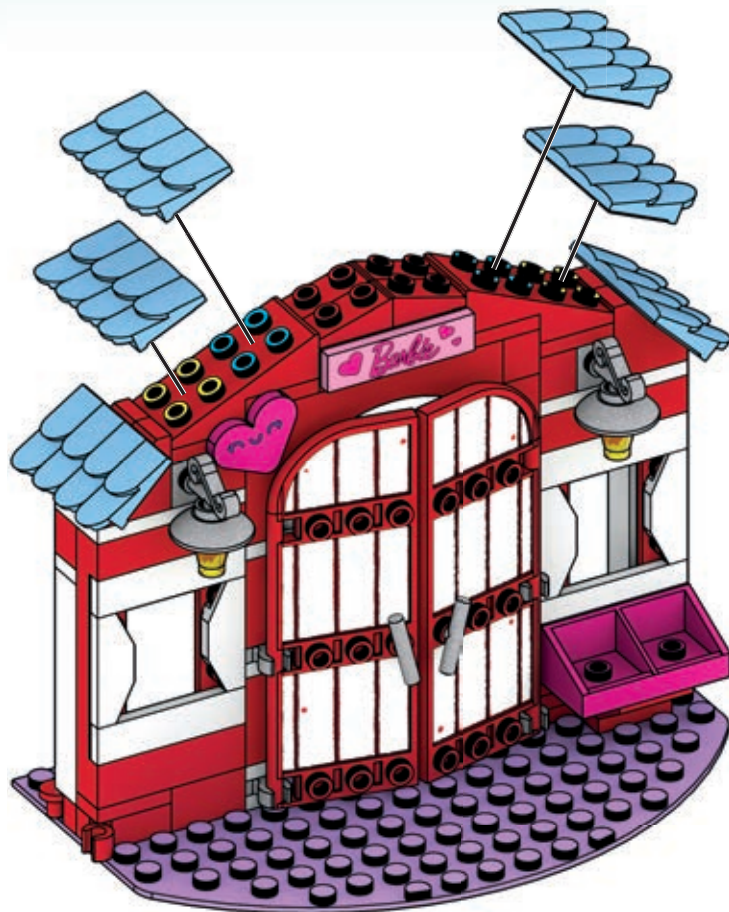

45

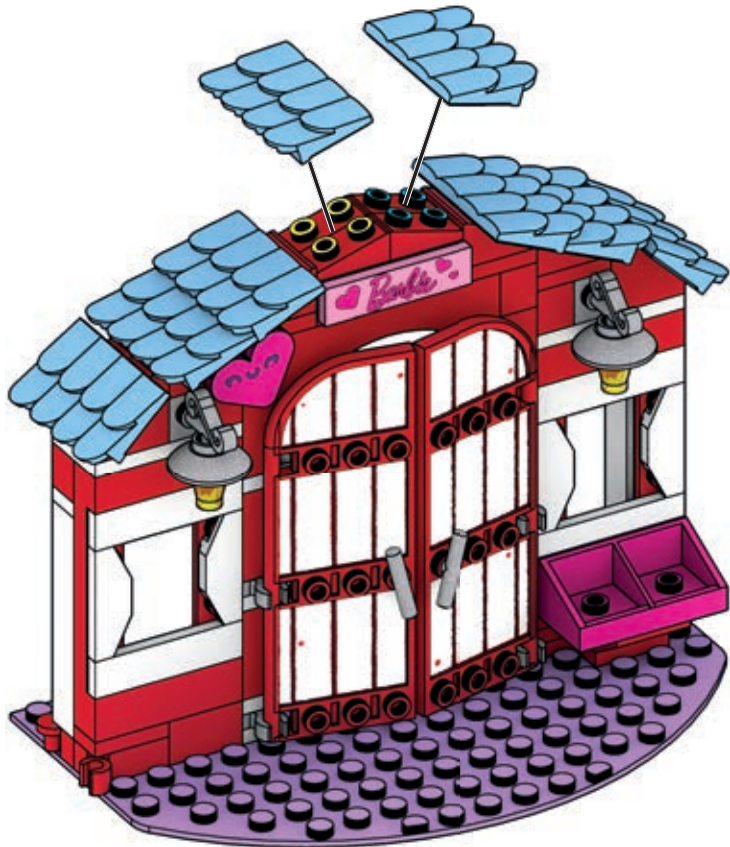
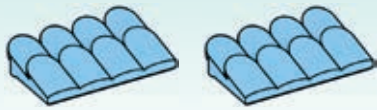

46

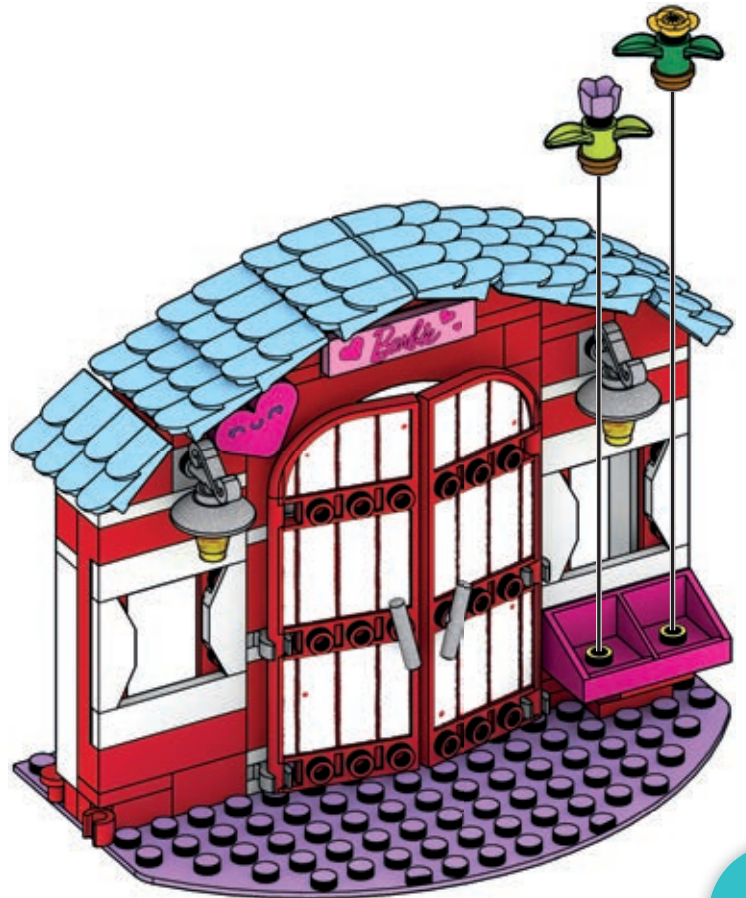

47

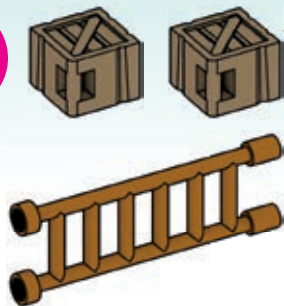

# LET'S PLAY! AMUSONS-NOUS!

¡AJUGAR! • A BRINCAR!  
LASS UNS SPIELEN! • НАИГРАЕМ ИГРУ!



# LET'S BUILD THE STABLES! CONSTRUIVONS L'ÉCURIE!



¡CONSTRUYAMOS LOS ESTABLOS!  
CONSTRUAMOS OS ESTÁBULOS!  
DIE STÄLLE BAUEN!  
ПОСТРОИМ СТОЙЛА!

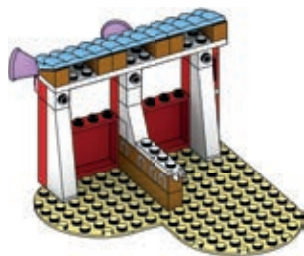

# CUSTOMIZE YOUR BARBIE FIGURE! PERSONNALISEZ VOTRE FIGURINE BARBIE!

¡PERSONALIZA TU BARBIE! • PERSONALIZE SUA BARBIE!  
DIE BARBIE-FIGUREN INDIVIDUELL GESTALTEN!  
СДЕЛАЙ СВОЮ ФИГУРКУ БАРБИ УНИКАЛЬНОЙ!



1

2



48

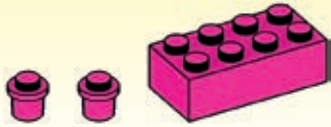

49



1

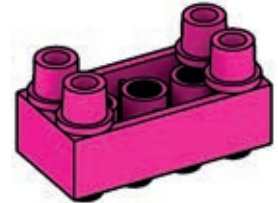

2

50

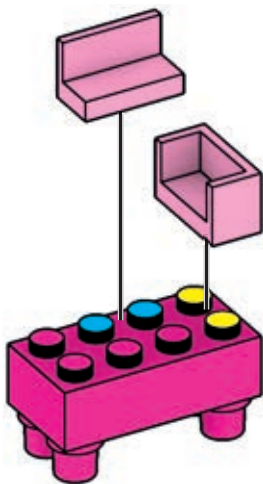
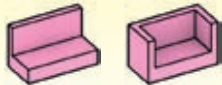

51

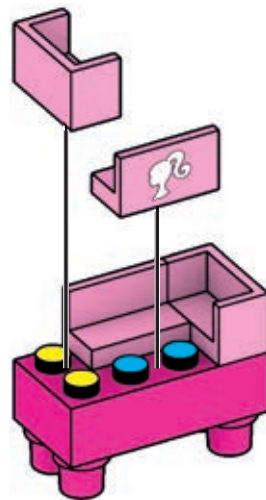
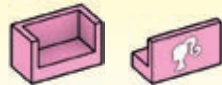

52

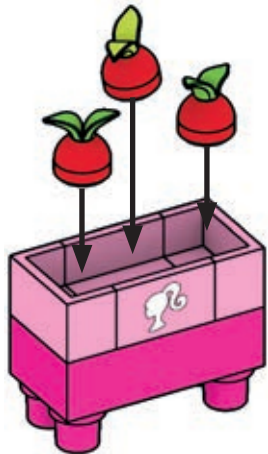
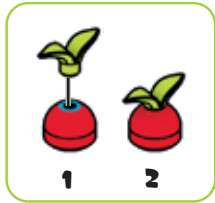
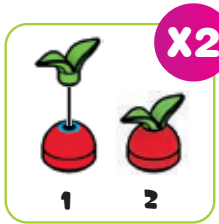

53

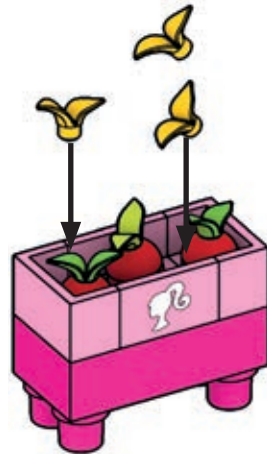

1



2





54

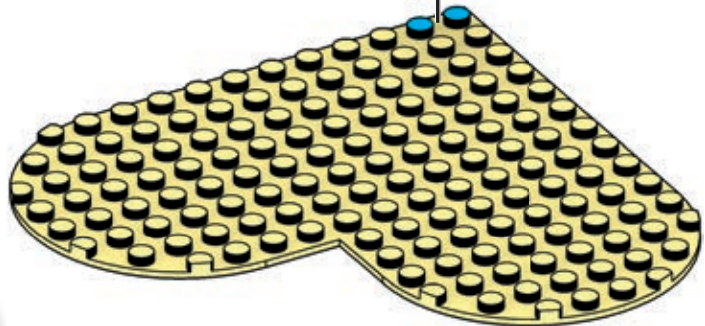
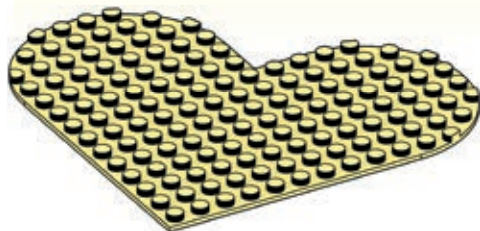
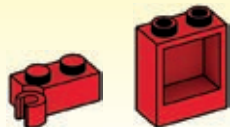

55

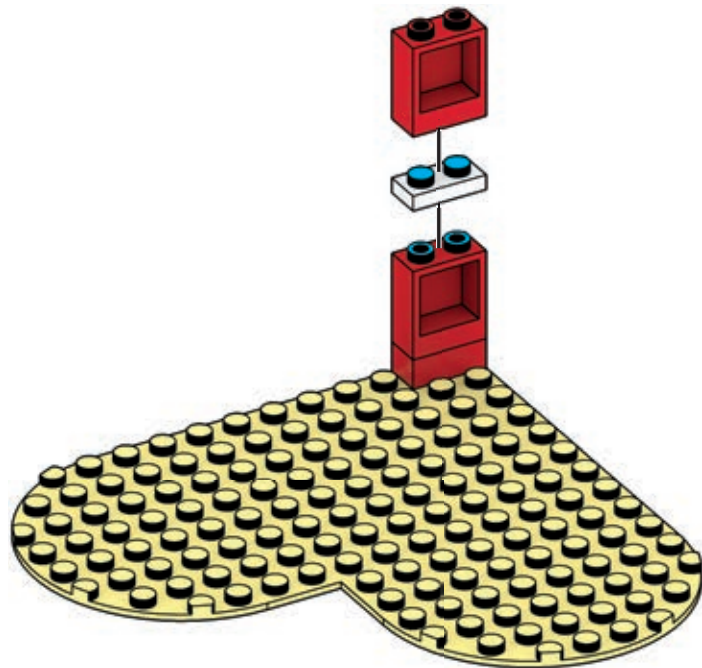

56

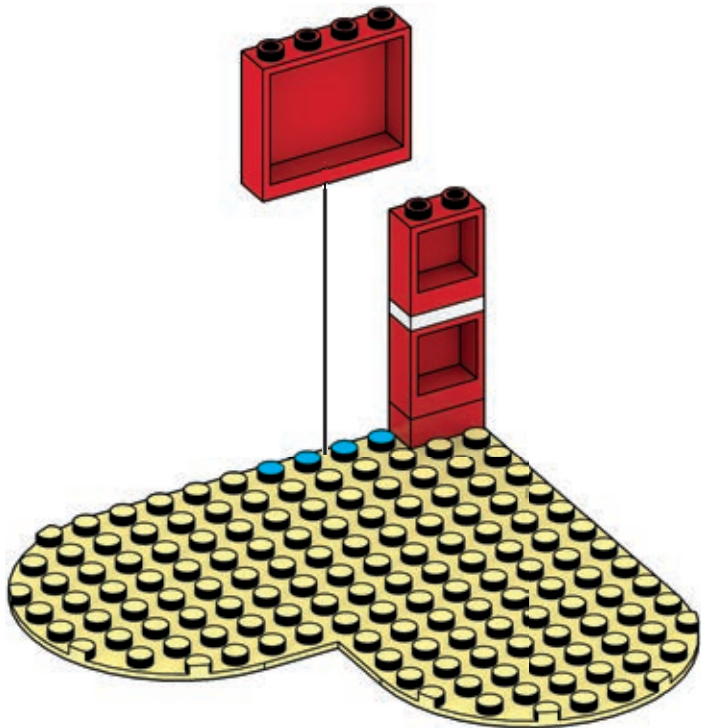

57

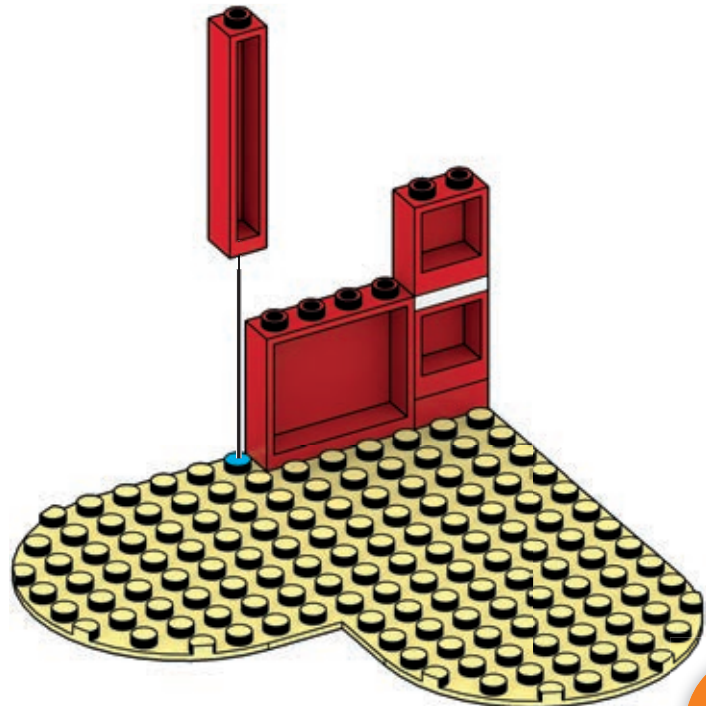

58

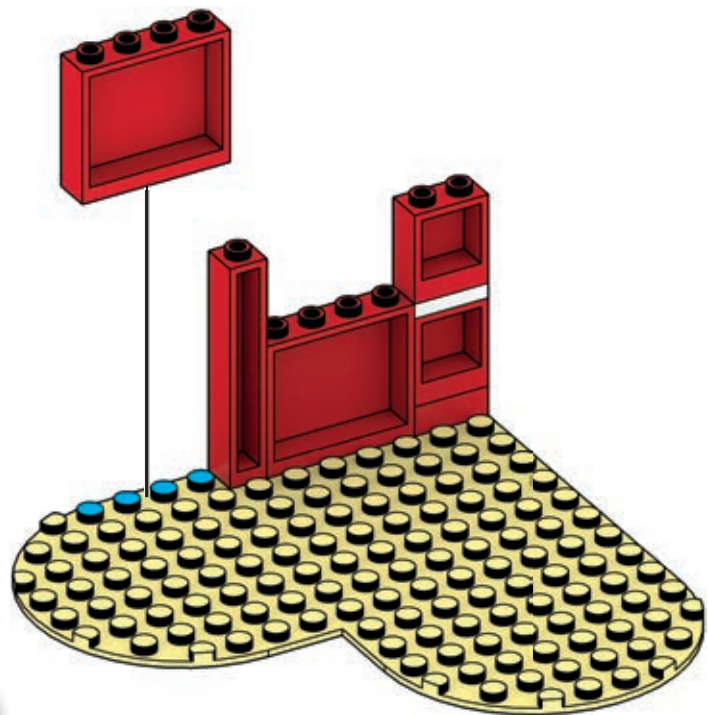

59

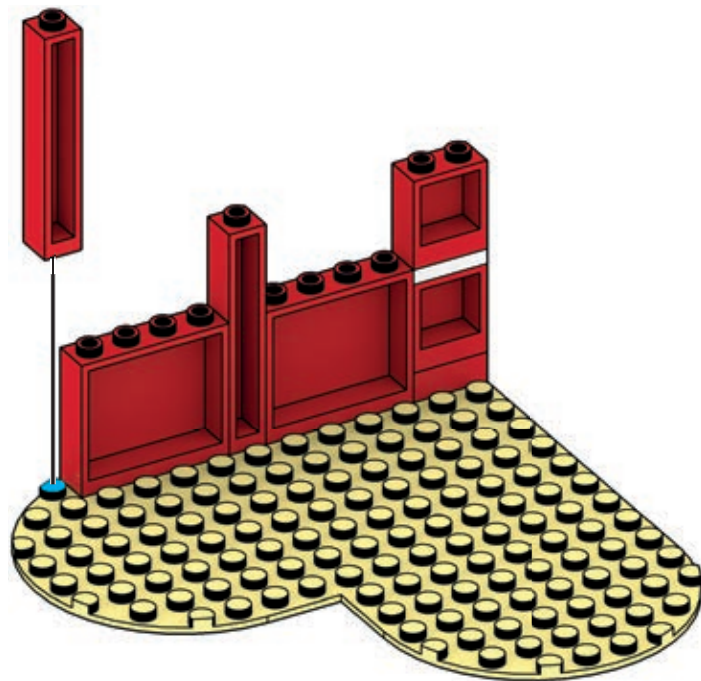

60

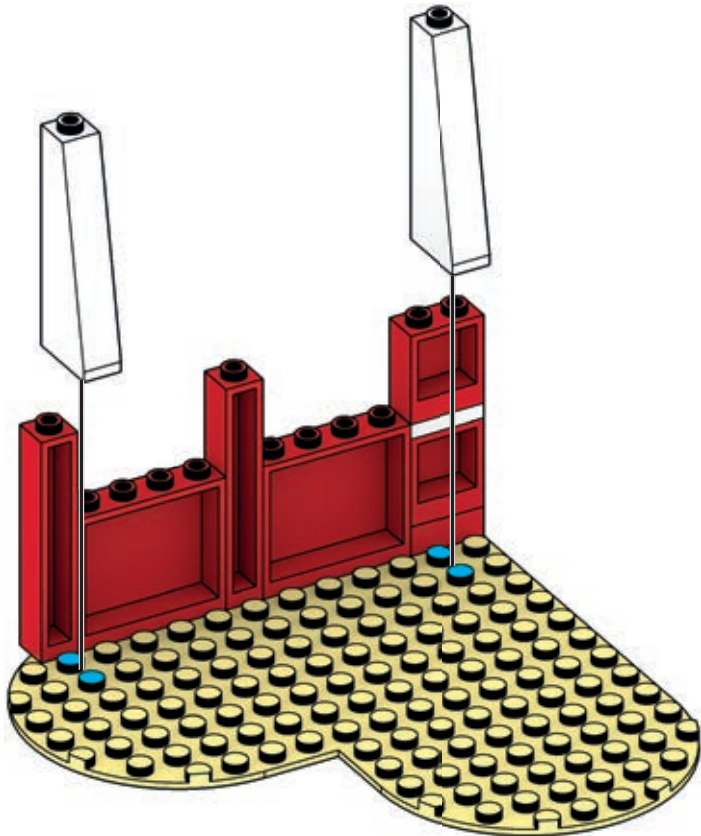
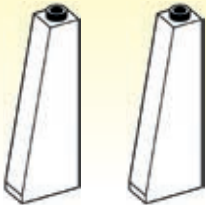

61

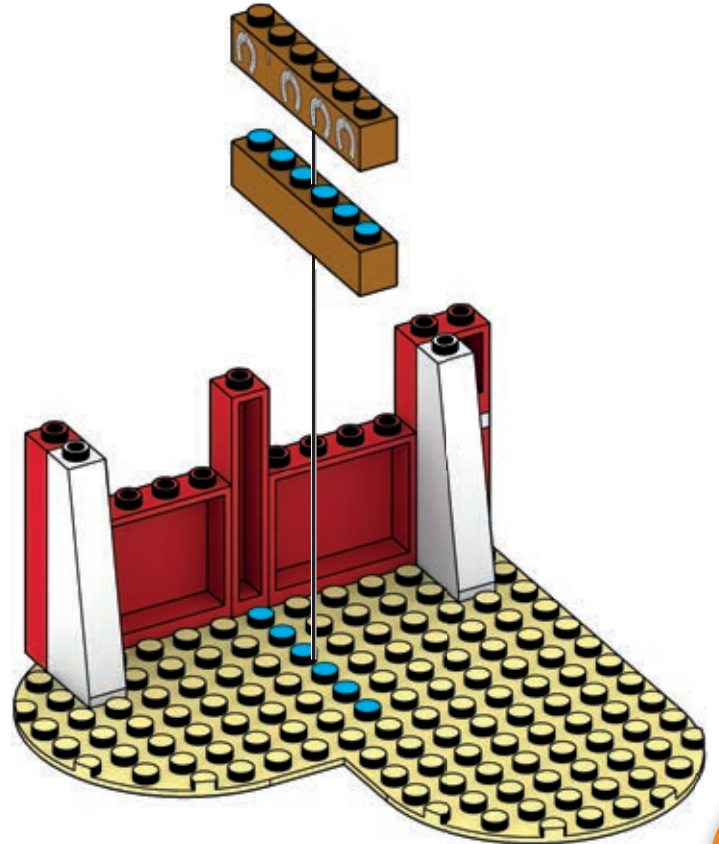
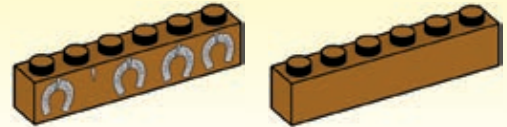

62

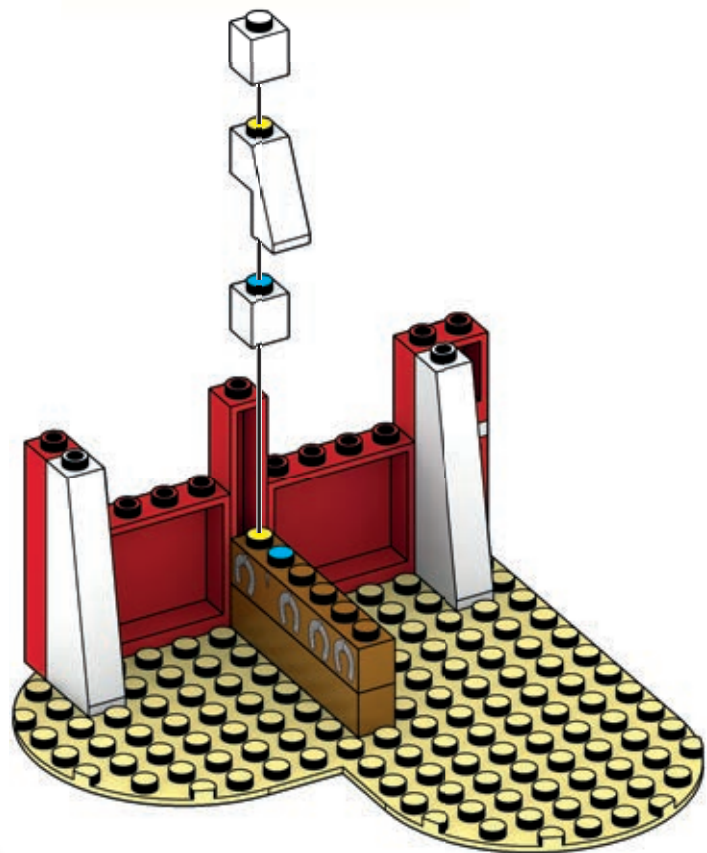

63

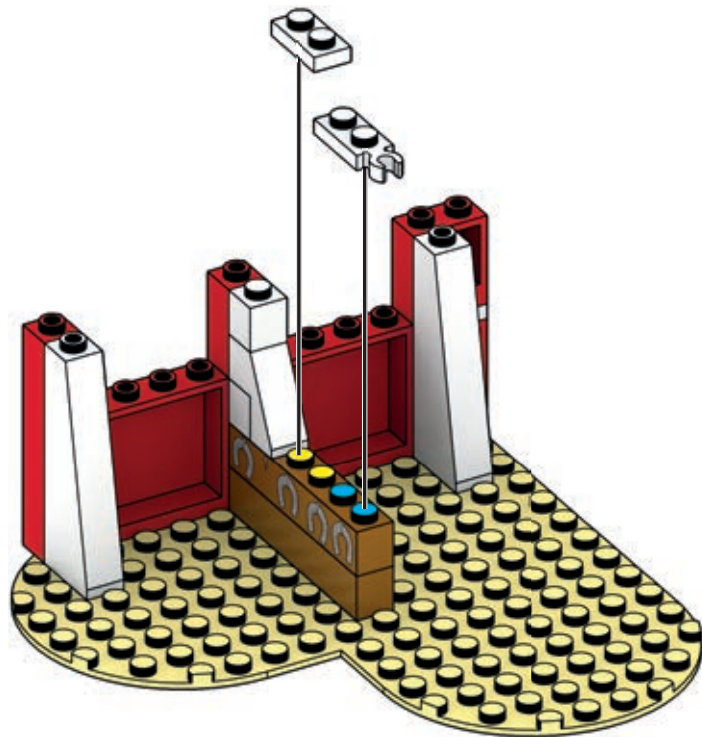



64

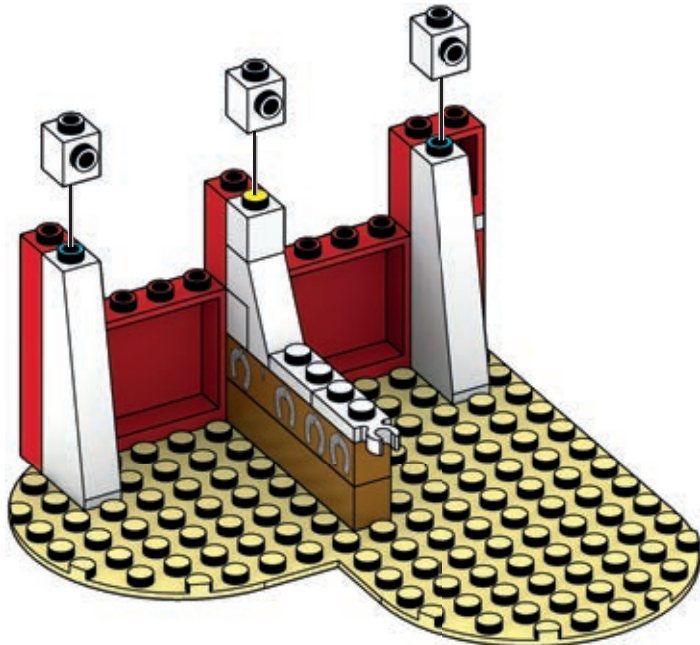

1

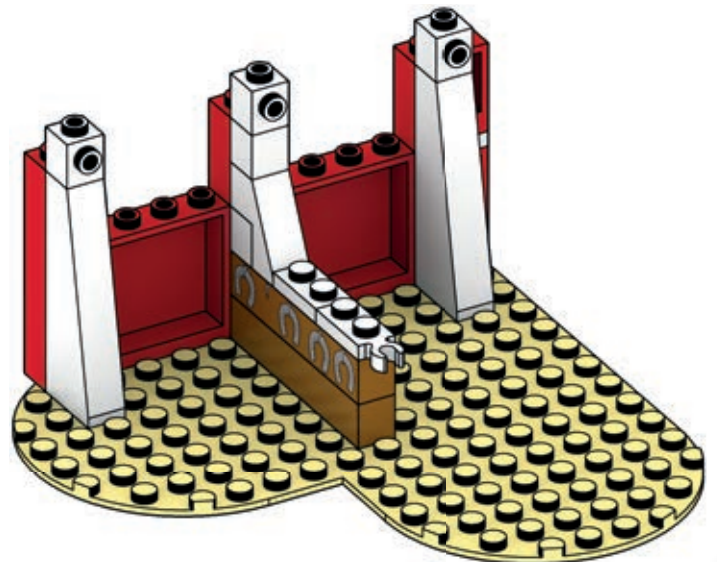

2

65



x2

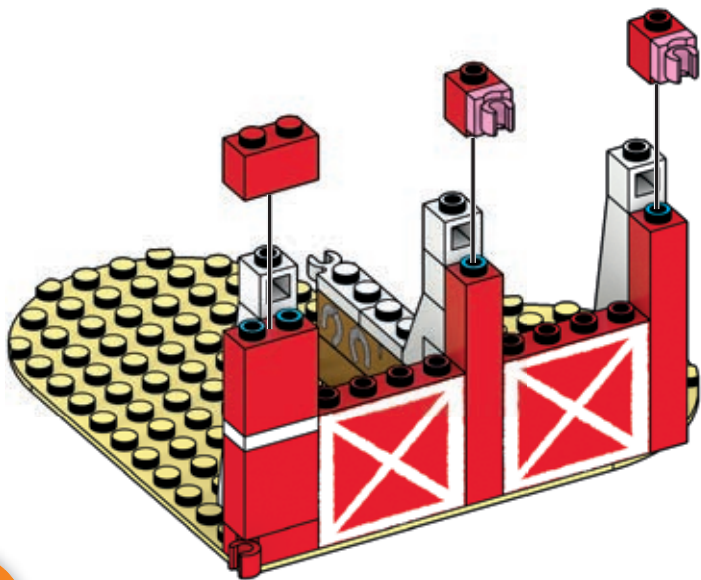
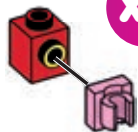

66

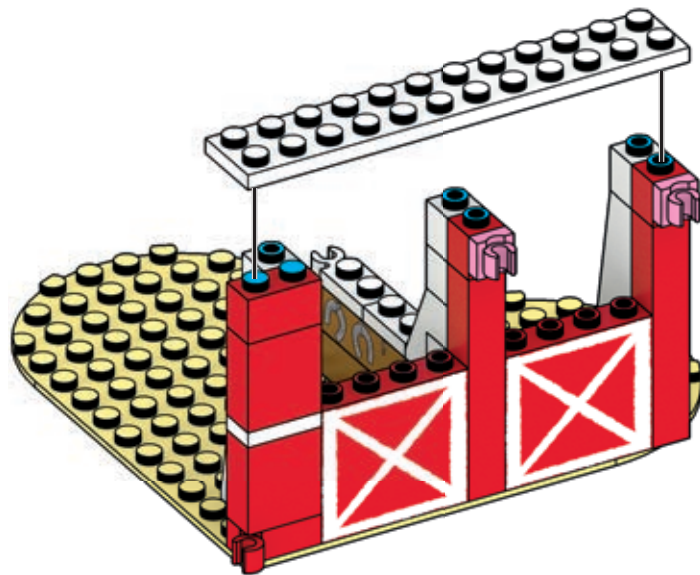
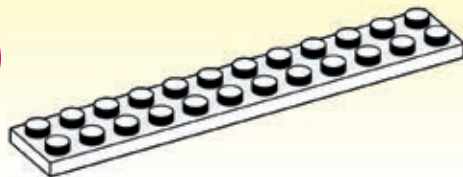

67

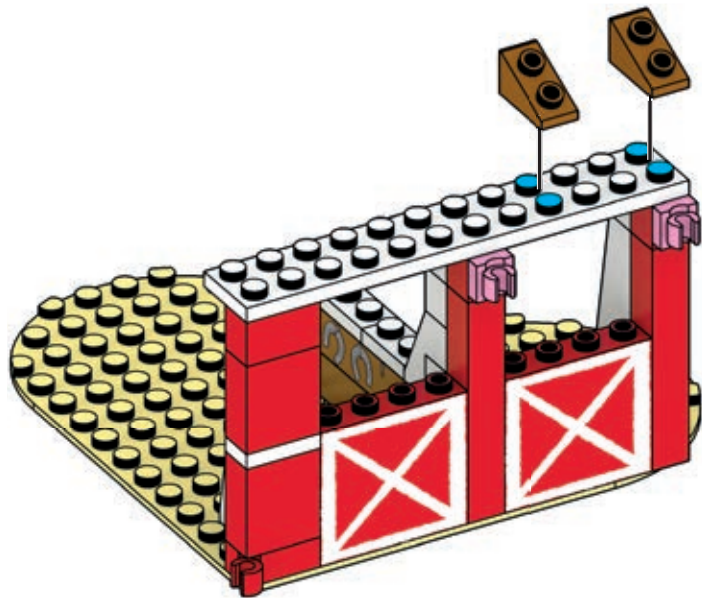

68

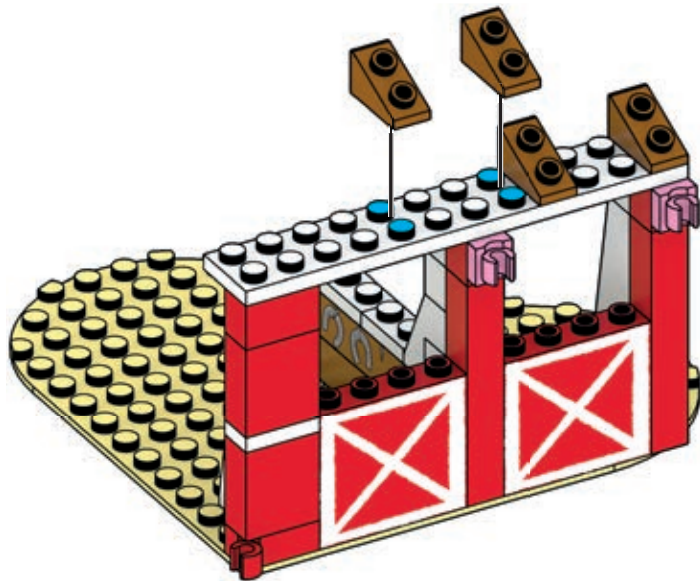

69

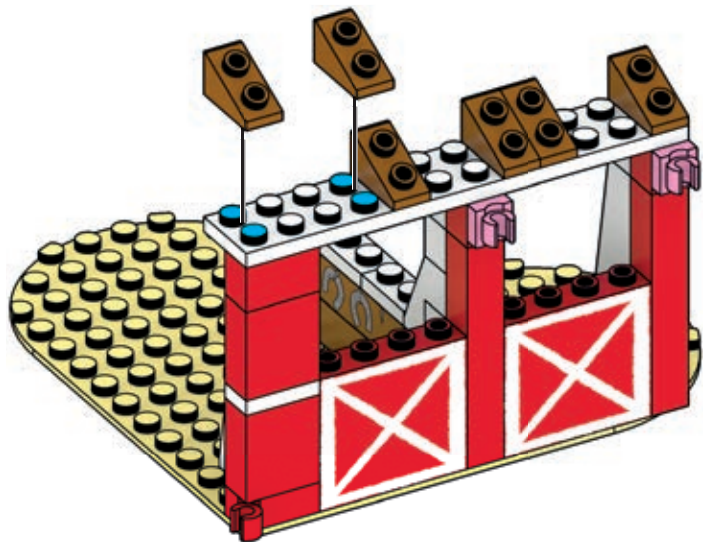

70

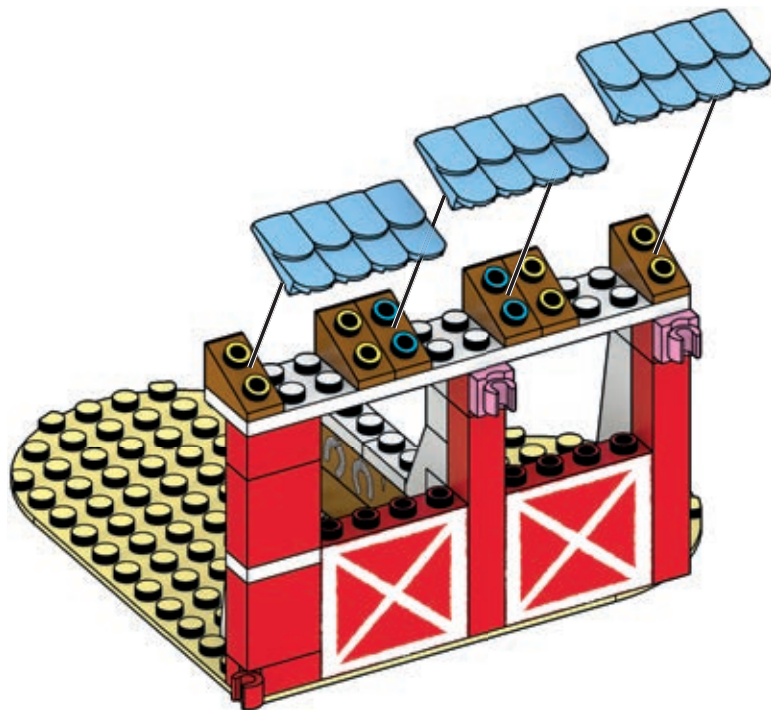

71

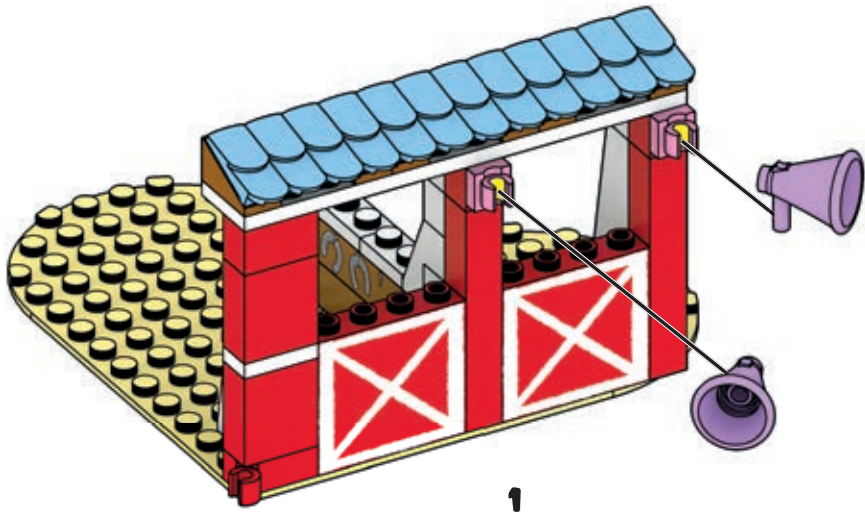

1

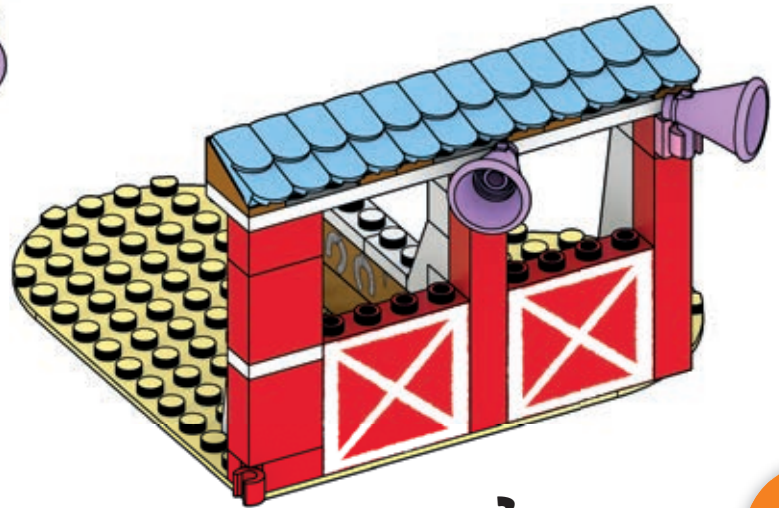

2

72

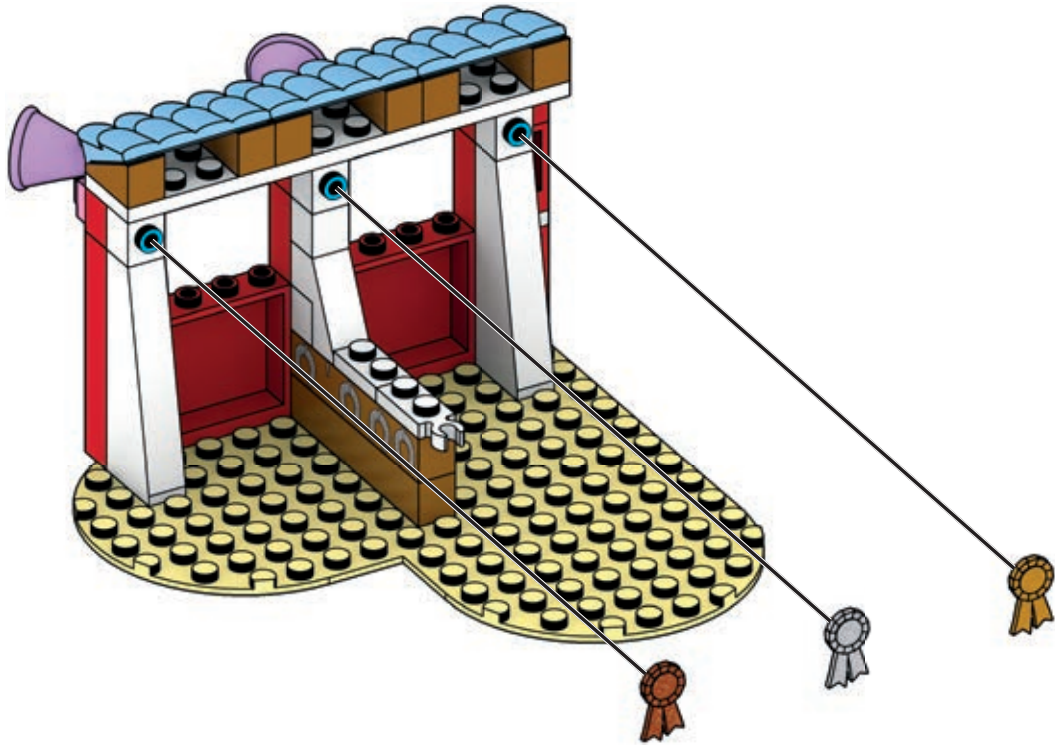

73

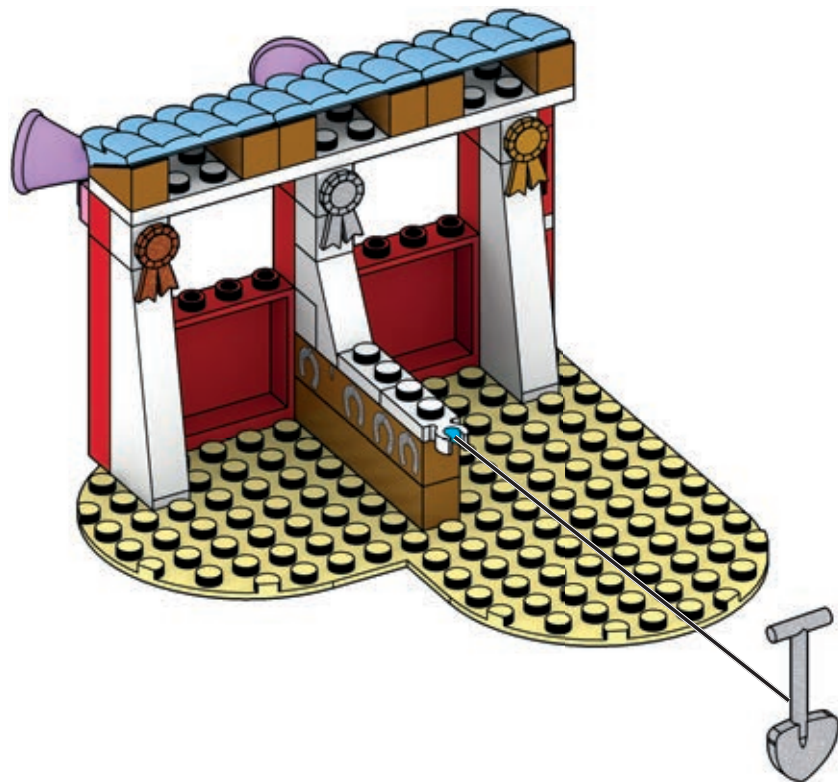

74

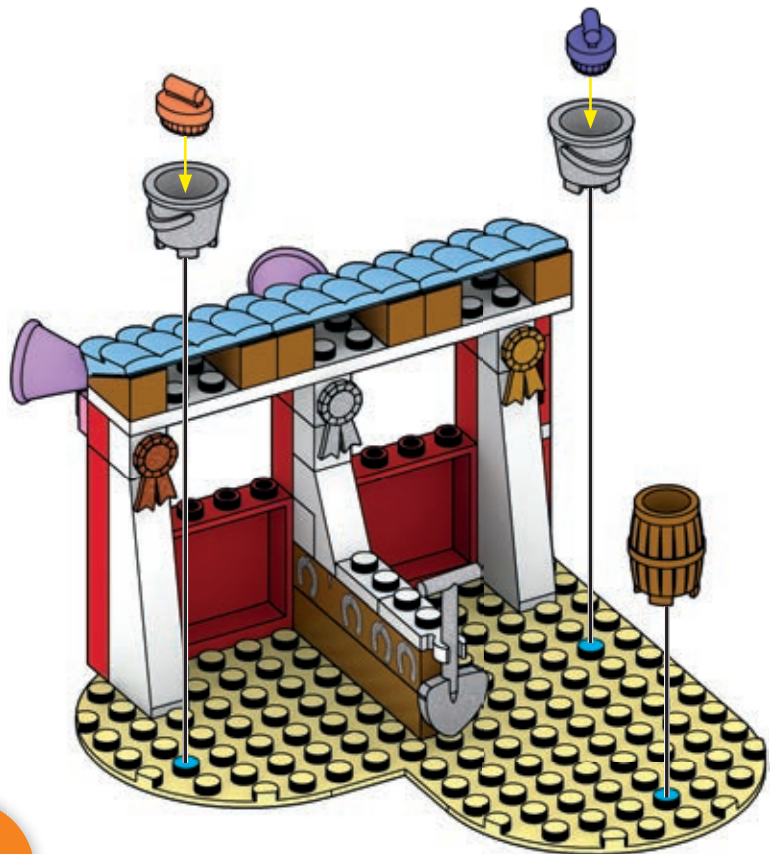

75





# LET'S PLAY! AMUSONS-NOUS!

IAJUGAR! • A BRINCAR!  
LASS UNS SPIELEN! • НАИГРАЕМ ИГРУ!



# LET'S BUILD THE GARDEN! CONSTRUIVONS LE JARDIN!



¡CONSTRUYAMOS UN JARDÍN!  
CONSTRUAMOS UM JARDIM!  
EINEN GARTEN BAUEN!  
ДАВАЙ СОБЕРЕМ САД!



# CUSTOMIZE YOUR BARBIE FIGURE! PERSONNALISEZ VOTRE FIGURINE BARBIE!

¡PERSONALIZA TU BARBIE! • PERSONALIZE SUA BARBIE!  
DIE BARBIE-FIGUREN INDIVIDUELL GESTALTEN!  
СДЕЛАЙ СВОЮ ФИГУРКУ БАРБИ УНИКАЛЬНОЙ!



1



2



1



2



1



2

76



1



2

77



1



2

78



1



2

79



1



2

80

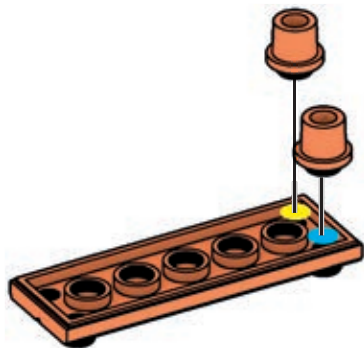

81

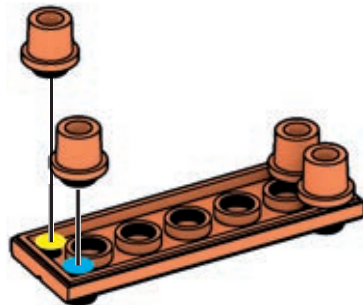

1

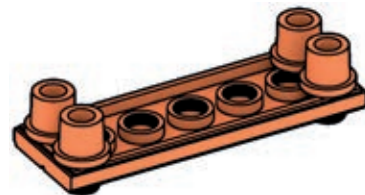

2

82

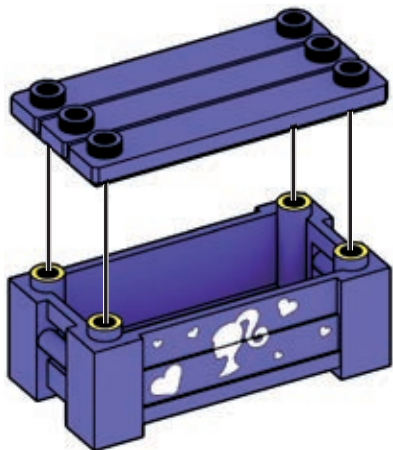
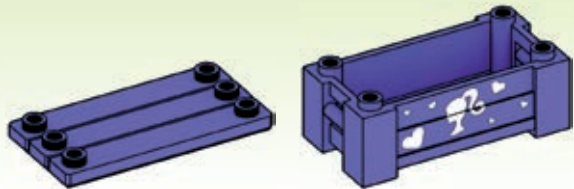

1



2



83

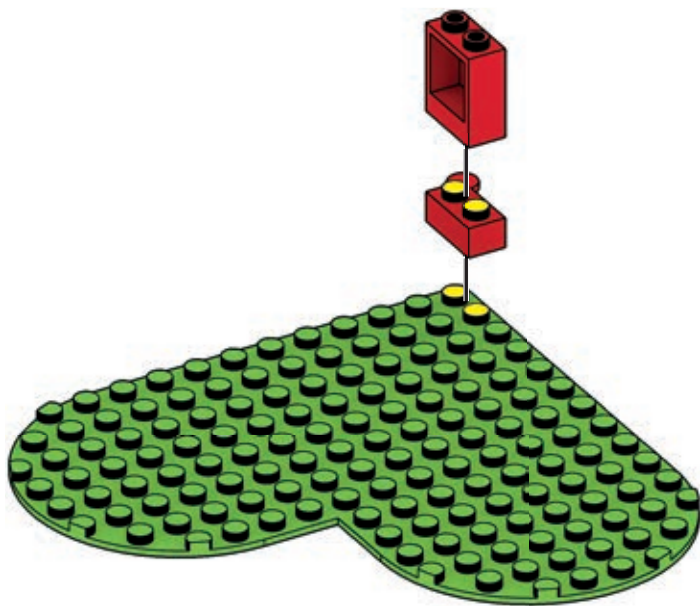
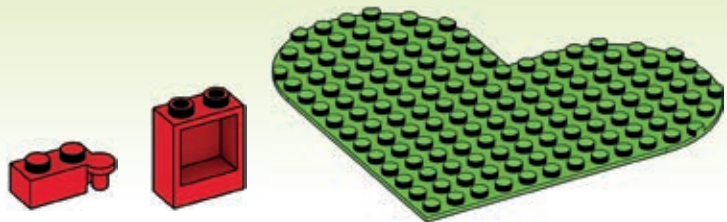



84

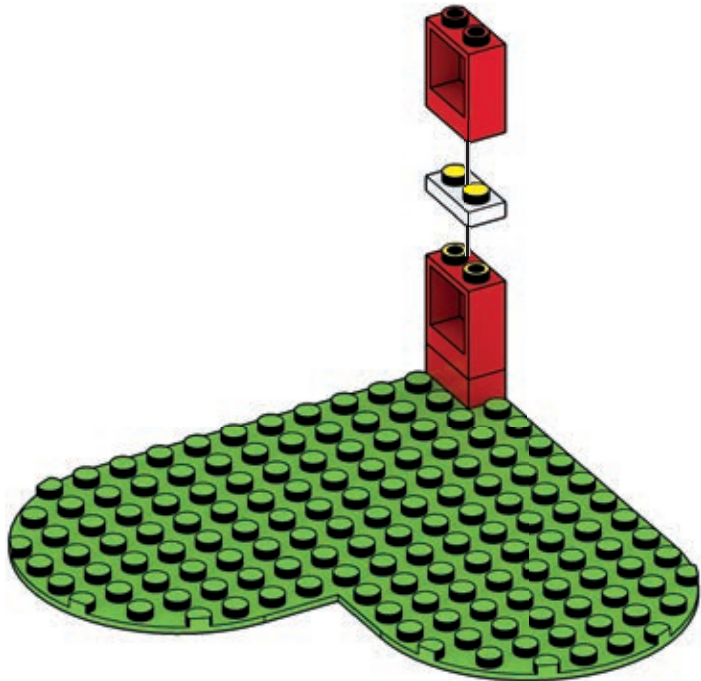

85

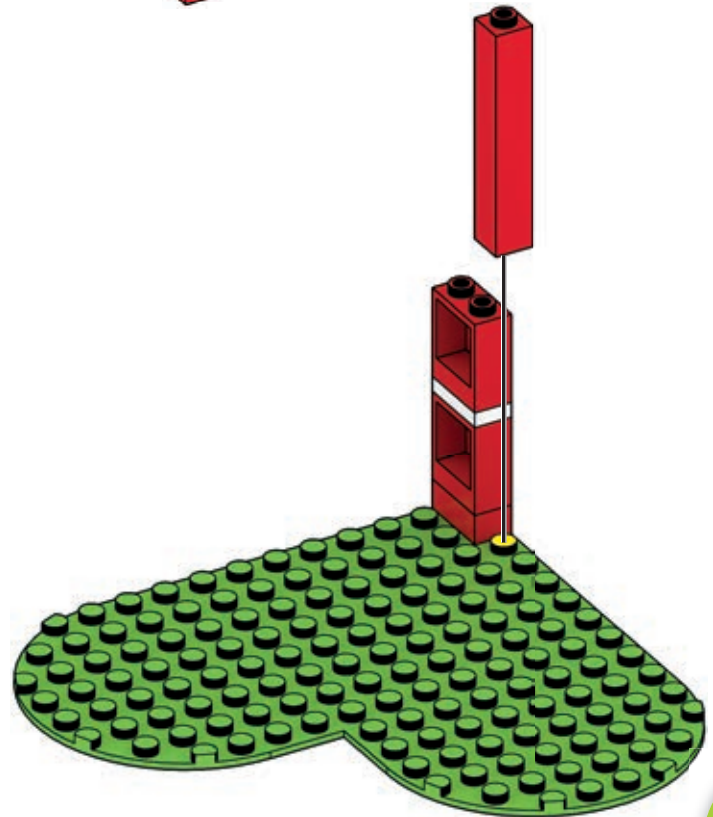

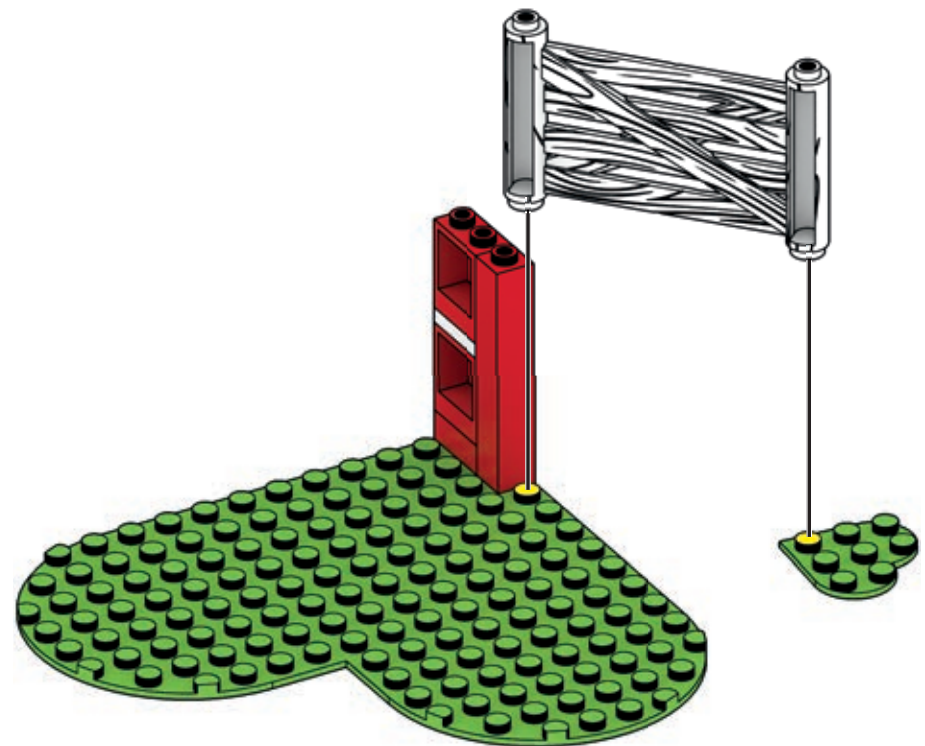
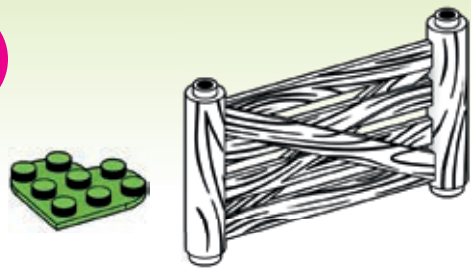

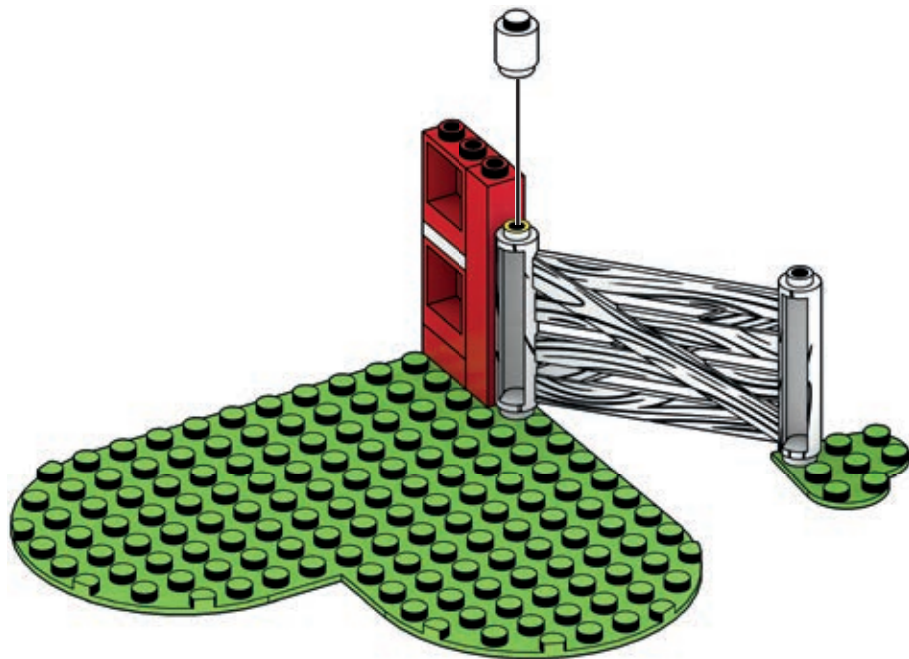

88

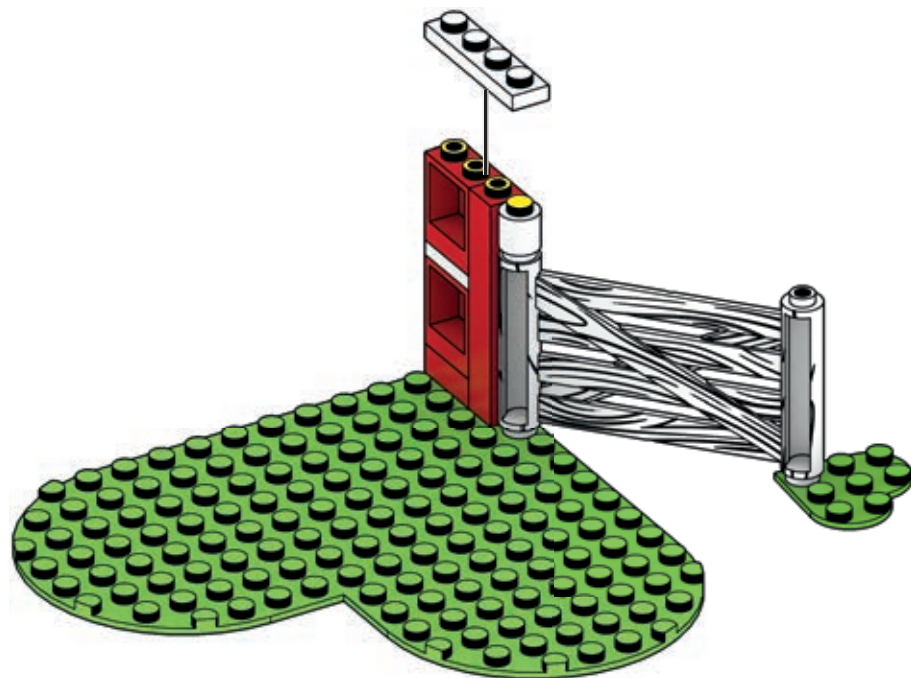



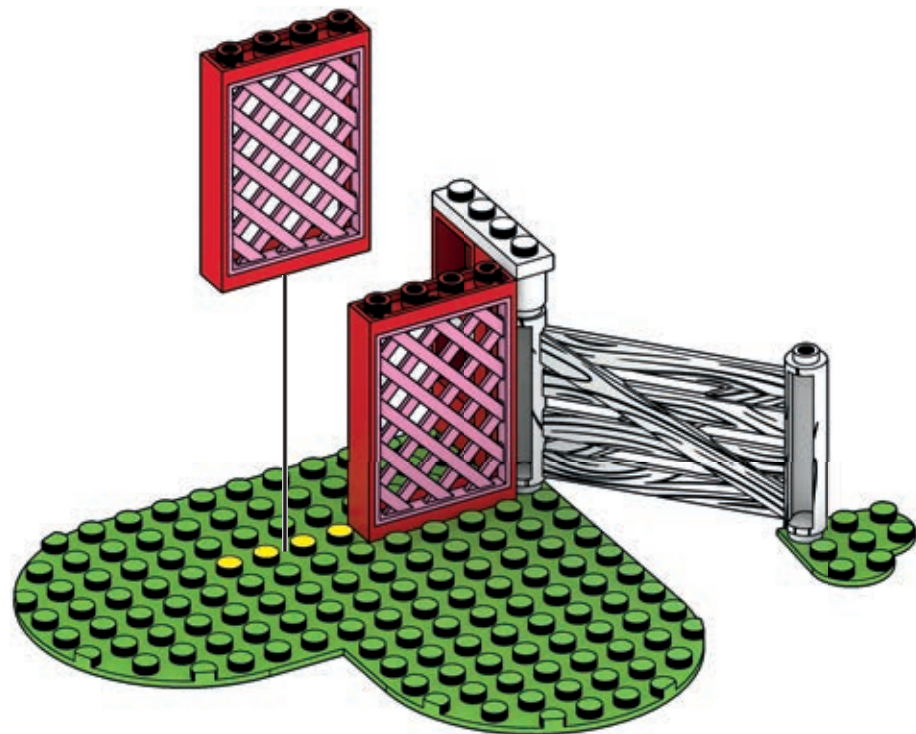

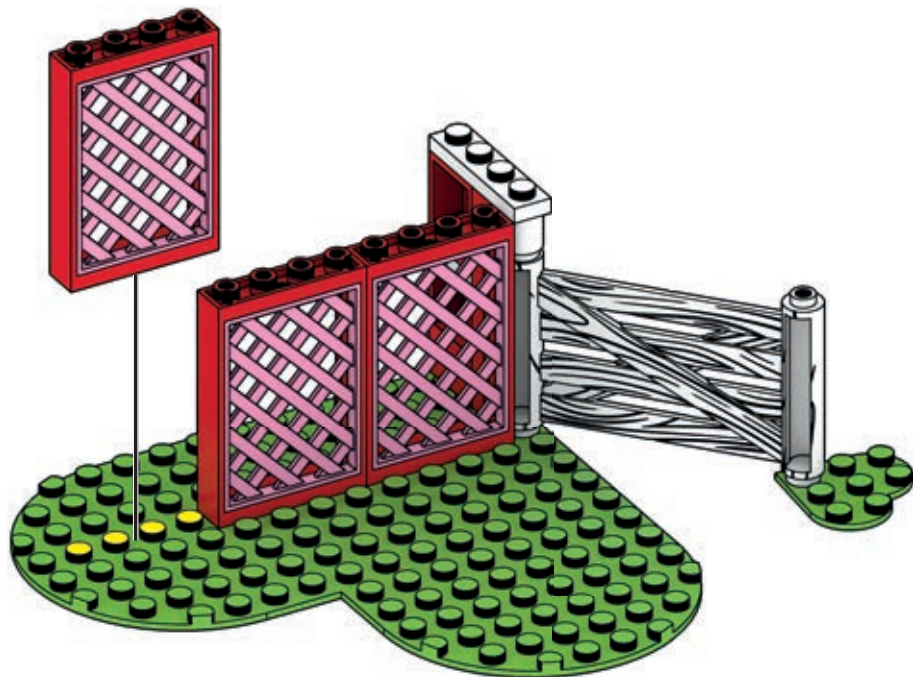

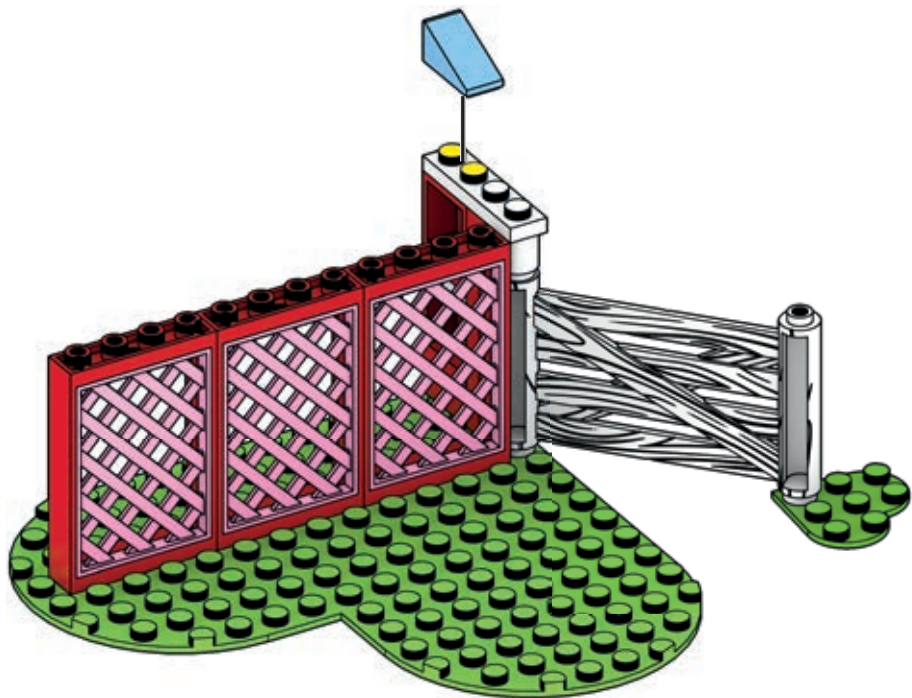



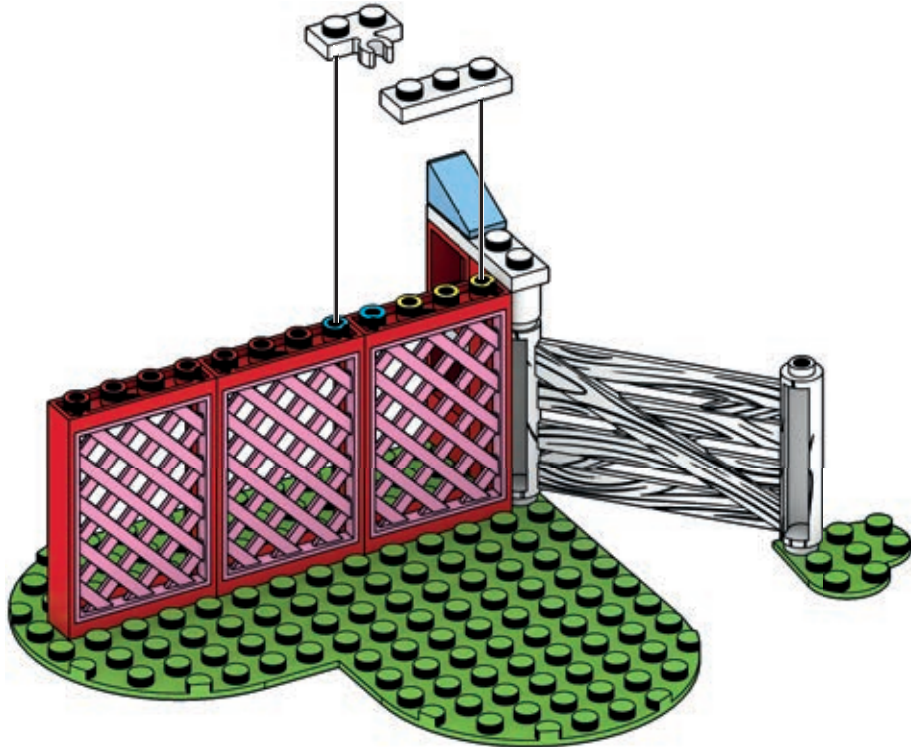

94

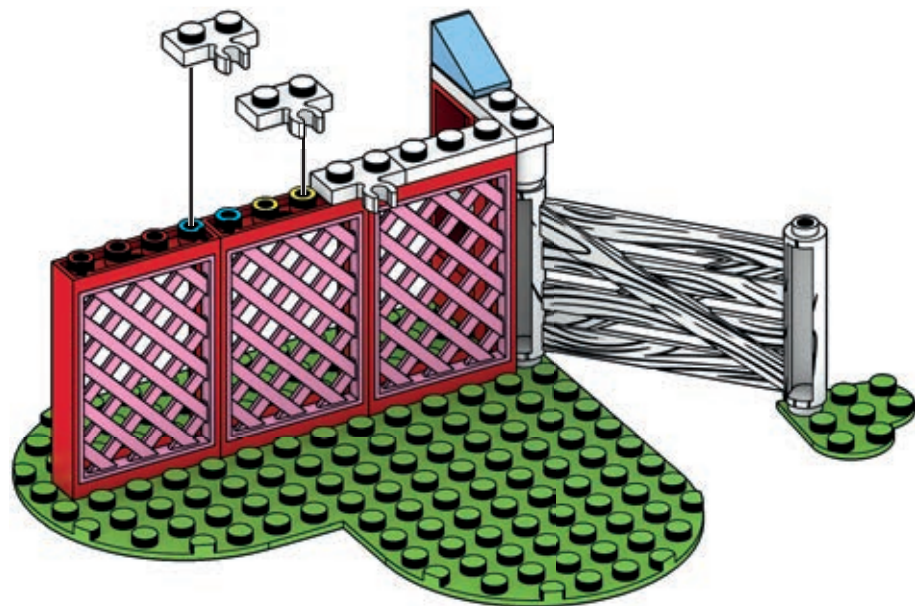

95

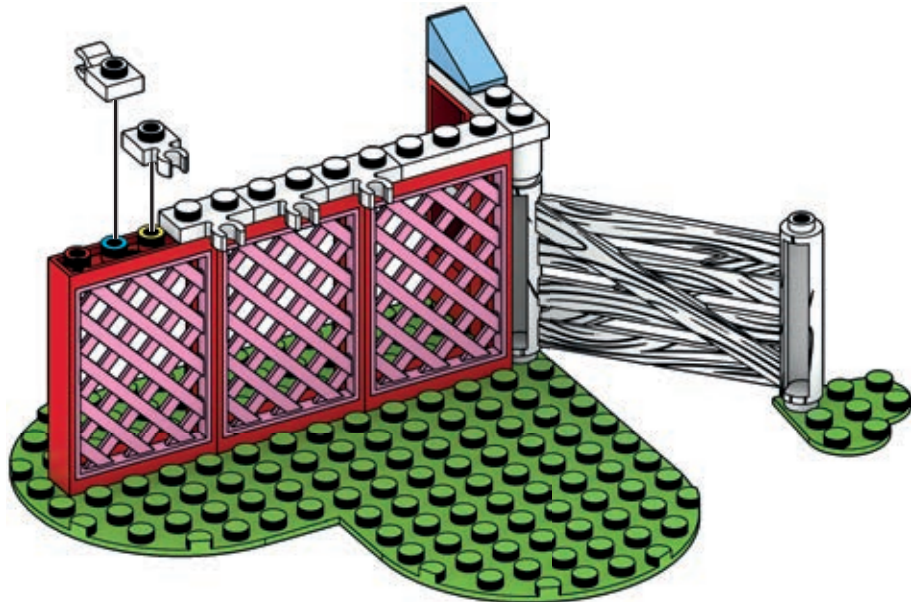

96

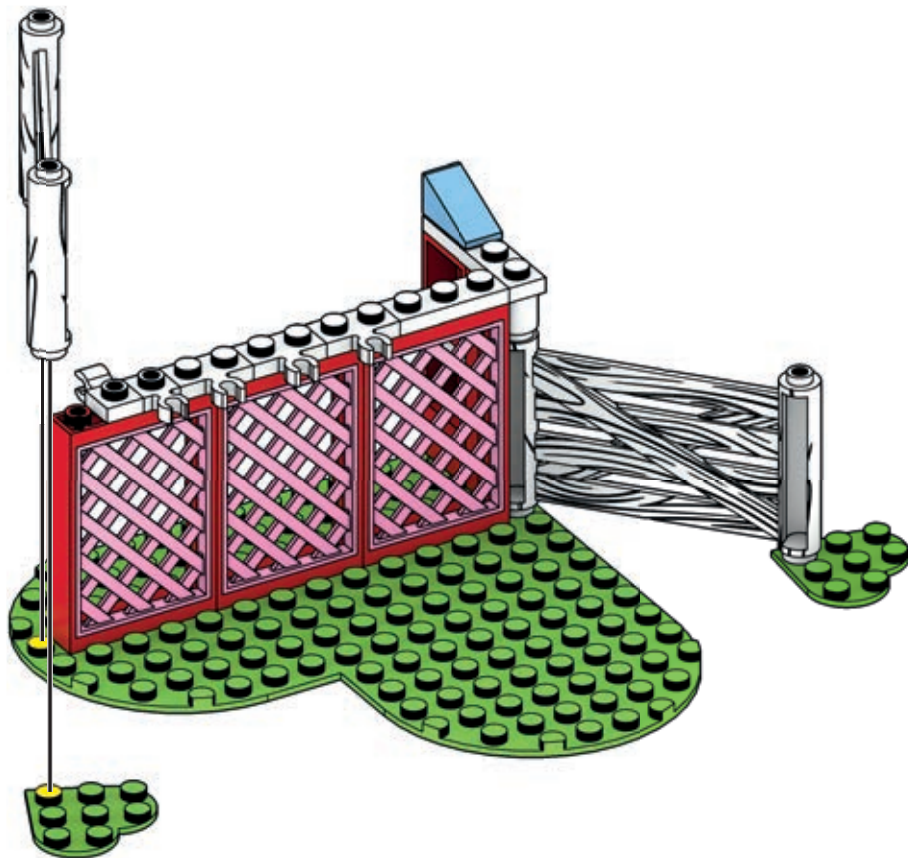
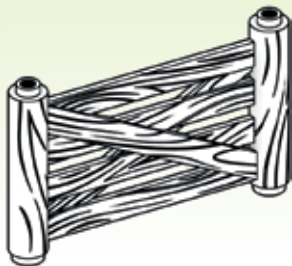

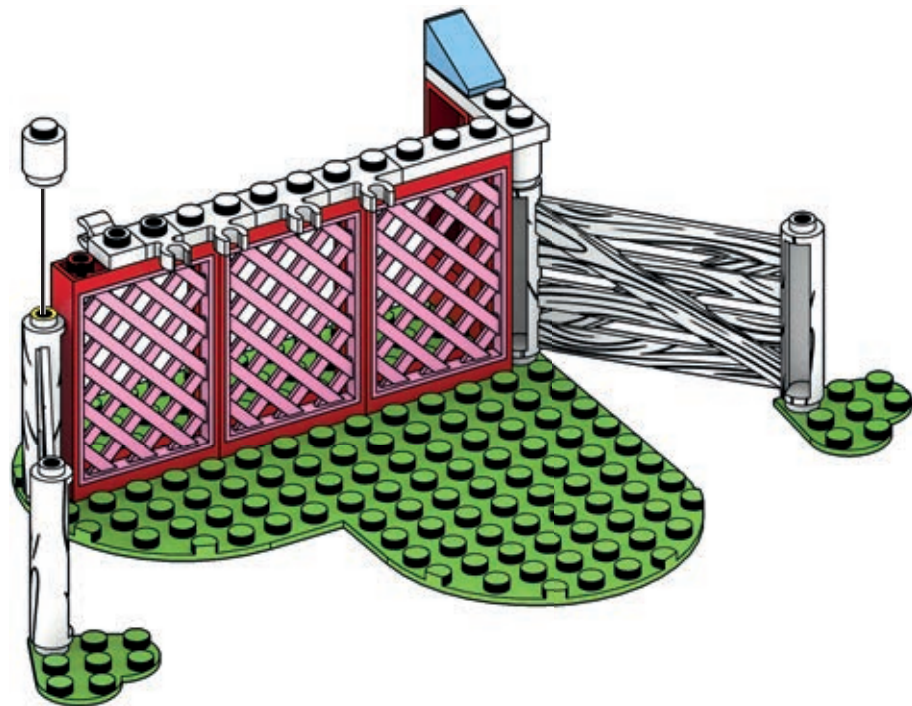

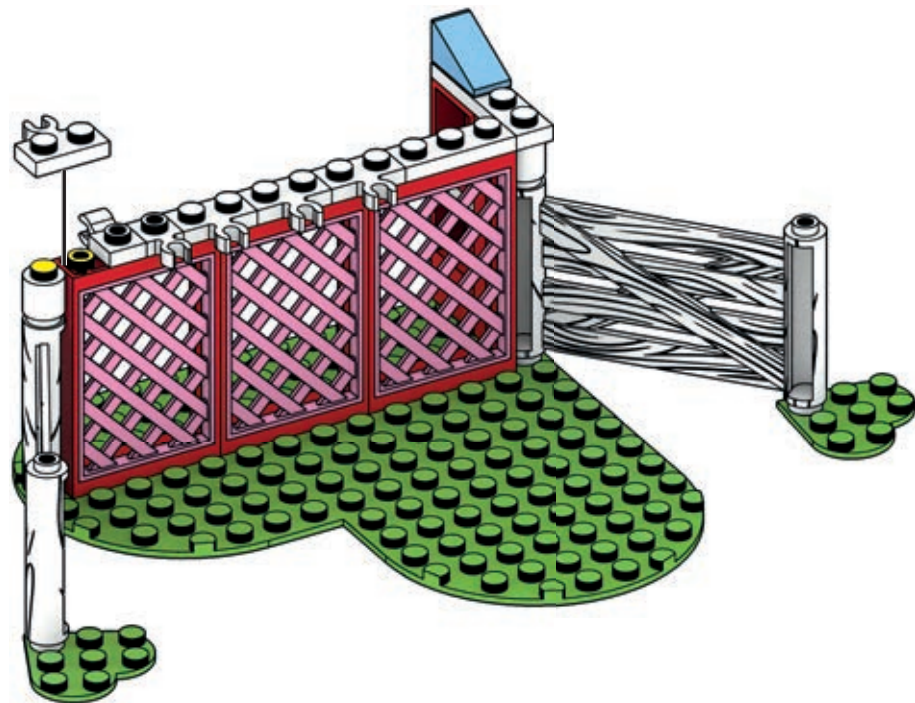

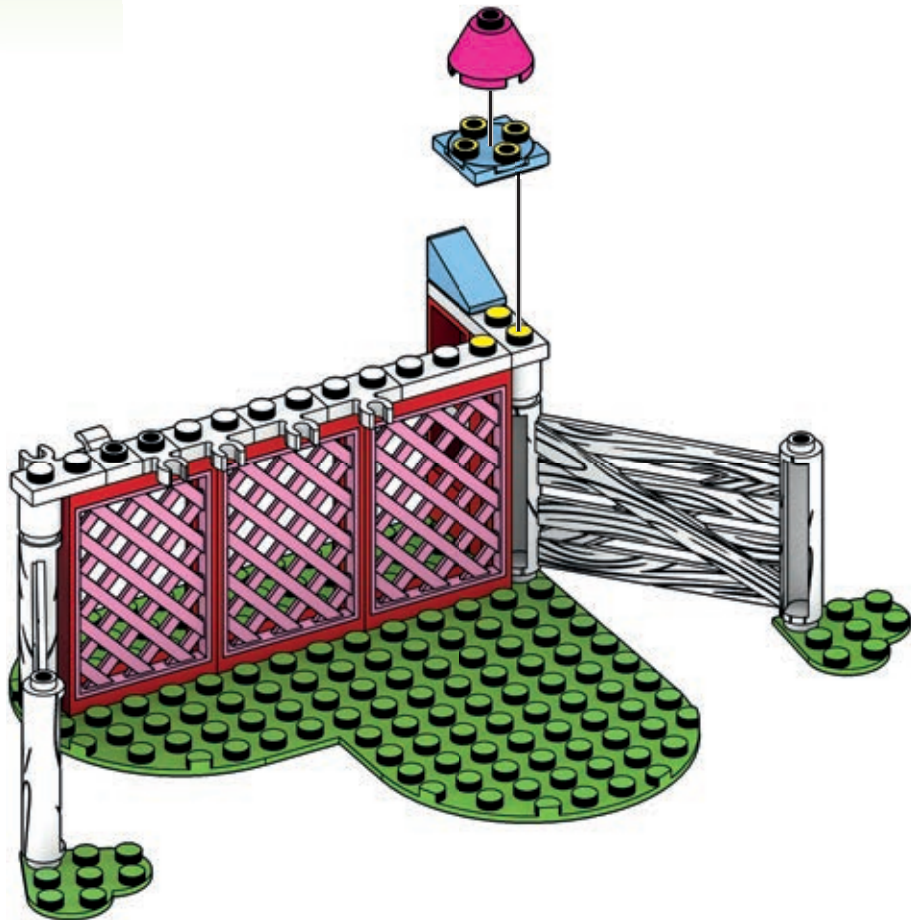

100

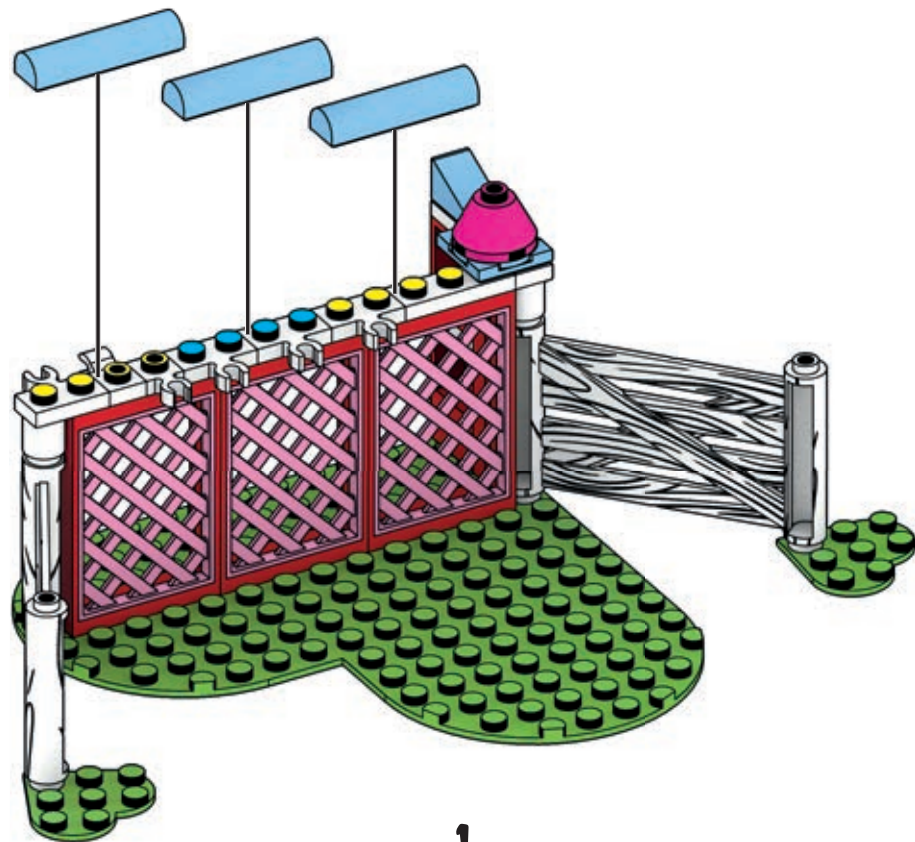



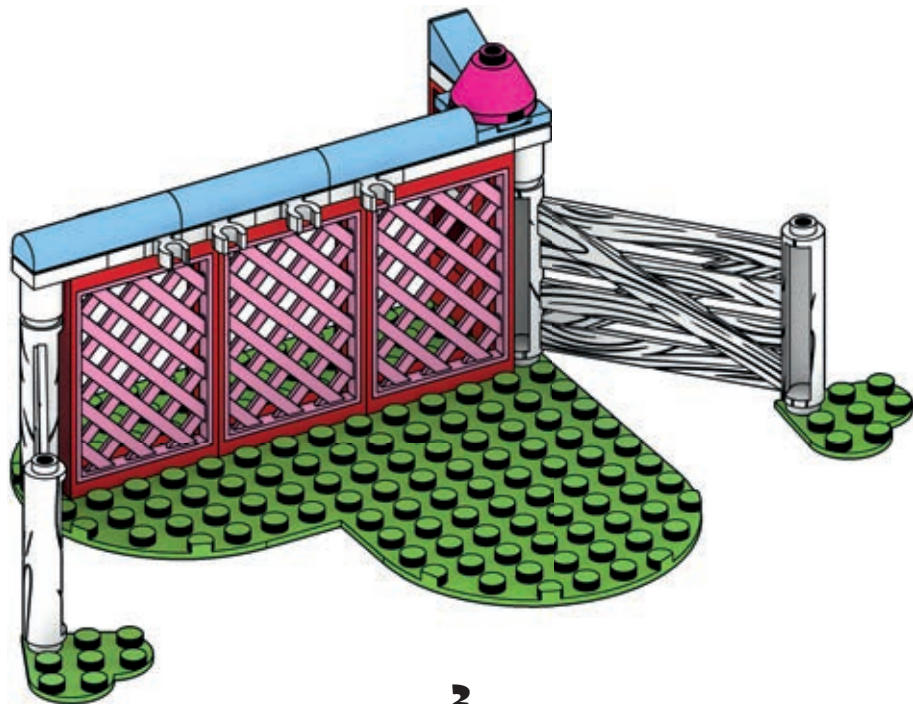

2

101

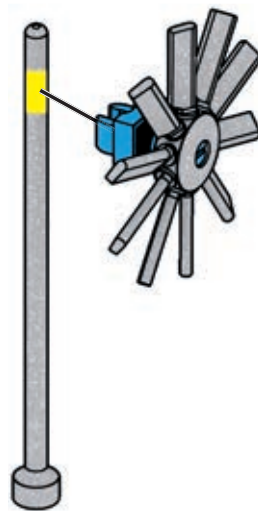
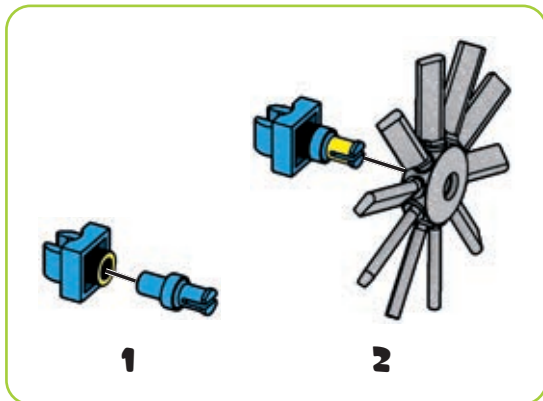

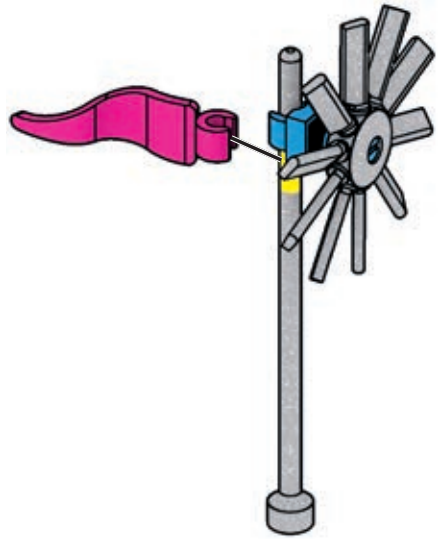

1

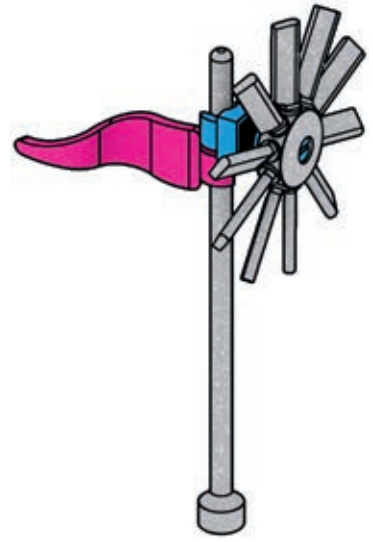

2

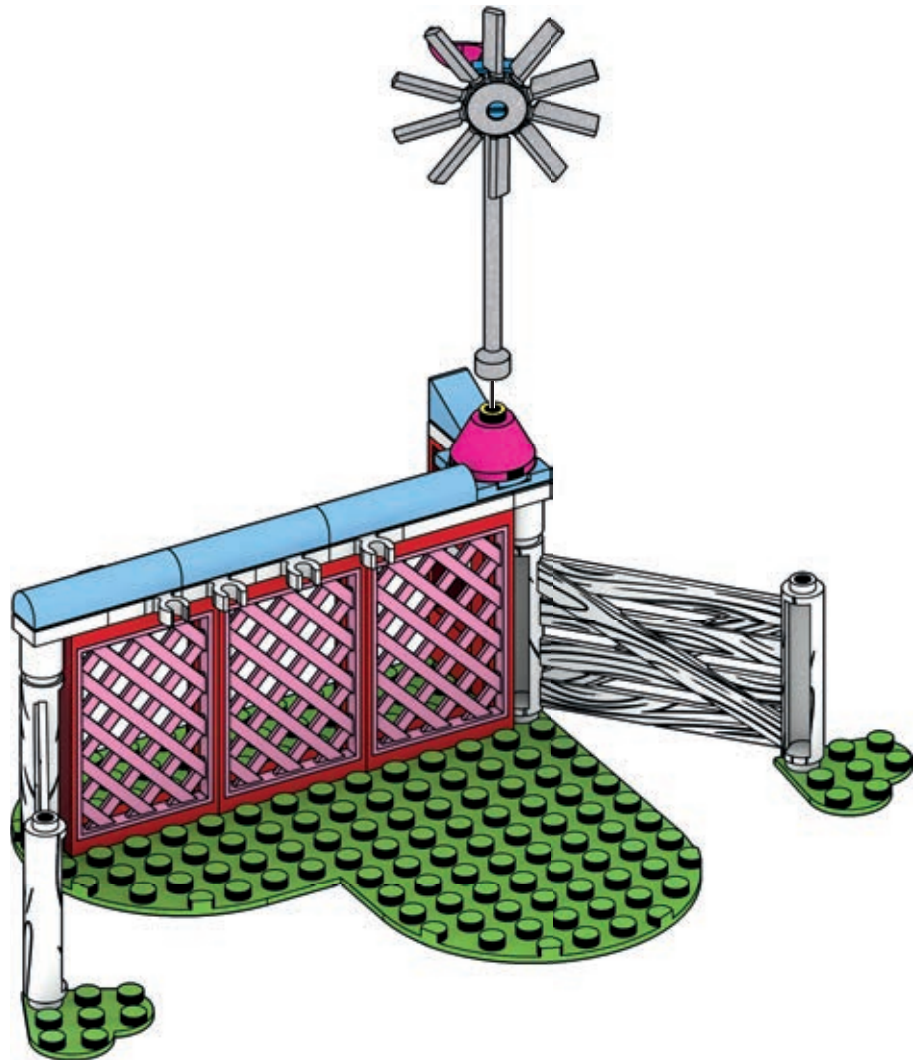

104

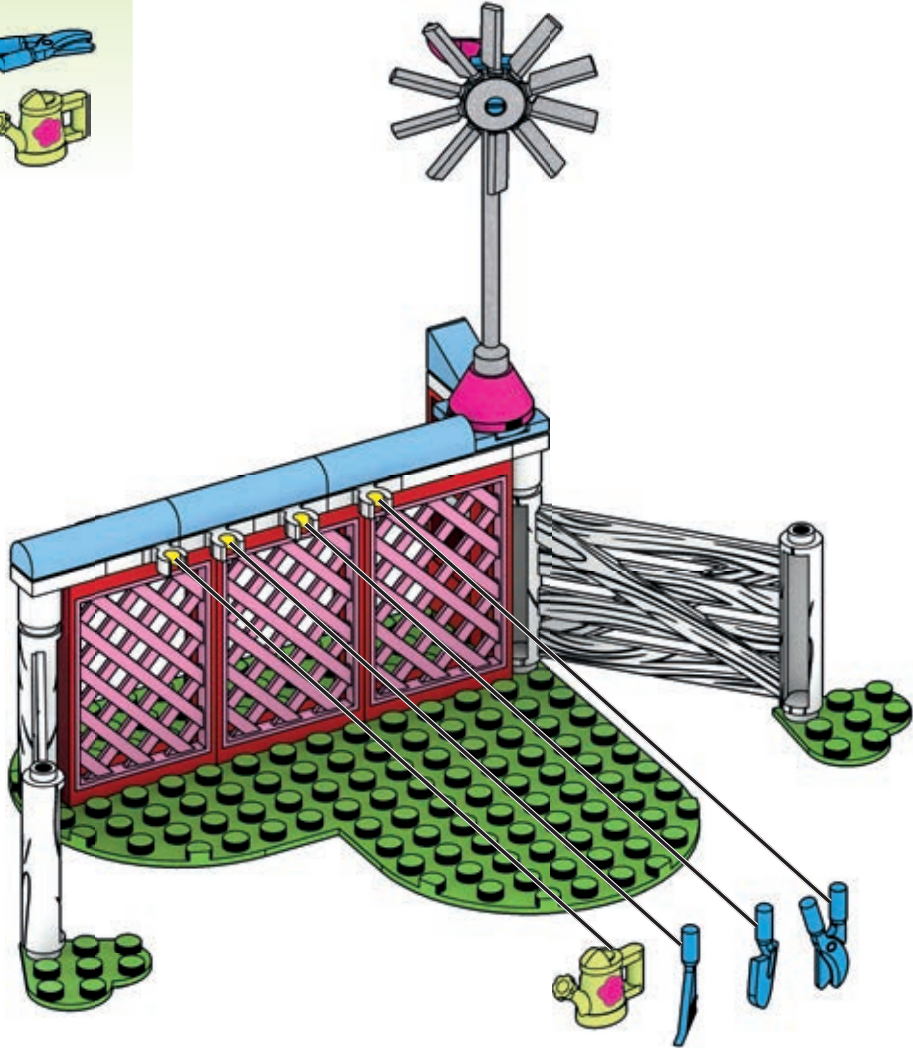
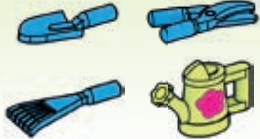







1





2

108

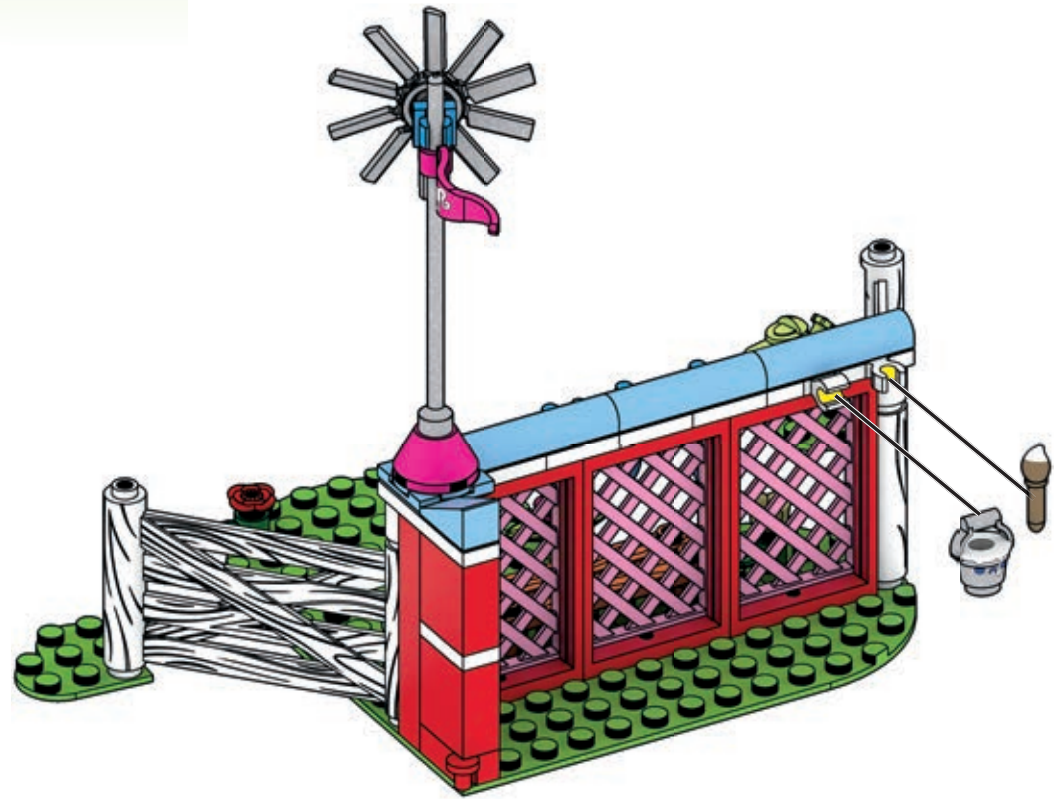

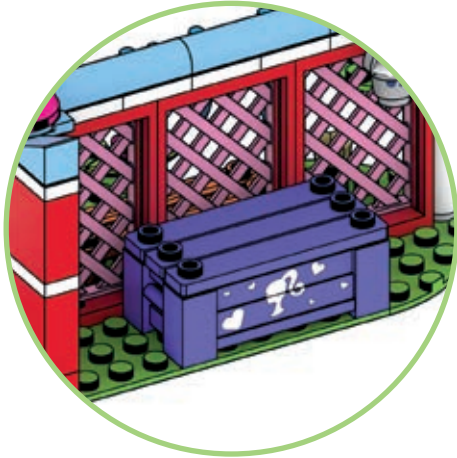
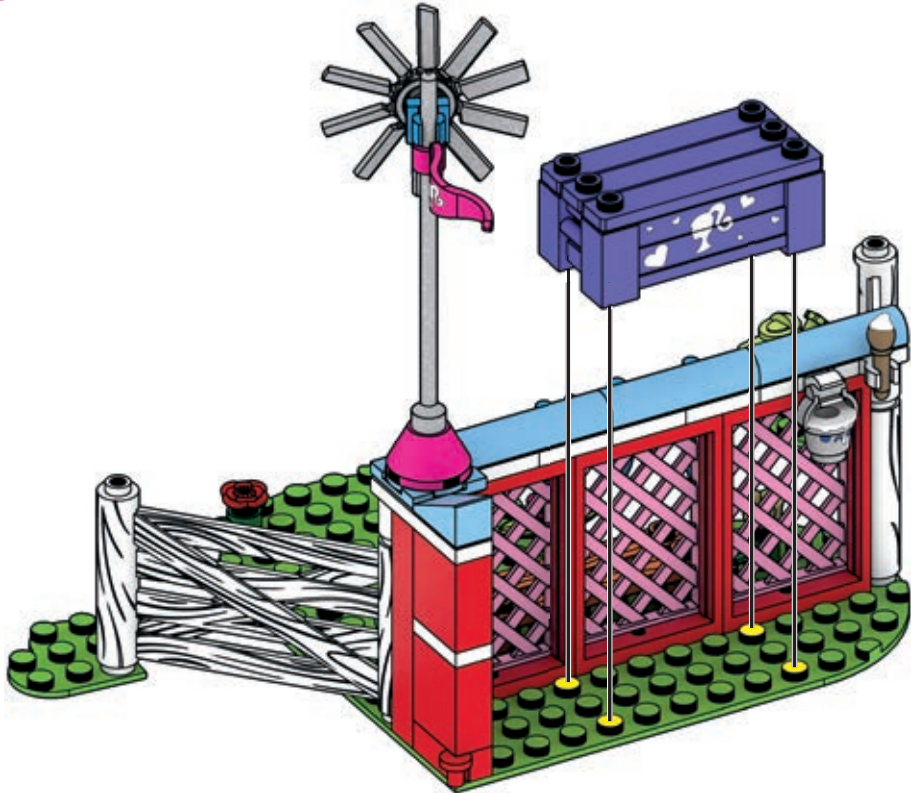

110

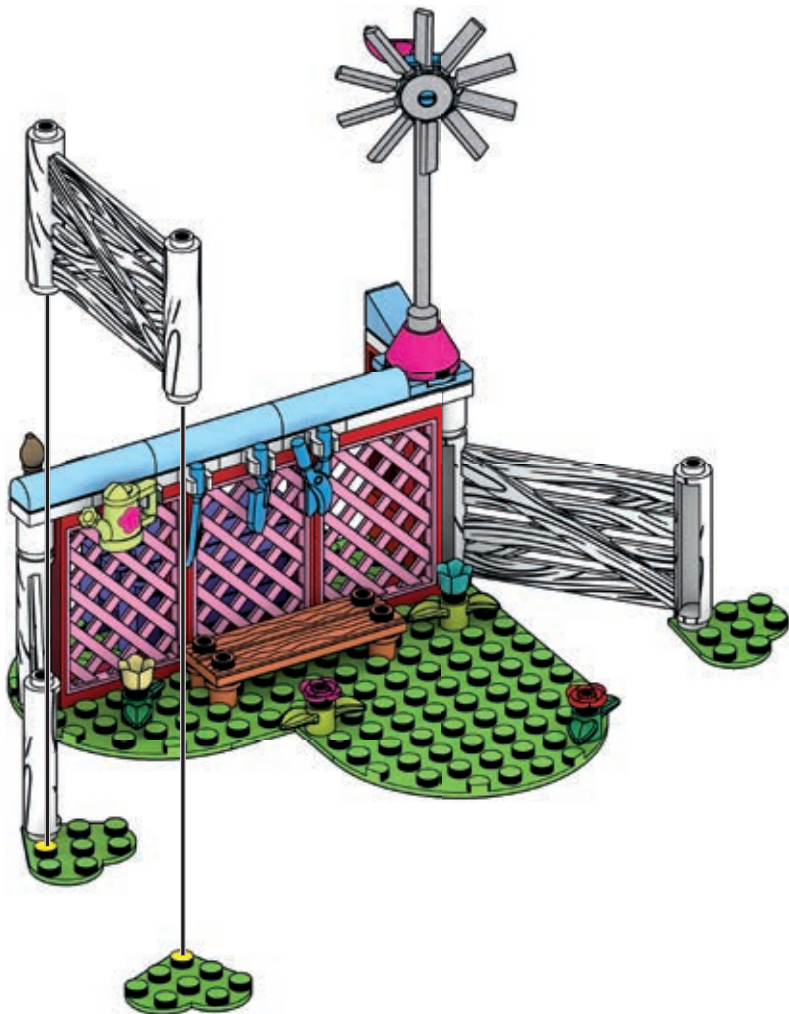
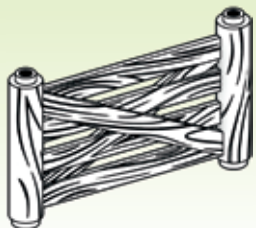

111



112

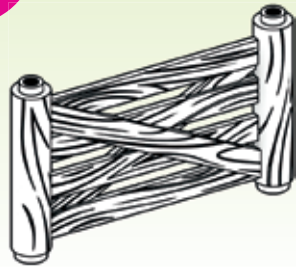

113

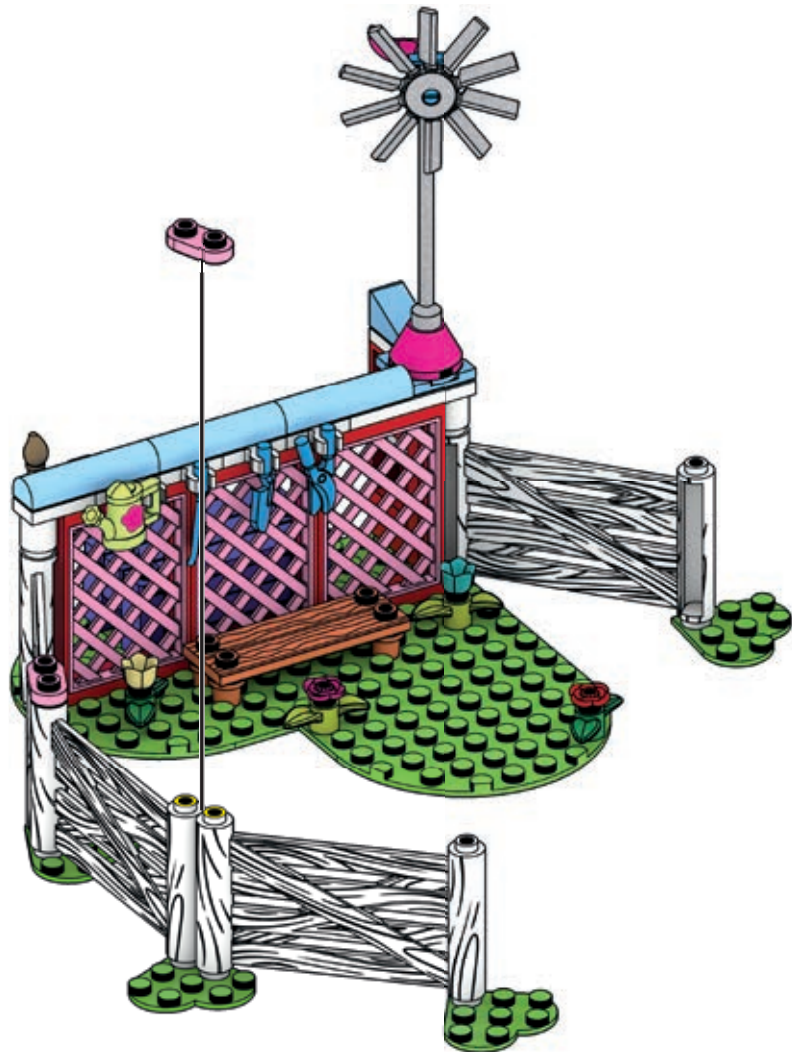

114

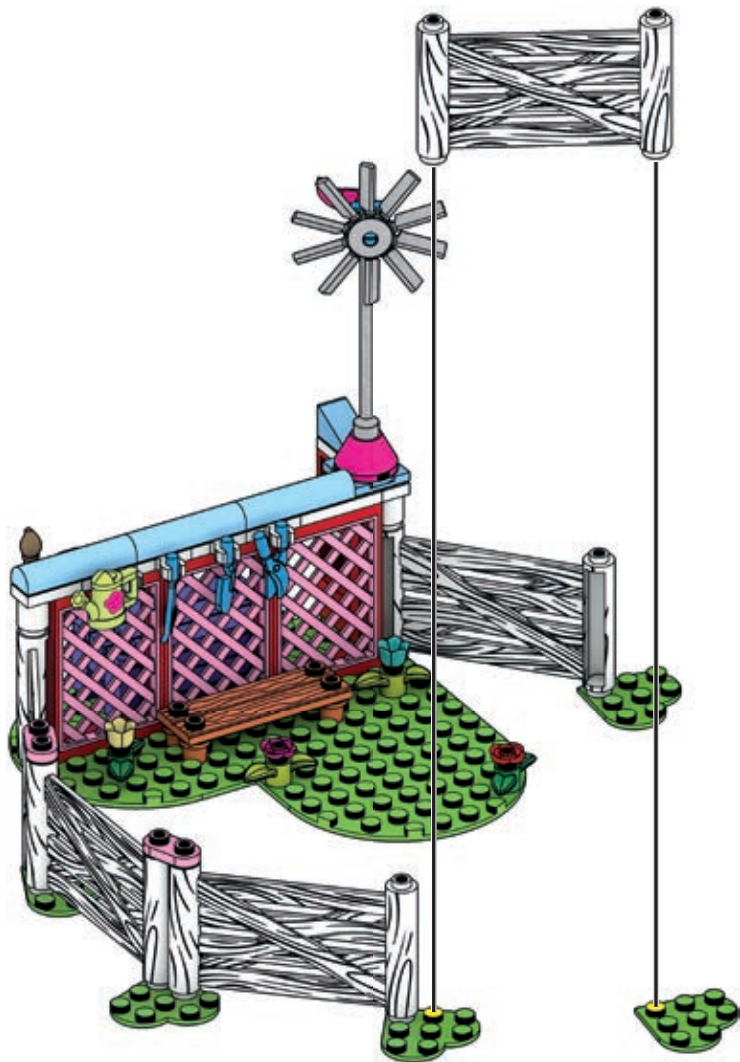
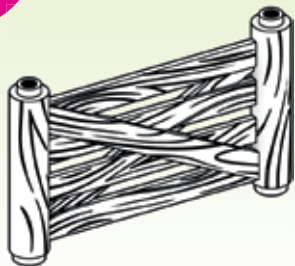



115

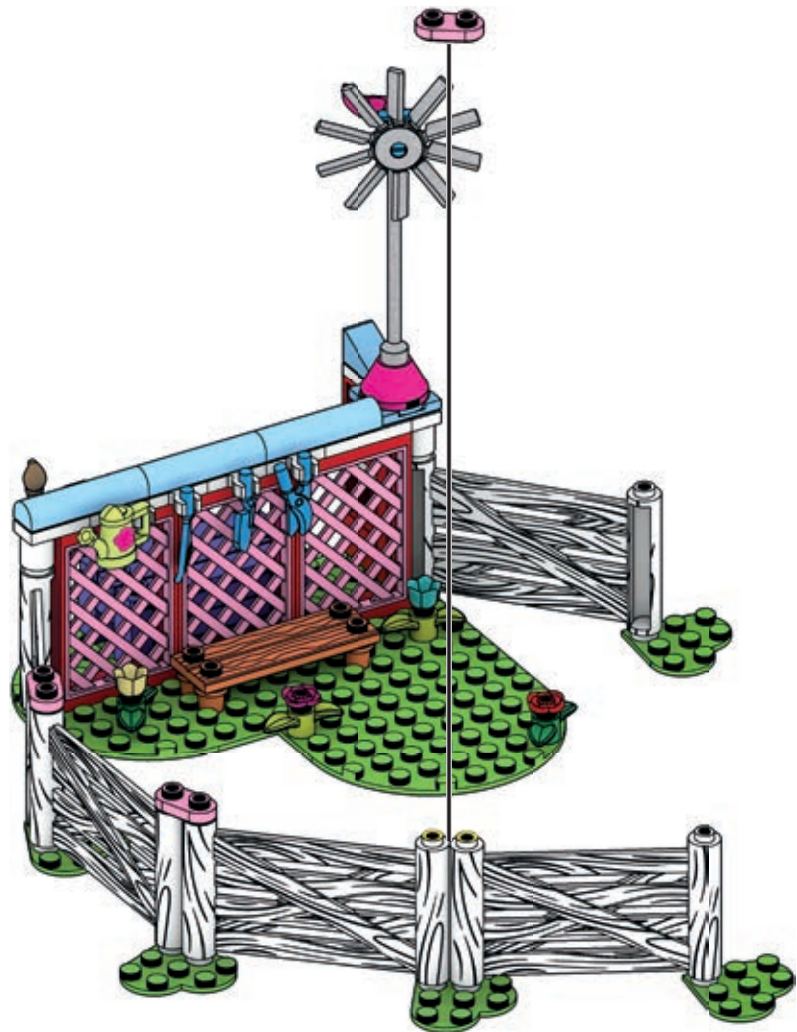

116

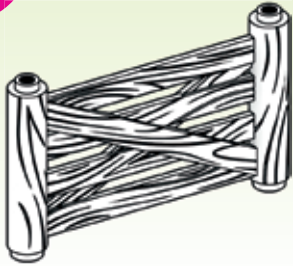

117



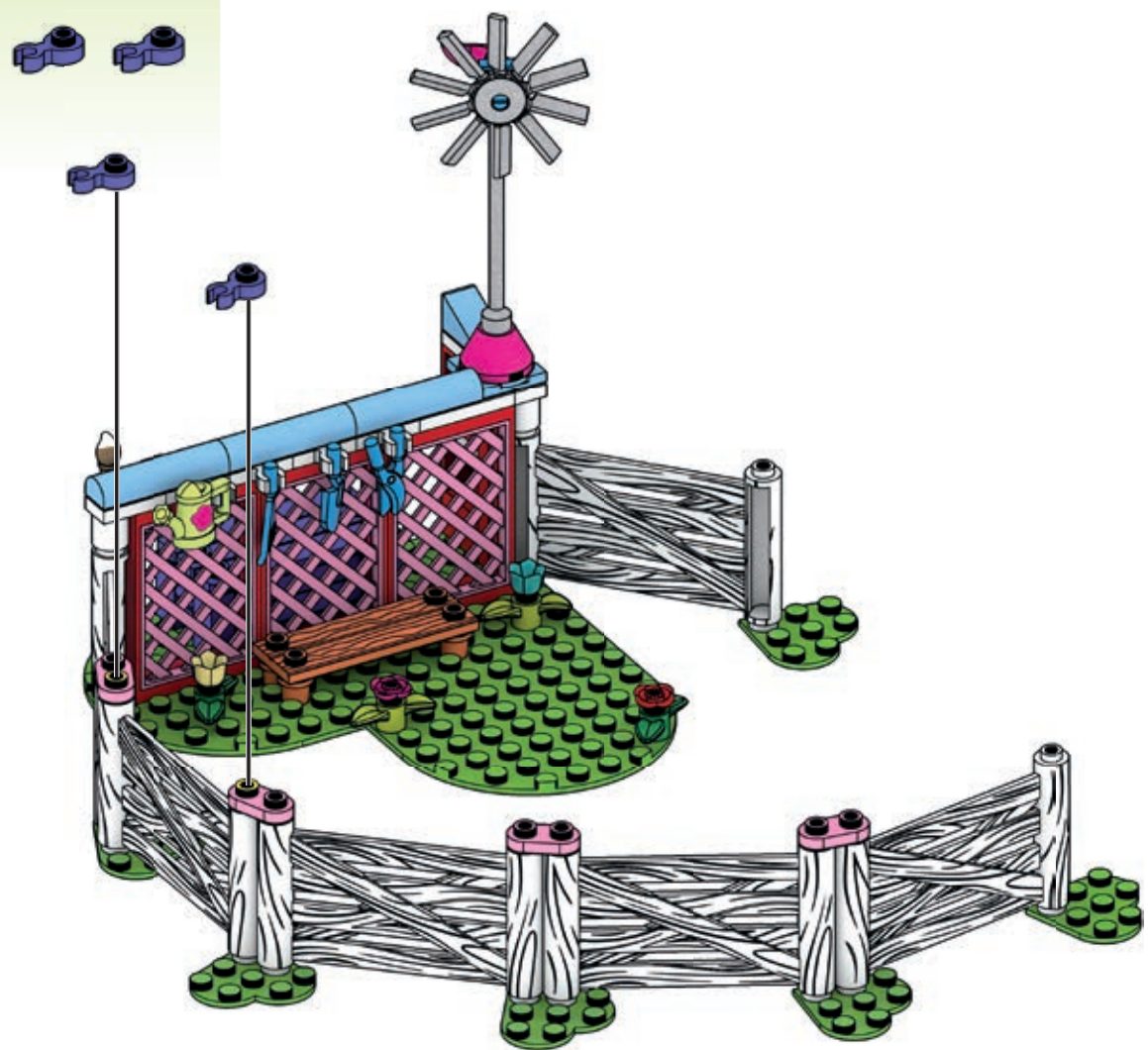

119

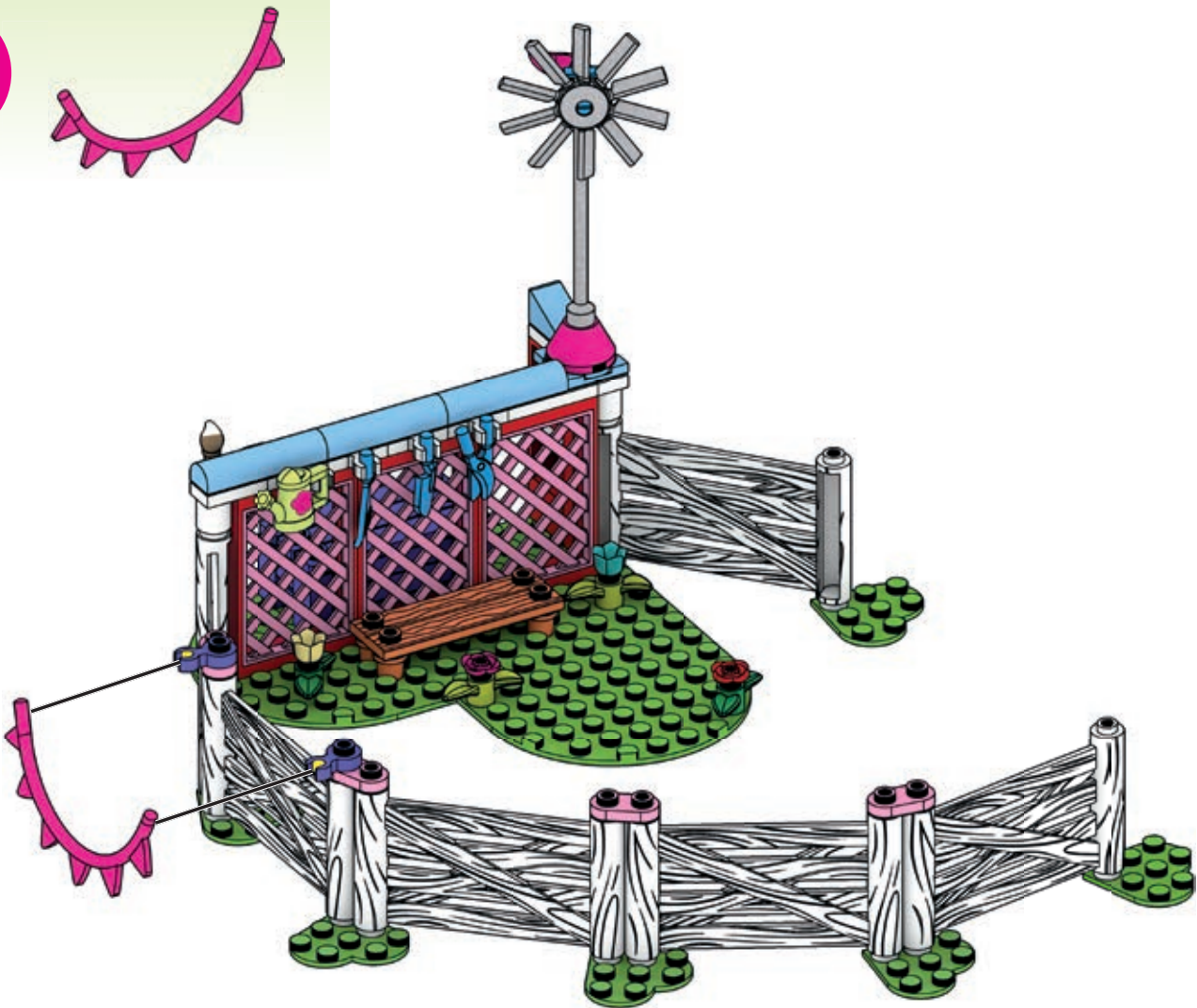

120

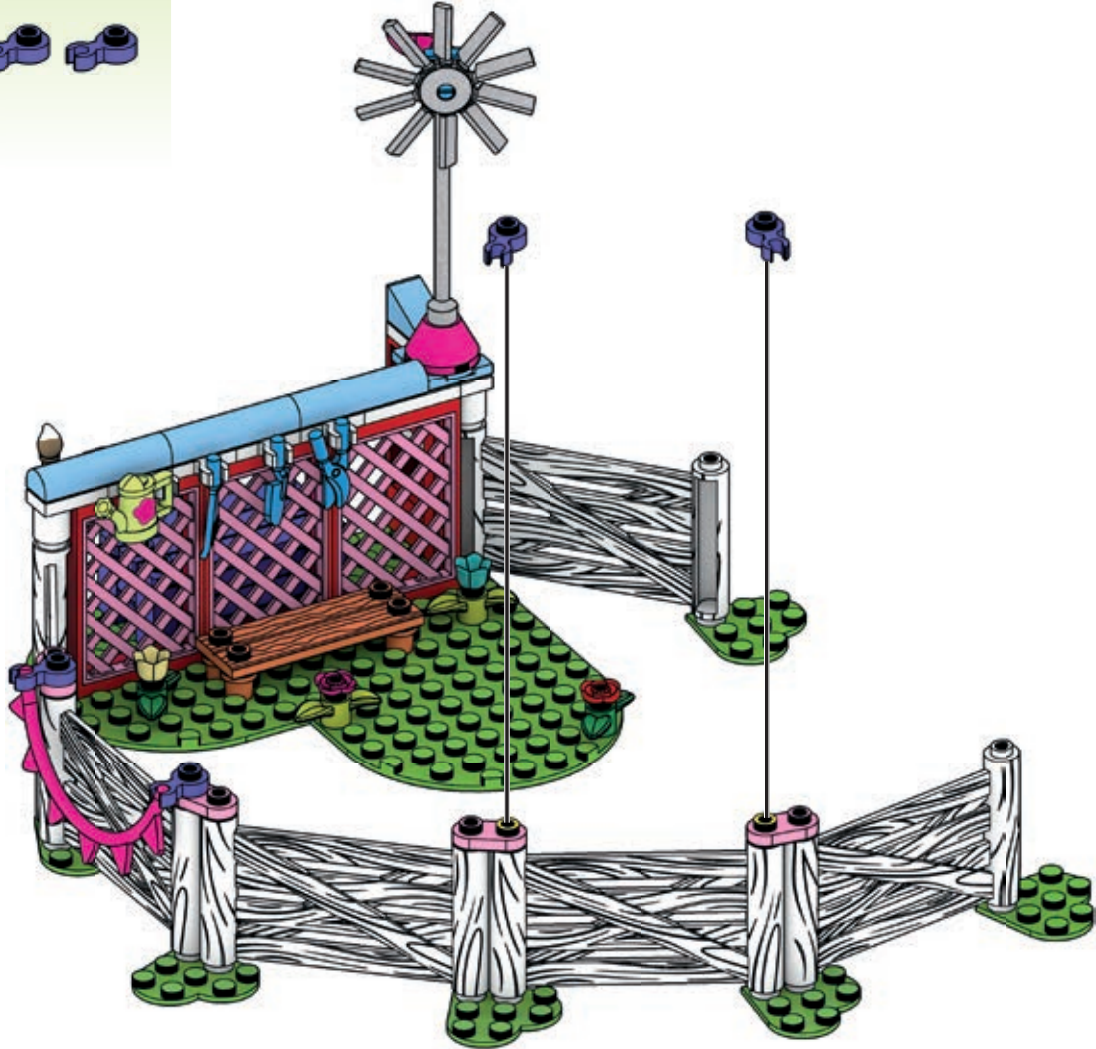

121

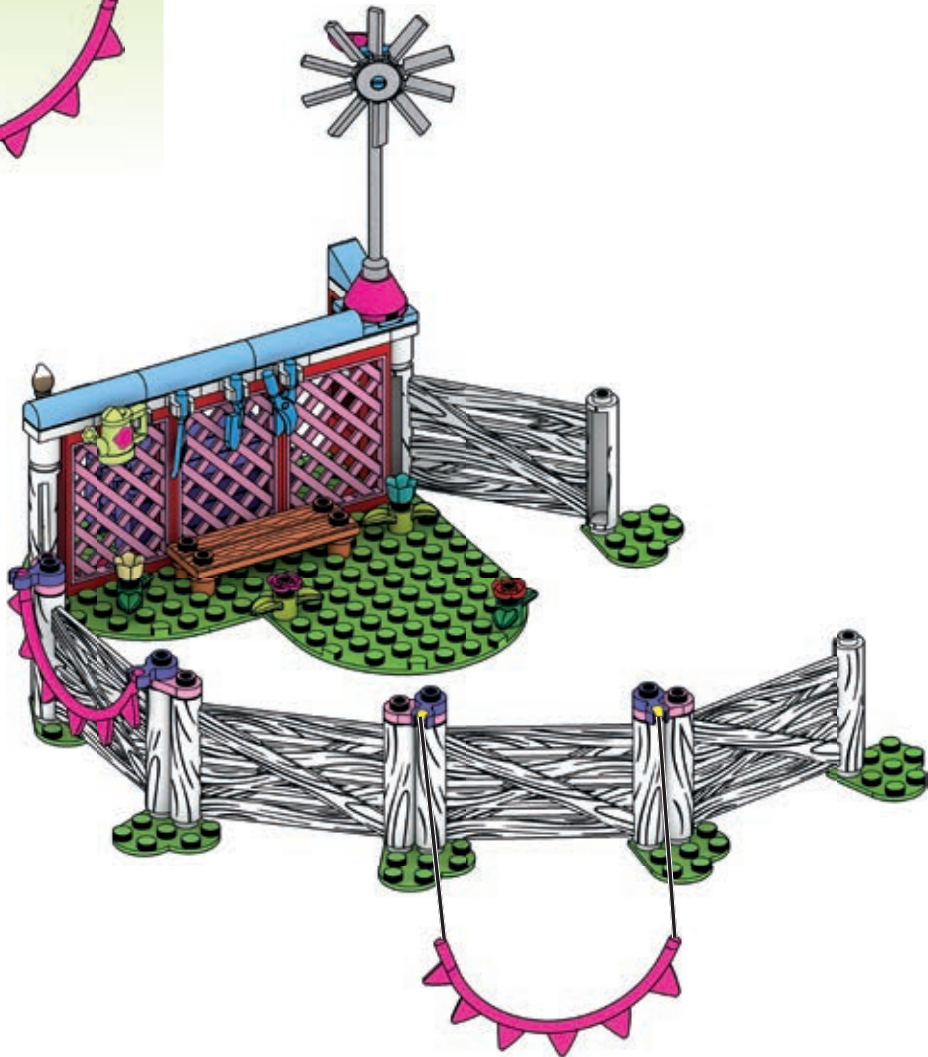

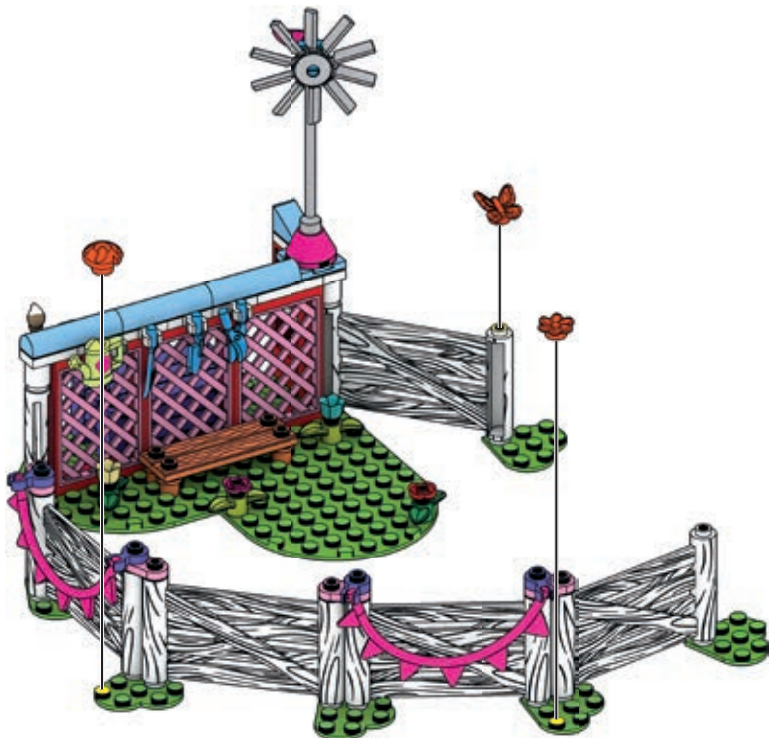

1



2



# LET'S PLAY! AMUSONS-NOUS!

ИЗУГАРИ! • A BRINCARI!  
LASS UNS SPIELEN! • НАИИНАЕМ ИГРУ!



123

47

75

122

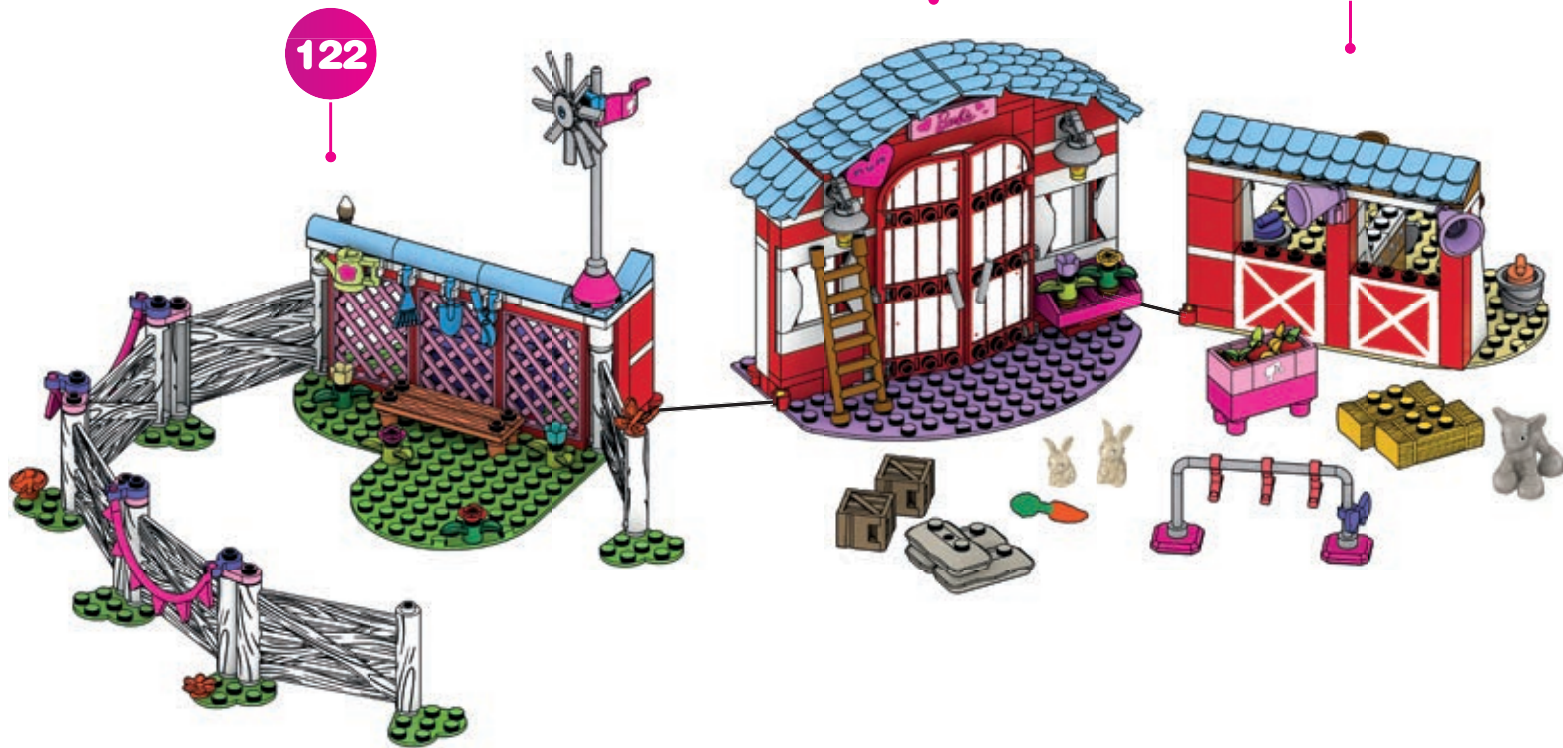

1



2

**FLIP THE BARN & PLAY INSIDE THE STABLES!**  
**RETOURNEZ LA GRANGE ET JOUEZ À L'INTÉRIEUR DE L'ÉCURIE!**

¡DALE LA VUELTA AL GRANERO Y JUEGA EN EL ESTABLO! • VIRA O CELEIRO E BRINCA DENTRO DOS ESTÁBULOS!  
DIE SCHEUNE UMDREHEN UND IN DEN STÄLLEN SPIELEN! • ПЕРЕВЕРНИ КОНЮШНЮ И ИГРАЙ СО СТОЙЛАМИ!





**PLAY OUTSIDE THE STABLES!  
JOUÉZ À L'EXTÉRIEUR DE L'ÉCURIE!**

¡JUEGA FUERA DEL ESTABLO! • BRINCA FORA DOS ESTÁBULOS!  
AUSSERHALB DER STÄLLE SPIELEN! • ИГРАЙ РЯДОМ С КОНЮШНЕЙ!





## COMBINE THE GARDEN AND STABLE FOR A HORSE SHOW! COMBINEZ LE JARDIN ET L'ÉCURIE POUR ORGANISER UN SPECTACLE ÉQUESTRE!

¡COMBINA EL JARDÍN Y LOS ESTABLOS PARA UN ESPECTÁCULO DE CABALLOS!  
MISTURE O JARDIM E OS ESTÁBULOS PARA UM ESPETÁCULO DE CAVALOS!  
DEN GARTEN UND DIE STÄLLE FÜR EINE PFERDE-SHOW KOMBINIEREN!  
ОБЪЕДИНИ САД И КОНЮШНЮ ДЛЯ ВЫСТАВКИ ЛОШАДЕЙ!

1



2



2x AM01113MY	1x AM18623GX	3x AM07629E	1x AM77912ATH	2x AM09393AMC	2x AM73974APG	2x AM09013AMC	1x AM10931MY	1x AM78710GX
3x AM78802AMC	2x AM19999ASX	2x AM07629APG	1x AM77912APG	4x AM19660E	1x AM01404ATC	1x AM72917E	2x AM17153AMC	1x AM78711GX
1x AM78803BBG	1x AM73975AMP	2x AS-HDJ87-07	1x AM77912APG	2x AM74016APG	1x AM01404ATC	4x AM72917APG	2x AM17153AMC	1x AM01314E
3x AM78803BYE	1x AM73975AAD	1x AS-HDJ87-07	1x AS-HDJ87-14	1x AS-HDJ87-10	4x AM80573AMC	4x AM15484AMC	1x AM09023AMC	1x AS-HDJ87-06
2x AM78803HT	1x AM73975AAD	1x AM75176MCX	1x AS-HDJ87-14	2x AS-HDJ87-10	3x AM76559AMC	4x AM15484AMC	1x AM09023AMC	1x AM09593E
1x AM72954AMC	4x AM81164AAD	1x AM75176MCX	2x AM76026NL	2x AM77226APG	3x AM76560AMC	2x AM73009ATC	8x AM03872AMC	4x AM09838E
1x AM72954ATC	4x AM81164ATC	1x AM75174MCX	4x AM12251AMP	1x AM78169AWU	3x AM76560AMC	5x AM03773AMC	4x AM04218AMC	1x AM09838E
1x AM72954BYE	2x AM81215ZD	2x AM18287APG	1x AM12251AMP	1x AM78169AWU	1x AM04430I	1x AS-HDJ87-16	4x AM04218AMC	1x AS-HDJ87-03
1x AM74648GX	2x AM0910E	3x AM81245RQ	1x AM18591E	1x AS-HDJ87-09	6x AM04429MY	1x AS-HDJ87-16	1x AM18658E	3x AM79678I
1x AM75175MCX	2x AM0910E	1x AS-HDJ87-11	1x AM74415E	3x AM78726BMG	1x AM07228ASX	1x AM18223AMC	1x AM18658E	3x AM74718DO
1x AM72953JF	2x AM01086E	1x AS-HDJ87-11	2x AM76054E	1x AS-HDJ87-09	1x AM07228ASX	6x AM81364HT	2x AM76777ASE	3x AM74718DO
1x AM72953CS	1x AM01086AMC	1x AM73193AMP	4x AM80174ASX	1x AS-HDJ87-09	1x AS-HDJ87-08	6x AM81364HT	4x AM76450E	3x AM74718DO
1x AM72953NL	3x AM07629AMC	1x AM77912AWS	7x AM09393E	1x AS-HDJ87-04	2x AM81095ASX	1x AM03772AMC	1x AM78712GX	1x AM19134APG





3x  
AM16289AMC



2x  
AM16289E



2x  
AM03767E



2x  
AM80908AMC



1x  
AM17503AMC



3x  
AM01087AMC



1x  
AM78479APG



1x  
AM09033ATC



2x  
AM09493E



1x  
AM19754ATC



2x  
AM77499BYE



11x  
AM81161I



2x  
AS-HDJ87-05



3x  
AS-HDJ87-17



2x  
AM07475E



1x  
AM79449AAD



2x  
AM17194AMC

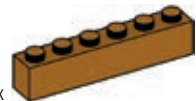

1x  
AM01313MY

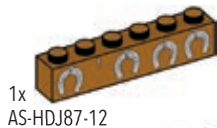

1x  
AS-HDJ87-12

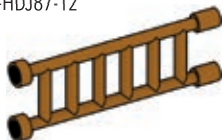

1x  
AM80741MY



1x  
AM76572AMP



1x  
AS-HDJ87-13



1x  
AM72890AMC

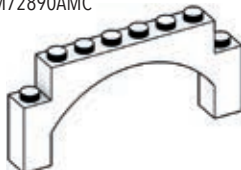

1x  
AM72890E



1x  
AM09323APG



1x  
AM80855MCX

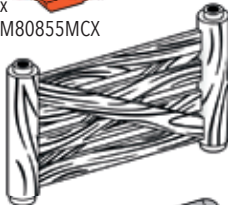

6x  
AM77227E

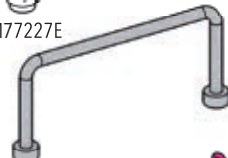

1x  
AM01462APG



2x  
AM81162ATC



1x  
AS-HDJ87-01

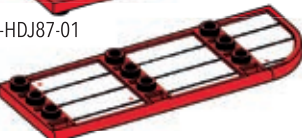

1x  
AS-HDJ87-02



1x  
AM01172E

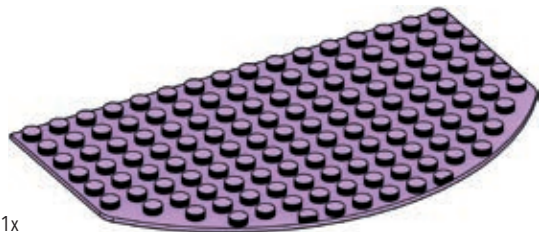

1x  
AM81365NL

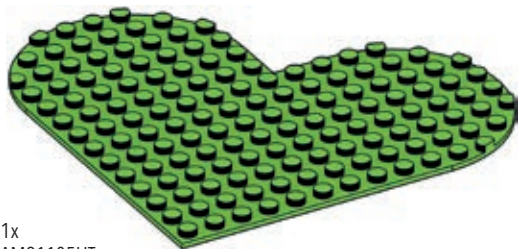

1x  
AM81105HT

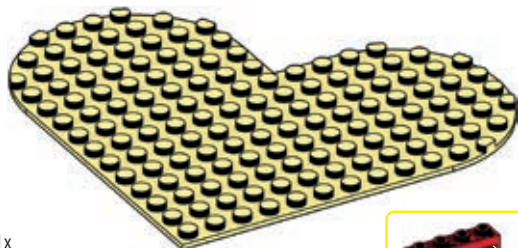

1x  
AM81105CS

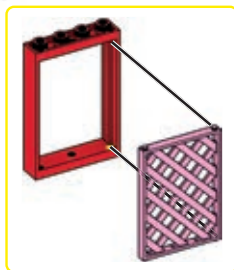

1x  
AM81120AMP



1x  
AM81121RQ



1x  
AS-GWR34-D



1x  
AS-GWR34-E



1x  
AS-GWR35-E



1x  
AS-GWR35-D



1x  
FIG-HDJ87-A



1x  
AM81370VS



1x  
AM81119ASV

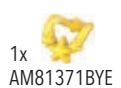

1x  
AM81371BYE



1x  
AM81129RQ



1x  
AM81369ASV



1x  
AM81369ATS



1x  
FIG-HDJ87-B



1x  
AM81123NL



1x  
AM81123GX



1x  
AM81373ASX



1x  
AM81124ADS



1x  
AM81124DR



1x  
FIG-HDJ87-C



1x  
FIG-HDJ87-D



1x  
FIG-HDJ87-H



1x  
FIG-HDJ87-G



1x  
FIG-HDJ87-E



1x  
FIG-HDJ87-F

**Missing pieces? • Pièces manquantes?**

¿Partes faltantes? • Perdeu peças?  
Fehlen Teile? • Не хватает деталей?

[support.megabrand.com](http://support.megabrand.com)

\*HHP86, HHP87, HHP88, HHM01, HHW83

Set(s) sold separately and subject to availability. / Ensemble(s) vendu(s) séparément. Certains produits peuvent ne pas être commercialisés. / Se vende(n) por separado y está(n) sujeto(s) a disponibilidad. / Conjunto(s) vendido(s) em separado e sujeito(s) à disponibilidade. / Set in vendita separatamente, secondo disponibilità. / Das/Die Set(s) sind separat erhältlich. / Zestawy(s) sprzedawany(e) oddzielnie w zależności od dostępności. / Set(s) apart verkrijgbaar en afhankelijk van beschikbaarheid. / Набор(-ы) продаются отдельно, при наличии. / Sæt sælges separat og så længe lager haves. / Seten säljs separat så länge lagret räcker. / Settet/settene selges separat så langt lageret rekker. / Pakkaus/pakkaukset myydään erikseen, saatavuus voi vaihdella. / Το(α) σετ πωλούνται ξεχωριστά και ανάλογα με τη διαθεσιμότητα. / Setler ayrı olarak satılır ve stoklarla sınırlıdır. / Set (sety) se prodává (prodávají) samostatně dle aktuální nabídky. / Súprava/-y sa predáva(jú) samostatne a podľa dostupnosti. / A készlet(ek) külön kapható(k), az elérhetőség változhat. / セット商品は別売りになります。在庫状況は別途ご確認をお願いします。

تباع المجموعة أو وتخصع على حد و تخضع لتوافرها.  
每套单独发售，按供货情况决定。

Mattel Europa B.V., Gondel 1, 1186 MJ Amstelveen, Nederland. Mattel U.K. Limited, The Porter Building, 1 Brunel Way, Slough SL1 1FQ, UK. Mattel France, Parc de la Cerisaie, 1/3/5 allée des Fleurs, 94260 Fresnes Cedex. N° Cristal 0969 36 99 99 (Numéro non surtaxé) ou www.lesjouesmattel.fr Mattel Belgium, Trade Mart, Atomiumsquare, Bogota 202 - B 275, 1020 Brussels. Gratis nummer België: 0800 - 16 936 - Gratis nummer Luxemburg: 800 - 22 784 - Gratis nummer Nederland: 0800 - 262 88 35. Deutschland: Mattel GmbH, Solmsstraße 83, D-60486 Frankfurt am Main. Schweiz: Mattel AG, Kirchstrasse 24, CH-3097 Liebefeld. Österreich: Mattel Ges.m.b.H., Campus 21, Liebermannstraße A01 404, A- 2345 Brunn/Gebirge. Mattel Italia Srl, Via Turati 4, 20121 Milano, Italy. Servizio assistenza clienti: Customerserv.italia@mattel.com - Numero verde 800 11 37 11. Mattel España, S.A., Arbaud 200 pl. 9, 08036 Barcelona. cservice.spain@mattel.com Tel: +34 933 06 79 00 http://www.service.mattel.com/es. Mattel East Asia Ltd., Room 503-09, North Tower, World Finance Centre, Harbour City, Tsingshatsui, HK, China. Tel: (852) 3185-6500. Diimport & Diedarkan Oleh: Mattel Continental Asia Sdn Bhd. Level 19, Tower 3, Avenue 7, No. 8 Jalan Kerinchi, Bangsar South, 59200 Kuala Lumpur, Malaysia. Mattel South Africa (PTY) LTD, Office 102 I3, 30 Melrose Boulevard, Johannesburg 2196. Dystrybutor: Mattel Poland Sp. z o.o., Warsaw Trade Tower 34 p. ul. Chłodna 51, 00-867 Warszawa. Mattel Australia Pty. Ltd., 658 Church St., Richmond, Victoria, 3121. Consumer Advisory Service - 1300 135 312. Mattel AEBE, Εθνάρχου Μικαηλίου 1, Κτήριο Κ-2, ΤΚ 17561, Παλάσι Φάληρο. Mattel Ouyuncakçılık Tic. Ltd. Şti. İkerenköy Mah., Umut Sok. No:10-12 Quick Tower Kat:2/15 34752 Ataşehir İstanbul Tel: 0216 750 75 00. Импортер/Уполномоченная организация: ООО "МАТТЕЛ" Российская Федерация, 105120 Москва, 2-й Сыртинский переулок 1; +7 495 287 79 39. Mattel Czech Republic s.r.o., The Forum, Václavské nám. 19, 11000 Praha 1, Mattel, 333 Continental Boulevard, El Segundo, CA 90245, USA. Consumer Services: 1-800-465-MEGA (6342). Mattel Canada Inc., Mattel Centre, Ontario L8R 3W2. Consumer Services: You may call us free at/ Composés sans frais le 1-800-524-8697. Importador y distribuidor en México: Mattel de México, S.A. de C.V., Miguel de Cervantes Saavedra No. 195 Pisos 10 y 11, Col. Granada, Alcaldía Miguel Hidalgo, C.P. 11520, México, Ciudad de México, R.F.C. MME-920701-N83. Tels: 59-05-51-00 ext. 5206 e 01-800-463-59-89. Mattel Chile, S.A., Avenida Américo Vespucio 501-8, Quilicura, Santiago, Tel: 1230-020-6213. Servicio al consumidor Venezuela: Tel: 0-800-100-9123. Mattel Argentina, S.A., Av. Libertador 1000, Piso 11 - Oficinas 109 y 111, Vicente López - Prov. Buenos Aires. Tel: 0800-666-3373. Mattel Colombia, S.A., Calle 12387-07 P5, Bogotá. Tel: 01800-710-2069. Mattel Perú, S.A., Av. Juan de Arona # 151, Centro Empresarial Juan de Arona, Torre C, Piso 7, Oficina 704, San Isidro, Lima 27, Perú. RUC: 20425853865. Reg. Importador: 02350-12-JUE-DIGESA. Tel: 0800-54744. E-mail Latinoamérica: servicio.clientes@mattel.com. Mattel do Brasil Ltda. - CNPJ: 54.558.002/0001-20 - Rua Verbo Divino, 1488 - 2º. Andar - 04719-904 - Chácara Santo Antônio - São Paulo - SP - Brasil. Serviço de Atendimento ao Consumidor: fone 0800 575 0780. E-mail: sac.matteldobrazil@mattel.com



\*HHW83



\*HHP87



\*HHP86



\*HHP88



\*HHM01

# ATTENTION : DANGER

D'ÉTOUFFEMENT. - PRÉSENCE DE PETITS ÉLÉMENTS. LE JOUET CONTIENT UNE PETITE BALLE. NE CONVIENT PAS AUX ENFANTS DE MOINS DE 3 ANS.

**ATENÇÃO!** NÃO INDICADO / NÃO RECOMENDÁVEL PARA CRIANÇAS MENORES DE 3 (TRÊS) ANOS POR CONTER PARTE(S) PEQUENA(S) / BOLA(S) PEQUENA(S) QUE PODE(M) SER ENGOLIDA(S) OU ASPIRADA(S) QUANDO PROVOCAR ASFIXIA.

تحذير:  
خطر الاختناق - قطع صغيرة.  
تحتوي اللعبة على كرة صغيرة  
غير صالحة للأطفال أقل من 3 سنوات.

**警告!**  
噎住危險。包含有小部件  
此玩具含有一个小球。  
不适合3岁以下的小孩玩。

⚠ WARNING : CHOKING HAZARD. - Small parts. Toy contains a small ball. Not for children under 3 years.



ADVERTENCIA : PELIGRO DE ATRAGANTAMIENTO. Juguete no recomendado para menores de 3 años, porque contiene piezas pequeñas / bolitas que podrían provocar asfixia en caso de ser ingeridas o inhaladas por el/la niño/a. AVVERTENZA: Piccole parti. Piccole palle. Rischio di soffocamento. ACHTUNG: Kleine Teile. Kleine Kugeln. Erstickungsgefahr. OSTRZEŻENIE: Małe części. Małe kuleczki. Niebezpieczeństwo zadławienia. WAARSCHUWING: Kleine onderdelen. Kleine balletjes. Verstikkingsgevaar. ПРЕДУПРЕЖДЕНИЕ: Мелкие детали. Маленькие шарики. Опасность проглатывания. / ADVARSEL: Små dele. Små bolde/kugler. Kvelningsfare. VARNING: Smådelar. Små bollar. Kvävningrisk. ADVARSEL: Små deler. Små kuler. Kvelningsfare. VAROITUS: Pieniä osia. Pieniä palloja. Tukehtumisvaara.

ΠΡΟΣΟΧΗ: Μικρά κομμάτια. Μικρές μπάλετσες. Κίνδυνος Πνιγμού. UYARI: Küçük parçalar. Küçük toplar. Yutma tehlikesi. UPOZORNENIE: Malé diely. Malé micky. Nebezpečie udusení. UPOZORNENIE: Malé casti. Malé guľôčky. Nebezpečenstvo zadusenía. FIGYELMEZTETÉS: Kis alkatrészek. Kis labdák. Fulladásveszély. 警告:  
のどにつまる危険 小さな部品が含まれています  
小さな玉が含まれています。  
3歳以下の子供には与えないで下さい。

# DISCOVER, DELIGHT AND DREAM WITH MEGA™ BARBIE® COLOR REVEAL! UN MONDE DE DÉCOUVERTES, DE PLAISIRS ET DE RÊVES VOUS ATTEND AVEC BARBIE® COLOR REVEAL



¡DESCUBRE, DISFRUTA Y SUEÑA CON BARBIE™ COLOR REVEAL DE MEGA™!  
DESCUBRA, SONHE E DELICIE-SE COM A BARBIE™ COLOR REVEAL DA MEGA™  
ENTDECKEN, FREUEN UND TRÄUMEN MIT MEGA BARBIE COLOR REVEAL!  
ОТКРЫВАЙТЕ НОВЫЙ МИР, РАДУЙТЕСЬ И МЕЧТАЙТЕ С НАБОРОМ MEGA™ BARBIE™ COLOR REVEAL!

BARBIE® and associated trademarks and trade dress are owned by,  
and used under license from Mattel. ©2022 Mattel.

©2022 MEGA Brands &™ MEGA Brands.  
Printed in China / Imprimé en Chine

AD-HDJ87-02A

Mattel Canada Inc. Mississauga, Ontario L5R 3W2.  
MADE IN CHINA. FABRIQUE EN CHINE. FABRICADO NA / HECHO EN CHINA.  
ИЗГОТОВЛЕНО В КИТАЕ. ÇIN'DE ÜRETİLMİŞTİR. صنع في الصين



1186 MJ, 1, NL

