

MEGA
CONSTRUX

HALO

HALO
INFINITE

GYG58



2 in 1^{*}
EM / B

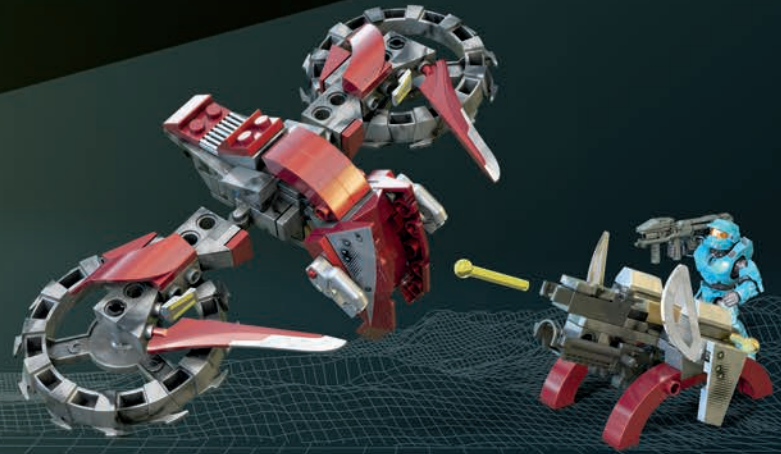

PRO
BUILDERS

*Instructions included for main model only. Other build(s) can be found at megaconstrux.com / Instructions incluses pour le modèle principal uniquement. Les instructions pour l'(les) autre(s) modèle(s) de construction se trouvent sur le site megaconstrux.com



megaconstrux.com

Scan here for instructions
Scanner ici pour obtenir
les instructions

Escanee aquí para obtener instrucciones
Digitalize aqui para instruções
Hier scannen und Anleitung aufrufen
Просканируйте здесь для
получения инструкций

Choose your Build Choisissez votre construction

Elije tu armado • Escolha sua montagem
Wähle dein Modell • Выбери свою конструкцию

Most models can be built one at a time. / La plupart des modèles peuvent être construits un à la fois. / La mayoría de modelos se pueden construir de uno en uno. / A maioria dos modelos pode ser construída separadamente. / La maggior parte dei modelli possono essere realizzati uno per volta. / Die meisten Modelle können eines nach dem anderen gebaut werden. / Większości modeli nie da się budować jednocześnie z innymi. / De meeste modellen kunnen één voor één gebouwd worden. / Большинство моделей могут быть собраны по одной за раз. / De fleste modeller kan bygges enkeltvis. / De flesta modeller kan byggas en i taget. / De fleste modellene kan bygges en om gangen. / Useimmat mallit voidaan rakentaa yksi kerrallaan. / Τα περισσότερα μοντέλα μπορούν να κατασκευασθούν ένα ένα. / Modellerin çoğu ayrı ayrı inşa edilmeyle gerektirebilir. / Většinou lze najednou sestavit pouze jeden model / Väčšina modelov môže byť zostavená iba raz. / A modellek többségéből egyszerre csak egy építhető. /ほとんどのモデルは、一度に一つを組み立てることができます。





1

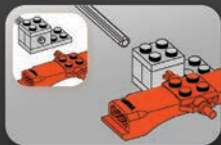

Building Tool Outil de construction

Herramienta de construcción
Bauwerkzeug
Ferramenta de montagem
Инструмент для конструирования

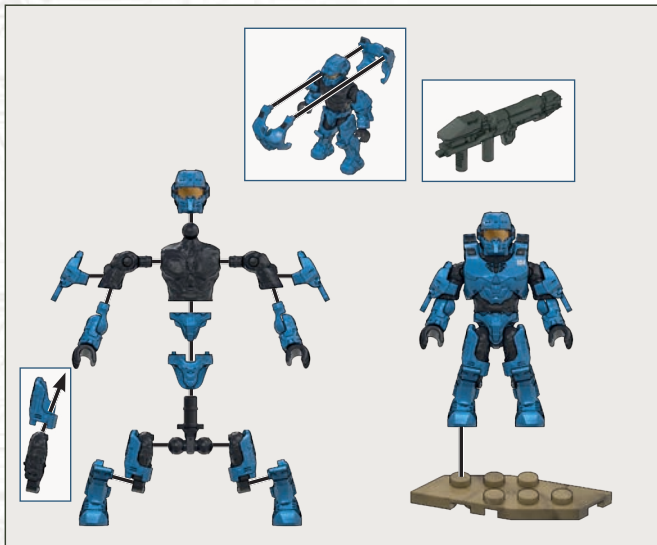
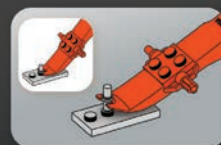

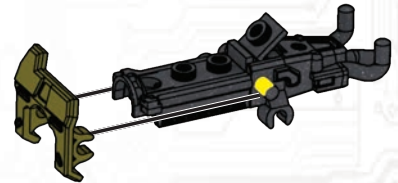
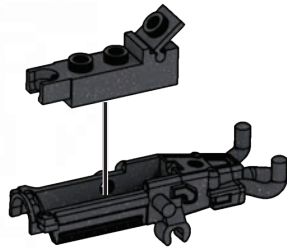
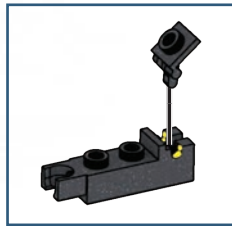
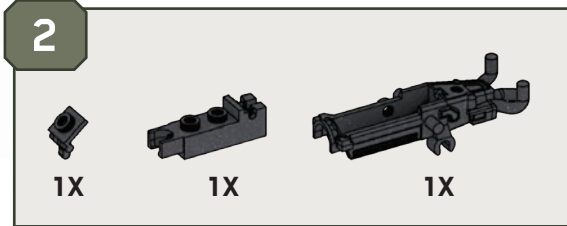

4



1X

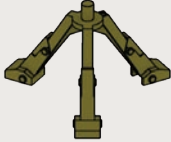

1X

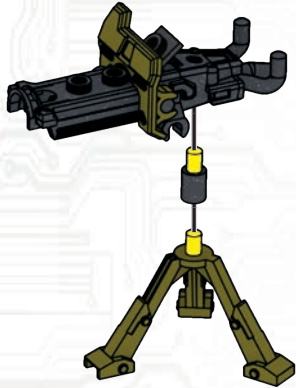

5



1X

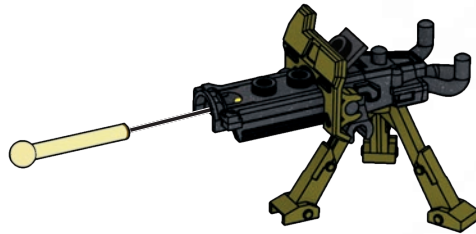

1

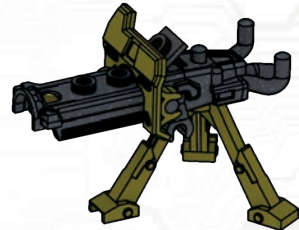

2

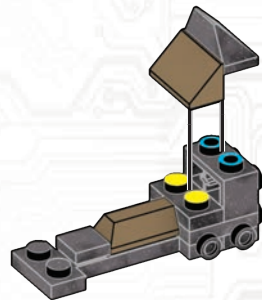
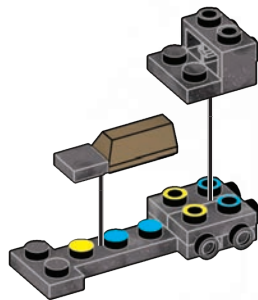
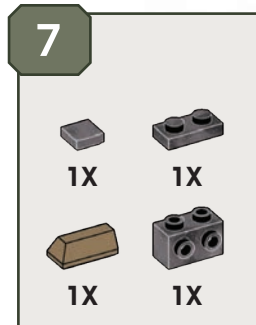
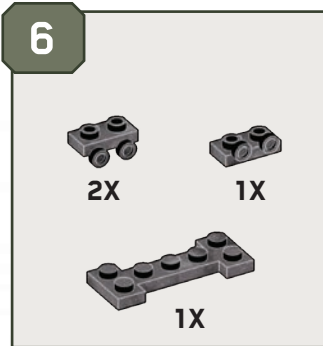

9



2X



1X

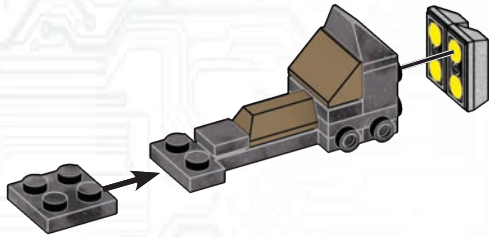
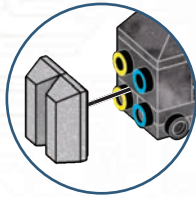

10



1X



1X

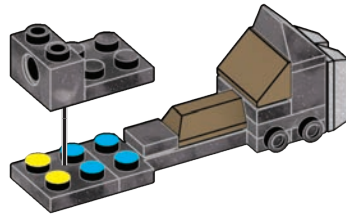

11



4X



2X



1X

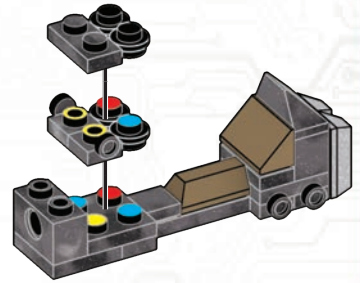

12



3X

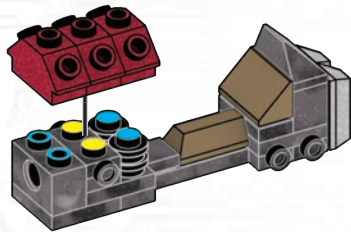

13



2X



2X



2X

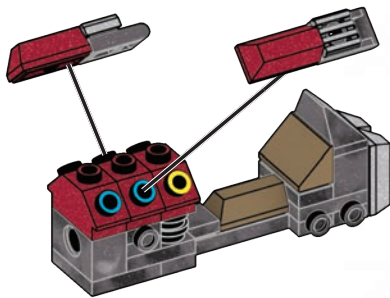
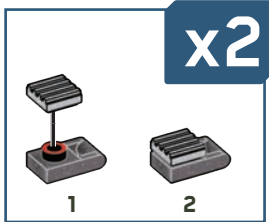

14



1X

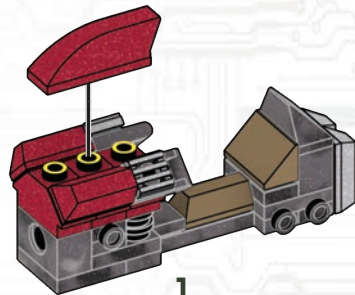

1

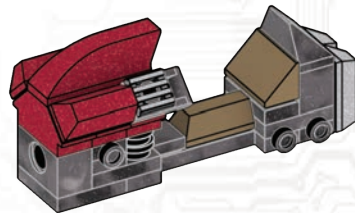

2

15



1X

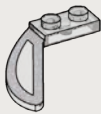

1X



1X

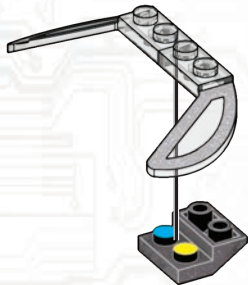

16



4X



2X



2X

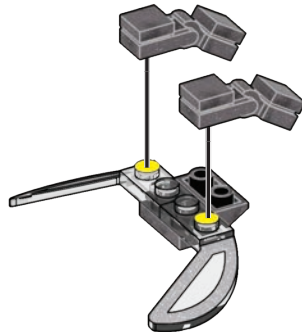

1

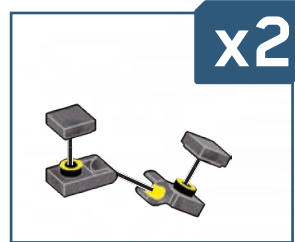

x2

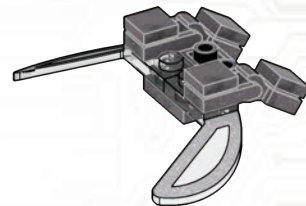

2

17

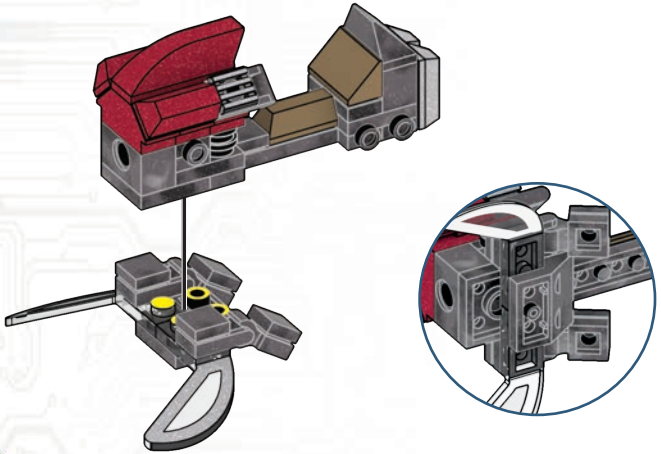

18

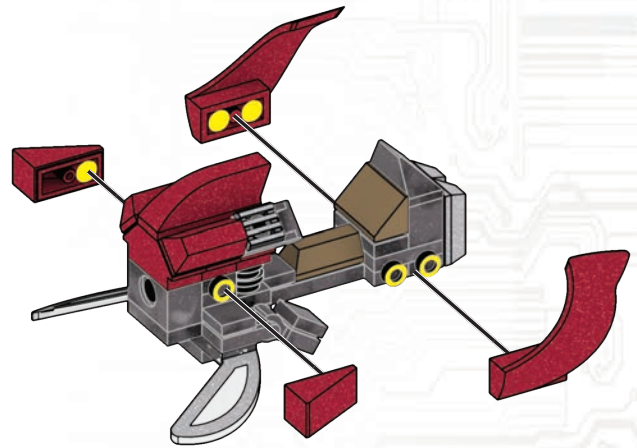
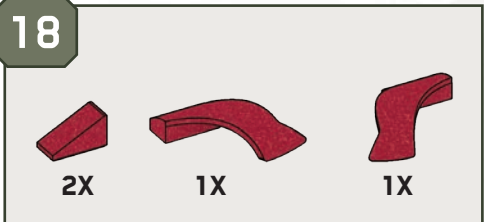

19



1X



2X



1X

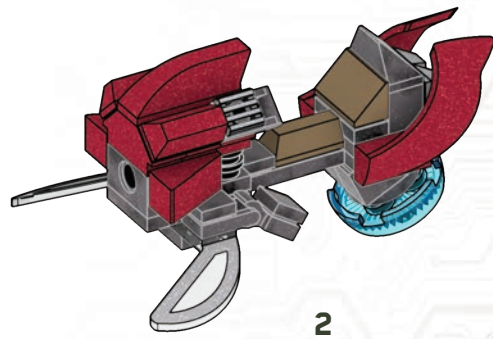
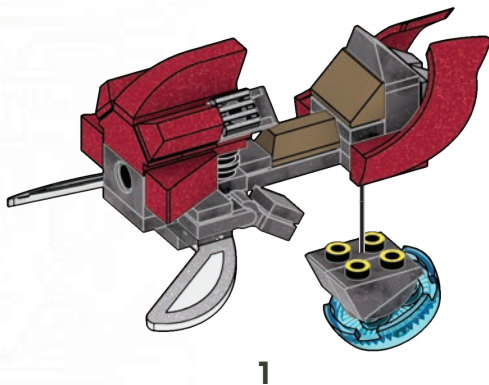
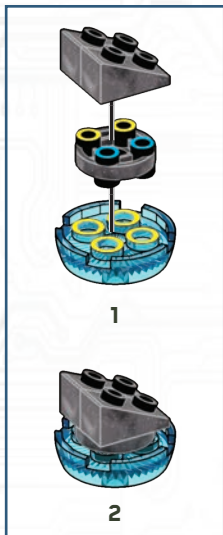



20



1X



1X



1X



2X



1X



1X

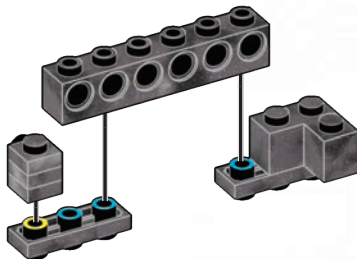
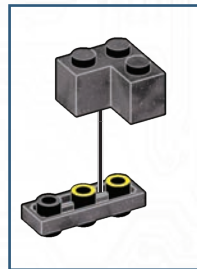
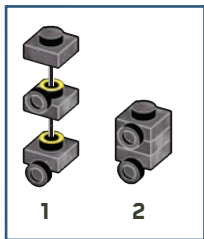

21



2X

2X

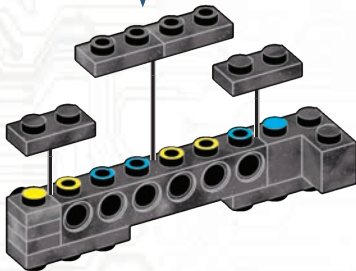

22



1X



1X

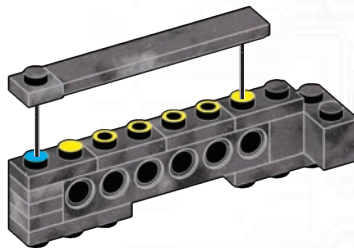

23



1X



1X

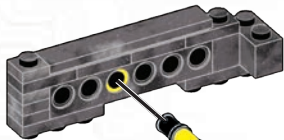
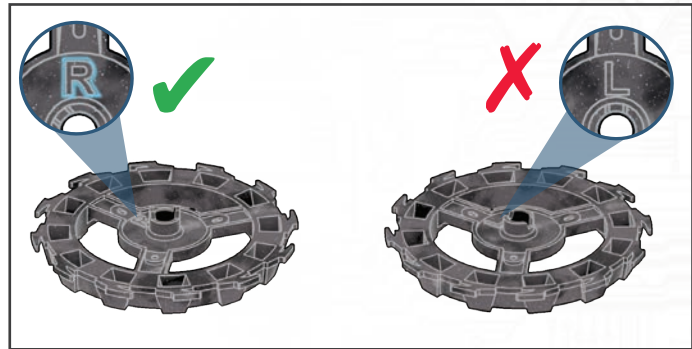

1



2

24

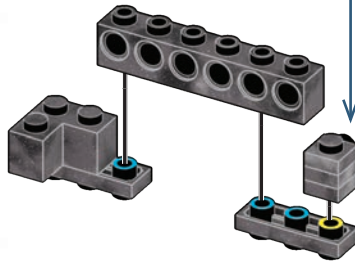
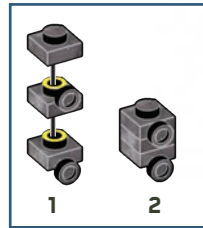
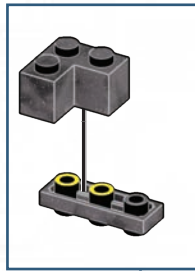
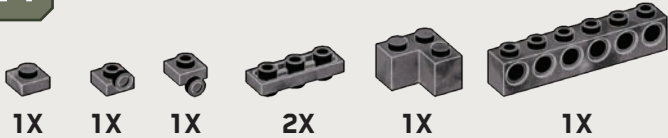

25



2X

2X

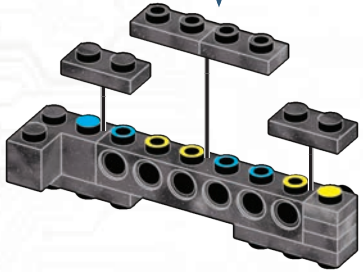

26



1X



1X

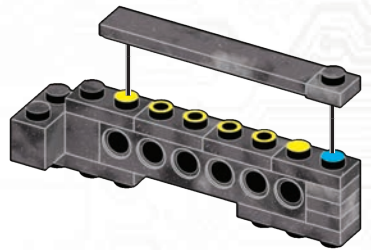

27



1X



1X

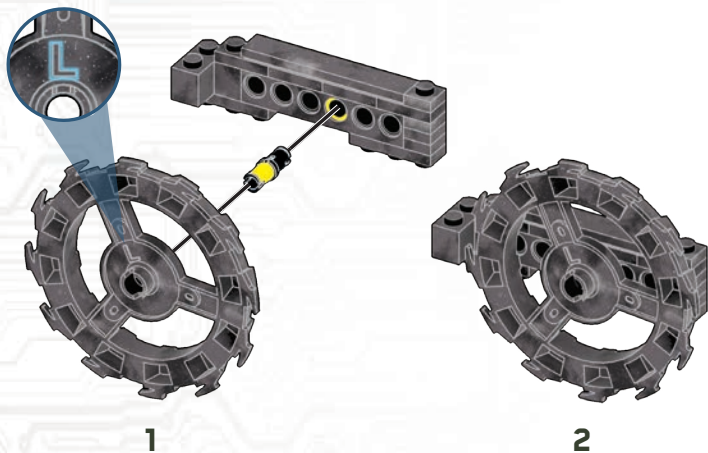

28



1X



2X



2X



1X



1

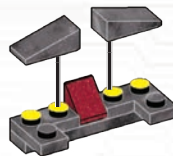

2



3

29

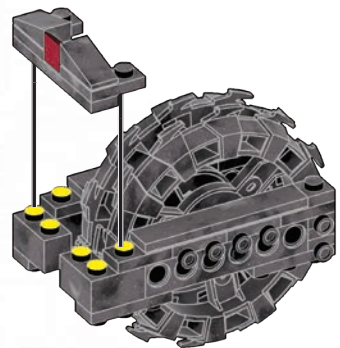
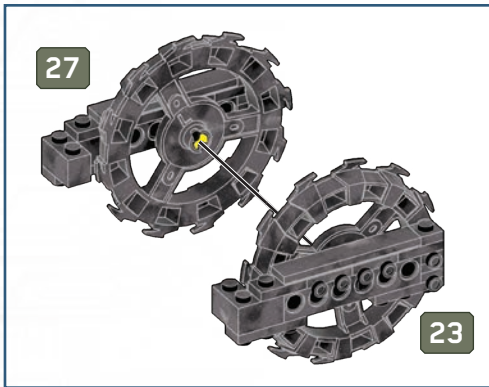

30

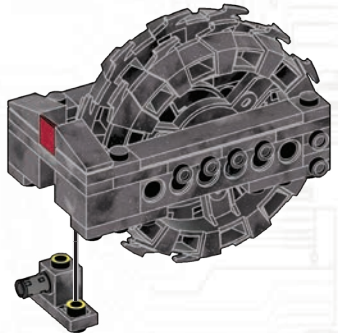
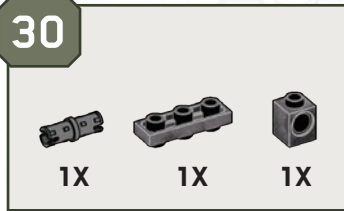

31



1X



1X



2X



1X



1X

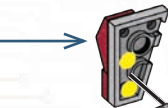
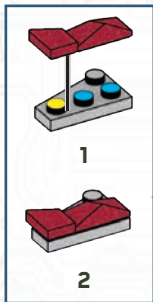

2

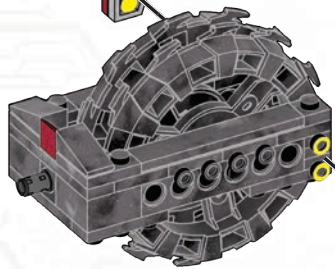

1

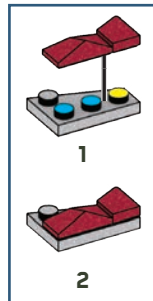

2

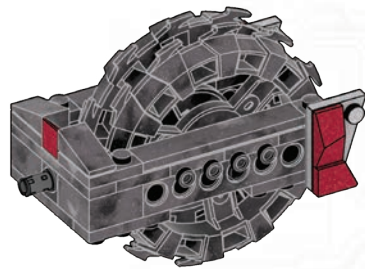

2

32



6X

1X



33



1X

1X



34



1X

1X

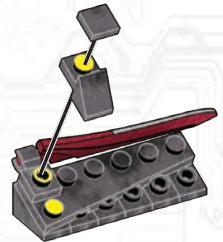

35



1X



1



2

36



6X

1X



37



1X



1X



38



1X



1X



39



1X

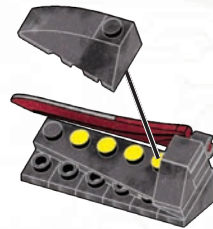

1



2

40

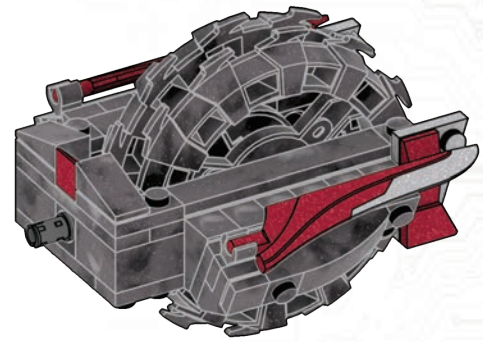
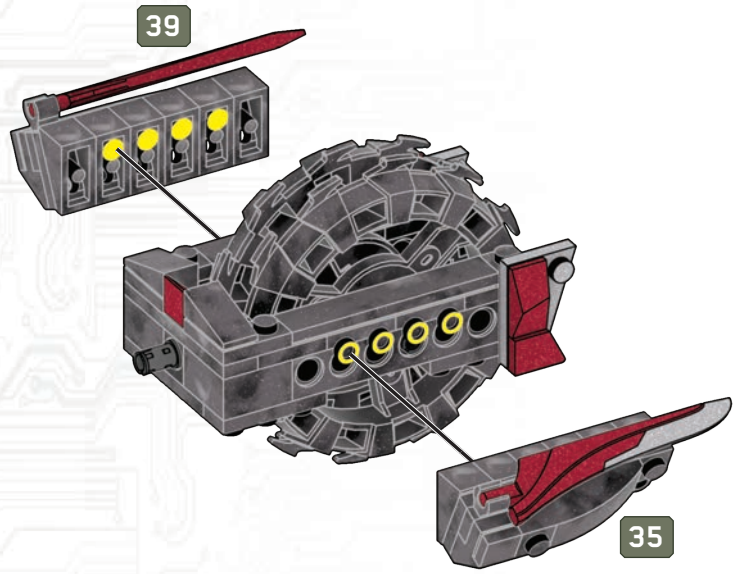

41

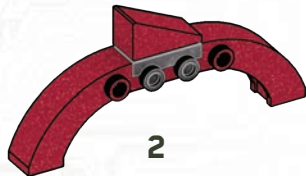
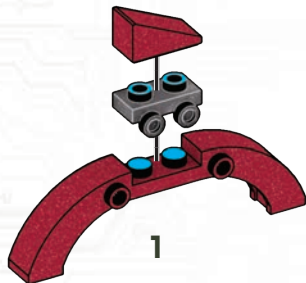
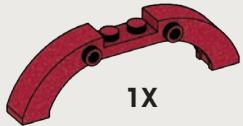
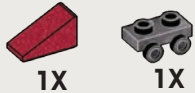

42

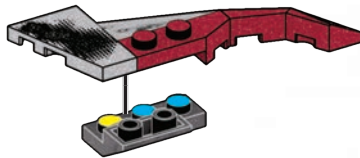
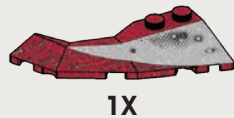

43

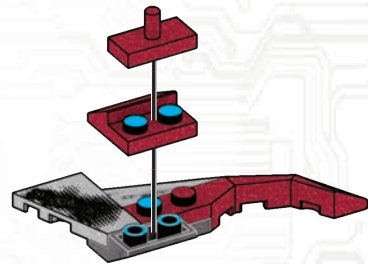

44



1X

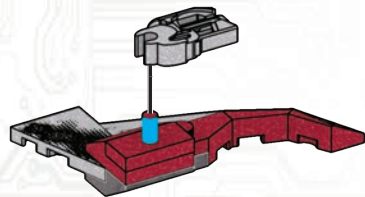

1

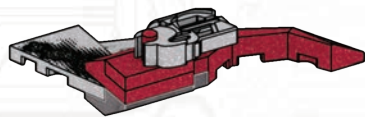

2

45

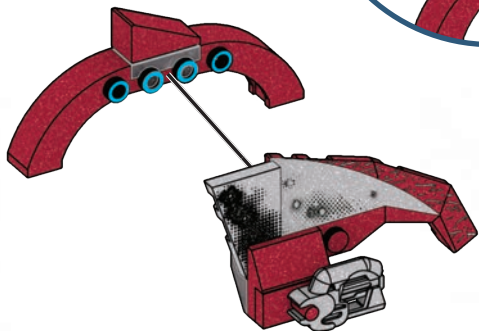
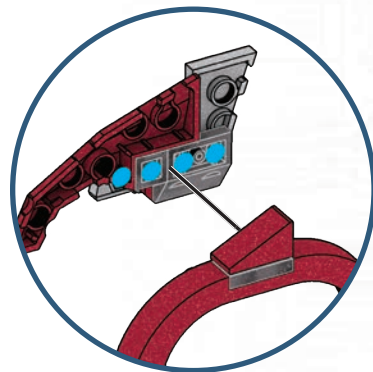

1

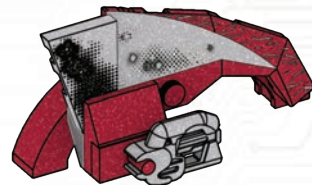

2

46

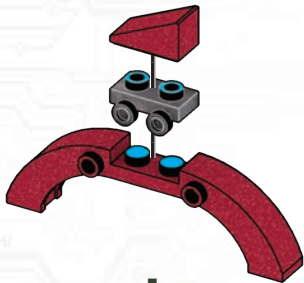
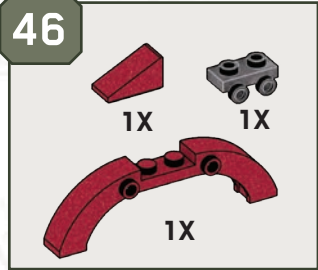

1

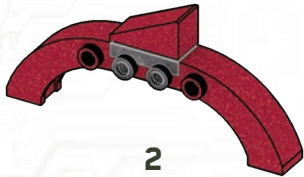

2

47

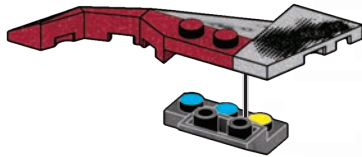
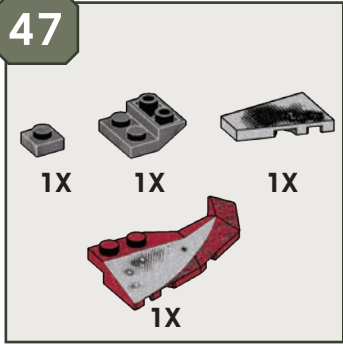

48

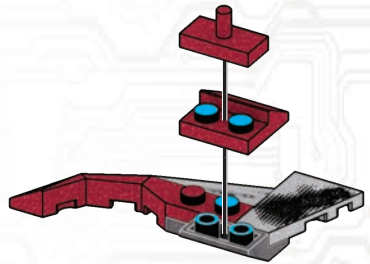
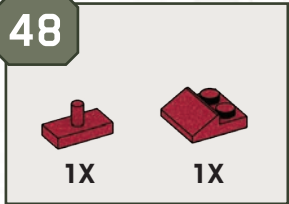

49



1X

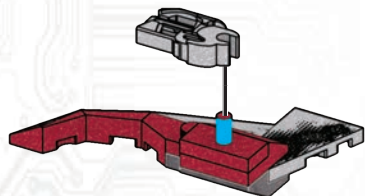

1

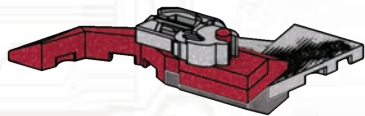

2

50

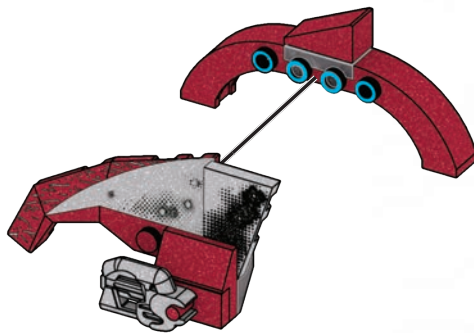
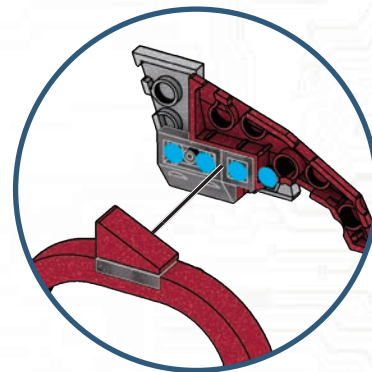

1

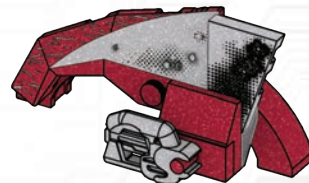

2

51

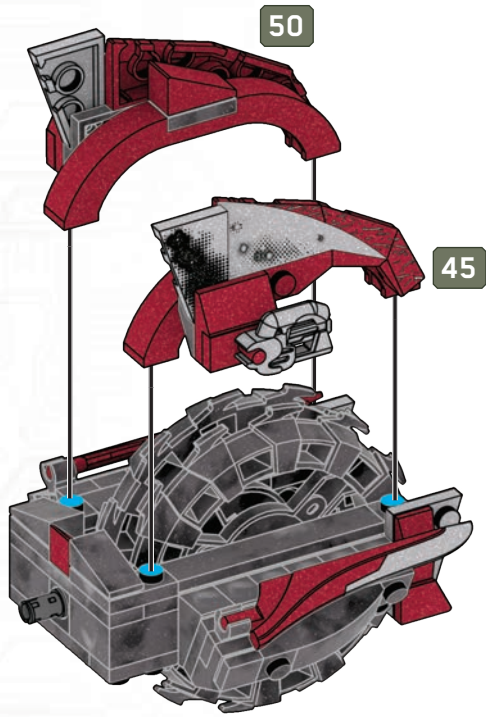

1

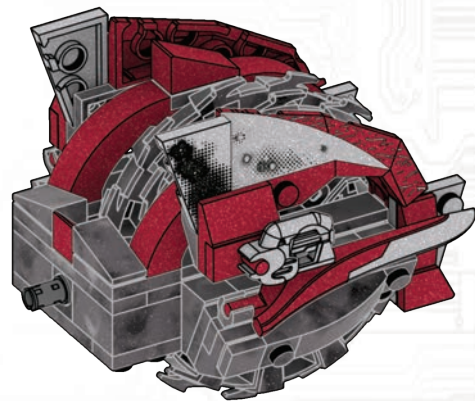

2

52

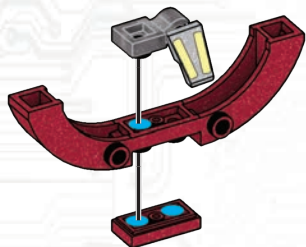
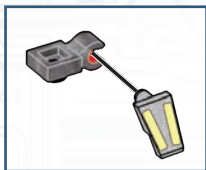
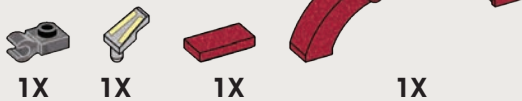

1

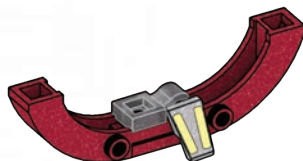

2

53

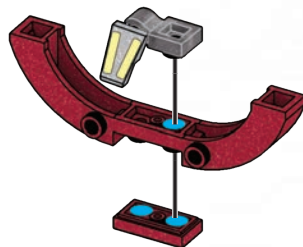
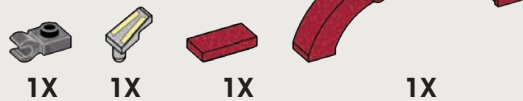

1

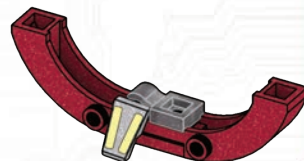

2

54

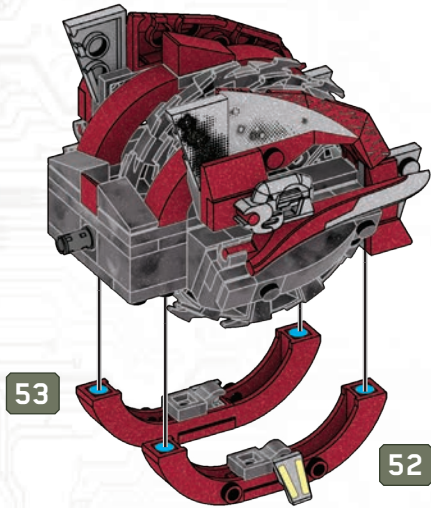

55

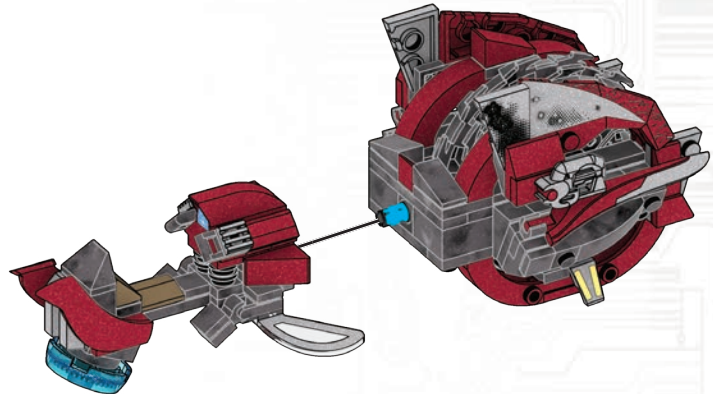

56



2X

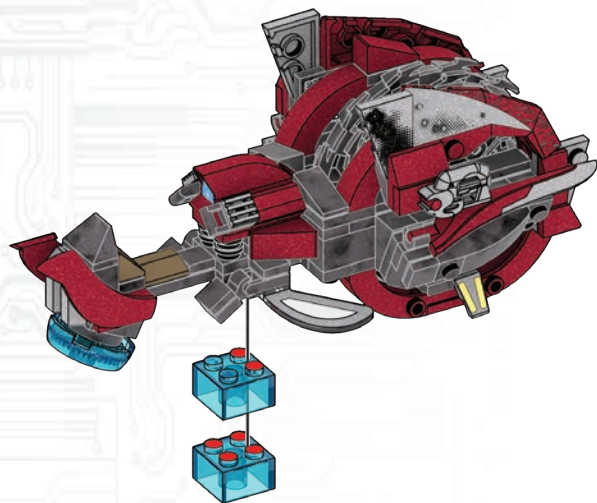

1

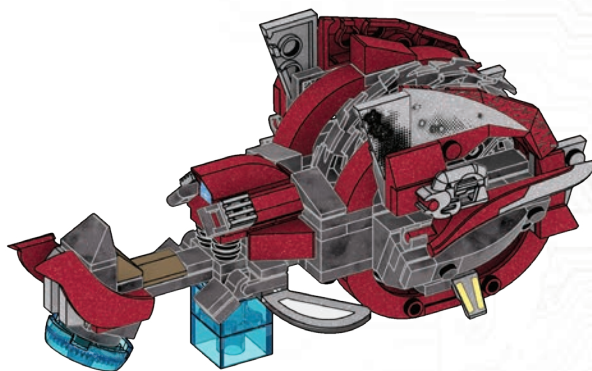

2

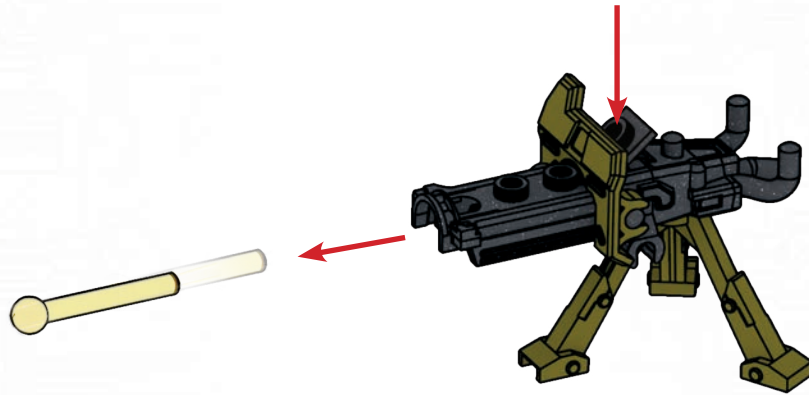

Warning: Do not aim at eyes or face. Only use projectiles supplied with this toy. Do not fire at point blank range. / Attention : Ne pas viser les yeux ou le visage. Ne pas utiliser d'autres projectiles que ceux fournis avec ce jouet. Ne pas tirer à bout portant. / Advertencia: No apuntar hacia los ojos o la cara. Utilizar exclusivamente los proyectiles suministrados con este juguete. No disparar a quemarropa. / **ATENÇÃO!**: Não apontar em direção aos olhos ou ao rosto. Usar apenas os projéteis fornecidos com este brinquedo. Não disparar à queima-roupa. / Avvertenza: Non mirare agli occhi o al viso. Usare solo i proiettili forniti con il giocattolo. Non sparare a distanza ravvicinata. / Achtung: Nicht auf Augen oder Gesicht zielen. Nur die zu diesem Spielzeug gehörenden Projektile verwenden. Nicht auf Menschen oder Tiere oder aus nächster Nähe zielen. Ostrzeżenie: Nie celuj w oczy i twarz. Nie strzelaj pociskami innymi niż dostarczone z zabawką. Nie strzelaj z bliska. / Waarschuwing: niet op ogen of gezicht richten. Gebruik uitsluitend de bijgeleverde projectielen. Niet van te dichtbij afschieten. / Предупреждение: Не направляйте в глаза или лицо. Используйте только снаряды, входящие в комплект. Не стреляйте со слишком близкого расстояния. / Advarsel: Sigt ikke mod øjne eller ansigt. Brug kun de projektiler, som følger med legetøjet. Skyd ikke direkte på personer eller ting. / Warning: Sikta inte mot ögon eller ansikte. Använd endast projektiler som medföljer leksaken. Fyra inte av på mycket nära håll. / Advarsel: Du må ikke sikte mot øyne eller ansikt. Bruk bare prosjektilene som følger med leken. Ikke skyt på noe på kloss hold. / Varoitus: Älä tähtää silmiin äläkä kasvoihin. Käytä ainoastaan tämän tuotteen mukana tulleita ammuksia. Älä ammu lähietäisyydeltä. / Προσοχή: Μην στοχεύετε στα μάτια ή στο πρόσωπο. Χρησιμοποιείτε μόνο τα βλήματα που περιλαμβάνονται. Μην στοχεύετε όταν δεν έχετε ορατότητα. / Uyarı: Göze veya yüze nişan almayın. Fırlatmak için yalnızca bu oyuncakla birlikte verilen objeleri kullanın. İnsanlara ve hayvanlara nişan almayın. / Upozornění: Nemířte na oči nebo na obličej. Používejte pouze projektily dodávané s touto hračkou. Nestřelejte z bezprostřední blízkosti. / Upozornenie: Nemierťte do očí ani do tváre. Používajte iba strely dodané spolu s touto hračkou. Nestrielajte z bezprostrednej blízkosti. / Figyelmeztetés: Tilos szemre és arcra célozni. Kizárólag a játékhoz mellékelt lövedékeket használja. A játékkal tilos közvetlen közelről löni. 警告: 目や顔を狙わないでください。このおもちゃに同梱されている発射物の使用するようにしてください。到達可能な距離内で火を燃やさないでください。 تحذير: يجب عدم التصويب باتجاه العينين أو الوجه. يجب استخدام المقذوفات المزودة مع هذه اللعبة فقط. يجب عدم الإطلاق من مدى قريب.

警告: 请勿对着眼睛或脸部发射。仅使用本玩具自带的抛射物。请勿近距离射击。

ESCHARUM

SPARTAN FRED-104

SPINS & TWISTS
TOURNE ET S'INCLINE



XBOX 343 INDUSTRIES™

© 2020 Microsoft Corporation. All Rights Reserved. Microsoft, Halo, the Halo logo, Xbox, the Xbox logo, and 343 Industries are trademarks of the Microsoft group of companies.

CHOPPER TAKEDOWN ■ MOTO D'ATTAQUE ■ VEHÍCULO DE ACCIÓN ■ VEÍCULO DE AÇÃO
ABBATTIMENTO MOTOVEICOLO | CHOPPER ÜBERFALL | CHOPPER - ATAK NA POJAZD ZESTAW | ЗАХВАТ МОТОЦИКЛА | ΜΗΧΑΝΗ ΜΑΧΗΣ |
MOTOSIKLET ATAĞI | A MOTORKERÉKPÁR MEGSEMMSÍTÉSE | SKJUT NED CHOPPERN | MOTORCYKELKAMP | SESTRĚLENÍ CHOPPERA | ZOSTRELENIE CHOPPERA | مهمة انزال المروحية

4X
AM01113F

1X
AM78600MM

7X
AM07223AWC

6X
AM03328AWC

2X
AM79666APG

2X
AM77574AWC

4X
AM79590AWC

6X
AM74415AWC

4X
AM76054AWC

1X
AM74299AKM

1X
AM74300AKM

1X
AM74397MM

1X
AM15258AKM

2X
AS-GYG58-06

2X
AM72534F

1X
AM73534BDM

2X
AM17131AKM

6X
AM09393AWC

2X
AM022501AKM

1X
AM79070AWC

8X
AM76467AWC

2X
AM17070AKM

2X
AM18740AWC

1X
AM80356AWC

1X
AM18232ASE

2X
AM18232APG

2X
AM18232AKM

1X
AM19061AWC

1X
AM03019ASE

1X
AM19380AWC

2X
AM19015APG

1X
AM79097AXU

2X
AM17128AWC

4X
AM04430AKM

14X
AM04429AWC

1X
AM79877AWC

1X
AM17502AWC

2X
AM15484AWC

2X
AM03773AWC

3X
AM18223AWC

1X
AM18265F

1X
AS-GYG58-07

1X
AS-GYG58-08

2X
AM17153AWC

2X
AM09023AAV

3X
AM74060AKM

2X
AM78189AKM

1X
AM72240AAV

3X
AM78601ZD

1X
AM16955AKM

1X
AM16956AKM

1X
AS-GYG58-05

1X
AS-GYG58-02

1X
AS-GYG58-04

1X
AM17073APG

1X
AM17074APG

5X
AM80143AWC

1X
AM78599MM

1X
AM07224AWC

1X
AM07225AWC

1X
AM07475AWC

1X
AM17148AWC

2X
AM16331AWC

1X
AM72010AWC

1X
AM72011AWC



2X
AM76357ANW



1X
AS-GYG58-03

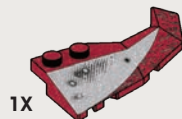

1X
AS-GYG58-01



1X
AS-GYG58-09



1X
AS-GYG58-10



1X
AM79096MM



2X
AM81190AWC

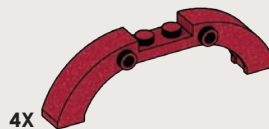

4X
AM81191AKM

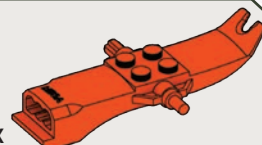

1X
AM80855MCX

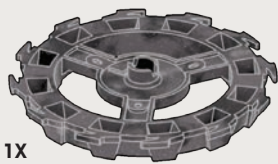

1X
AM81273AWC



1X
AM81274AWC

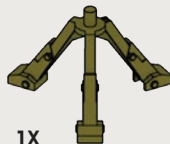

1X
AM72524AXU



1X
FIG-GYG58-A



1X
FIG-GYG58-B



1X
AM79108JZ



1X
AM19980AYB

Mattel Europa B.V., Gondel 1, 1186 MJ Amstelveen, Nederland. Mattel U.K. Limited, The Porter Building, 1 Brunel Way, Slough SL1 1FQ, UK. Mattel France, Parc de la Cerisaie, 1/3/5 allée des Fleurs, 94260 Fresnes Cedex. № Cristal 0969 36 99 99 (Numéro non surtaxé) ou www.lesjouetsmattel.fr Mattel Belgium, Trade Mart, Atomiumsquare, Bogota 202 – B 275, 1020 Brussels. Gratis nummer België: 0800 – 16 936 - Gratis nummer Luxembourg: 800 - 22 784 - Gratis nummer Nederland: 0800 - 262 88 35. Deutschland : Mattel GmbH, Solmsstraße 4, D-60486 Frankfurt am Main. Schweiz: Mattel AG, Kirchstrasse 24, CH-3097 Liebefeld. Österreich: Mattel Ges.m.b.H., Campus 21, Liebermannstraße A01 404, A- 2345 Brunn/Gebrige. Mattel Italy Srl, Via Bracco, 6-MAC 6, 20159 Milano, Italy. Servizio assistenza clienti: Customersrvitalia@mattel.com - Numero verde 800 11 37 11. Mattel España, S.A., Aribau 200. 08036 Barcelona. cservice.spain@mattel.com Tel: 902203010 <http://www.service.mattel.com/es>. Mattel East Asia Ltd., Room 503-09, North Tower, World Finance Centre, Harbour City, Tsimshatsui, HK, China. Tel.: (852) 3185-6500. Diimport & Diedarkan Oleh: Mattel Continental Asia Sdn Bhd. Level 19, Tower 3, Avenue 7, No. 8 Jalan Kerinchi, Bangsar South, 59200 Kuala Lumpur, Malaysia. Mattel South Africa (PTY) LTD, Office 102 I3, 30 Melrose Boulevard, Johannesburg 2196. Dystrybutor: Mattel Poland Sp. z o.o., Warsaw Trade Tower 34 p., ul. Chłodna 51, 00-867 Warszawa. Mattel Australia Pty. Ltd., 658 Church St., Richmond, Victoria, 3121. Consumer Advisory Service - 1300 135 312. Mattel AEBE, Εθνάρχου Μακαρίου 1, Κτήριο Κ-2, ΤΚ 17561, Πλατεία Φάληρο. Mattel Oyuncakçılık Tic. Ltd. Şti. İçerenköy Mah. Erkut Sok. A Blok No:12 Ünler Plaza Kat:9-10 34752 Ataşehir İstanbul. Tel: 0216 570 75 00. Импортер/Уполномоченная организация: ООО "МАТТЕЛ" Российская Федерация, 105120 Москва, 2-й Сыромятинский переулок 1; +7 495 287 79 39. Forg.: Mattel Toys Hungary Kft 1139 Budapest Váci út 91. +36 1 270 0223. Mattel Czech Republic s.r.o., The Forum, Václavské nám. 19, 11000 Praha 1. Mattel, 333 Continental Boulevard, El Segundo, CA 90245, USA. Consumer Services: 1-800-465-MEGA (6342). Importado y distribuido por Mattel de México, S.A. de C.V., Miguel de Cervantes Saavedra No. 193, Pisos 10 y 11, Col. Granada, Alcatida Miquel Hidalgo, C.P. 11520, México, Ciudad de México. R.F.C. MME-920701-NB3. Tels.: 59-05-51-00 Ext. 5206 6 01-800-463-59-89. Mattel Chile, S.A., Avenida América Vespucio 501-B, Quilicura, Santiago. Tel.: 1230-020-6213. Servicio al consumidor Venezuela: Tel.: 0-800-100-9123. Mattel Argentina, S.A., Av. Libertador 1000, Piso 11 – Oficinas 109 y 111, Vicente López – Prov. Buenos Aires. Tel.: 0800-666-3373. Mattel Colombia, S.A., Calle 123#7-07 P5, Bogotá. Tel.: 01800-710-2069. Mattel Perú, S.A., Av. Juan de Arona # 151, Centro Empresarial Juan de Arona, Torre C, Piso 7, Oficina 704, San Isidro, Lima 27, Perú. RUC: 20425853865. Reg. Importador: 02350-12-JUE-DIGESA. Tel.: 0800-54744. E-mail Latinoamérica: servicio.clientes@mattel.com. Mattel do Brasil Ltda. CNPJ : 54.558.002/0001-20 - Rua Verbo Divino, 1488 - 2º. Andar - 04719-904 - Chácara Santo Antônio - São Paulo - SP - Brasil. Serviço de Atendimento ao Consumidor: fone 0800 575 0780. E-mail: sac.matteldobrazil@mattel.com



HALO

**MORE TO COLLECT!
ENCORE PLUS
À COLLECTIONNER!
MÁS PARA
COLECCIONAR!**



**MAIS PARA
COLECIONAR!
MEHR ZUM
SAMMELN!
СОБЕРИ БОЛЬШЕ!**



GYG57



GYG60

Set(s) sold separately and subject to availability. / Ensemble(s) vendu(s) séparément. Certains produits peuvent ne pas être commercialisés. / Se vende(n) por separado y está(n) sujeto(s) a disponibilidad. / Conjunto(s) vendido(s) em separado e sujeito(s) à disponibilidade. / Set in vendita separatamente, secondo disponibilità. / Das/Die Set(s) sind separat erhältlich. / Zestaw(y) sprzedawany(e) oddzielnie w zależności od dostępności. / Set(s) apart verkrijgbaar en afhankelijk van beschikbaarheid. / Набор(-ы) продаются отдельно, при наличии. / Sæt sælges separat og så længe lager haves. / Seten säljs separat så länge lagret räcker. / Settett/settene selges separat så langt lageret rekker. / Pakkaus/pakkaukset myydään erikseen, saatavuus voi vaihdella. / Το(α) σετ πωλούνται ξεχωριστά και ανάλογα με τη διαθεσιμότητα. / Setler ayrı olarak satılır ve stoklarla sınırlıdır. / Set (sety) se prodává (prodávají) samostatně dle aktuální nabídky. / Súprava-/y sa predáva(jú) samostatne a podľa dostupnosti. / A készlet(ek) külön kapható(k), az elérhetőség változhat. / セット商品は別売りになります。在庫状況は別途ご確認をお願いします。 / تباع المجموعة أو المجموعات على حدة وتخضع لتوافرها.

每套单独发售，按供货情况决定。

1186 MJ, 1, NL ©D714,887, D781,964, D797,203, D841,710

UK
CA



*Instructions included for main model only. Other build(s) can be found at megaconstrux.com / Instructions incluses pour le modèle principal uniquement. Les instructions pour l'(les) autre(s) modèle(s) de construction se trouvent sur le site megaconstrux.com / Se incluyen las instrucciones para el modelo principal solamente. Se pueden encontrar otras construcciones en megaconstrux.com / Instruções incluídas somente para o modelo principal. Outras montagens podem ser encontradas em megaconstrux.com / Istruzioni incluse solo per il modello principale. È possibile trovare le altre costruzioni su megaconstrux.com / Nur für das Hauptmodell ist eine Anleitung enthalten. Unter megaconstrux.com finden Sie weitere Bauanleitungen. / Znajdują instrukcje tylko do głównego modelu. Inne wersje są dostępne na megaconstrux.com / Instructies alleen bij het hoofdmodel. Andere bouw mogelijkheden kunt u vinden op megaconstrux.com / Инструкция относится только к основной модели. Другие конструкции можно найти на сайте megaconstrux.com / Οι οδηγίες που περιλαμβάνονται είναι μόνο για το κύριο μοντέλο. Μπορείτε να βρείτε άλλες κατασκευές στο megaconstrux.com / Yönergeler sadece ana modeller için dahil edilmiştir. Diğer yapı parçaları megaconstrux.com adresinde bulunabilir / Instruktioner medföljer endast för huvudmodellen. Andra byggen finns på megaconstrux.com / Ohjeet ovat sisällytetyjä vain päämalleihin. Muut kokoonpanot ovat löydettävissä osoitteessa megaconstrux.com / Veiljedningen følger kun med hovedmodellen. Andre byggemodeller kan findes på megaconstrux.com / Instruksjoner kun inkludert for hovedmodell. Annen/andre versjon-/er finner du på megaconstrux.com / Pribalené pokyny jsou pouze pro hlavní model. Ostatní stavby lze najít na megaconstrux.com / Pribalené pokyny su iba hlavný model. Ostatné stavby možno nájsť na megaconstrux.com / A mellékelt utasítások csak a fő modellre vonatkoznak. Egyéb építőelem(ek) a megaconstrux.com weboldalon található(k) / megaconstrux.com/ تعليمات موجودة للنموذج الرئيسي فقط. يمكن العثور على بناء (أبنية) أخرى على موقع

©2020, MEGA Brands Inc. & MEGA Brands Inc. CONSTRUX™ is owned by Mattel and used under license. CONSTRUX™ appartient à Mattel et est utilisée sous licence. Printed in China / Imprimé en Chine AD-GYG58-01A

Mattel Canada Inc. Mississauga, Ontario L5R 3W2.
MADE IN CHINA. FABRIQUÉ EN CHINE. FABRICADO NA / HECHO EN CHINA.
ИЗГОТОВЛЕНО В КИТАЕ. ÇIN'DE ÜRETİLMİŞTİR. صنع في الصين

