

MEGATM



HotWheels
MONSTER TRUCKS

HHD18

HW DEMO DERBYTM
MONSTER TRUCK

CAMIÓN DE CARRERAS / МАШИНКА МОHCTP-ТРАК / SZÖRNYJÁRGÁNY / MONSTER شاحنة



SWAP^{THE}
TIRES!
CHANGEZ^{LES}
PNEUS!

¡INTERCAMBIA
LOS NEUMÁTICOS!
TROCAR OS PNEUS
DIE REIFEN WECHSELN
ЗАМЕНИТЕ ШИНЫ



Build Construisez

Construye | Constrói
Bauen | Стройте



Share | Partagez

Comparte | Partilha
Teilen | Делитесь

Devices not included | Appareils non inclus | Dispositivos no incluído
Dispositivos não incluídos | Geräte nicht enthalten | Устройства не входят в комплект



Get creative! Soyez créatif!

¡Sé creativo!
seja criativo!
werde kreativ!
проявите
творческий подход!



Build ideas may use pieces from multiple sets (sold separately). / Les idées de construction peuvent nécessiter des pièces issues de différents coffrets (vendus séparément). / Las ideas de construcción pueden utilizar piezas de varios conjuntos (se venden por separado). / As ideias de construção podem utilizar peças de vários conjuntos (vendidas em separado). / Für Baulideen sind möglicherweise Teile von mehreren Sets nötig (separat erhältlich). / В идеях конструкций могут быть использованы детали из разных наборов (продаются отдельно).

megaunboxed.com



BUILDING TOOL OUTIL DE CONSTRUCTION

HERRAMIENTA DE CONSTRUCCIÓN
BAUWERKZEUG
FERRAMENTA DE MONTAGEM
ИНСТРУМЕНТ ДЛЯ КОНСТРУИРОВАНИЯ

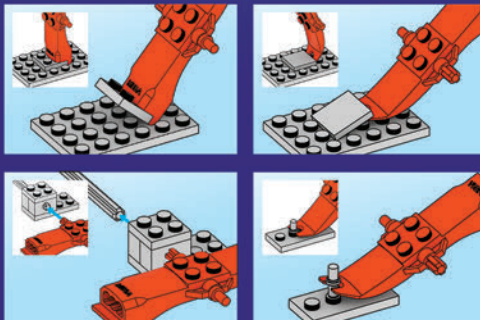



1



1



2

2



1x

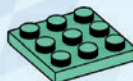

1x

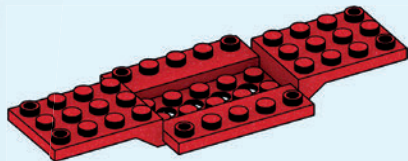

1x

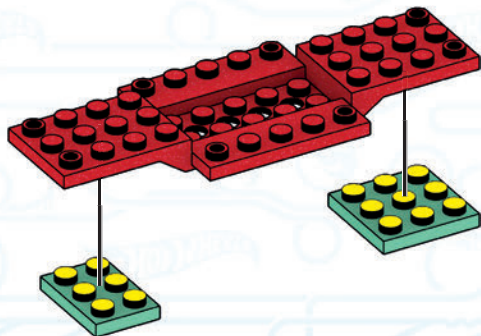



HW DEMO DERBY™ MONSTER TRUCK · CAMIÓN DE CARRERAS

3



1x



1x

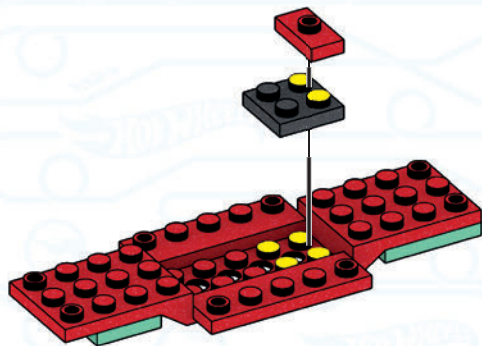

4



2x

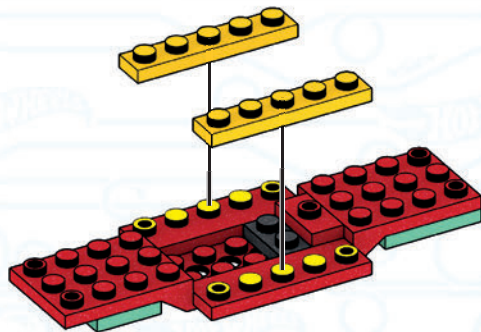

5



1x



1x

6



1x



1x

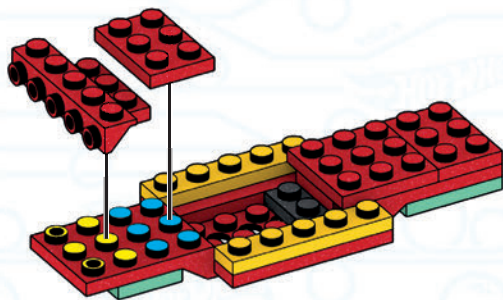
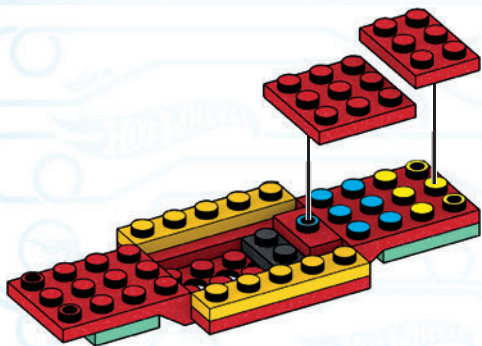



HW DEMO DERMY™ MONSTER TRUCK · CAMIÓN DE CARRERAS

7



1x

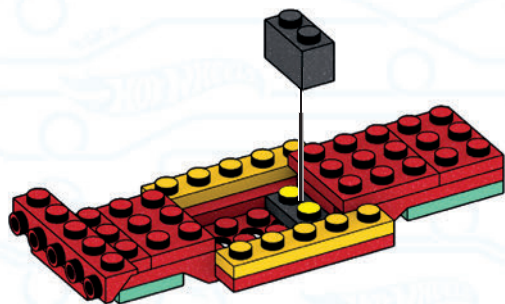

8



1x



1x

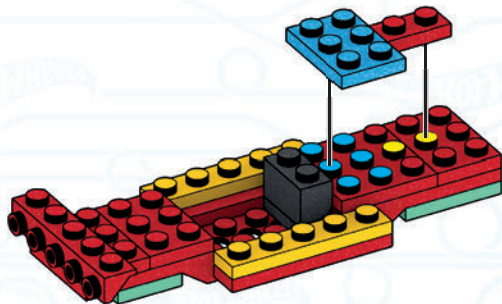

9



1x



1x



1x

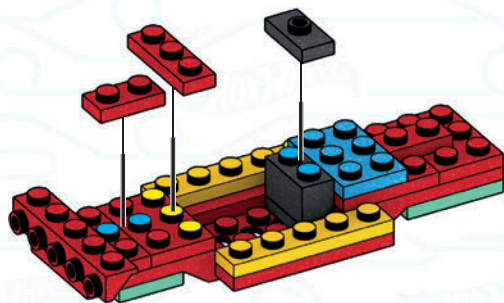



HW DEMO DERBY™ MONSTER TRUCK · CAMIÓN DE CARRERAS

10



4x

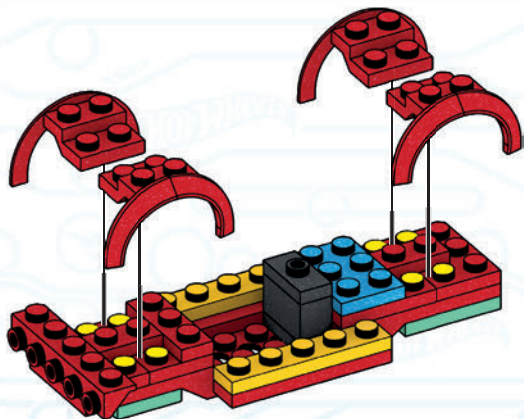

11



1x



1x

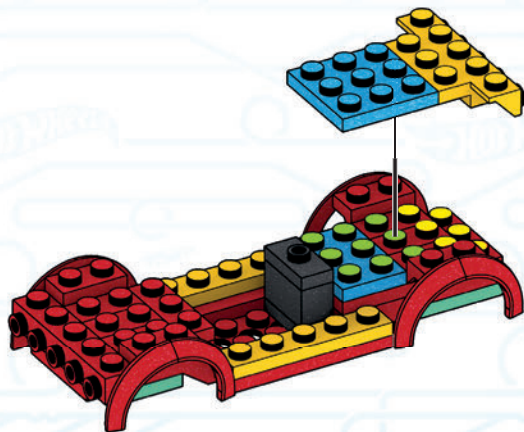

12



2x

13



1x

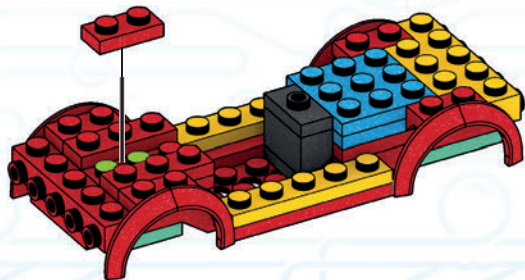
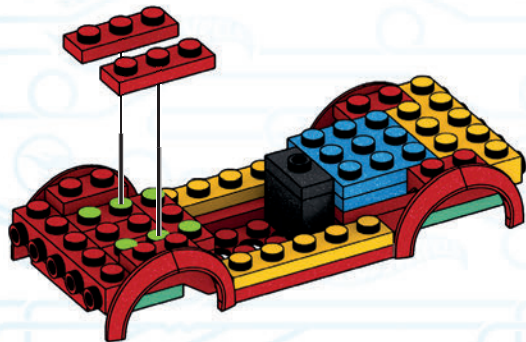



HW DEMO DERBY™ MONSTER TRUCK · CAMIÓN DE CARRERAS

14



1x



1x

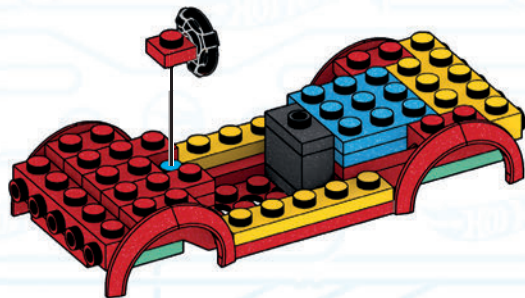
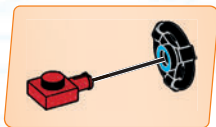

15



1x



1x

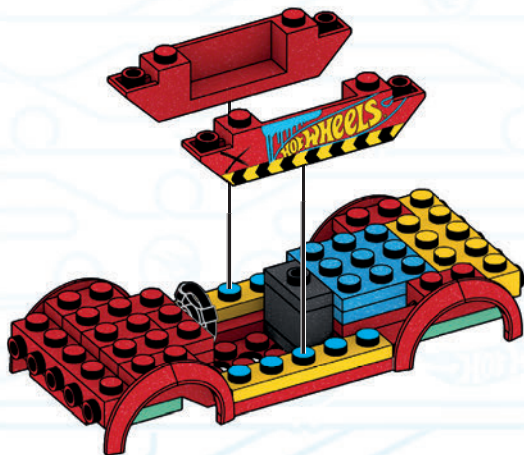



HW DEMO DERMY™ MONSTER TRUCK · CAMIÓN DE CARRERAS

16



2x

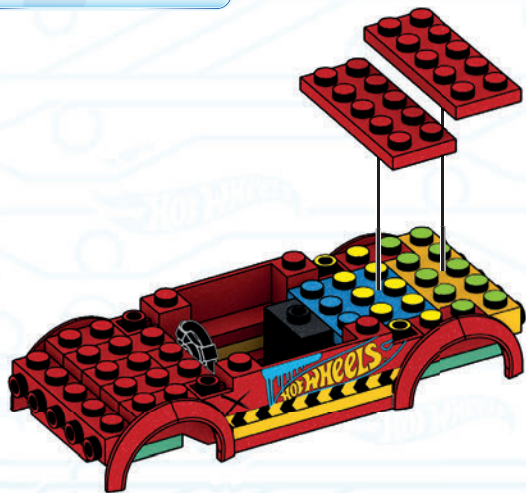

17



1x

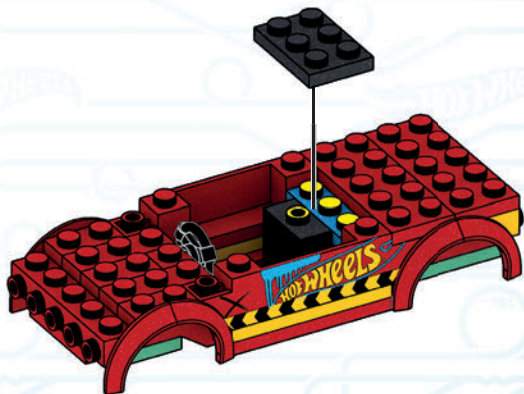



18

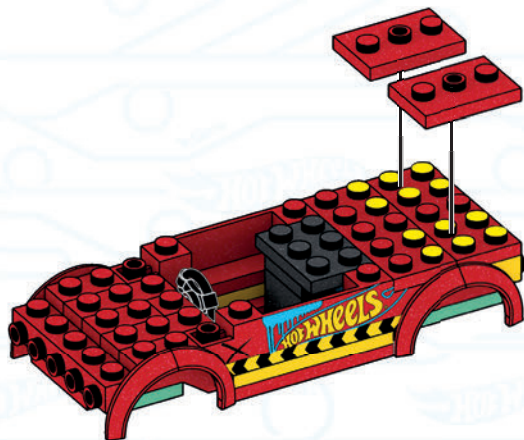



HW DEMO DERMY™ MONSTER TRUCK · CAMIÓN DE CARRERAS

19



1x



2x

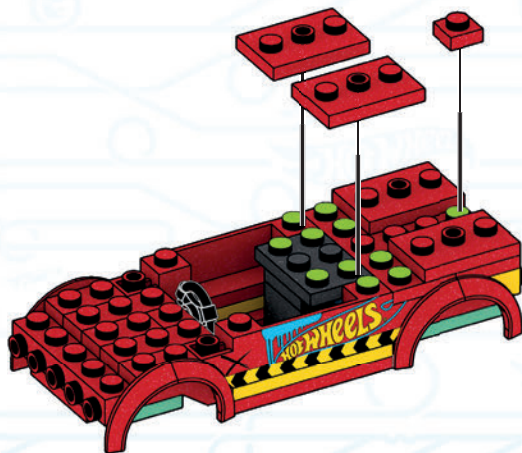

20



1x

21



1x



1x

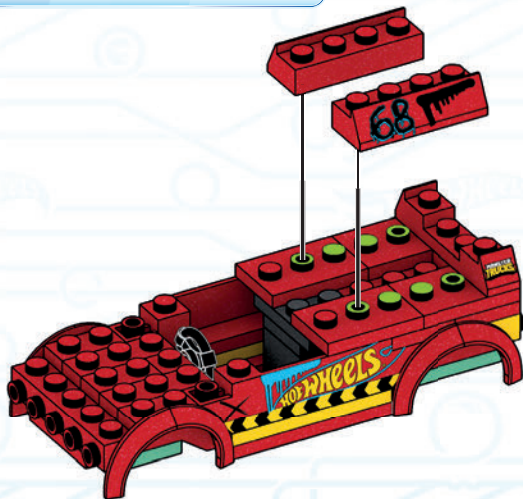
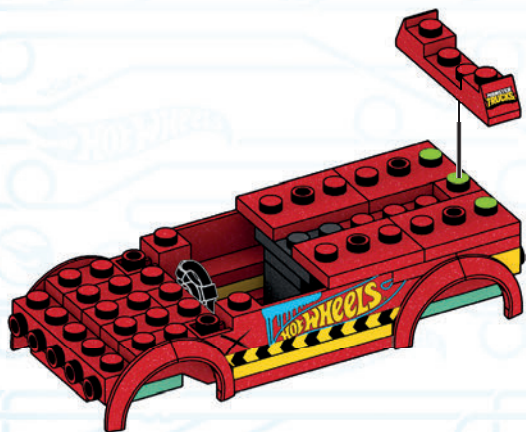



HW DEMO DERBY™ MONSTER TRUCK · CAMIÓN DE CARRERAS

23



1x

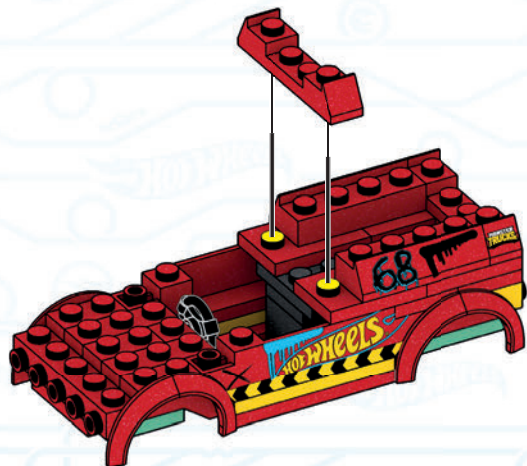

22



1x



1x

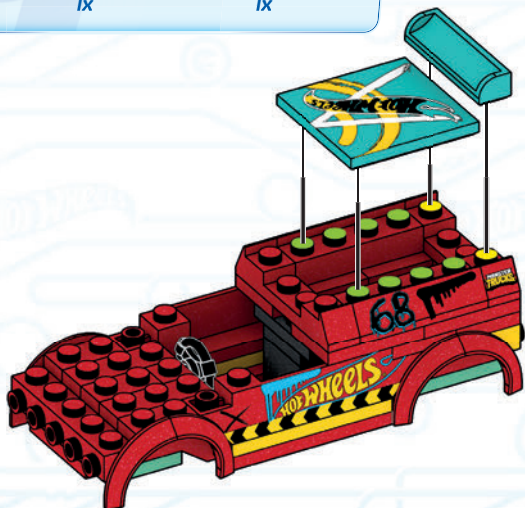

24



1x

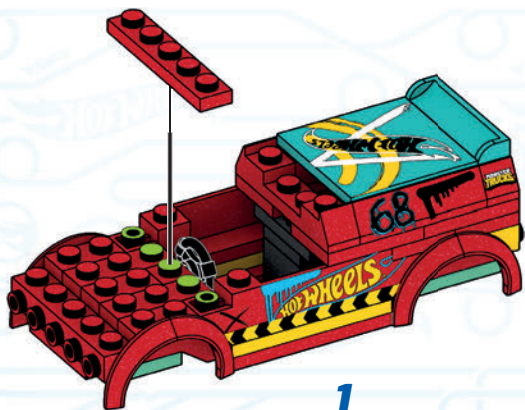

1

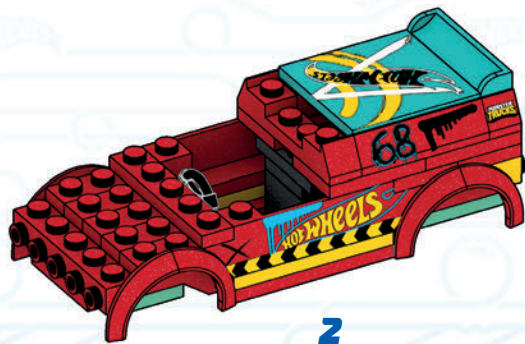

2



HW DEMO DERBY™ MONSTER TRUCK · CAMIÓN DE CARRERAS

25



2x



1x



1x

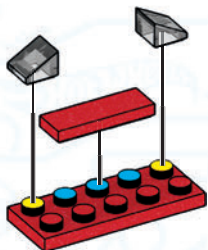

26



1x



1x



1x

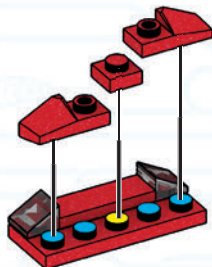

27

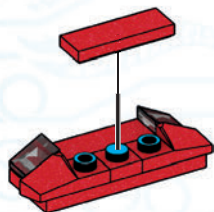

1

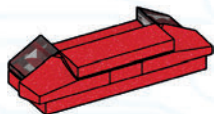

2

28

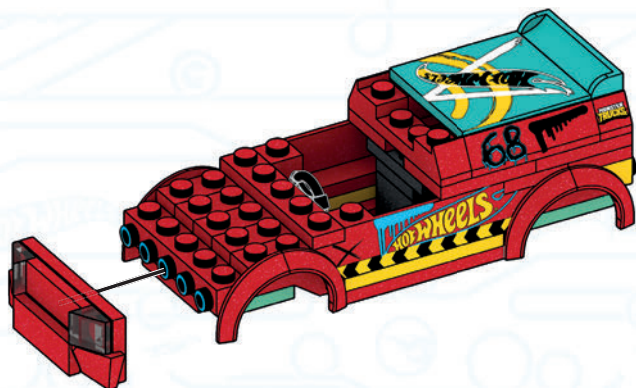



HW DEMO DERMY™ MONSTER TRUCK · CAMIÓN DE CARRERAS

29



1x



1x

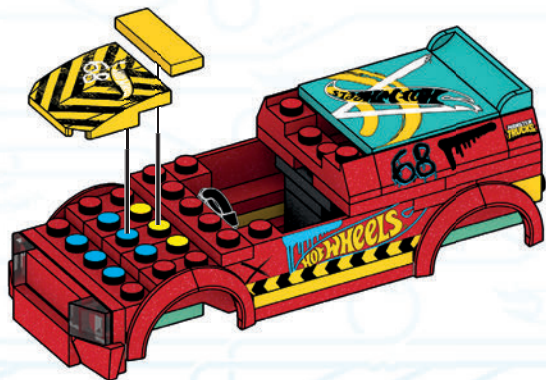

30



1x



1x

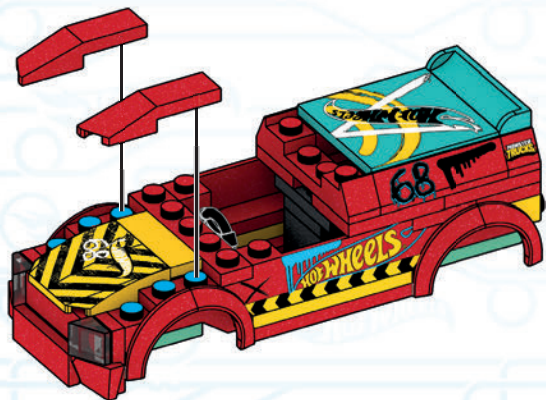

31



1x

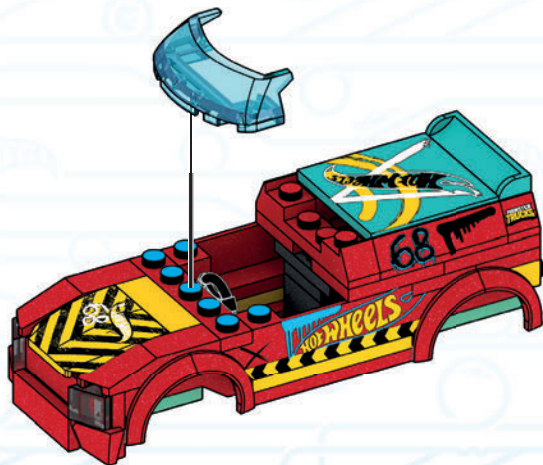



HW DEMO DERMY™ MONSTER TRUCK · CAMIÓN DE CARRERAS

32



1x

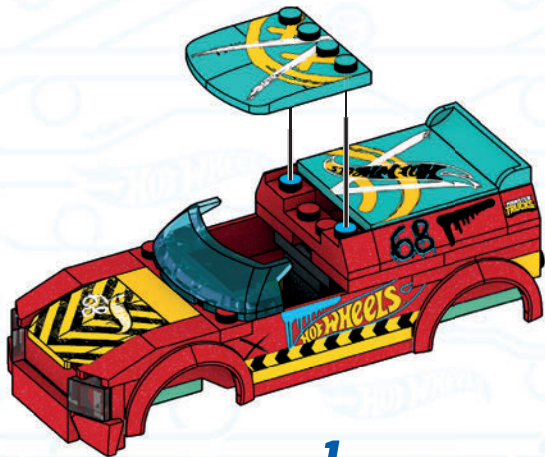

1

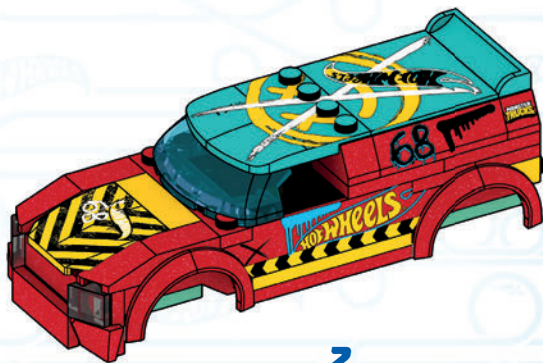

2

33

2x

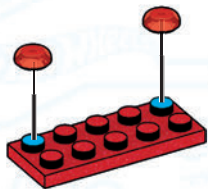

1x

**34**

1x

**1****2**



HW DEMO DERMY™ MONSTER TRUCK · CAMIÓN DE CARRERAS

35

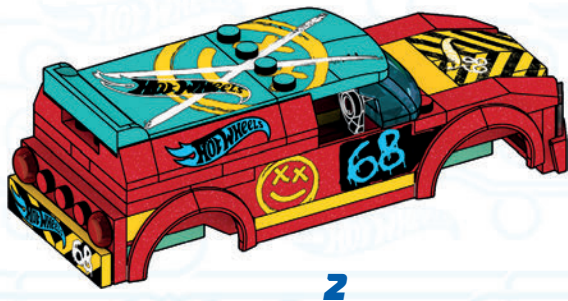
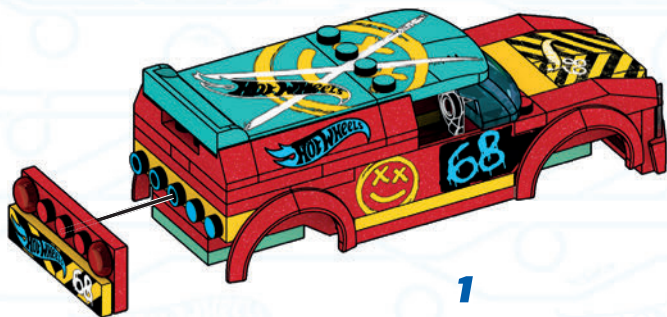

36



2x



2x

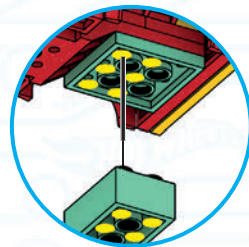
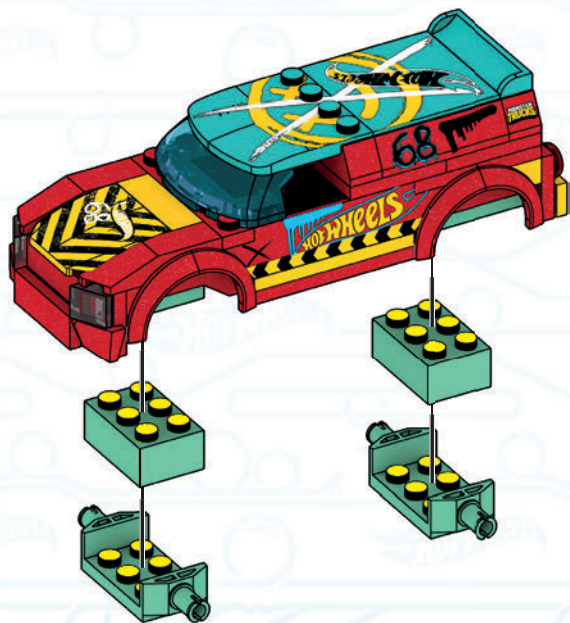
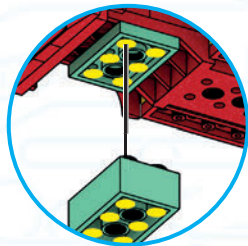



HW DEMO DERMY™ MONSTER TRUCK · CAMIÓN DE CARRERAS

37



4x

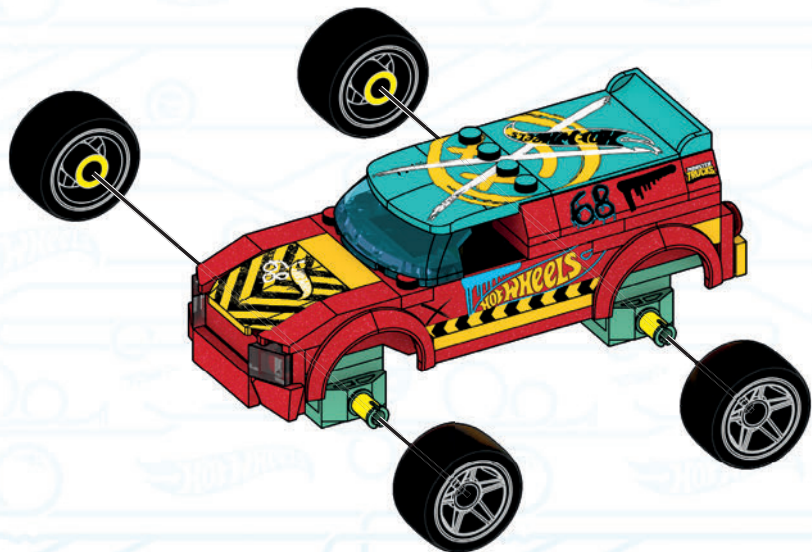





HW DEMO DERMY™ MONSTER TRUCK · CAMIÓN DE CARRERAS



38



1x

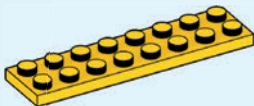

1x

39



2x

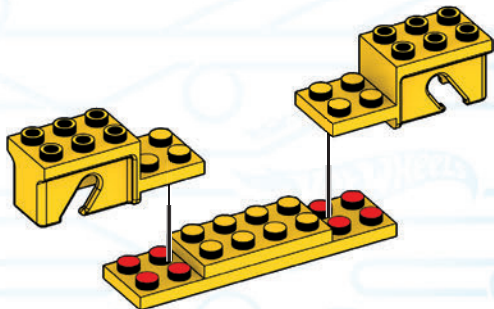
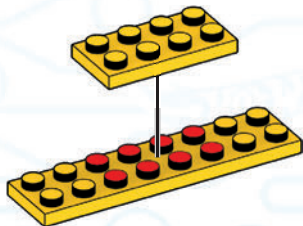

40

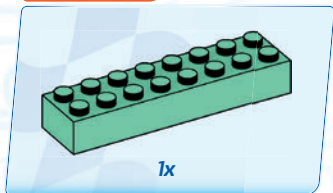

41

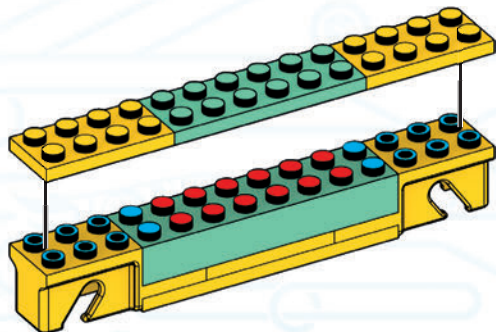
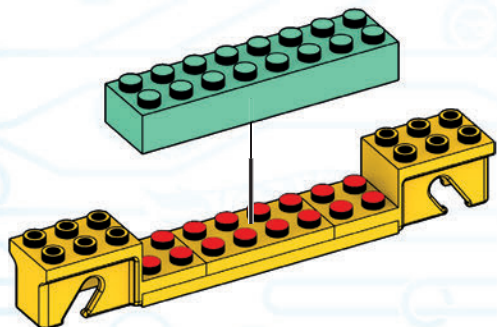
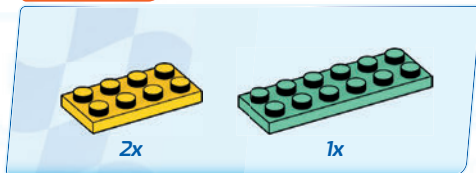



42



2x

43



2x

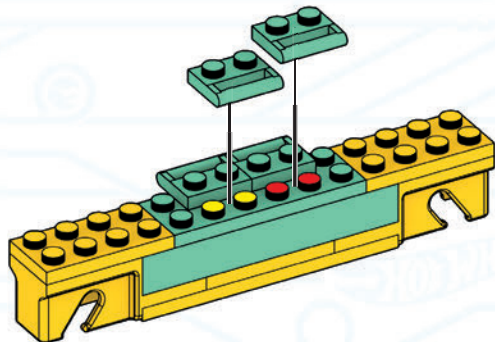
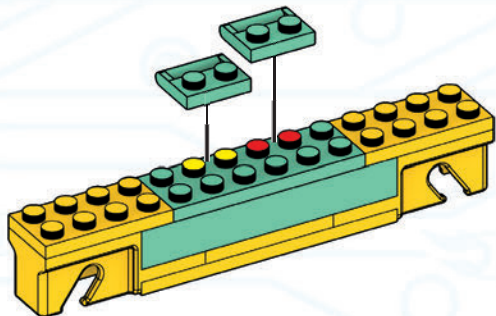

44

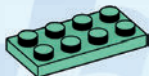

1x

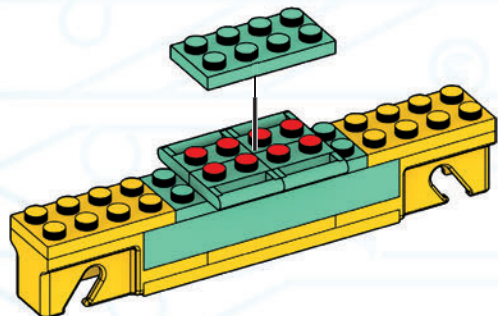

45



4x

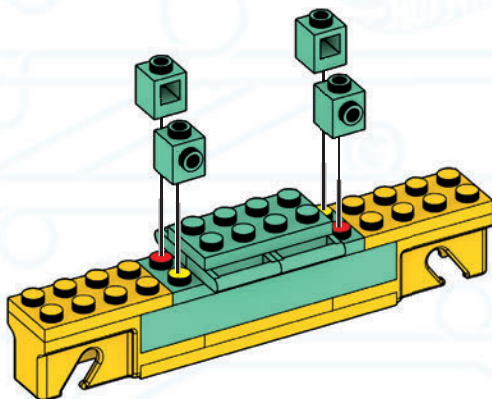
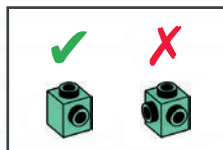



46



2x

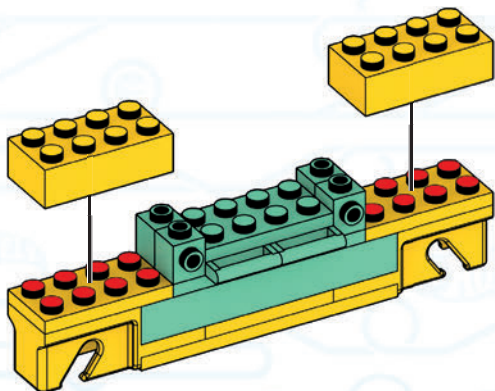

47



2x



2x

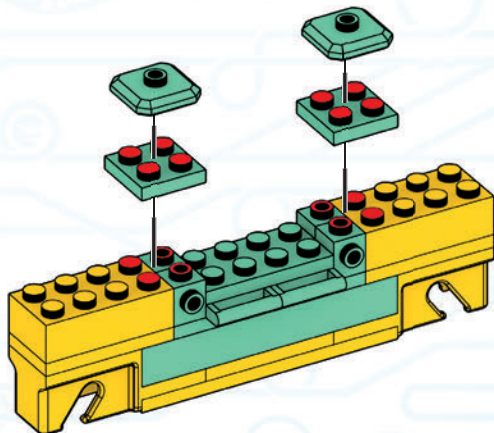

48



2x

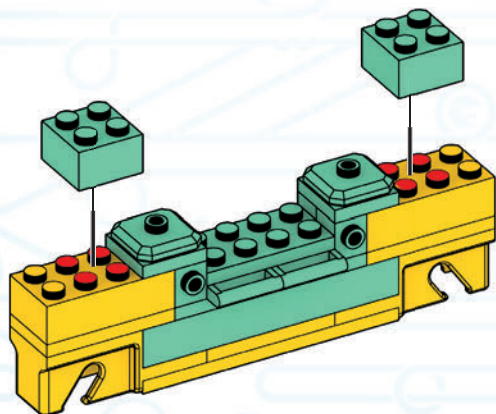

49



4x

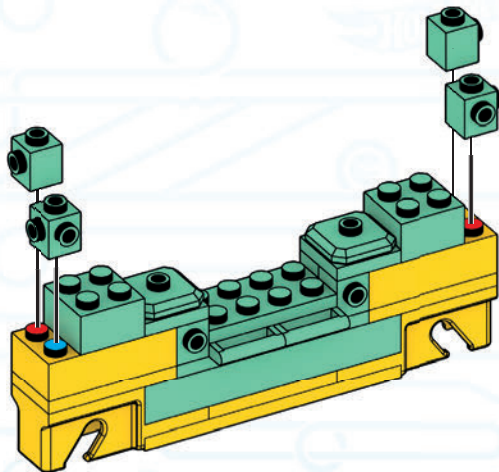



HW DEMO DERBY™ MONSTER TRUCK · CAMIÓN DE CARRERAS

50

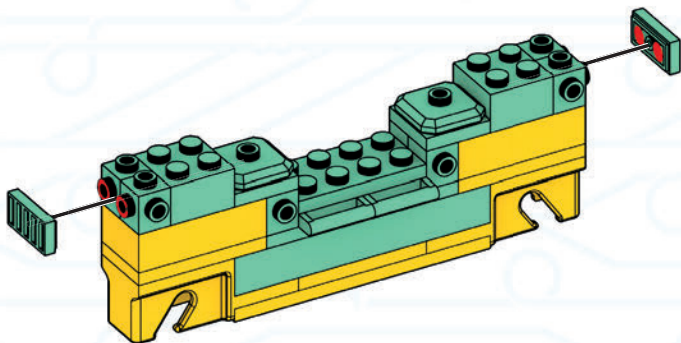

51



2x

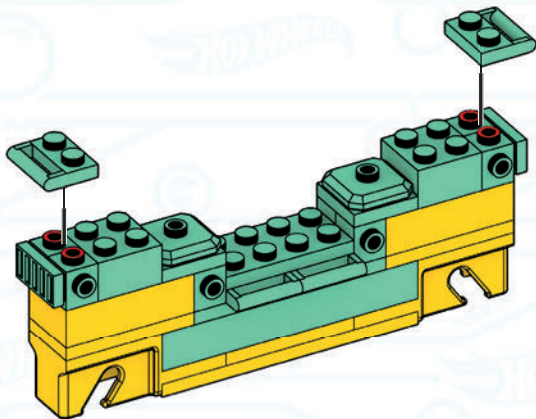



HW DEMO DERYM™ MONSTER TRUCK · CAMIÓN DE CARRERAS

52



4x

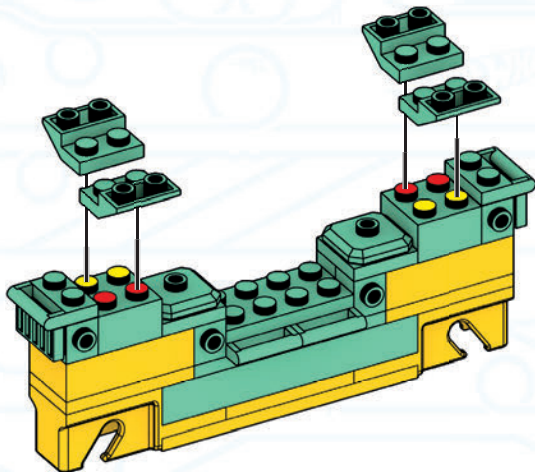

53



2x

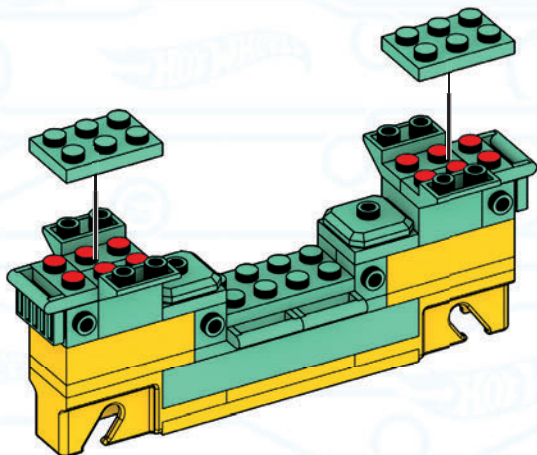



HW DEMO DERBY™ MONSTER TRUCK · CAMIÓN DE CARRERAS

54



2x

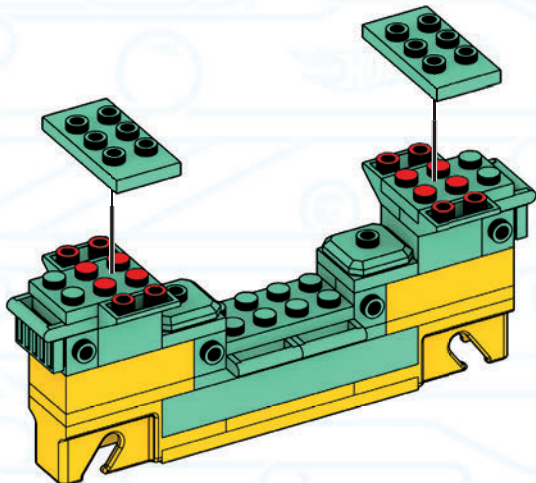

55



2x

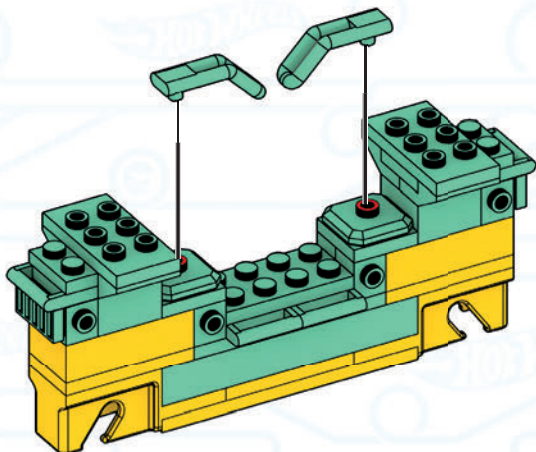



56

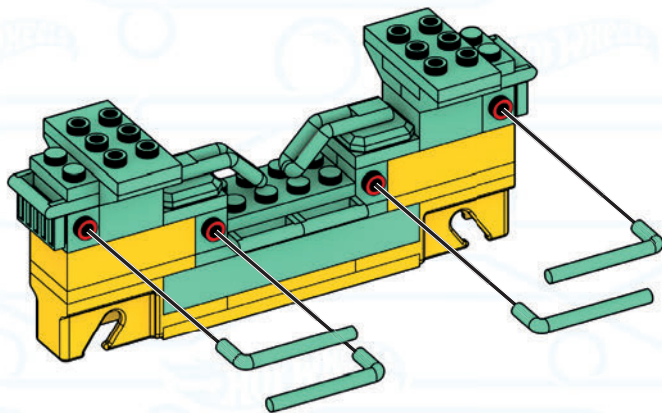
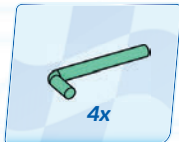

1

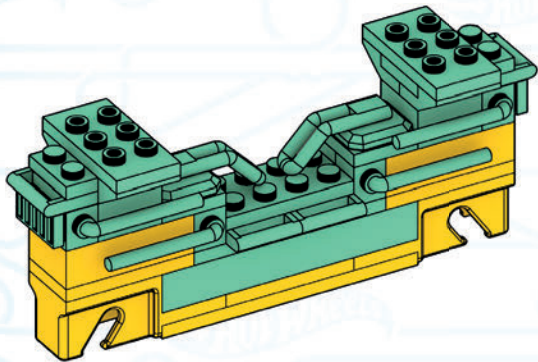

2

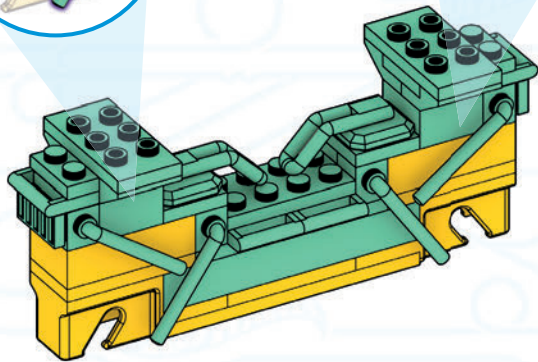
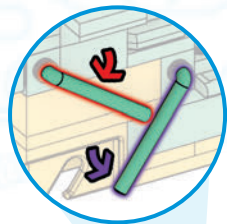

3

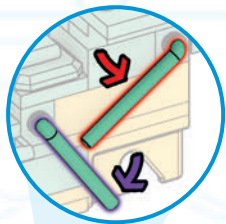



HW DEMO DERMY™ MONSTER TRUCK · CAMIÓN DE CARRERAS

57

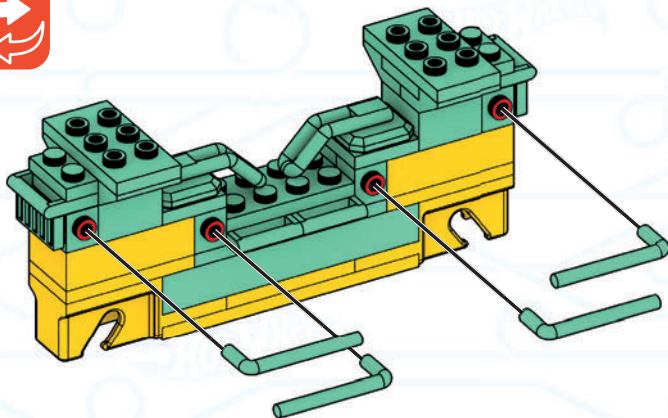
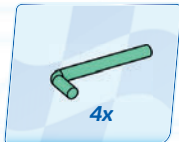

1

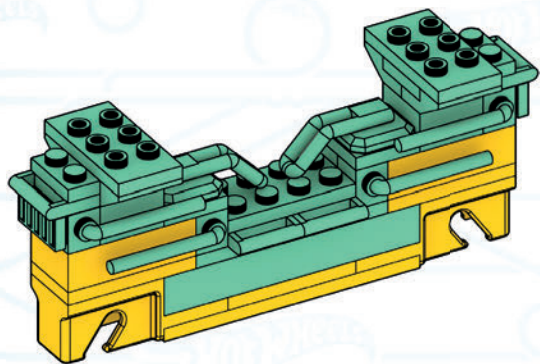

2

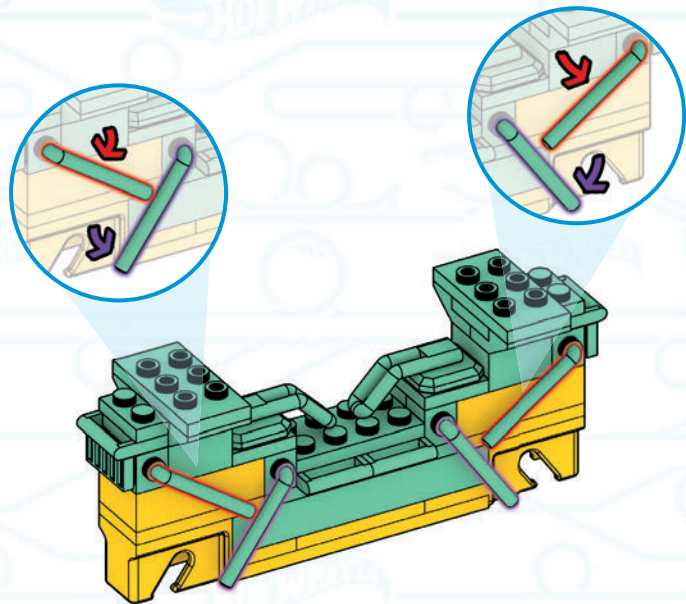

3



58

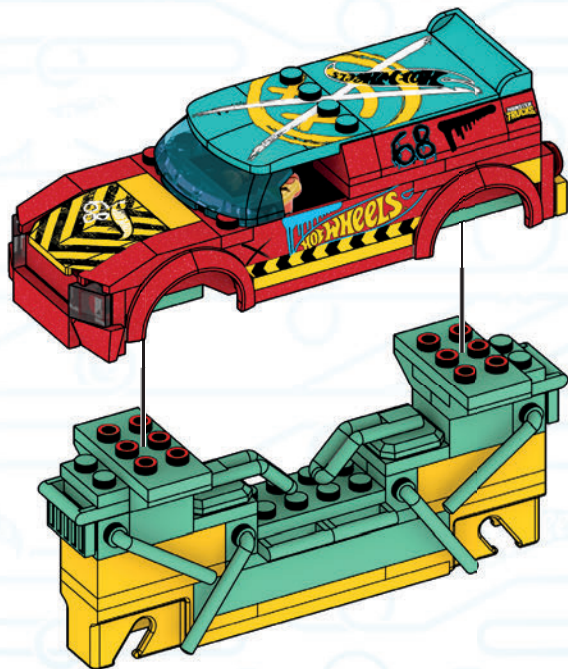
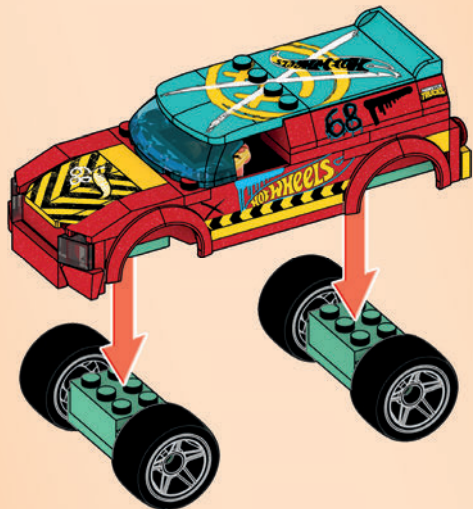

1

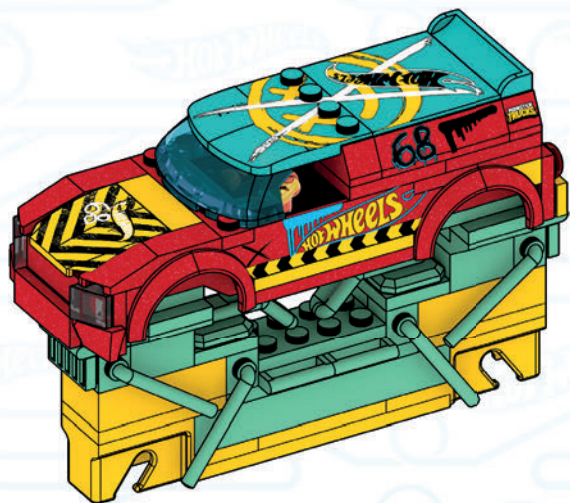

2



HW DEMO DERMY™ MONSTER TRUCK · CAMIÓN DE CARRERAS



59



1x



1x



1x

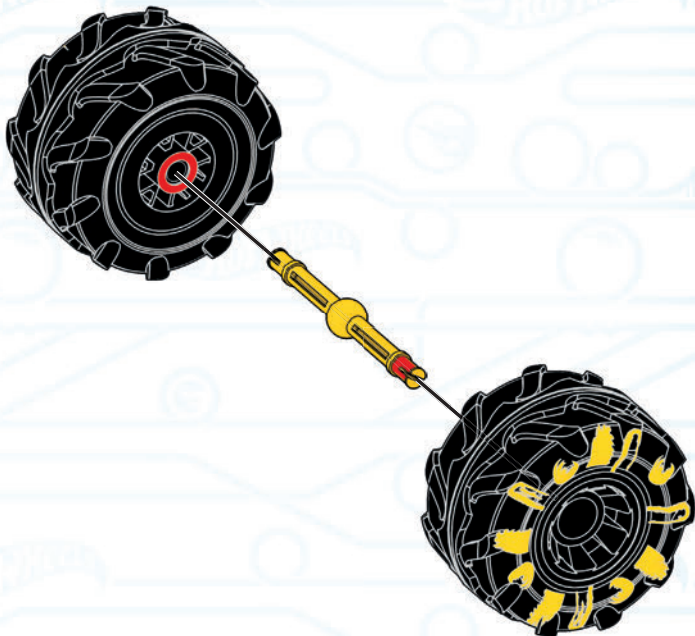

1

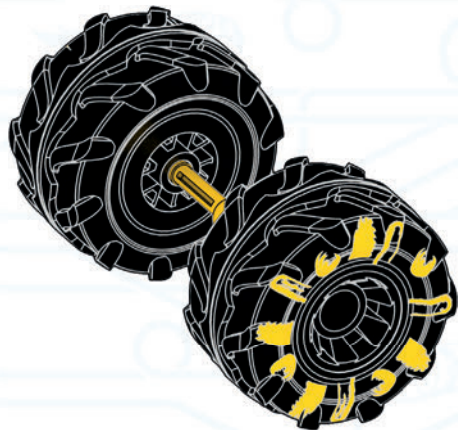

2



60

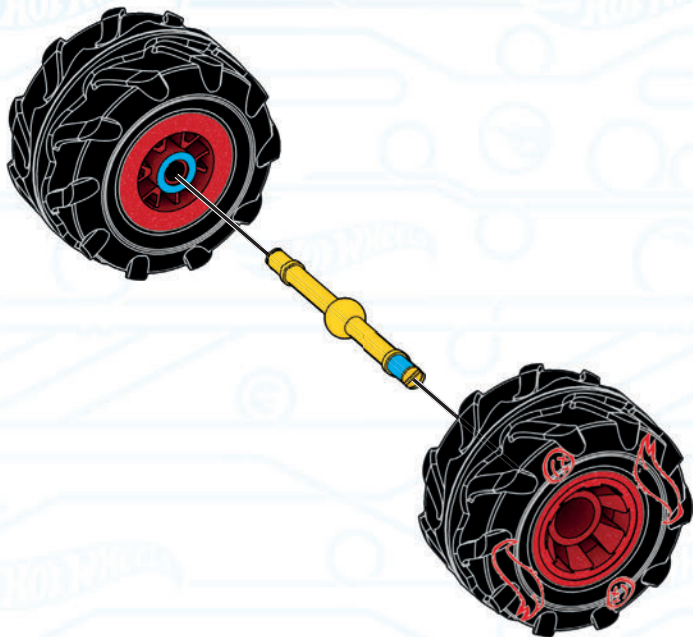
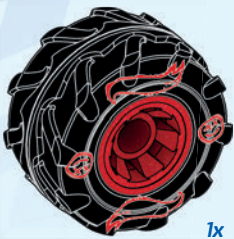



2



HW DEMO DERMY™
MONSTER TRUCK · CAMIÓN DE CARRERAS

61

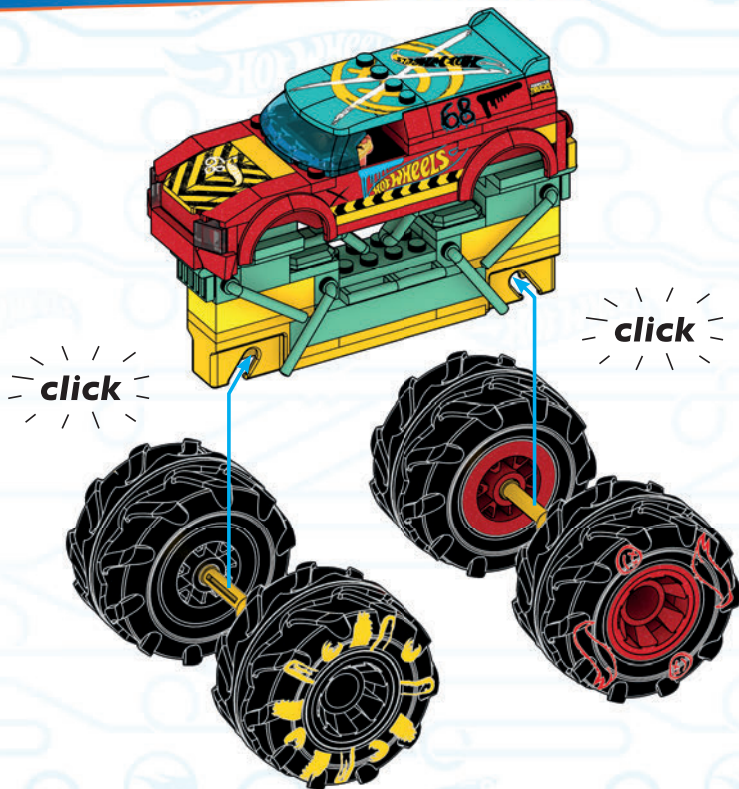

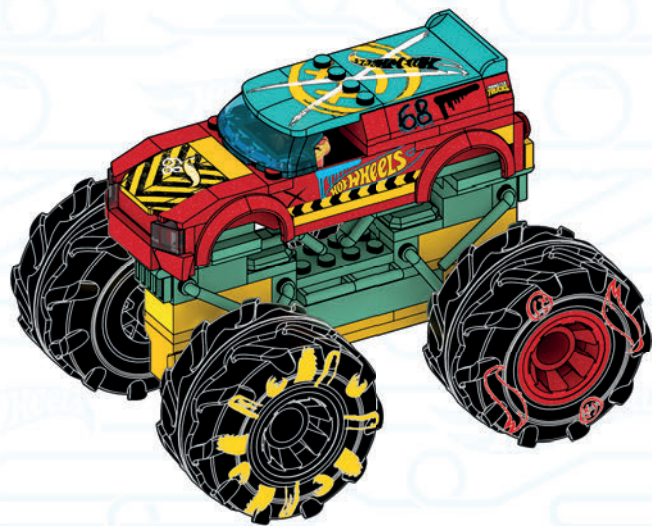

MIX & MATCH! COMBINE-LES!

MEZCLA Y COMBINA! • MISTURA E COMBINA!
ZUM KOMBINIEREN! • СОЧЕТАЙ И ПОДБИРАЙ!



HHD18*

BONE SHAKER™



HDJ89*

TWIN MILL™



HDJ90*

HW40™



GYG32*

RODGER DODGER™



GYG33*

MEGA WREX™



HDJ95*

TIGER SHARK™



GVM26*

'83 CHEVY®
SILVERADO™



HHL97*

64 CORVETTE®
GRAND SPORT™



HHL95*

TWINDUCTION™



GYG66*

RODGER DODGER™



GYG22*

'17 CAMARO®



HHL98*

'16 CADILLAC®
ATS-V™



HHL96*

RALLY CAT™



GVM13*

MOD ROD™



GVM13*

NIGHT SHIFTER™



GVM13*

DAWGZILLA™



GVM13*



* HDJ89 / HDJ90 / GYG32 / GYG33 / HDJ95 / GVM26 / GYG22 / GYG66 / GVM13 / HHL95 / HHL96 / HHL97 / HHL98 / HDJ93 / HDJ94 / HHD17 / HHD18 / HHD19

Set(s) sold separately and subject to availability. / Ensemble(s) vendu(s) séparément. Certains produits peuvent ne pas être commercialisés. / Se vende(n) por separado y está(n) sujeto(s) a disponibilidad. / Conjunto(s) vendido(s) em separado e sujeito(s) à disponibilidade. / Set in vendita separatamente, secondo disponibilità. / Das/Die Set(s) sind separat erhältlich. / Zestaw(y) sprzedawany(e) oddzielnie w zależności od dostępności. / Set(s) apart verkrijgbaar en afhankelijk van beschikbaarheid. / Набор(ы) продаются отдельно, при наличии. / Sæt sælges separat og så længe lager haves. / Seten säljs separat så länge lagret räcker. / Settet/settene selges separat så langt lageret rekker. / Pakkaus/pakkaukset myydään erikseen, saatavuus voi vaihdella. / Το(α) σετ πωλούνται ξεχωριστά και ανάλογα με τη διαθεσιμότητα. / Setler ayrı olarak satılır ve stoklarla sınırlıdır. / Set (sety) se prodává (prodávají) samostatně dle aktuální nabídky. / Súprava/-y sa predáva(jú) samostatne a podľa dostupnosti. / A készlet(ek) külön kapható(k), az elérhetőség változhat. / セット商品は別売りになります。在庫状況は別途ご確認をお願いします。

每套单独发售，按供货情况决定。

تباع المجموعة أو المجموعات على حدة وتخضع لتوافرها.

Additional purchase required. / Achat additionnel requis. / Zusätzlicher Kauf erforderlich. / Richiede acquisto addizionale. / Aanvullende aankoop vereist. / Requiere compra adicional. / Requiere compra adicional. / Ytterligare köp krävs. / Edellyttää lisäosien ostamista. / Supplerende køb nødvendig. / Ekstra kjøp kreves. / Wymagany dodatkowy zakup. / Vyžaduje dodatečný nákup. / Vyžaduje sa dokúpenie. / További vásárlás szükséges. / Неоходима дополнительная

покупка. / Αναπτερά επιπλέον αγορά. / Ek ürünü satın alınması gerekir. / تتطلب شراء القطع الإضافية.

REBUILD YOUR CARS INTO MONSTER TRUCKS! RÉASSEMBLE TES VOITURES POUR EN FAIRE DES MONSTER TRUCKS!

CONVIERTE TUS COCHES EN "MONSTER TRUCKS!" · TRANSFORMA OS SEUS CARROS EM MONSTER TRUCKS!
FAHRZEUGE IN MONSTER TRUCKS UMBAUEN! · ПЕРЕСТРАИВАЙ СВОИ МАШИНКИ В МОШТР-ТРАКИ!



HDJ95*

RACE ACE™



HDJ93*

GUNKSTER™



HDJ94*

V8 BOMBER™



HHD17*

HW DEMO DERBY™



HHD18*

TIGER SHARK™



GVM26*

HW 5 ALARM™



HHD19*

'83 CHEVY® SILVERADO™



HHL97*



1



2



3











Most models can be built one at a time. / La plupart des modèles peuvent être construits un à la fois. / La mayoría de modelos se pueden construir de uno en uno. / A maioria dos modelos pode ser construída separadamente. / La maggior parte dei modelli possono essere realizzati uno per volta. / Die meisten Modelle können eines nach dem anderen gebaut werden. / Większości modeli nie da się budować jednocześnie z innymi. / De meeste modellen kunnen één voor één gebouwd worden. / Большинство моделей могут быть собраны по одной за раз. / De fleste modeller kan bygges enkeltvis. / De fleste modeller kan bygges en i taget. / De fleste modellene kan bygges en om gangen. / Useimmat mallit voidaan rakentaa yksi kerrallaan. / Τα περισσότερα μοντέλα μπορούν να κατασκευασθούν ένα ένα. / Modellerin çoğu ayrı ayrı edilmeği gerektirebilir. / Většinou lze najednou sestavit pouze jeden model. / Väčšina modelov môže byť zostavená iba raz. / A modellek többségéből egyszerre csak egy építhető.











ほとんどのモデルは、一度に一つを組み立てることができます。 / يمكن تركيب التصميم الواحد تلو الآخر.









大多數型號可一次性建構









- 2x  AM75332X
- 2x  AM03328AXW
- 1x  AM80546AXW
- 2x  AM17127AGY
- 4x  AM07629ACS
- 4x  AM18286ACS
- 2x  AM09198ACS
- 1x  AM07590MM
- 1x  AM07590AXW
- 3x  AM09393AXW
- 1x  AM72496AXW
- 1x  AM72497AXW







- 1x  AM09013MM
- 6x  AM72000ACS
- 1x  AM81383F
- 2x  AM73009ACS
- 2x  AM03773ACS
- 1x  AM03773MM
- 4x  AM18223ACS
- 2x  AM09023ACS
- 1x  AM809668BYE
- 2x  AM80966AXW
- 3x  AM01314AXW

- 1x  AM03772MM
- 3x  AM03772ACS
- 2x  AM03772AXW
- 1x  AM03772AYP
- 2x  AM03873ACS
- 8x  AM77738ACS
- 2x  AM77747ACS
- 4x  AM17509AXW
- 1x  AM09921CV
- 2x  AM18299ACS

- 1x  AM09493ACS
- 3x  AM094938BYE
- 2x  AM090338BYE
- 1x  AS-HHD18-12
- 2x  AM074758BYE
- 1x  AM07475AXW
- 1x  AM80982AXW
- 1x  AM80981AXW
- 1x  AS-HHD18-13
- 1x  AM18336AXW

- 1x  AS-HHD18-06
- 1x  AS-HHD18-07
- 2x  AM80971ACS
- 4x  AM80965AXW
- 1x  AM01480ACS
- 1x  AM80538AAV
- 4x  AM80972AXW
- 1x  AS-HHD18-03

- 1x  AM81163ACS
- 1x  AM81163ATP
- 1x  AM81163AXW
- 1x  AS-HHD18-05
- 1x  AS-HHD18-04
- 4x  AS-HHD18-14
- 1x  AM809698BYE
- 1x  AM80970AXW

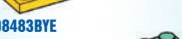
- 2x  AM809788BYE
- 1x  AS-HHD18-01
- 1x  AS-HHD18-02
- 2x  AM809798BYE
- 1x  AM084838BYE
- 1x  AM04984ACS
- 1x  AM80855MCX



1x
AS-HHD18-10



1x
AS-HHD18-11



1x
AS-HHD18-08

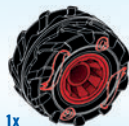

1x
AS-HHD18-09

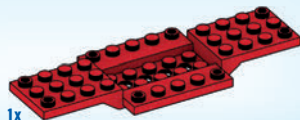

1x
AM80975AXW



1x
FIG-HHD18-A



Missing pieces? • Pièces manquantes?

¿Partes faltantes? • Perdeu peças?
Fehlende Teile? • Не хватает деталей?

support.megabrand.com

ATTENTION : DANGER
D'ÉTOUFFEMENT. - PRÉSENCE DE PETITS
ÉLÉMENTS. NE CONVIENT PAS AUX ENFANTS DE
MOINS DE 3 ANS.

ATENÇÃO! NÃO INDICADO / NÃO
RECOMENDÁVEL PARA CRIANÇAS MENORES DE 3
(TRÊS) ANOS POR CONTER PARTE(S) PEQUENA(S)
QUE PODE(M) SER ENGOLIDA(S) OU ASPIRADA(S)
PODENDO PROVOCAR ASFIXIA.

警告:
のどにつまる危険 小さな部品が含まれています
3歳以下の子供には与えないで下さい。

警告!
不适合3岁以下儿童使用。
内含小零件。

WARNING : CHOKING HAZARD. - Small parts. Not for children under 3 years.
ADVERTENCIA : PELIGRO DE ATRAGANTAMIENTO. Juguete no recomendado
para menores de 3 años, porque contiene piezas pequeñas que podrían
provocar asfixia en caso de ser ingeridas o inhaladas por el/la niño/a.
AVVERTENZA : Contiene pezzi di piccole dimensioni.

ACHTUNG: Kleine Teile.
OSTRZEŻENIE: Małe części. Niebezpieczeństwo zadławienia.
WAARSCHUWING: Kleine onderdelen
ПРЕДУПРЕЖДЕНИЕ: Мелкие детали.
ADVASEL: Ineholder små dele.
WARNING: Smådelar
ADVASEL: Små deler
VAROITUS: Pieniä osia
ΠΡΟΣΟΧΗ: Περιλαμβάνονται μικρά κομμάτια.
UYARI: Küçük parçalar.
UPOZORNĚNÍ: Malé díly
UPOZORNENIE: Malé časti
FIGYELMEZTETÉS: Kis alkatrészek.



تحذير:

غير مناسبة للأطفال دون 36 شهراً - قطع صغيرة.

Mattel Europa B.V., Gondel 1, 1186 MJ Amstelveen, Nederland.
Mattel U.K. Limited, The Porter Building, 1 Brunel Way, Slough SL1
1FQ, UK. Mattel France, Parc de la Cersaie, 1/3/5 allée des Fleurs,
94260 Fresnes Cedex. N° Cristal 0969 36 99 99 (Numéro non sur-
taxé) ou www.lesjouetsmattel.fr Mattel Belgium, Trade Mart, Atomi-
umsquare, Bogota 202 - B 275, 1020 Brussels. Grátis nummer
België: 0800 - 16 936 - Grátis nummer Luxemburg: 800 - 22 784
-Grátis nummer Nederland: 0800 - 262 88 35. Deutschland: Mat-
tel GmbH, Solmsstraße 4, D-60486 Frankfurt am Main. Schweiz:
Mattel AG, Kirchstrasse 24, CH-3097 Liebefeld. Österreich: Mattel
Ges.m.b.H., Campus 21, Liebermannstraße A01 404, A- 2345
Brunn/Gebirge. Mattel Italy Srl, Via Bracco, 6-MAC 6, 20159 Milano,
Italy. Servizio assistenza clienti: Customersrv.italia@mattel.com -
Numero verde 800 11 37 11. Mattel España, S.A., Arribau 20.08036
Barcelona. cservice.spain@mattel.com Tel: 900 102 390 <http://www.service.mattel.com/es>. Mattel East Asia Ltd., Room 503-09,
North Tower, World Finance Centre, Harbour City, Tsimshatsui, HK,
China. Tel: (852) 3185-6500. Dilimport & Diddarkan Oleh: Mattel
Continental Asia Sdn Bhd. Level 19, Tower 3, Avenue 7, No. 8 Jalan
Kerinci, Bangsar South, 59200 Kuala Lumpur, Malaysia. Mattel
South Africa (PTY) LTD, Office 102 B3, 30 Melrose Boulevard, Jo-
hannesburg 2196. Dystrybutor: Mattel Poland Sp. z o.o., Warsaw
Trade Tower 34 p., ul. Chłodna 51, 00-867 Warszawa. Mattel Aus-
tralia Pty. Ltd., 658 Church St., Richmond, Victoria, 3121. Consumer
Advisory Service - 1300 135 312. Mattel AEBE, Εθνάρχου Μακαρίου
1, Κηφισό Κ-2, ΤΚ 17561, Πολυλόγος Φάληρο. Mattel Oyuncakçılık
Tic. Ltd. Şti. İkerenköy Mah. Erkut Sok. A Blok No:12 Üner Plaza
Kat:9-10 34752 Ataşehir İstanbul. Tel: 0216 570 75 00. Импортёр/
Уполномоченная организация: ООО "МАТТЕЛ" Российская
Федерация, 105120 Москва, 2-й Сыромятинский переулок.1:
+7 495 287 79 39. Mattel Czech Republic s.r.o., The Forum, Vá-
clavské nám. 19, 11000 Praha1. Mattel, 333 Continental Boulevard,
El Segundo, CA 90245, USA. Mattel Canada Inc., Mississauga,
Ontario L5R 3W2. Consumer Services: You may call us free at/
Composé sans frais le 1-800-524-8697. Importado y distribuido
por Mattel de México, S.A. de C.V., Miguel de Cervantes Saavedra
No. 193, Pisos 10 y 11, Col. Granada, Alcaldía Miguel Hidalgo, C.P.
11520, México, Ciudad de México. R.F.C. MME-920701-NB3. Tels:
59-05-51-00 Ext. 5206 ó 01-800-463-59-89. Mattel Chile, S.A.,
Avenida Américo Vespucio 501-B, Quilicura, Santiago. Tel: 1230-
020-6213. Servicio al consumidor Venezuela: Tel: 0-800-100-9123.
Mattel Argentina, S.A., Av. Libertador 1000, Piso 11 - Oficinas 109
y 111, Vicente López - Prov. Buenos Aires. Tel: 0800-666-3373.
Mattel Colombia, S.A., Calle 123#-07 P.5, Bogotá. Tel: 01800-710-
2069. Mattel Perú, S.A., Av. Juan de Arona # 151, Centro Empres-
arial Juan de Arona, Torre C, Piso 7, Oficina 704, San Isidro, Lima 27,
Perú. RUC: 20425853865. Reg. Importador: 02350-12-JUE-DIGESA.
Tel: 0800-54744. E-mail Latinoamerica.servicio.clientes@mattel.com
com. Mattel do Brasil Ltda. - CNPJ: 54.558.002/0001-20 - Rua Verbo
Divino, 1488 - 2º. Andar - 04719-904 - Chácara Santa Antônio - São
Paulo - SP - Brasil. Serviço de Atendimento ao Consumidor: fone
0800 575 0780. E-mail: sac.matteldobrazil@mattel.com

BUILD YOUR WAY BY COMBINING MEGA™ HOT WHEELS® SETS CRÉEZ VOTRE UNIVERS EN ASSOCIANT LES COFFRETS HOT WHEELS® MEGA



HDJ95

HHL95

HHL96

HHL97

HHD18

CONSTRUYE EL RETO COMBINANDO LOS CONJUNTOS DE HOT WHEELS® DE MEGA™ • CONSTRUA O DESAFIO COMBINANDO OS CONJUNTOS MEGA™ HOT WHEELS® EIGENE STRECKEN BAUEN DURCH DAS KOMBINIEREN VON MEGA HOT WHEELS SETS • СТРОЙТЕ ПО-СВОЕМУ, ОБЪЕДИНЯЯ НАБОРЫ MEGA™ HOT WHEELS®

Set(s) sold separately and subject to availability. / Ensemble(s) vendu(s) séparément. Certains produits peuvent ne pas être commercialisés. / Se vende(n) por separado y está(n) sujeto(s) a disponibilidad. / Conjunto(s) vendido(s) em separado e sujeito(s) à disponibilidade. / Set in vendita separatamente, secondo disponibilità. / Das/Die Set(s) sind separat erhältlich. / Zestaw(y) sprzedawany(e) oddzielnie w zależności od dostępności. / Set(s) apart verkrijgbaar en afhankelijk van beschikbaarheid. / Набор(-ы) продаются отдельно, при наличии. / Sæt sælges separat og så længe lager haves. / Seten säljs separat så länge lagret räcker. / Tettett/settene selges separat så langt lageret rekker. / Pakkaus/pakkaukset myydään erikseen, saatavuus voi vaihdella. / Το(α) σετ πωλούνται ξεχωριστά και ανάλογα με τη διαθεσιμότητα. / Setler ayrı olarak satılır ve stokları sınırlıdır. / Set (sety) se prodává (prodávají) samostatně dle aktuální nabídky. / Súprava/-y sa predáva(jú) samostatne a podľa dostupnosti. / A készlet(ek) külön kapható(k), az elérhetőség változhat. / セット商品は別売りになります。在庫状況は別途ご確認をお願いします。 / تباع المجموعة أو المجموعات على حدة وتخضع لتوافرها.

每套单独发售，按供货情况决定。

1186 MJ, 1, NL

©2021 MEGA Brands &™ MEGA Brands. HOT WHEELS™ and associated trademarks and trade dress are owned by and used under license from Mattel. HOT WHEELS™ ainsi que les marques et designs y afférents appartiennent à, et sont utilisés sous licence de Mattel. ©2021 Mattel.

Printed in China / Imprimé en Chine

AD-HHD18-01A

Mattel Canada Inc. Mississauga, Ontario L5R 3W2.
MADE IN CHINA. FABRIQUÉ EN CHINE. FABRICADO NA / HECHO EN CHINA.
ИЗГОТОВЛЕНО В КИТАЕ. ÇIN'DE ÜRETİLMİŞTİR. صنع في الصين

PD714,887

