

MEGA™

POKÉMON™



1 → 4

HNT94-01

PIKACHU



## Build Construisez

Construye | Constrói  
Вауен | Стройте



## Share Partagez

Comparte | Partilha  
Teilen | Делитесь

Device not included | Appareil non inclus  
Dispositivo não incluído | Dispositivo não incluído  
Gerät nicht enthalten | Устройство не входит в комплект



[megaunboxed.com](https://megaunboxed.com)

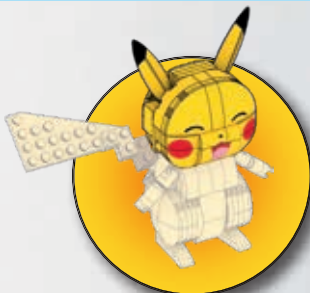

1



1x



1x



2x

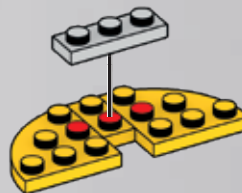

2



3x

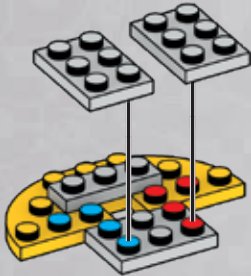

3



1x



1x



1x

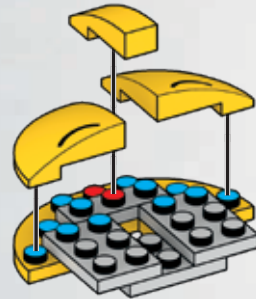

4



1x

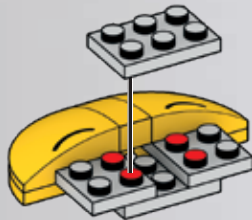

5



2x



1x



1x



1x



1x



1



2



6



2x

1x

7



2x

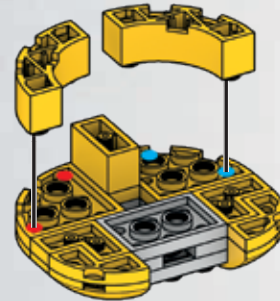
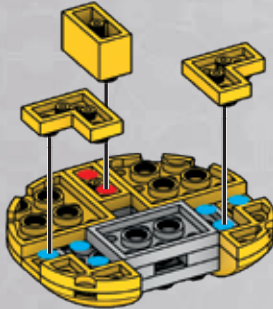

8



1x

1x

2x

1x

9



1x

1x

2x

1x

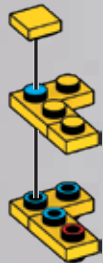

1



2

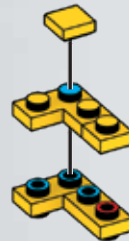

1



2

10

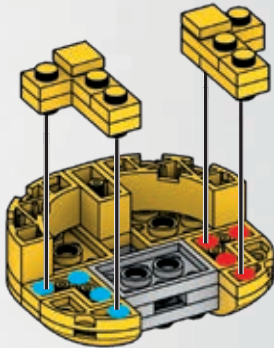

11

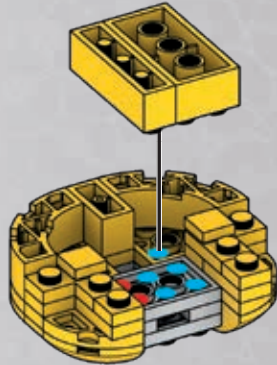
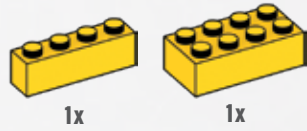

12

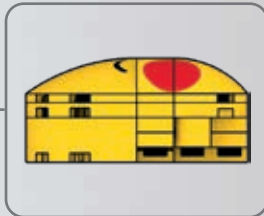
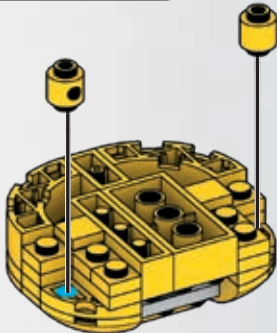

13

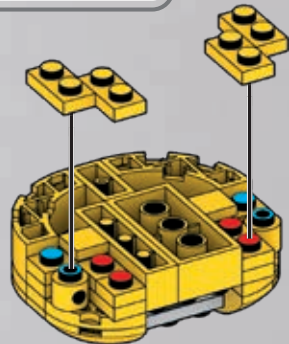

14



2x



2x



1x

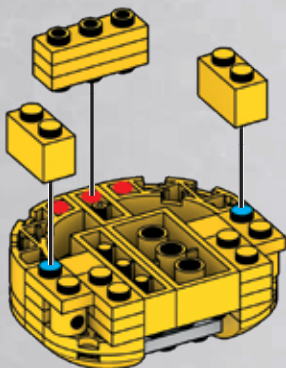
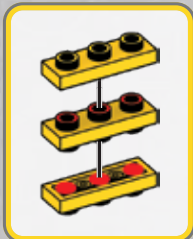

1

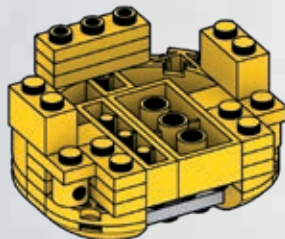

2

15



3x



1x



16



2x



2x



1x

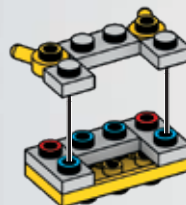

17



1x



1x



1



2

18

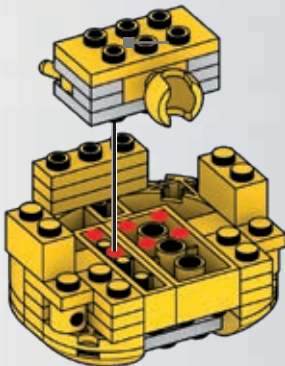

1

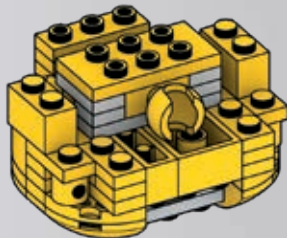

2

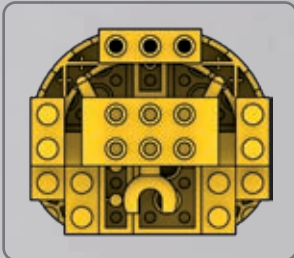

19



1x

1x

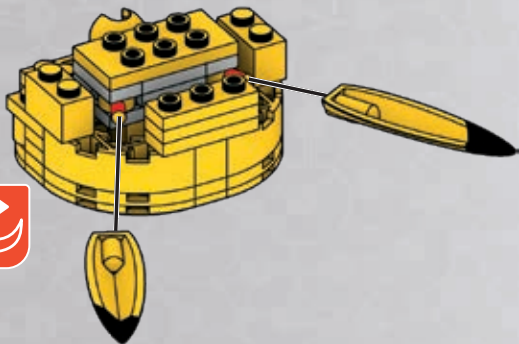

20



1x

1x

2x

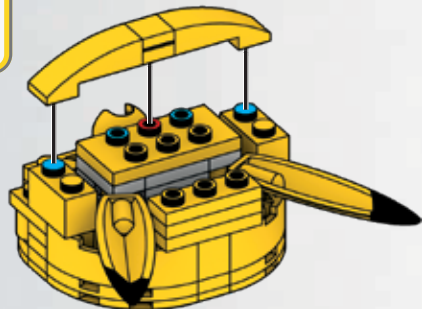

21



1x

2x

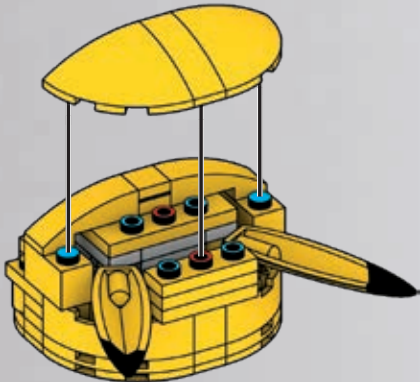

1

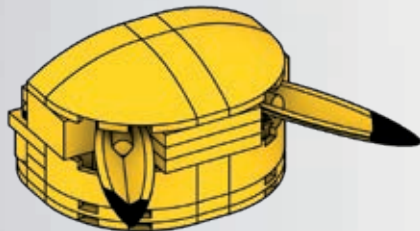

2

22



2x



2x



2x



2x



1



2



3

x2

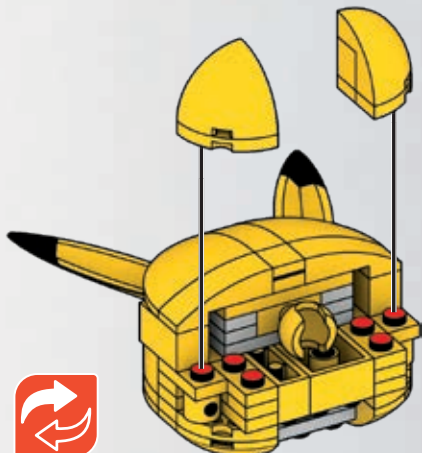

1

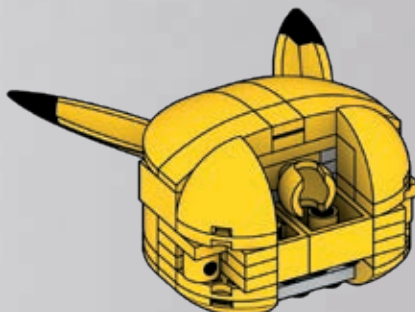

2



23



1x



1x

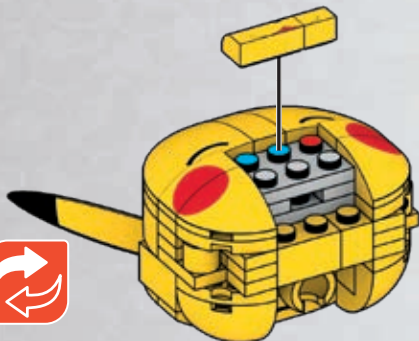

24



1x



1x

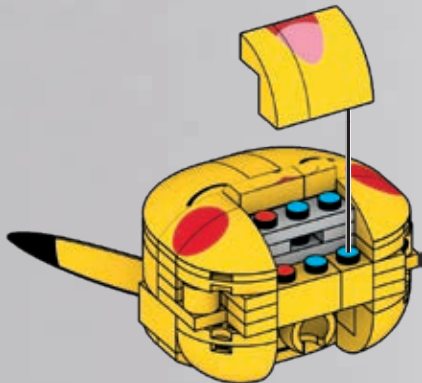

1

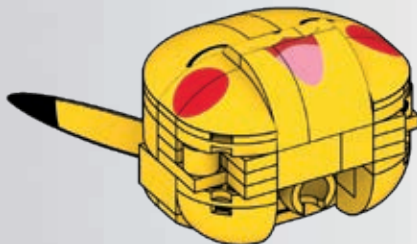

2



25



1x

1x

1x

26



2x

1x

1x

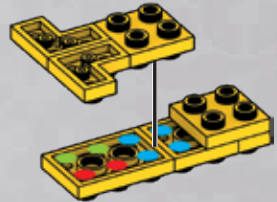

27



1x

1x

1x

28



2x

29



2x

1x

2x

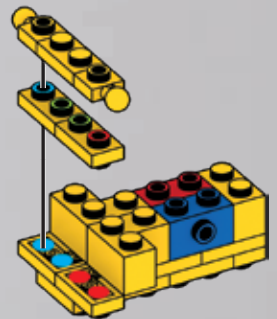
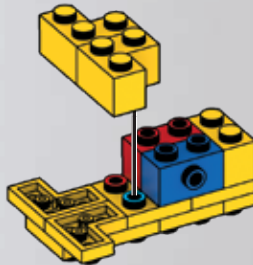
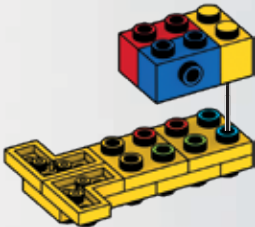

30



1x



1x

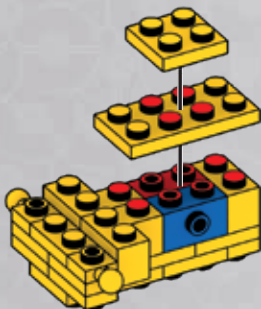

31



4x

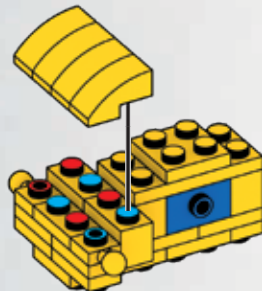

32



2x

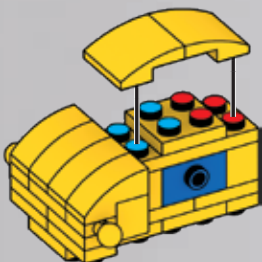

1

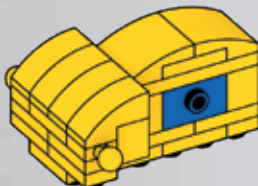

2

33



2x

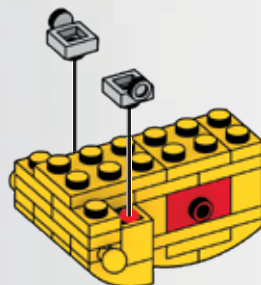

**34**

4x

1x

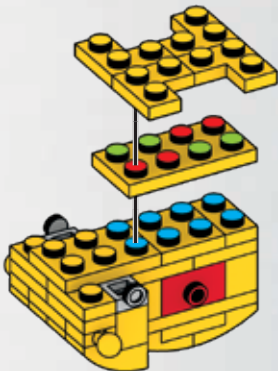
**35**

1x

1x

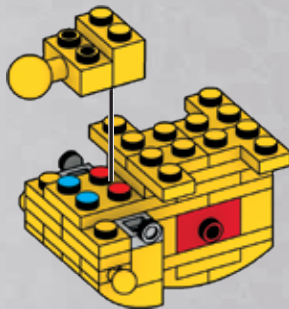
**36**

2x

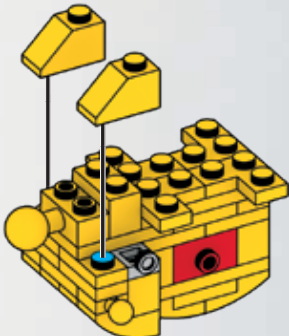
**37**

1x

2x

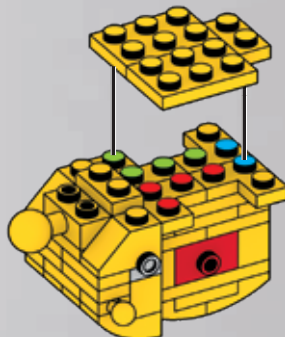

38



2x



1x

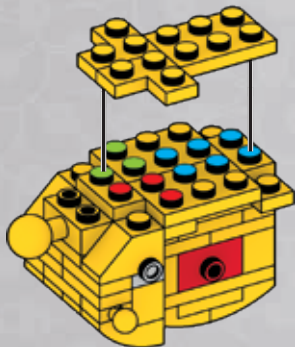

39



1x



1x



2x

X



✓

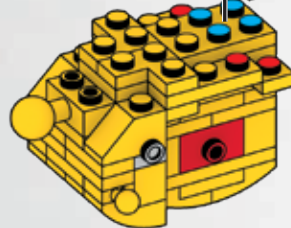

40



2x



1x

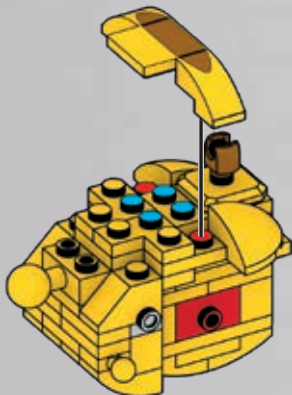

41



1x



1x

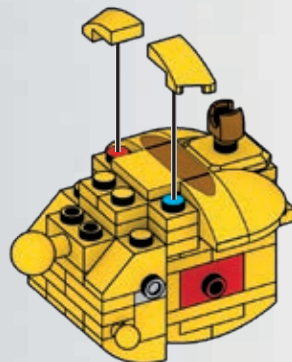

42



2x



1x



1x

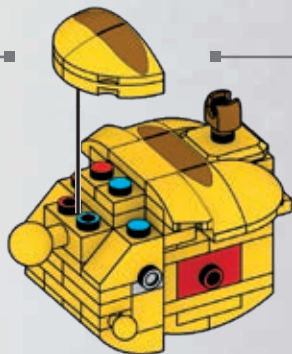

1

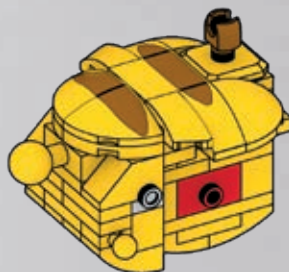

2



43



2x



2x

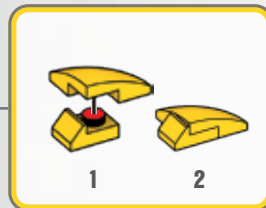
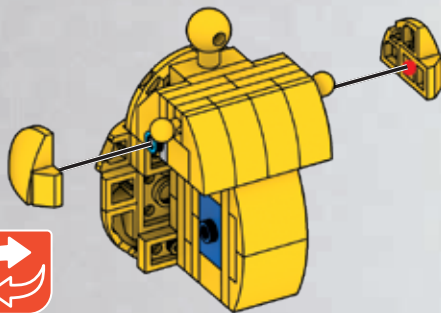
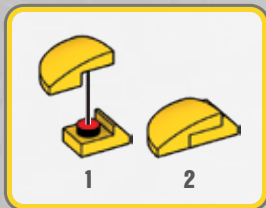

44



1x



1x

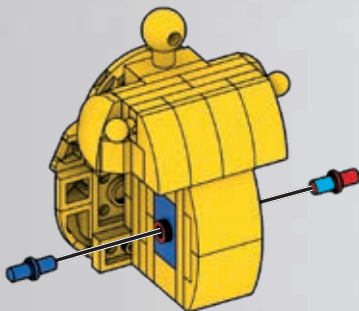

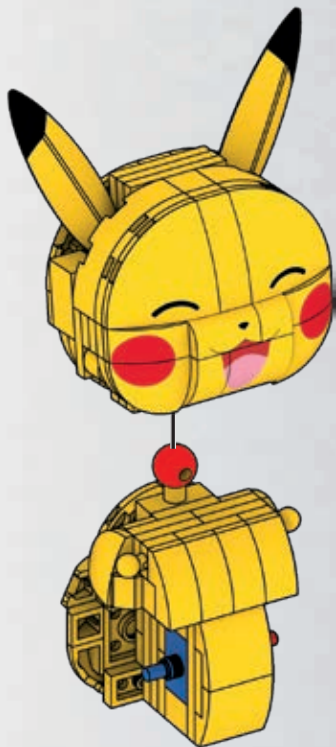

1

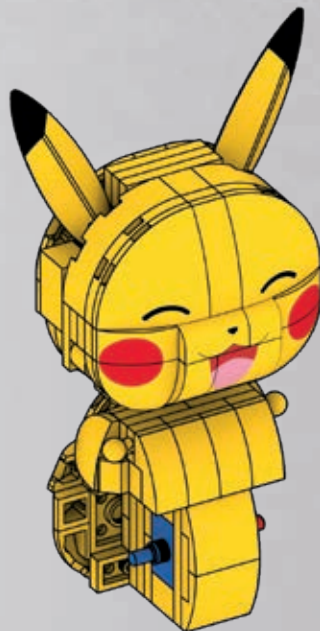

2



46



1x



1x

47



3x



48



1x



1x

49



3x



50



1x



51



3x



1



2

52



1x



4x



1



2

53



1x



1x



1



2

54

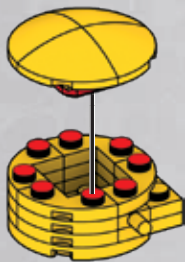

1

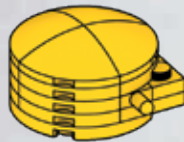

2

55



1x

1x

1x

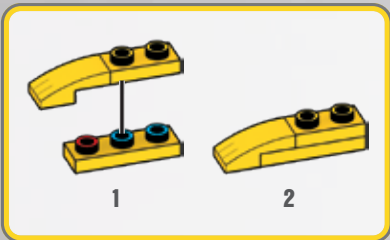
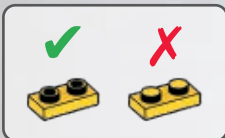

1



2

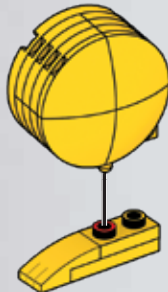

1

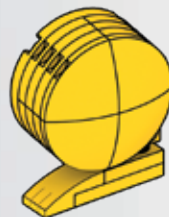

2

56



1x

1x



57



3x



58



1x

1x

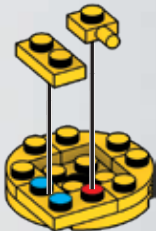

59



3x

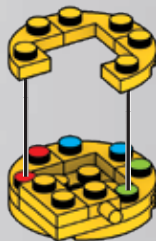

60



1x





61



3x



1



2

62



1x



4x



1



2

63



1x



1x



1



2

64

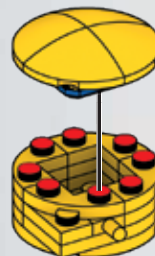

1



2

65



1x



1x



1x



1



2



1



2

66

65

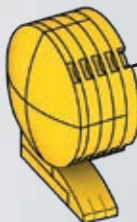

55

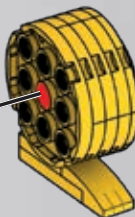

67



2x



2x



2x



2x



1

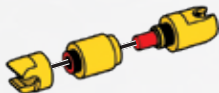

2



3

x2

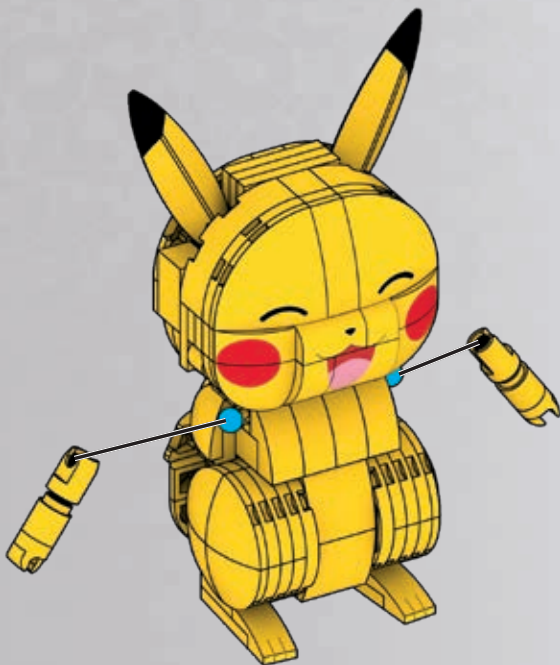

1

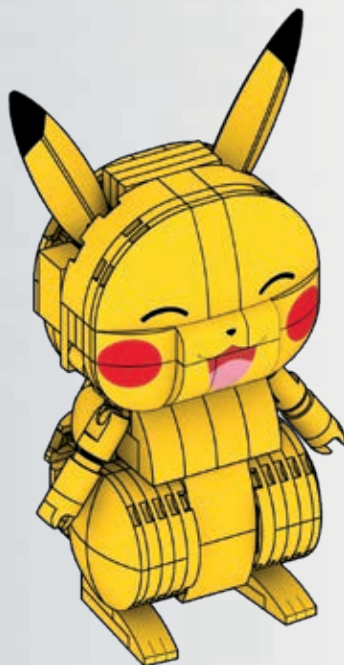

2

68



1x



1x



2x



1x

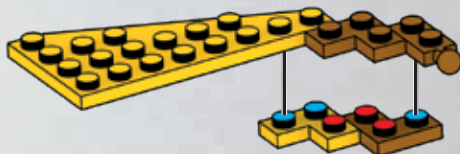

69



1x



1x

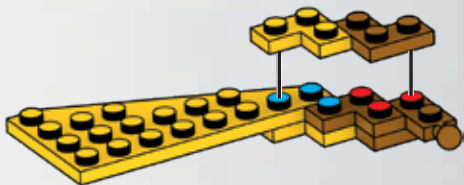

1



2

70

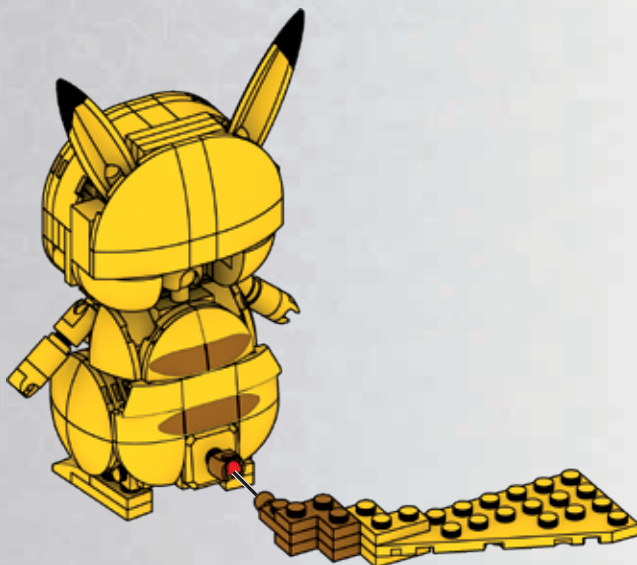

1

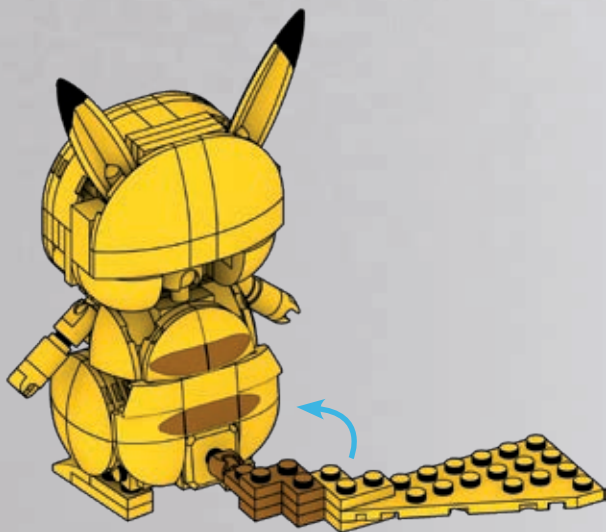

2

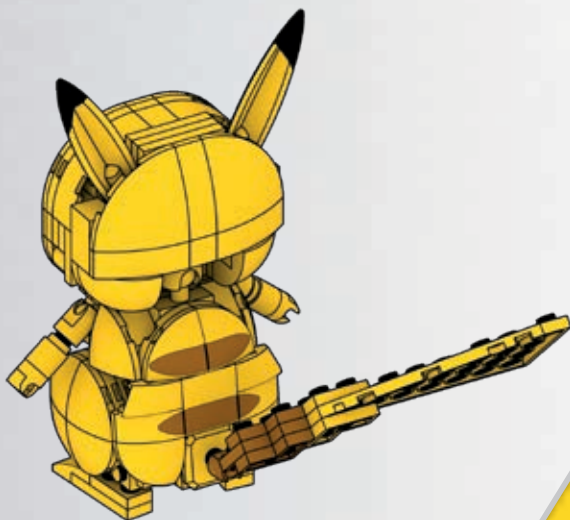

3

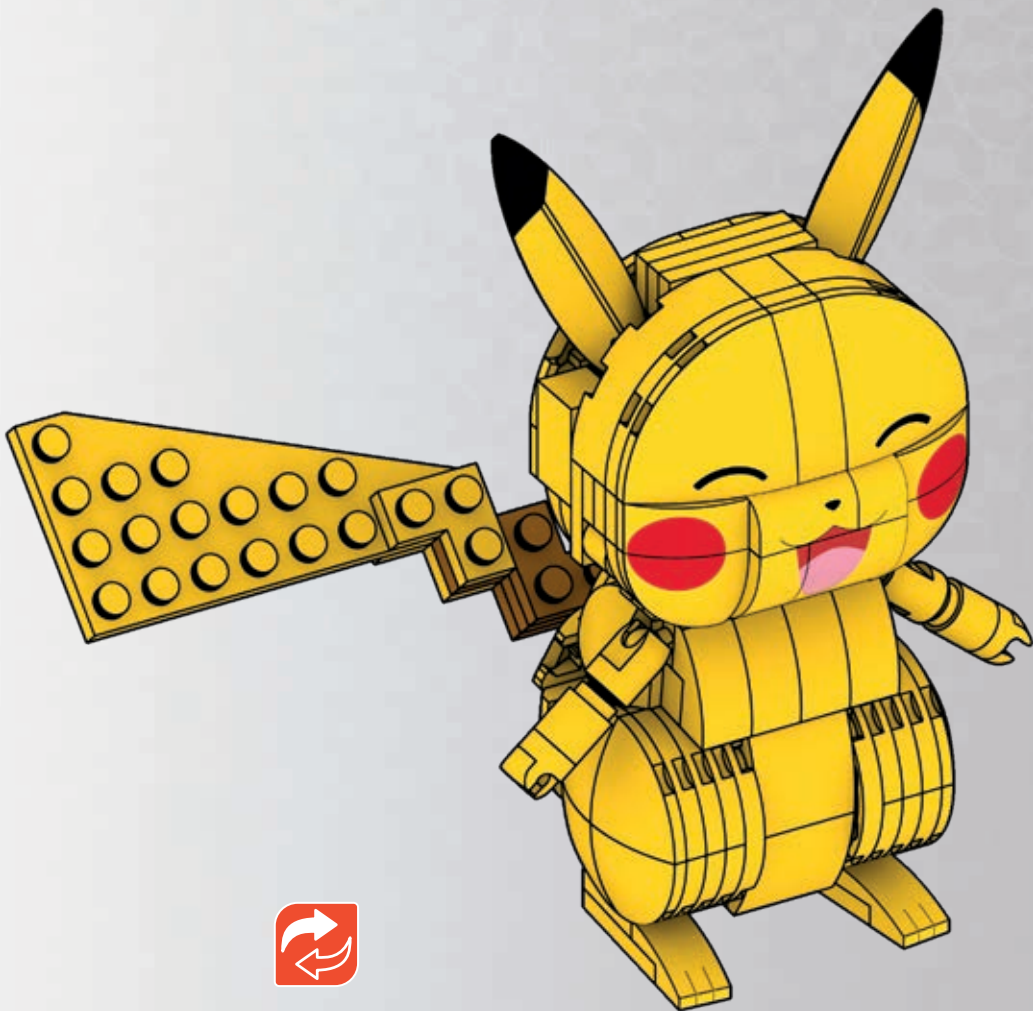





## **POSE IT! VARIEZ LES POSES !**

¡PÓSALO! / VOCÊ PODE POSAR!  
LÄSST SICH IN COOLE POSEN  
BRINGEN! / МЕНЯЙ ПОЗЫ!



3x  
AM07223BYE



2x  
AM03328BLG



5x  
AM03328BYE



2x  
AM79377BYE



2x  
AM77574BLG



1x  
AS-GMD31-10



2x  
AM17003BYE



1x  
AM17003B



1x  
AM17003AMC



2x  
AM78297BYE



2x  
AM78275BYE



2x  
AM79487BYE



2x  
AM80144BYE



2x  
AM01086BYE



2x  
AM01312BYE



2x  
AM01140BYE



1x  
AM78296MY



2x  
AM19530BYE



10x  
AM09393BYE



1x  
AM09393BLG



6x  
AM16680BYE



3x  
AM16680BLG



2x  
AM79246BYE



1x  
AM74427BYE



1x  
AM74426BYE



2x  
AS-GMD31-11



1x  
AS-GMD31-09



2x  
AS-GMD31-14



1x  
AS-GMD31-02



1x  
AS-GMD31-04



4x  
AM17788BYE



2x  
AM01322BYE



5x  
AM09013BYE



1x  
AM18601AMC



1x  
AM18601B



1x  
AM73009BYE



1x  
AM73009AMC



1x  
AM73009B



1x  
AM78276MY



26x  
AM04322BYE



3x  
AM15484MY



16x  
AM15484BYE



2x  
AM74106BYE



4x  
AM03773BYE



4x  
AM01146BYE



1x  
AS-GMD31-15



1x  
AS-GMD31-01



1x  
AS-GMD31-03



2x  
AM80799BYE



10x  
AM76525BYE



1x  
AS-GMD31-12



1x  
AS-GMD31-13



1x  
AM79796BYE



1x  
AM79227BYE



1x  
AS-GMD31-08



1x  
AS-GMD31-07



4x  
AM72600BYE



1x  
AM01314BLG



1x  
AM80143BYE



4x  
AM03772BLG



4x  
AM03772BYE



2x  
AM17153BYE



2x  
AM80634BYE



4x  
AM07230BYE



2x  
AM17056BYE



2x  
AM73003BYE



1x  
AS-HNT94-02



1x  
AS-HNT94-01



2x  
AM19324BYE



**Missing pieces?  
Pièces manquantes?**  
¿Partes faltantes? • Perdeu peças?  
Fehlen Teile? • Не хватает деталей?

[support.megabrand.com](http://support.megabrand.com)

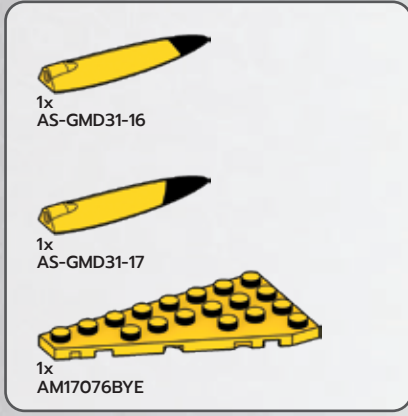
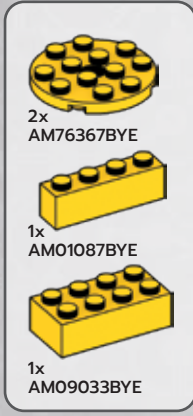

**WARNING:**  
CHOKING HAZARD – Small parts.  
Not for children under 3 years.

**ATTENTION :**  
DANGER D'ÉTOUFFEMENT –  
PETITS ÉLÉMENTS. NE  
CONVIENT PAS AUX ENFANTS  
DE MOINS DE 36 MOIS.

**ATENÇÃO:** NÃO INDICADO / NÃO RECOMENDÁVEL PARA CRIANÇAS MENORES DE 3 (TRÊS) ANOS POR CONTER PARTE(S) PEQUENA(S) QUE PODE(M) SER ENGOLIDA(S) OU ASPIRADA(S) PODENDO PROVOCAR ASFIXIA.

WARNING: Small parts, ATTENTION : PETITS ÉLÉMENTS, ACHTUNG: Kleine Teile, AVVERTENZA: Piccole parti, WAARSCHUWING: Kleine onderdelen, ADVERTENCIA: PELIGRO DE ATRAGANTAMIENTO. Juguete no recomendado para menores de 3 años, porque contiene piezas pequeñas que podrían provocar asfixia en caso de ser ingeridas o inhaladas por el/la niño/a, WARNING: Små delar, VAROITUS: Pieniä osia, ADVARSEL: Små dele, ADVARSEL: Små deler, OSTRZEŻENIE: Małe części, UPOZORNĚNÍ: Malé části, UPOZORNENIE: Malé časti, FIGYELMEZTETÉS: Kis alkatrészek, ПРЕДУПРЕЖДЕНИЕ: Мелкие детали, ΠΡΟΕΙΔΟΠΟΙΗΣΗ: Μικρά κομμάτια, UYARI: Küçük parçalar.

تحذير : قطع صغيرة.  
警告:  
のどにつまる危険 小さな部品が含まれています 3歳以下の子供には与えないで下さい。

**警告! 不适合3岁以下儿童使用。内含小零件。**

Mattel Europa B.V., Gondel 1, 1186 MJ Amstelveen, Nederland. Mattel U.K. Limited, The Porter Building, 1 Brunel Way, Slough SL1 1FQ, UK. Mattel France, Parc de la Cerisaie, 1/3/5 allée des Fleurs, 94260 Fresnes Cedex. N° Cristal 0969 36 99 99 (Numéro non surtaxé) ou www.lesjouetsmattel.fr Mattel Belgium N.V. De Kleetlaan 4, 1831 Machelen (Diegem) Belgium. Deutschland : Mattel GmbH, Solmsstraße 83, D-60486 Frankfurt am Main. Schweiz: Mattel AG, Kirchstrasse 24, CH-3097 Liebefeld. Österreich: Mattel Ges.m.b.H., Campus 21, Liebermannstraße A01 404, A- 2345 Brunn/Gebrige. Mattel Italy Srl, Via Turati 4, 20121 Milano, Italy. Servizio assistenza clienti: Customers.vitalia@mattel.com - Numero verde 800 11 37 11. Mattel España, S. A. Aribau 200 pl. 9, 08036 Barcelona. cservice.pain@mattel.com Tel.: +34 933 06 79 00 http://www.service.mattel.com/es. Hong Kong: Kids Kingdom Limited, Room 1908-9, Gala Place, 56 Dundas Street, Mongkok, Kowloon, Hong Kong. Customer Care line: (852)2782-0766. Taiwan: Chickabiddy Company Limited, 5/F, No. 186, Section 4, Nanjing East Road, Taipei 10595, Taiwan. Customer Care line: (02)2578-1188. Mainland China: Mattel Barbie (Shanghai) Trading Co., Ltd. Units 4701-4711, 47F, 2 Grand Gateway 3 Hong Qiao Road, Shanghai, 200030, P.R.C. Customer Care line: 400-819-8658. Diimport & Diedarkan Oleh: Mattel Continental Asia Sdn Bhd. Level 19, Tower 3, Avenue 7, No. 8 Jalan Kerinchi, Bangsar South, 59200 Kuala Lumpur, Malaysia. Mattel South Africa (PTY) LTD, Office 102 13, 30 Melrose Boulevard, Johannesburg 2196. Dystrybutor: Mattel Poland Sp. z o.o., Warsaw Trade Tower 34 p., ul. Chłodna 51, 00-867 Warszawa. Mattel Australia Pty. Ltd., 658 Church St., Richmond, Victoria, 3121. Consumer Advisory Service - 1300 135 312. Mattel AEBE, ΕΒΨάρου Μακαρίου 1, Κτηριο Κ-2, ΤΚ 17561, Παλαιό Φάληρο. Mattel Oyuncakçılık Tic. Ltd. Şti. İçerenköy Mah., Umut Sokak No: 10 - 12, Quick Tower kat:2 içkapı no:15 Ataşehir 34752, İstanbul, Türkiye. Tel: 0216 570 75 00. Импортер/Уполномоченная организация: ООО "МАТЕЛ" Российская Федерация, 105120 Москва, 2-й Сыромиятинский переулок, 1; +7 495 287 79 39. Mattel Czech Republic s.r.o., The Forum, Václavské nám. 19, 11000 Praha1, Mattel, 333 Continental Boulevard, El Segundo, CA 90245, USA. Consumer Services: 1-800-465-MEGA (6342). Mattel Canada Inc., Mississauga, Ontario L5R 3W2. Consumer Services: You may call us free at /composez sans frais le 1-800-524-8697. Importado y distribuido por Mattel de México, S.A. de C.V., Miguel de Cervantes Saavedra No. 193, Pisos 10 y 11, Col. Granada, Alcala Miguel Hidalgo, CP. 11520, México, Ciudad de México. R.F.C. MME-920701-NB3. Tels.: 59-05-51-00 Ext. 5206 6 01-800-463-59-89. Mattel Chile, S.A., Avenida Amerigo Vesputio 501-B, Quilicura, Santiago. Tel.: 1230-020-6213. Servicio al consumidor Venezuela: Tel.: 0-800-100-9123. Mattel Argentina, S.A., Av. Libertador 1000, Piso 11 - Oficinas 109 y 111, Vicente López - Prov. Buenos Aires. Tel.: 0800-666-3373. Mattel Colombia, S.A., Calle 123#-07 P5 Bogotá. Tel.: 01800-710-2069. Mattel Perú, S.A., Av. Juan de Arona # 151, Centro Empresarial Juan de Arona, Torre C, Piso 7, Oficina 704, San José, Lima 27, Perú. RUC: 20425853865. Reg. Importador: 02350-12-JUE-DIGESA. Tel.: 0800-54744. E-mail Latinoamérica: servicio.clientes@mattel.com. Mattel do Brasil Ltda.- CNPJ : 54.558.002/0001-20 - Rua Verbo Divino, 1488 - 2ª. Andar - 04719-904 - Chácara Santo Antônio - São Paulo - SP - Brasil. Serviço de Atendimento ao Consumidor: fone 0800 575 0780. E-mail: sac.matteldobrazil@mattel.com

MEGA™

POKÉMON™



GVK83



GKY96



GYH00



HDL84

Set(s) sold separately and subject to availability. / Ensemble(s) vendu(s) séparément. Certains produits peuvent ne pas être commercialisés.

Se vende(n) por separado y está(n) sujeto(s) a disponibilidad. / Conjunto(s) vendido(s) em separado e sujeito(s) a disponibilidade. / Set in vendita separatamente, secondo disponibilità. / Das/Die Set(s) sind separat erhältlich. / Zestaw(y) sprzedawany(e) oddzielnie w zależności od dostępności. / Set(s) apart verkrijgbaar en afhankelijk van beschikbaarheid. / Набор(-ы) продаются отдельно, при наличии. / Sæt sælges separat og så længe lager haves. / Seten säljs separat så länge lagret räcker. / Settet/settene selges separat så langt lageret rekker. / Pakkaus/pakkaukset myydään erikseen, saatavuus voi vaihdella. / To(a) σε πωλούνται ξεχωριστά και ανάλογα με τη διαθεσιμότητα. / A készlet(ek) külön kapható(k), az elérhetőség változhat.

セット商品は別売りになります。在庫状況は別途ご確認をお願いします。

تباع المجموعة أو المجموعات على حدة وتخضع لتوافرها.  
每套单独发售。按供货情况决定。

© D781,964, D797,203, D834,105

1186 MJ, 1, NL

Mattel Canada Inc. Mississauga, Ontario L5R 3W2.

MADE IN CHINA. FABRIQUÉ EN CHINE. FABRICADO NA CHINA. HECHO EN CHINA.

ИЗГОТОВЛЕНО В КИТАЕ. ÇIN'DE ÜRETİLMİŞTİR. صنع في الصين

©2023 MEGA Brands &™ MEGA Brands.

Printed in China / Imprimé en Chine

AD-HNT94-01



FR  
DONNEZ  
OU  
RECYCLEZ

ASSOCIATION

MAGASIN

DÉCHÈTERIE

Adresses sur quefairedemesdechets.fr





MEGA™

POKÉMON™

5

9

5 → 9



HNT94-02

EEVEE  
ÉVOLI

EVOLI



## Build Construisez

Construye | Constrói  
Вауен | Стройте



## Share Partagez

Comparte | Partilha  
Teilen | Делитесь

Device not included | Appareil non inclus  
Dispositivo no incluído | Dispositivo não incluído  
Gerät nicht enthalten | Устройство не входит в комплект



[megaunboxed.com](https://megaunboxed.com)



1



1x



2x



1x



2



2x



3



2x

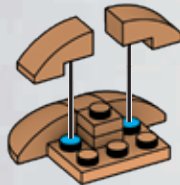

4



1x



2x

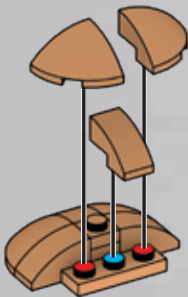

1



2

5



1x



1x



1x



1



2

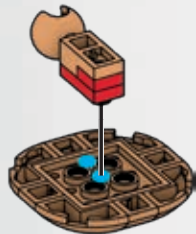



6



2x



1x

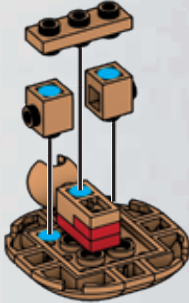

7



2x

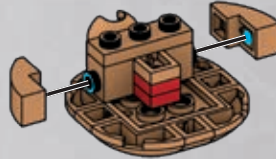

8



2x

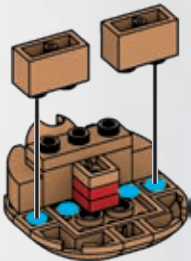

9



2x



1x

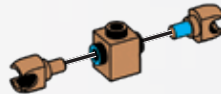

1



2

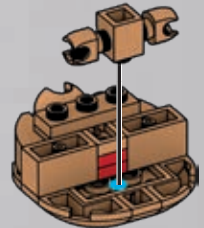

10



2x

1x

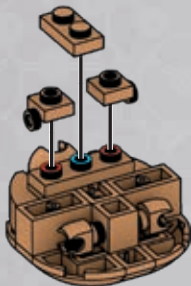

11



2x

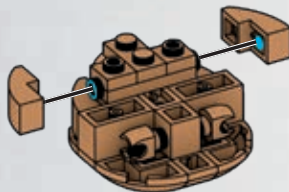

12



3x

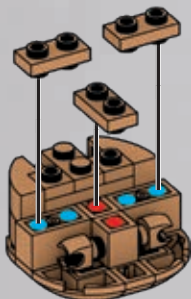

13



2x



1x



1x

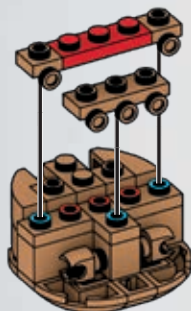

14



1x

1x



15



1x

1x



1

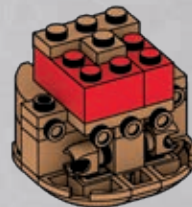

2

16



1x

1x



1x

17



1x

18



3x

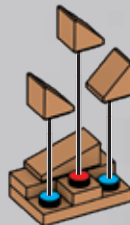
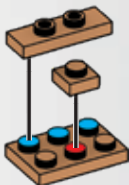

1



2

19

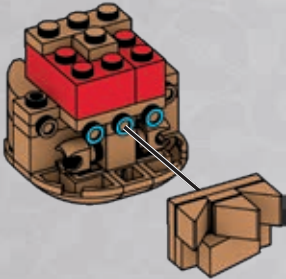

20

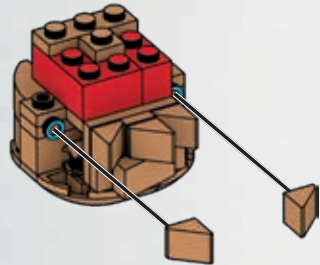

21

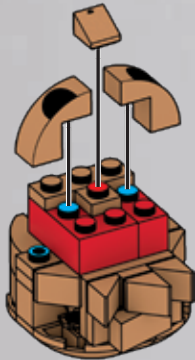

22

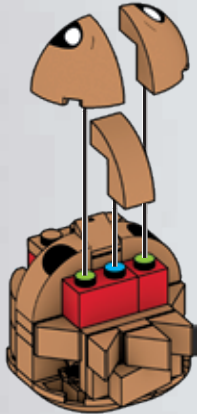

23



1x

1x

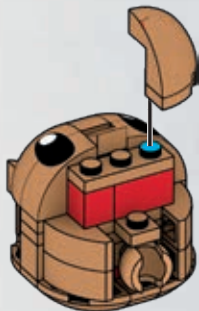
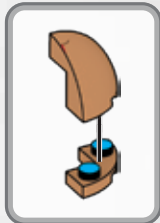

24



1x

1x

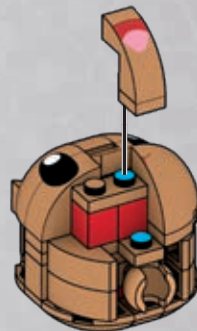
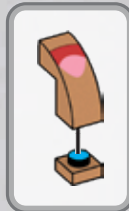

25



1x

1x

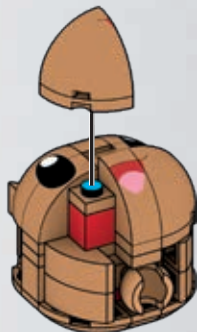
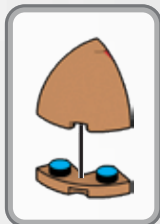

1



2

26



2x

2x

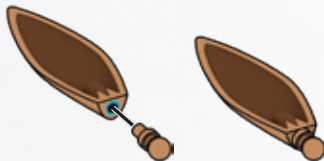

1

x2



2

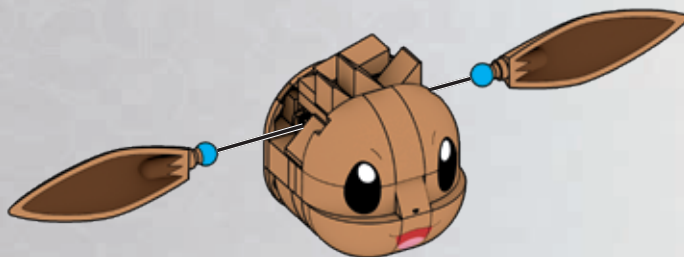

1

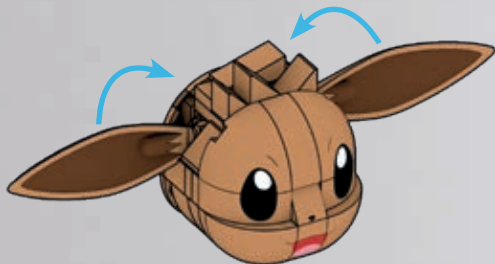

2

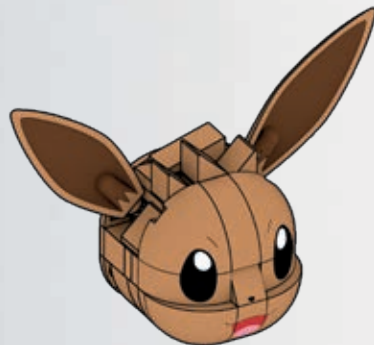

3



**27**

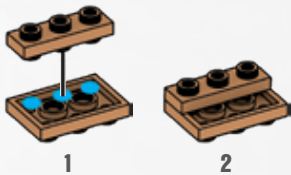

**28**

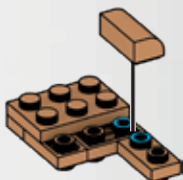

**29**

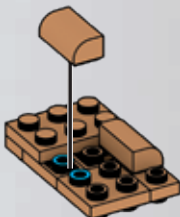

**30**

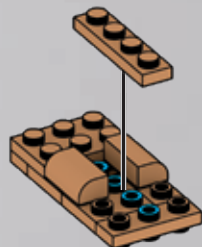



31



2x

1x

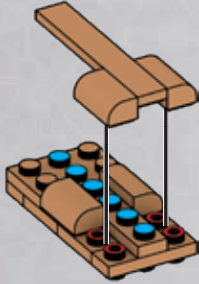

1

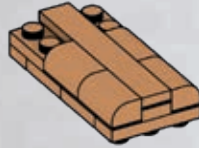

2

32



2x

2x

1x

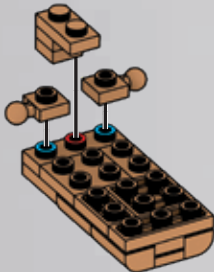

33



1x

1x

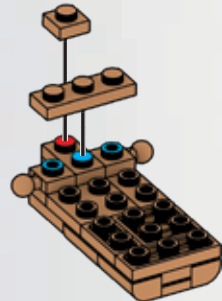

34



2x

1x

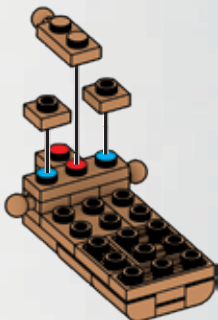

35



1x

1x

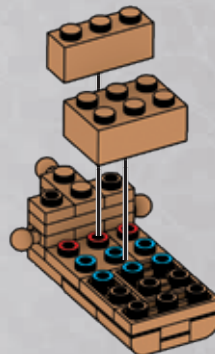

36



1x

2x

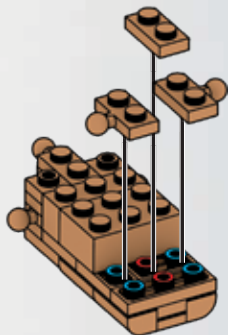

37



2x

1x

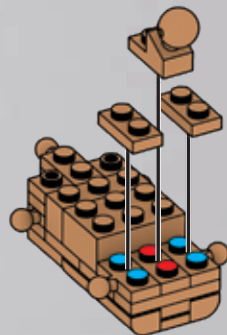

38



1x

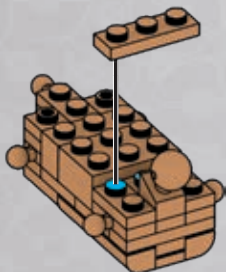

39



1x



1x

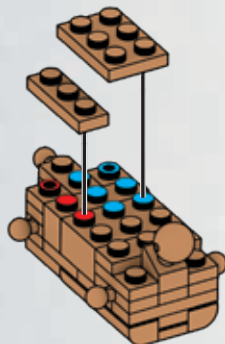

40



1x



1x



1x

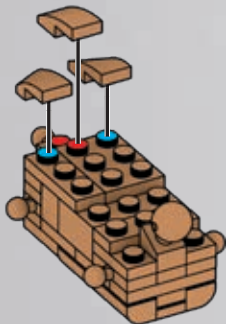

41



3x



1x

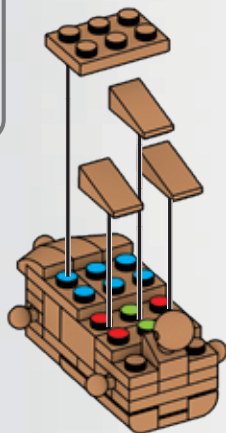

42



1x

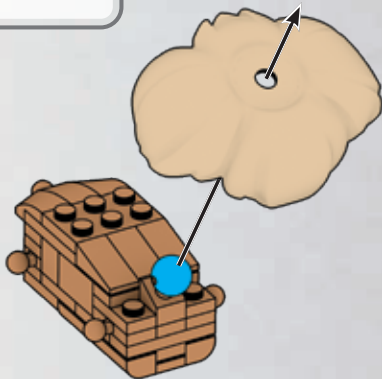

1



2

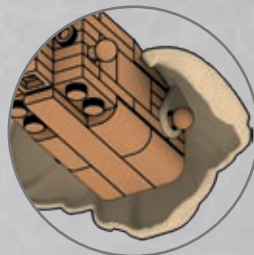

43



2x

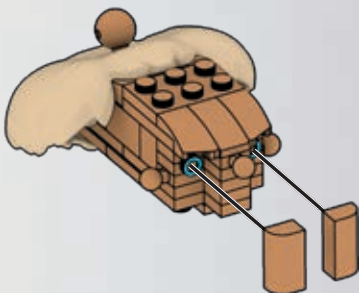

1

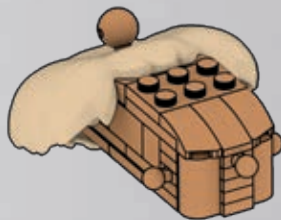

2

44



1



2

45



4x

4x

4x



1

2

x4

46



1x

1x

1x

1x



47



2x

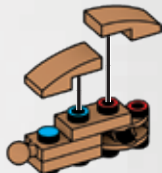

1



2

48



1x

1x

1x

1x

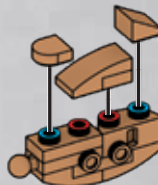

1



2

49

50



1x

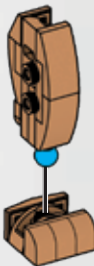

45

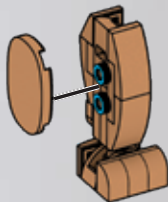

1

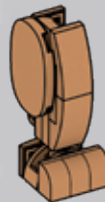

2

51



1x

1x

1x

1x



52



2x



1



2

53



1x

1x

1x

1x

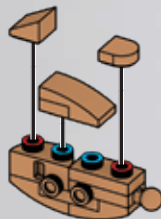
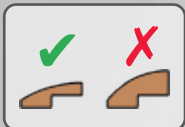

1



2



54

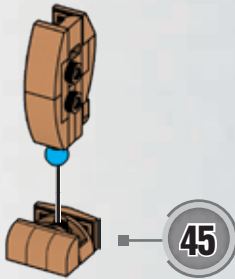

55



1x

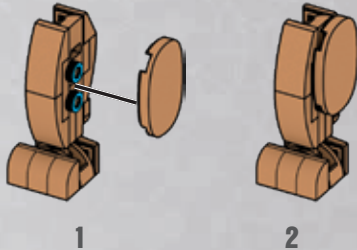

56

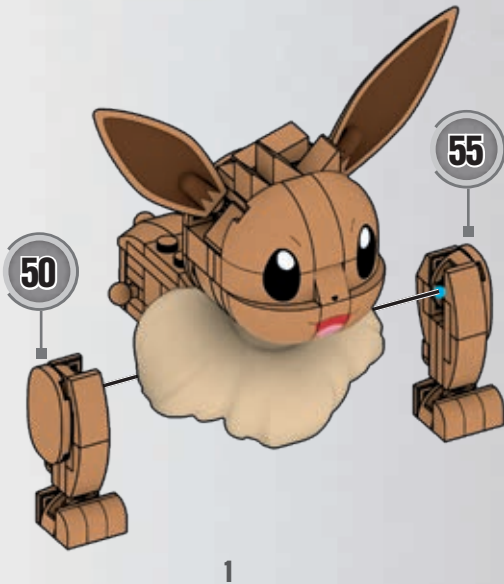

57



1x

1x

1x

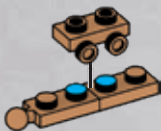

58



1x

1x



1



2

59



1x

1x

1x

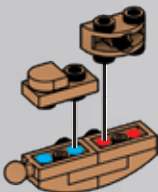

60



1x

1x



1



2

61

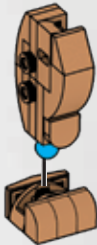

45

62



1x

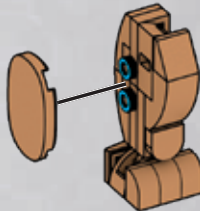

1



2

63



1x



1x



1x

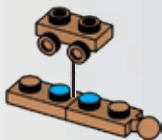

64



1x



1x

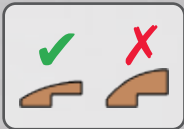

1



2

65



1x



1x



1x

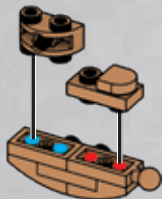

66



1x



1x



1



2

67

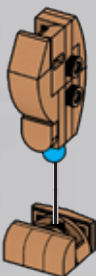

45

68



1x

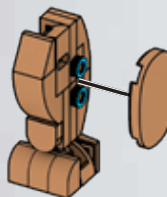

1



2

69

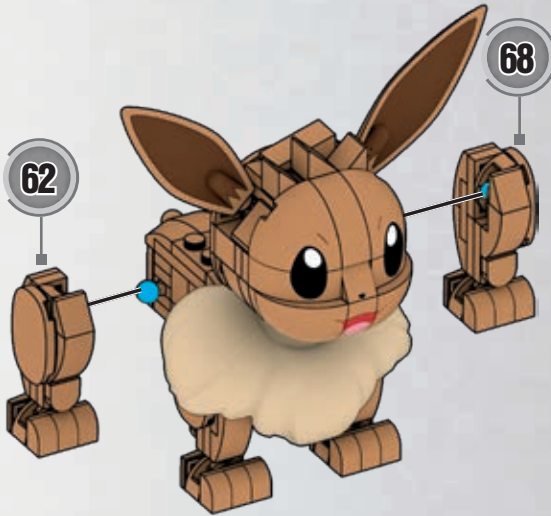

1

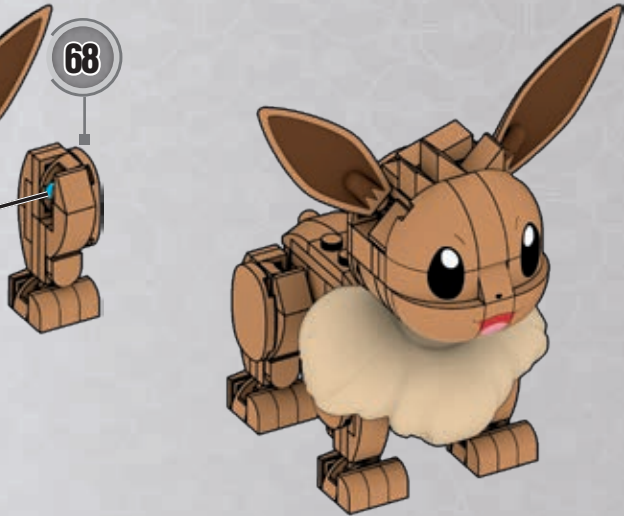

2



70



1x



2x



1x



1x



71



1x



1



2

72



1x



1x

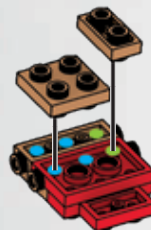

73



1x



1x

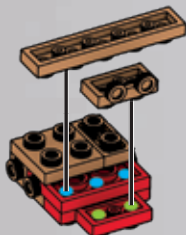

74



2x



1x

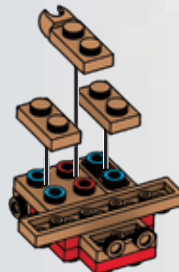

75



2x

1x

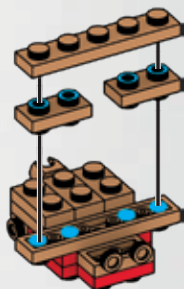

76



1x

1x



77



1x

1x

1x

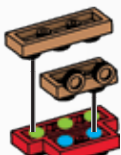

1



2

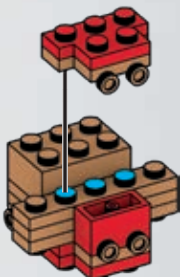

78



1x

1x

1x





79



2x



2x



80



2x

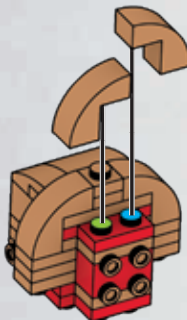

1

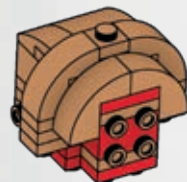

2

81



1x



1x



1x

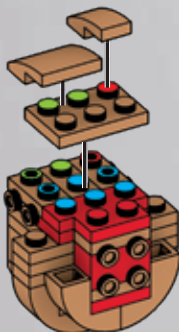

82



1x



1x



1x

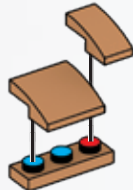

1



2

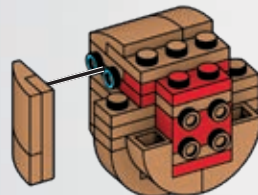

83

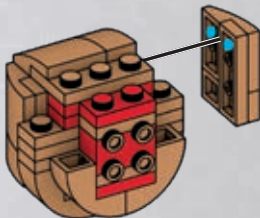
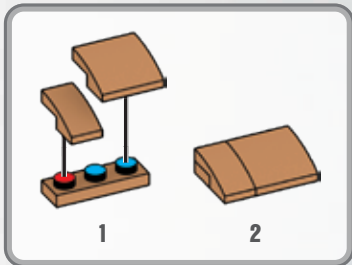
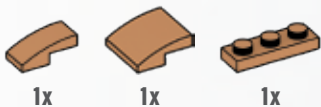

84

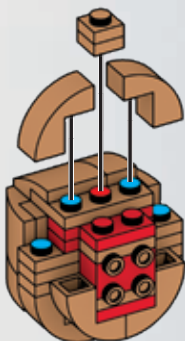
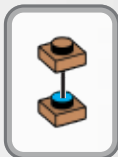

85

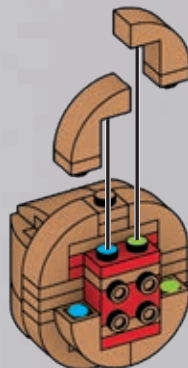
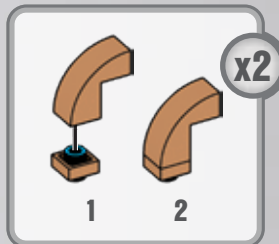

86

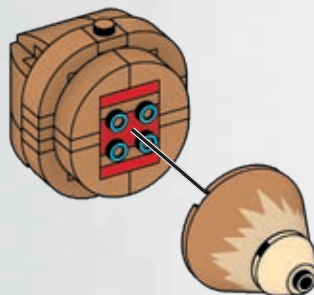
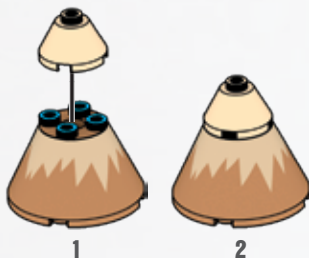

87

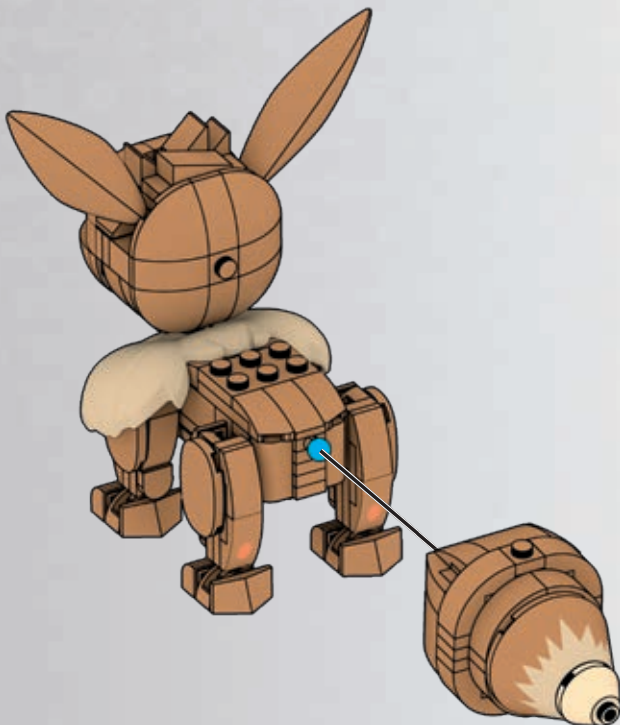

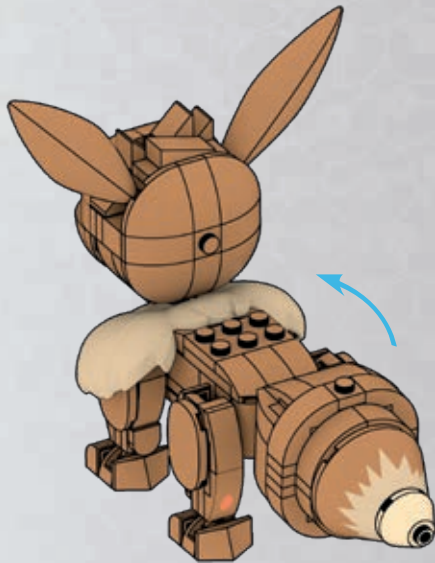

1

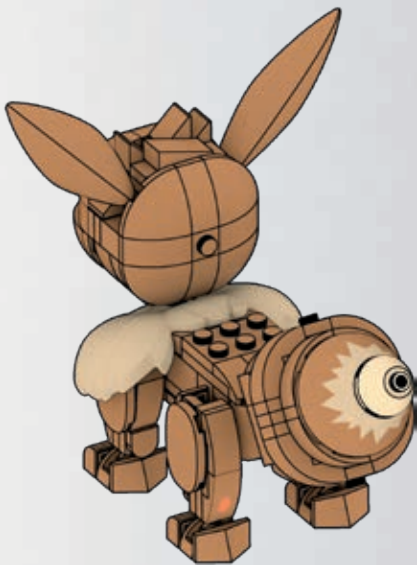

2



3



## **POSE IT! VARIEZ LES POSES !**

¡PÓSALO! / VOCÊ PODE POSAR!  
LÄSST SICH IN COOLE POSEN  
BRINGEN! / МЕНЯЙ ПОЗЫ!



4x  
AM76204VL



14x  
AM03328VL



1x  
AM03328AMC



2x  
AM81529VL



6x  
AM77574VL



2x  
AM79377VL



4x  
AM17127VL



1x  
AS-HDL84-05



5x  
AM15258VL



2x  
AM78291VL



2x  
AM78296VL

2x  
AM07629VL



1x  
AM17507VL



4x  
AM17131VL



10x  
AM09393VL



1x  
AM09393AMC



12x  
AM16680VL



2x  
AM78397VL



8x  
AM76467VL



1x  
AM74427VL



1x  
AM74426VL



13x  
AM78486VL

2x  
AS-HDL84-12



4x  
AM17128VL



8x  
AM78281VL



1x  
AM81421VL



6x  
AM03017VL



4x  
AS-HDL84-09



10x  
AM17788VL



5x  
AM78276VL



1x  
AM80765VL



1x  
AM01404BTN

2x  
AM09013VL



1x  
AM09013AMC



2x  
AM04322VL



3x  
AM01146VL



1x  
AS-HDL84-04



9x  
AM16682VL



1x  
AS-HNT94-04



1x  
AS-HDL84-02



4x  
AM74106VL

3x  
AM80143VL



1x  
AM81260VL



1x  
AM16384VL



1x  
AM16384AMC



4x  
AM80799VL



1x  
AS-HDL84-01



1x  
AS-HDL84-03



1x  
AS-HNT94-05



1x  
AS-HNT94-03

4x  
AM80727VL



1x  
AM74298VL



8x  
AM01314VL



1x  
AM01314AMC



2x  
AM77465AMC



6x  
AM03772VL



1x  
AM03772AMC



2x  
AM03873VL



1x  
AM03873AMC



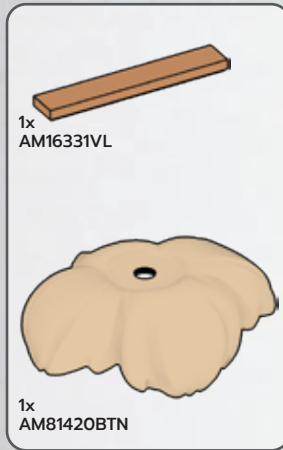
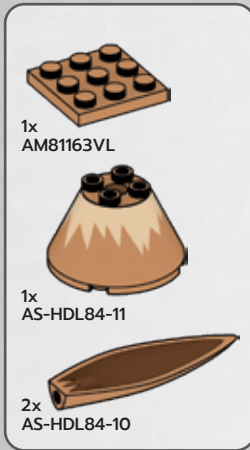

**Missing pieces?**  
**Pièces manquantes?**  
 ¿Partes faltantes? • Perdeu peças?  
 Fehlen Teile? • Не хватает деталей?

[support.megabrand.com](http://support.megabrand.com)

**⚠ WARNING:**  
**CHOKING HAZARD – Small parts.**  
 Not for children under 3 years.

**ATTENTION :**  
**DANGER D'ÉTOUFFEMENT –**  
**PETITS ÉLÉMENTS. NE**  
**CONVIENT PAS AUX ENFANTS**  
**DE MOINS DE 36 MOIS.**

**ATENÇÃO:** NÃO INDICADO / NÃO RECOMENDÁVEL PARA CRIANÇAS MENORES DE 3 (TRÊS) ANOS POR CONTER PARTE(S) PEQUENA(S) QUE PODE(M) SER ENGOLIDA(S) OU ASPIRADA(S) PODENDO PROVOCAR ASFIXIA.

**WARNING: Small parts, ATTENTION : PETITS ÉLÉMENTS, ACHTUNG:**  
 Kleine Teile, **AVVERTENZA: Piccole parti, WAARSCHUWING: Kleine**  
 onderdelen, **ADVERTENCIA: PELIGRO DE ATRAGANTAMIENTO. Juguete**  
 no recomendado para menores de 3 años, porque contiene piezas  
 pequeñas que podrían provocar asfixia en caso de ser ingeridas o inhaladas por  
 el/la niño/a, **WARNING: Små delar, VAROITUS: Pieniä osia, ADVARSEL: Små dele,**  
**ADVARSEL: Små deler, OSTRZEŻENIE: Małe części, UPOZORNĚNÍ: Malé části,**  
**UPOZORNENIE: Malé časti, FIGYELMEZTETÉS: Kis alkatrészek, ПРЕДУПРЕЖДЕНИЕ:**  
 Мелкие детали, **ΠΡΟΕΙΔΟΠΟΙΗΣΗ: Μικρά κομμάτια, UYARI: Küçük parçalar.**  
 تحذير : قطع صغيرة.

**警告:**  
 のどにつまる危険 小さな部品が含まれています 3歳以下の子供には与えないで下さい。

**警告! 不适合3岁以下儿童使用。内含小零件。**

Mattel Europa B.V., Gondel 1, 1186 MJ Amstelveen, Nederland. Mattel U.K. Limited, The Porter Building, 1 Brunel Way, Slough SL1 1FQ, UK. Mattel France, Parc de la Cerisaie, 1/3/5 allée des Fleurs, 94260 Fresnes Cedex. N° Cristal 0969 36 99 99 (Numéro non surtaxé) ou [www.lesjouetsmattel.fr](http://www.lesjouetsmattel.fr) Mattel Belgium N.V. De Kleetlaan 4, 1831 Machelen (Diegem) Belgium. Deutschland : Mattel GmbH, Solmsstraße 83, D-60486 Frankfurt am Main. Schweiz: Mattel AG, Kirchstrasse 24, CH-3071 Liebefeld. Österreich: Mattel Ges.m.b.H., Campus 21, Liebermannstraße A01 404, A- 2345 Brunn/Gebrige. Mattel Italy Srl, Via Turati 4, 20121 Milano, Italy. Servizio assistenza clienti: [Customers.vitalia@mattel.com](mailto:Customers.vitalia@mattel.com) - Numero verde 800 11 37 11. Mattel España, S. A. Aribau 200 pl. 9, 08036 Barcelona. [cservice.pain@mattel.com](mailto:cservice.pain@mattel.com) Tel.: +34 933 06 79 00 <http://www.service.mattel.com/es>. Hong Kong: Kids Kingdom Limited, Room 1908-9, Gala Place, 56 Dundas Street, Mongkok, Kowloon, Hong Kong. Customer Care line: (852)2782-0766. Taiwan: Chickabiddy Company Limited, 5/F, No. 186, Section 4, Nanjing East Road, Taipei 10595, Taiwan. Customer Care line: (02)2578-1188. Mainland China: Mattel Barbie (Shanghai) Trading Co., Ltd. Units 4701-4711, 47F, 2 Grand Gateway 3 Hong Qiao Road, Shanghai, 200030, P.R.C. Customer Care line: 400-819-8658. Diimport & Diedarkan Oleh: Mattel Continental Asia Sdn Bhd. Level 19, Tower 3, Avenue 7, No. 8 Jalan Kerinchi, Bangsar South, 59200 Kuala Lumpur, Malaysia. Mattel South Africa (PTY) LTD, Office 102 13, 30 Melrose Boulevard, Johannesburg 2196. Dystrybutor: Mattel Poland Sp. z o.o., Warsaw Trade Tower 34 p., ul. Chłodna 51, 00-867 Warszawa. Mattel Australia Pty. Ltd., 658 Church St., Richmond, Victoria, 3121. Consumer Advisory Service - 1300 135 312. Mattel AEBE, Еввързу Макарвиу 1, Ктрио К-2, ТК 17561, Плавио Фалгуро. Mattel Oyuncakçılık Tic. Ltd. Şti. İçerençik Mah., Umut Sokak No: 10 - 12, Quick Tower kat:2 içkapı no:15 Ataşehir 34752, İstanbul, Türkiye. Tel: 0216 570 75 00. Импортёр/Уполномоченная организация: ООО "МАТЕЛ" Российская Федерация, 105120 Москва, 2-й Сыромиятинский переулок, 1; +7 495 287 79 39. Mattel Czech Republic s.r.o., The Forum, Václavské nám. 19, 11000 Praha1. Mattel, 333 Continental Boulevard, El Segundo, CA 90245, USA. Consumer Services: 1-800-465-MEGA (6342). Mattel Canada Inc., Mississauga, Ontario L5R 3W2. Consumer Services: You may call us free at / composez sans frais le 1-800-524-8697. Importado y distribuido por Mattel de México, S.A. de C.V., Miguel de Cervantes Saavedra No. 193, Pisos 10 y 11, Col. Granada, Alcatla Miguel Hidalgo, CP. 11520, México, Ciudad de México. R.F.C. MME-920701-NB3. Tels.: 59-05-51-00 Ext. 5206 ó 01-800-463-59-89. Mattel Chile, S.A., Avenida Americo Vesputico 501-B, Quilicura, Santiago. Tel: 1230-020-6213. Servicio al consumidor Venezuela: Tel: 0-800-100-9123. Mattel Argentina, S.A., Av. Libertador 1000, Piso 11 - Oficinas 109 y 111, Vicente López - Prov. Buenos Aires. Tel: 0800-666-3373. Mattel Colombia, S.A., Calle 123#7-07 P5 Bogotá. Tel: 01800-710-2069. Mattel Perú, S.A., Av. Juan de Arona # 151, Centro Empresarial Juan de Arona, Torre C, Piso 7, Oficina 704, San Isidro, Lima 27, Perú. RUC: 20425853865. Reg. Importador: 02350-12-JUE-DIGESA. Tel: 0800-54744. E-mail Latinoamérica: [servicio.clientes@mattel.com](mailto:servicio.clientes@mattel.com). Mattel do Brasil Ltda.- CNPJ : 54.558.002/0001-20 - Rua Verbo Divino, 1488 - 2ª. Andar - 04719-904 - Chácara Santo Antônio - São Paulo - SP - Brasil. Serviço de Atendimento ao Consumidor: fone 0800 575 0780. E-mail: [sac.matteldobrazil@mattel.com](mailto:sac.matteldobrazil@mattel.com)





# POKÉMON



GVK83



GKY96



GYH00



GMD31

Set(s) sold separately and subject to availability. / Ensemble(s) vendu(s) séparément. Certains produits peuvent ne pas être commercialisés.

Se vende(n) por separado y está(n) sujeto(s) a disponibilidad. / Conjunto(s) vendido(s) em separado e sujeito(s) a disponibilidade. / Set in vendita separatamente, secondo disponibilità. / Das/Die Set(s) sind separat erhältlich. / Zestaw(y) sprzedawany(e) oddzielnie w zależności od dostępności. / Set(s) apart verkrijgbaar en afhankelijk van beschikbaarheid. / Набор(-ы) продаются отдельно, при наличии. / Sæt sælges separat og så længe lager haves. / Seten säljs separat så länge lagret räcker. / Settet/settene selges separat så langt lageret rekker. / Pakkaus/pakkausset myydään erikseen, saatavuus voi vaihdella. / Το(α) σετ πωλούνται ξεχωριστά και ανάλογα με τη διαθεσιμότητα. / Setler ayrı olarak satılır ve stoklarla sınırlıdır. / Set (sety) se prodává (prodávaji) samostatně dle aktuální nabídky. / Súprava/-y sa predáva(jú) samostatne a podľa dostupnosti. / A készlet(ek) külön kapható(k), az elérhetőség változhat.

セット商品は別売りになります。在庫状況は別途ご確認をお願いします。

تباع المجموعة أو المجموعات على حدة وتخضع لتوافرها.

每套单独发售，按供货情况决定。

© D781,964, D797,203,  
D799,607, D834,105

1186 MJ, 1, NL

Mattel Canada Inc. Mississauga, Ontario L5R 3W2.

MADE IN CHINA. FABRIQUÉ EN CHINE. FABRICADO NA CHINA. HECHO EN CHINA.

ИЗГОТОВЛЕНО В КИТАЕ. ÇIN'DE ÜRETİLMİŞTİR. صنع في الصين

©2023 MEGA Brands &™ MEGA Brands.

Printed in China / Imprimé en Chine

AD-HNT94-02



Adresses sur [quefairedemesdechets.fr](http://quefairedemesdechets.fr)



MEGA™

POKÉMON™

10

13

10 → 13



HNT94-03

PIPLUP  
TIPOUF

PLINFA



## Build Construisez

Construye | Constrói  
Bauen | Стройте

## Share Partagez

Comparte | Partilha  
Teilen | Делитесь

Device not included | Appareil non inclus  
Dispositivo no incluído | Dispositivo não incluído  
Gerät nicht enthalten | Устройство не входит в комплект



[megaunboxed.com](http://megaunboxed.com)



1



2x



2x

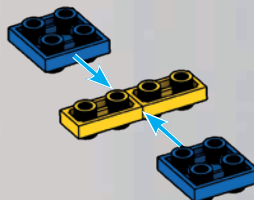

1

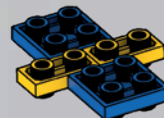

2

2

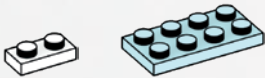

1x

1x



3



4x

2x

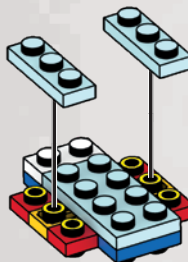

4



2x

2x

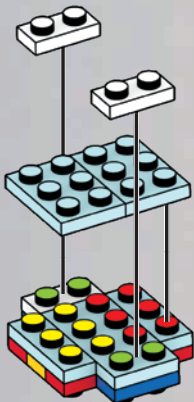

5



1x

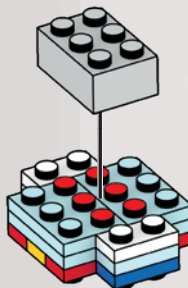

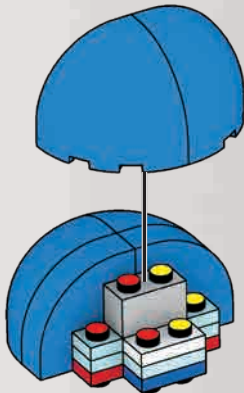
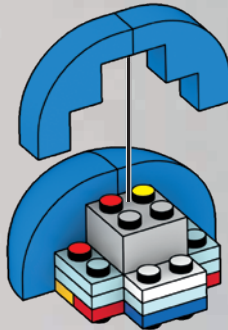
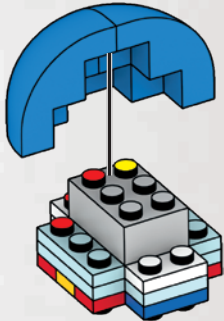
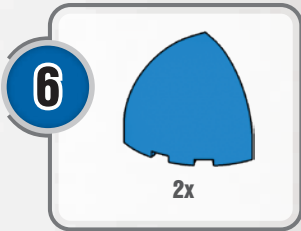

1

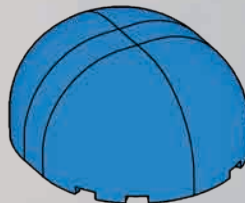

2

9



2x



1x

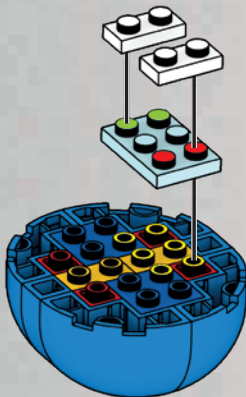

10



1x



1x

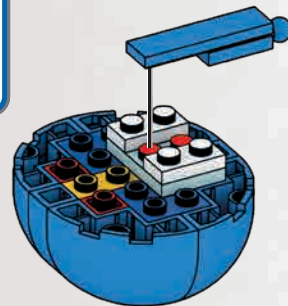
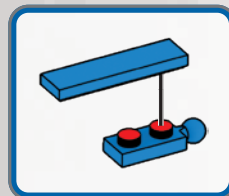

11



1x



1x

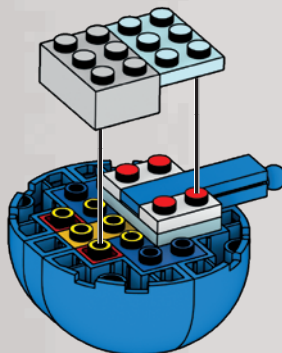



12



2x



1x

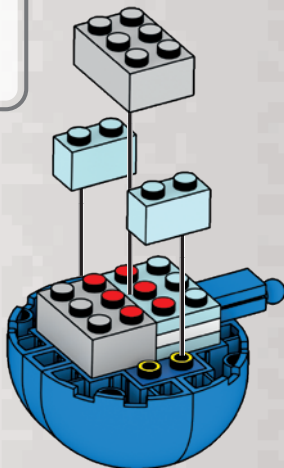

1

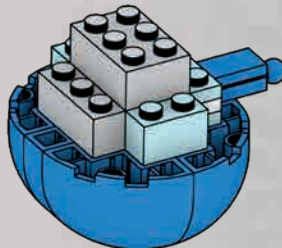

2

13



1x



2x

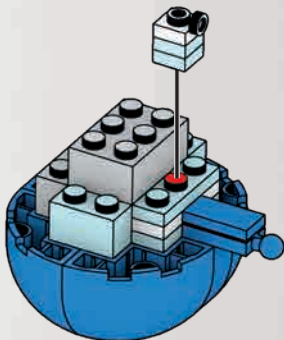
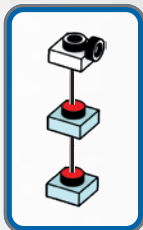

14



1x



1x

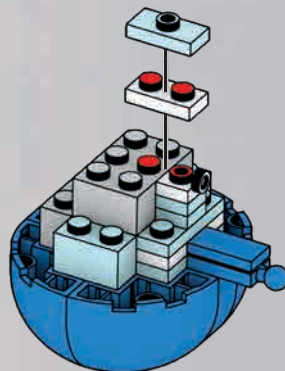



15



1x



1x



1



2

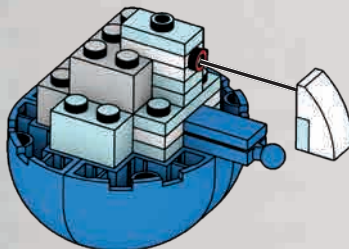

1

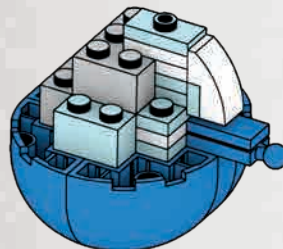

2

16



1x



1x

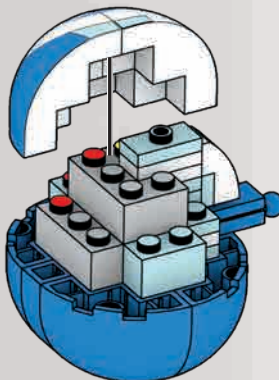

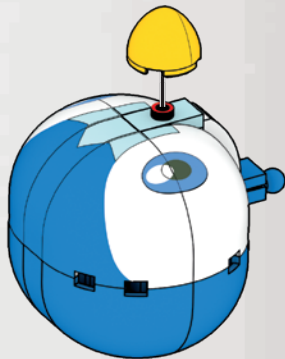
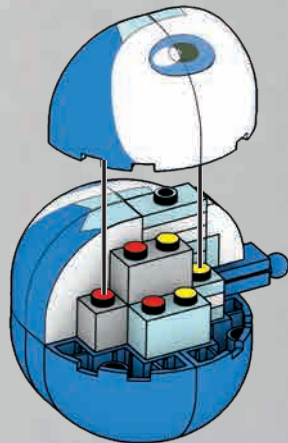
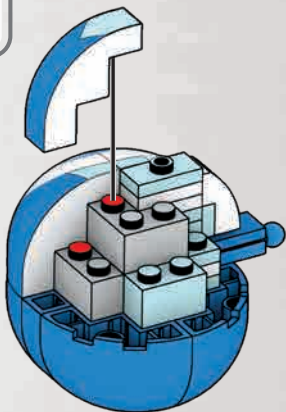

1

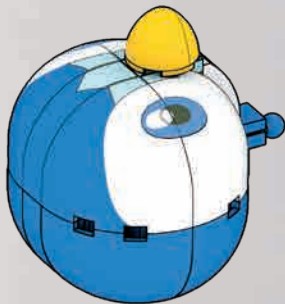

2





20



1x



2x



1x

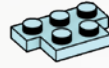

1x

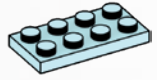

1x

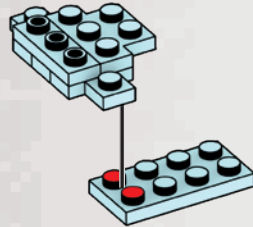
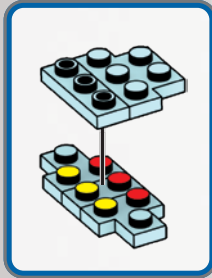

21



1x

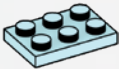

1x

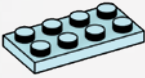

1x

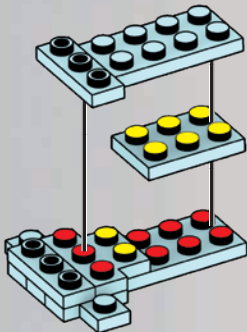

22



2x

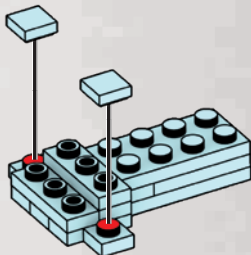

1

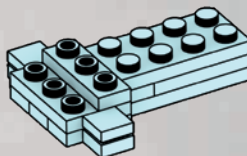

2

23



1x



1x

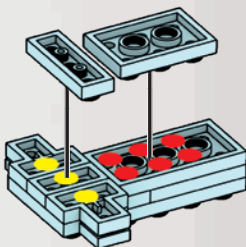

24



1x



1x

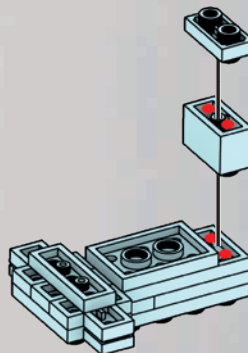

25

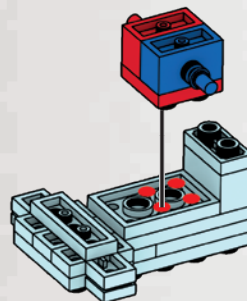
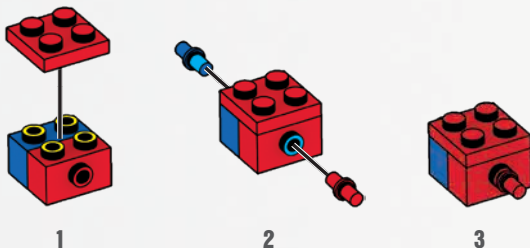

26

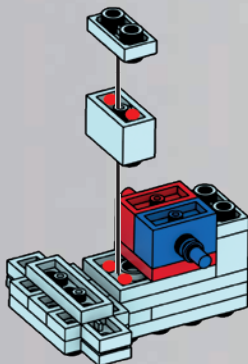

27

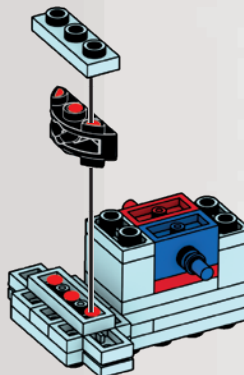

28



3x

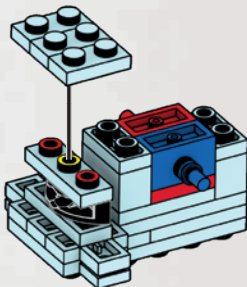

29



1x



1x

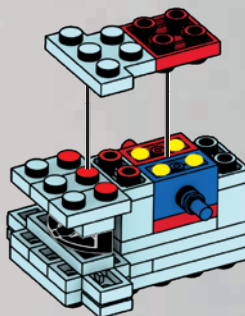

30



1x



1x

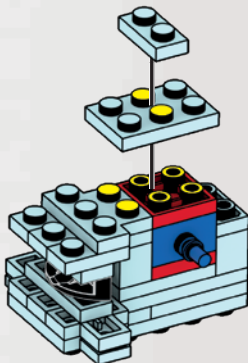

31



2x

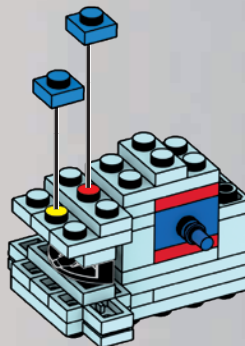

32

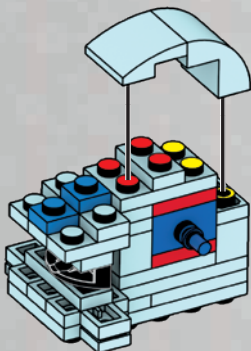
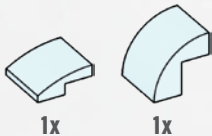

33

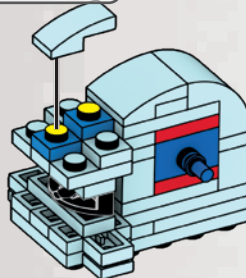
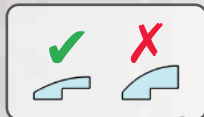

34

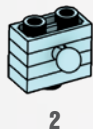
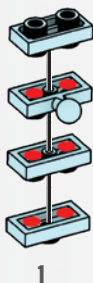
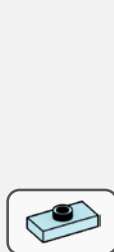
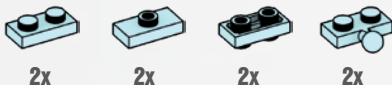

x2

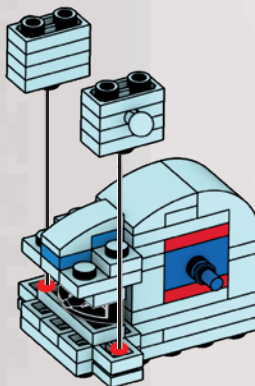



35



2x



2x



1



2

x2

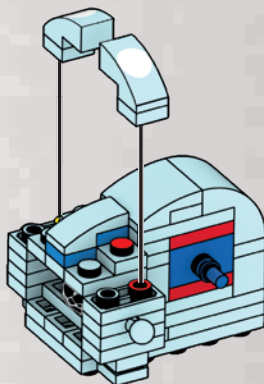

36



2x

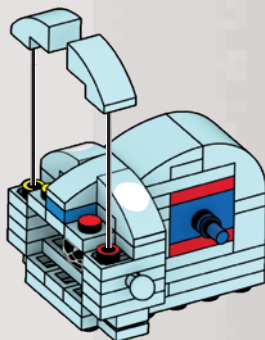

1

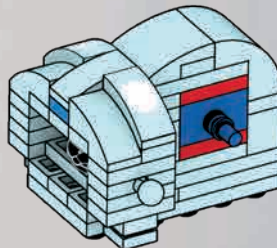

2

**37**

2x

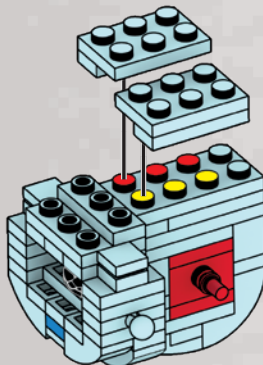
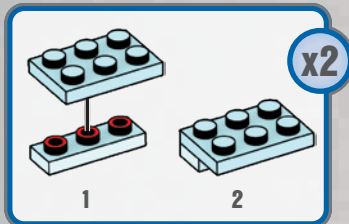

2x

**38**

2x

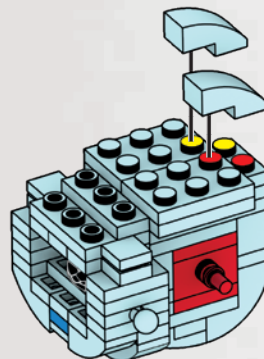
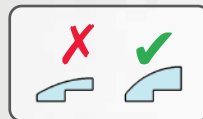
**39**

2x

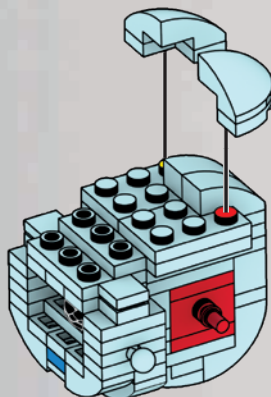
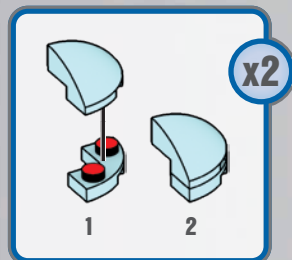

2x

**40**

1x



1x

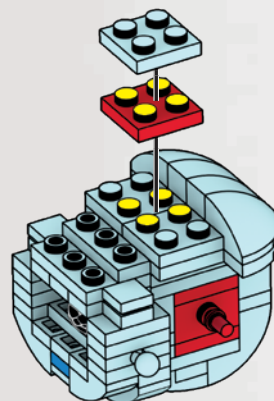

41



2x



2x

X

✓



42



2x

x2



1



2

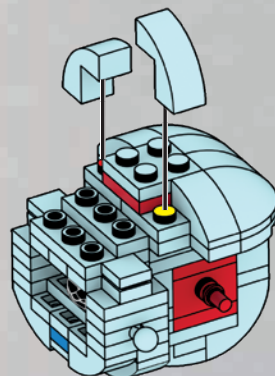
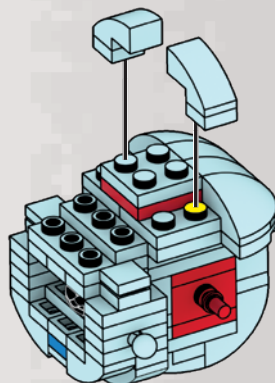

43



1x



2x

X

✓

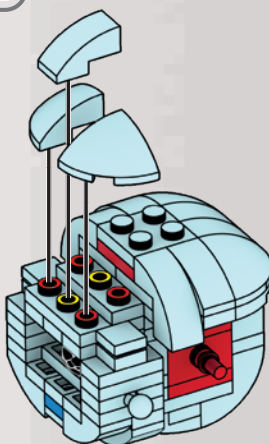

1

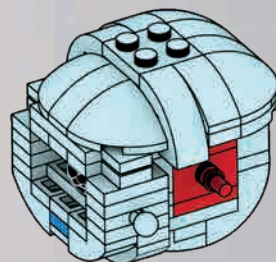

2

44

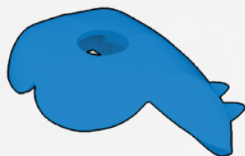

1x

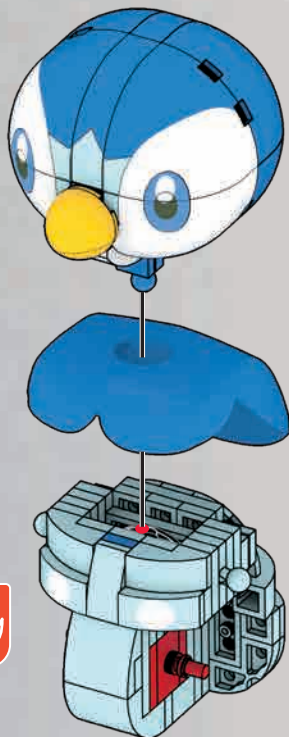

1



2



45



1x

1x



46



3x



47

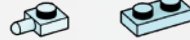

1x

1x

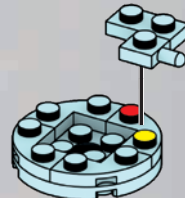

48



3x

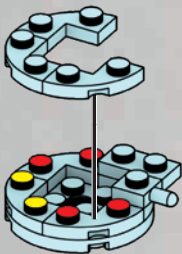

1

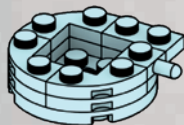

2

49



1x



2x

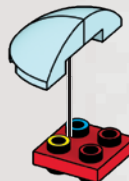

50



2x

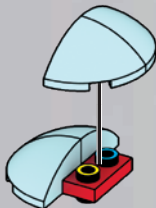

1



2

51



1x



1



2

52

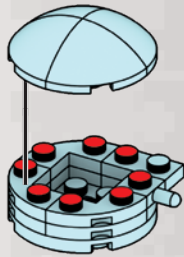

1

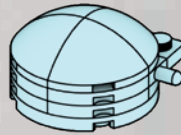

2

53



1x



1x



1x

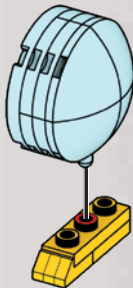
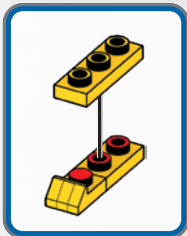

1

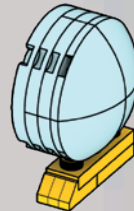

2



54



1x

1x



55



3x



56

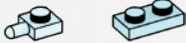

1x

1x



57



3x

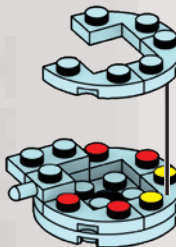

58



1x



2x



59



2x



1



2

60



1x



1



2

61

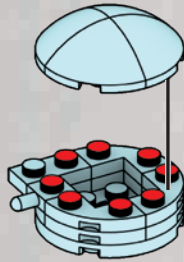

1

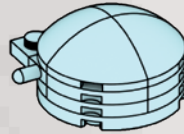

2

62



1x



1x



1x

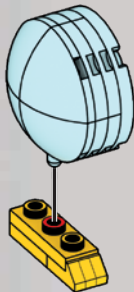
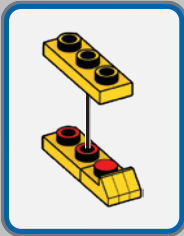

1

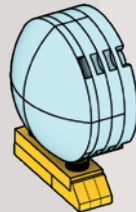

2

63

62

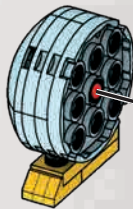

53

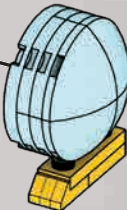

1



2

64



2x



2x



2x



65



2x



2x

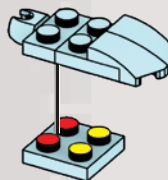

66



2x

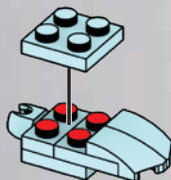

1



2

x2

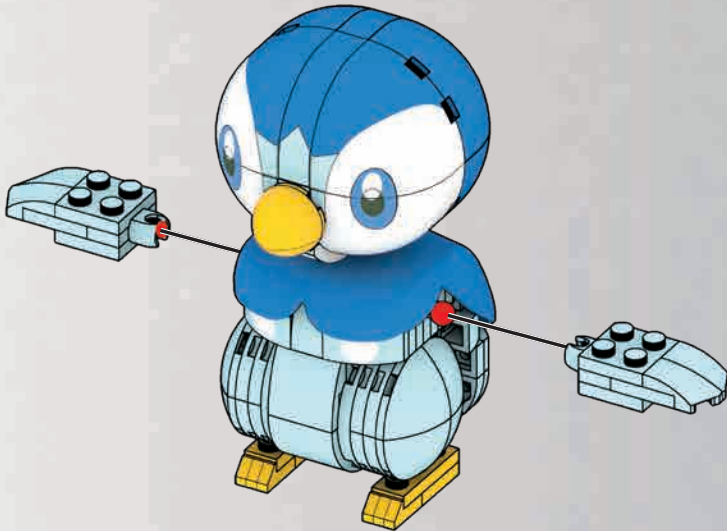

1

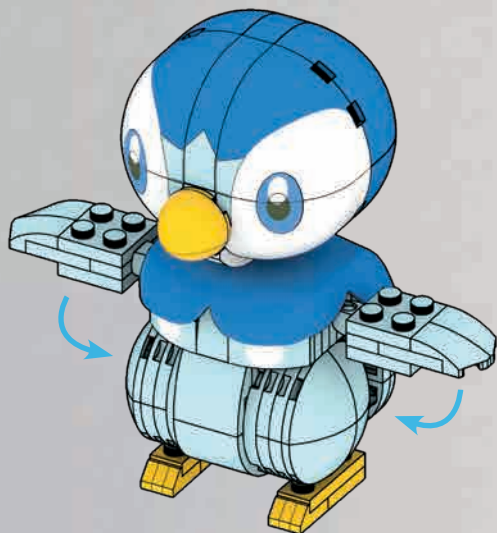

2



3





# POSE IT! VARIEZ LES POSES !

¡PÓSALO! / VOCÊ PODE POSAR!  
LÄSST SICH IN COOLE POSEN  
BRINGEN! / МЕНЯЙ ПОЗЫ!



1x  
AM17003AMC



1x  
AM17003B



2x  
AM07223AWG



7x  
AM03328AWG



2x  
AM03328HP



4x  
AM81529AMC



1x  
AM79590E



2x  
AM01140AWG



2x  
AS-HNT94-13



3x  
AM07590AWG



9x  
AM09393AWG



6x  
AM09393E



4x  
AM16680AWG



2x  
AM16680BYE



2x  
AM79246BYE



2x  
AM78397AWG



2x  
AM78277AWG



2x  
AM74427AWG



2x  
AM74426AWG



1x  
AM78486AWG



1x  
AS-HNT94-06



1x  
AM17788E



7x  
AM17788AWG



2x  
AS-HNT94-12



2x  
AM16682AWG



2x  
AM18293AWG



1x  
AM78276HP



4x  
AM09013AWG



1x  
AM18601B



1x  
AM18601AMC



1x  
AM73009AMC



1x  
AM73009B



7x  
AM03773AWG



2x  
AM03773AMC



3x  
AM01146B



2x  
AM01146AMC



16x  
AM04322AWG



1x  
AM74106AWG



12x  
AM80799AWG



1x  
AM08481AWG



1x  
AM78282F



2x  
AM72257HP



1x  
AS-HNT94-09



6x  
AM72600AWG



2x  
AM72600BYE



2x  
AM01314AWG



2x  
AM77465AWG



9x  
AM03772AWG



3x  
AM03873BLG



1x  
AM09838HP



3x  
AM09493AWG



2x  
AM76367AWG



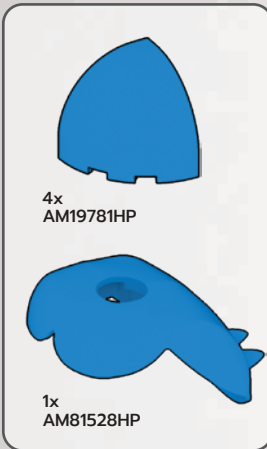
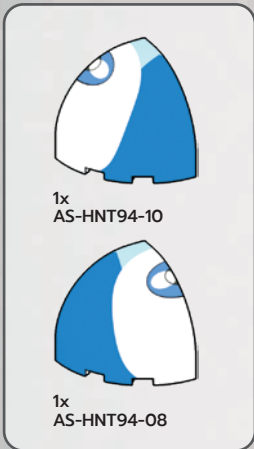
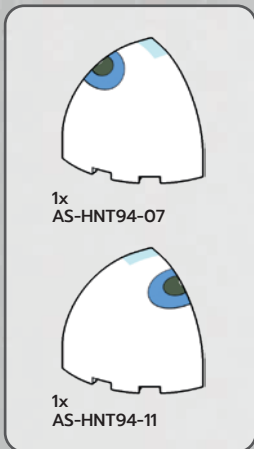

**Missing pieces?**  
**Pièces manquantes?**  
 ¿Partes faltantes? • Perdeu peças?  
 Fehlen Teile? • Не хватает деталей?

[support.megabrand.com](http://support.megabrand.com)

**⚠ WARNING:**  
**CHOKING HAZARD** – Small parts.  
 Not for children under 3 years.

**ATTENTION:**  
**DANGER D'ÉTOUFFEMENT –**  
**PETITS ÉLÉMENTS. NE**  
**CONVIENT PAS AUX ENFANTS**  
**DE MOINS DE 36 MOIS.**

**ATENÇÃO:** NÃO INDICADO / NÃO RECOMENDÁVEL PARA CRIANÇAS MENORES DE 3 (TRÊS) ANOS POR CONTER PARTE(S) PEQUENA(S) QUE PODE(M) SER ENGOLIDA(S) OU ASPIRADA(S) PODENDO PROVOCAR ASFIXIA.

**WARNING: Small parts, ATTENTION : PETITS ÉLÉMENTS, ACHTUNG:**  
 Kleine Teile, **AVVERTENZA: Piccole parti, WAARSCHUWING: Kleine**  
 onderdelen, **ADVERTENCIA: PELIGRO DE ATRAGANTAMIENTO. Juguete**  
 no recomendado para menores de 3 años, porque contiene piezas  
 pequeñas que podrían provocar asfixia en caso de ser ingeridas o inhaladas por  
 el/la niño/a, **WARNING: Små delar, VAROITUS: Pieniä osia, ADVARSEL: Små dele,**  
**ADVARSEL: Små deler, OSTRZEŻENIE: Małe części, UPOZORNĚNÍ: Malé části,**  
**UPOZORNENIE: Malé časti, FIGYELMEZTETÉS: Kis alkatrészek, ПРЕДУПРЕЖДЕНИЕ:**  
 Мелкие детали, **ΠΡΟΕΙΔΟΠΟΙΗΣΗ: Μικρά κομμάτια, UYARI: Küçük parçalar.**



**تحذير: قطع صغيرة.**

**警告:**  
 のどにつまる危険 小さな部品が含まれています 3歳以下の子供には与えないで下さい。

**警告! 不适合3岁以下儿童使用。内含小零件。**

Mattel Europa B.V., Gondel 1, 1186 MJ Amstelveen, Nederland. Mattel U.K. Limited, The Porter Building, 1 Brunel Way, Slough SL1 1FQ, UK. Mattel France, Parc de la Cerisaie, 1/3/5 allée des Fleurs, 94260 Fresnes Cedex. N° Cristal 0969 36 99 99 (Numéro non surtaxé) ou [www.lesjouetsmattel.fr](http://www.lesjouetsmattel.fr) Mattel Belgium N.V. De Kleetlaan 4, 1831 Machelen (Diegem) Belgium. Deutschland : Mattel GmbH, Solmsstraße 83, D-60486 Frankfurt am Main. Schweiz: Mattel AG, Kirchstrasse 24, CH-3071 Liebefeld. Österreich: Mattel Ges.m.b.H., Campus 21, Liebermannstraße A01 404, A- 2345 Brunn/Gebrige. Mattel Italy Srl, Via Turati 4, 20121 Milano, Italy. Servizio assistenza clienti: [Customers.rv.italia@mattel.com](mailto:Customers.rv.italia@mattel.com) - Numero verde 800 11 37 11. Mattel España, S. A. Aribau 200 pl. 9, 08036 Barcelona. [cservice.spain@mattel.com](mailto:cservice.spain@mattel.com) Tel.: +34 933 06 79 00 <http://www.service.mattel.com/es>. Hong Kong: Kids Kingdom Limited, Room 1908-9, Gala Place, 56 Dundas Street, Mongkok, Kowloon, Hong Kong. Customer Care line: (852)2782-0766. Taiwan: Chickabiddy Company Limited, 5/F, No. 186, Section 4, Nanjing East Road, Taipei 10595, Taiwan. Customer Care line: (02)2578-1188. Mainland China: Mattel Barbie (Shanghai) Trading Co., Ltd. Units 4701-4711, 47F, 2 Grand Gateway 3 Hong Qiao Road, Shanghai, 200030, P.R.C. Customer Care line: 400-819-8658. Diimport & Diedarkan Oleh: Mattel Continental Asia Sdn Bhd. Level 19, Tower 3, Avenue 7, No. 8 Jalan Kerinchi, Bangsar South, 59200 Kuala Lumpur, Malaysia. Mattel South Africa (PTY) LTD, Office 102 13, 30 Melrose Boulevard, Johannesburg 2196. Dystrybutor: Mattel Poland Sp. z o.o., Warsaw Trade Tower 34 p., ul. Chłodna 51, 00-867 Warszawa. Mattel Australia Pty. Ltd., 658 Church St., Richmond, Victoria, 3121. Consumer Advisory Service - 1300 135 312. Mattel AEBE, Еввързуо Макардиу 1, Ктрпо К-2, ТК 17561, Платоа Фалгур, Mattel Oyuncakçılık Tic. Ltd. Şti. İçerenköy Mah., Umut Sokak No: 10 - 12, Quick Tower kat:2 içkapı no:15 Ataşehir 34752, İstanbul, Türkiye. Tel: 0216 570 75 00. Импортёр/Уполномоченная организация: ООО "МАТТЕЛ" Российская Федерация, 105120 Москва, 2-й Сыромиятинский переулок, 1; +7 495 287 79 39. Mattel Czech Republic s.r.o., The Forum, Václavské nám. 19, 11000 Praha1, Mattel, 333 Continental Boulevard, El Segundo, CA 90245, USA. Consumer Services: 1-800-465-MEGA (6342). Mattel Canada Inc., Mississauga, Ontario L5R 3W2. Consumer Services: You may call us free at / composez sans frais le 1-800-524-8697. Importado y distribuido por Mattel de México, S.A. de C.V., Miguel de Cervantes Saavedra No. 193, Pisos 10 y 11, Col. Granada, Alcaidía Miguel Hidalgo, CP. 11520, México, Ciudad de México. R.F.C. MME-920701-NB3. Tels.: 59-05-51-00 Ext. 5206 ó 01-800-463-59-89. Mattel Chile, S.A., Avenida Amerigo Vesputcio 501-B, Quilicura, Santiago. Tel.: 1230-020-6213. Servicio al consumidor Venezuela: Tel.: 0-800-100-9123. Mattel Argentina, S.A., Av. Libertador 1000, Piso 11 - Oficinas 109 y 111, Vicente López - Prov. Buenos Aires. Tel.: 0800-666-3373. Mattel Colombia, S.A., Calle 123#7-07 P5 Bogotá. Tel.: 01800-710-2069. Mattel Perú, S.A., Av. Juan de Arona # 151, Centro Empresarial Juan de Arona, Torre C, Piso 7, Oficina 704, San Isidro, Lima 27, Perú. RUC: 20425853865. Reg. Importador: 02350-12-JUE-DIGESA. Tel.: 0800-54744. E-mail Latinoamérica: [servicio.clientes@mattel.com](mailto:servicio.clientes@mattel.com). Mattel do Brasil Ltda. - CNPJ : 54.558.002/0001-20 - Rua Verbo Divino, 1488 - 2ª. Andar - 04719-904 - Chácara Santo Antônio - São Paulo - SP - Brasil. Serviço de Atendimento ao Consumidor: fone 0800 575 0780. E-mail: [sac.matteldobrazil@mattel.com](mailto:sac.matteldobrazil@mattel.com)



# POKÉMON



GVK83



GKY96



GYH00



HDL84

Set(s) sold separately and subject to availability. / Ensemble(s) vendu(s) séparément. Certains produits peuvent ne pas être commercialisés.

Se vende(n) por separado y está(n) sujeto(s) a disponibilidad. / Conjunto(s) vendido(s) em separado e sujeito(s) à disponibilidade. / Set in vendita separatamente, secondo disponibilità. / Das/Die Set(s) sind separat erhältlich. / Zestaw(y) sprzedawany(e) oddzielnie w zależności od dostępności. / Set(s) apart verkrijgbaar en afhankelijk van beschikbaarheid. / Набор(-ы) продаются отдельно, при наличии. / Sæt sælges separat og så længe lager haves. / Seten säljs separat så länge lagret räcker. / Settet/settene selges separat så langt lageret rekker. / Pakkaus/pakkaukset myydään erikseen, saatavuus voi vaihdella. / Το(α) σετ πωλούνται ξεχωριστά και ανάλογα με τη διαθεσιμότητα. / Setler ayrı olarak satılır ve stoklarla sınırlıdır. / Set (sety) se prodává (prodávaji) samostatně dle aktuální nabídky. / Súprava/-y sa predáva(jú) samostatne a podľa dostupnosti. / A készlet(ek) külön kapható(k), az elérhetőség változhat. / セット商品は別売りになります。在庫状況は別途ご確認ください。 / 確認をお願いします。 /

تباع المجموعة أو المجموعات على حدة وتخضع لتوافرها.  
每套单独发售，按供货情况决定。

© D799,608, D841,101, D834,105

1186 MJ, 1, NL

Mattel Canada Inc. Mississauga, Ontario L5R 3W2.  
MADE IN CHINA. FABRIQUÉ EN CHINE. FABRICADO NA CHINA. HECHO EN CHINA.  
ИЗГОТОВЛЕНО В КИТАЕ. ÇIN'DE ÜRETİLMİŞTİR. صنع في الصين

©2023 MEGA Brands &™ MEGA Brands.  
Printed in China / Imprimé en Chine

AD-HNT94-03



Adresses sur [quefairedemesdechets.fr](http://quefairedemesdechets.fr)

