



POKÉMON™



BUILD & SHOW PIKACHU  
EVOLUTION TRIO  
CRÉER ET MONTRER LES TROIS  
ÉVOLUTIONS DE PIKACHU

CONSTRUYE Y MUESTRA - EVOLUCIONES DE PIKACHU / CONSTRUA E MOSTRE - EVOLUÇÕES DO PIKACHU

GYH06



# Build Construisez

Construye | Constrói  
Bauen | Стройте



# Share | Partagez

Comparte | Partilha  
Teilen | Делитесь



# Easy-to-follow steps!

# Des instructions faciles à suivre !

¡Pasos fáciles de seguir!  
Passos fáceis de seguir!  
Einfache Schritte!  
Простые действия!



Devices not included | Appareils non inclus | Dispositivos no incluido | Dispositivos  
não incluídos | Geräte nicht enthalten | Устройства не входят в комплект



[megaunboxed.com](https://megaunboxed.com)

1



2x



2x

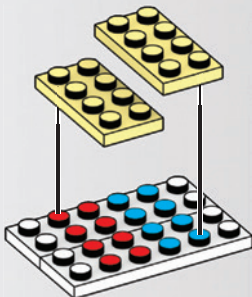

2



4x

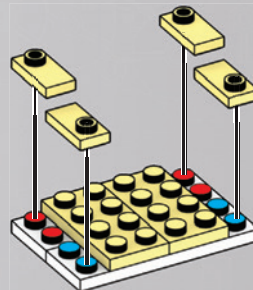

3



4x

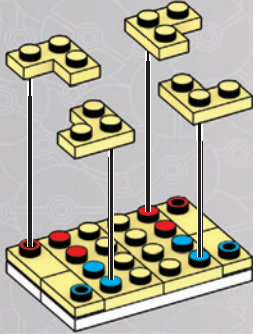

4



4x

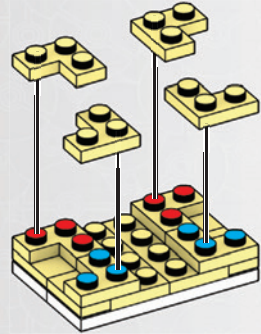

5



2x



1x

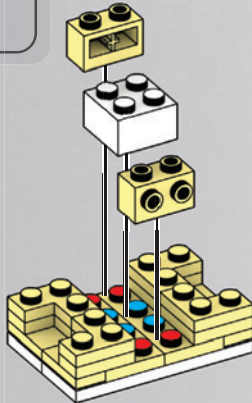

6



4x



2x

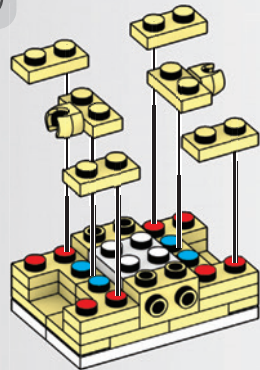



7



4x

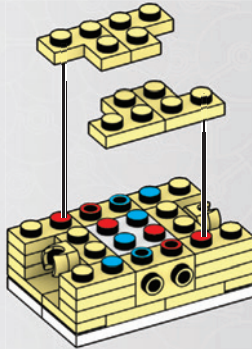

8



4x

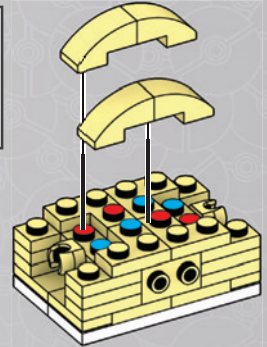
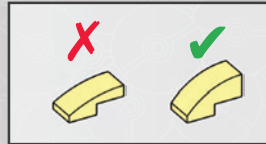

9



4x

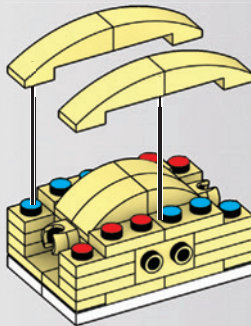

1

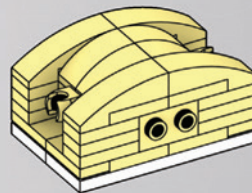

2



10



4x



2x

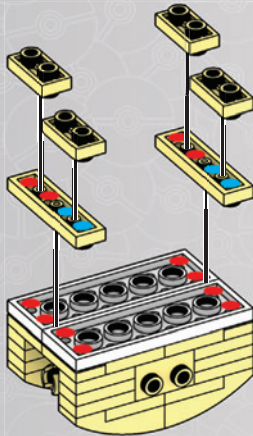

1

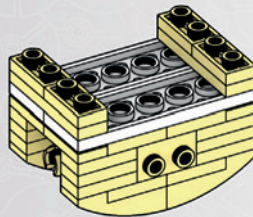

2

11



4x



2x

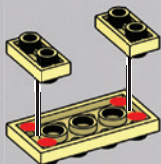

1

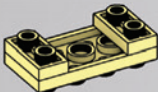

2

x2

12



1x

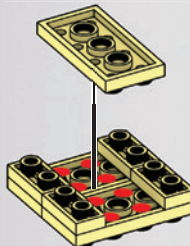

1

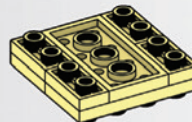

2

13



2x

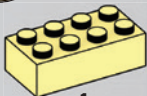

1x

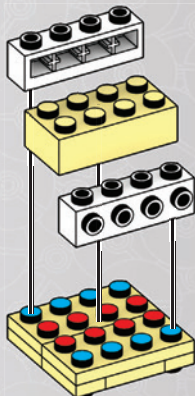

14

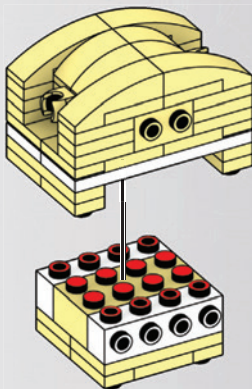

1

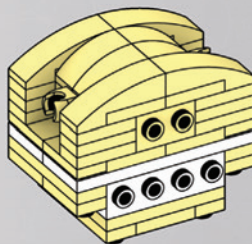

2

15



4x



8x

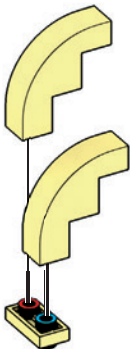

1



2

x4

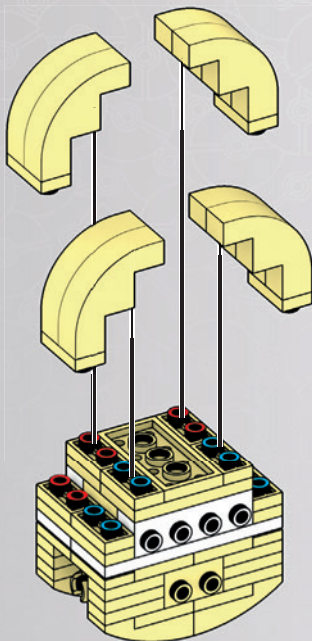

1

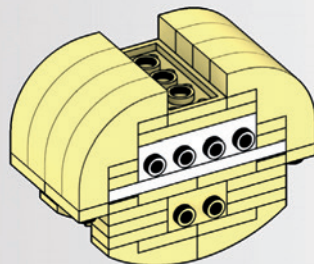

2



16



2x

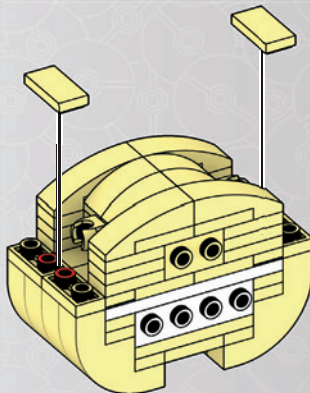

17



4x

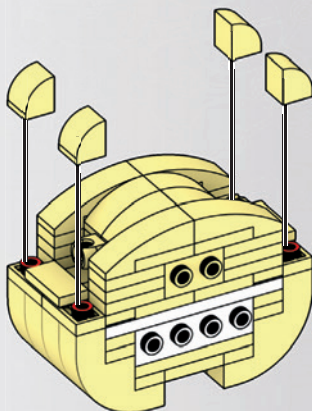

1

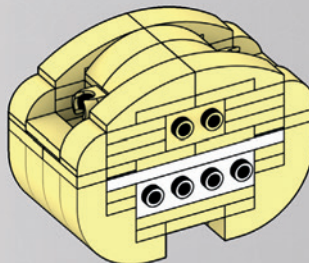

2

18



1x

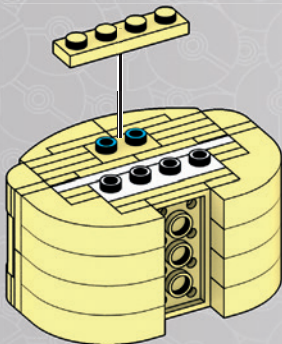

19



1x

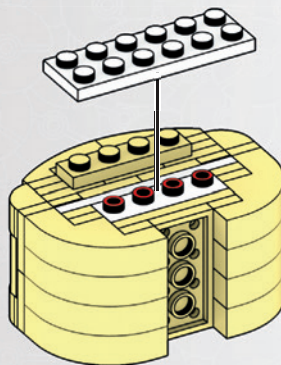

20



1x



2x

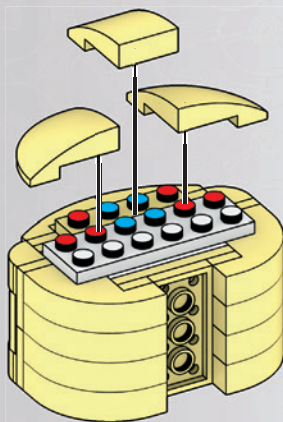

21

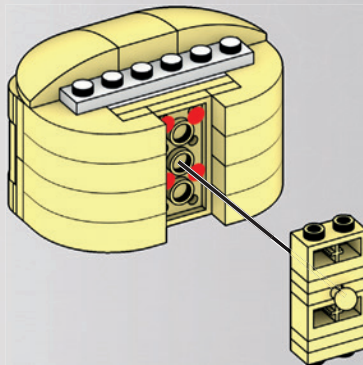
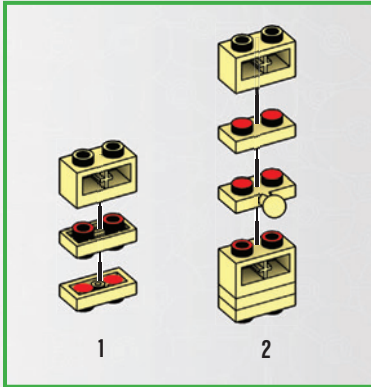
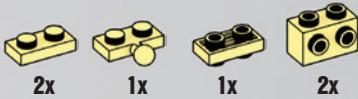



22



1x



2x



1x

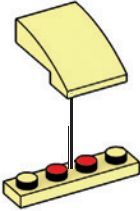

1

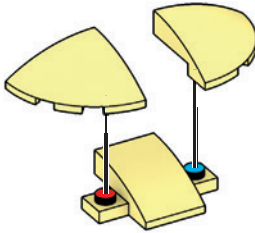

2

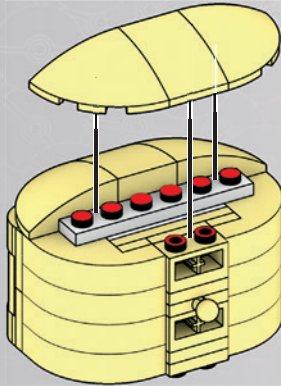

1

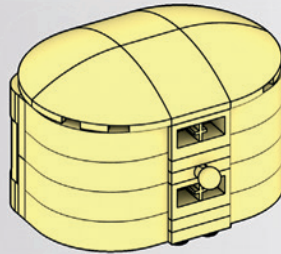

2

23



1x

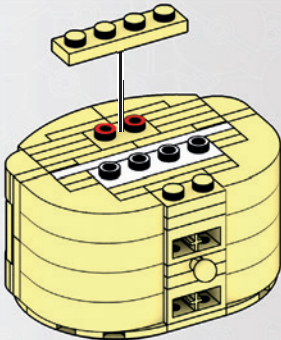

24



1x

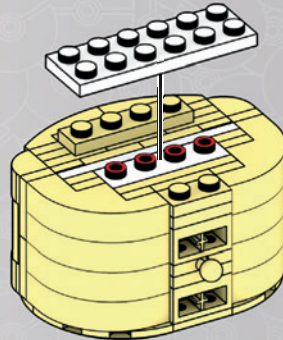

25



1x



1x



1x

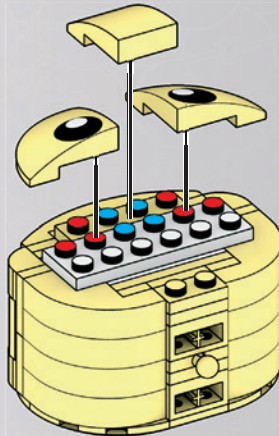

26



1x



1x



1x



1x

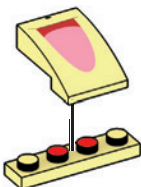

1

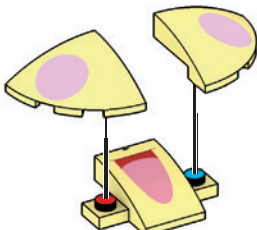

2

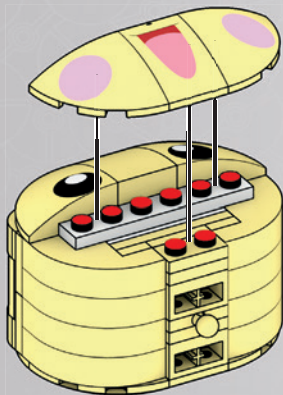

1

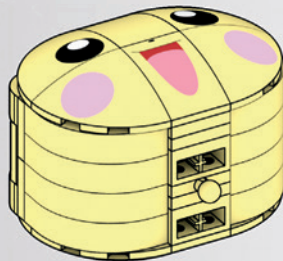
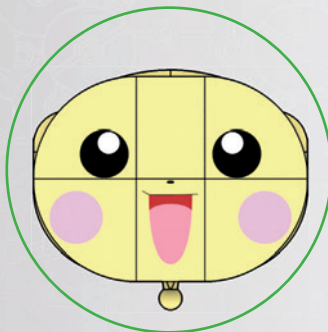

2



27



2x

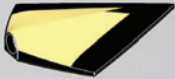

2x



1

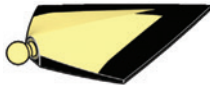

2

x2

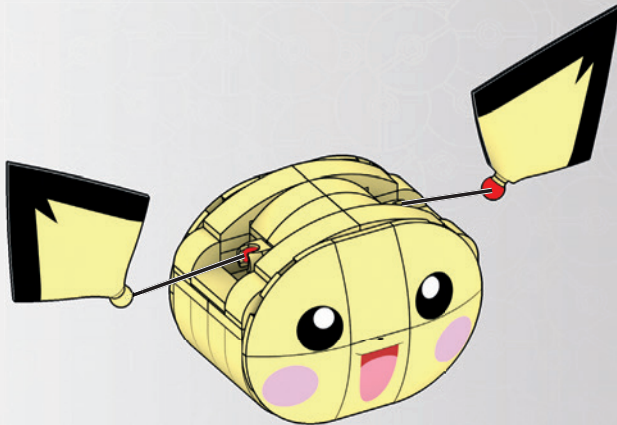

1

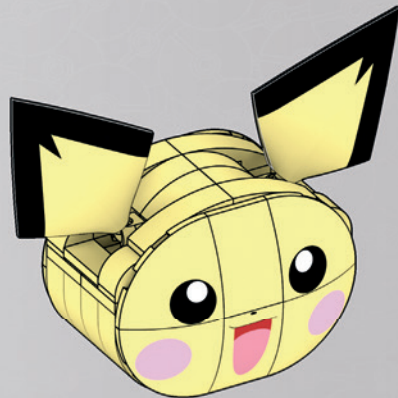

2



32



33

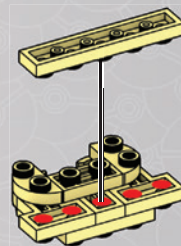
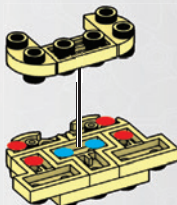
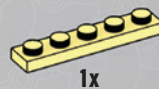

1

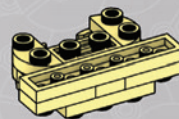

2

34

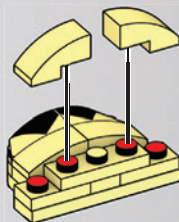
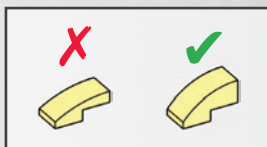



35

1x

1x

1x

2x

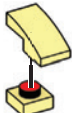
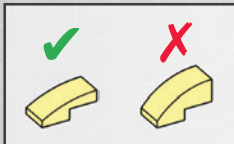

1

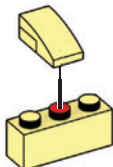

2

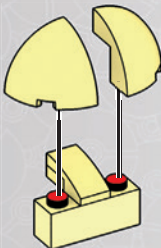

36

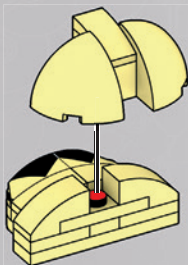

1



2

37



1x

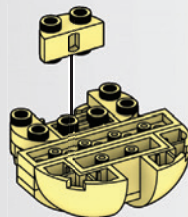

38



2x

1x

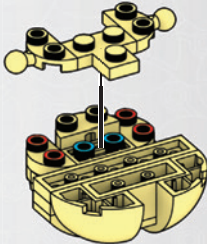

39



2x

2x

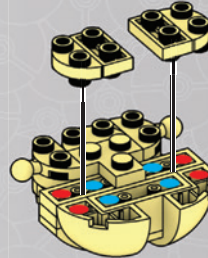

40



1x

1x

1x

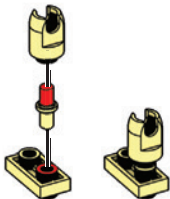

1

2

41



2x

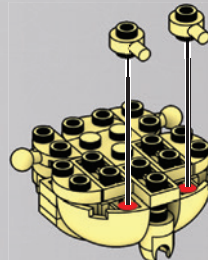
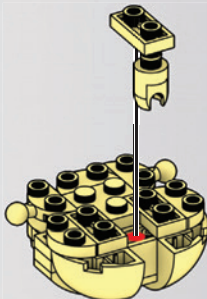

42

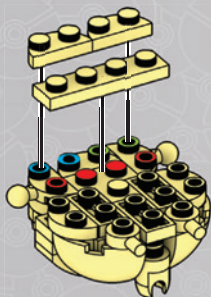

43

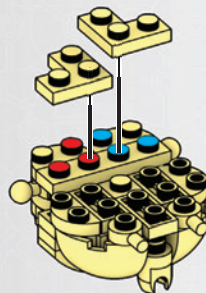

44

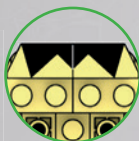
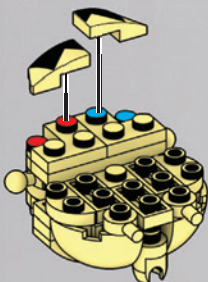

45

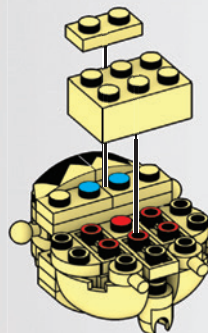
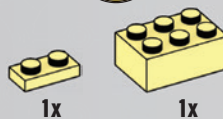

46



2x

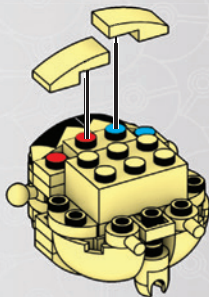

47



1x



1x



2x

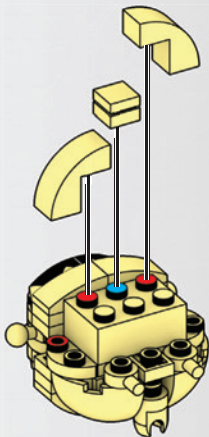

48



1x



2x

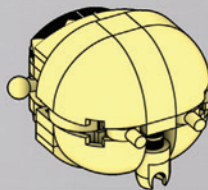
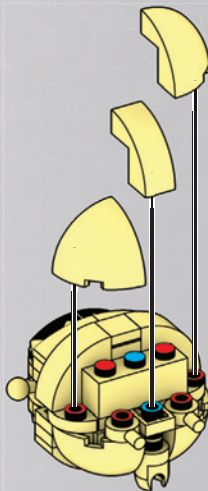

1

2



49



2x



2x



2x

50

x2

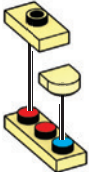

1



2

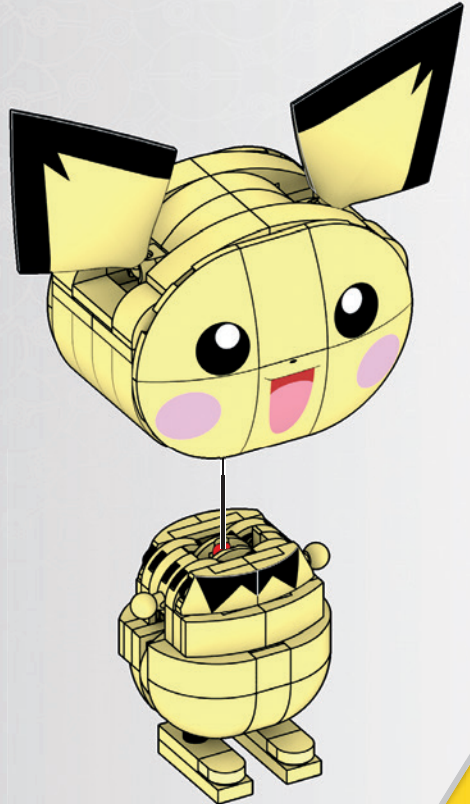
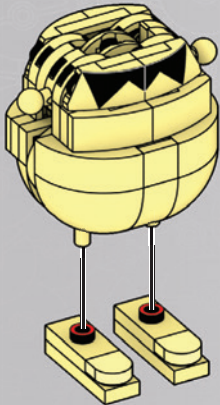

51



2x



2x



2x

x2

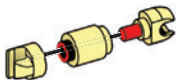

1



2

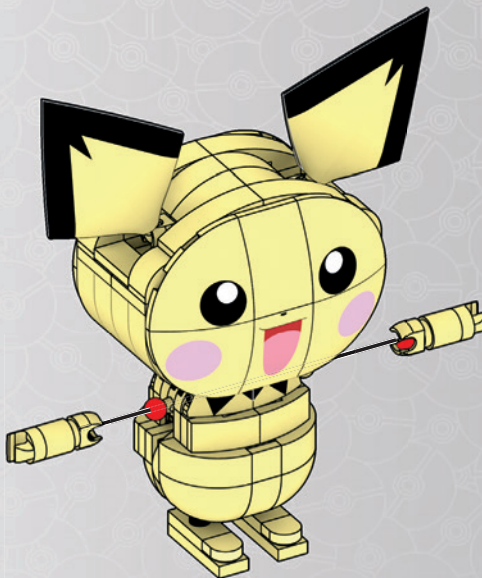

1

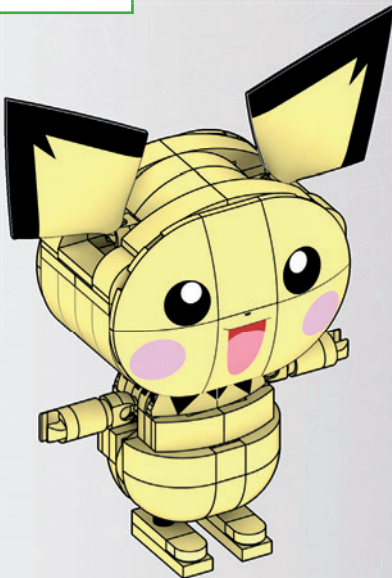

2

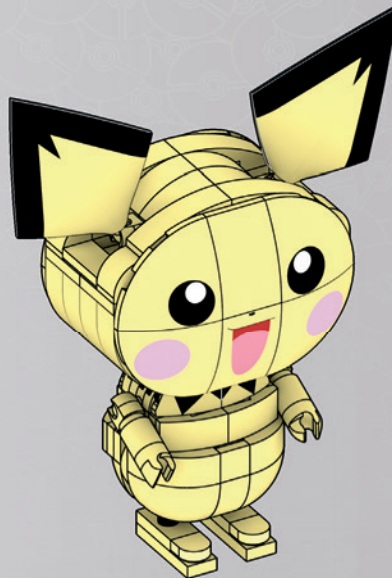

3

52



1x



1x



1x

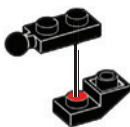

1



2



3

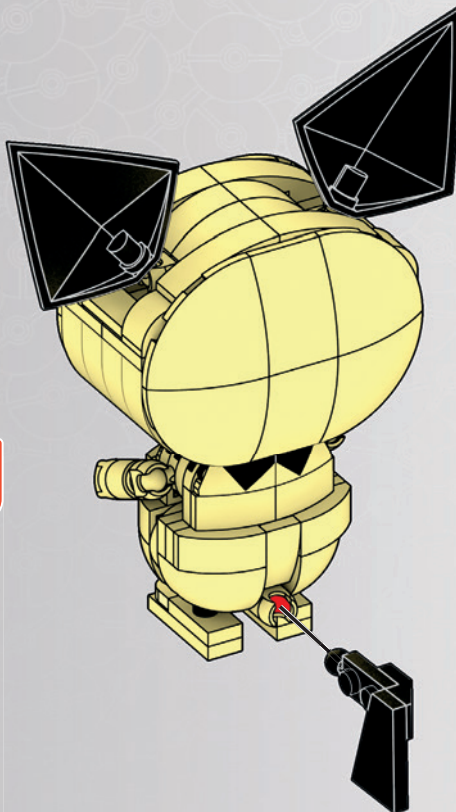

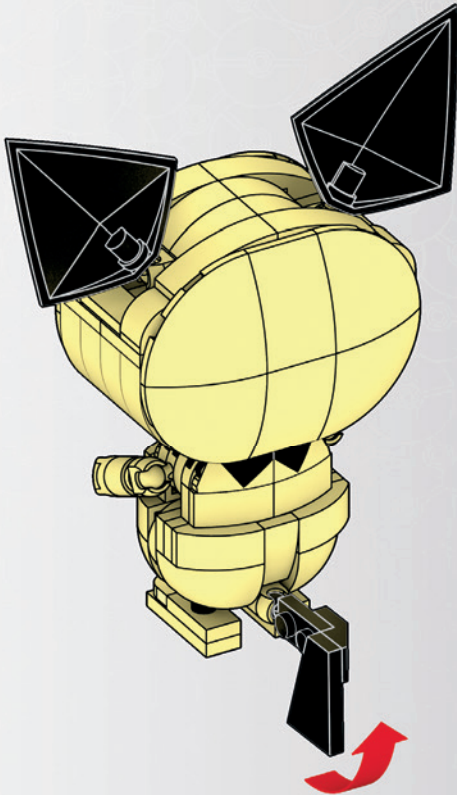

1

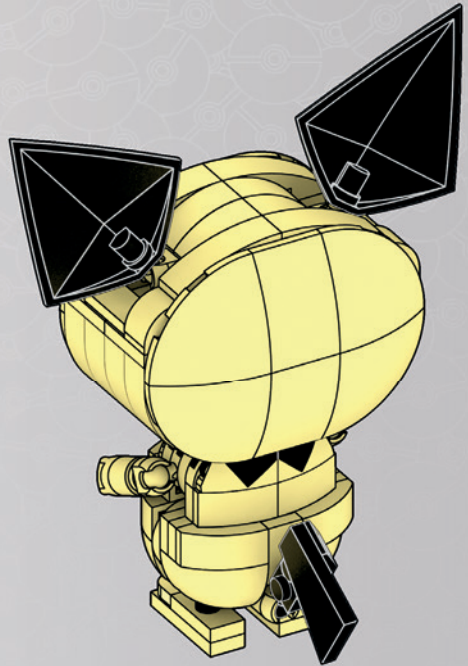

2



54

1x

1x

2x

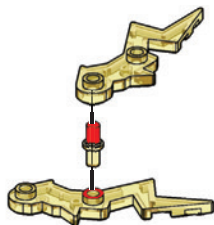

1



2



3



4



1

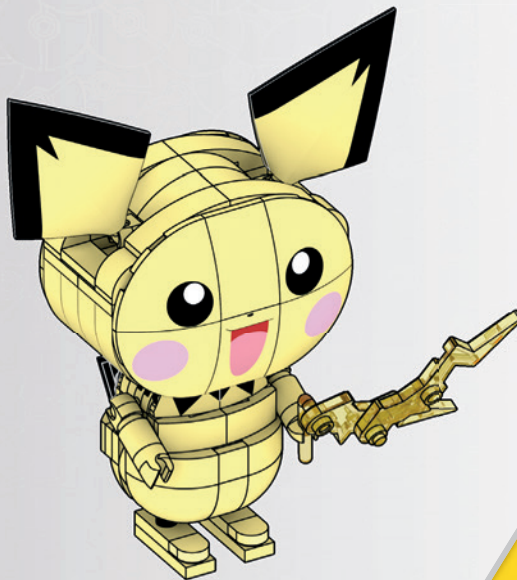

2

55

1x

1x

2x

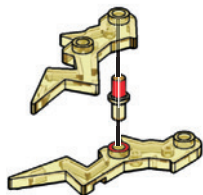

1



2



3



4

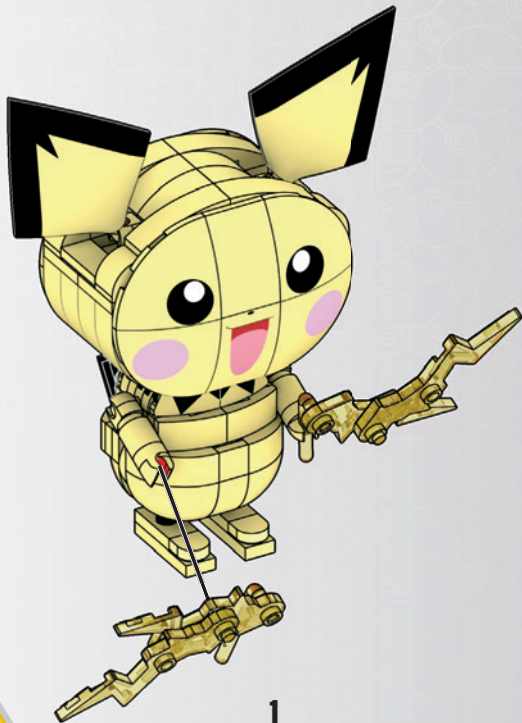

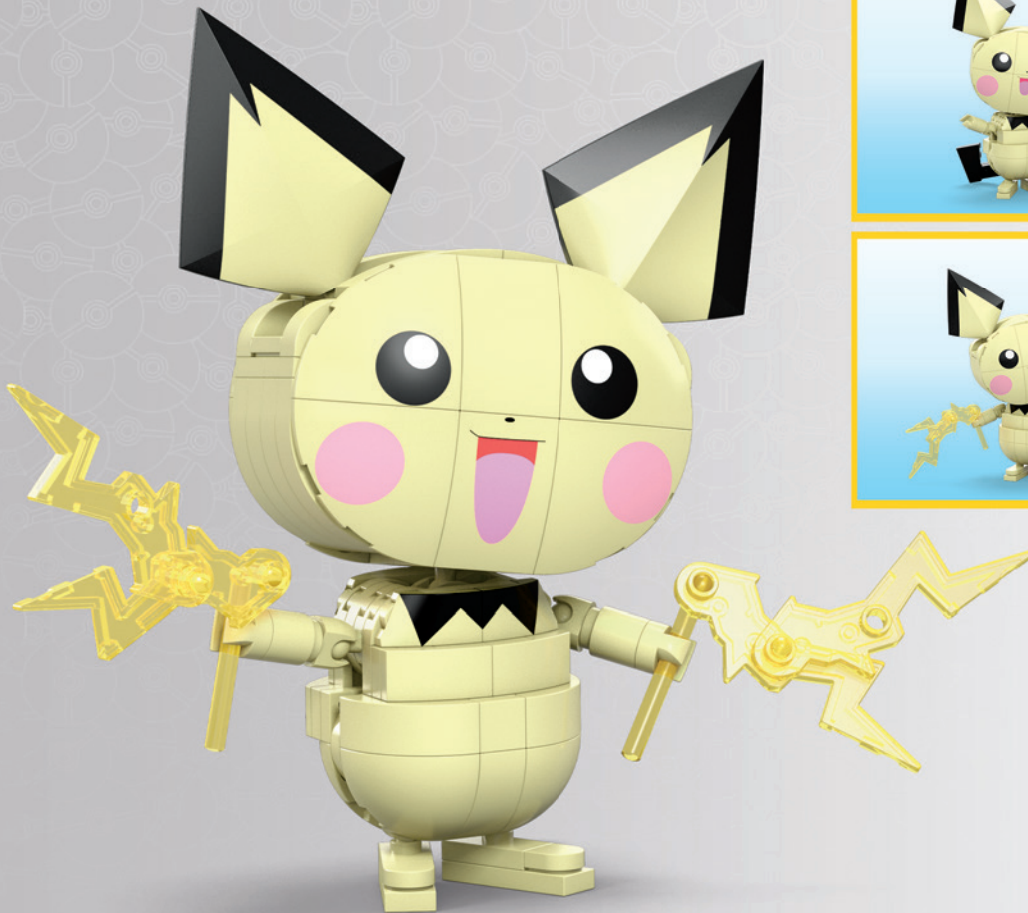

**POSE IT! / VARIEZ LES  
POSES! / ¡PÓSALO!  
VOCÊ PODE POSAR!  
LÄSST SICH IN COOLE  
POSEN BRINGEN!  
МЕНЯЙ ПОЗЫ!**





**BUILD & SHOW PIKACHU EVOLUTION TRIO**  
**CRÉER ET MONTRER LES TROIS ÉVOLUTIONS DE PIKACHU**  
**CONSTRUYE Y MUESTRA - EVOLUCIONES DE PIKACHU**



**PICHU**

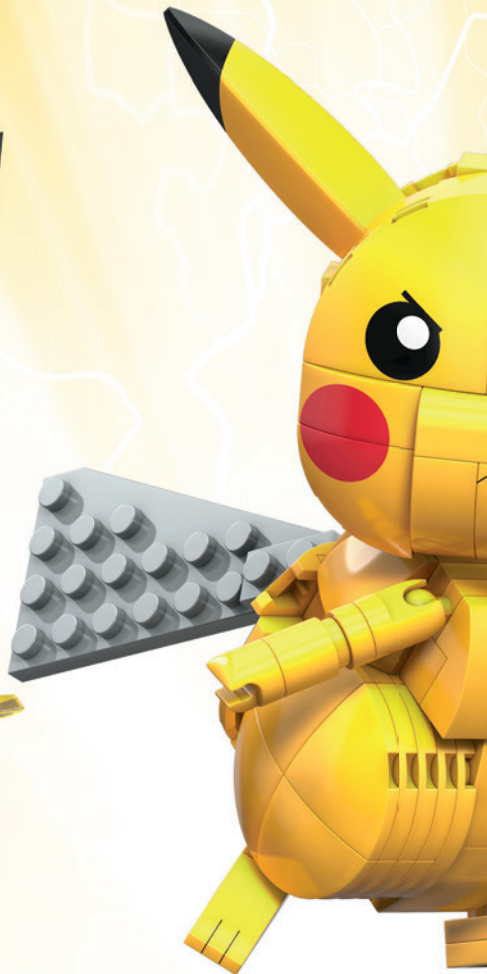





**PIKACHU**



**RAICHU**

2x  
AM76204CS



1x  
AM07223CS



2x  
AM03328CS



2x  
AM17003ZD



1x  
AM17003CS



2x  
AM78297CS



2x  
AM78291CS



2x  
AM80010CS



1x  
AM78275CS



2x  
AM80144CS



4x  
AM07659CS



2x  
AM78296CS



4x  
AM79375CS



4x  
AM78391CS



2x  
AM80011CS



2x  
AM022501CS



4x  
AM73758CS



2x  
AM07590CS



7x  
AM09393CS



17x  
AM16680CS



1x  
AM78397CS



2x  
AM78277CS



1x  
AM78276F



1x  
AS-GYH06-11



1x  
AS-GYH06-12



1x  
AS-GYH06-13



1x  
AS-GYH06-14



5x  
AM78486CS



6x  
AM17788CS



1x  
AM72002F



1x  
AM78281CS



4x  
AM17502CS



3x  
AM16682CS



3x  
AM01314CS



14x  
AM15484CS



4x  
AM18293CS



1x  
AM03773CS



1x  
AM19898F



1x  
AM09023E



8x  
AM72257CS



3x  
AM17021CS



1x  
AS-GYH06-10



1x  
AM16384CS



2x  
AM77738ZD



4x  
AM19324CS



4x  
AM80634CS



1x  
AM03873CS



2x  
AM17503E



7x  
AM09593CS



1x  
AM09033CS



5x  
AM09493CS



1x  
AM07475CS



4x  
AM78389ZD



4x  
AM07230CS



1x  
AS-GYH06-06



1x  
AS-GYH06-07



1x  
AS-GYH06-08



1x  
AS-GYH06-09



2x  
AS-GYH06-05



4x  
AM01480E



## Missing pieces? Pièces manquantes?

¿Partes faltantes? • Perdeu peças?  
Fehlen Teile? • Не хватает деталей?

support.megabrand.com

**ATTENTION** : DANGER  
D'ÉTOUFFEMENT. - PRÉSENCE DE PETITS  
ÉLÉMENTS. NE CONVIENT PAS AUX ENFANTS DE  
MOINS DE 3 ANS.

**ATENÇÃO!** NÃO INDICADO / NÃO  
RECOMENDÁVEL PARA CRIANÇAS MENORES DE 3  
(TRÊS) ANOS POR CONTER PARTE(S) PEQUENA(S)  
QUE PODE(M) SER ENGOLIDA(S) OU ASPIRADA(S)  
PODENDO PROVOCAR ASFIXIA.

警告:

のどにつまる危険 小さな部品が含まれています  
3歳以下の子供には与えないで下さい。

**警告!**  
不适合3岁以下儿童使用。  
内含小零件。

**⚠ WARNING : CHOKING HAZARD. - Small parts.**

Not for children under 3 years.

**ADVERTENCIA: PELIGRO DE ATRAGANTAMIENTO.** Juguete no recomendado para menores de 3 años, porque contiene piezas pequeñas que podrían provocar asfixia en caso de ser ingeridas o inhaladas por el/la niño/a.

**AVVERTENZA:** Contiene pezzi di piccole dimensioni.

**ACHTUNG:** Kleine Teile.

**OSTRZEŻENIE:** Małe części. Niebezpieczeństwo zadławienia.

**WAARSCHUWING:** Kleine onderdelen

**ПРЕДУПРЕЖДЕНИЕ:** Мелкие детали.

**ADVARSEL:** Indeholder små dele.

**VARNING:** Smådelar

**ADVARSEL:** Små deler

**VAROITUS:** Pieniä osia

**ΠΡΟΣΟΧΗ:** Περιλαμβάνονται μικρά κομμάτια.

**UVARI:** Kicsik darcsalár.

**UPOZORNĚNÍ:** Malé díly

**UPOZORNENIE:** Malé části

**FIGYELMEZTETÉS:** Kis alkatrészek.



0-3

تحذير:

غير مناسبة للأطفال دون 36 شهراً - قطع صغيرة.

Build & Show Pikachu Evolution Trio / Créer et montrer les trois évolutions de Pikachu / Construye y muestra - Evoluciones de Pikachu / Construa e mostre - Evoluções do Pikachu / Costruisci e mostra Pikachu Evolution Trio / Bauen & Zeigen Pikachu Evolution Trio / Buduj i pokaż Pikachu zestaw trzech form / Bouw en laat Pikachu Evolution Trio zien / Построй и покажи Pikachu Тройная Эволюция / Κατασκευή & Εμφάνιση Pikachu Evolution Trio / Pikachu Evrim Üçlülüsünü Birleştir ve Göster / Pikachu Evolução trio épitése és megjelntése / Bygg och visa Pikachu utvecklings-trio / Rakenna & näytä Pikachu-evoluutiokolmikko / Byg og vis Pikachu udviklings-trio / Bygg & Vis Pikachu Evolusjon Trio / Sestavte a předvedte trojici figurek Pikachu Evolution / Vytvorte a ukážte evolučné trio Pikachu / بناء وعرض تطور الثلاثي

Mattel Europa B.V., Gondel 1, 1186 MJ Amstelveen, Nederland. Mattel U.K. Limited, The Porter Building, 1 Brunel Way, Slough SL1 1FQ, UK. Mattel France, Parc de la Cerisaie, 1/3/5 allée des Fleurs, 94260 Fresnes Cedex. N° Cristal 0969 36 99 99 (Numéro non surtaxé) ou www.lesjouetsmattel.fr Mattel Belgium, Trade Mart, Atomiumsquare, Bogota 202 - B 275, 1020 Brussels. Gratis nummer België: 0800 - 16 936 - Gratis nummer Luxemburg: 800 - 22 784 - Gratis nummer Nederland: 0800 - 262 88 35. Deutschland: Mattel GmbH, Solmsstraße 83, D-60486 Frankfurt am Main. Schweiz: Mattel AG, Kirchstrasse 24, CH-3097 Liebefeld. Österreich: Mattel Ges.m.b.H., Campus 21, Liebermannstraße A01 404, A- 2345 Brunn/Gebrige. Mattel Italy Srl, Via Turati 4, 20121 Milano, Italy. Servizio assistenza clienti: Customersrvvitalia@mattel.com - Numero verde 800 11 37 11. Mattel España, S.A, Aribau 200 pl. 9, 08036 Barcelona. cservice.spain@mattel.com Tel.: +34 933 06 79 00 http://www.service.mattel.com/es. Mattel East Asia Ltd., Room 503-09, North Tower, World Finance Centre, Harbour City, Tsimshatsui, HK, China. Tel.: (852) 3185-6500. Diimpport & Diedarkan Oleh: Mattel Continental Asia Sdn Bhd. Level 19, Tower 3, Avenue 7, No. 8 Jalan Kerinchi, Bangsar South, 59200 Kuala Lumpur, Malaysia. Mattel South Africa (PTY) LTD, Office 102 B3, 30 Melrose Boulevard, Johannesburg 2196. Dystrybutor: Mattel Poland Sp. z o.o., Warsaw Trade Tower 34 p., ul. Chłodna 51, 00-867 Warszawa. Mattel Australia Pty. Ltd., 658 Church St., Richmond, Victoria, 3121. Consumer Advisory Service - 1300 135 312. Mattel AEBE, Εθνάρχου Μακρίνου 1, Κτήριο Κ-2, ΤΚ 17561, Παλαιό Φάληρο. Mattel Oyuncakçılık Tic. Ltd. Şti. İçerenköy Mah., Umut Sok. No:10-12 Quick Tower Kat:2/15 34752 Ataşehir İstanbul Tel: 0216 570 75 00. Импортер/Уполномоченная организация: ООО "МАТТЕЛ" Российская Федерация, 105120 Москва, 2-й Сыроматинский переулок, 1; +7 495 287 79 39. Mattel Czech Republic s.r.o., The Forum, Václavské nám. 19, 11000 Praha 1. Mattel, 333 Continental Boulevard, El Segundo, CA 90245, USA. Consumer Services: 1-800-465-MEGA (6342). Mattel Canada Inc., Mississauga, Ontario L5R 3W2. Consumer Services: You may call us free at/ Composez sans frais le 1-800-524-8697. Importado y distribuido por Mattel de México, S.A. de C.V., Miguel de Cervantes Saavedra No. 193, Pisos 10 y 11, Col. Granada, Alcañida Miguel Hidalgo, CP 11520, México, Ciudad de México. R.F.C. MME-920701-NB3. Tels: 59-05-51-00 Ext. 5206 ó 01-800-463-59-89. Mattel Chile, S.A., Avenida Américo Vespucio 501-B, Quilicura, Santiago. Tel.: 1230-020-6213. Servicio al consumidor Venezuela: Tel: 0-800-100-9123. Mattel Argentina, S.A., Av. Libertador 1000, Piso 11 - Oficinas 109 y 111, Vicente López - Prov. Buenos Aires. Tel: 0800-666-3373. Mattel Colombia, S.A., Calle 123#-07 P5, Bogotá. Tel: 01800-710-2069. Mattel Perú, S.A., Av. Juan de Arona # 151, Centro Empresarial Juan de Arona, Torre C, Piso 7, Oficina 704, San Isidro, Lima 27, Perú. RUC: 20425853865. Reg. Importador: 02350-12-JUE-DIGESA. Tel: 0800-54744. E-mail Latinoamérica: servicio.clientes@mattel.com. Mattel do Brasil Ltda. - CNPJ: 54.558.002/0001-20 - Rua Verbo Divino, 1488 - 2º - Andar - 04719-904 - Chácara Santo Antônio - São Paulo - SP - Brasil. Serviço de Atendimento ao Consumidor: fone 0800 575 0780. E-mail: sac.matteldobrazil@mattel.com





# POKÉMON



GMD31



HDL84

Set(s) sold separately and subject to availability. / Ensemble(s) vendu(s) séparément. Certains produits peuvent ne pas être commercialisés. / Se vende(n) por separado y está(n) sujeto(s) a disponibilidad. / Conjunto(s) vendido(s) em separado e sujeito(s) à disponibilidade. / Set in vendita separatamente, secondo disponibilità. / Das/Die Set(s) sind separat erhältlich. / Zestaw(y) sprzedawany(e) oddzielnie w zależności od dostępności. / Set(s) apart verkrijgbaar en afhankelijk van beschikbaarheid. / Набор(-ы) продаются отдельно, при наличии. / Sæt sælges separat og så længe lager haves. / Seten säljs separat så länge lagret räcker. / Settet/settene selges separat så langt lageret rekker. / Pakkaus/pakkausset myydään erikseen, saatavuus voi vaihdella. / Το(α) σετ πωλούνται ξεχωριστά και ανάλογα με τη διαθεσιμότητα. / Setler ayrı olarak satılır ve stoklarla sınırlıdır. / Set (sety) se prodává (prodávají) samostatně dle aktuální nabídky. / Сўправа/-y sa predáva(jú) samostatne a podľa dostupnosti. / A készlet(ek) külön kapható(k), az elérhetőség változhat. / セット商品は別売りになります。在庫状況は別途ご確認をお願いします。 / نباع المجموعة أو المجموعات على حدة وتخضع لتوافرها. / 每套单独发售，按供货情况决定。

Set(s) sold separately and subject to availability. / Ensemble(s) vendu(s) séparément. Certains produits peuvent ne pas être commercialisés. / Se vende(n) por separado y está(n) sujeto(s) a disponibilidad. / Conjunto(s) vendido(s) em separado e sujeito(s) à disponibilidade. / Set in vendita separatamente, secondo disponibilità. / Das/Die Set(s) sind separat erhältlich. / Zestaw(y) sprzedawany(e) oddzielnie w zależności od dostępności. / Set(s) apart verkrijgbaar en afhankelijk van beschikbaarheid. / Набор(-ы) продаются отдельно, при наличии. / Sæt sælges separat og så længe lager haves. / Seten säljs separat så länge lagret räcker. / Settet/settene selges separat så langt lageret rekker. / Pakkaus/pakkausset myydään erikseen, saatavuus voi vaihdella. / Το(α) σετ πωλούνται ξεχωριστά και ανάλογα με τη διαθεσιμότητα. / Setler ayrı olarak satılır ve stoklarla sınırlıdır. / Set (sety) se prodává (prodávají) samostatně dle aktuální nabídky. / Сўправа/-y sa predáva(jú) samostatne a podľa dostupnosti. / A készlet(ek) külön kapható(k), az elérhetőség változhat. / セット商品は別売りになります。在庫状況は別途ご確認をお願いします。 / نباع المجموعة أو المجموعات على حدة وتخضع لتوافرها. / 每套单独发售，按供货情况决定。

Set(s) sold separately and subject to availability. / Ensemble(s) vendu(s) séparément. Certains produits peuvent ne pas être commercialisés. / Se vende(n) por separado y está(n) sujeto(s) a disponibilidad. / Conjunto(s) vendido(s) em separado e sujeito(s) à disponibilidade. / Set in vendita separatamente, secondo disponibilità. / Das/Die Set(s) sind separat erhältlich. / Zestaw(y) sprzedawany(e) oddzielnie w zależności od dostępności. / Set(s) apart verkrijgbaar en afhankelijk van beschikbaarheid. / Набор(-ы) продаются отдельно, при наличии. / Sæt sælges separat og så længe lager haves. / Seten säljs separat så länge lagret räcker. / Settet/settene selges separat så langt lageret rekker. / Pakkaus/pakkausset myydään erikseen, saatavuus voi vaihdella. / Το(α) σετ πωλούνται ξεχωριστά και ανάλογα με τη διαθεσιμότητα. / Setler ayrı olarak satılır ve stoklarla sınırlıdır. / Set (sety) se prodává (prodávají) samostatně dle aktuální nabídky. / Сўправа/-y sa predáva(jú) samostatne a podľa dostupnosti. / A készlet(ek) külön kapható(k), az elérhetőség változhat. / セット商品は別売りになります。在庫状況は別途ご確認をお願いします。 / نباع المجموعة أو المجموعات على حدة وتخضع لتوافرها. / 每套单独发售，按供货情况决定。



Mattel Canada Inc. Mississauga, Ontario L5R 3W2.  
MADE IN CHINA. FABRIQUÉ EN CHINE. FABRICADO NA CHINA. HECHO EN CHINA.  
ИЗГОТОВЛЕНО В КИТАЕ. ÇIN'DE ÜRETİLMİŞTİR. صنع في الصين

© D781,964, D797,203, D799,607, D834,105

1186 MJ, 1, NL

©2022 MEGA Brands &™ MEGA Brands.  
Printed in China / Imprimé en Chine

AD-GYH06-04A







POKÉMON™



BUILD & SHOW PIKACHU  
EVOLUTION TRIO  
CRÉER ET MONTRER LES TROIS  
ÉVOLUTIONS DE PIKACHU

CONSTRUYE Y MUESTRA - EVOLUCIONES DE PIKACHU / CONSTRUA E MOSTRE - EVOLUÇÕES DO PIKACHU

GYH06



# Build Construisez

Construye | Constrói  
Bauen | Стройте



# Share | Partagez

Comparte | Partilha  
Teilen | Делитесь



# Easy-to-follow steps!

# Des instructions faciles à suivre !

¡Pasos fáciles de seguir!  
Passos fáceis de seguir!  
Einfache Schritte!  
Простые действия!



Devices not included | Appareils non inclus | Dispositivos no incluido | Dispositivos não incluídos | Geräte nicht enthalten | Устройства не входят в комплект

[megaunboxed.com](http://megaunboxed.com)



1



1x



1x



2x

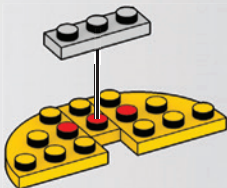

2



3x

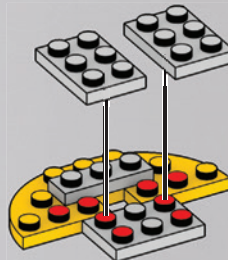

3

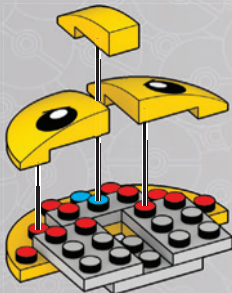

4

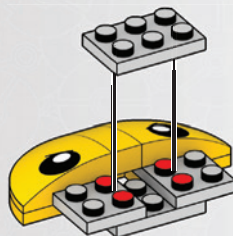
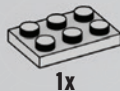

5

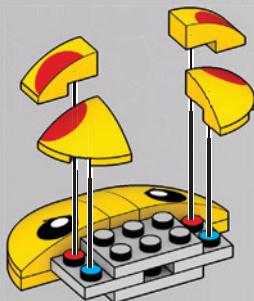

1



2

6

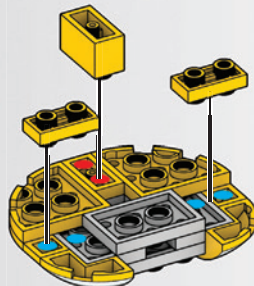
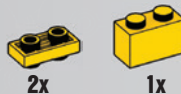



7



2x

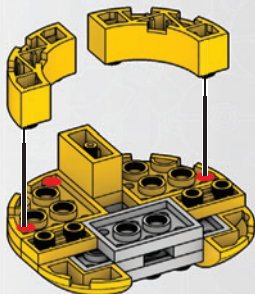

8



2x

2x

4x



x2

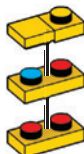

1



2

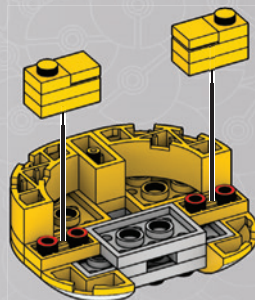

9



2x

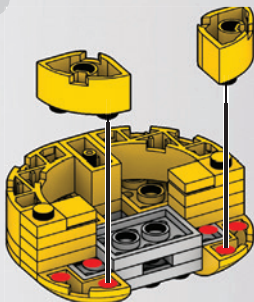

10



1x



1x

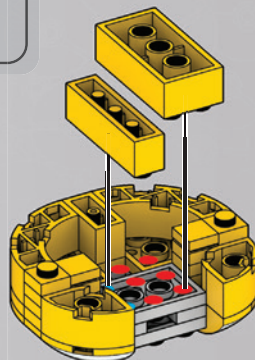



11



2x



2x

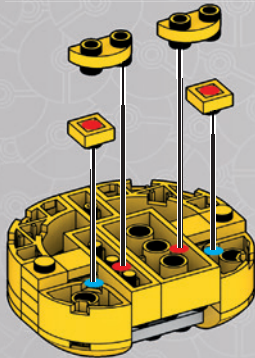

12



2x



2x



1x

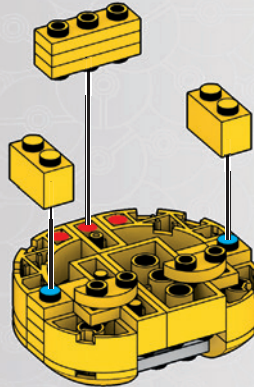
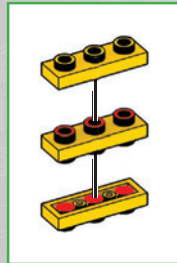

1

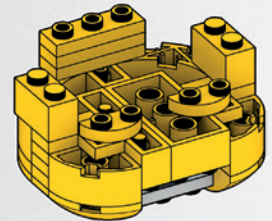

2

13



3x



1x

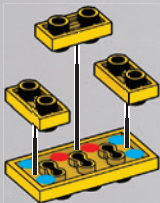

14



2x



2x



1x

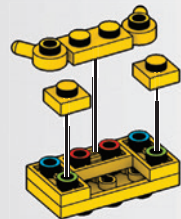
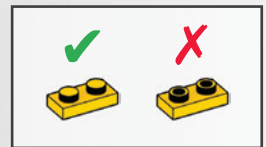

15



1x



1x

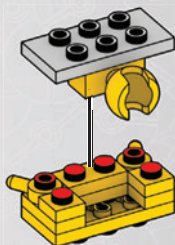

1



2

16

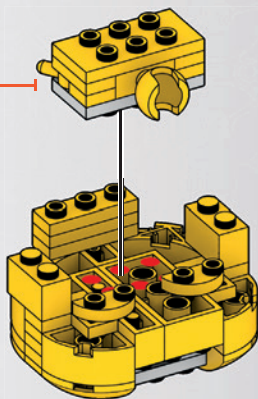

1

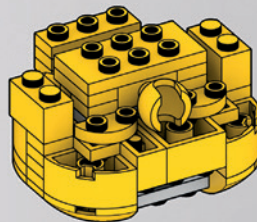

2

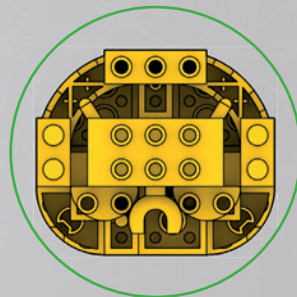

17



1x



1x

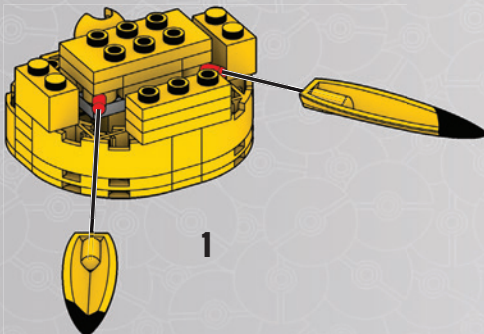
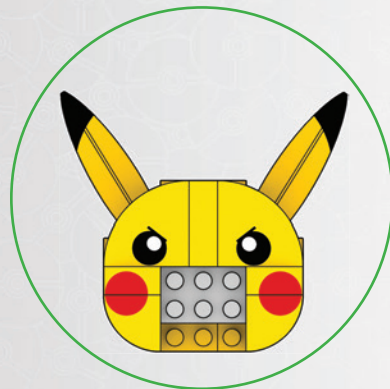

1

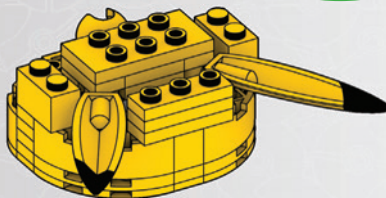

2

18



1x



2x

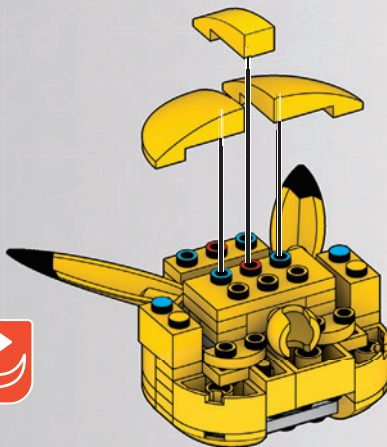



19



1x

1x

2x

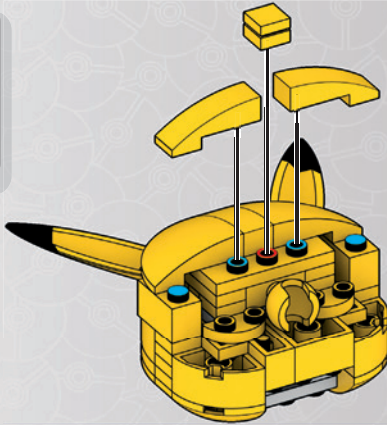

20



4x

2x

2x

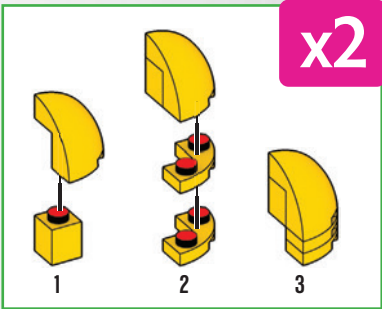
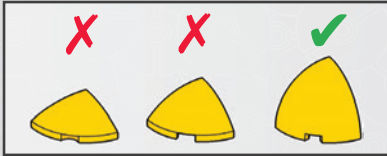

x2

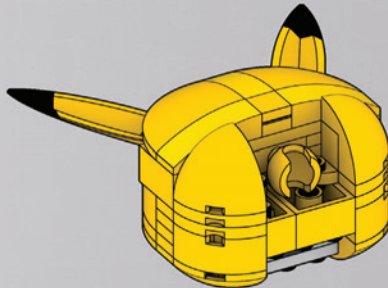
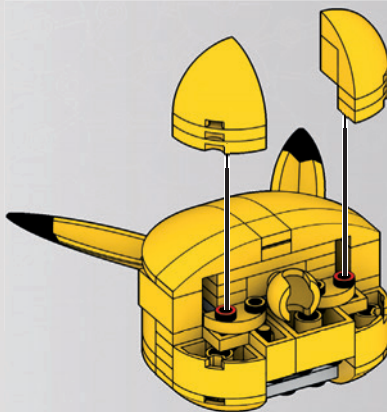

1

2



21



1x



1x

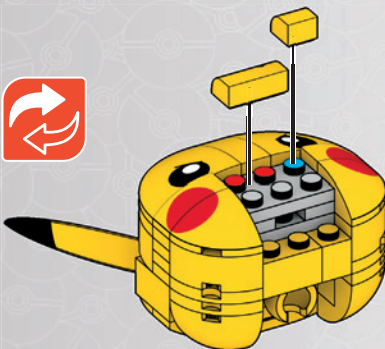

22



1x



1x

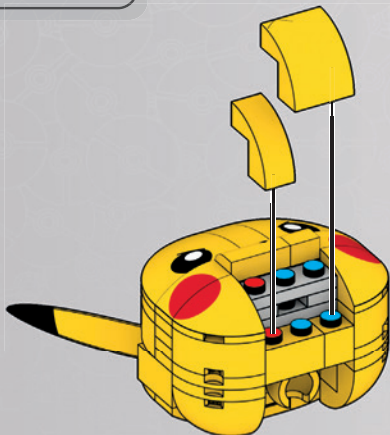

1

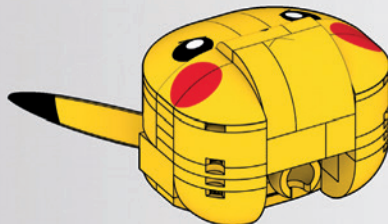
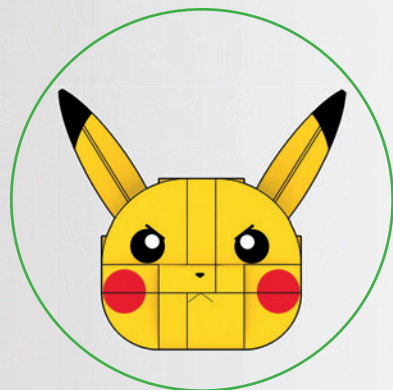

2

23

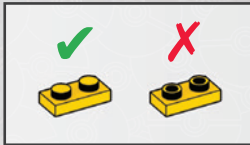

24

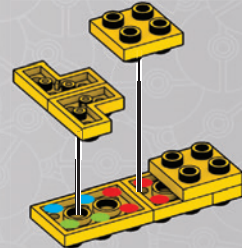

25



26

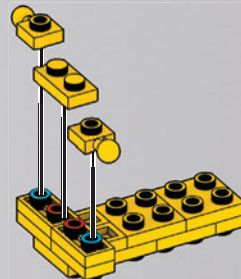
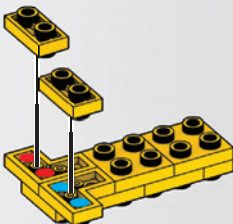
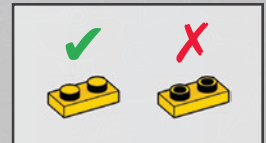

27



2x

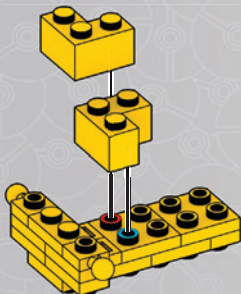

28



1x



1x



1x

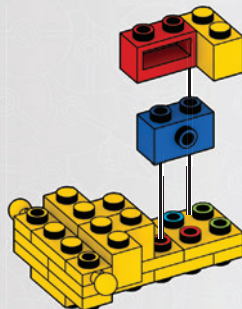

29



1x



1x

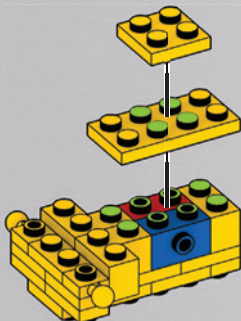

30



2x

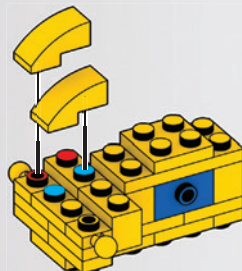

31



2x



32



2x

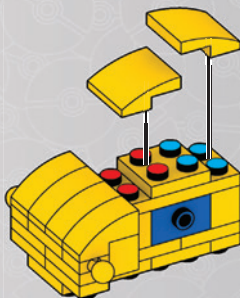

1

2

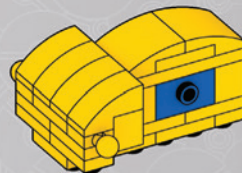

33



2x

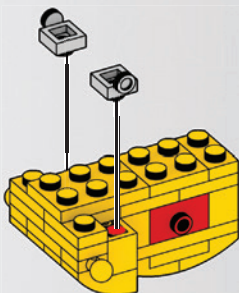

34



4x



1x

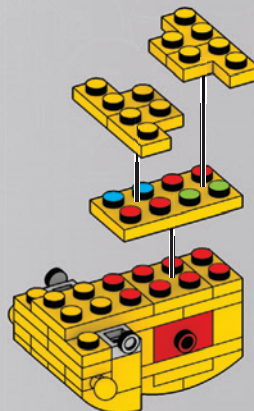



35



1x



1x

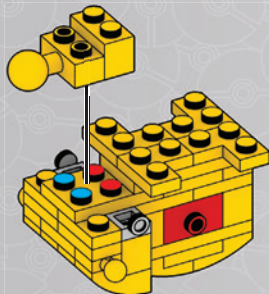

36



2x

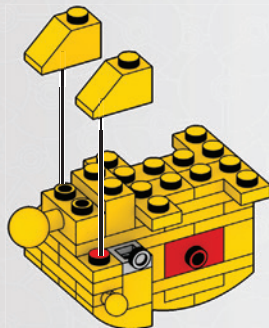

37



2x



1x

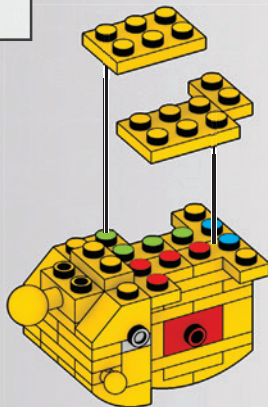
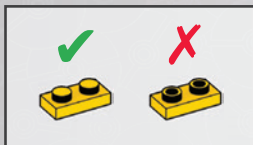

38



2x



1x

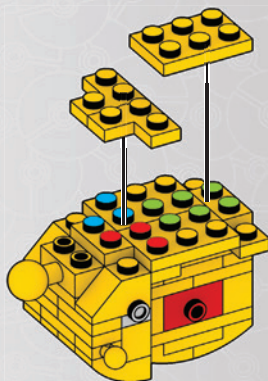

39



2x

X

✓

X

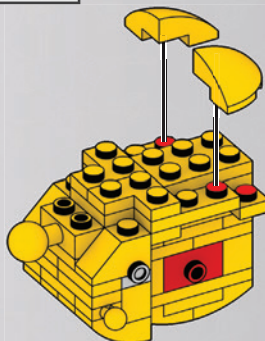

40



1x



1x

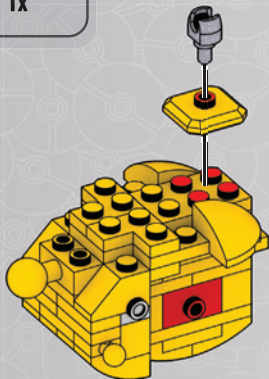

41



2x



1x

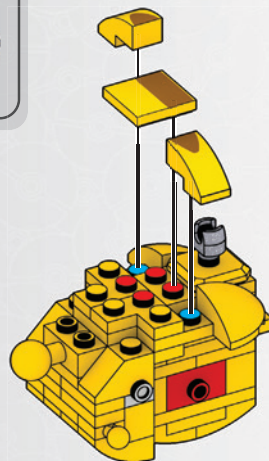

42



1x



1x

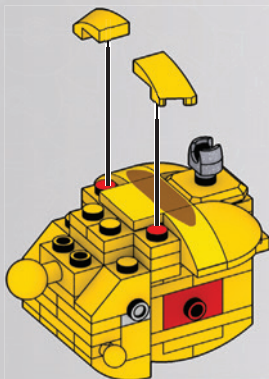

43



2x



1x



1x

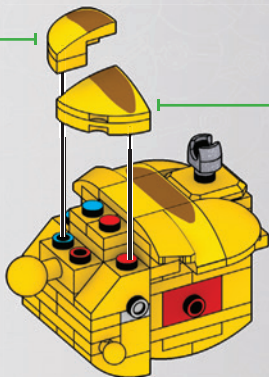
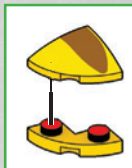

1

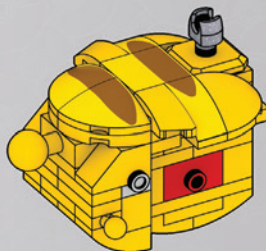

2



44



2x



2x

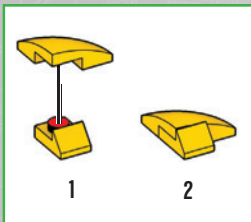

1

2

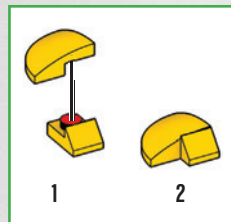
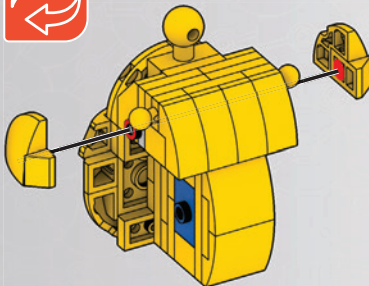

1

2

45



1x



1x

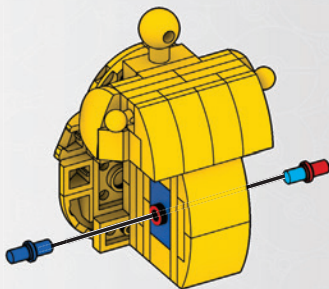

1

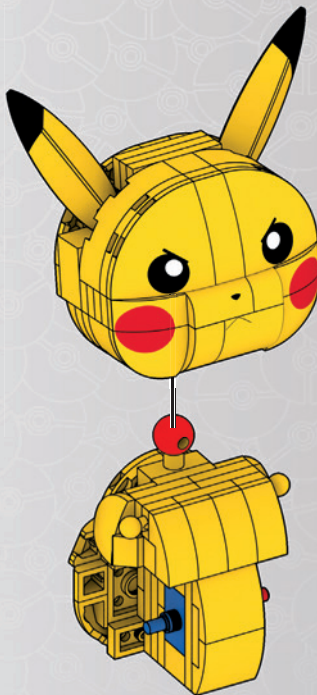

2

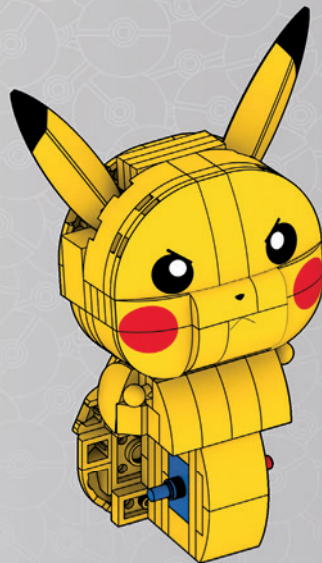

3

46



3x



1x



1x

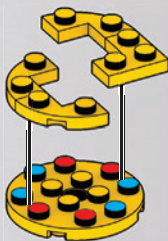

47



1x



3x



1x



48



4x

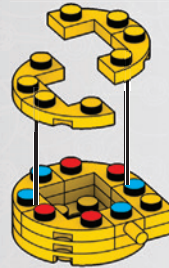

1

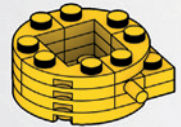

2

49



1x



2x

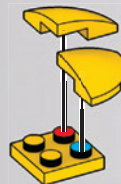



50



2x

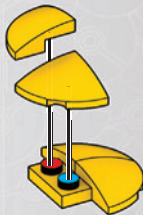
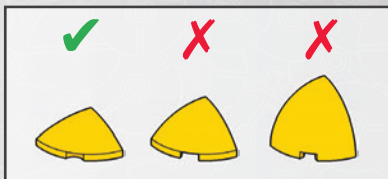

1



2

51



1x



1x

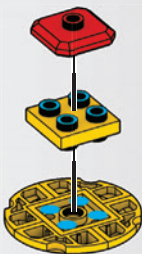

1



2

52

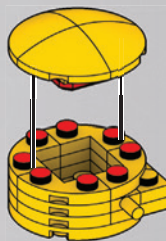

1

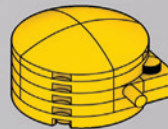

2

53



1x



1x



1x

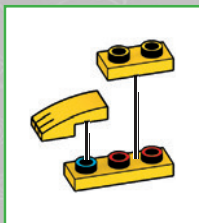
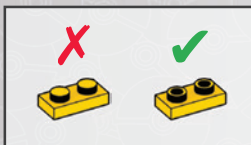

1

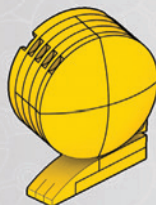

2

54



3x



1x



1x

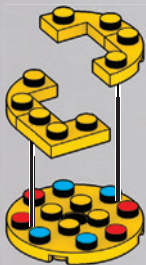

55



1x



3x



1x

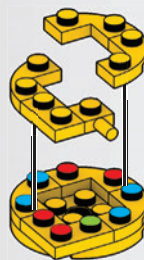
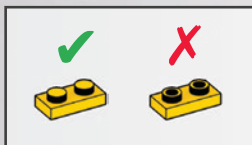

56



4x

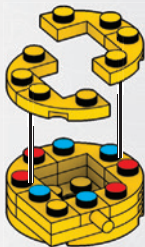

1

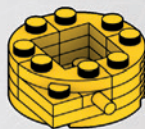

2

57



1x



2x

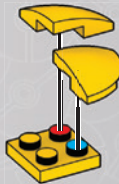
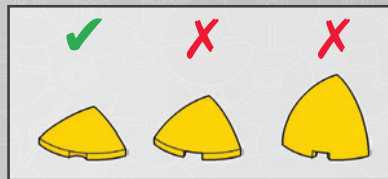

58



2x

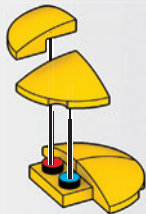
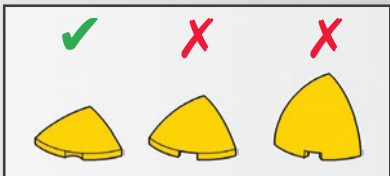

1



2

59



1x



1x

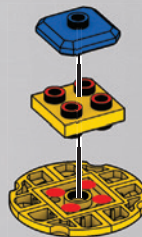

1



2



60

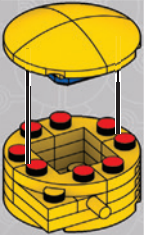

1



2

61



1x



1x



1x

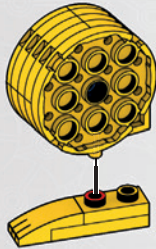
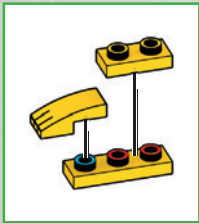
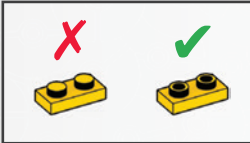

1

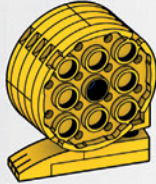

2

62

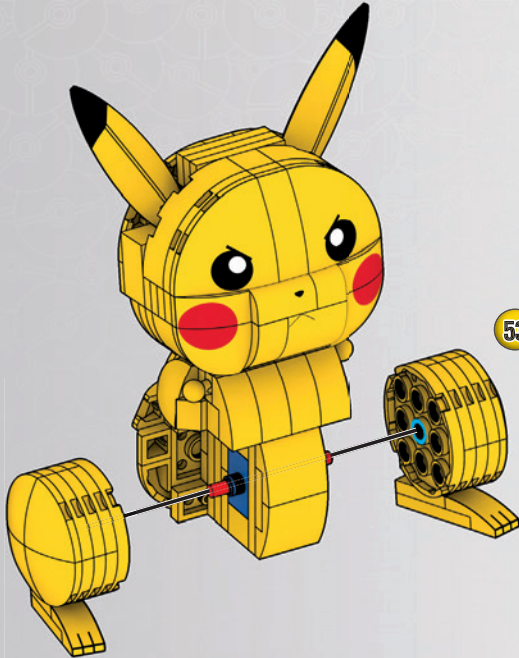

61

53

63



2x



2x



2x



2x



1

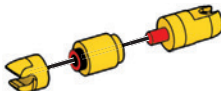

2



3

x2

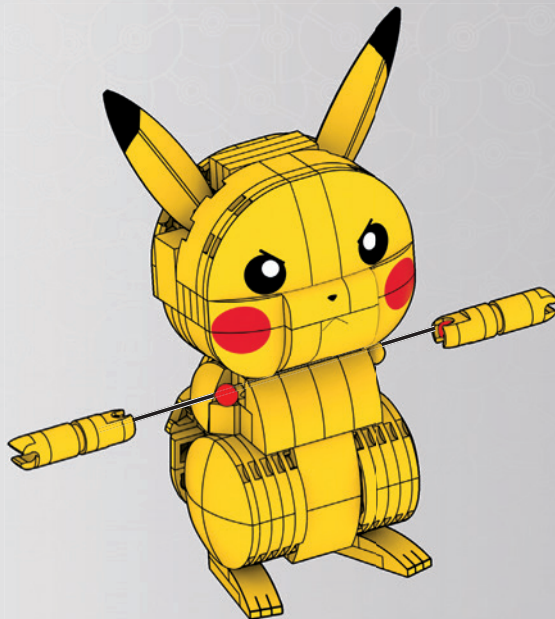

1

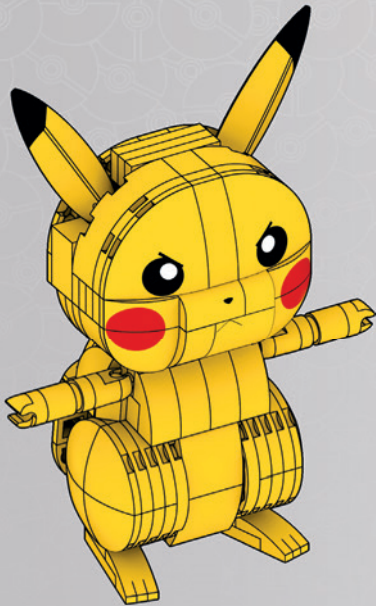

2

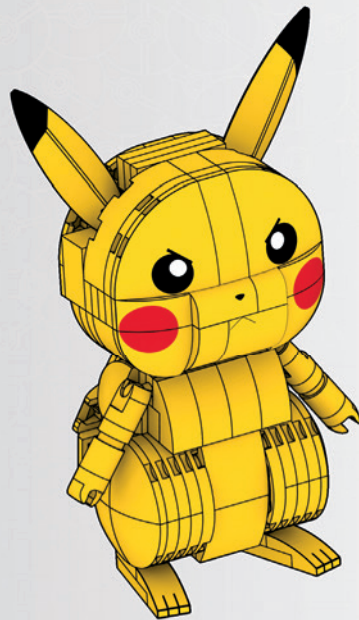

3



64

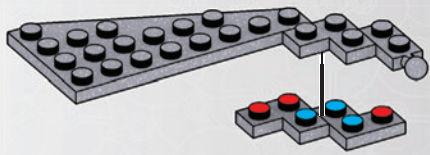

65

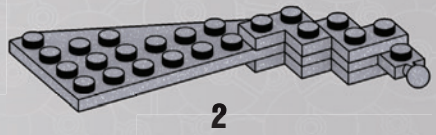

66

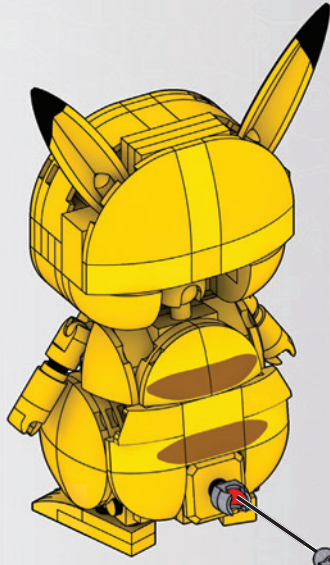

1

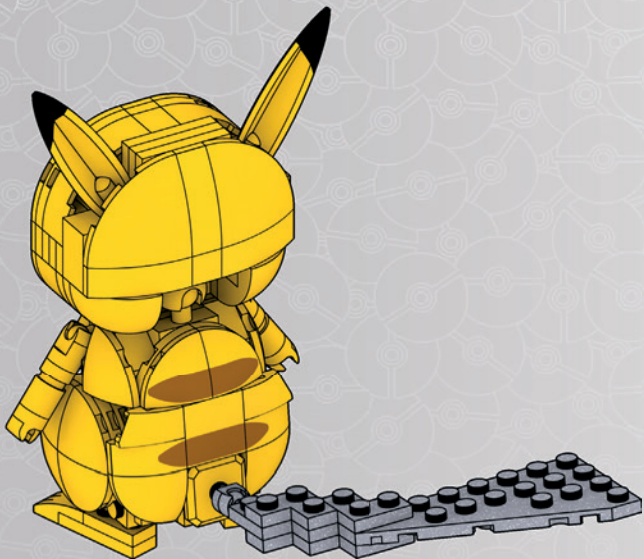

2

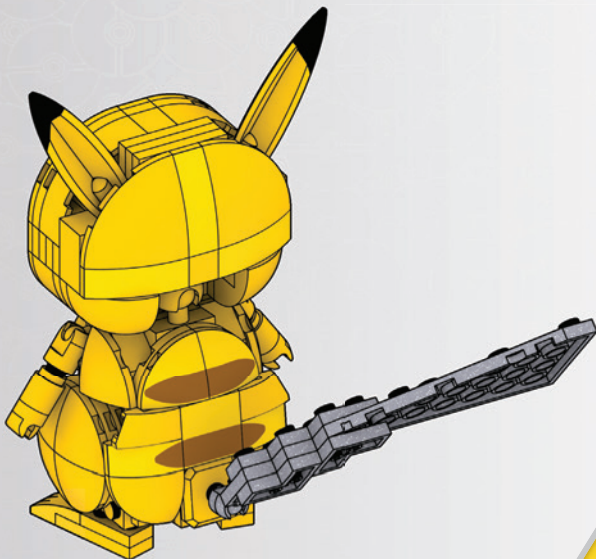

3

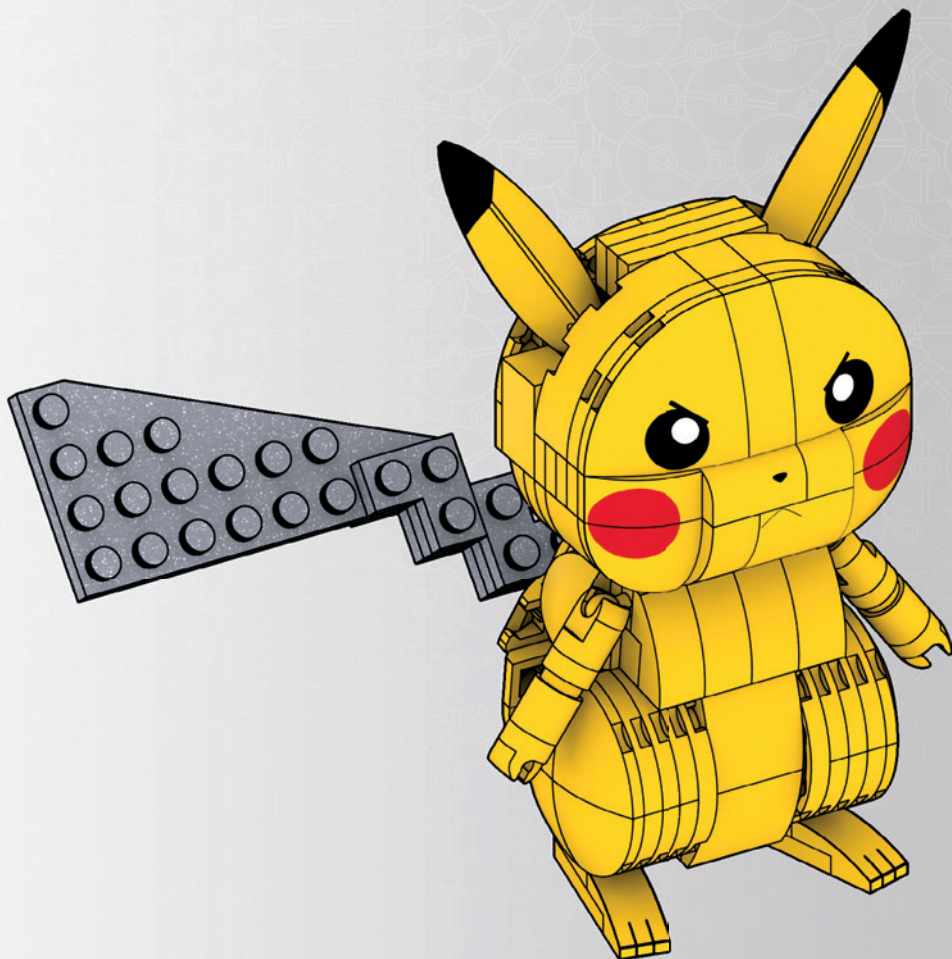





**POSE IT! / VARIEZ LES  
POSES! / ¡PÓSALO!  
VOCÊ PODE POSAR!  
LÄSST SICH IN COOLE  
POSEN BRINGEN!  
МЕНЯЙ ПОЗЫ!**





1x  
AM17003AMC



1x  
AM17003B



2x  
AM81248BYE



3x  
AM07223BYE



7x  
AM03328BYE



2x  
AM77574BLG



1x  
AM17787BYE



2x  
AM79377BYE



2x  
AM01312BYE



2x  
AM01140BYE



1x  
AM78296AWB



2x  
AM78297BYE



2x  
AM78275BYE



2x  
AM80144BYE



2x  
AM01086BYE



2x  
AM19530BYE



2x  
AM78391BYE



2x  
AM79246BYE



11x  
AM09393BYE



7x  
AM16680BYE



1x  
AM74427BYE



1x  
AM74426BYE



4x  
AM17788BYE



2x  
AM01322BYE



5x  
AM09013BYE



1x  
AM18601AMC



1x  
AM18601B



1x  
AM16682BYE



26x  
AM04322BYE



10x  
AM15484BYE



5x  
AM15484AWB



1x  
AM73009AMC



1x  
AM73009B



1x  
AM73009BYE



4x  
AM03773BYE



4x  
AM01146BYE



1x  
AS-GMD31-02



1x  
AS-GMD31-04



2x  
AS-GMD31-14



2x  
AS-GMD31-11



1x  
AS-GYH06-03



2x  
AM74106BYE



1x  
AS-GMD31-15



1x  
AS-GMD31-12



1x  
AS-GMD31-13



1x  
AS-GMD31-03



1x  
AS-GMD31-01



1x  
AM79227BYE



1x  
AM79796BYE



2x  
AM17153BYE



2x  
AM02212BYE



1x  
AM78276AWB



4x  
AM03772BYE



4x  
AM03772BLG



4x  
AM07230BYE



4x  
AM72600BYE



1x  
AM01314BLG



1x  
AM80143BYE



1x  
AS-GYH06-04



10x  
AM76525BYE



2x  
AM80799BYE



2x  
AM80634BYE



2x  
AM17056BYE



2x  
AM09493BYE



1x  
AM18299BYE



1x  
AM18299BLG



2x  
AM73003BYE



2x  
AM19324BYE



1x  
AM01087BYE



1x  
AM09033BYE



1x  
AS-GMD31-17



1x  
AS-GMD31-16





1x  
AS-GYH06-02



1x  
AS-GYH06-01



2x  
AM76367BYE



1x  
AM17076AWB

## Missing pieces? Pièces manquantes?

¿Partes faltantes? • Perdeu peças?  
Fehlen Teile? • Не хватает деталей?

support.megabrand.com

**ATTENTION** : DANGER  
D'ÉTOUFFEMENT. - PRÉSENCE DE PETITS  
ÉLÉMENTS. NE CONVIENT PAS AUX ENFANTS DE  
MOINS DE 3 ANS.

**ATENÇÃO!** NÃO INDICADO / NÃO  
RECOMENDÁVEL PARA CRIANÇAS MENORES DE 3  
(TRÊS) ANOS POR CONTER PARTE(S) PEQUENA(S)  
QUE PODE(M) SER ENGOLIDA(S) OU ASPIRADA(S)  
PODENDO PROVOCAR ASFIXIA.

警告:

のどに詰まる危険 小さな部品が含まれています  
3歳以下の子供には与えないで下さい。

**警告!**

不适合3岁以下儿童使用。  
内含小零件。

⚠ WARNING : CHOKING HAZARD. - Small parts.

Not for children under 3 years.

ADVERTENCIA: PELIGRO DE ATRAGANTAMIENTO. Jugete no recomendado  
para menores de 3 años, porque contiene piezas pequeñas que podrían  
provocar asfixia en caso de ser ingeridas o inhaladas por el/a niño/a.

AVVERTENZA: Contiene pezzi di piccole dimensioni.

ACHTUNG: Kleine Teile.

OSTRZEŻENIE: Małe części. Niebezpieczeństwo zadławienia.

WAARSCHUWING: Kleine onderdelen

ПРЕДУПРЕЖДЕНИЕ: Мелкие детали.

ADVARSEL: Indeholder små dele.

WARNING: Smådelar

ADVARSEL: Små deler

VAROITUS: Pieniä osia

ΠΡΟΣΟΧΗ: Περιλαμβάνονται μικρά κομμάτια.

UVARI: Küçük parçalar.

UPOZORNĚNÍ: Malé díly

UPOZORNENIE: Malé časti

FIGYELMEZTETÉS: Kis alkatrészek.



0-3

تحذير:

غير مناسبة للأطفال دون 36 شهراً - قطع صغيرة.

Build & Show Pikachu Evolution Trio / Créer et montrer les trois évolutions de Pikachu / Construye y muestra - Evoluciones de Pikachu / Construa e mostre - Evoluções do Pikachu /  
Costruisci e mostra Pikachu Evolution Trio / Bauen & Zeigen Pikachu Evolution Trio / Buduj i pokaż Pikachu zestaw trzech form / Bouw en laat Pikachu Evolution Trio zien / Построй и  
покажи Pikachu Тройная Эволюция / Κατασκευή & Εμφάνιση Pikachu Evolution Trio / Pikachu Evrim Üçlüsünü Birleştir ve Göster / Pikachu Evolução trio építés e megjelenítése /  
Bygg och visa Pikachu utvecklings-trio / Rakenna & näytä Pikachu-evoluutiokolmikko / Byg og vis Pikachu udviklingstrio / Bygg & Vis Pikachu Evolusjon Trio / Sestavte a předvedte  
trojici figurek Pikachu Evolution / Vytvorte a ukážete evolučné trio Pikachu / بناء وعرض تطور Pikachu الثلاثي

Mattel Europa B.V., Gondel 1, 1186 MJ Amstelveen, Nederland. Mattel U.K. Limited, The Porter Building, 1 Brunel Way, Slough SL1 1FQ, UK. Mattel France, Parc de la Cerisaie, 1/3/5 allée des Fleurs, 94260 Fresnes Cedex. N° Cristal 0969 36 99 99 (Numéro non surtaxé) ou www.lesjouetsmattel.fr Mattel Belgium, Trade Mart, Atomiumsquare, Bogota 202 - B 275, 1020 Brussels. Grátis nummer België: 0800 - 16 936 - Grátis nummer Luxembourg: 800 - 22 784 - Grátis nummer Nederland: 0800 - 262 88 35. Deutschland: Mattel GmbH, Solmsstraße 83, D-60486 Frankfurt am Main. Schweiz: Mattel AG, Kirchstrasse 24, CH-3097 Liebefeld. Österreich: Mattel Ges.m.b.H., Campus 21, Liebermannstraße A01 404, A- 2345 Brunn/Gebrige. Mattel Italy Srl, Via Turati 4, 20121 Milano, Italy. Servizio assistenza clienti: Customersrv.italia@mattel.com - Numero verde 800 11 37 11. Mattel España, S.A, Aribau 200 pl. 9, 08036 Barcelona. cservice.spain@mattel.com. Tel: +34 933 06 79 00 http://www.service.mattel.com/es. Mattel East Asia Ltd., Room 503-09, North Tower, World Finance Centre, Harbour City, Tsimshatsui, HK, China. Tel: (852) 3185-6500. Diimport & Diedarkan Oleh: Mattel Continental Asia Sdn Bhd. Level 19, Tower 3, Avenue 7, No. 8 Jalan Kerinchi, Bangsar South, 59200 Kuala Lumpur, Malaysia. Mattel South Africa (PTY) LTD, Office 102 I3, 30 Melrose Boulevard, Johannesburg 2196. Dystrybutor: Mattel Poland Sp. z o.o., Warsaw Trade Tower 34 p., ul. Chłodna 51, 00-867 Warszawa. Mattel Australia Pty. Ltd., 658 Church St., Richmond, Victoria, 3121. Consumer Advisory Service - 1300 135 312. Mattel AEBE, Εθνόγυου Μακρίου 1, Κηφισό Κ-2, ΤΚ 17561, Παλιό Φάληρο. Mattel Oyuncakçılık Tic. Ltd. Şti. İçerenköy Mah., Umut Sok. No:10-12 Quick Tower Kat:2/15 34752 Ataşehir İstanbul Tel: 0216 570 75 00. Импортёр/Уполномоченная организация: ООО "МАТТЕЛ" Российская Федерация, 105120 Москва, 2-й Сыроматинский переулок, 1; +7 495 287 79 39. Mattel Czech Republic s.r.o., The Forum, Václavské nám. 19, 11000 Praha 1. Mattel, 333 Continental Boulevard, El Segundo, CA 90245, USA. Consumer Services: 1-800-465-MEGA (6342). Mattel Canada Inc., Mississauga, Ontario L5R 3W2. Consumer Services: You may call us free at/ Composez sans frais le 1-800-524-8697. Importado y distribuido por Mattel de México, S.A. de C.V., Miguel de Cervantes Saavedra No. 193, Pisos 10 y 11, Col. Granada, Alcaldía Miguel Hidalgo, C.P. 11520, México, Ciudad de México. R.F.C. MME-920701-NB3. Tels: 59-05-51-00 Ext. 5206 ó 01-800-463-59-89. Mattel Chile, S.A., Avenida Américo Vespucio 501-B, Quilicura, Santiago, Chile. Tel: 1230-020-6213. Servicio al consumidor Venezuela: Tel: 0-800-100-9123. Mattel Argentina, S.A., Av. Libertador 1000, Piso 11 - Oficinas 109 y 111, Vicente López - Prov. Buenos Aires, Tel: 0800-666-3373. Mattel Colombia, S.A., Calle 123#-07 P5, Bogotá. Tel: 01800-710-2069. Mattel Perú, S.A., Av. Juan de Arona # 151, Centro Empresarial Juan de Arona, Torre C, Piso 7, Oficina 704, San Isidro, Lima 27, Perú. RUC: 20425853865. Reg. Importador: 02350-12-JUE-DIGESA. Tel: 0800-54744. E-mail Latinoamérica: servicio.clientes@mattel.com. Mattel do Brasil Ltda. - CNPJ: 54.558.002/0001-20 - Rua Verbo Divino, 1488 - 2º. Andar - 04719-904 - Chácara Santo Antônio - São Paulo - SP - Brasil. Serviço de Atendimento ao Consumidor: fone 0800 575 0780. E-mail: sac.matteldobrazil@mattel.com



# POKÉMON

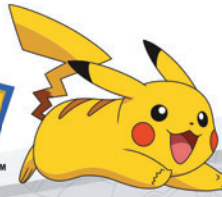

GMD31



HDL84

Set(s) sold separately and subject to availability. / Ensemble(s) vendu(s) séparément. Certains produits peuvent ne pas être commercialisés. / Se vende(n) por separado y está(n) sujeto(s) a disponibilidad. / Conjunto(s) vendido(s) em separado e sujeito(s) à disponibilidade. / Set in vendita separatamente, secondo disponibilità. / Das/Die Set(s) sind separat erhältlich. / Zestaw(y) sprzedawany(e) oddzielnie w zależności od dostępności. / Set(s) apart verkrijgbaar en afhankelijk van beschikbaarheid. / Набор(-ы) продаются отдельно, при наличии. / Sæt sælges separat og så længe lager haves. / Seten säljs separat så länge lagret räcker. / Settet/settene selges separat så langt lageret rekker. / Pakkaus/pakkausset myydään erikseen, saatavuus voi vaihdella. / Το(α) σετ πωλούνται ξεχωριστά και ανάλογα με τη διαθεσιμότητα. / Setler ayrı olarak satılır ve stoklarla sınırlıdır. / Set (sety) se prodává (prodávají) samostatně dle aktuální nabídky. / Сўправа/-y sa predáva(jú) samostatne a podľa dostupnosti. / A készlet(ek) külön kapható(k), az elérhetőség változhat. / セット商品は別売りになります。在庫状況は別途ご確認をお願いします。 / نباع المجموعة أو المجموعات على حدة وتخضع لتوافرها. / 每套单独发售，按供货情况决定。

Set(s) sold separately and subject to availability. / Ensemble(s) vendu(s) séparément. Certains produits peuvent ne pas être commercialisés. / Se vende(n) por separado y está(n) sujeto(s) a disponibilidad. / Conjunto(s) vendido(s) em separado e sujeito(s) à disponibilidade. / Set in vendita separatamente, secondo disponibilità. / Das/Die Set(s) sind separat erhältlich. / Zestaw(y) sprzedawany(e) oddzielnie w zależności od dostępności. / Set(s) apart verkrijgbaar en afhankelijk van beschikbaarheid. / Набор(-ы) продаются отдельно, при наличии. / Sæt sælges separat og så længe lager haves. / Seten säljs separat så länge lagret räcker. / Settet/settene selges separat så langt lageret rekker. / Pakkaus/pakkausset myydään erikseen, saatavuus voi vaihdella. / Το(α) σετ πωλούνται ξεχωριστά και ανάλογα με τη διαθεσιμότητα. / Setler ayrı olarak satılır ve stoklarla sınırlıdır. / Set (sety) se prodává (prodávají) samostatně dle aktuální nabídky. / Сўправа/-y sa predáva(jú) samostatne a podľa dostupnosti. / A készlet(ek) külön kapható(k), az elérhetőség változhat. / セット商品は別売りになります。在庫状況は別途ご確認をお願いします。 / نباع المجموعة أو المجموعات على حدة وتخضع لتوافرها. / 每套单独发售，按供货情况决定。

نباع المجموعة أو المجموعات على حدة وتخضع لتوافرها. / 每套单独发售，按供货情况决定。



Mattel Canada Inc. Mississauga, Ontario L5R 3W2.  
MADE IN CHINA. FABRIQUÉ EN CHINE. FABRICADO NA CHINA. HECHO EN CHINA.  
ИЗГОТОВЛЕНО В КИТАЕ. ÇIN'DE ÜRETİLMİŞTİR. صنع في الصين

© D781,964, D797,203, D799,607, D834,105

1186 MJ, 1, NL

©2022 MEGA Brands &™ MEGA Brands.  
Printed in China / Imprimé en Chine

AD-GYH06-05A





LEGO  
**MEGA**

**POKÉMON**



**BUILD & SHOW PIKACHU  
EVOLUTION TRIO  
CRÉER ET MONTRER LES TROIS  
ÉVOLUTIONS DE PIKACHU**

CONSTRUYE Y MUESTRA - EVOLUCIONES DE PIKACHU / CONSTRUA E MOSTRE - EVOLUÇÕES DO PIKACHU

GYH06





# Build Construisez

Construye | Constrói  
Bauen | Стройте



# Share | Partagez

Comparte | Partilha  
Teilen | Делитесь



# Easy-to-follow steps!

# Des instructions faciles à suivre !

¡Pasos fáciles de seguir!  
Passos fáceis de seguir!  
Einfache Schritte!  
Простые действия!



Devices not included | Appareils non inclus | Dispositivos no incluído | Dispositivos  
não incluídos | Geräte nicht enthalten | Устройства не входят в комплект



[megaunboxed.com](https://megaunboxed.com)

1

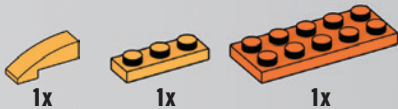

1x

1x

1x

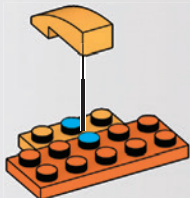

2

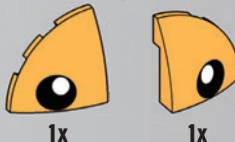

1x

1x

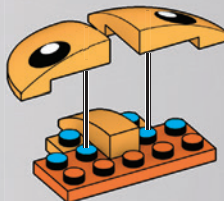

3

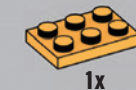

1x

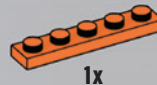

1x

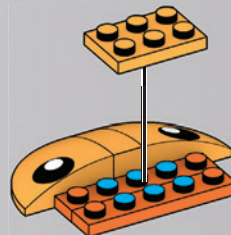

4



1x

1x

1x

1x

5



1x

2x

6



2x

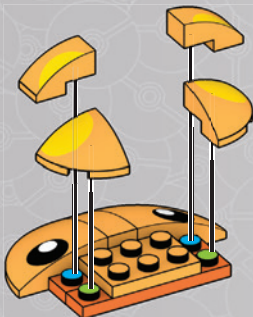

1



2

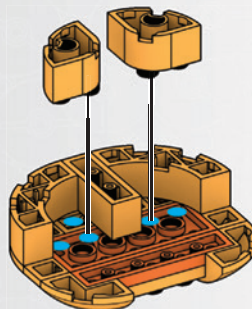
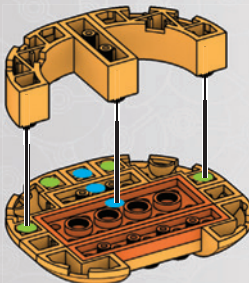

7



2x

2x

8



1x

1x

9



2x

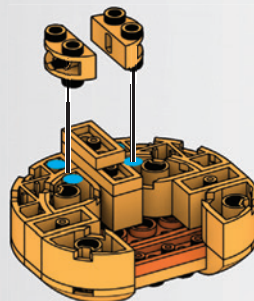
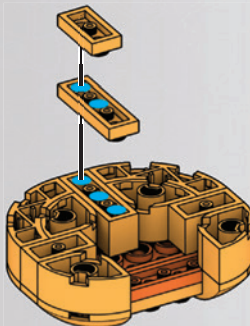
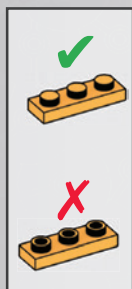
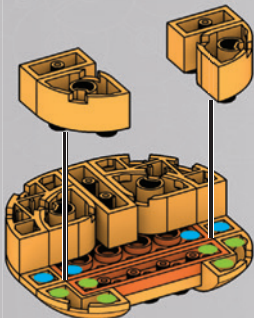

10

2x



1x



1x

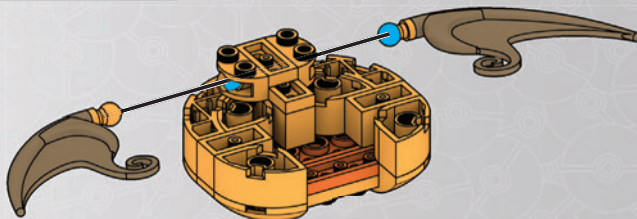
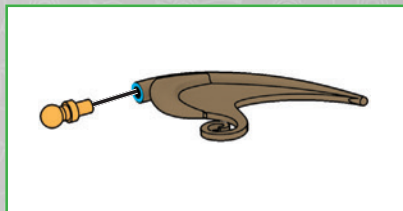

1

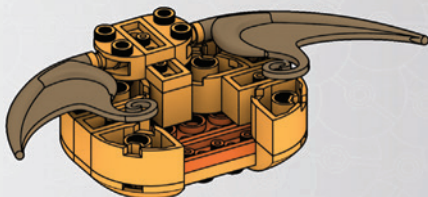

2

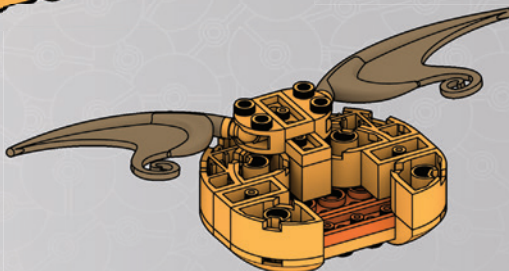

3

11



2x



2x

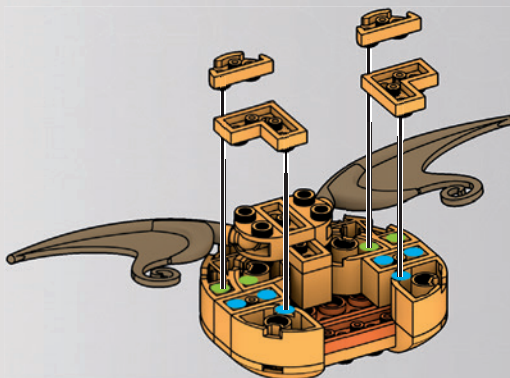





15

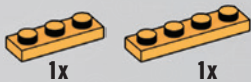

1x

1x

16



2x

1x

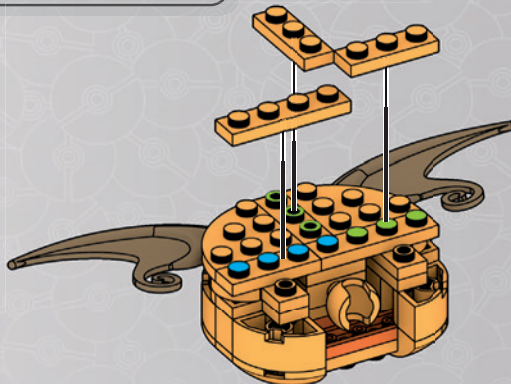
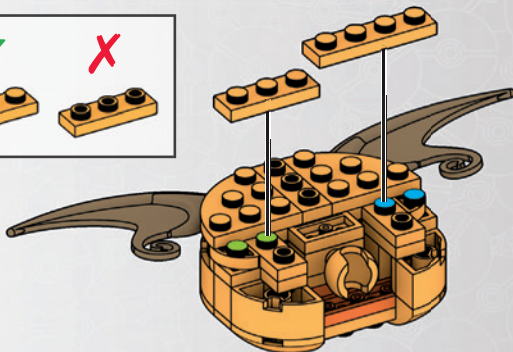
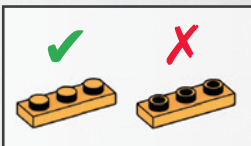
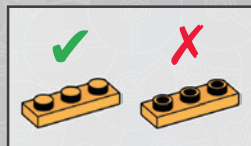

17



2x

18



1x

1x

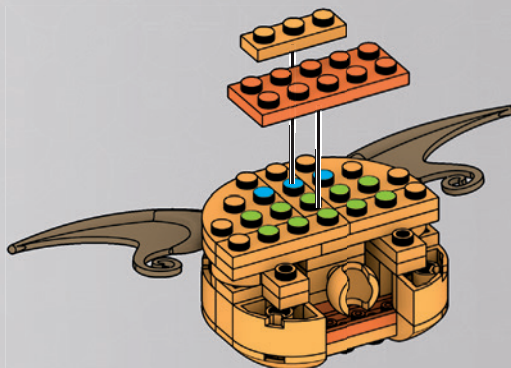
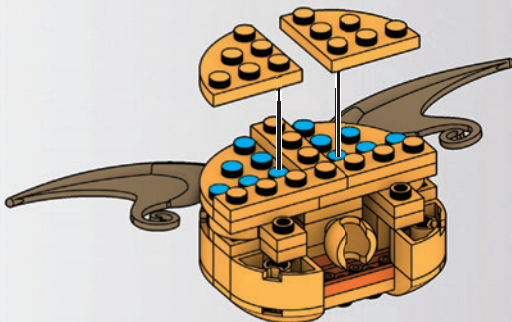
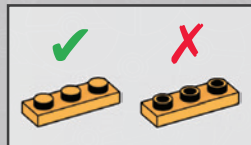

19

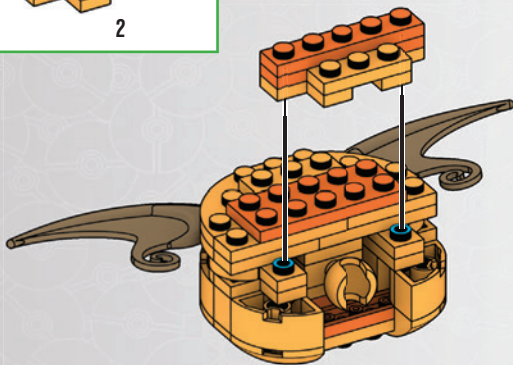
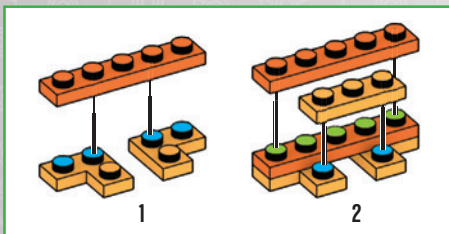
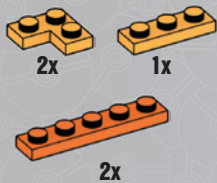

20

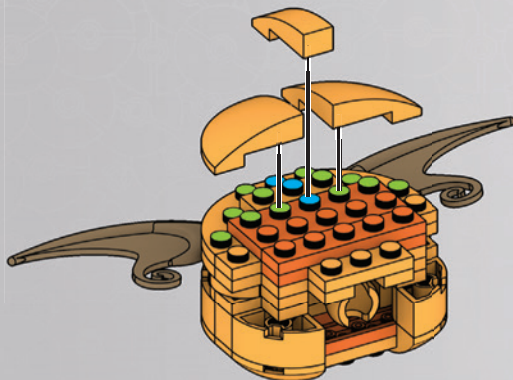

21

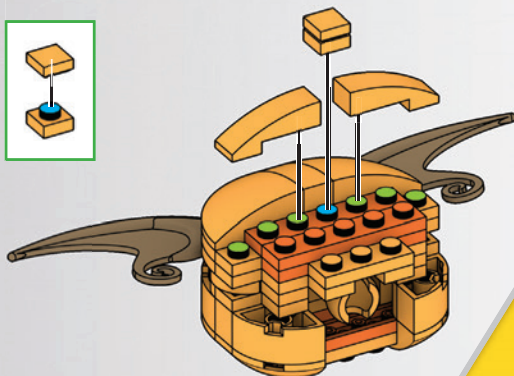
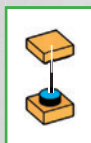



22



3x

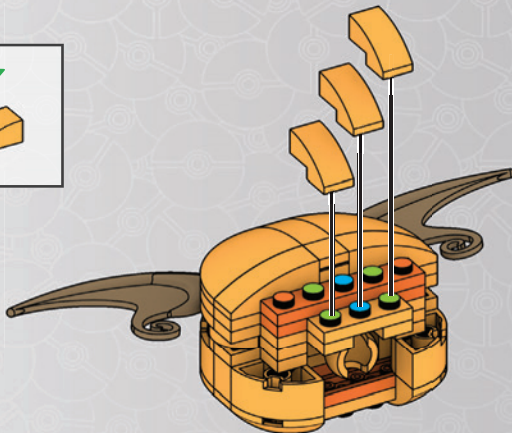
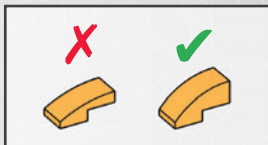

23



4x



2x



x2

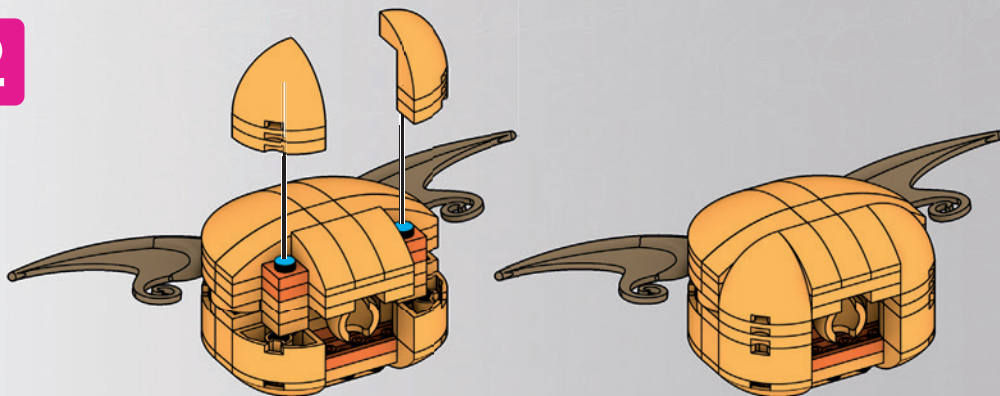

1

2

24



1x



1x

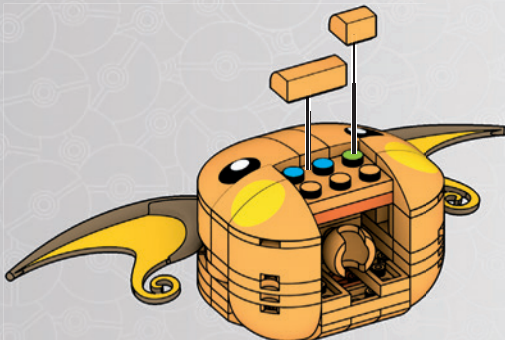

25



1x



1x

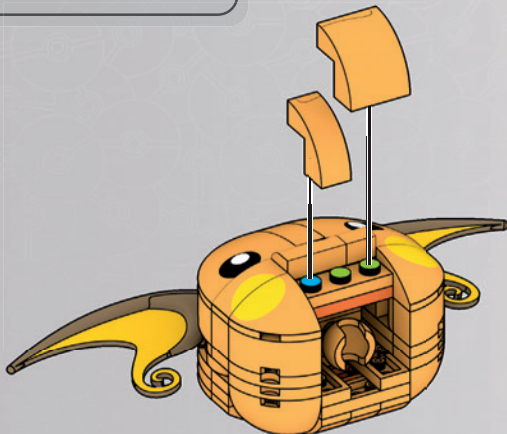
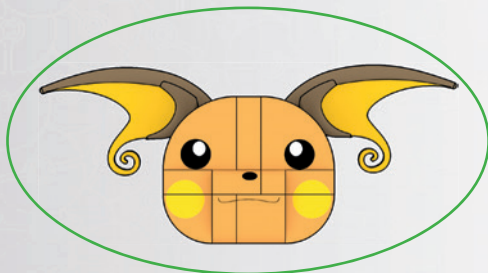

1

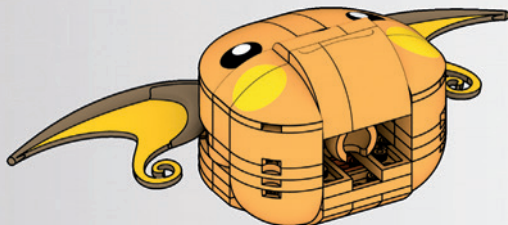

2

26

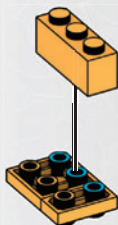
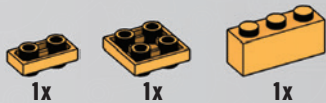

27

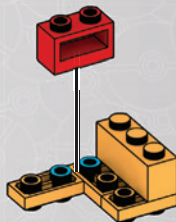

28

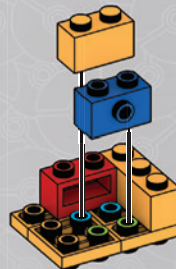

29

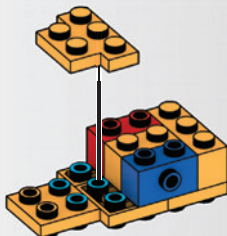
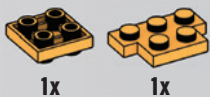

30

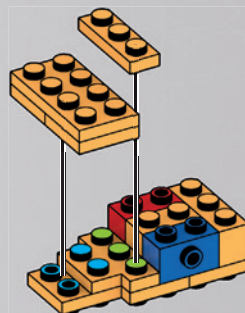
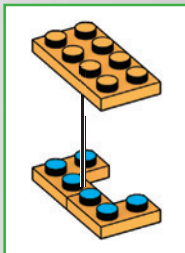
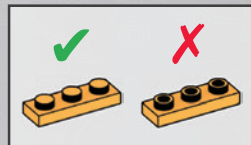
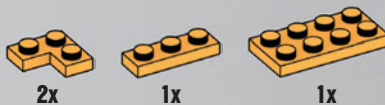



31

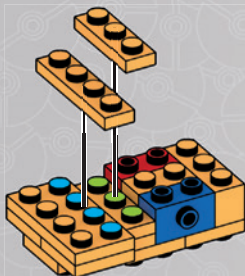
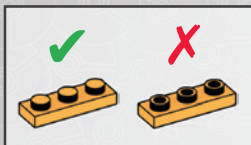

1

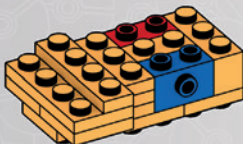

2

32

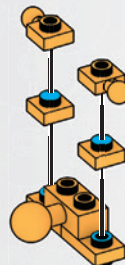
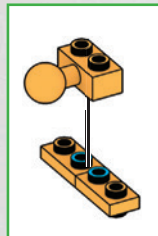
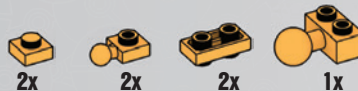

33

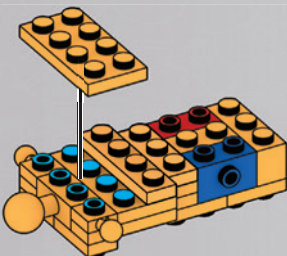
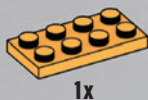

34

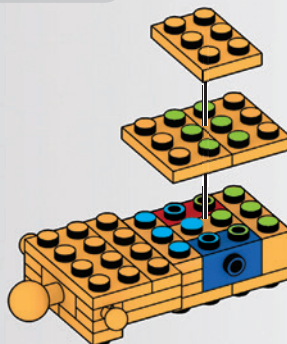

35



1x



1x



1x



1x

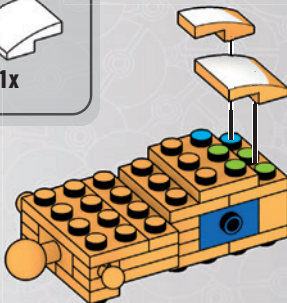

1

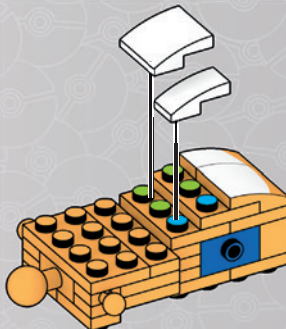

2

36



1x



1x



1x

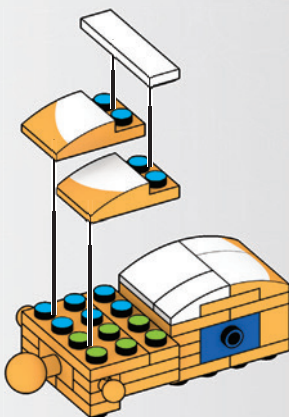

1

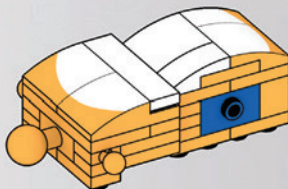

2

37



2x

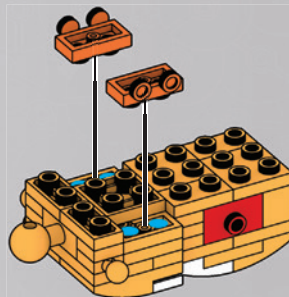

38

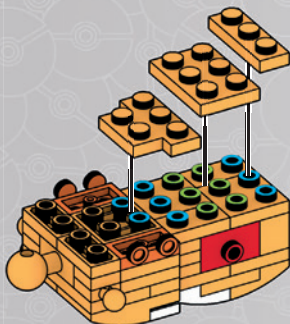
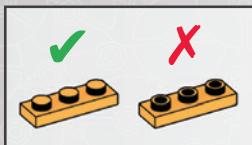
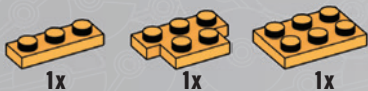

39

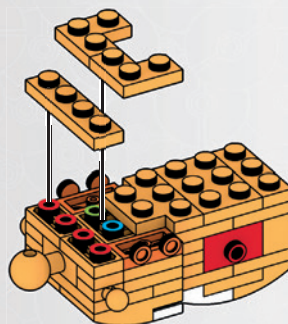

40

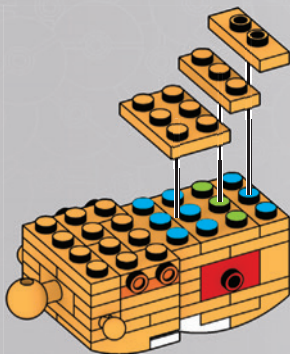
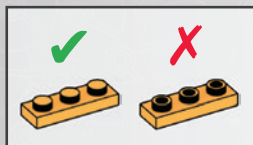
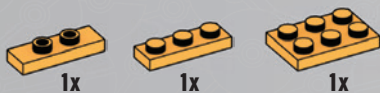

41

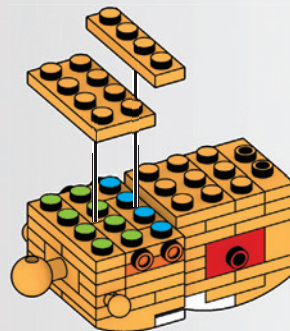



42



3x

1x

1x

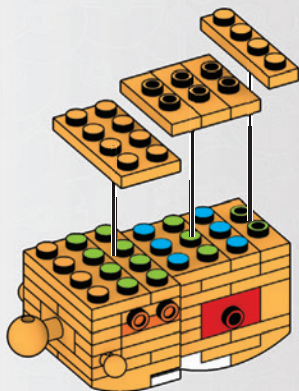

43



1x

1x

1x

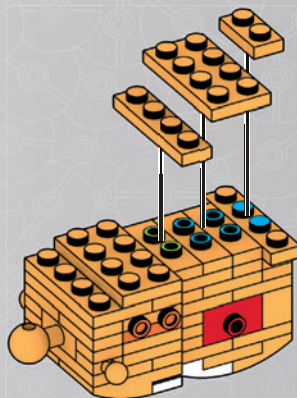

44



1x

1x

2x

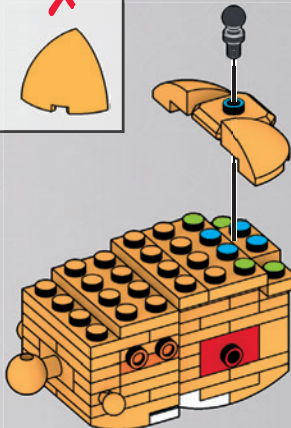

45



2x

46



1x



1x

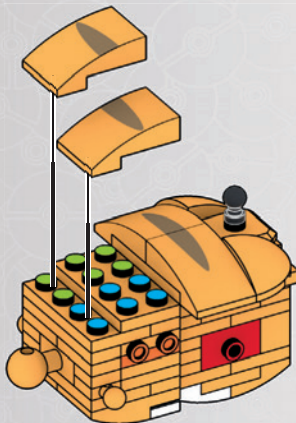
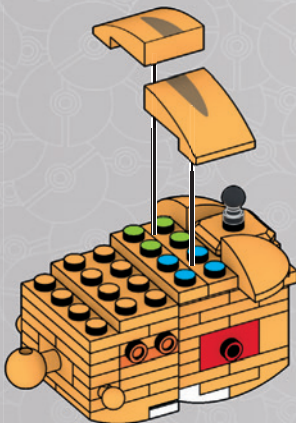

1

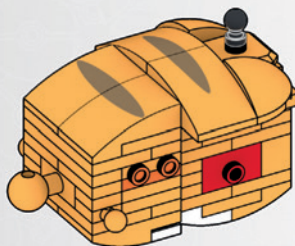

2

47



1x



1x



1x



1x



1x



1x

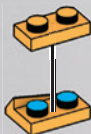
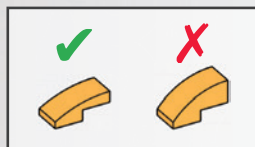
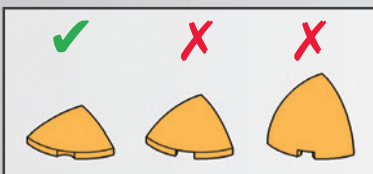

1



2

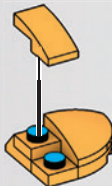

3



4

48



1x



1x



1x



1x



1x



1x

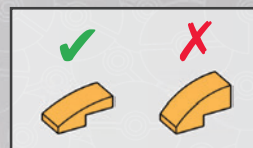

1



2



3



4

49



48

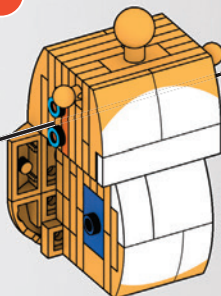

47

50



1x



1x

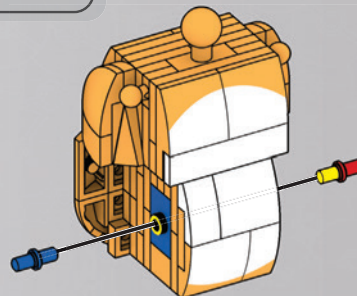



51

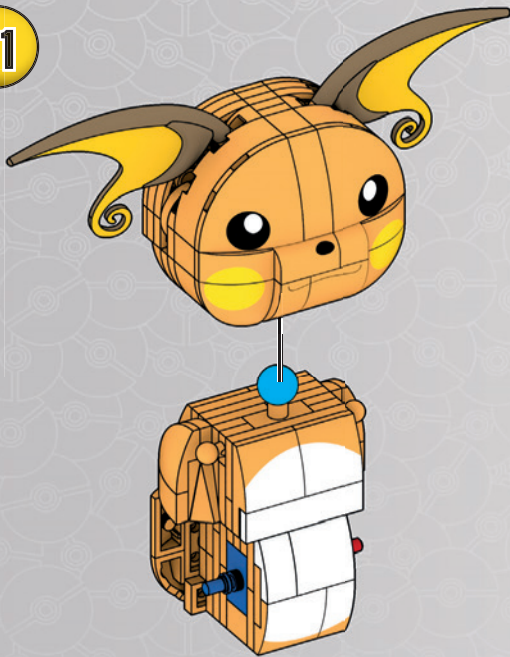

1



2

52



1x

1x

3x

1x

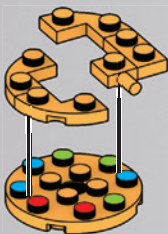

53



4x

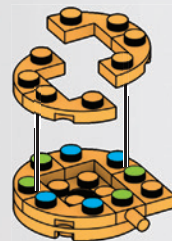

54



4x

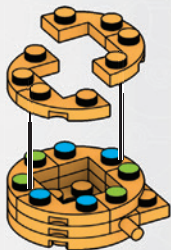

55



1x



4x



1

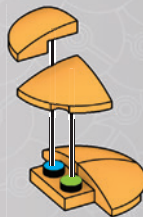

2



3

56



1x



1x

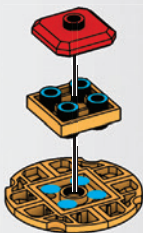

1



2

57

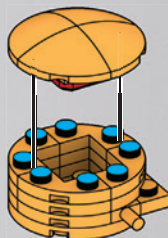

1

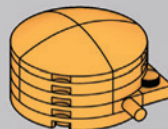

2

58

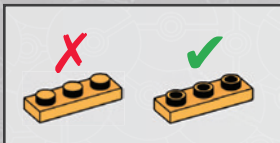

1

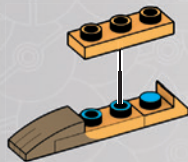

2

59

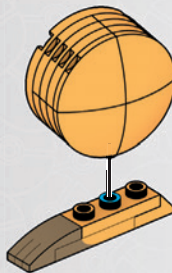

1

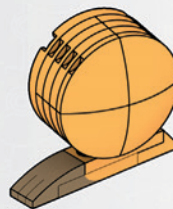

2

60

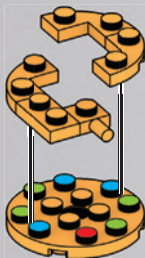

61

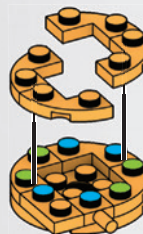



62



4x

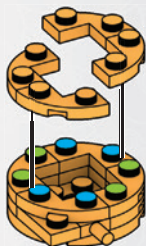

63



1x



4x



1

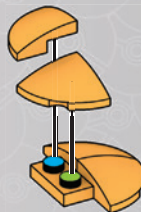

2



3

64



1x



1x

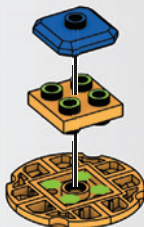

1



2

65

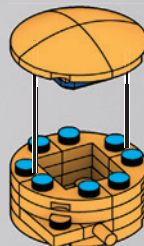

1

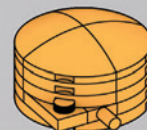

2

66

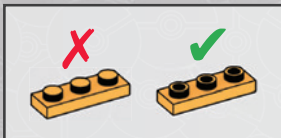

1

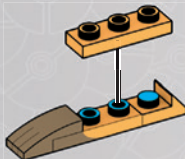

2

67

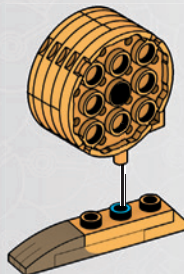

1

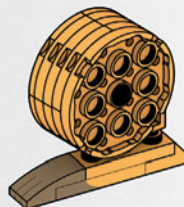

2

68

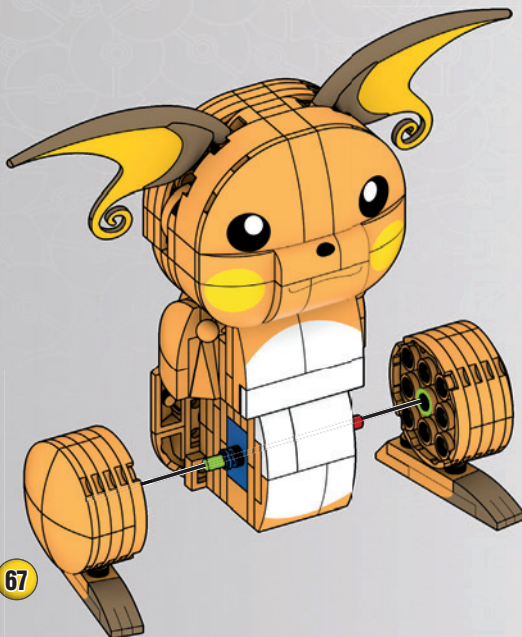

67

59

69



2x



2x



2x



2x

x2

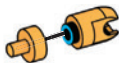

1

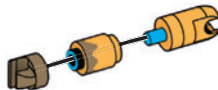

2



3



1



2



3



70

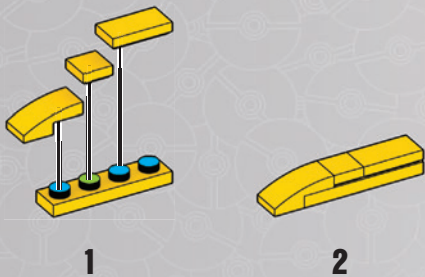

71

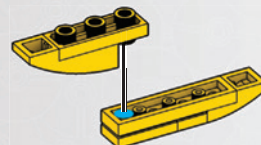
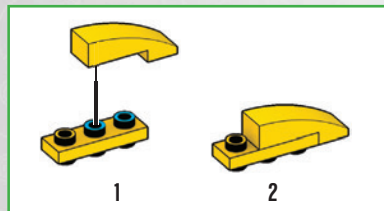

72

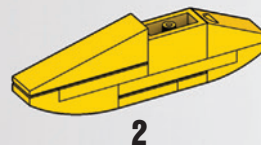
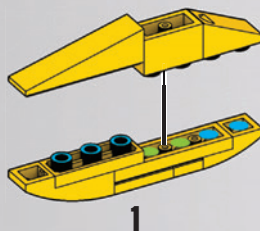
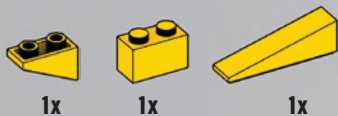

73

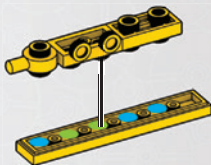
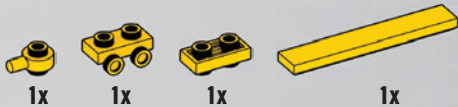

74

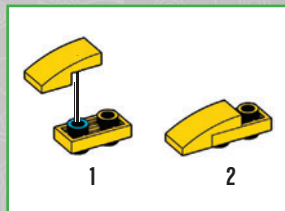
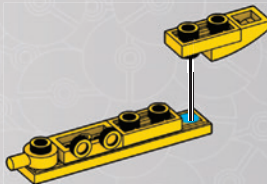

75

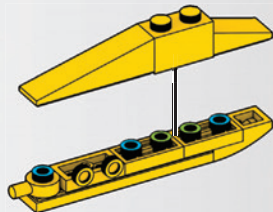
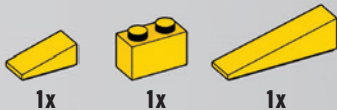

1

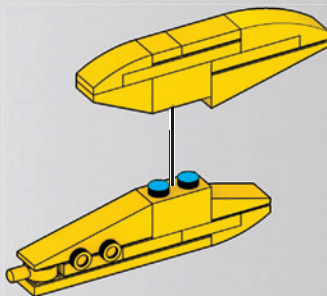

2

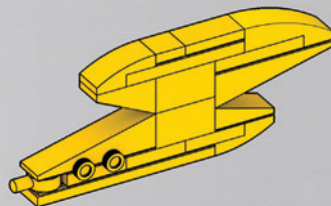

3

76



1x



4x

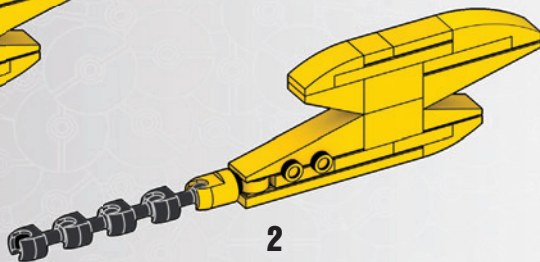
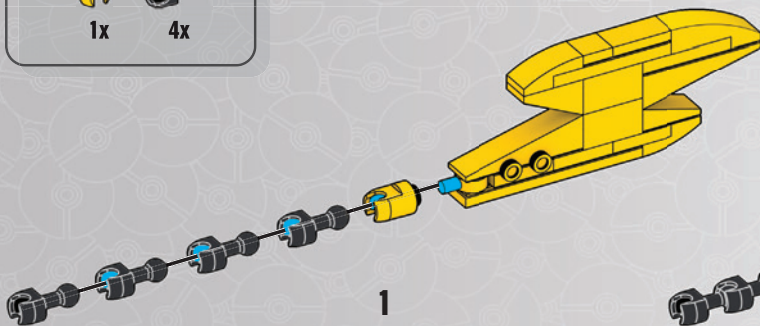

77



5x

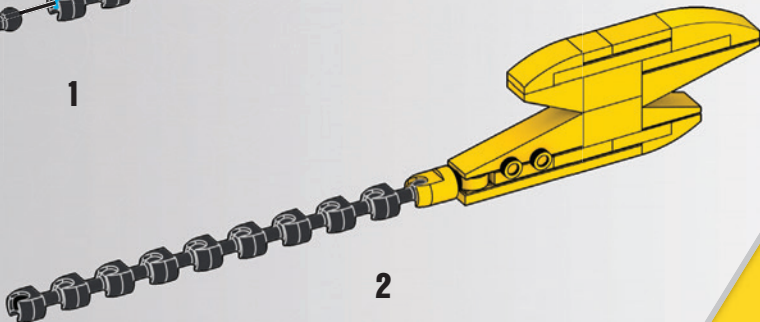
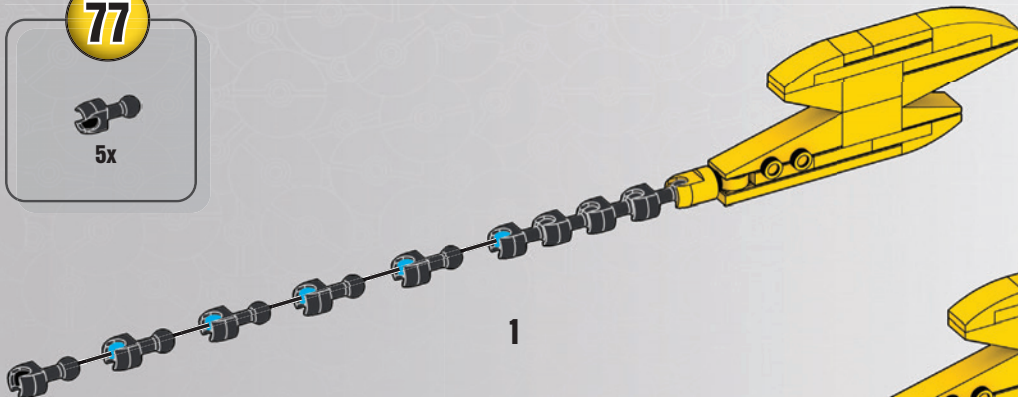



78



1x



1x



4x

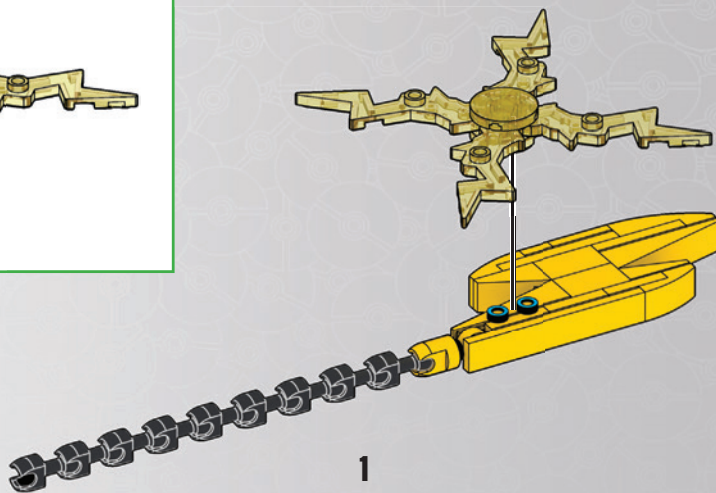
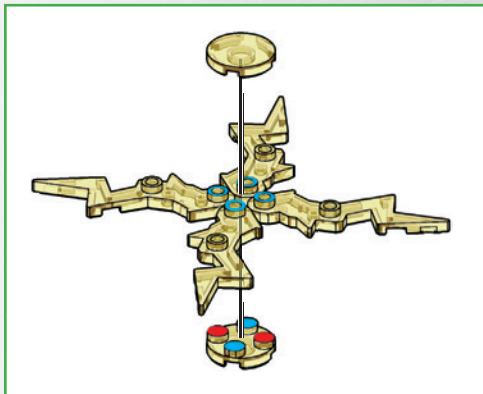

1

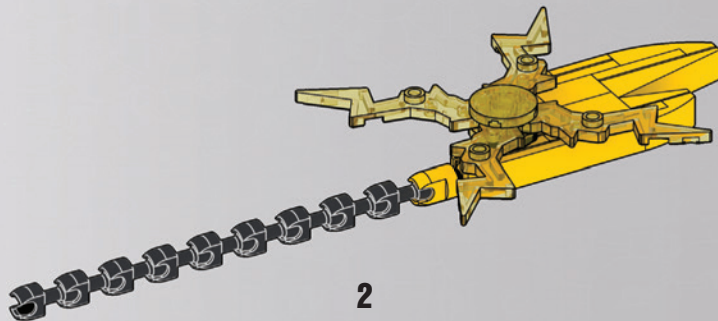

2

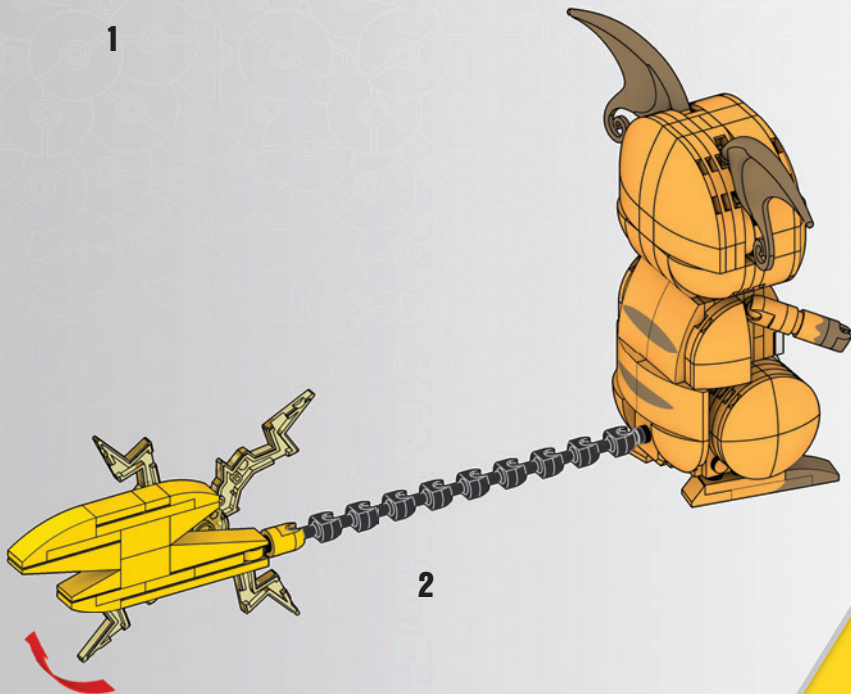
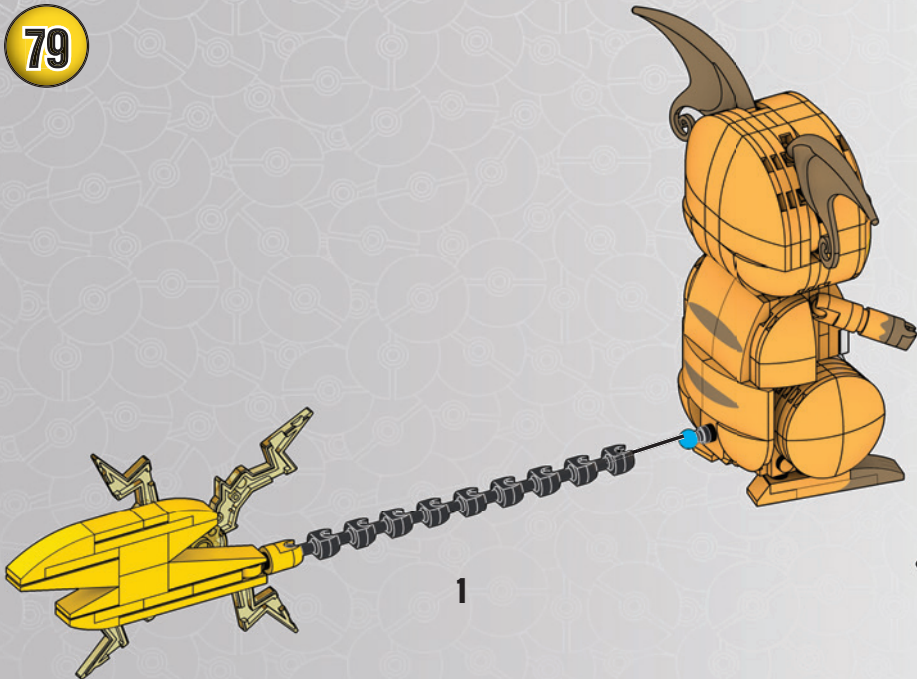

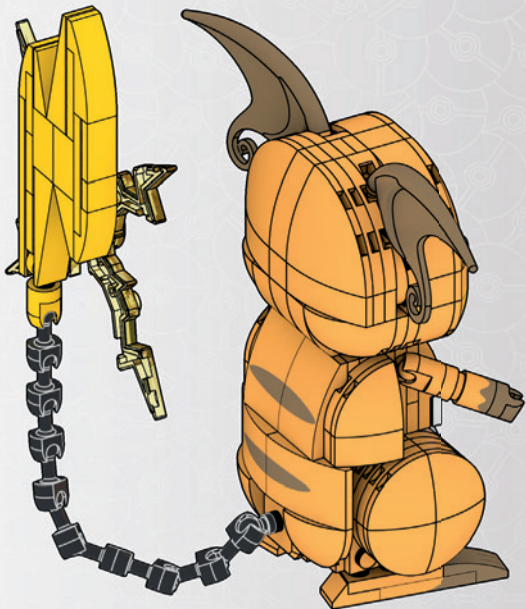

3

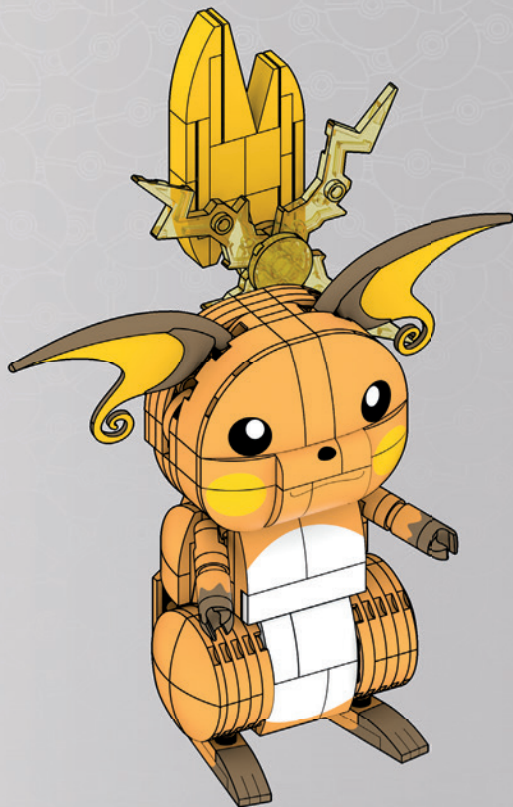

4





**POSE IT! / VARIEZ LES  
POSES! / ¡PÓSALO!  
VOCÊ PODE POSAR!  
LÄSST SICH IN COOLE  
POSEN BRINGEN!  
МЕНЯЙ ПОЗЫ!**



1



2

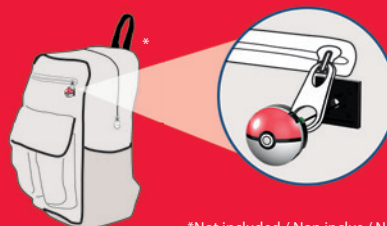

\*Not included / Non inclus / No incluido  
não incluído / Nicht enthalten / не входит



1x AM17003B  
 1x AM17003AMC  
 2x AM81248FM  
 1x AM07223FM  
 1x AM07223BYE  
 5x AM03328FM  
 2x AM78297ASE  
 1x AM17787FM  
 2x AM78291FM  
 1x AM78291AYB  
 1x AM80010BYE  
 2x AM01140FM  
 2x AM79377FM  
 2x AM19530FM  
 9x AM78290AYB  
 2x AM78275FM

1x AM78275BYE  
 2x AS-GYH06-26  
 2x AM78391FM  
 2x AM79375FM  
 1x AM022501BYE  
 1x AM07590BOR  
 7x AM09393FM  
 4x AM16680FM  
 2x AM16680BYE  
 1x AM76467BYE  
 2x AM76467BOR  
 1x AM15480FM  
 1x AM15481FM  
 1x AM17128BYE  
 1x AM02215ZD

1x AS-GYH06-36  
 1x AM74677ZD  
 1x AM79018F  
 2x AM78281FM  
 1x AM18710BYE  
 1x AM18601B  
 1x AM18601AMC  
 3x AM09013FM  
 2x AM09013BYE  
 1x AS-GYH06-24  
 1x AS-GYH06-23  
 8x AM15484FM  
 28x AM04322FM  
 1x AM78486E

2x AM78486BYE  
 2x AM78486FM  
 1x AS-GYH06-30  
 2x AS-GYH06-32  
 1x AS-GYH06-19  
 1x AS-GYH06-21  
 3x AM17788FM  
 1x AM73009B  
 1x AM73009FM  
 1x AM73009AMC  
 1x AM79017F  
 2x AM03773FM  
 5x AM01146FM  
 10x AM76525FM

1x AM74106E  
 1x AS-GYH06-29  
 1x AS-GYH06-25  
 4x AM02212FM  
 1x AM79796FM  
 1x AM79227FM  
 1x AS-GYH06-20  
 1x AS-GYH06-22  
 2x AM80634FM  
 2x AM80799FM  
 1x AS-GYH06-27  
 1x AS-GYH06-28

1x AS-GYH06-33  
 1x AS-GYH06-34  
 2x AS-GYH06-35  
 4x AM74298FM  
 2x AM72600FM  
 2x AS-GYH06-31  
 11x AM01314FM  
 3x AM80143FM  
 1x AM80143BYE  
 2x AM16384FM  
 3x AM77465FM  
 6x AM03772FM  
 4x AM17056FM

4x AM07230FM  
 1x AM07230BYE  
 7x AM09593FM  
 1x AM09593BYE  
 1x AM09838E  
 5x AM09493FM  
 2x AM76367FM  
 1x AS-GYH06-17  
 1x AS-GYH06-18  
 2x AM19324FM  
 2x AM73003FM  
 2x AM16959BYE  
 3x AM07475BOR

**Missing pieces?  
Pièces manquantes?**  
¿Partes faltantes? • Perdeu peças?  
Fehlen Teile? • Не хватает деталей?

[support.megabrand.com](http://support.megabrand.com)



4x  
AM78389ZD



1x  
AM16331BYE



2x  
AM80965BOR



1x  
AS-GYH06-15



1x  
AS-GYH06-16

**ATTENTION :** DANGER  
D'ÉTOUFFEMENT. - PRÉSENCE DE PETITS  
ÉLÉMENTS. NE CONVIENT PAS AUX ENFANTS DE  
MOINS DE 3 ANS.

**ATENÇÃO!** NÃO INDICADO / NÃO  
RECOMENDÁVEL PARA CRIANÇAS MENORES DE 3  
(TRÊS) ANOS POR CONTER PARTE(S) PEQUENA(S)  
QUE PODE(M) SER ENGOLIDA(S) OU ASPIRADA(S)  
PODENDO PROVOCAR ASFIXIA.

警告:

のどにつまる危険 小さな部品が含まれています  
3歳以下の子供には与えないで下さい。

**警告!**

不适合3岁以下儿童使用。  
内含小零件。

⚠️ **WARNING : CHOKING HAZARD.** - Small parts.

Not for children under 3 years.

**ADVERTENCIA:** PELIGRO DE ATRAGANTAMIENTO. Juguete no recomendado para menores de 3 años, porque contiene piezas pequeñas que podrían provocar asfixia en caso de ser ingeridas o inhaladas por el/la niño/a.

**AVVERTENZA:** Contiene pezzi di piccole dimensioni.

**ACHTUNG:** Kleine Teile.

**OSTRZEŻENIE:** Małe części. Niebezpieczeństwo zadławienia.

**WAARSCHUWING:** Kleine onderdelen

**ПРЕДУПРЕЖДЕНИЕ:** Мелкие детали.

**ADVARSEL:** Indeholder små dele.

**WARNING:** Smådelar

**ADVARSEL:** Små deler

**VAROITUS:** Pieniä osia

**ΠΡΟΣΟΧΗ:** Περιλαμβάνονται μικρά κομμάτια.

**UVARI:** Kicsikrészletek.

**UPOZORNĚNÍ:** Malé díly

**UPOZORNENIE:** Malé časti

**FIGYELMEZTETÉS:** Kis alkatrészek.



0-3

تحذير:

غير مناسبة للأطفال دون 36 شهراً - قطع صغيرة.

Build & Show Pikachu Evolution Trio / Créer et montrer les trois évolutions de Pikachu / Construye y muestra - Evoluciones de Pikachu / Construa e mostre - Evoluções do Pikachu / Costruisci e mostra Pikachu Evolution Trio / Bauen & Zeigen Pikachu Evolution Trio / Buduj i pokaż Pikachu zestaw trzech form / Bouw en laat Pikachu Evolution Trio zien / Построй и покажи Pikachu Тройная Эволюция / Κατασκευή & Εμφάνιση Pikachu Evolution Trio / Pikachu Evrim Üçlüsünü Birleştir ve Göster / Pikachu Evolução Trio épitése és megjelentesítse / Bygg och visa Pikachu utvecklings-trio / Rakenna & näytä Pikachu-evoluutiokolmikikko / Byg og vis Pikachu udviklingstrio / Bygg & Vis Pikachu Evolusjon Trio / Sestavte a předvedte trojici figurek Pikachu Evolution / Vytvorite a ukážte evolučné trio Pikachu / البناء وعرض تطور Pikachu الثلاثي

Mattel Europa B.V., Gondel 1, 1186 MJ Amstelveen, Nederland. Mattel U.K. Limited, The Porter Building, 1 Brunel Way, Slough SL1 1FQ, UK. Mattel France, Parc de la Cerisaie, 1/3/5 allée des Fleurs, 94260 Fresnes Cedex. N° Cristal 0969 36 99 99 (Numéro non surtaxé) ou [www.lesjouetsmattel.fr](http://www.lesjouetsmattel.fr) Mattel Belgium, Trade Mart, Atomiumsquare, Bogota 202 - B 275, 1020 Brussels. Gratis nummer België: 0800 - 16 936 - Gratis nummer Luxemburg: 800 - 22 784 - Gratis nummer Nederland: 800 - 262 88 35. Deutschland: Mattel GmbH, Solmsstraße 83, D-60486 Frankfurt am Main. Schweiz: Mattel AG, Kirchstrasse 24, CH-3097 Liebefeld. Österreich: Mattel Ges.m.b.H., Campus 21, Liebermannstraße A01 404, A- 2345 Brunn/Gebirge. Mattel Italy Srl, Via Turati 4, 20121 Milano, Italy. Servizio assistenza clienti: [CustomerService.italy@mattel.com](mailto:CustomerService.italy@mattel.com) - Numero verde 800 11 37 11. Mattel España, S.A., Aribau 200 pl. 9, 08036 Barcelona. [csevice.spain@mattel.com](mailto:csevice.spain@mattel.com) Tel: +34 933 06 79 00 <http://www.service.mattel.com/es>. Mattel East Asia Ltd., Room 503-09, North Tower, World Finance Centre, Harbour City, Tsimshatsui, HK, China. Tel: (852) 3185-6500. Diiport & Diedarkan Oleh: Mattel Continental Asia Sdn Bhd. Level 19, Tower 3, Avenue 7, No. 8 Jalan Kerinchi, Bangsar South, 59200 Kuala Lumpur, Malaysia. Mattel South Africa (PTY) LTD, Office 102 I3, 30 Melrose Boulevard, Johannesburg 2196. Diiytributor: Mattel Poland Sp. z o.o., Warsaw Trade Tower 34 p., ul. Chłodna 51, 00-867 Warszawa. Mattel Australia Pty. Ltd., 658 Church St., Richmond, Victoria, 3121. Consumer Advisory Service - 1300 135 312. Mattel AEBE, Εθνάρχου Μακαρίου 1, Κτήριο Κ-2, ΤΚ 17561, Παλαιό Φάληρο. Mattel Oyuncakçılık Tic. Ltd. Şti. İçerenköy Mah., Umut Sok. No:10-12 Quick Tower Kat:2/15 34752 Ataşehir İstanbul Tel: 0216 570 75 00. Импортёр/Уполномоченная организация: ООО "МАТТЕЛ" Российская Федерация, 105120 Москва, 2-й Сыромятинский переулоч, 1; +7 495 287 79 39. Mattel Czech Republic s.r.o., The Forum, Václavské nám. 19, 11000 Praha 1. Mattel, 333 Continental Boulevard, El Segundo, CA 90245, USA. Consumer Services: 1-800-465-MEGA (6342). Mattel Canada Inc., Mississauga, Ontario L5R 3W2. Consumer Services: You may call us free at / Composez sans frais le 1-800-524-8697. Importado y distribuido por Mattel de México, S.A. de C.V., Miguel de Cervantes Saavedra No. 193, Pisos 10 y 11, Col. Granada, Alcaidía Miguel Hidalgo, CP 11520, México, Ciudad de México. R.F.C. MME-920701-NB3. Tels: 59-05-51-00 Ext. 5206 ó 01-800-463-59-89. Mattel Chile, S.A., Avenida Américo Vespucio 501-B, Quilicura, Santiago. Tel: 1230-020-6213. Servicio al consumidor Venezuela: Tel: 0-800-100-9123. Mattel Argentina, S.A., Av. Libertador 1000, Piso 11 - Oficinas 109 y 111, Vicente López - Prov. Buenos Aires. Tel: 0800-666-3373. Mattel Colombia, S.A., Calle 123#7-07 P5, Bogotá. Tel: 01800-710-2069. Mattel Perú, S.A., Av. Juan de Arona # 151, Centro Empresarial Juan de Arona, Torre C, Piso 7, Oficina 704, San Isidro, Lima 27, Perú. RUC: 20425853865. Reg. Importador: 02350-12-JUE-DIGESA. Tel: 0800-54744. E-mail Latinoamérica: [servicio.clientes@mattel.com](mailto:servicio.clientes@mattel.com). Mattel do Brasil Ltda. - CNPJ: 54.558.002/0001-20 - Rua Roque Divino, 1488 - 2º. Andar - 04719-904 - Chácara Santo Antônio - São Paulo - SP - Brasil. Serviço de Atendimento ao Consumidor: fone 0800 575 0780. E-mail: [sac.matteldobrazil@mattel.com](mailto:sac.matteldobrazil@mattel.com)





# POKÉMON



GMD31



HDL84

Set(s) sold separately and subject to availability. / Ensemble(s) vendu(s) séparément. Certains produits peuvent ne pas être commercialisés. / Se vende(n) por separado y está(n) sujeto(s) a disponibilidad. / Conjunto(s) vendido(s) em separado e sujeito(s) à disponibilidade. / Set in vendita separatamente, secondo disponibilità. / Das/Die Set(s) sind separat erhältlich. / Zestaw(y) sprzedawany(e) oddzielnie w zależności od dostępności. / Set(s) apart verkrijgbaar en afhankelijk van beschikbaarheid. / Набор(-ы) продаются отдельно, при наличии. / Sæt sælges separat og så længe lager haves. / Seten säljs separat så länge lagret räcker. / Settet/settene selges separat så langt lageret rekker. / Pakkaus/pakkausset myydään erikseen, saatavuus voi vaihdella. / Το(α) σετ πωλούνται ξεχωριστά και ανάλογα με τη διαθεσιμότητα. / Setler ayrı olarak satılır ve stoklarla sınırlıdır. / Set (sety) se prodává (prodávají) samostatně dle aktuální nabídky. / Сўправа/-y sa predáva(jú) samostatne a podľa dostupnosti. / A készlet(ek) külön kapható(k), az elérhetőség változhat. / セット商品は別売りになります。在庫状況は別途ご確認をお願いします。 / نباع المجموعة أو المجموعات على حدة وتخضع لتوافرها. / 每套单独发售，按供货情况决定。

Set(s) sold separately and subject to availability. / Ensemble(s) vendu(s) séparément. Certains produits peuvent ne pas être commercialisés. / Se vende(n) por separado y está(n) sujeto(s) a disponibilidad. / Conjunto(s) vendido(s) em separado e sujeito(s) à disponibilidade. / Set in vendita separatamente, secondo disponibilità. / Das/Die Set(s) sind separat erhältlich. / Zestaw(y) sprzedawany(e) oddzielnie w zależności od dostępności. / Set(s) apart verkrijgbaar en afhankelijk van beschikbaarheid. / Набор(-ы) продаются отдельно, при наличии. / Sæt sælges separat og så længe lager haves. / Seten säljs separat så länge lagret räcker. / Settet/settene selges separat så langt lageret rekker. / Pakkaus/pakkausset myydään erikseen, saatavuus voi vaihdella. / Το(α) σετ πωλούνται ξεχωριστά και ανάλογα με τη διαθεσιμότητα. / Setler ayrı olarak satılır ve stoklarla sınırlıdır. / Set (sety) se prodává (prodávají) samostatně dle aktuální nabídky. / Сўправа/-y sa predáva(jú) samostatne a podľa dostupnosti. / A készlet(ek) külön kapható(k), az elérhetőség változhat. / セット商品は別売りになります。在庫状況は別途ご確認をお願いします。 / نباع المجموعة أو المجموعات على حدة وتخضع لتوافرها. / 每套单独发售，按供货情况决定。

Set(s) sold separately and subject to availability. / Ensemble(s) vendu(s) séparément. Certains produits peuvent ne pas être commercialisés. / Se vende(n) por separado y está(n) sujeto(s) a disponibilidad. / Conjunto(s) vendido(s) em separado e sujeito(s) à disponibilidade. / Set in vendita separatamente, secondo disponibilità. / Das/Die Set(s) sind separat erhältlich. / Zestaw(y) sprzedawany(e) oddzielnie w zależności od dostępności. / Set(s) apart verkrijgbaar en afhankelijk van beschikbaarheid. / Набор(-ы) продаются отдельно, при наличии. / Sæt sælges separat og så længe lager haves. / Seten säljs separat så länge lagret räcker. / Settet/settene selges separat så langt lageret rekker. / Pakkaus/pakkausset myydään erikseen, saatavuus voi vaihdella. / Το(α) σετ πωλούνται ξεχωριστά και ανάλογα με τη διαθεσιμότητα. / Setler ayrı olarak satılır ve stoklarla sınırlıdır. / Set (sety) se prodává (prodávají) samostatně dle aktuální nabídky. / Сўправа/-y sa predáva(jú) samostatne a podľa dostupnosti. / A készlet(ek) külön kapható(k), az elérhetőség változhat. / セット商品は別売りになります。在庫状況は別途ご確認をお願いします。 / نباع المجموعة أو المجموعات على حدة وتخضع لتوافرها. / 每套单独发售，按供货情况决定。

Mattel Canada Inc. Mississauga, Ontario L5R 3W2.  
MADE IN CHINA. FABRIQUÉ EN CHINE. FABRICADO NA CHINA. HECHO EN CHINA.  
ИЗГОТОВЛЕНО В КИТАЕ. ÇİN'DE ÜRETİLMİŞTİR. صنع في الصين

© D781,964, D797,203, D799,607, D834,105

1186 MJ, 1, NL

©2022 MEGA Brands &™ MEGA Brands.  
Printed in China / Imprimé en Chine

AD-GYH06-06A

