

HKF89

MEGA-WREX™ BONEYARD STUNT COURSE
PISTE CASCADES MEGA-WREX

PISTA DE ACROBACIAS EN EL CEMENTERIO MEGA-WREX
MEGA WREX PISTA DE ACROBACIAS





**Build
Construisez**
Construye | Constrói
Bauen | Стройте

Share | Partagez

Comparte | Partilha
Teilen | Делитесь

Device not included | Appareil non inclus | Dispositivo não incluído
Dispositivo não incluído | Gerät nicht enthalten
Устройство не входит в комплект



3 ways to rebuild & play | façons de reconstruire et de jouer
formas de reconstruir y jugar | formas de reconstruir e brincar
Möglichkeiten, neu aufzubauen und zu spielen | способа перестроить и играть



Instructions included for main model only. Other build(s) can be found at megaunboxed.com / Instructions incluses pour le modèle principal uniquement. Les instructions pour l'(les) autre(s) modèle(s) de construction se trouvent sur le site megaunboxed.com / Nur für das Hauptmodell ist eine Anleitung enthalten. Unter megaunboxed.com finden Sie weitere Bauanleitungen. / Istruzioni incluse solo per il modello principale. È possibile trovare le altre costruzioni su megaunboxed.com / Instrukcijas alleen bij het hoofdmodel. Andere bouw mogelijkheden kunt u vinden op megaunboxed.com / Se incluyen las instrucciones para el modelo principal solamente. Se pueden encontrar otras construcciones en megaunboxed.com / Instruções incluídas somente para o modelo principal. Outras montagens podem ser encontradas em megaunboxed.com / Instruktioner medföljer endast för huvudmodellen. Andra byggen finns på megaunboxed.com / Ohjeet ovat sisällytettävä vain päämallleihin. Muut kokoonpanot ovat löydettävissä osoitteessa megaunboxed.com / Vejledningen følger kun med hovedmodellen. Andre byggemodeller kan findes på megaunboxed.com / Instruksjoner kun inkludert for hovedmodell. Annen/andre versjon/-er finner du på megaunboxed.com / Załączono instrukcje tylko do głównego modelu. Inne wersje są dostępne na megaunboxed.com / Příbalené pokyny jsou pouze pro hlavní model. Ostatní stavby lze najít na megaunboxed.com / Pribalené pokyny sú iba hlavný model. Ostatné stavby možno nájsť na megaunboxed.com / A mellékelt utasítások csak a fő modellre vonatkoznak. Egyéb építõelem(ek) a megaunboxed.com weboldalon található(k) / Инструкция относится только к основной модели. Другие конструкции можно найти на сайте megaunboxed.com / Οι οδηγίες που περιλαμβάνονται είναι μόνο για το κύριο μοντέλο. Μηδενικά τα βρείτε άλλες κατασκευές στο megaunboxed.com / Yönergeler sadece ana modeller için dahil edilmştir. Diğer yapı parçaları megaunboxed.com adresinde bulunabilir / メインのモデルのみの取扱説明書が含まれています。他のはmegaunboxed.comにあります。 / التعليمات موجودة للنموذج الرئيسي فقط. يمكن العثور على بناء (أخرى) على موقع megaunboxed.com / 拼搭指南仅包含主体部分的拼搭指导。其他部分拼搭指导可以上megaunboxed.com查找

megaunboxed.com



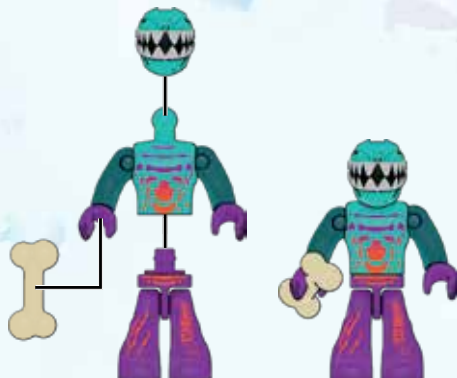

1

2

Most models can be built one at a time. / La plupart des modèles peuvent être construits un à la fois.

La mayoría de modelos se pueden construir de uno en uno. / A maioria dos modelos pode ser construída separadamente. / La maggior parte dei modelli possono essere realizzati uno per volta. / Die meisten Modelle können eines nach dem anderen gebaut werden. / Większości modeli nie da się budować jednocześnie z innymi. / De meeste modellen kunnen één voor één gebouwd worden. / Большинство моделей могут быть собраны по одной за раз. / De fleste modeller kan bygges enkeltvis. / De fleste modeller kan byggas en i taget. / De fleste modellene kan bygges en om gangen. / Useimmat mallit voidaan rakentaa yksi kerrallaan. / Τα περισσότερα μοντέλα μπορούν να κατασκευασθούν ένα ένα. / Modellerin çoğu ayrı ayrı inşa edilmeyi gerektirebilir. / Většinou lze najednou sestavit pouze jeden model. / Väčšina modelov môže byť zostavená iba raz. / A modellek többségéből egyszerre csak egy építhető. /ほとんどのモデルは、一度に一つを組み立てることができます。

يمكن تركيب التصميم الواحد تلو الآخر.
大多數型號可一次性建構

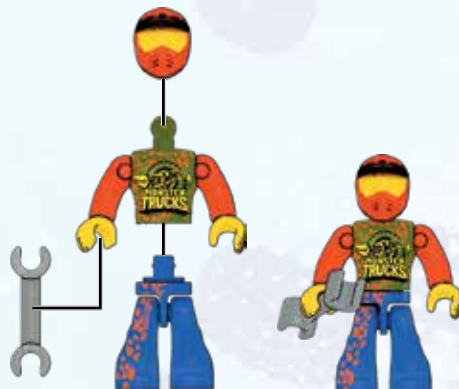

1

2



BUILDING TOOL OUTIL DE CONSTRUCTION

HERRAMIENTA DE CONSTRUCCIÓN
BAUWERKZEUG
FERRAMENTA DE MONTAGEM
ИНСТРУМЕНТ ДЛЯ КОНСТРУИРОВАНИЯ

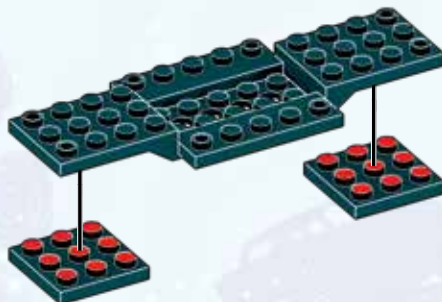
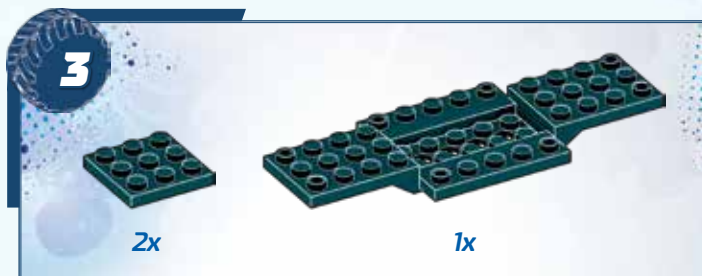
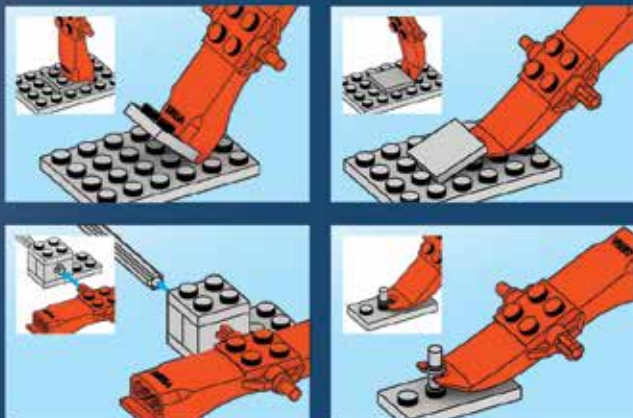

4



1x



1x

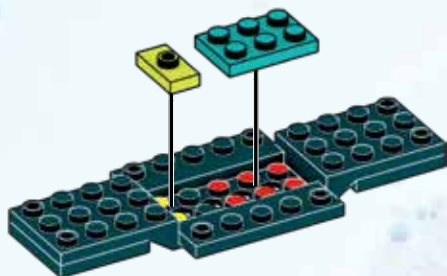

5



2x



1x

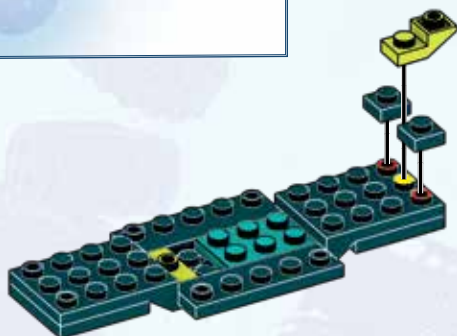

6



1x



7



1x



2x

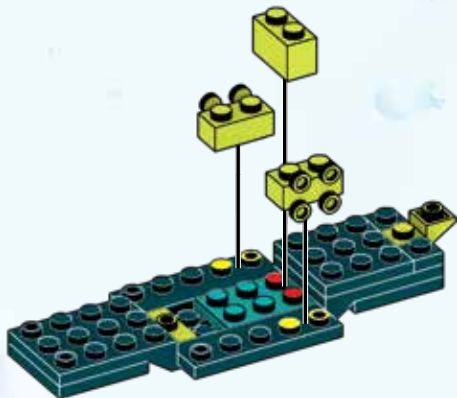

8



4x

x2

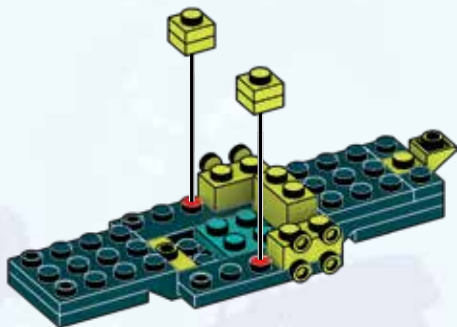

9



2x



1x

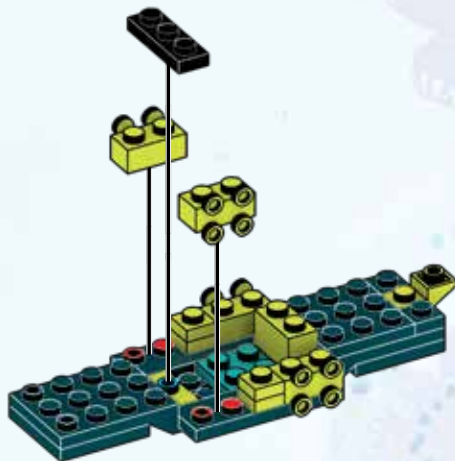

10



1x



1x

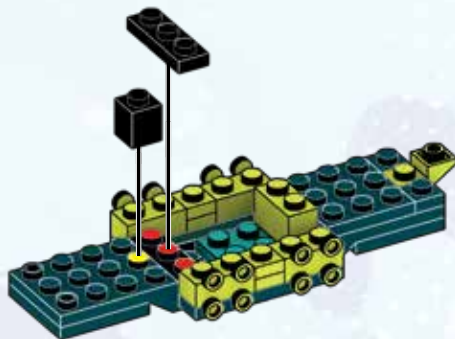

11



2x

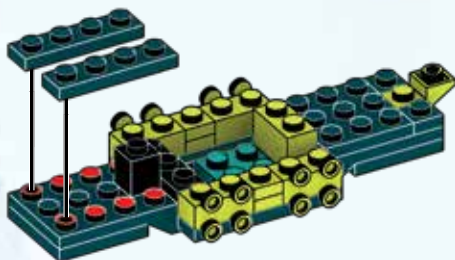

12



1x



1x

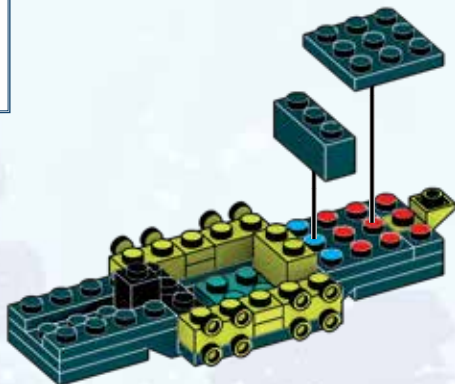

13



1x



2x

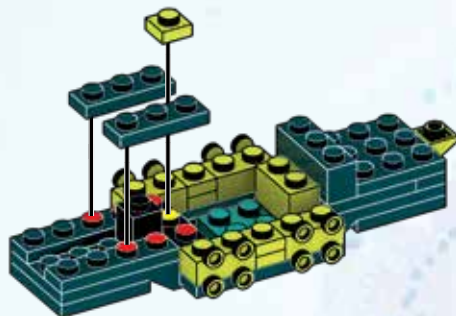

14



2x

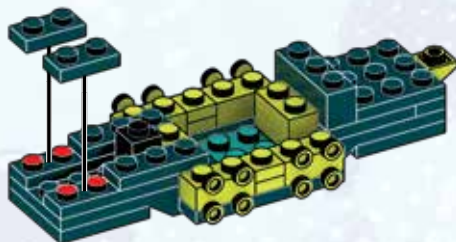

15



2x

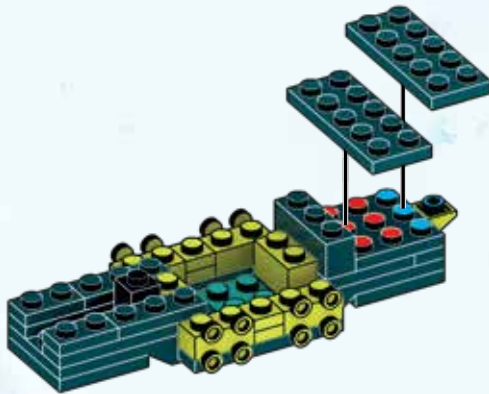

16



1x

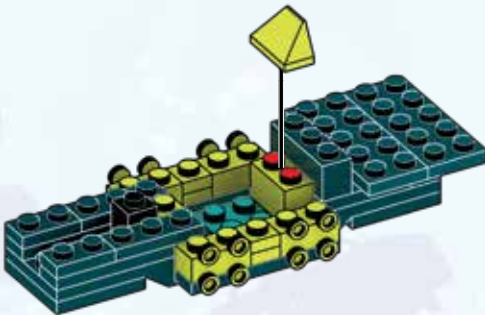

17



1x



1x



2x



1



2

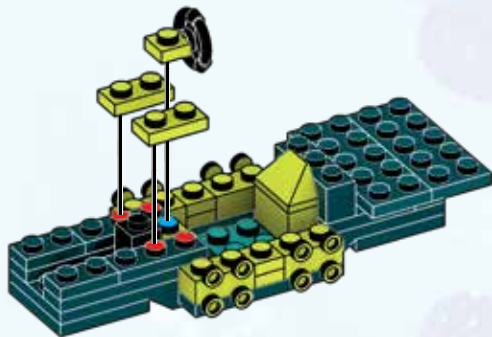

18



2x



1x



1x



1



2



1



2

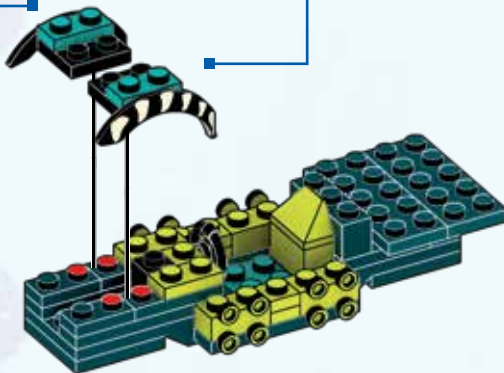

19



2x



1x

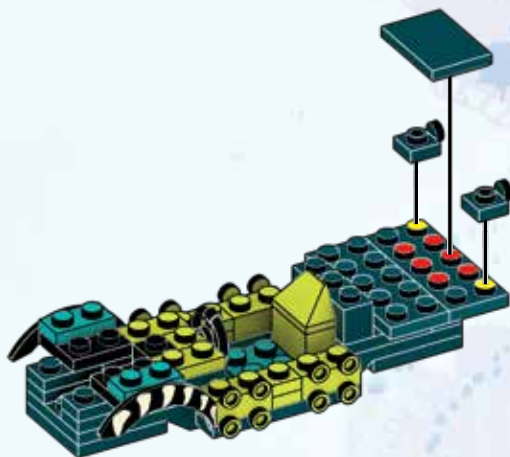

20



2x



1x

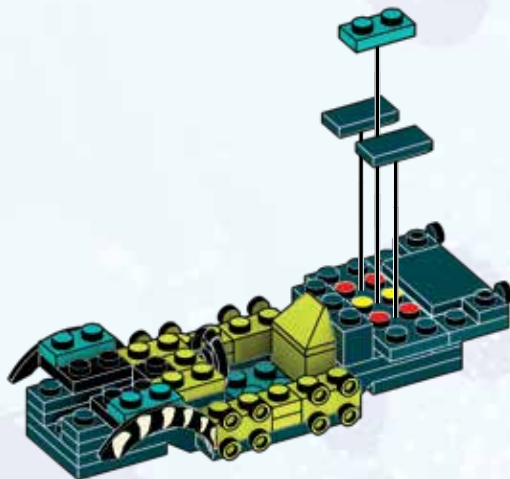

21



2x

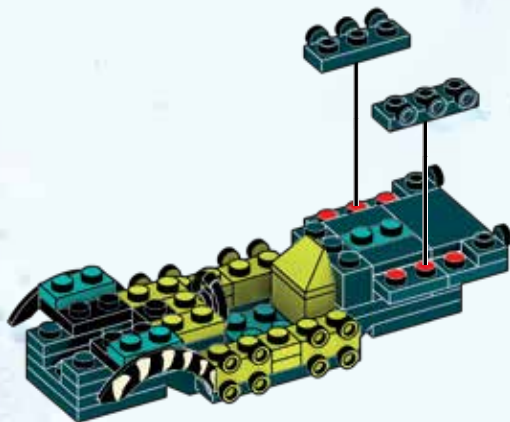

22



1x

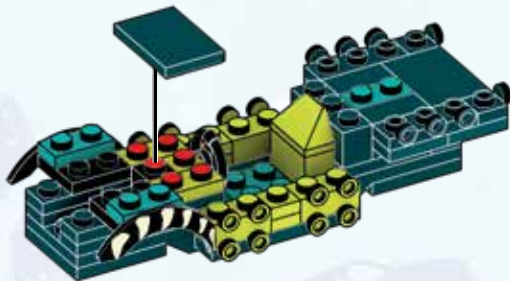

23



1x

1x

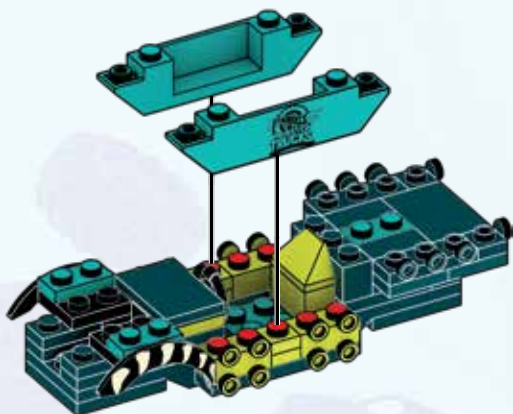

1

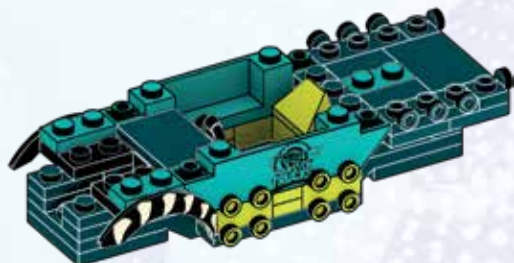

2

24



1x



1x



1x

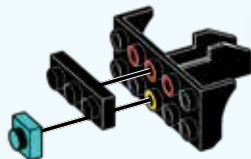

25



1x



1x



1x



1x

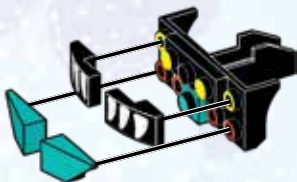

26



1x



1x

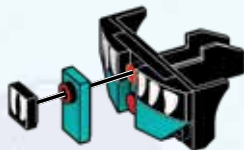

1



2

27

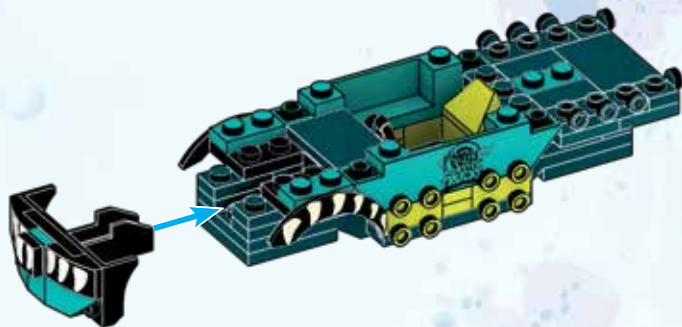

28

1x 1x

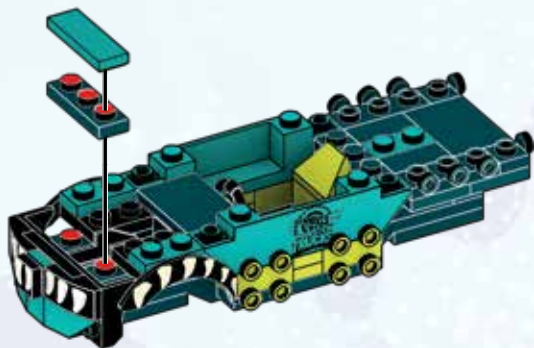

29



1x

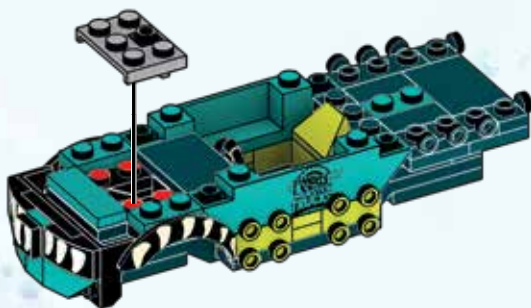

30



2x

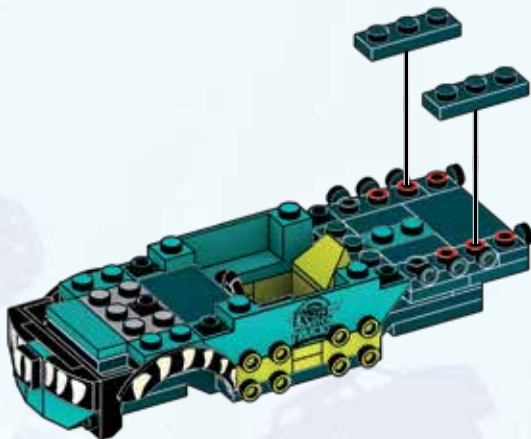

31



1x



2x

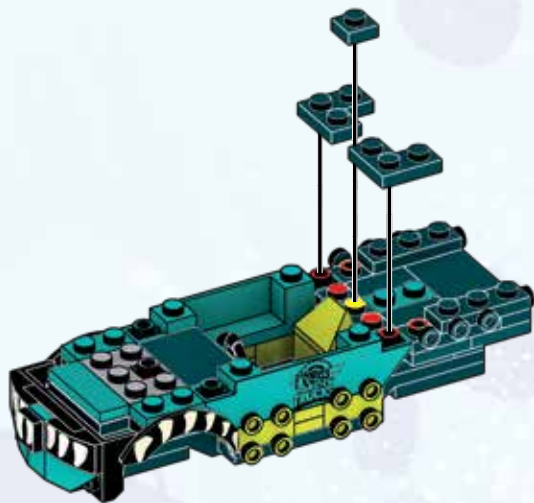

32



1x



2x



1x



1x



1x

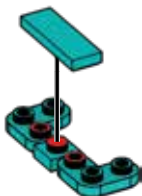

1

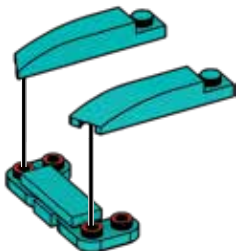

2

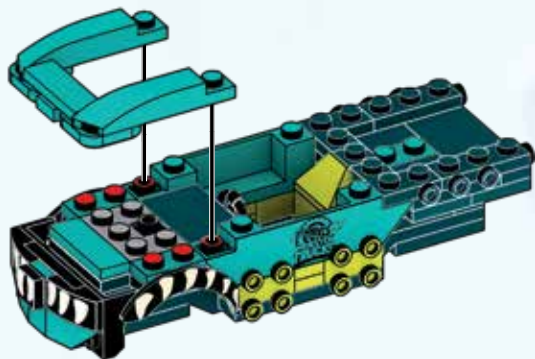

33



1x



1x

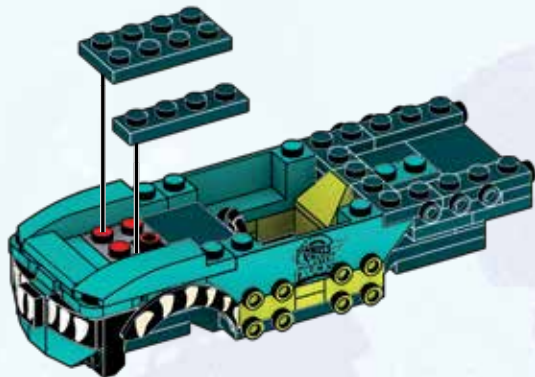

34



1x



1x

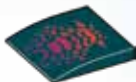

1x

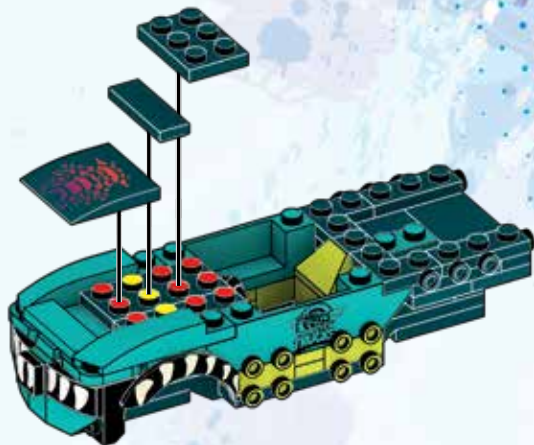

35



2x

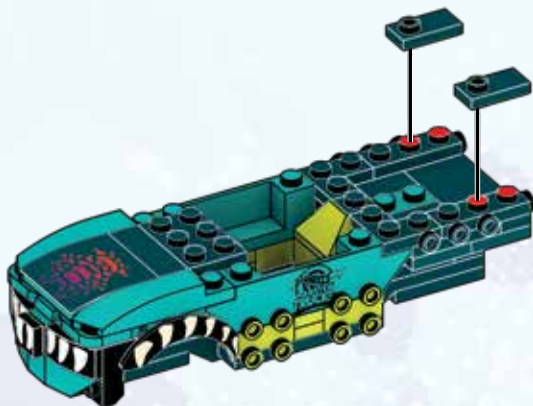

36



1x



1x



1x

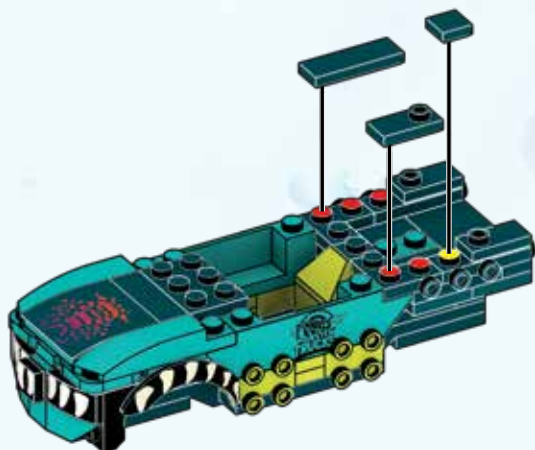

37



1x



2x

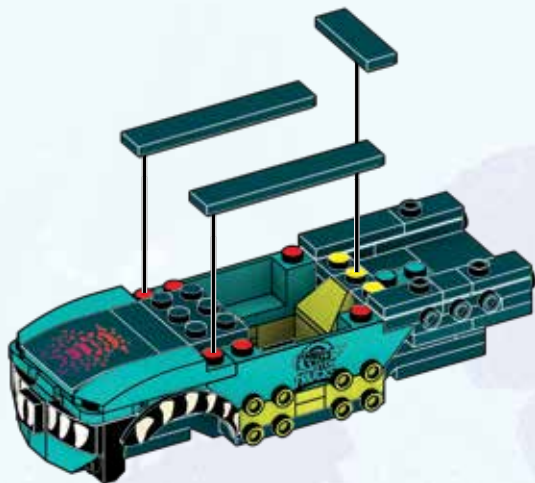

38



1x

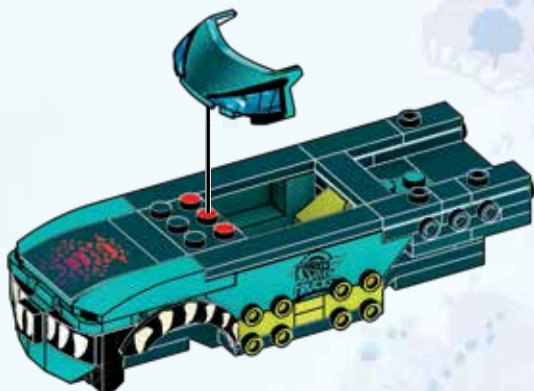

39



1x

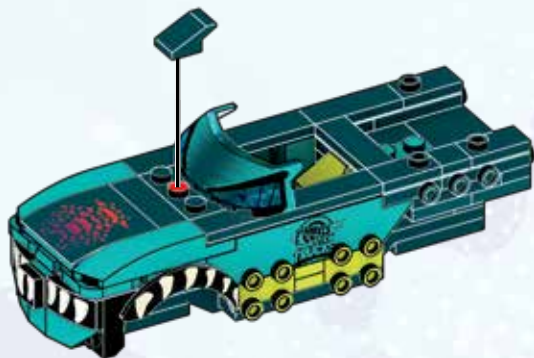

40



1x



1x

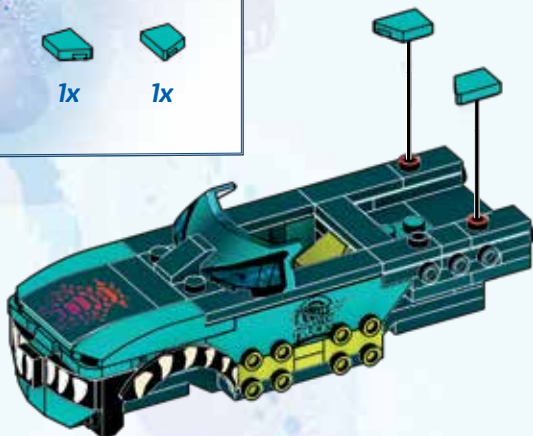

1

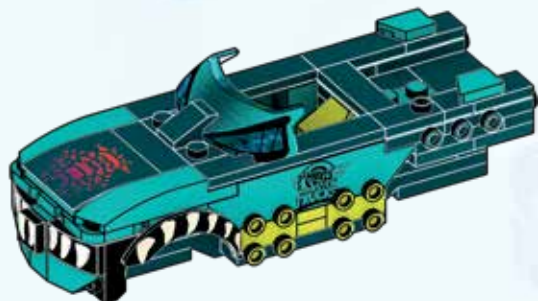

2

41



1x



1x



1x



42



2x

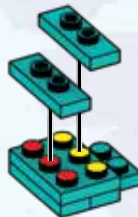

43



1x

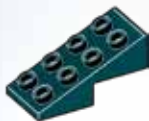

1x

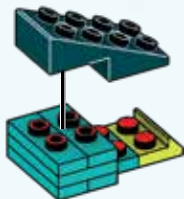

44



1x



1x



1x



1x



1

2

3

45



1x



1x



1

2

46

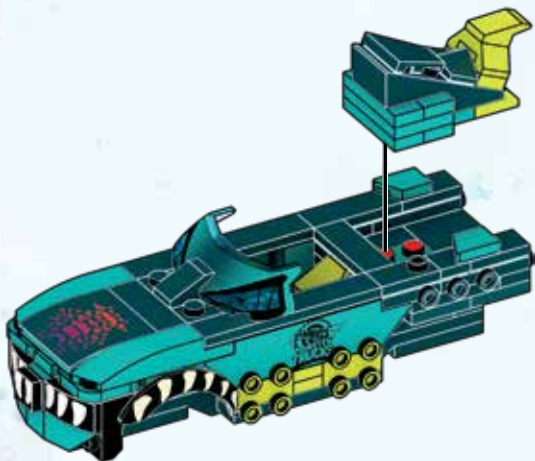

47



2x

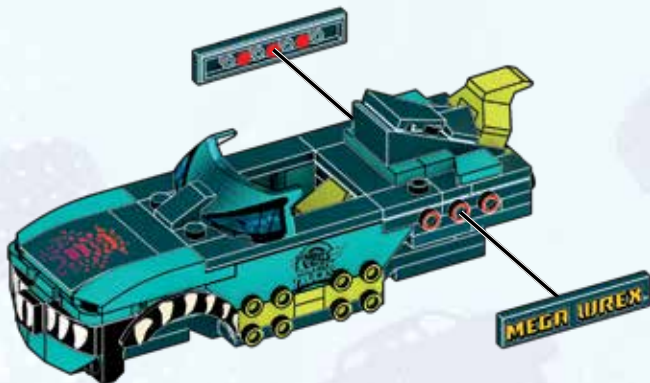

48



1x

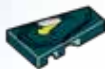

1x



49



1x



1x



50



2x

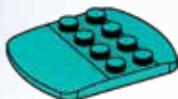

1x



1x



1

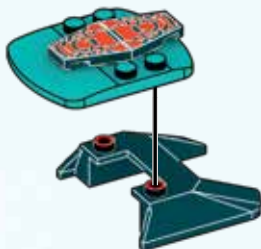

2



3

51



1



2

52



1x



1x



1



2

53



1x



1x

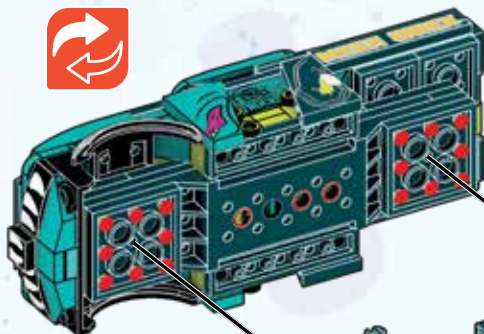

1

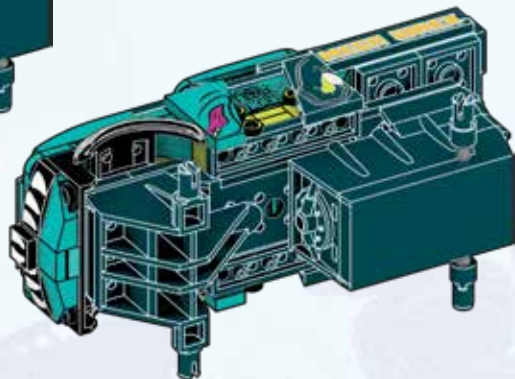
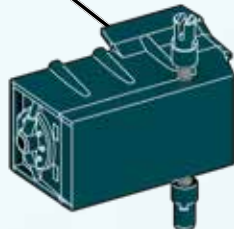

2



1



2

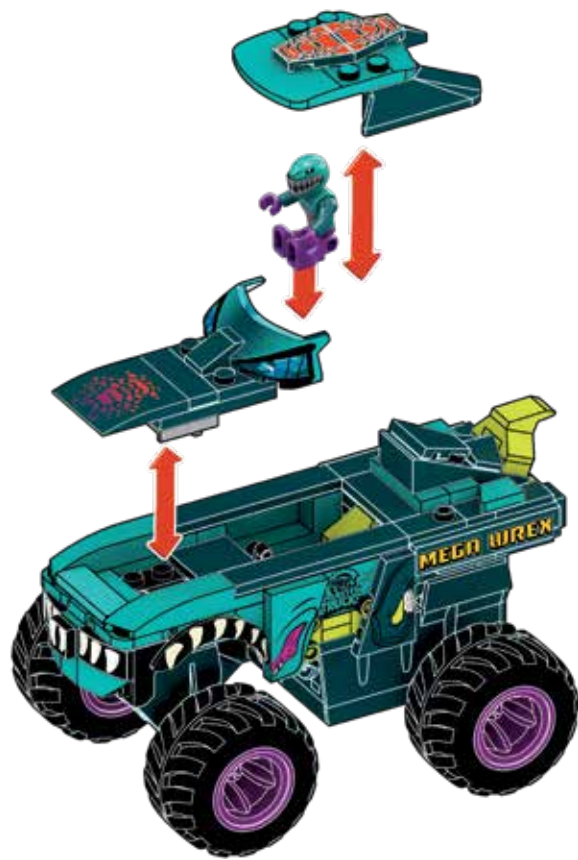

1



2



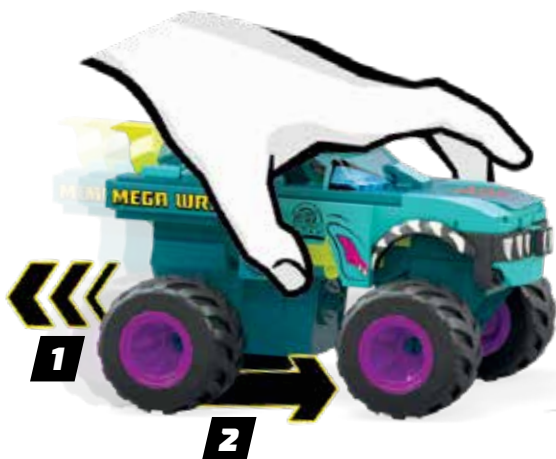

1

**PULL BACK AND GO!
TIREZ LE VÉHICULE VERS
L'ARRIÈRE ET PARTEZ !**

**¡HAZLO RODAR HACIA ATRÁS Y SUÉLTALO!
PUXA PARA TRÁS PARA ARRANCAR!
ZURÜCKZIEHEN UND LOSS GEHT'S!
ПОТЯНИ И ЗАПУСТИ!**



2

**PIECES FLY OFF ON IMPACT
LES ÉLÉMENTS VOLENT LORS DE L'IMPACT**

**LAS PIEZAS SALEN VOLANDO POR EL IMPACTO
AS PEÇAS VOAM COM O IMPACTO
BEIM AUFSCHLAG FLIEGEN TEILE AB
ДЕТАЛИ ВЫЛЕТАЮТ ПРИ СТОЛКНОВЕНИИ**

**SMASH
&
CRASH™**

Rebuild & play
Reconstruire et jouer

Reconstruir y jugar
Reconstruir e brincar
Umbauen und spielen
перестроить и играть

1

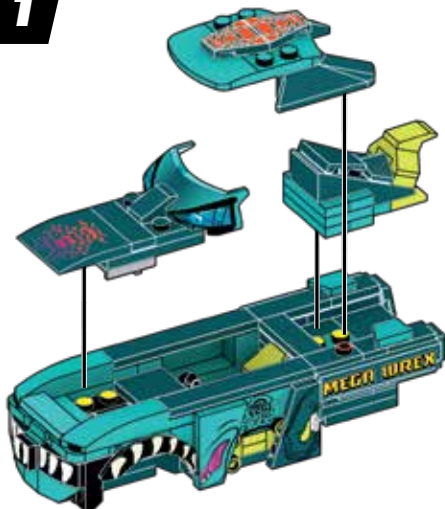

2

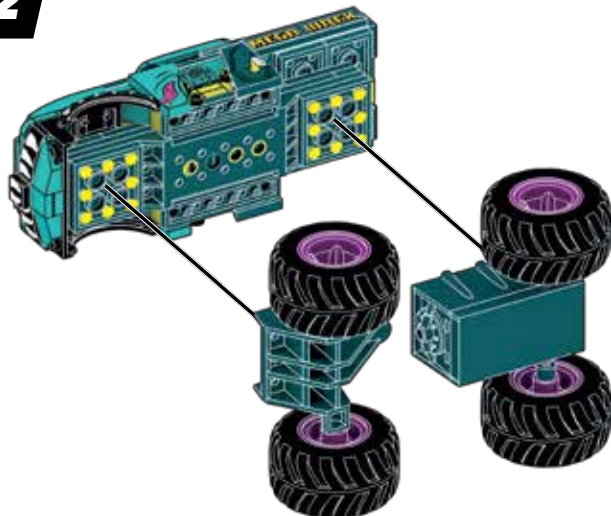

3



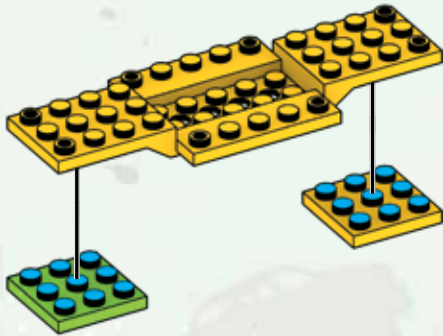
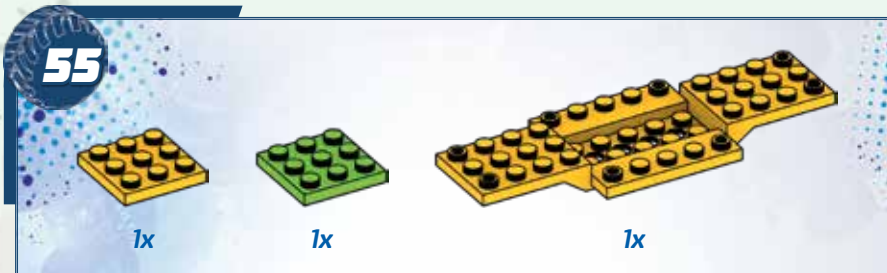
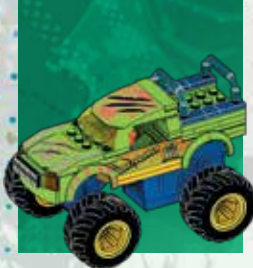

56



1x



1x

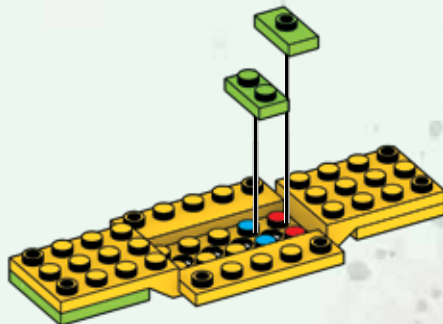

57



1x



1x



58



2x

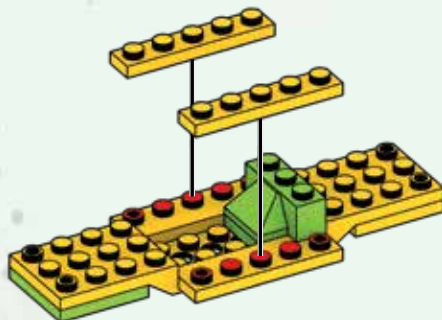

59



2x

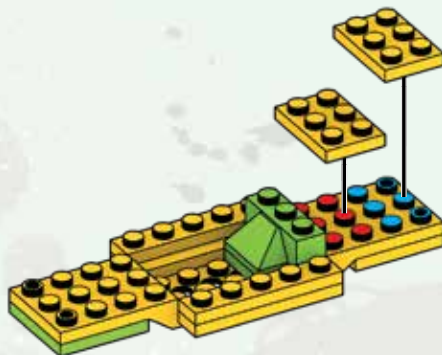

60



3x

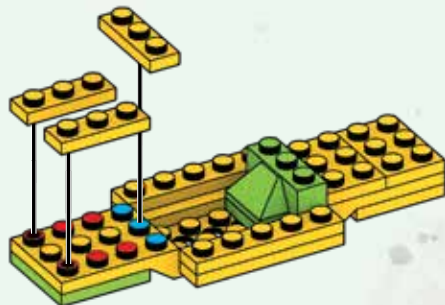

61



1x



1x



1x

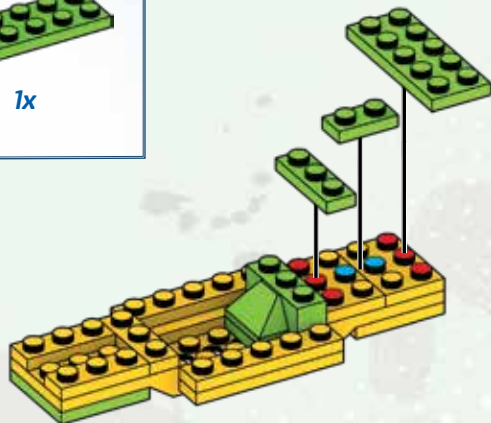

62



2x



1x

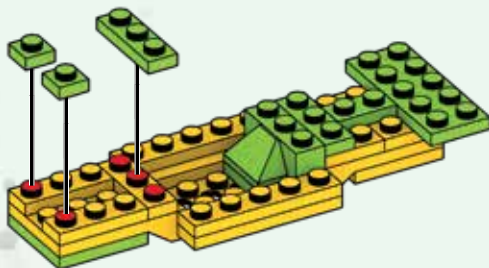

63



1x



1x



2x

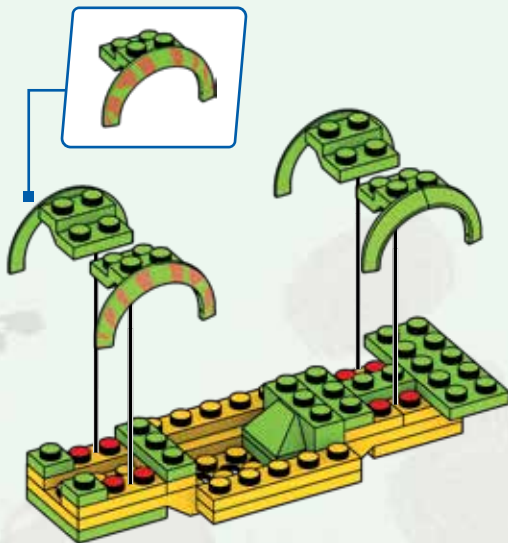

64



1x



2x

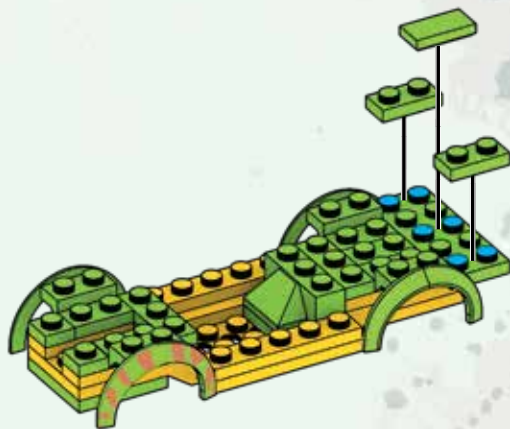

65



2x



66



1x



1x

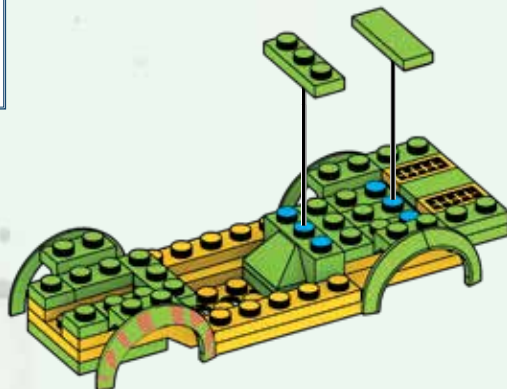

67



2x



1x



68



1x



1x



2x

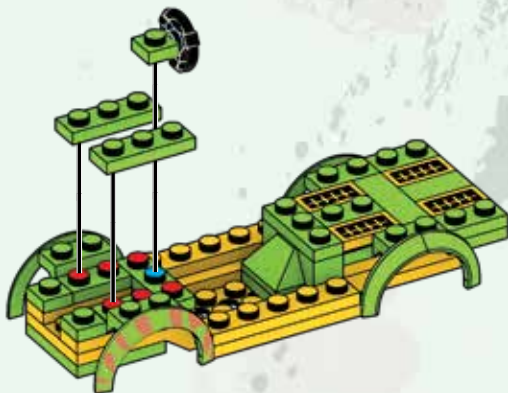
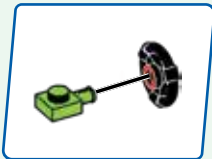

69



1x



1x

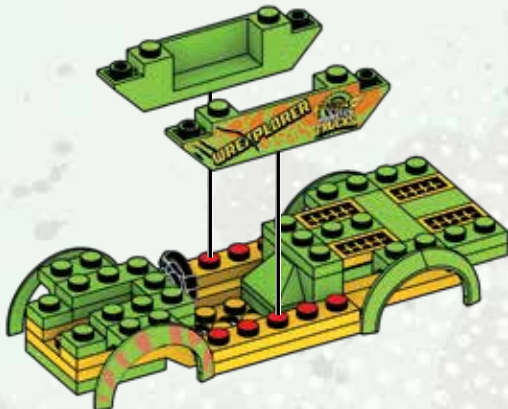

70



1x



2x

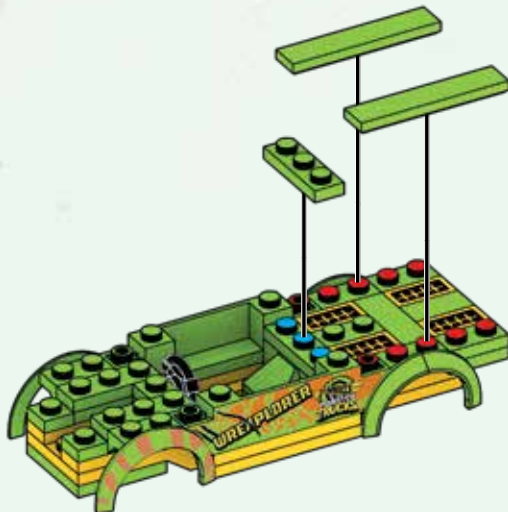

71



1x



2x

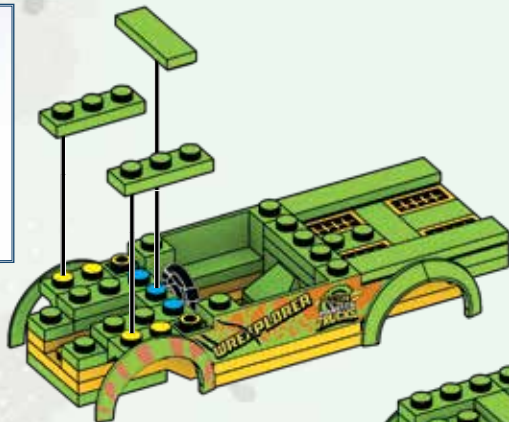

1

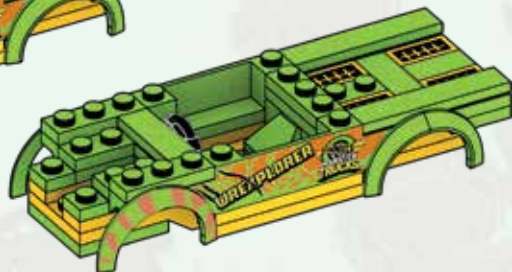

2

72



1x

1x



1x

73



2x



1x



1x

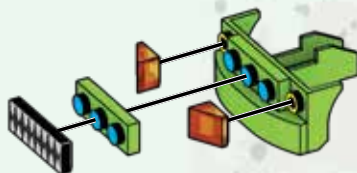
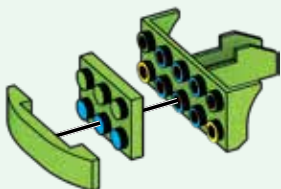

1

2

74

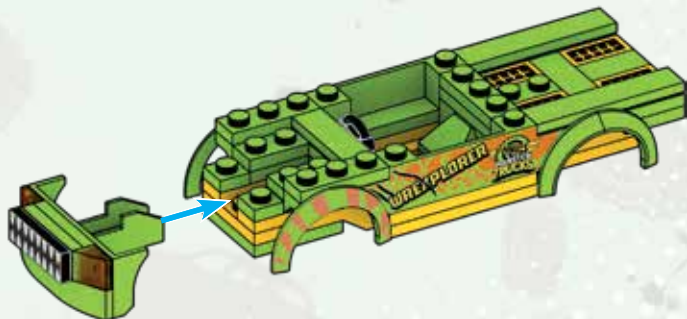

75



1x

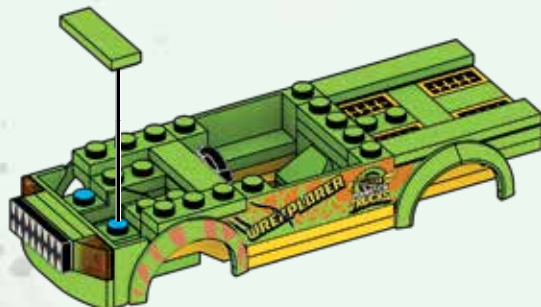

76



1x

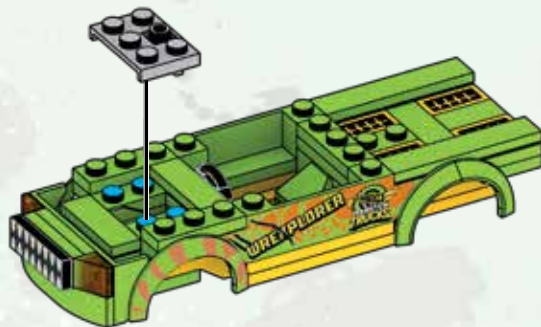

77



2x

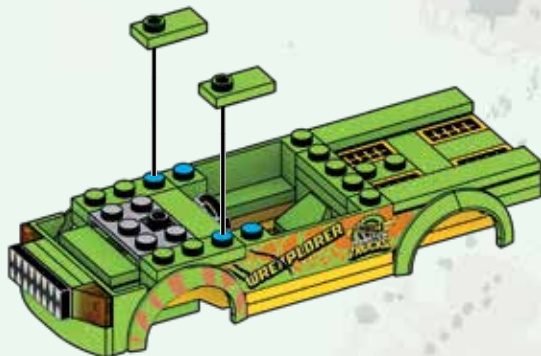

78



1x

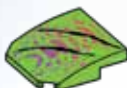

1x

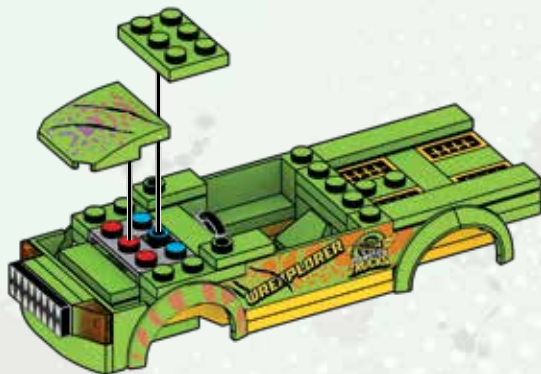

79



1x



1x

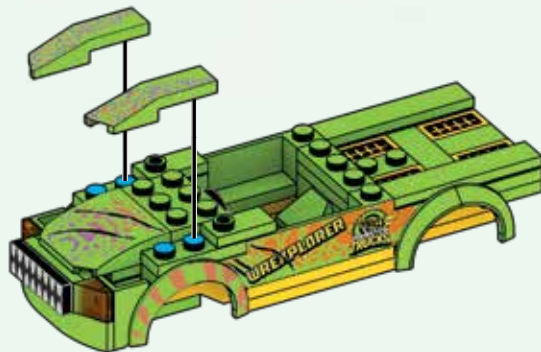

80



1x



2x

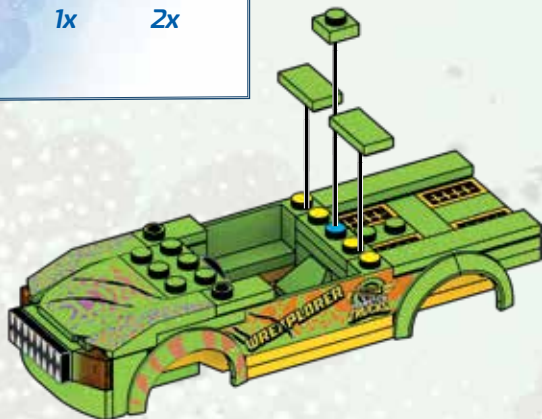

1

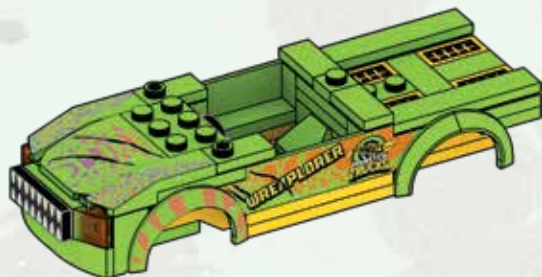

2

81



1x



1x



1x



2x

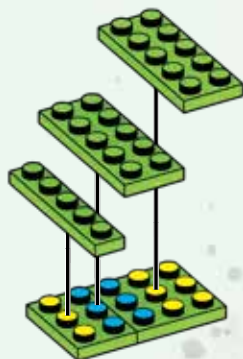

82



2x

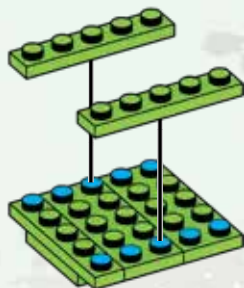

83



2x



4x

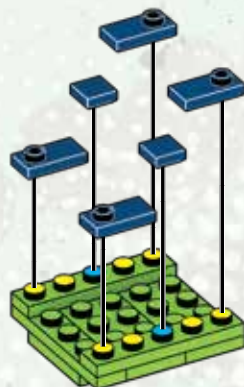

84



4x



4x



2x



1



2



3

x2

85

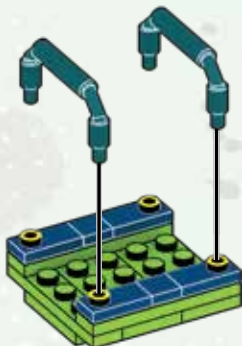

1



2

86

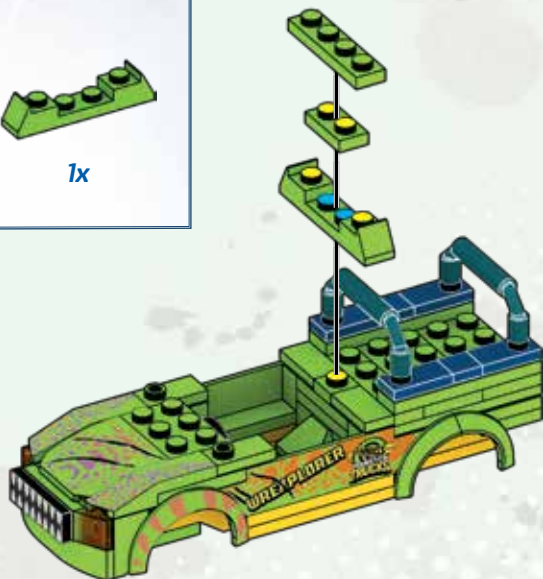
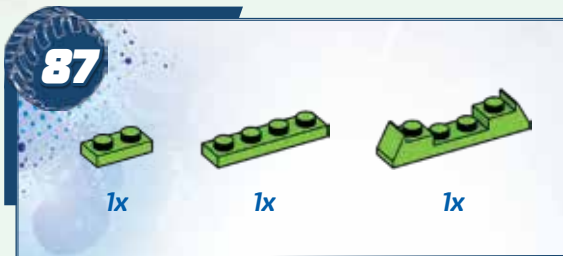
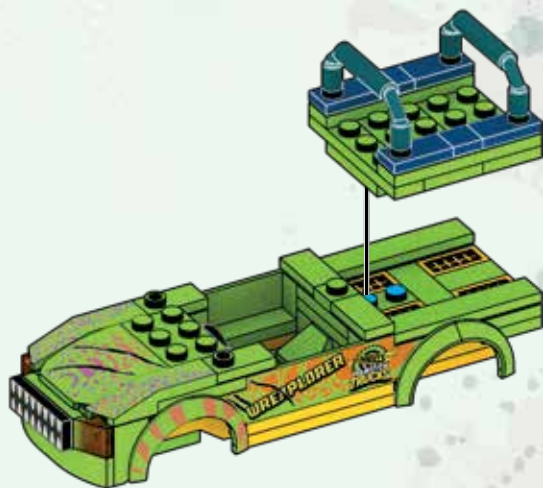

88



1x



1x

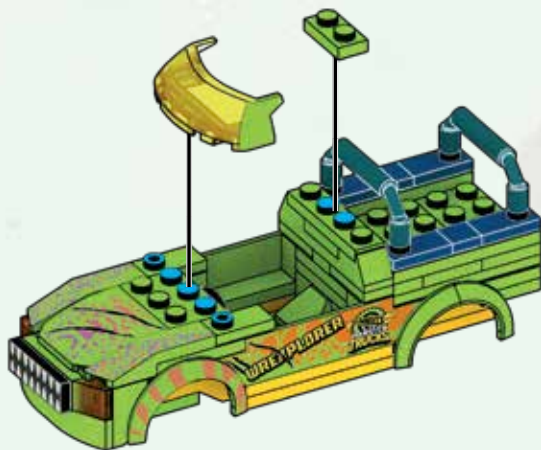

89



1x



1x

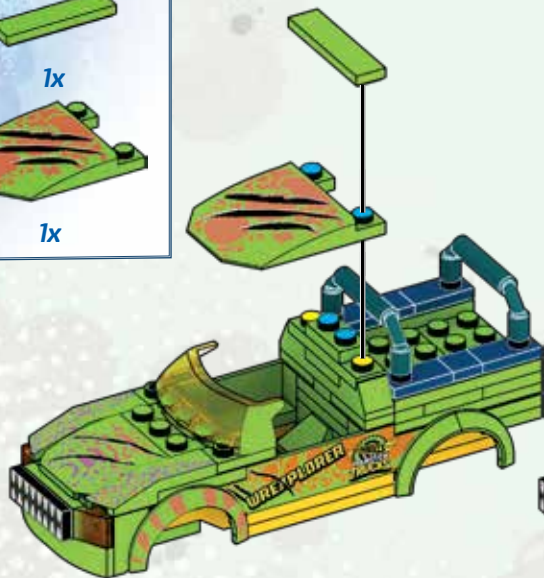

1

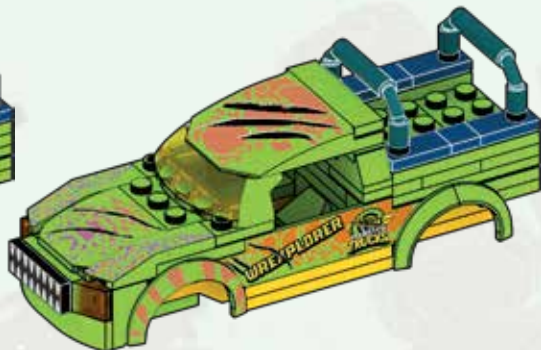

2

90



1x

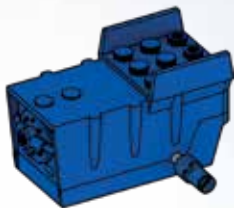

1x

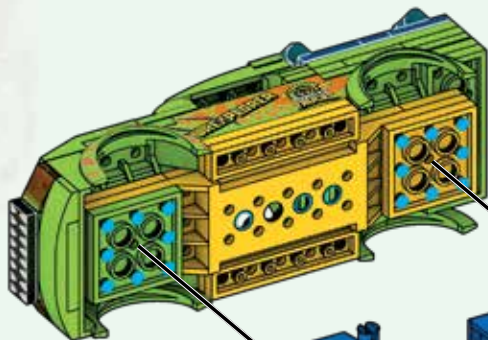

1

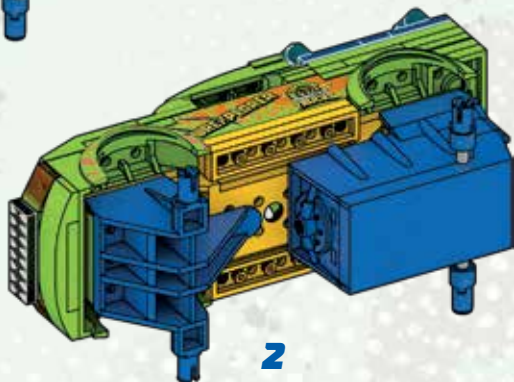
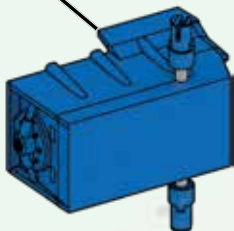

2



91



2x



2x

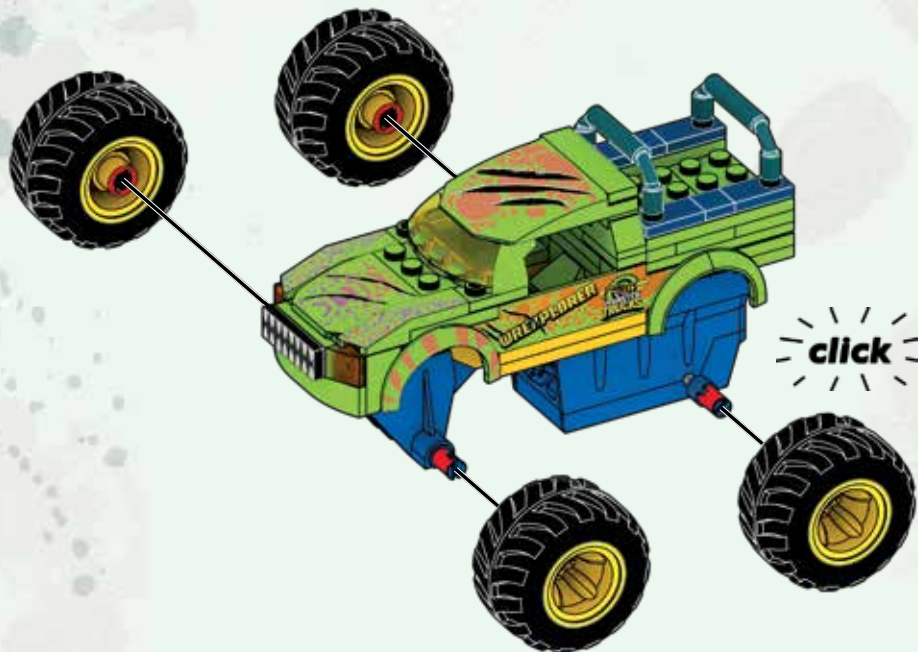

1



2

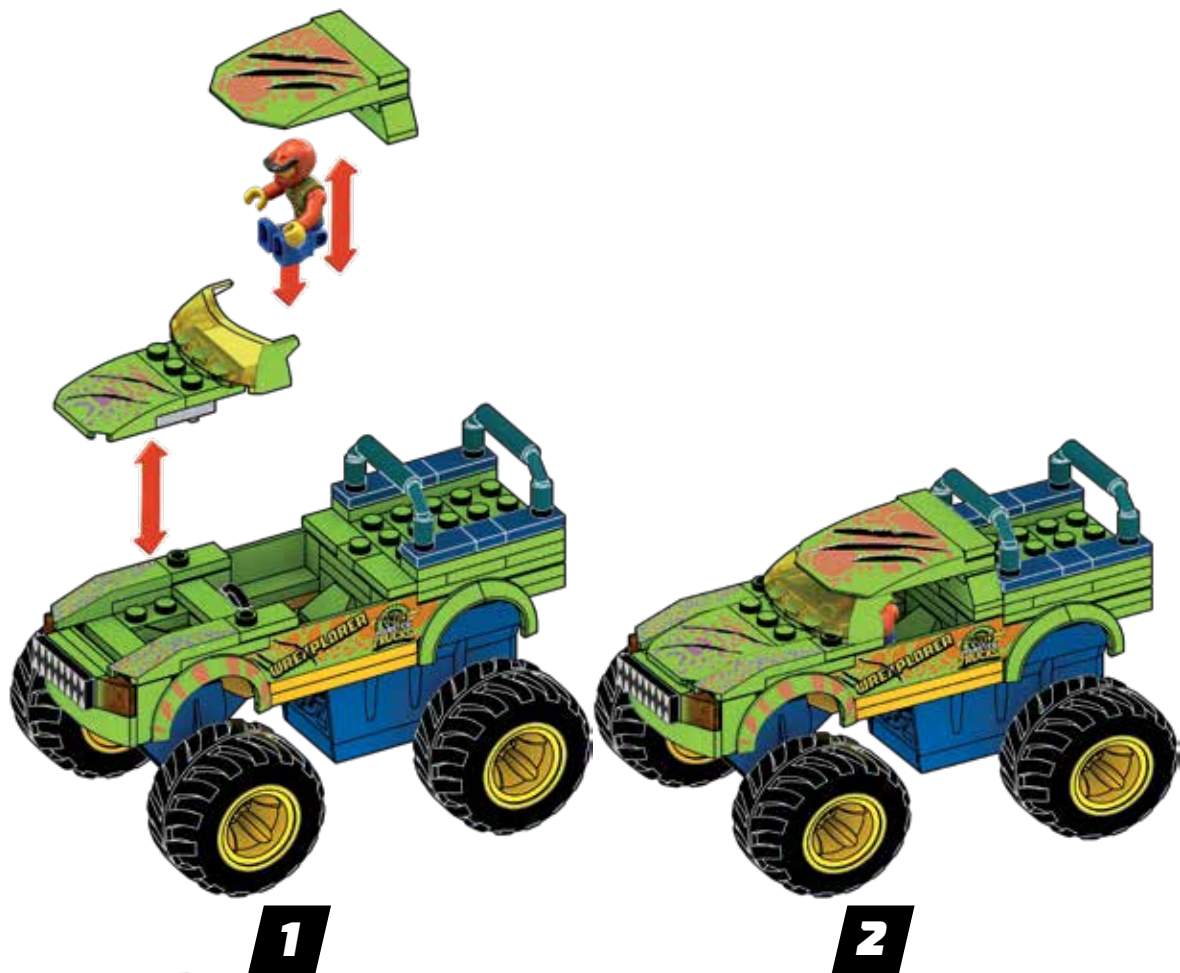

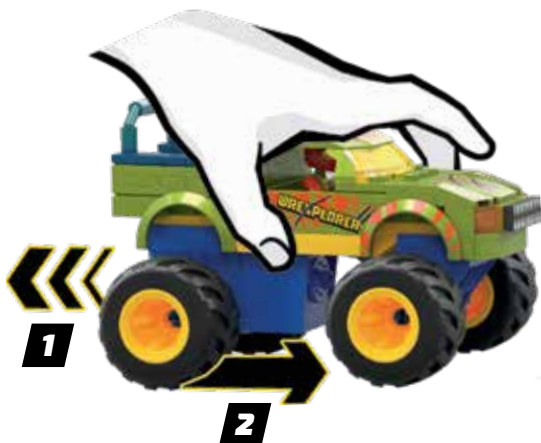

1

**PULL BACK AND GO!
TIREZ LE VÉHICULE VERS
L'ARRIÈRE ET PARTEZ !**

**¡HAZLO RODAR HACIA ATRÁS Y SUÉLTALO!
PUXA PARA TRÁS PARA ARRANCAR!
ZURÜCKZIEHEN UND LOSS GEHT'S!
ПОТЯНИ И ЗАПУСТИ!**



2

**PIECES FLY OFF ON IMPACT
LES ÉLÉMENTS VOLENT LORS DE L'IMPACT**

**LAS PIEZAS SALEN VOLANDO POR EL IMPACTO
AS PEÇAS VOAM GOM O IMPACTO
BEIM AUFSCHLAG FLIEGEN TEILE AB
ДЕТАЛИ ВЫЛЕТАЮТ ПРИ СТОЛКНОВЕНИИ**

**SMASH
&
CRASH™**

Rebuild & play
Reconstruire et jouer

Reconstruir y jugar
Reconstruir e brincar
Umbauen und spielen
перестроить и играть

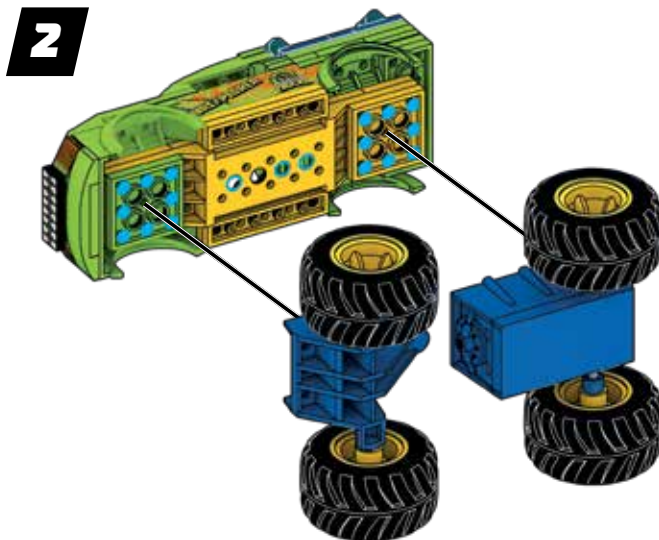

9

10

92



2x



1x

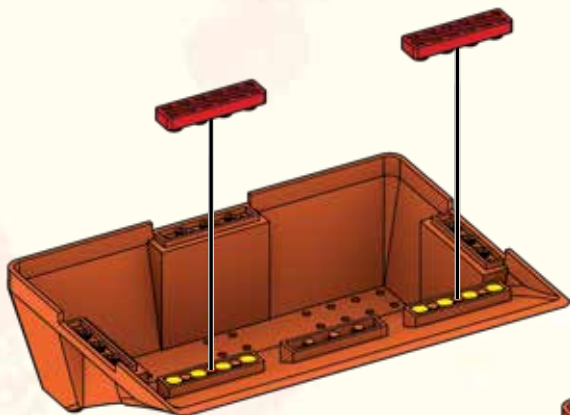

1

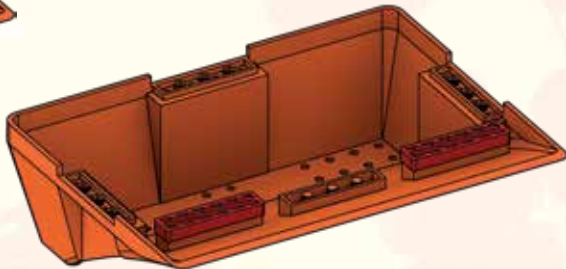

2

93



2x



94



2x



95



2x



96



2x

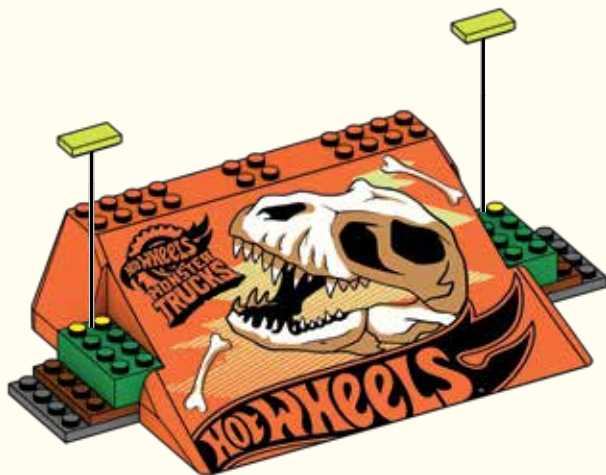

1



2

97



2x



1x

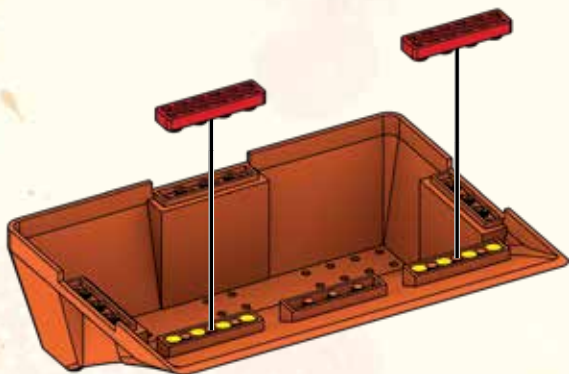

1

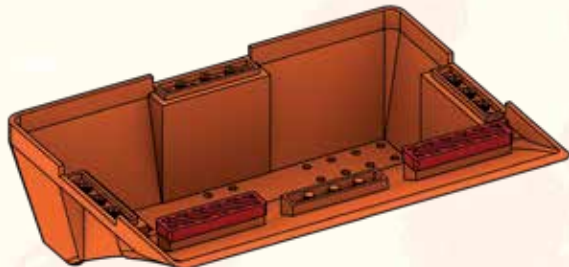

2

98



2x



99



2x



100



2x

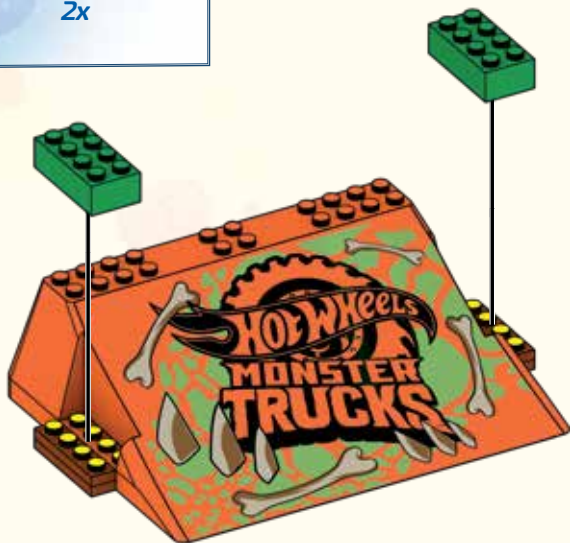

1



2

101



1x



1x

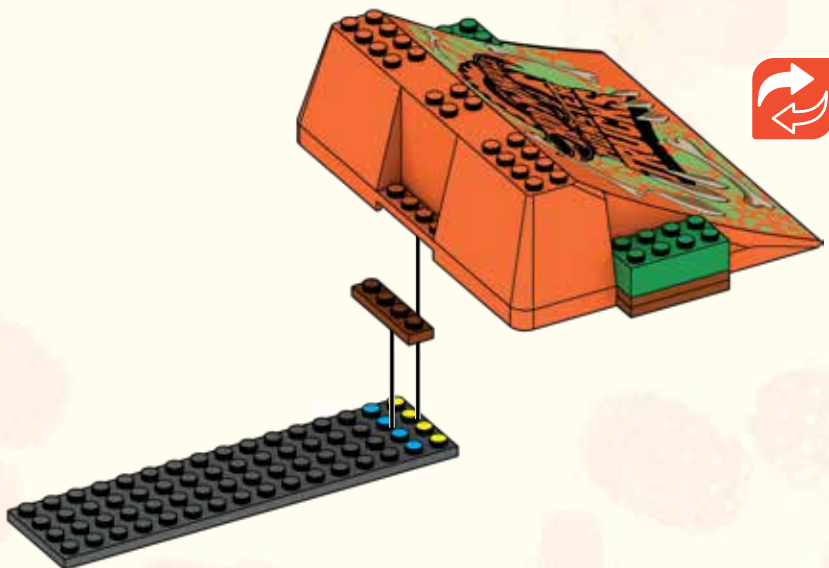

102



2x



1x



2x

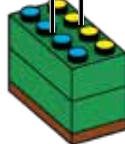

1

2

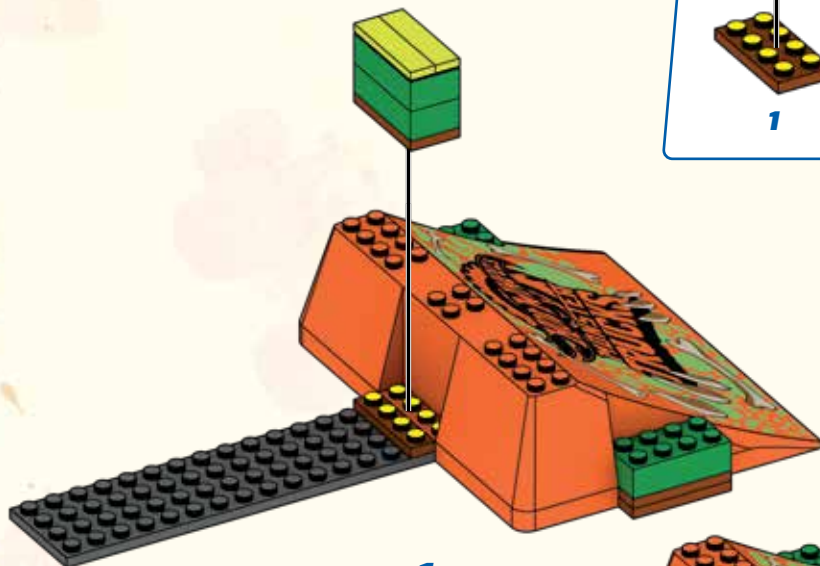

1

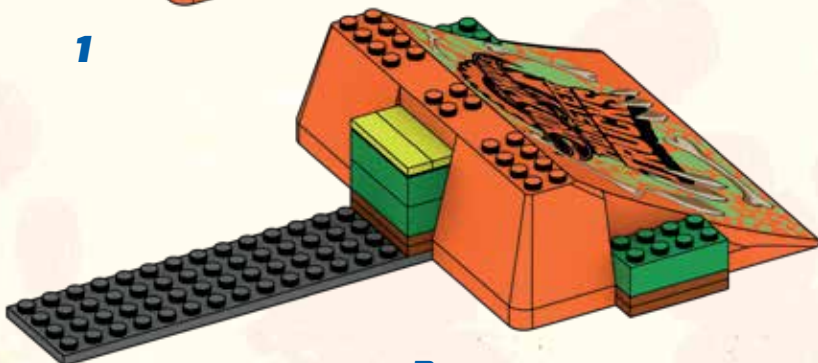

2

103

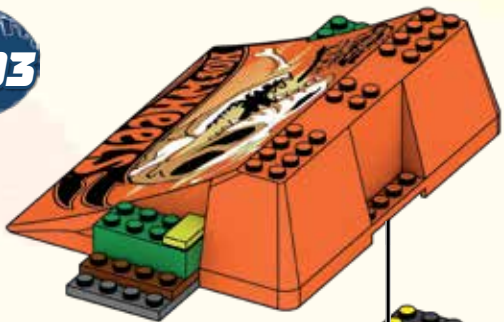

104



1x

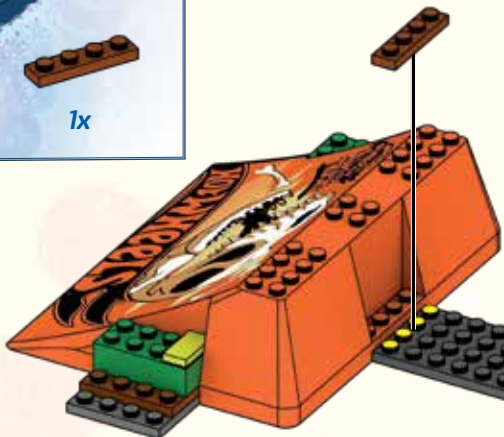

105



2x



1x

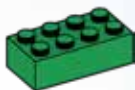

2x



1

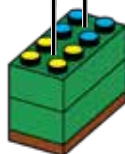

2

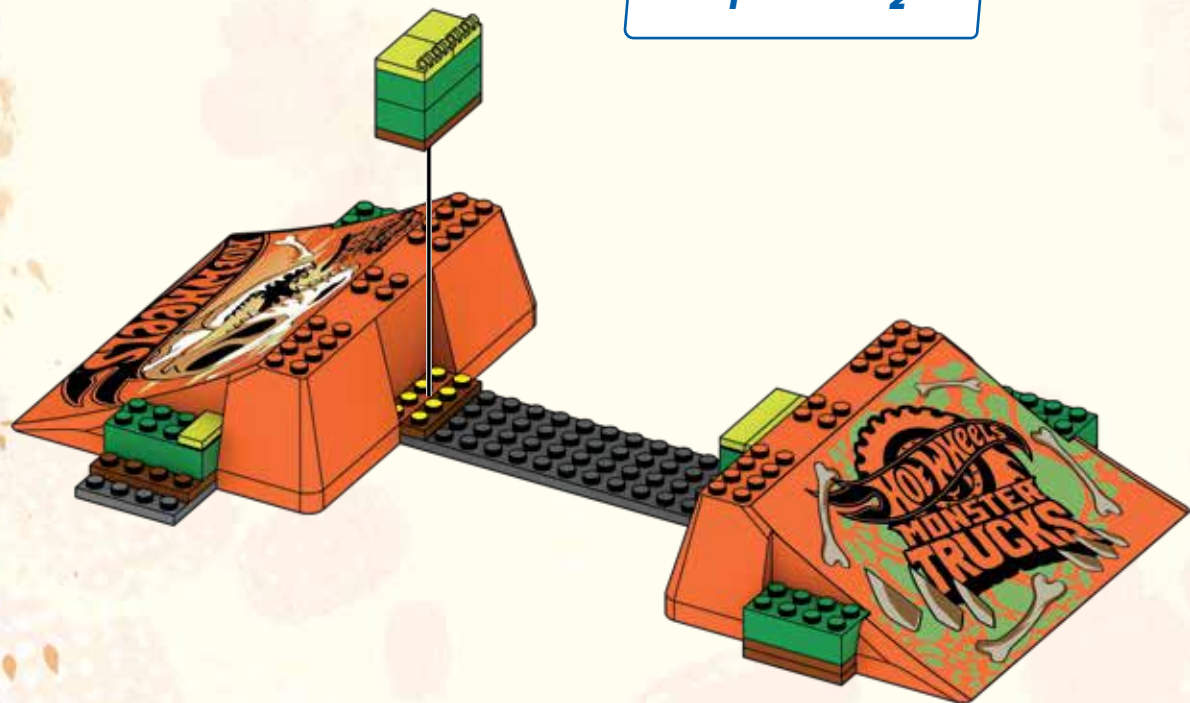

1

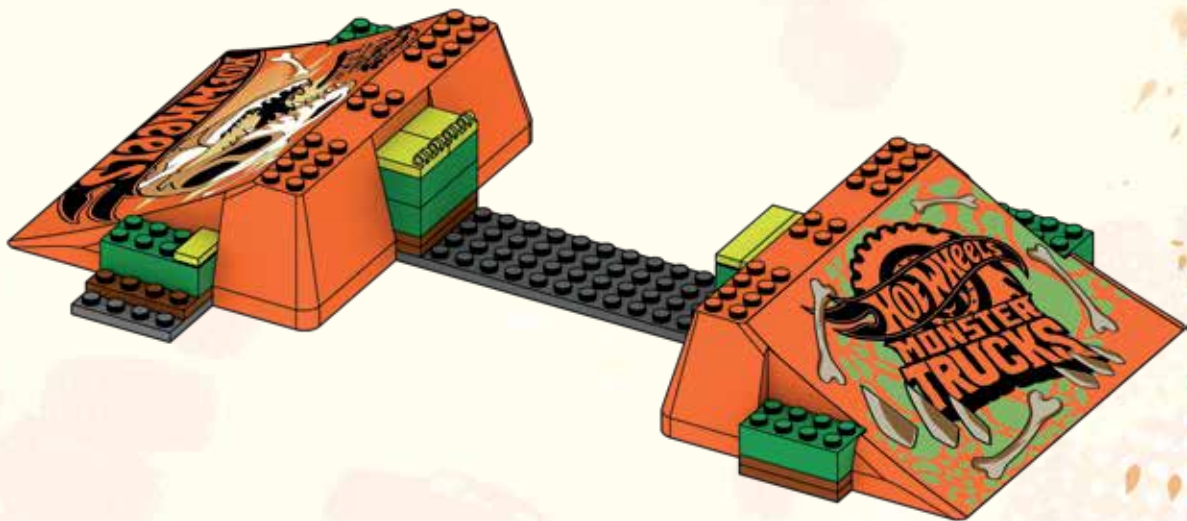

2

106



1x



3x



2x



1x

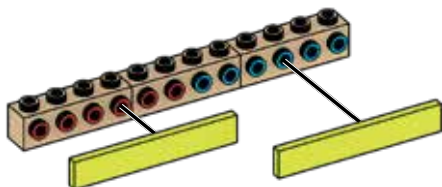

1

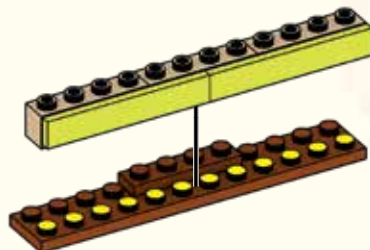

2

107



6x

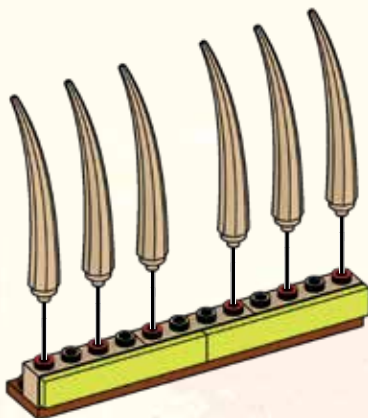



2x



2x



1x

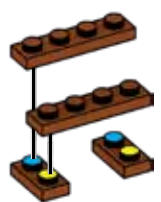

1



2

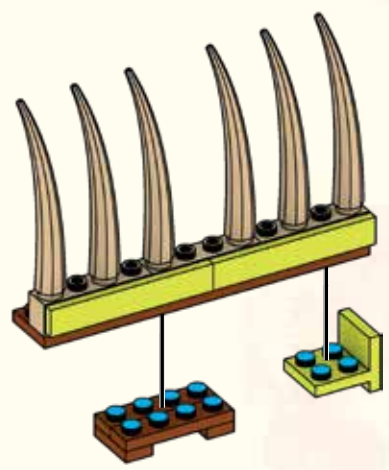

1

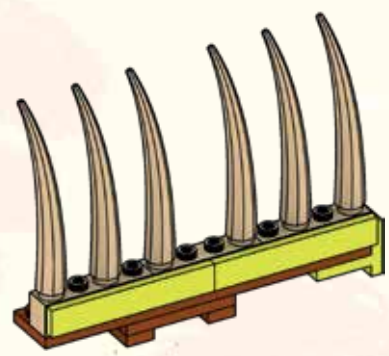

2

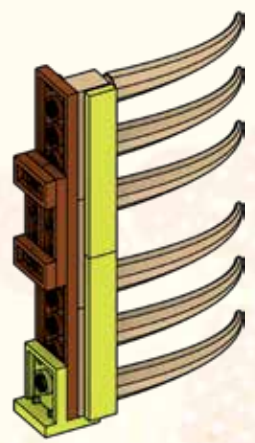

3

109



1x



3x



2x



1x

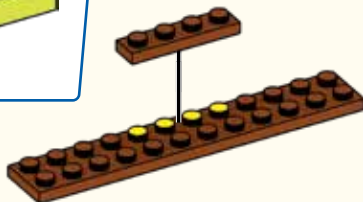
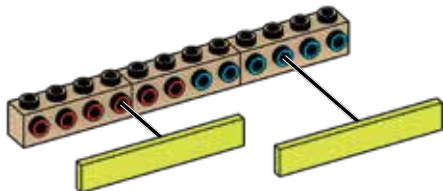

1

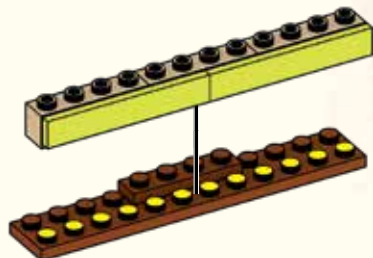

2

110



6x

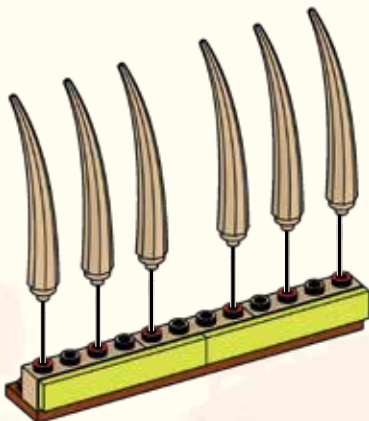

111



2x



2x



1x



1



2

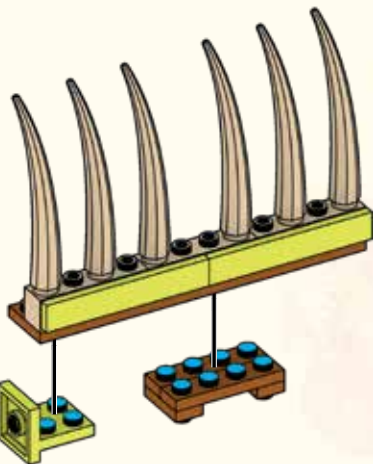

1

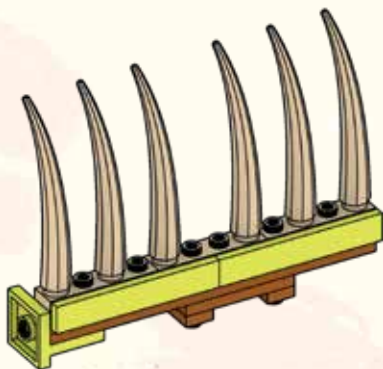

2

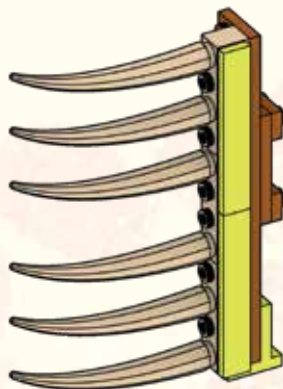

3

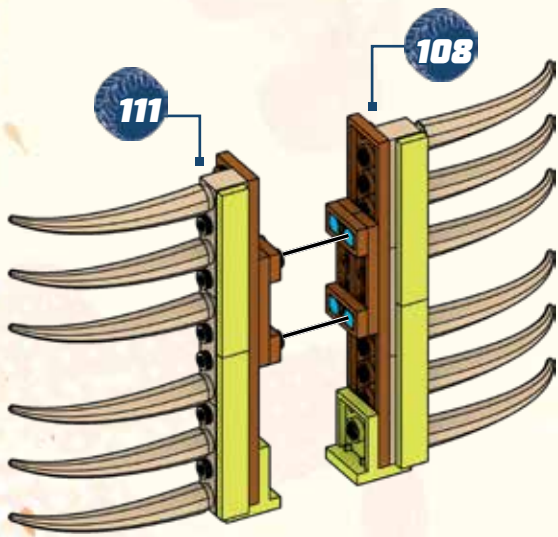

1

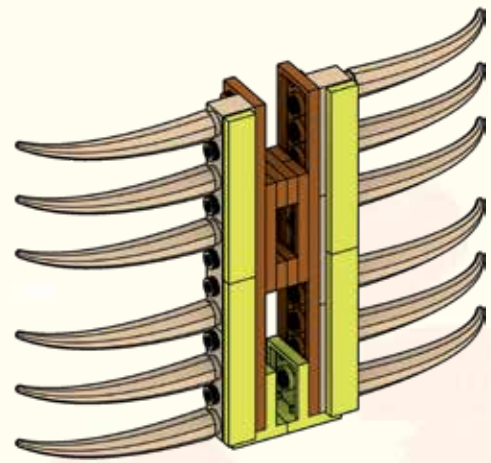

2

113



2x



1x



1



2

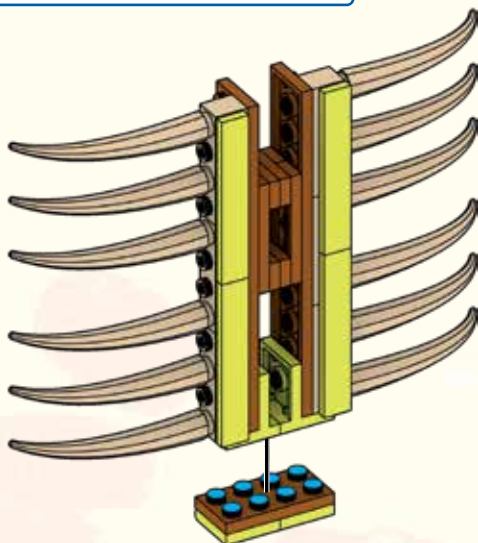

1

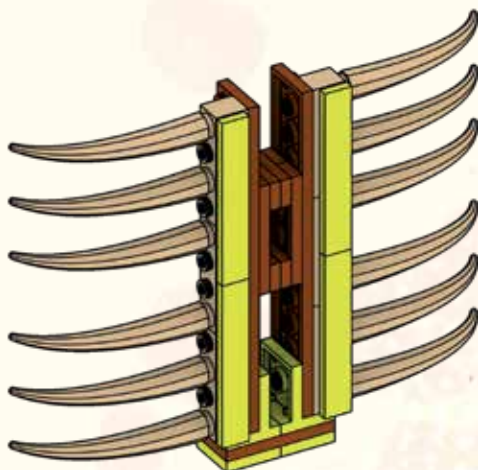

2

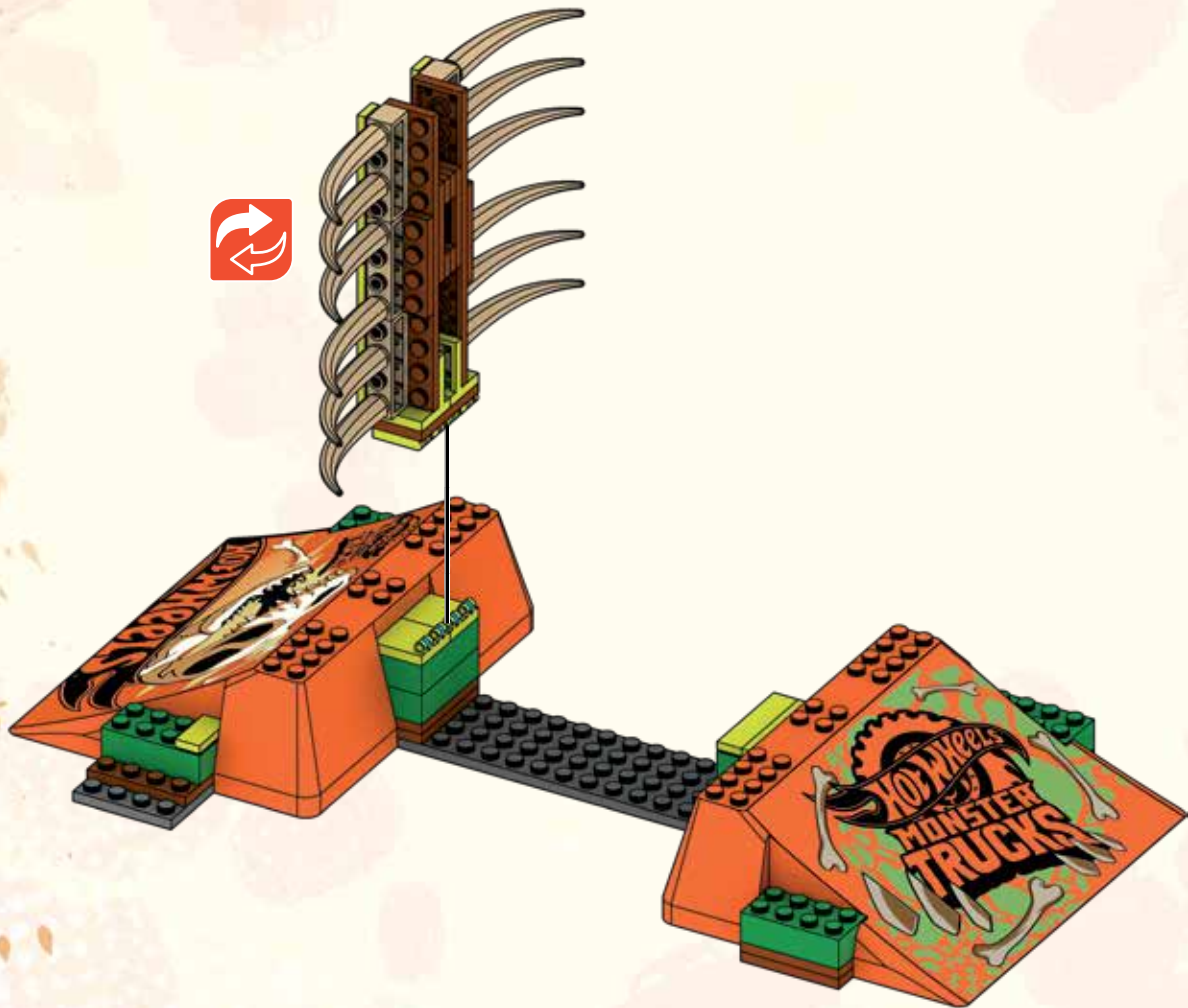

1

115



4x



4x



4x

x4



1



2

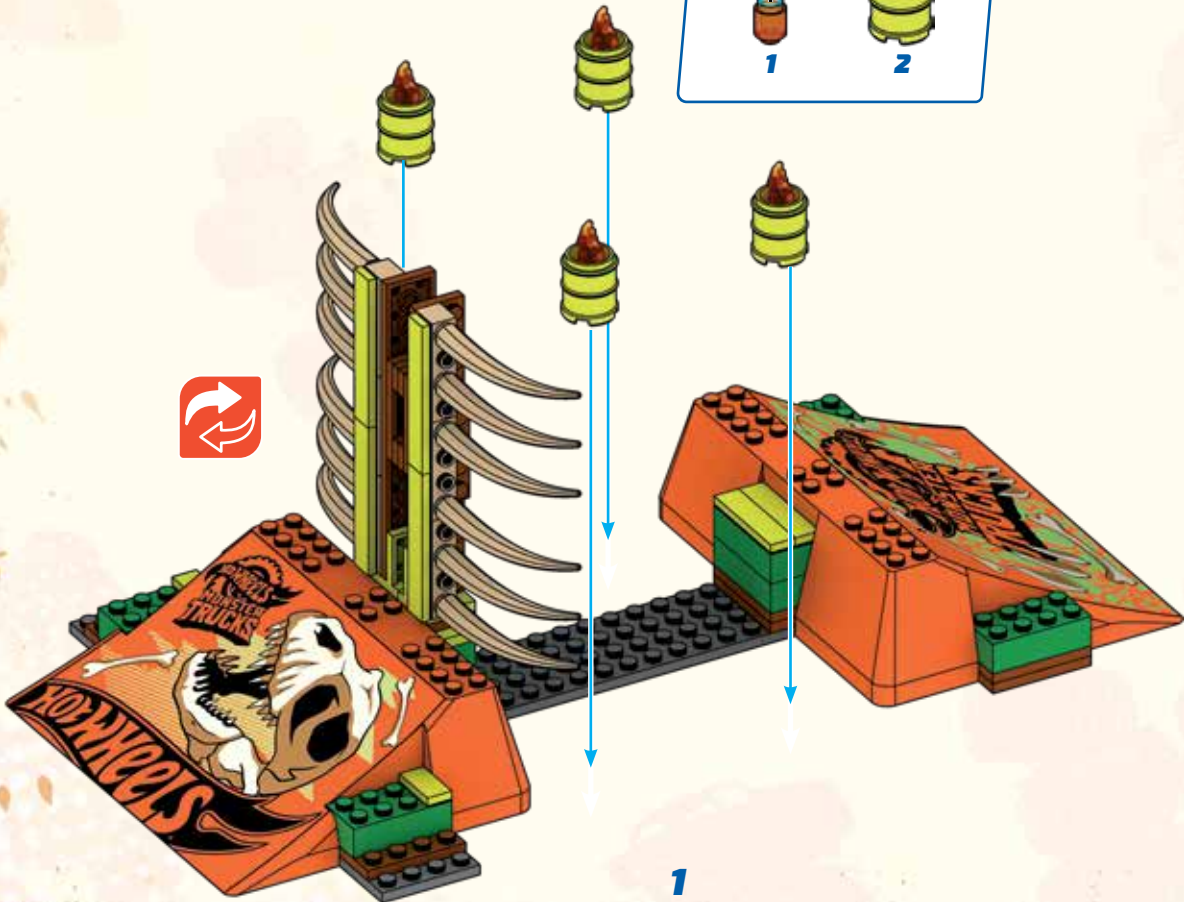

1

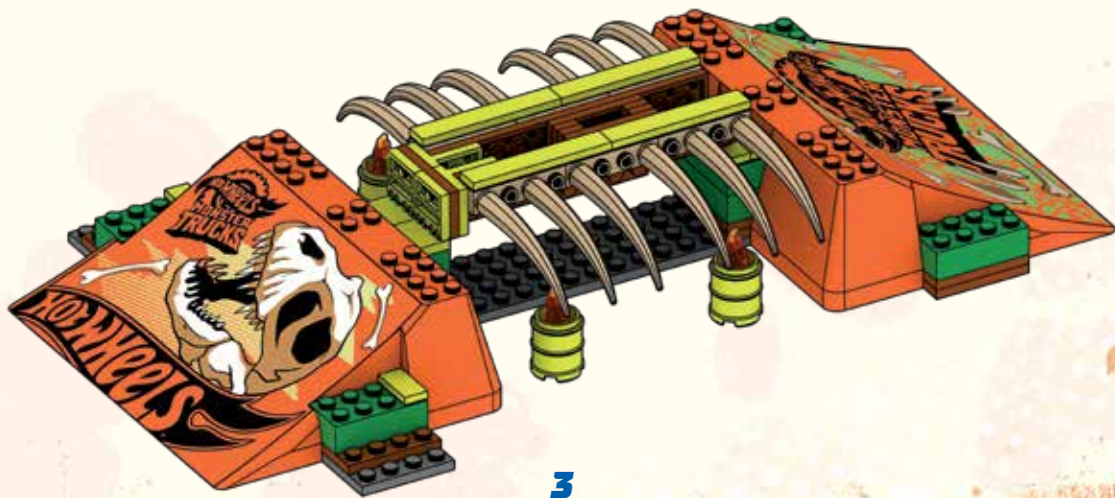
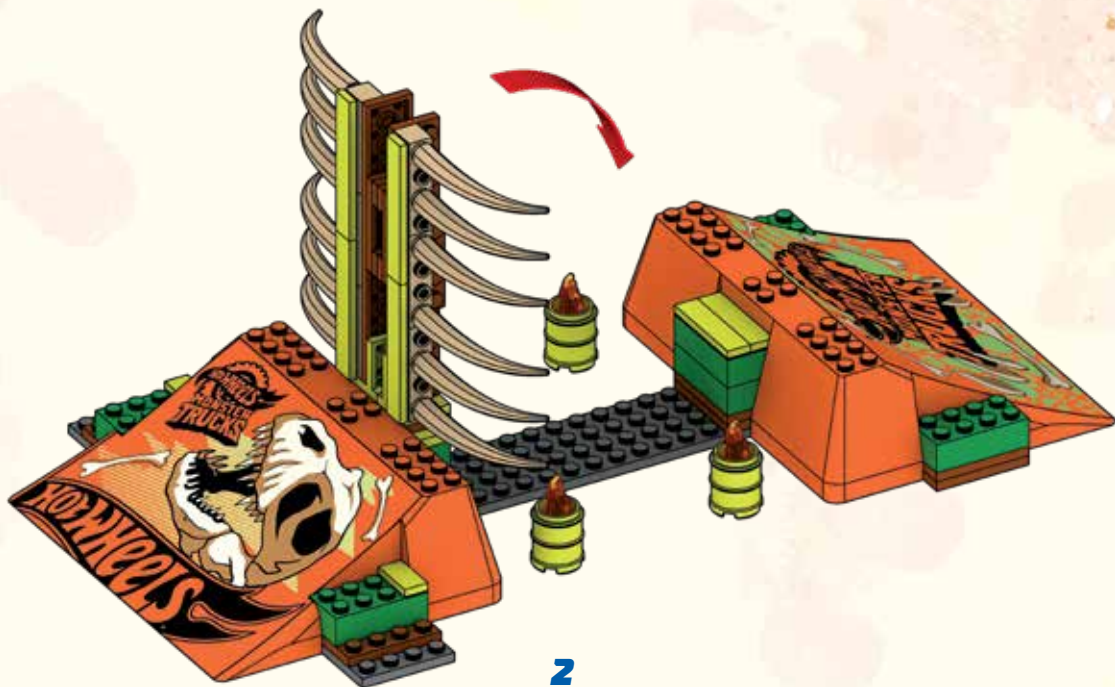



**Mega-Wrex™ Boneyard Stunt Course / Piste Cascades Mega-Wrex / Pista de acrobacias en el Cementerio Mega-Wrex
Mega Wrex Pista de Acrobacias / Percorso Sfasciacarrozze Mega-Wrex / Mega-Wrex Knochen Crash Stuntbahn
Mega-Wrex Tor przeszkód grozy / Mega-Wrex Stuntbaan op het Kerkhof / Трюки на свалке Mega-Wrex
Mega-Wrex Διαδρομή για Κόλπα / Mega-Wrex Dinozor Kemikli Aksiyon Sahası / Mega-Wrex dinócsontos kaszkadórpálya
Mega-Wrex Boneyard stundbana / Mega-Wrex-knoglestuntbane / مسار الحركات الاستعراضية**

⚠ WARNING: DO NOT AIM AT EYES OR FACE. ONLY USE PROJECTILES SUPPLIED WITH THIS TOY. DO NOT FIRE AT POINT BLANK RANGE.

ADVERTENCIA: NO APUNTAR A LOS OJOS NI A LA CARA. SI ADQUIRIÓ UN MODELO CON PROYECTIL(ES) INCLUIDO(S): UTILIZAR ÚNICAMENTE EL(LOS) PROYECTIL(ES) INCLUIDO(S) EN ESTE JUGUETE. NO DISPARAR A PERSONAS NI ANIMALES. NO DISPARAR A QUEMARROPA.

ATTENTION : NE PAS VISER LES YEUX OU LE VISAGE. NE PAS UTILISER D'AUTRES PROJECTILES QUE CEUX FOURNIS AVEC CE JOUET. NE PAS TIRER À BOUT PORTANT.

ATENÇÃO!: NÃO APONTAR PARA OS OLHOS E PARA A FACE. NÃO UTILIZAR PROJÉTEIS DIFERENTES DOS PROVIDOS E DOS INDICADOS PELO FABRICANTE DO BRINQUEDO.

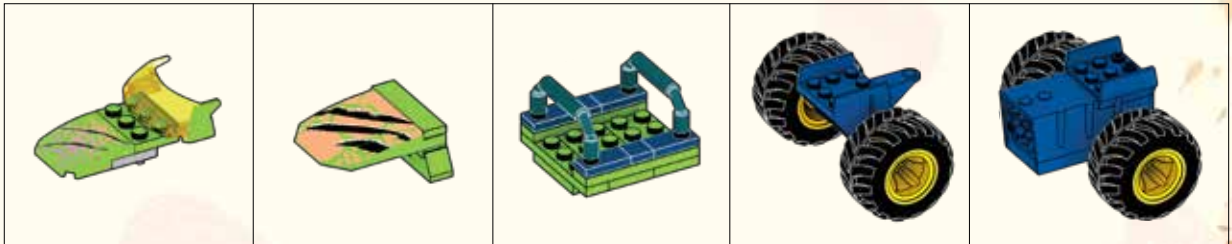
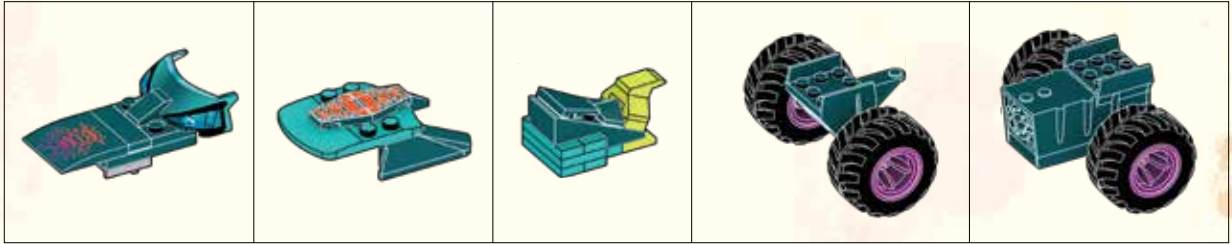

Avvertenza: Non mirare agli occhi o al viso. Usare solo i proiettili forniti con il giocattolo. Non sparare a distanza ravvicinata.

Achtung: Nicht auf Augen oder Gesicht zielen. Nur die zu diesem Spielzeug gehörenden Projektile verwenden. Nicht auf Menschen oder Tiere oder aus nächster Nähe zielen.

Ostrzeżenie: Nie celuj w oczy i twarz. Nie strzelaj pociskami innymi niż dostarczone z zabawką. Nie strzelaj z bliska.

Waarschuwing: niet op ogen of gezicht richten. Gebruik uitsluitend de bijgeleverde projectielen. Niet van te dichtbij afschieten.

Предупреждение: Не направляйте в глаза или лицо. Используйте только снаряды, входящие в комплект. Не стреляйте со слишком близкого расстояния.

Advarsel: Sigt ikke mot øjne eller ansikt. Brug kun de projektiler, som følger med legetøjet. Skyd ikke direkte på personer eller ting.

Varning: Sikta inte mot ögon eller ansikte. Använd endast projektiler som medföljer leksaken. Fyra inte av på mycket nära håll.

Advarsel: Du må ikke sikte mot øyne eller ansikt. Bruk bare prosjektilene som følger med leken. Ikke skyt på noe på kloss hold.

Varoitus: Älä tähtää silmiin äläkä kasvoihin. Käytä ainoastaan tämän tuotteen mukana tulleita ammuksia. Älä ammu lähietäisyydeltä.

Προσοχή: Μην στοχεύετε στα μάτια ή στο πρόσωπο. Χρησιμοποιείτε μόνο τα βλήματα που περιλαμβάνονται. Μην στοχεύετε όταν δεν έχετε ορατότητα.

Uyarı: Göze veya yüze nişan almayın. Fırlatmak için yalnızca bu oyuncakla birlikte verilen objeleri kullanın. İnsanlara ve hayvanlara nişan almayın.

Upozornění: Nemířte na oči nebo na obličej. Používejte pouze projektily dodávané s touto hračkou. Nestřílejte z bezprostřední blízkosti.

Upozornenie: Nemierite do očí ani do tváre. Používajte iba strely dodané spolu s touto hračkou. Nestrieľajte z bezprostrednej blízkosti.

Figyelmeztetés: Tilos szemre és arcra célozni. Kizárólag a játékhoz mellékelte lövedékeket használja. A játékkal tilos közvetlen közelről löni.

警告: 目や顔に向けてのご使用、至近距離での発射はお控えください。このおもちゃの同梱物のみご使用ください。

تحذير: يجب عدم التصويب باتجاه العينين أو الوجه. يجب استخدام المقذوفات المزودة مع هذه اللعبة فقط. يجب عدم الإطلاق من مدى قريب.

警告: 请勿对着眼睛或脸部发射。仅使用本玩具自带的抛射物。请勿近距离射击。

1

**PULL BACK AND GO!
TIREZ LE VÉHICULE VERS
L'ARRIÈRE ET PARTEZ !**

¡HAZLO RODAR HACIA ATRÁS Y SUÉLTALO!
PUXA PARA TRÁS PARA ARRANCAR!
ZURÜCKZIEHEN UND LOSS GEHT'S!
ПОТЯНИ И ЗАПУСТИ!

**2**

**HIT THE RAMP & BARRIER,
WATCH IT FLIP!
PERCUTEZ LA RAMPE ET
LA BARRIÈRE, REGARDEZ-LA
SE RENVERSER**

GOLPEA LA RAMPA Y LA BARRERA
MIRA CÓMO DA UNA VUELTA
A RAMPA E A BARREIRA
VÊ O VEÍCULO DAR UMA VOLTA
GEGEN DIE RAMPE UND DAS HINDERNIS
FAHRENVERRÜCKTE ÜBERSCHLÄGE
СТОЛКНИСЬ С РАМПОЙ ИЛИ
ПРЕПЯТВИЕМСМОТРИ, КАК МАШИНКА
ПЕРЕВОРАЧИВАЕТСЯ



**SMASH
&
CRASH™**

3

PIECES FLY OFF on IMPACT
LES ÉLÉMENTS VOLENT LORS DE L'IMPACT

LAS PIEZAS SALEN VOLANDO POR EL IMPACTO
AS PEÇAS VOAM COM O IMPACTO
BEIM AUFSCHLAG FLIEGEN TEILE AB
ДЕТАЛИ ВЫЛЕТАЮТ ПРИ СТОЛКНОВЕНИИ





4x
AM74397VF



2x
AM07223MD



1x
AS-HKF89-05



1x
AM07223VF



3x
AM03328AYR



6x
AM03328ANY



3x
AM03328VF



2x
AM03328CV



2x
AM79590VF



1x
AM80546ANY



1x
AM80546AYR



1x
AM74299VF



1x
AM74299CV



1x
AM74300VF



1x
AM74300CV



2x
AM17127KC



1x
AM17018VF



1x
AM17018AYR



1x
AM17131VF



1x
AM72002ANY



1x
AM19165ANY



4x
AM76052VF



1x
AM72973BTN



1x
AM01086F



4x
AM00910KC



2x
AM81383F



2x
AM22501VF



3x
AM22501AYR



2x
AM22501ANY



4x
AM187568YE



2x
AM73758AYR



4x
AM73758MD



3x
AM73758VF



1x
AM73758CV



1x
AM07590AYR



2x
AM07590ANY



7x
AM09393AYR



3x
AM09393CV



2x
AM09393ANY



2x
AM09393VF



4x
AM09393ANM



2x
AM16680ANM



1x
AM09835ANY



1x
AM17130CV



1x
AM17129CV



1x
AS-HKF89-06



1x
AS-HKF89-07



4x
AM16914KC



1x
AM19061AYR



1x
AM19061ANY



1x
AM09013ANY



4x
AM81353ANY



2x
AM16972CV



2x
AM15484VF



2x
AS-HKF89-03



1x
AM76456VF



4x
AM09267ANY



4x
AM09268ANY



1x
AM76379ANY



1x
AM76653APG



2x
AM72233VF



1x
AS-HKF89-22



3x
AM80966AYR



2x
AM80966CV



3x
AM80966VF

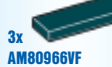

2x
AM74298CV



2x
AM81259VF



3x
AM01314F



1x
AM01314CV



5x
AM01314VF



3x
AM01314BYE



9x
AM01314AYR



1x
AM16384AYR



1x
AM16384VF



1x
AS-HKF89-10



1x
AS-HKF89-11



1x
AS-HKF89-12



1x
AS-HKF89-13



2x
AM81639VF



3x
AM03772AYR

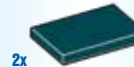

2x
AM03772BYE



3x
AM03772CV



2x
AM03772VF



1x
AM03772VF



2x
AM03772CV



1x
AM03772VF



2x
AM81688APG



4x
AM15064ANY



2x
AM80958ANY



1x
AM77465CV



1x
AS-HKF89-08



1x
AS-HKF89-09



1x
AS-HKF89-23



1x
AS-HKF89-24



2x
AM80972AYR



1x
AS-HKF89-18



4x
AM81640AMC



1x
AM09593AYR



3x
AM09593VF



10x
AM09593ANM



1x
AM09838AYR



2x
AM09838ANY



1x
AS-HKF89-19



1x
AS-HKF89-20



6x
AM17503BTN



1x
AM81336AYR



1x
AS-HKF89-04



4x
AM81163VF



2x
AM81163AYR



1x
AM81163BYE



1x
AM80921ANY



1x
AM19014CV



1x
AM19013CV



2x
AM07475BYE



3x
AM07475AYR



2x
AM17793AYR



2x
AS-HKF89-14



7x
AM09493ANM



1x
AM09493VF



8x
AM09033BMG



1x
AS-HKF89-15



1x
AS-HKF89-21



2x
AM17054BDG



1x
AM79253CV



1x
AS-HKF89-17



1x
AM80968VF



3x
AM80965AYR



2x
AM80965VF



1x
AM17194VF



1x
AM81540AYR



2x
AM16331VF



4x
AM16331ANY



12x
AM79670BTN



1x
AS-HKF89-25



1x
AS-HKF89-26



1x
AS-HKF89-27



1x
AS-HKF89-28



2x
AS-HKF89-32



2x
AS-HKF89-33



2x
AS-HKF89-34



2x
AS-HKF89-35



1x
AM81631AYR



1x
AM81631F



1x
AM81331VF



1x
AM81331B



1x
AS-HKF89-36

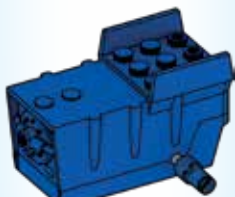

1x
AS-HKF89-37

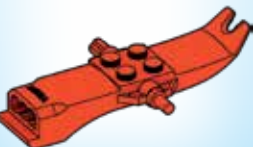

1x
AM80855MCX



1x
FIG-HKF89-A



1x
FIG-HKF89-B



1x
AS-HKF89-01



1x
AS-HKF89-02

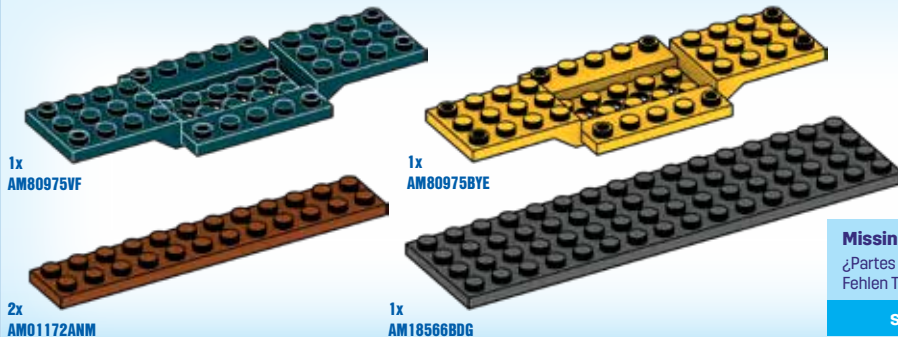

1x
AM80975F

1x
AM80975BE

2x
AM01172ANM

1x
AM18566BDG

Missing pieces? • Pièces manquantes?

¿Partes faltantes? • Perdeu peças?
Fehlen Teile? • Не хватает деталей?

support.megabrands.com



WARNING:
CHOKING HAZARD – Small parts.
Not for children under 3 years.

ATTENTION :
DANGER D'ÉTOUFFEMENT –
PETITS ÉLÉMENTS. NE
CONVIENT PAS AUX ENFANTS
DE MOINS DE 36 MOIS.

ATENÇÃO: NÃO INDICADO / NÃO RECOMENDÁVEL PARA CRIANÇAS MENORES DE 3 (TRÊS) ANOS POR CONTER PARTE(S) PEQUENA(S) QUE PODE(M) SER ENGOLIDA(S) OU ASPIRADA(S) PODENDO PROVOCAR ASFIXIA.

WARNING: Small parts, **ATTENTION :** PETITS ÉLÉMENTS, **ACHTUNG:** Kleine Teile, **AVVERTENZA:** Piccole parti, **WAARSCHUWING:** Kleine onderdelen, **ADVERTENCIA:** PELIGRO DE ATRAGANTAMIENTO. Juguete no recomendado para menores de 3 años, porque contiene piezas pequeñas que podrían provocar asfixia en caso de ser ingeridas o inhaladas por el/la niño/a, **VARNING:** Små delar, **VAROITUS:** Pieniä osia, **ADVASEL:** Små dele, **ADVASEL:** Små deler, **OSTRZEŻENIE:** Małe części, **UPOZORNĚNÍ:** Malé části, **UPOZORNENIE:** Malé části, **FIGYELMEZTETÉS:** Kis alkatrészek, **ПРЕДУПРЕЖДЕНИЕ:** Мелкие детали, **ΠΡΟΕΙΔΟΠΟΙΗΣΗ:** Μικρά κομμάτια, **UYARI:** Küçük parçalar.



警告: 切割 صغيرة. 的どにつまる危険 小さな部品が含まれています 3歳以下の子供には与えないで下さい。

警告! 不适合3岁以下儿童使用。内含小零件。

Mattel Europa B.V., Gondel 1, 1186 MJ Amstelveen, Nederland. Mattel U.K. Limited, The Porter Building, 1 Brunel Way, Slough SL1 1FQ, UK. Mattel France, Parc de la Cerisaie, 1/3/5 allée des Fleurs, 94260 Fresnes Cedex. N° Cristal 0969 36 99 99 (Numéro non surtaxé) ou www.lesjouetsmattel.fr Mattel Belgium N.V. De Kleetlaan 4, 1831 Machelen (Diegem) Belgium. Deutschland: Mattel GmbH, Solmsstraße 83, D-60486 Frankfurt am Main, Schweiz: Mattel AG, Kirchstrasse 24, CH-3097 Liebefeld, Österreich: Mattel Ges.m.b.H., Campus 21, Liebenmannstraße A01 404, A-2345 Brunn/Gebrige, Mattel Italy Srl, Via Turati 4, 20121 Milano, Italy, Servizio assistenza clienti: Customersrvitalia@mattel.com - Numero verde 800 11 37 11, Mattel España, S. A. Aribau 200 pl. 9, 08036 Barcelona. cservice.spain@mattel.com Tel.: +34 933 06 79 00 <http://www.service.mattel.com/es> Hong Kong: Kids Kingdom Limited, Room 1908-9, Gala Place, 56 Dundas Street, Mongkok, Kowloon, Hong Kong. Customer Care line: (852)2782-0766. Taiwan: Chickabiddy Company Limited 5/F, No. 186, Section 4, Nanjing East Road, Taipei 10595, Taiwan. Customer Care line: (02)2578-1188. Mainland China: Mattel Barbie (Shanghai) Trading Co., Ltd. Units 4701-4711, 47F, 2 Grand Gateway 3 Hong Qiao Road, Shanghai, 200030, P.R.C. Customer Care line: 400-819-8658. Diiimport & Diederkan Oleh: Mattel Continental Asia Sdn Bhd, Level 19, Tower 3, Avenue 7, No. 8 Jalan Kerinchi, Bangsar South, 59200 Kuala Lumpur, Malaysia. Mattel South Africa (PTY) LTD, Office 102 I3, 30 Melrose Boulevard, Johannesburg 2196. Distributor: Mattel Poland Sp. z o.o. Warsaw Trade Tower 34 p., ul. Chlodna 51, 00-867 Warszawa, Mattel Australia Pty Ltd., 658 Church St., Richmond, Victoria, 3121. Consumer Advisory Service - 1300 135 312. Mattel AEBE, ΕΒνδοχου Μαρκοπού 1, Κτήριο Κ-2, ΤΚ 17561, Πολυαίο Φάληρο, Mattel Oyuncakçılık Tic. Ltd. Şti. İçerenköy Mah., Umut Sokak No: 10 - 12, Quick Tower kat:2 İçari no:15 Ataşehir 34752, İstanbul, Türkiye. Tel:0216 570 75 00. Импортёр/Уполномоченная организация: ООО "МАТТЕЛ" Российская Федерация, 105120 Москва, 2-й Сыромятинский переулок 1; +7 495 287 79 39. Mattel Czech Republic s.r.o., The Forum, Václavské nám. 19, 11000 Praha1, Mattel, Inc. 636 Girard Avenue, East Aurora, NY 14052, U.S.A. Mattel Canada Inc., Mississauga, Ontario L5R 3W2. Consumer Services: You may call us free at / Composez sans frais le 1-800-524-8697. Importado y distribuido por Mattel de México S.A. de CV, Miguel de Cervantes Saavedra No. 193, Pisos 10 y 11, Col. Granada, Alcatdia Miguel Hidalgo, C.P. 11520, México, Ciudad de México. R.F.C. MME-920701-NB3. Tels: 59-05-51-00 Ext. 5206 ó 01-800-463-59-89. Mattel Chile, S.A., Avenida América Vespucio 501-B, Quilicura, Santiago, Tel.: 1230-020-6213. Servicio al consumidor Venezuela: Tel.: 0-800-100-9123. Mattel Argentina, S.A., Av. Libertador 1000, Piso 11 – Oficinas 109 y 111, Vicente López – Prov. Buenos Aires. Tel.: 0800-666-3373. Mattel Colombia, S.A., Calle 123#7-07 P5, Bogotá. Tel.: 01800-710-2069. Mattel Perú, S.A., Av. Juan de Arona # 151, Centro Empresarial Juan de Arona, Torre C, Piso 7, Oficina 704, San Isidro, Lima 27, Perú. RUC: 20425853865. Reg. Importador: 02350-12-JUE-DIGESA. Tel.: 0800-54744. E-mail Latinoamérica: servicio.clientes@mattel.com. Mattel do Brasil Ltda - CNPJ: 54.558.002/0001-20 - Rua Verbo Divino, 1488 - 2º. Andar - 04719-904 - Chácara Santo Antônio - São Paulo - SP - Brasil. Serviço de Atendimento ao Consumidor: fone 0800 575 0780. E-mail: sac.matteldobrazil@mattel.com

BUILD YOUR WAY CONSTRUIS TON UNIVERS



HKF89



HNG52



HKF87

Crea tu camino | Constrói à tua maneira
Bauen, wie es dir gefällt! | Построй мир по-своему

Set(s) sold separately and subject to availability. / Ensemble(s) vendu(s) séparément. Certains produits peuvent ne pas être commercialisés. / Se vende(n) por separado y está(n) sujeto(s) a disponibilidad. / Conjunto(s) vendido(s) em separado e sujeito(s) à disponibilidade. / Set in vendita separatamente, secondo disponibilità. / Das/Die Set(s) sind separat erhältlich. / Zestaw(y) sprzedawany(e) oddzielnie w zależności od dostępności. / Set(s) apart verkrijgbaar en afhankelijk van beschikbaarheid. / Набор(-ы) продаются отдельно, при наличии. / Sæt sælges separat og så længe lager haves. / Seten säljs separat så länge lagret räcker. / Settet/settene selges separat så langt lageret rekker. / Pakkaus/pakkaukset myydään erikseen, saatavuus voi vaihdella. / Το(α) οετ πωλούνται ξεχωριστά και ανάλογα με τη διαθεσιμότητα. / Setler ayrı olarak satılır ve stoklarla sınırlıdır. / Set (sety) se prodává (prodávají) samostatně dle aktuální nabídky. / Сүправа/-y sa predává(jú) samostatne a podľa dostupnosti. / A készlet(ek) külön kapható(k), az elérhetőség változhat. / セット商品は別売りになります。在庫状況は別途ご確認をお願いします。 / تباع المجموعة أو المجموعات على حدة وتخضع لتوافرها. / 每套单独发售，按供货情况决定。

1186 MJ, 1, NL

© P714,887, D841,101

Mattel Canada Inc. Mississauga, Ontario L5R 3W2.
MADE IN CHINA. FABRIQUÉ EN CHINE. FABRICADO NA CHINA. HECHO EN CHINA.
ИЗГОТОВЛЕНО В КИТАЕ. ÇIN'DE ÜRETİLMİŞTİR. صنع في الصين

©2022 MEGA Brands &™ MEGA Brands.
Printed in China / Imprimé en Chine

AD-HKF89-01C



HOT WHEELS™ and associated trademarks and trade dress are owned by, and used under license from, Mattel. ©2022 Mattel.

