

**MEGA**<sup>TM</sup>

**HOT WHEELS**<sup>TM</sup>  
**MONSTER TRUCKS**<sup>TM</sup>



HNG52

**GUNKSTER<sup>TM</sup> MONSTER TRUCK**  
**CAMIÓN DE CARRERAS**

**SMASH & CRASH**<sup>TM</sup>



## Build Construisez

Construye | Constrói  
Bauen | Стройте



## Share | Partagez

Comparte | Partilha  
Teilen | Делитесь



## Easy-to-follow steps! Des instructions faciles à suivre !

¡Pasos fáciles de seguir!  
Passos fáceis de seguir!  
Einfache Schritte!  
Простые действия!



Devices not included | Appareils non inclus | Dispositivos no incluido | Dispositivos não incluídos | Geräte nicht enthalten | Устройства не входят в комплект

[megaunboxed.com](http://megaunboxed.com)



1



2

2



2x

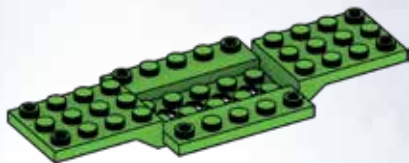

1x

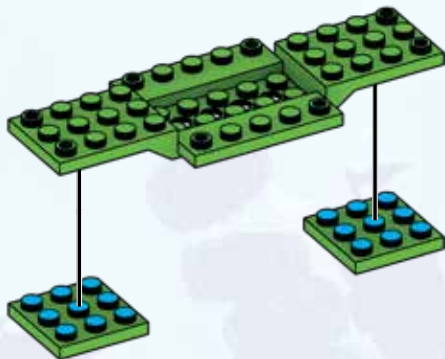

3



1x



1x



1x

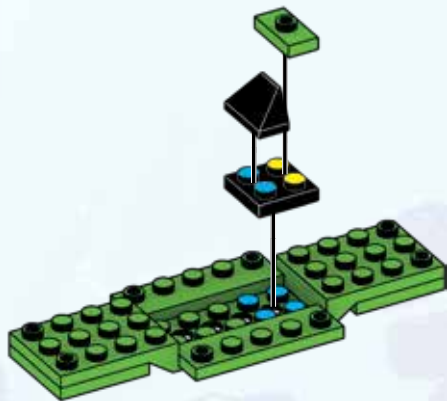

4



2x

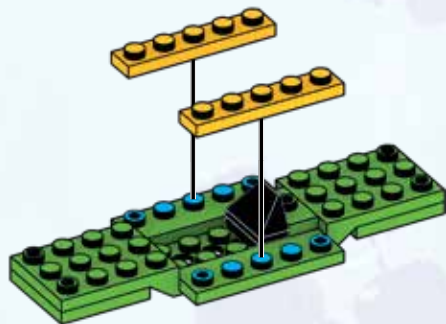

5



1x



1x

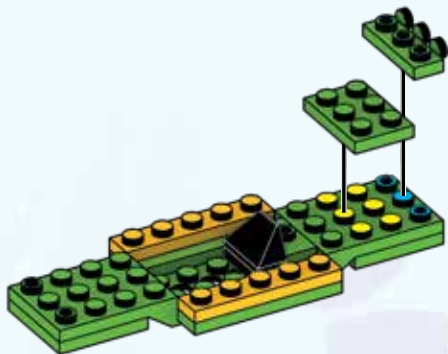

6



2x



1x

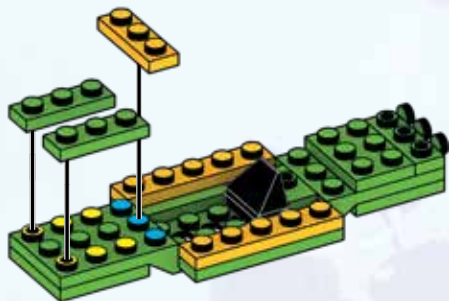

7



1x



1x



1x

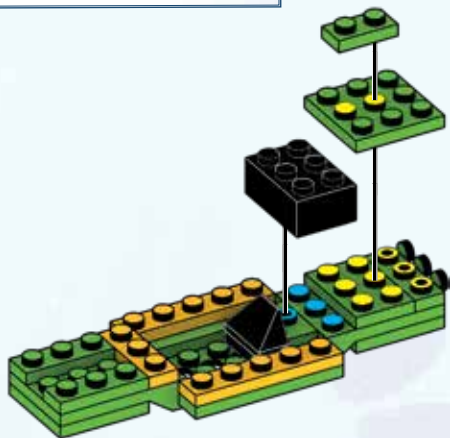



8



2x



1x



1x

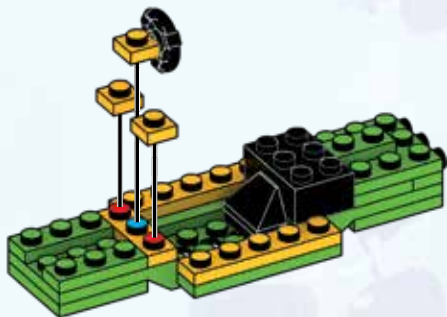
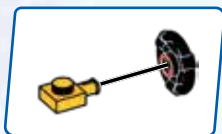

9



1x



1x



2x

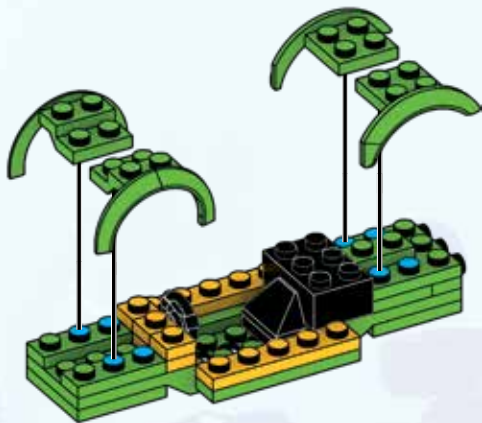

10



2x

11



1x



1x

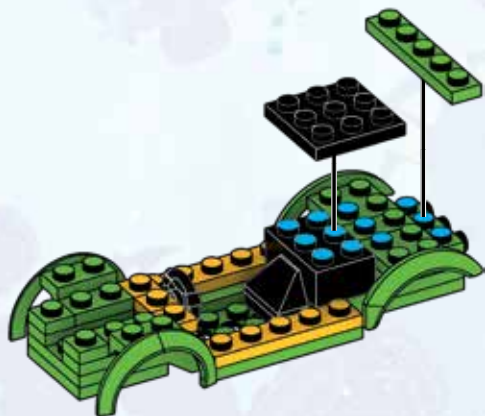
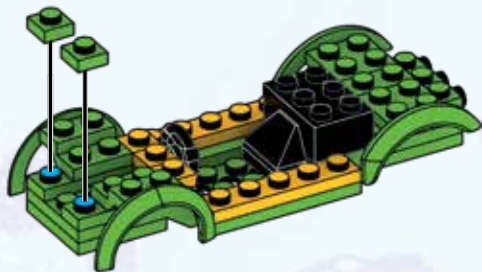

12



1x



1x



1x

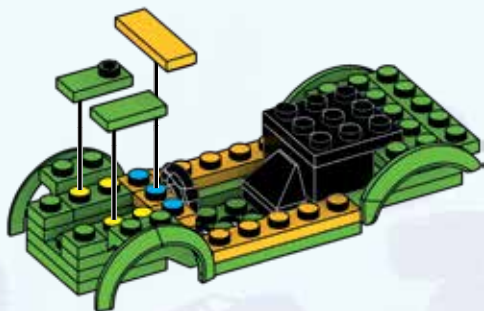

13



1x



1x

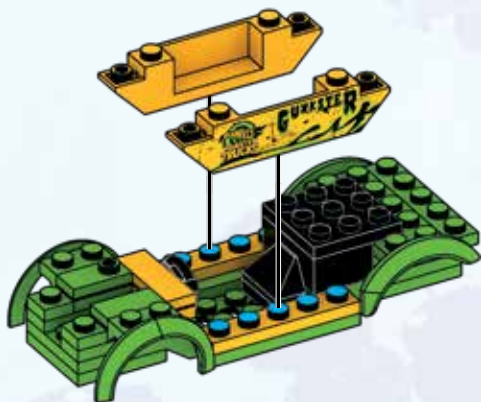

14



2x



2x

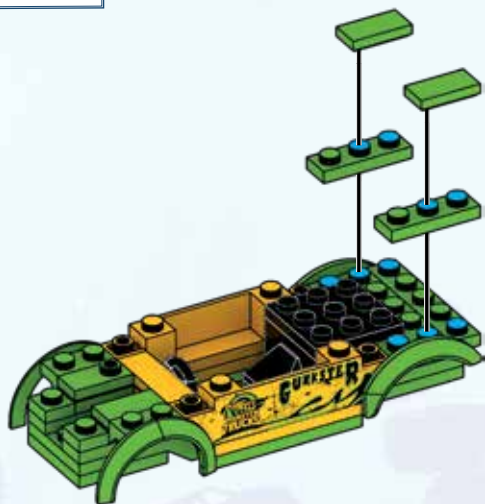

15



2x

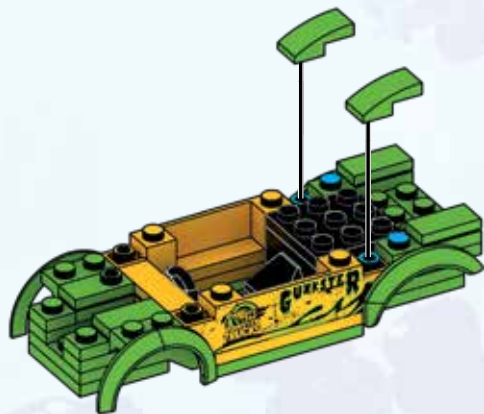

16



1x



1x

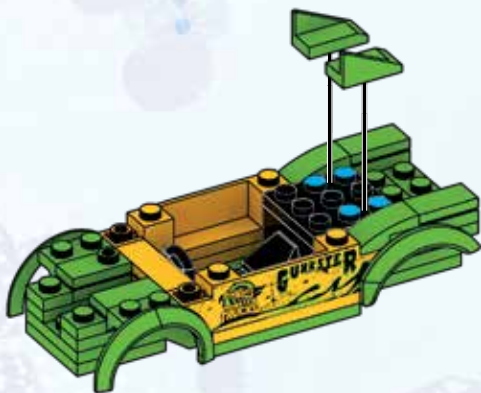

1

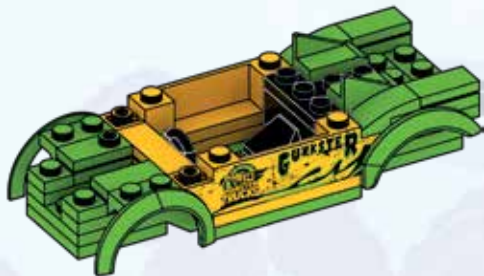

2



**17**

1x



1x

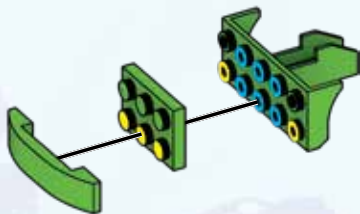

1x

**18**

2x



1x

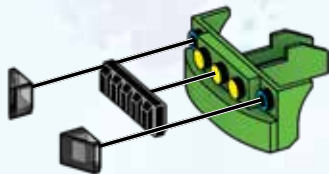

1



2

19

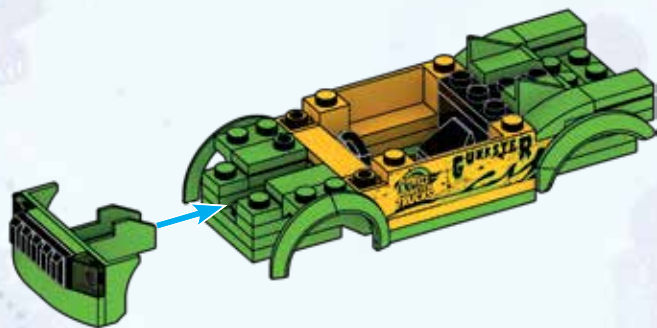

20



1x

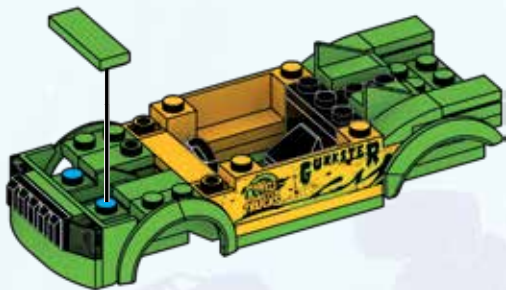

21



1x

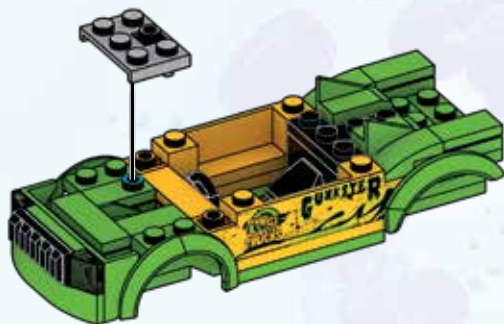

22



2x

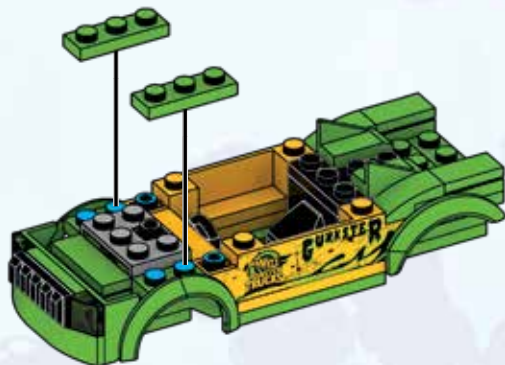

23



1x



1x



1x



1x



1x

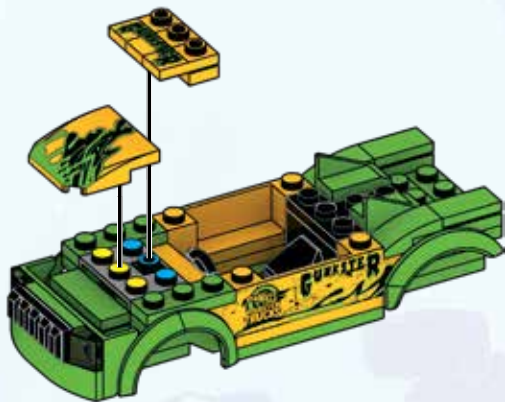
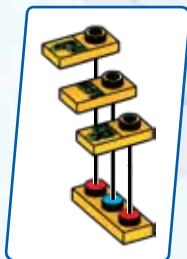

24



2x

1x

1x

25



1x

2x

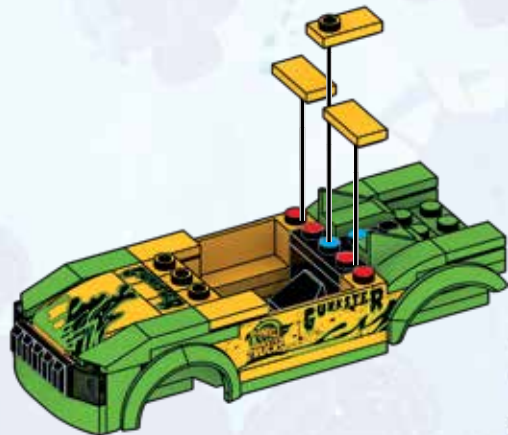
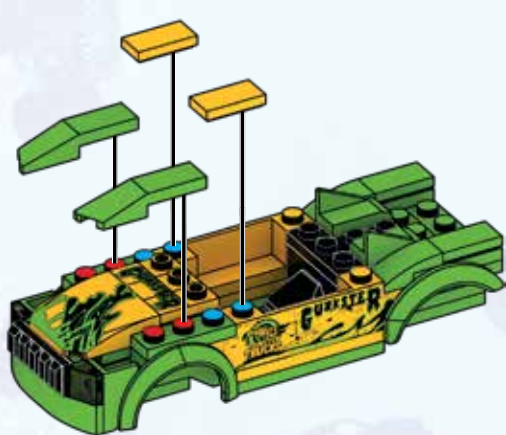

26



1x



1x

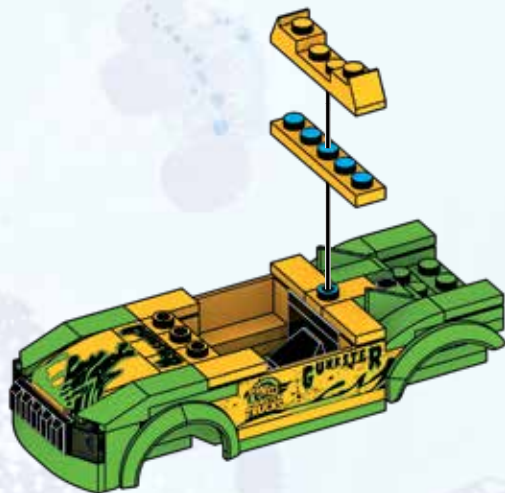

27



1x

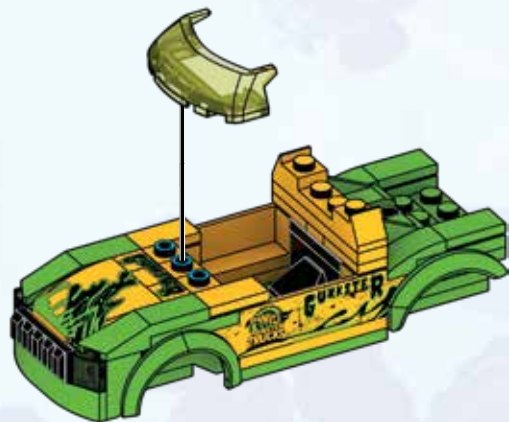

28



1x



1x

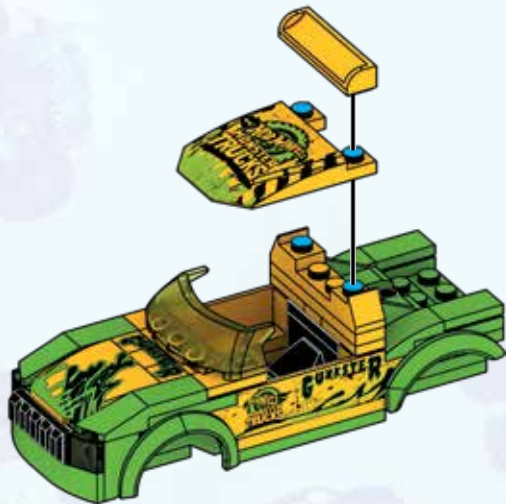

1



2

29



1x



1x



1x

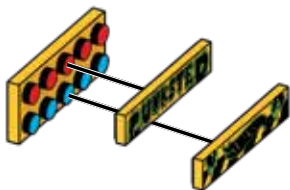

1



2

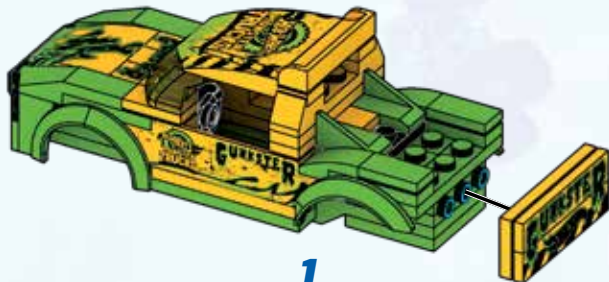

1



2



**30**



1x

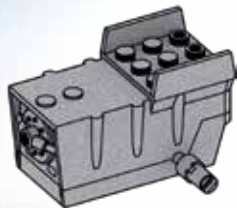

1x

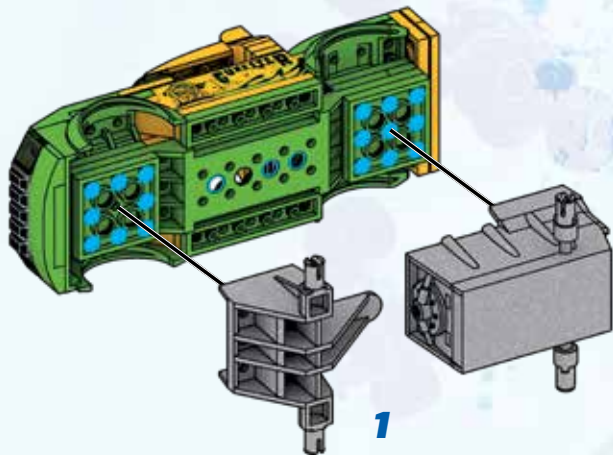

1

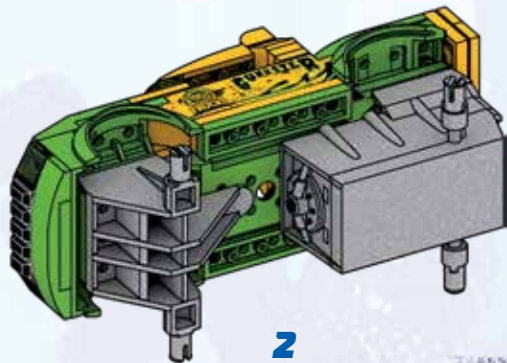

2

31



2x



2x

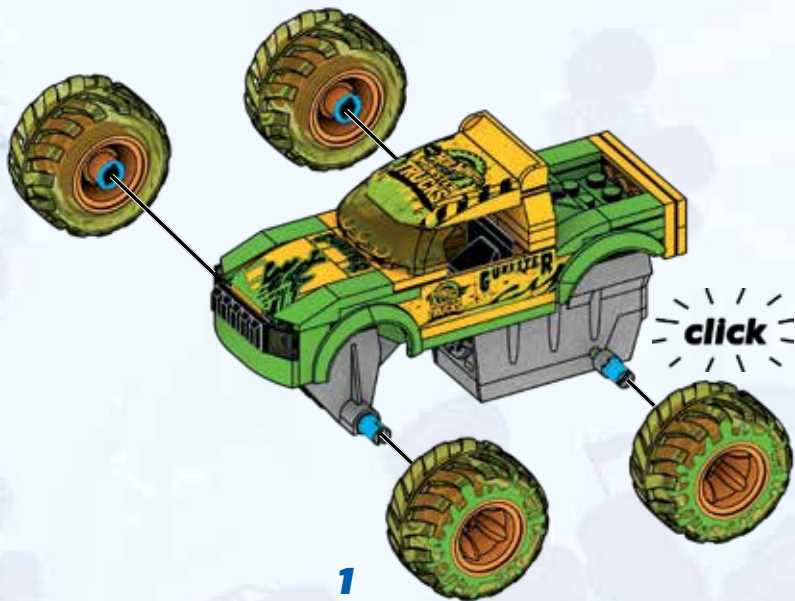

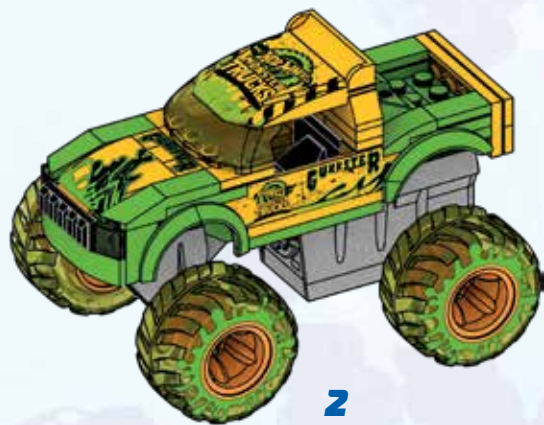



Gunkster™ Monster Truck / Gunkster Camión de carreras / Gunkster Машинка монстр-трак  
Gunkster Szörnyjárgány / Gunkster Monster / شاحنة

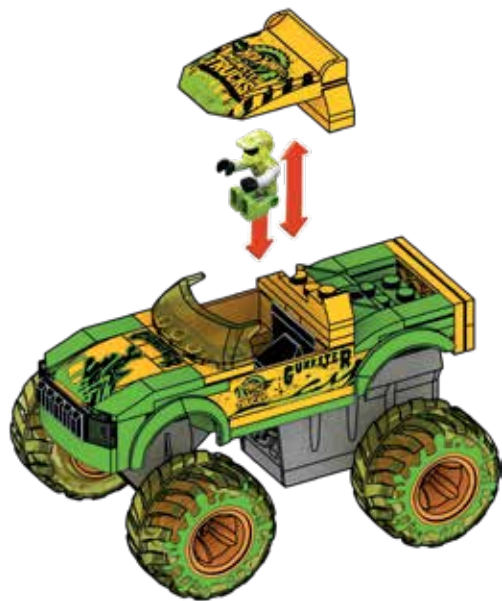

**SMASH  
&  
CRASH™**

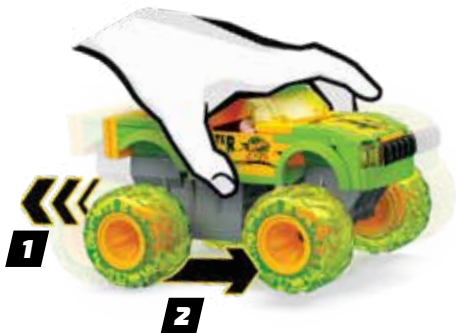

**1**

**PULL BACK AND GO!**

**TIREZ LE VÉHICULE VERS L'ARRIÈRE ET PARTEZ !**

¡HAZLO RODAR HACIA ATRÁS Y SUÉLTALO!  
 PUXA PARA TRÁS PARA ARRANCAR!  
 ZURÜCKZIEHEN UND LOSS GEHT'S!  
 ПОТЯНИ И ЗАПУСТИ!



**2**

**PIECES FLY OFF ON IMPACT**

**LES ÉLÉMENTS VOLENT LORS DE L'IMPACT**

LAS PIEZAS SALEN VOLANDO POR EL IMPACTO  
 AS PEÇAS VOAM COM O IMPACTO  
 BEIM AUFSCHLAG FLIEGEN TEILE AB  
 ДЕТАЛИ ВЫЛЕТАЮТ ПРИ СТОЛКНОВЕНИИ

**SMASH  
&  
CRASH™**

**Rebuild & play**  
**Reconstruire et jouer**

**Reconstruir y jugar**  
**Reconstruir e brincar**  
**Umbauen und spielen**  
**перестроить и играть**

**1**



**2**

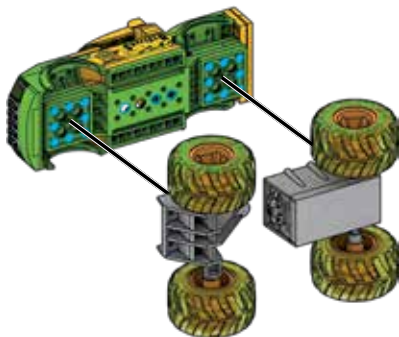

**3**



⚠ WARNING: DO NOT AIM AT EYES OR FACE. ONLY USE PROJECTILES SUPPLIED WITH THIS TOY. DO NOT FIRE AT POINT BLANK RANGE.

ADVERTENCIA: NO APUNTAR A LOS OJOS NI A LA CARA. SI ADQUIRIÓ UN MODELO CON PROYECTIL(ES) INCLUIDO(S): UTILIZAR ÚNICAMENTE EL(LOS) PROYECTIL(ES) INCLUIDO(S) EN ESTE JUGUETE. NO DISPARAR A PERSONAS NI ANIMALES. NO DISPARAR A QUEMARROPA.

**ATTENTION** : NE PAS VISER LES YEUX OU LE VISAGE. NE PAS UTILISER D'AUTRES PROJECTILES QUE CEUX FOURNIS AVEC CE JOUET. NE PAS TIRER À BOUT PORTANT.

**ATENÇÃO!**: NÃO APONTAR PARA OS OLHOS E PARA A FACE. NÃO UTILIZAR PROJÉTEIS DIFERENTES DOS PROVIDOS E DOS INDICADOS PELO FABRICANTE DO BRINQUEDO.



Avvertenza: Non mirare agli occhi o al viso. Usare solo i proiettili forniti con il giocattolo. Non sparare a distanza ravvicinata.

Achtung: Nicht auf Augen oder Gesicht zielen. Nur die zu diesem Spielzeug gehörenden Projektile verwenden. Nicht auf Menschen oder Tiere oder aus nächster Nähe zielen.

Ostrzeżenie: Nie celuj w oczy i twarz. Nie strzelaj pociskami innymi niż dostarczone z zabawką. Nie strzelaj z bliska.

Waarschuwing: niet op ogen of gezicht richten. Gebruik uitsluitend de bijgeleverde projectielen. Niet van te dichtbij afschieten.

Предупреждение: Не направляйте в глаза или лицо. Используйте только снаряды, входящие в комплект. Не стреляйте со слишком близкого расстояния.

Advarsel: Sigtt ikke med øjne eller ansigt. Brug kun de projektiler, som følger med legetøjet. Skyd ikke direkte på personer eller ting.

Varning: Sikta inte mot ögon eller ansikte. Använd endast projektiler som medföljer leksaken. Fyra inte av på mycket nära håll.

Advarsel: Du må ikke sikte mot øyne eller ansikt. Bruk bare prosjektilene som følger med leken. Ikke skyt på noe på kloss hold.

Varoitus: Älä tähtää silmiin äläkä kasvoihin. Käytä ainoastaan tämän tuotteen mukana tulleita ammuksia. Älä ammu lähietäisyydeltä.

Προσοχή: Μην στοχεύετε στα μάτια ή στο πρόσωπο. Χρησιμοποιείτε μόνο τα βλήματα που περιλαμβάνονται. Μην στοχεύετε όταν δεν έχετε ορατότητα.

Uyarı: Göze veya yüze nişan almayın. Fırlatmak için yalnızca bu oyuncakla birlikte verilen objeleri kullanın. İnsanlara ve hayvanlara nişan almayın.

Upozornění: Nemířte na oči nebo na obličej. Používejte pouze projektily dodávané s touto hračkou. Nestřelejte z bezprostřední blízkosti.

Upozornenie: Nemířte do očí ani do tváre. Používajte iba strely dodané spolu s touto hračkou. Nestrieľajte z bezprostrednej blízkosti.

Figyelmeztetés: Tilos szemre és arcra célozni. Kizárólag a játékhoz mellékelte lövedékeket használja. A játékkal tilos közvetlen közelről löni.

警告: 目や顔に向けてのご使用、至近距離での発射はお控えください。このおもちゃの同梱物のみご使用ください。

تحذير: يجب عدم التصويب باتجاه العينين أو الوجه. يجب استخدام المقذوفات المزودة مع هذه اللعبة فقط. يجب عدم الإطلاق من مدى قريب.

**警告**: 请勿对着眼睛或脸部发射。仅使用本玩具自带的抛射物。请勿近距离射击。



2x  
AM03328JS



2x  
AM03328BYE



1x  
AM80546BYE



2x  
AM17127AGY



4x  
AM22501BYE



3x  
AM22501JS



1x  
AM73758JS



1x  
AM73758BYE



1x  
AM07590JS



1x  
AM09393JS



1x  
AS-HNG52-04



1x  
AS-HNG52-05



1x  
AS-HNG52-06



1x  
AM81383F



2x  
AM78486JS



1x  
AM81255JS



1x  
AM81256JS



1x  
AM19061F



1x  
AM03773F



1x  
AM80966JS



1x  
AM80966BYE



6x  
AM01314JS



2x  
AM01314BYE



1x  
AM74103F



1x  
AM81259JS



2x  
AM03772JS



1x  
AM81688APG



1x  
AM03873F



1x  
AM80982JS



1x  
AM80981JS



1x  
AM09921BYE



1x  
AM81366BYE



1x  
AM81540JS



1x  
AS-HNG52-08



1x  
AS-HNG52-09



1x  
AM07475JS



3x  
AM07475BYE



1x  
AM74398JS



1x  
AM74399JS



1x  
AM74399JS



2x  
AM80972JS





1x  
AS-HNG52-07



3x  
AM81163JS



1x  
AM81163F



1x  
AM80538Z



1x  
AM80965BYE



1x  
AM81631JS



2x  
AS-HNG52-10



2x  
AS-HNG52-11



1x  
AS-HNG52-03



1x  
AS-HNG52-01



1x  
AS-HNG52-02



1x  
FIG-HNG52-A

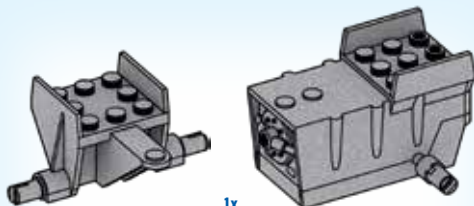

1x  
AM81331APG

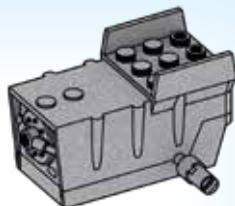

1x  
AS-HNG52-12

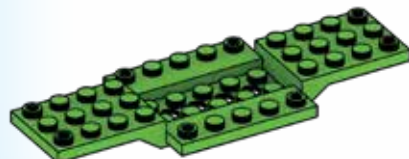

1x  
AM80975JS

**Missing pieces? • Pièces manquantes?**

¿Partes faltantes? • Perdeu peças?  
Fehlen Teile? • Не хватает деталей?

[support.megabrand.com](http://support.megabrand.com)



**WARNING:**  
CHOKING HAZARD – Small parts.  
Not for children under 3 years.

**ATTENTION :**  
**DANGER D'ÉTOUFFEMENT –**  
**PETITS ÉLÉMENTS. NE**  
**CONVIENT PAS AUX ENFANTS**  
**DE MOINS DE 36 MOIS.**

**ATENÇÃO:** NÃO INDICADO / NÃO RECOMENDÁVEL PARA CRIANÇAS MENORES DE 3 (TRÊS) ANOS POR CONTER PARTE(S) PEQUENA(S) QUE PODE(M) SER ENGLIDA(S) OU ASPIRADA(S) PODENDO PROVOCAR ASFIXIA.

**WARNING:** Small parts, **ATTENTION :** PETITS ÉLÉMENTS, **ACHTUNG:** Kleine Teile, **AVVERTENZA:** Piccole parti, **WAARSCHUWING:** Kleine onderdelen, **ADVERTENCIA:** PELIGRO DE ATRAGANTAMIENTO. Juguete no recomendado para menores de 3 años, porque contiene piezas pequeñas que podrían provocar asfixia en caso de ser ingeridas o inhaladas por el/la niño/a, **WARNING:** Små delar, **VAROITUS:** Pieniä osia, **ADVARSEL:** Små dele, **ADVARSEL:** Små deler, **OSTRZEŻENIE:** Małe części, **UPOZORNĚNÍ:** Malé části, **UPOZORNENIE:** Malé časti, **FIGYELMEZTETÉS:** Kis alkatrészek, **ПРЕДУПРЕЖДЕНИЕ:** Мелкие детали, **ΠΡΟΕΙΔΟΠΟΙΗΣΗ:** Μικρά κομμάτια, **UYARI:** Küçük parçalar.



**警告:**

のどにつまる危険 小さな部品が含まれています 3歳以下の子供には与えないで下さい。

**警告!** 不适合3岁以下儿童使用。内含小零件。

**تحذير:** قطع صغيرة.

Mattel Europa B.V., Gondel 1, 1186 MJ Amstelveen, Nederland. Mattel U.K. Limited, The Porter Building, 1 Brunel Way, Slough SL1 1FQ, UK. Mattel France, Parc de la Cerisaie, 1/3/5 allée des Fleurs, 94260 Fresnes Cedex. N° Cristal 0969 36 99 99 (Numéro non surtaxé) ou [www.lesjouetsmattel.fr](http://www.lesjouetsmattel.fr) Mattel Belgium, Trade Mart, Atomiumsquare, Bogota 202 – B 275, 1020 Brussels. Gratis nummer België: 0800 – 16 936 - Gratis nummer Luxemburg: 800 – 22 784 - Gratis nummer Nederland: 0800 – 262 88 35. Deutschland : Mattel GmbH, Solmsstraße 83, D-60486 Frankfurt am Main. Schweiz: Mattel AG, Kirchstrasse 24, CH-3097 Liebefeld. Österreich: Mattel Ges.m.b.H., Campus 21, Liebermannstraße A01 404, A- 2345 Brunn/Gebirge, Mattel Italy Srl, Via Turati 4, 20121 Milano, Italy. Servizio assistenza clienti: [CustomerServ.italia@mattel.com](mailto:CustomerServ.italia@mattel.com) - Numero verde 800 11 37 11. Mattel España, S.A, Aribau 200 pl. 9, 08036 Barcelona. [cservice.spain@mattel.com](mailto:cservice.spain@mattel.com) Tel.: +34 933 06 79 00 <http://www.service.mattel.com/es> Hong Kong: Kids Kingdom Limited, Room 1908-9, Gala Place, 56 Dundas Street, Mongkok, Kowloon, Hong Kong. Customer Care line: (852)2782-0766. Taiwan: Chickabiddy Company Limited, 5/F, No. 186, Section 4, Nanjing East Road, Taipei 10595, Taiwan. Customer Care line: (02)2578-1188. Mainland China: Mattel Barbie (Shanghai) Trading Co., Ltd. Units 4701-4711, 47F, 2 Grand Gateway, 3 Hong Qiao Road, Shanghai, 200030, P.R.C. Customer Care line: 400-819-8658. Diimport & Diedarkan Oleh: Mattel Continental Asia Sdn Bhd. Level 19, Tower 3, Avenue 7, No. 8 Jalan Kerinci, Bangsar South, 59200 Kuala Lumpur, Malaysia. Mattel South Africa (PTY) LTD, Office 102 B, 30 Melrose Boulevard, Johannesburg 2196. Distributor: Mattel Poland Sp. z o.o., Warszawa Trade Tower 34 p., ul. Chłodna 51, 00-867 Warszawa. Mattel Australia Pty. Ltd., 658 Church St., Richmond, Victoria, 3121. Consumer Advisory Service - 1300 135 312. Mattel AEBE, Εθνικού Μακροπίου 1, Κτήριο Κ-2, ΤΚ 17561, Παλιό Φάληρο. Mattel Oyuncakçılık Tic. Ltd. Şti. İçerenköy Mah., Umut Sokak No: 10 - 12, Quick Tower kat:2 İçkari no:15 Ataşehir 34752, İstanbul, Türkiye. Tel: 0216 570 75 00. Импортёр/Уполномоченная организация: ООО "МАТТЕЛ" Российская Федерация, 105120 Москва, 2-й Сыромятнинский переулок 1; +7 495 287 79 39. Mattel Czech Republic s.r.o., The Forum, Václavské nám. 19, 11000 Praha1. Mattel, 333 Continental Boulevard, El Segundo, CA 90245, USA. Consumer Services: 1-800-465-MEGA (6342). Mattel Canada Inc., Mississauga, Ontario L5R 3W2. Consumer Services: You may call us free at/ Composez sans frais le 1-800-524-8697. Importado y distribuido por Mattel de México, S.A. de C.V., Miguel de Cervantes Saavedra No. 193, Pisos 10 y 11, Col. Granada, Alcaldía Miguel Hidalgo, C.P. 11520, México, Ciudad de México. R.F.C. MME-920701-NB3. Tels.: 59-05-51-00 Ext. 5206 ó 01-800-463-59-89. Mattel Chile, S.A., Avenida América Vespucio 501-B, Quilicura, Santiago. Tel.: 1230-020-6213. Servicio al consumidor Venezuela: Tel.: 0-800-100-9123. Mattel Argentina, S.A., Av. Libertador 1000, Piso 11 – Oficinas 109 y 111, Vicente López – Prov. Buenos Aires. Tel.: 0800-666-3373. Mattel Colombia, S.A., Calle 123#7-07 P.5, Bogotá. Tel.: 01800-710-2069. Mattel Perú, S.A., Av. Juan de Arona # 151, Centro Empresarial Juan de Arona, Torre C, Piso 7, Oficina 704, San Isidro, Lima 27, Perú. RUC: 20425853865, Reg. Importador: 02350-12-JUE-DIGESA. Tel.: 0800-54744. E-mail [Latinoamerica: servicio.clientes@mattel.com](mailto:Latinoamerica: servicio.clientes@mattel.com). Mattel do Brasil Ltda. - CNPJ: 54.558.002/0001-20 - Rua Verbo Divino, 1488 - 2ª Andar - 04719-904 - Chácara Santo Antônio - São Paulo - SP - Brasil. Serviço de Atendimento ao Consumidor: fone 0800 575 0780. E-mail: [sac.matteldobrazil@mattel.com](mailto:sac.matteldobrazil@mattel.com)

# BUILD YOUR WAY CONSTRUIS TON UNIVERS



HNG52



HKF87



HKF89



Crea tu camino | Constrói à tua maneira  
Bauen, wie es dir gefällt! | Построй мир гонок

Set(s) sold separately and subject to availability. / Ensemble(s) vendu(s) séparément. Certains produits peuvent ne pas être commercialisés. / Se vende(n) por separado y está(n) sujeto(s) a disponibilidad. / Conjunto(s) vendido(s) em separado e sujeito(s) à disponibilidade. / Set in vendita separatamente, secondo disponibilità. / Das/Die Set(s) sind separat erhältlich. / Zestaw(y) sprzedawany(e) oddzielnie w zależności od dostępności. / Set(s) apart verkrijgbaar en afhankelijk van beschikbaarheid. / Набор(ы) продаются отдельно, при наличии. / Sæt sælges separat og så længe lager haves. / Seten säljs separat så länge lagret räcker. / Settet/settene selges separat så langt lageret rekker. / Pakkaus/pakkaukset myydään erikseen, saatavuus voi vaihdella. / Το(α) σετ πωλούνται ξεχωριστά και ανάλογα με τη διαθεσιμότητα. / Setler ayrı olarak satılır ve stoklarla sınırlıdır. / Set (sety) se prodává (prodávají) samostatně dle aktuální nabídky. / Сúправа/-y sa prodávа(ју) samostatne a podľa dostupnosti. / A készlet(ek) külön kapható(k), az elérhetőség változhat. / セット商品は別売りになります。在庫状況は別途ご確認をお願いします。 / تباع المجموعة أو المجموعات على حدة وتخضع لتوافرها. 每套单独发售，按供货情况决定。

HOT WHEELS™ and associated trademarks and trade dress are owned by, and used under license from, Mattel. ©2022 Mattel.

1186 MJ, 1, NL

Ⓟ D714,887

Mattel Canada Inc. Mississauga, Ontario L5R 3W2.  
MADE IN CHINA. FABRIQUÉ EN CHINE. FABRICADO EN CHINA. HECHO EN CHINA.  
ИЗГОТОВЛЕНО В КИТАЕ. ЧИՆԻՆ ԴՐԵՏԻՄԻՏՆԻՐ. صنع في الصين

©2022 MEGA Brands &™ MEGA Brands.  
Printed in China / Imprimé en Chine

AD-HNG52-01B

