



POKÉMON™



HKT19

ZUBAT'S MIDNIGHT FLIGHT VOL DE NUIT DE NOSFERAPTI

VUELO DE MEDIANOCHE DE ZUBAT / VOO NOTURNAL DO ZUBAT
ZUBATS MITTERNACHTSFLUG / НОЧНОЙ ПОЛЕТ ZUBAT



Build Construisez

Construye | Constrói
Bauen | Стройте



Share | Partagez

Comparte | Partilha
Teilen | Делитесь

Easy-to-follow steps!

Des instructions faciles à suivre !

¡Pasos fáciles de seguir!
Passos fáceis de seguir!
Einfache Schritte!
Простые действия!



Devices not included | Appareils non inclus
Dispositivos no incluido | Dispositivos não incluídos
Geräte nicht enthalten | Устройства не входят в комплект



megaunboxed.com



BUILD WITH MOTION

CONSTRUIS UN MONDE EN MOVEMENT

Construye con movimiento
Construção com movimento
Bauen mit Aktion
Строй с движением



12





1

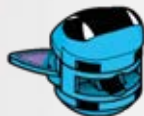

2

3



2x



1x



1x

4



1x



1x



1



2

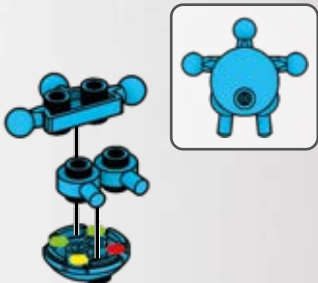

5



2x



2x

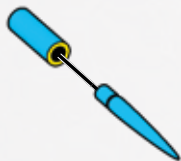

1



2

x2

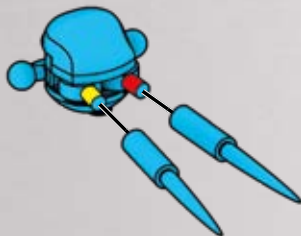

1

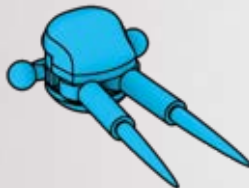

2

6

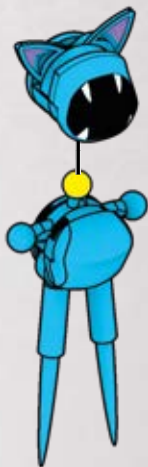

1



2

7



1x



1x



1



2

8



1x



1x



1



2

9

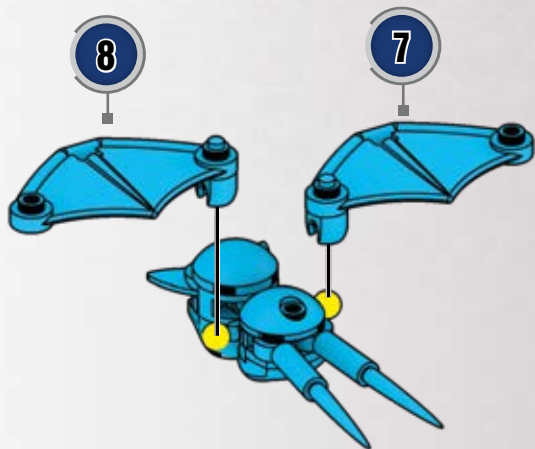

1

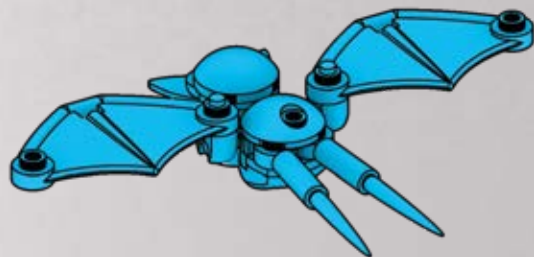

2

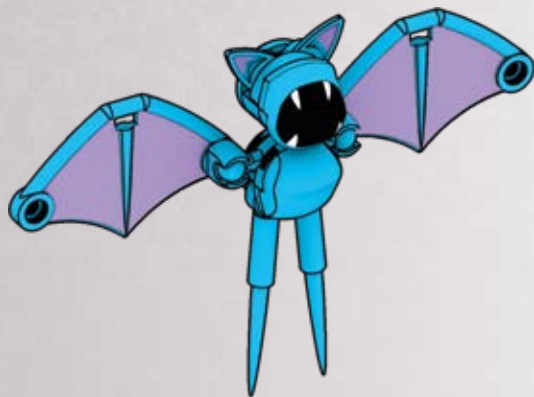

3



10



1x



1x



1x



1x



1



2

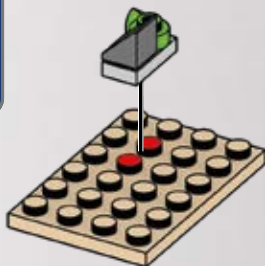

11



2x



1x



1x



1x

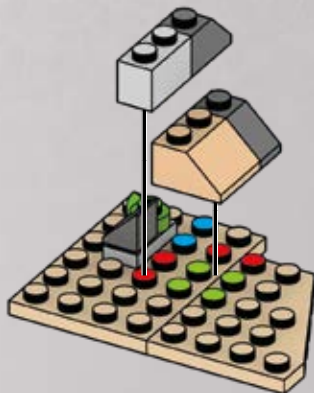

12



2x



1x

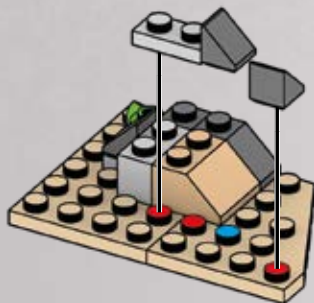

13



1x



3x

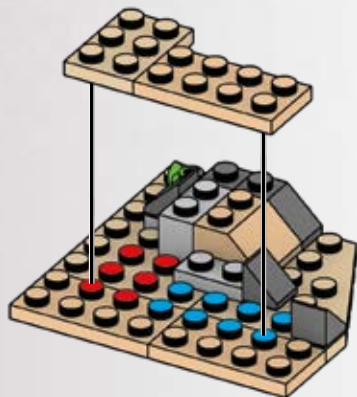

14

2x



1x

**15**

1x



1x

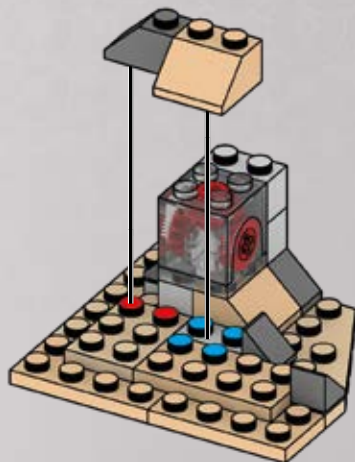
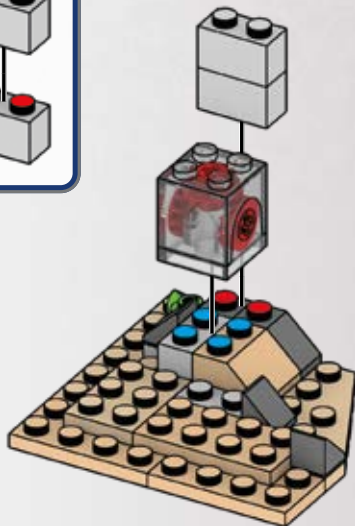
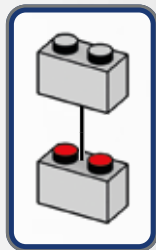

16



2x



1x



1x

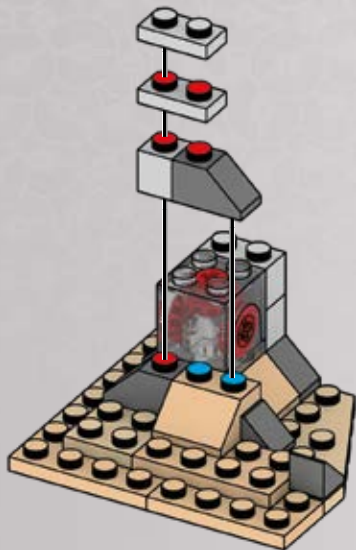

17



1x



1x

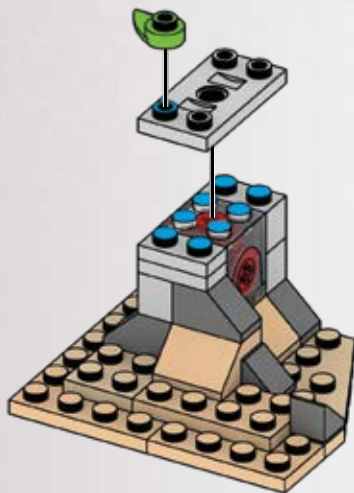

18



1x



1x



1x

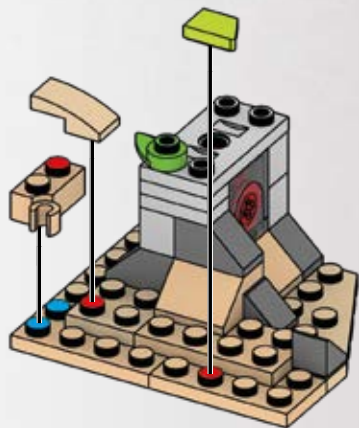

19



1x



1x

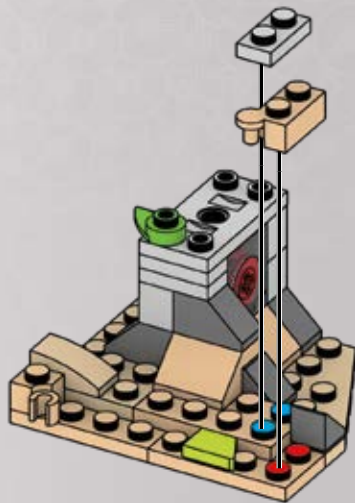

20



1x



1x

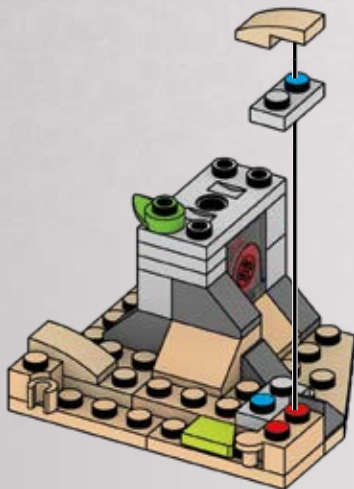

21

2x



1x



1x

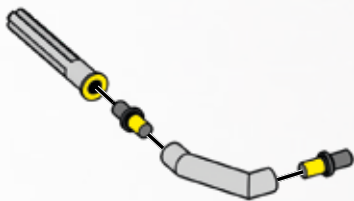

1

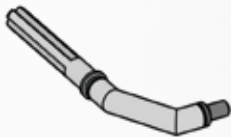

2

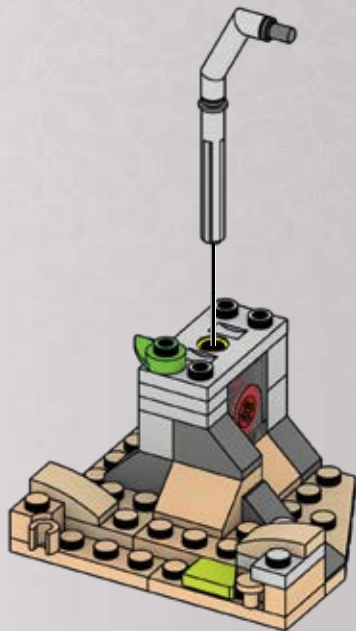

22



1x



1x



1



2

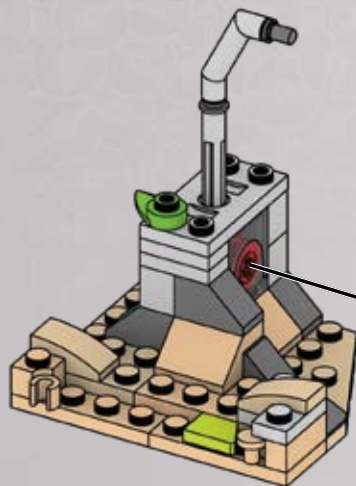

1

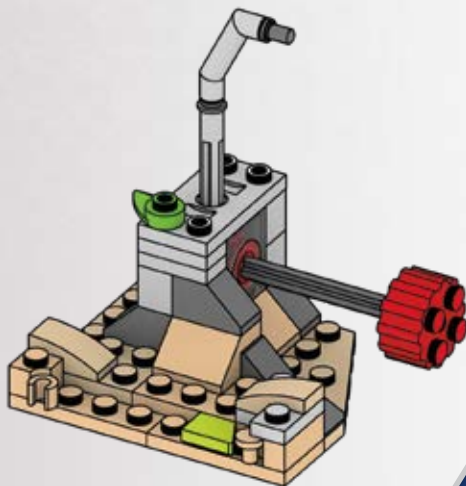
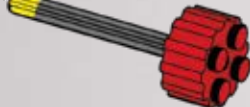

2

23

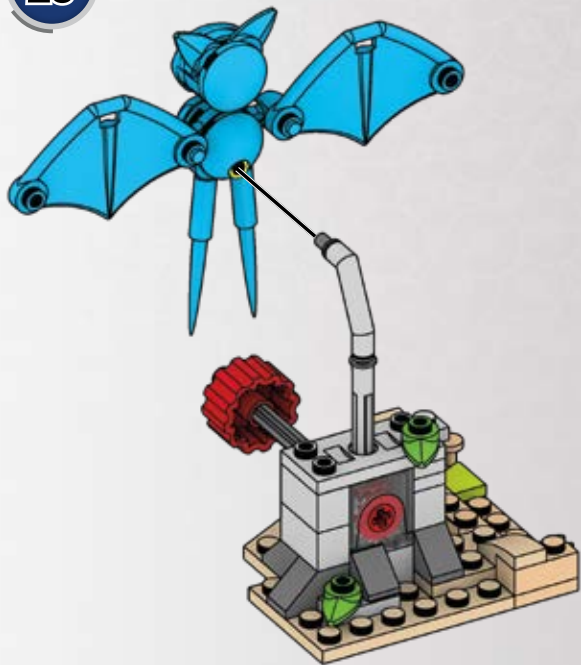

1

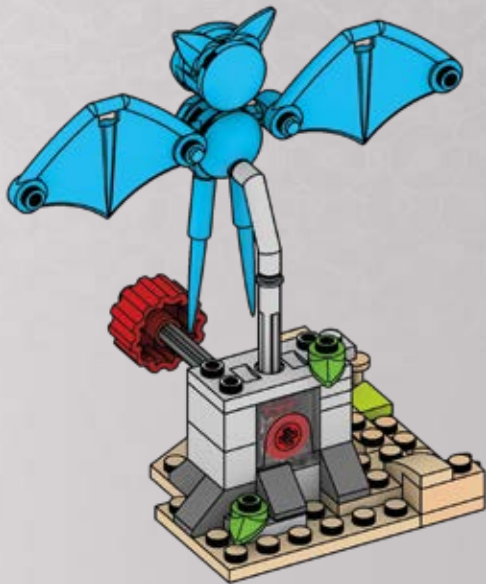

2

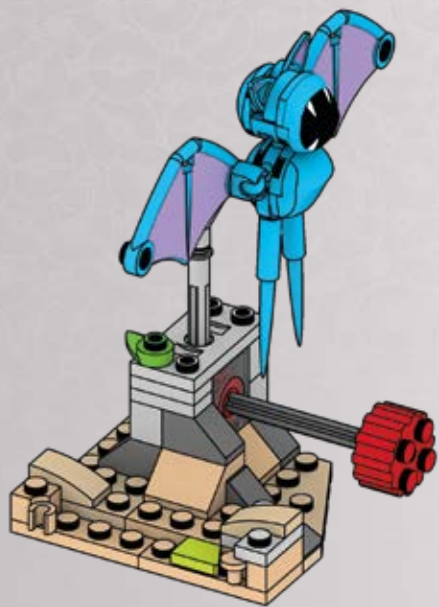

3

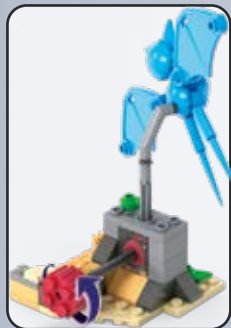
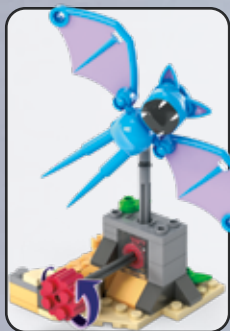

2x
AM17003BDG



2x
AM80010GD



2x
AM78279HT



2x
AM78296GD



1x
AM74299BBG



3x
AM15258BDG



2x
AS-DYF03-03



1x
AM01086BLG



2x
AM17506GD



2x
AM79375GD



1x
AM78391GD



6x
AM09393BLG



2x
AM78486BTN



1x
AM78285GD



1x
AM79982GD



1x
AS-HKT19-02



1x
AM78293GD



1x
AM78281GD



1x
AM76560AMR



1x
AM76559AMR



1x
AM79978GD



4x
AM01322BDG



3x
AM09013BLG



1x
AM74657BLG



1x
AM81613AMC



2x
AM10273AMR



1x
AM03772BTN



2x
AM77121GD



1x
AM80483BLG



1x
AM79871BLG



3x
AM09493AMR



1x
AS-HKT19-01



1x
AM79705BDG



1x
AM18280BTN



2x
AS-DYF03-02



1x
AM17055BTN



**Missing pieces?
Pièces manquantes?**

¿Partes faltantes? • Perdeu peças?
Fehlen Teile? • Не хватает деталей?

support.megabrands.com

ATTENTION : DANGER
D'ÉTOUFFEMENT. - PRÉSENCE DE PETITS
ÉLÉMENTS. NE CONVIENT PAS AUX ENFANTS DE
MOINS DE 3 ANS.

ATENÇÃO! NÃO INDICADO / NÃO
RECOMENDÁVEL PARA CRIANÇAS MENORES DE 3
(TRÊS) ANOS POR CONTER PARTE(S) PEQUENA(S)
QUE PODE(M) SER ENGOLIDA(S) OU ASPIRADA(S)
PODENDO PROVOCAR ASFIXIA.

警告:

のどにつまる危険 小さな部品が含まれています
3歳以下の子供には与えないで下さい。

警告!

不适合3岁以下儿童使用。
内含小零件。

⚠ WARNING : CHOKING HAZARD. - Small parts.
Not for children under 3 years.

ADVERTENCIA: PELIGRO DE ATRAGANTAMIENTO. Juguete no
recomendado para menores de 3 años, porque contiene piezas
pequeñas que podrían provocar asfixia en caso de ser ingeridas o
inhaladas por el/la niño/a.

AVVERTENZA: Contiene pezzi di piccole dimensioni.
ACHTUNG: Kleine Teile.

OSTRZEŻENIE: Mate części. Niebezpieczeństwo zadławienia.

WAARSCHUWING: Kleine onderdelen

ПРЕДУПРЕЖДЕНИЕ: Мелкие детали.

ADVARSEL: Indeholder små dele.

VARNING: Smådelar

ADVARSEL: Små deler

VAROITUS: Pieniä osia

ΠΡΟΣΟΧΗ: Περιλαμβάνονται μικρά κομμάτια.

UVARI: Kicsik darabok.

UPOZORNĚNÍ: Malé díly

UPOZORNENIE: Malé časti

FIGYELMEZTETÉS: Kis alkatrészek.



تحذير:

غير مناسبة للأطفال دون 36 شهراً - قطع صغيرة.

Mattel Europa B.V., Gondel 1, 1186 MJ Amstelveen, Nederland. Mattel U.K. Limited, The Porter Building, 1 Brunel Way, Slough SL1 1FQ, UK. Mattel France, Parc de la Cerisaie, 1/3/5 allée des Fleurs, 94260 Fresnes Cedex. N° Cristal 0969 36 99 99 (Número non surtaxé) ou www.lesjouetsmattel.fr Mattel Belgium, Trade Mart, Atomiumsquare, Bogota 202 - B 275, 1020 Brussels. Gratis nummer België: 0800 - 16 936 - Gratis nummer Luxemburg: 800 - 22 784 - Gratis nummer Nederland: 0800 - 262 88 35. Deutschland : Mattel GmbH, Solmsstraße 4, D-60486 Frankfurt am Main. Schweiz: Mattel AG, Kirchstrasse 24, CH-3097 Liebefeld. Österreich: Mattel Ges.m.b.H., Campus 21, Liebermannstraße A01 404, A- 2345 Brunn/Gebirge. Mattel Italy Srl, Via Bracco, 6-MAC 6, 20159 Milano, Italy. Servizio assistenza clienti: Customersrvitalia@mattel.com - Numero verde 800 11 37 11. Mattel España, S.A., Arribau 200, 08036 Barcelona. cservice.spain@mattel.com Tel: 900 102 390 http://www.service.mattel.com/es. Mattel East Asia Ltd., Room 503-09, North Tower, World Finance Centre, Harbour City, Tsimsatsui, HK, China. Tel: (852) 3185-6500. Diimport & Diedarkan Oleh: Mattel Continental Asia Sdn Bhd. Level 19, Tower 3, Avenue 7, No. 8 Jalan Kerinchi, Bangsar South, 59220 Kuala Lumpur, Malaysia. Mattel South Africa (PTY) LTD, Office 102 I3, 30 Melrose Boulevard, Johannesburg 2196. Dystrybutor: Mattel Poland Sp. z o.o., Warsaw Trade Tower 34 p., ul. Chłodna 51, 00-867 Warszawa. Mattel Australia Pty. Ltd., 658 Church St., Richmond, Victoria, 3121. Consumer Advisory Service - 1300 135 312. Mattel AEBE, Eßvárgyúte Mákori út 1, Képtér K-2, TK 17561, Paláoi Ófalgru. Mattel Oyuncakçılık Tic. Ltd. Şti. İçerenköy Mah., Erkut Sok. A Blok No:12 Üner Plaza Kat:9-10 34752 Ataşehir İstanbul. Tel: 0216 570 75 00. Импортёр/Уполномоченная организация: ООО "МАТТЕЛ" Российская Федерация, 105120 Москва, 2-й Сырмятинский переулк, 1; +7 495 287 79 39. Mattel Czech Republic s.r.o., The Forum, Václavské nám. 19, 11000 Praha1. Mattel, 333 Continental Boulevard, El Segundo, CA 90245, USA. Consumer Services: 1-800-465-MEGA (6342). Mattel Canada Inc., Mississauga, Ontario L5R 3W2. Consumer Services: You may call us free at/ Composez sans frais le 1-800-524-8697. Importado y distribuido por Mattel de México, S.A. de C.V., Miguel de Cervantes Saavedra No. 193, Pisos 10 y 11, Col. Granada, Alcaaldia Miguel Hidalgo, C.P. 11520, México, Ciudad de México. R.F.C. MME-920701-NB3. Tels: 59-05-51-00 Ext. 5206 ó 01-800-463-59-89. Mattel Chile, S.A., Avenida América Vespucio 501-B, Quilicura, Santiago. Tel: 1230-020-6213. Servicio al consumidor Venezuela: Tel: 0-800-100-9123. Mattel Argentina, S.A., Av. Libertador 1000, Piso 11 - Oficinas 109 y 111, Vicente López - Prov. Buenos Aires. Tel: 0800-666-3373. Mattel Colombia, S.A., Calle 123#7-07 PS, Bogotá. Tel: 01800-710-2069. Mattel Perú, S.A., Av. Juan de Arona # 151, Centro Empresarial Juan de Arona, Torre C, Piso 7, Oficina 704, San Isidro, Lima 27, Perú. RUC: 20425853865. Reg. Importador: 02350-12-JUE-DIGESA. Tel: 0800-54744. E-mail Latinoamérica: servicio.clientes@mattel.com. Mattel do Brasil Ltda. - CNPJ: 54.558.002/0001-20 - Rua Verbo Divino, 1488 - 2º - Andar - 04719-904 - Chácara Santo Antônio - São Paulo - SP - Brasil. Serviço de Atendimento ao Consumidor: fone 0800 575 0780. E-mail: sac.matteldobrazil@mattel.com



HKT19™



HKT21™



HKT20™



HKT25™

=

BUILD YOUR WORLD OF POKÉMON WITH MOTION CONSTRUIS TON MONDE POKÉMON EN MOUVEMENT



*Construye tu mundo de Pokémon con movimiento
Constrói o teu mundo de Pokémon com movimento
Eine eigene, bewegliche Pokémon Welt bauen
Построй свой мир Pokémon с движением*





***HKT19 / HKT20 / HKT21 / HKT25 / HDL76 / HDL77 / HDL80 / HDL86 / HHN61**

Set(s) sold separately and subject to availability. / Ensemble(s) vendu(s) séparément. Certains produits peuvent ne pas être commercialisés. / Se vende(n) por separado y está(n) sujeto(s) a disponibilidad. / Conjunto(s) vendido(s) em separado e sujeito(s) à disponibilidade. / Set in vendita separatamente, secondo disponibilità. / Das/Die Set(s) sind separat erhältlich. / Zestaw(y) sprzedawany(e) oddzielnie w zależności od dostępności. / Set(s) apart verkrijgbaar en afhankelijk van beschikbaarheid. / Набор(-ы) продаются отдельно, при наличии. / Sæt sælges separat og så længe lager haves. / Seten säljs separat så länge lagret räcker. / Settet/settene selges separat så langt lageret rekker. / Pakkaus/pakkaukset myydään erikseen, saatavuus voi vaihdella. / Το(α) σετ πωλούνται ξεχωριστά και ανάλογα με τη διαθεσιμότητα. / Setler ayrı olarak satılır ve stoklarla sinirlidir. / Set (sety) se prodává (prodávají) samostatně dle aktuální nabídky. / Súprava/-y sa predáva(jú) samostatne a podľa dostupnosti. / A készlet(ek) külön kapható(k), az elérhetőség változhat.

セット商品は別売りになります。在庫状況は別途ご確認お願いします。

تباع المجموعة أو المجموعات على حدة وتخضع لتوافرها.

每套单独发售，按供货情况决定。

©2022 Pokémon. ©1995–2022 Nintendo / Creatures Inc. / GAME FREAK inc. TM, ®, and character names are trademarks of Nintendo.

©2022 Pokémon. ©1995–2022 Nintendo/Creatures Inc./GAME FREAK inc. TM, ® et les noms des personnages sont des marques de Nintendo.



HDL76*



HDL77*



HDL80*



HDL86*



HHN61*



HKT21*



HKT19*



HKT20*



HKT25*

BUILD A WORLD OF POKÉMON CRÉEZ VOTRE UNIVERS POKÉMON

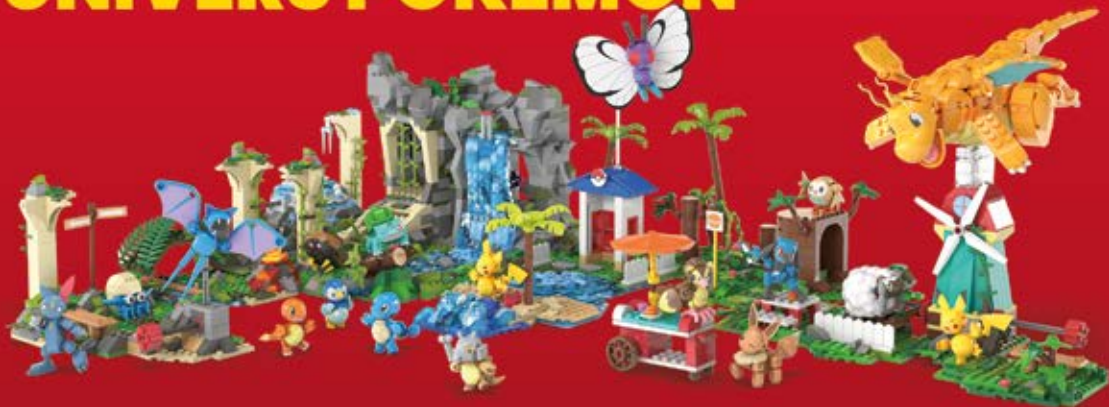

CONSTRUYE UN MUNDO DE POKÉMON
CONSTRÓI UM MUNDO DE POKÉMON EINE
POKÉMON WELT ERSCHAFFEN
ПОСТРОЙТЕ МИР POKÉMON

Mattel Canada Inc. Mississauga, Ontario L5R 3W2.
MADE IN CHINA. FABRIQUÉ EN CHINE. FABRICADO NA / HECHO EN CHINA.
ИЗГОТОВЛЕНО В КИТАЕ. ÇIN'DE ÜRETİLMİŞTİR. صنع في الصين

©2022 MEGA Brands &™ MEGA Brands.
Printed in China / Imprimé en Chine

AD-HKT19-01



1186 MJ, 1, NL
P D799,607, D834,105

