

# RENEGADE BANSHEE • BANSHEE REBELLE

BANSHEE RENEGADO • BANSHEE RENEGADA



HNC56

**MEGA** HALO

Paramount+  
ORIGINAL

HALO  
THE SERIES  
LA SÉRIE



**GET INSTRUCTIONS ONLINE  
INSTRUCTIONS DISPONIBLES  
EN LIGNE**

CONSULTA LAS INSTRUCCIONES EN LÍNEA  
OBTEN INSTRUÇÕES ONLINE  
ANWEISUNGEN ONLINE ERHÄLTlich  
ИНСТРУКЦИИ ДОСТУПНЫ ОНЛАЙН

[megaunboxed.com](http://megaunboxed.com)



1

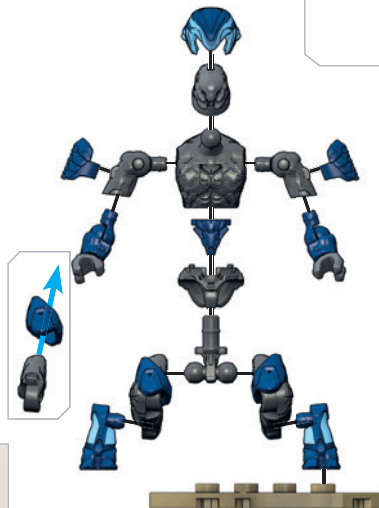



2



1X



1X



1X

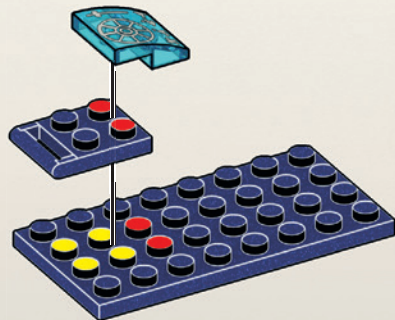

3



1X



1X



2X



2X

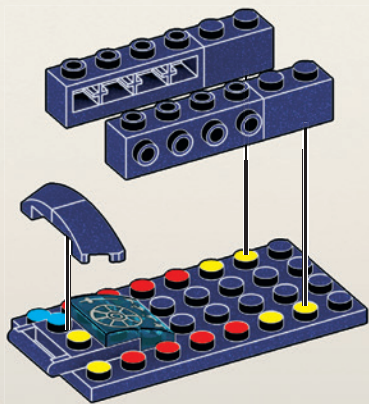

4



2X



2X



2X

x2

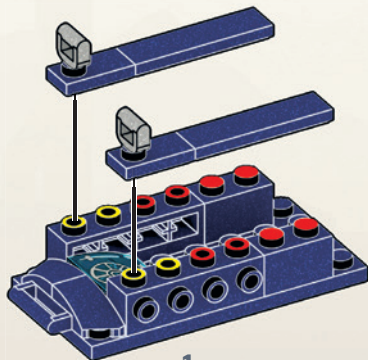
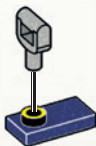

1

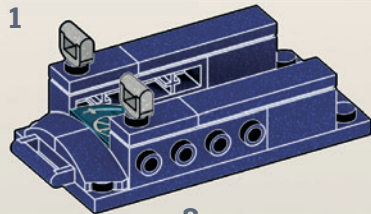

2



5



4X



2X

x2

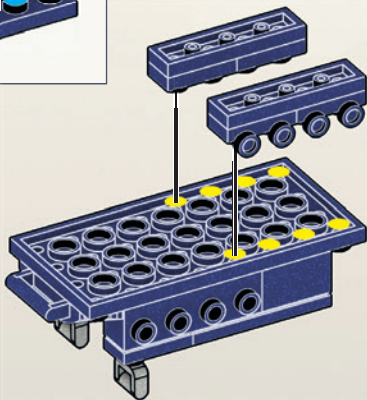
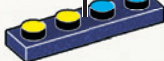

6



1X



1X



1X

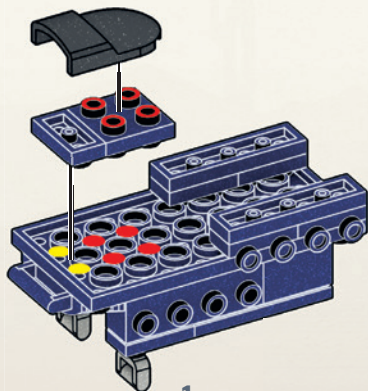

1

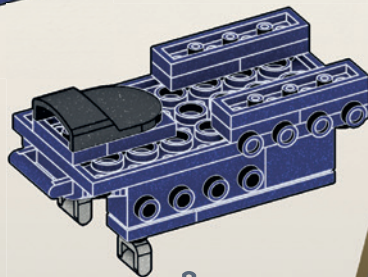

2

7

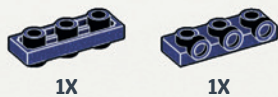

8



9

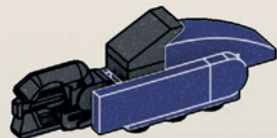
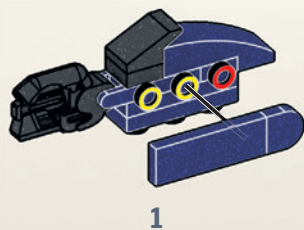
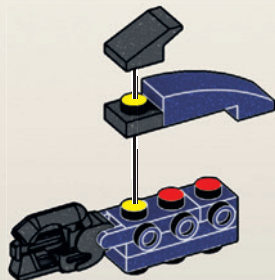
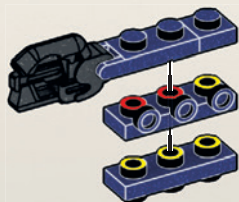

10

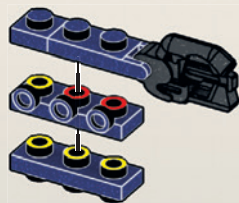
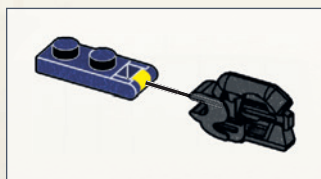
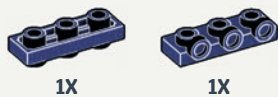
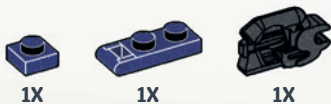

11

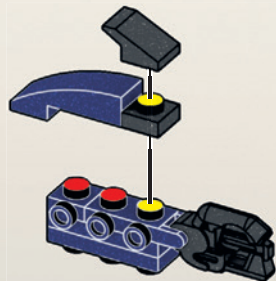

12

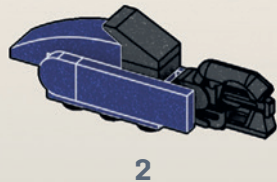
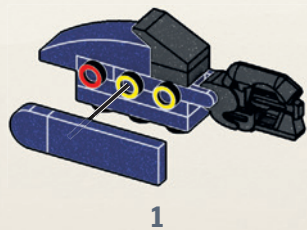

13



12

9

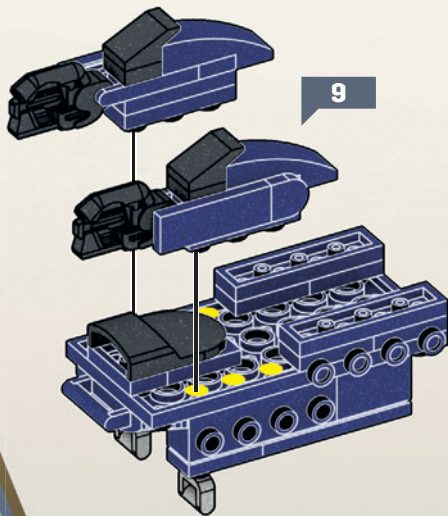

14



2X

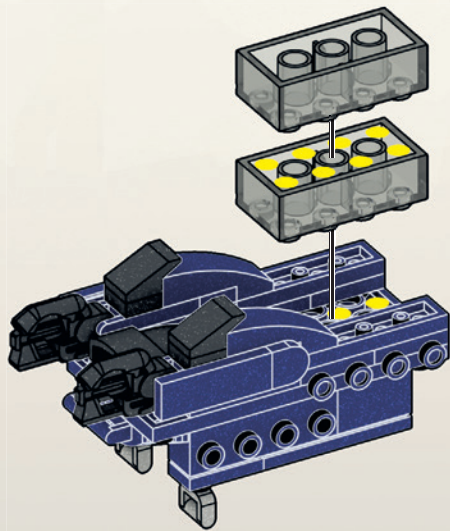
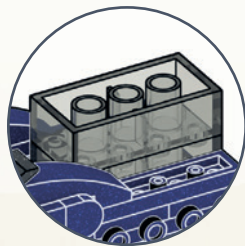

15

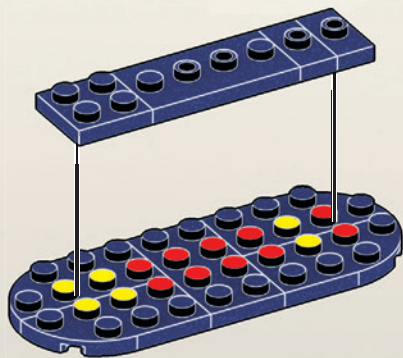
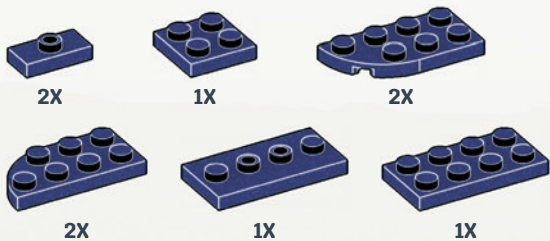

16

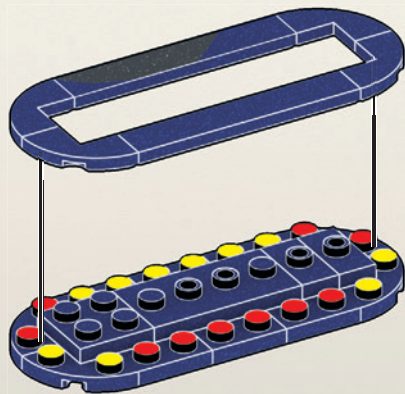
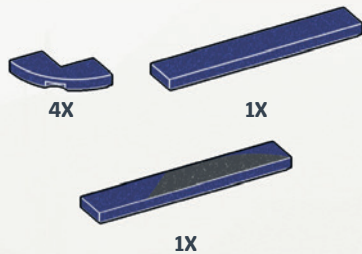



17



1X



1X



1X



1X

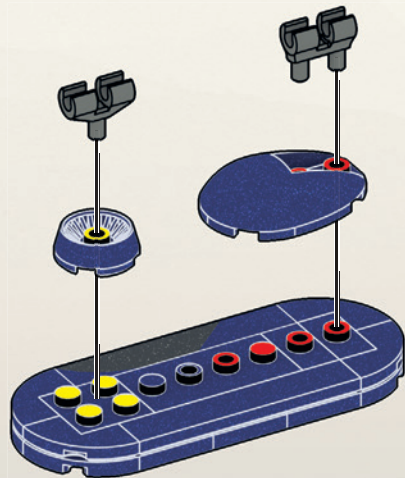

1

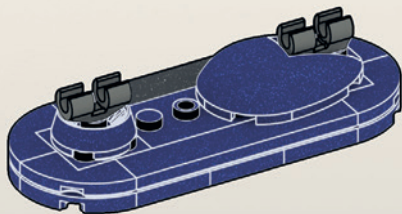

2

18



1X

1X

1X



1X



2X

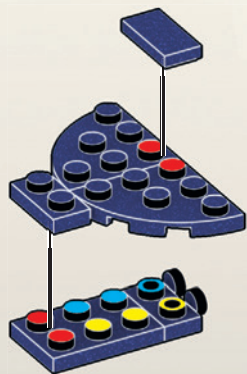

19



1X



1X

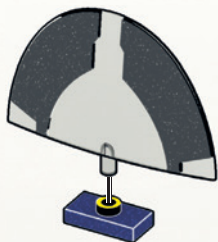

1

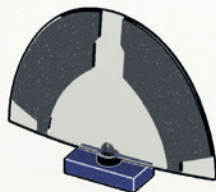

2

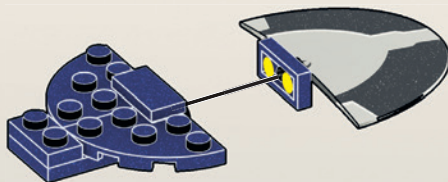

1

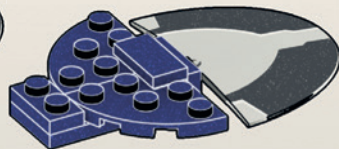

2

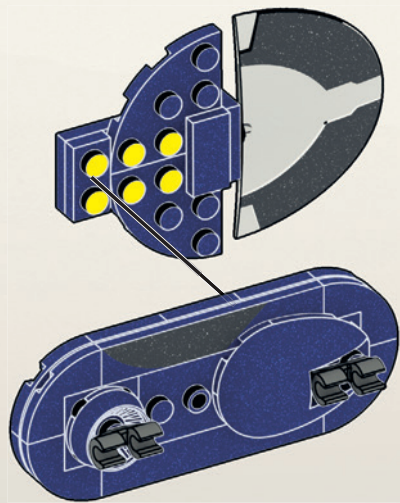

1

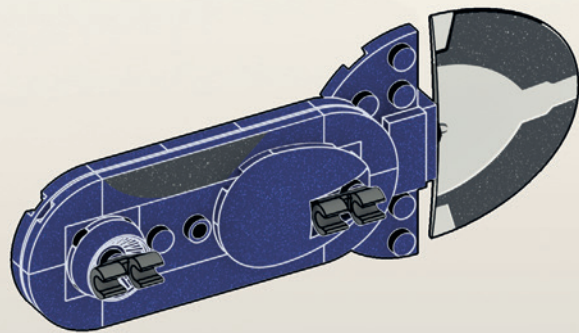

2

21

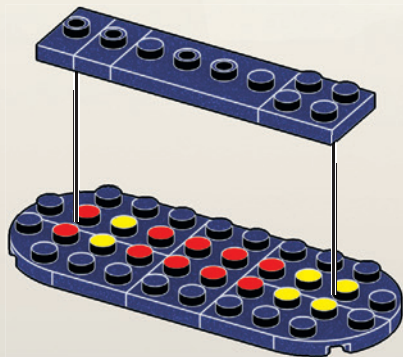
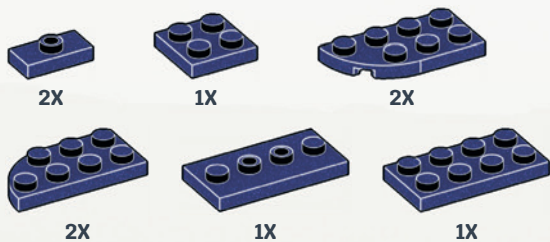

22

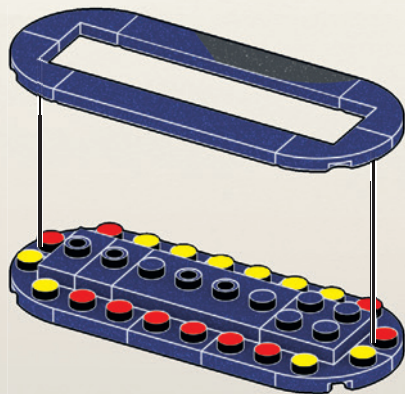
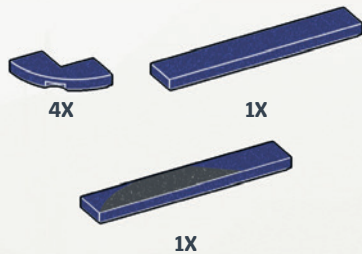

23



1X



1X



1X



1X

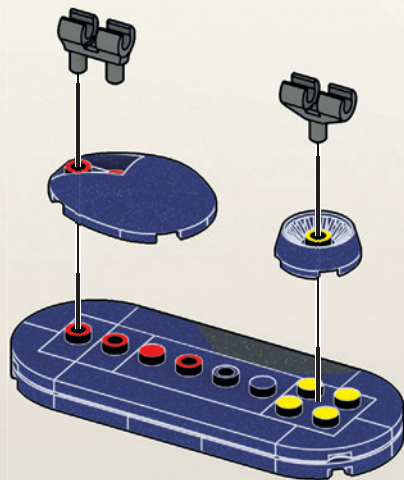

1

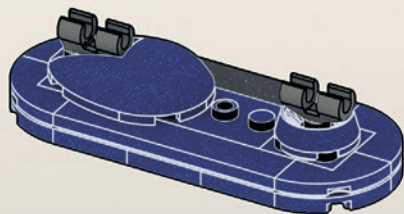

2



24



1X

1X

1X



1X



2X

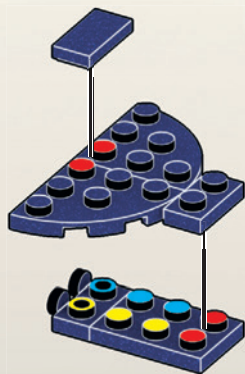

25



1X



1X

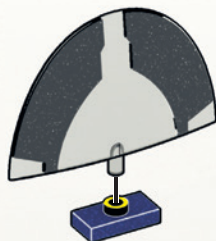

1

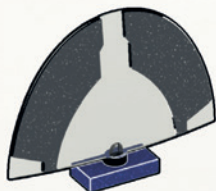

2

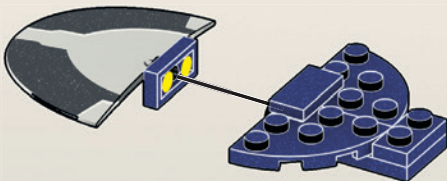

1

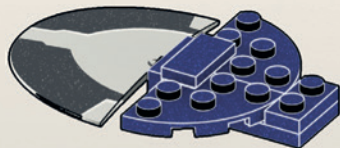

2

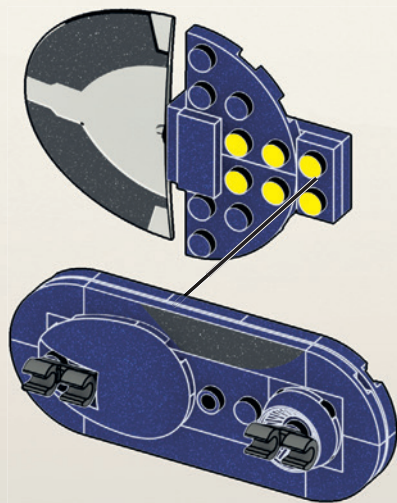

1

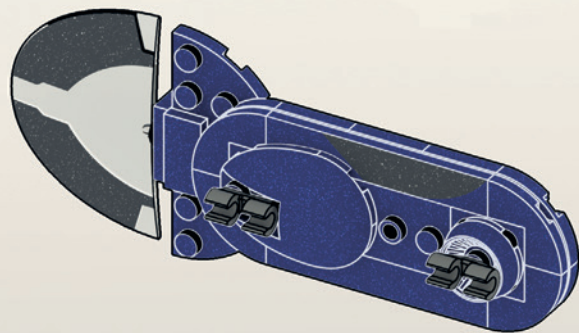

2

27



1X

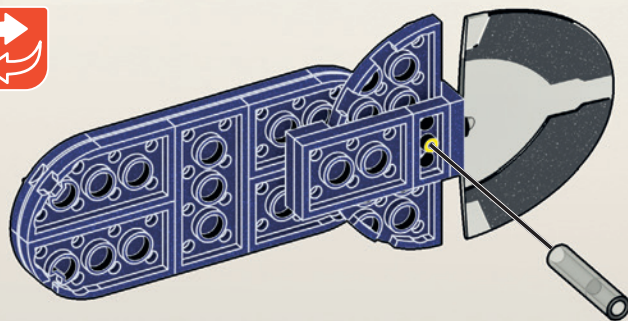

28

27



20

1

2

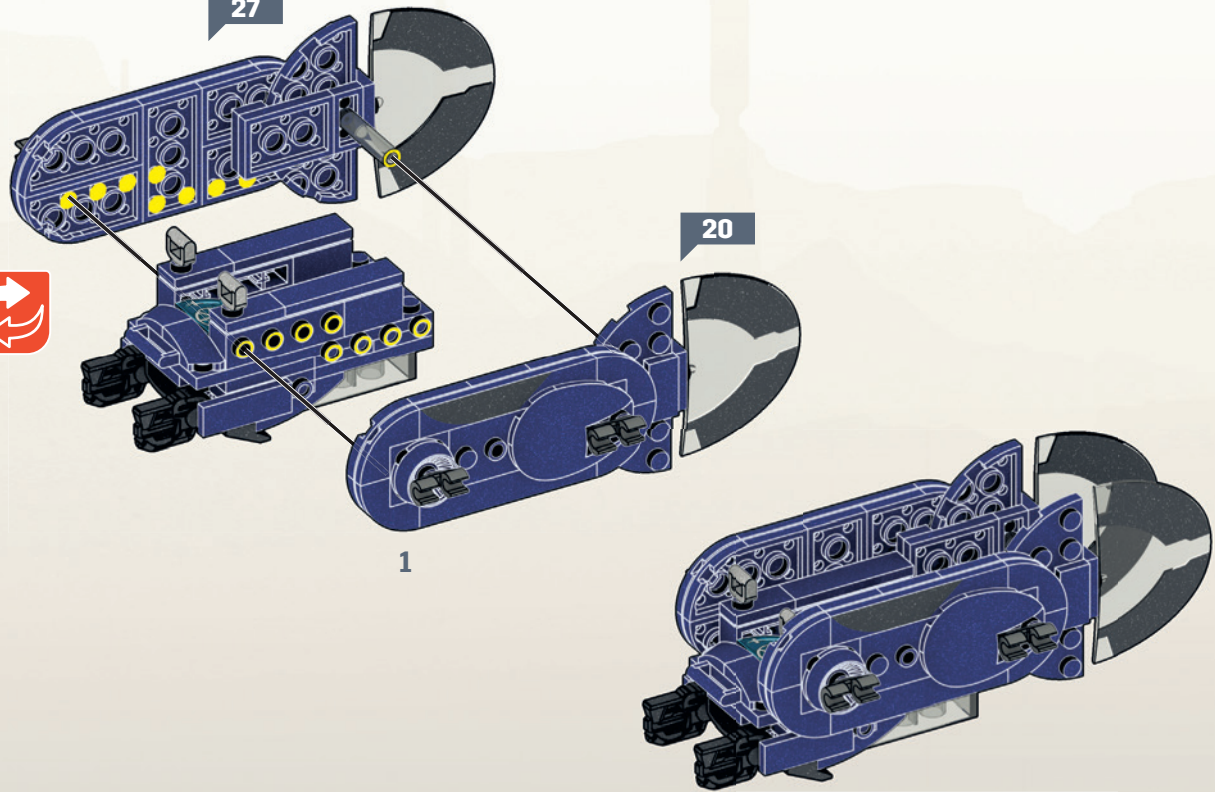

29

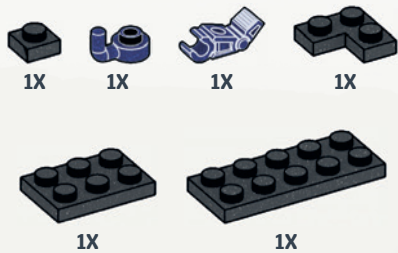

30

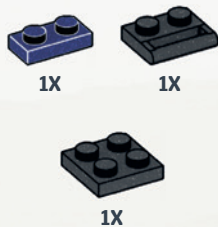

31

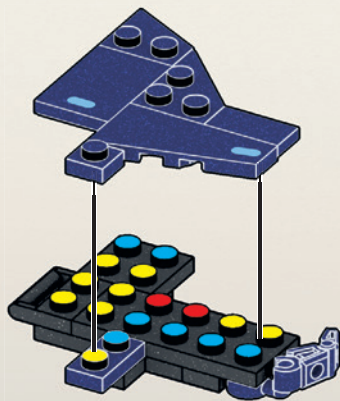
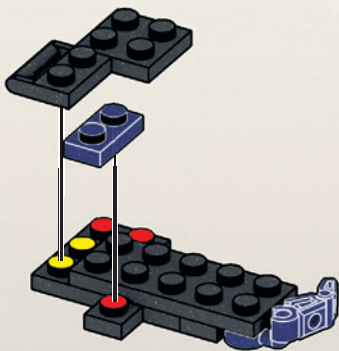
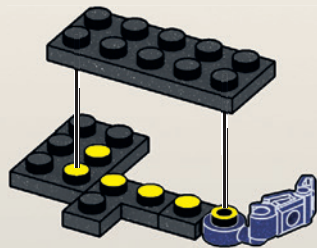
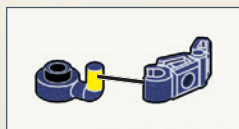
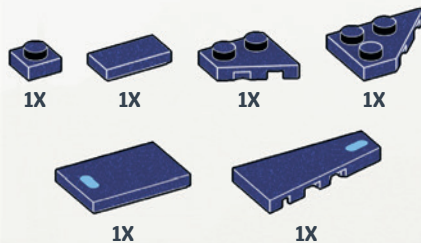



32

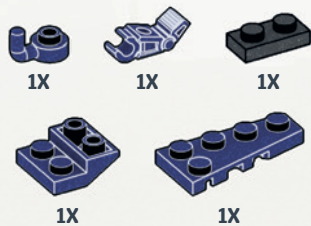

33

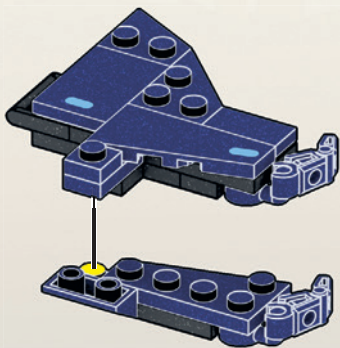
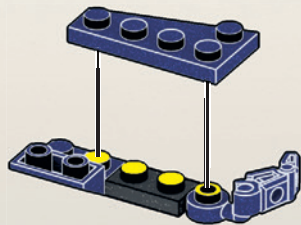
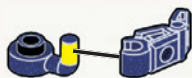

1

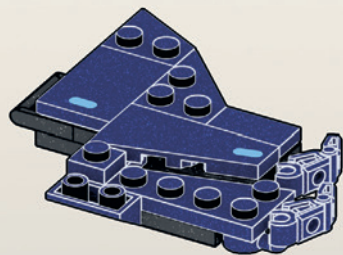

2

34

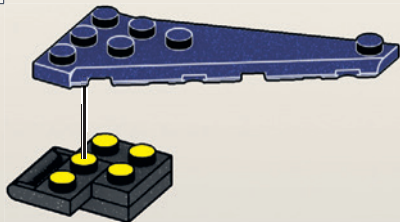
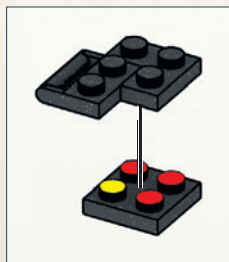
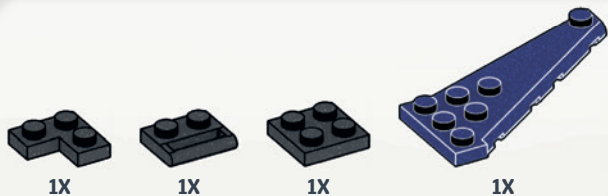

35

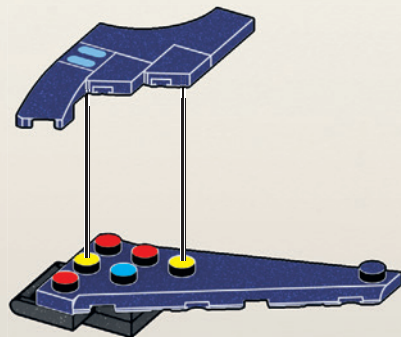

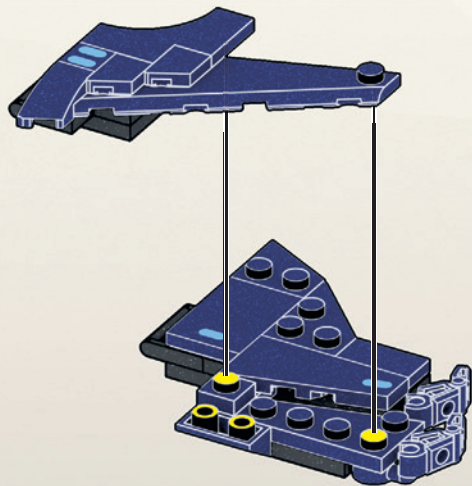

1

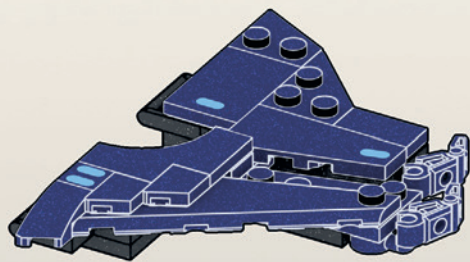

2

37



1X



1X



1X

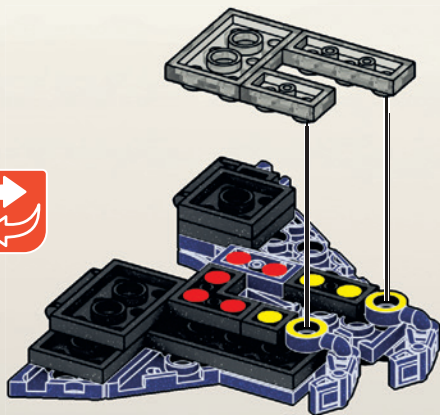

1

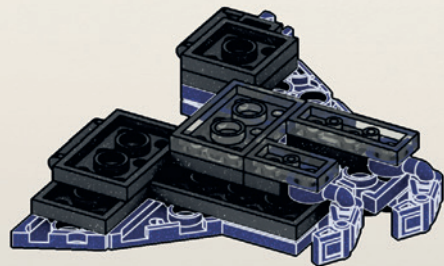

2

38



1X

1X

1X

1X



1X



1X

39



1X

1X



1X

40

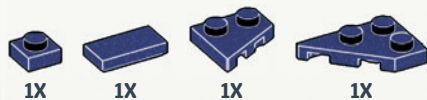

1X

1X

1X

1X

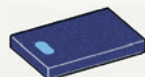

1X



1X

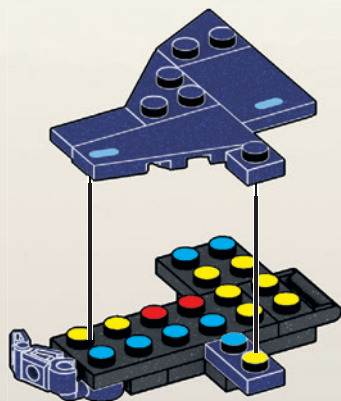
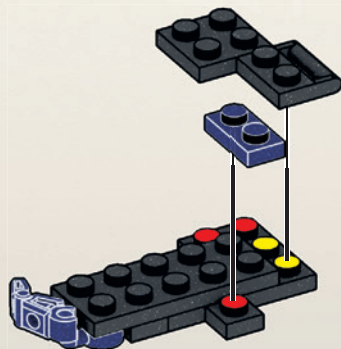
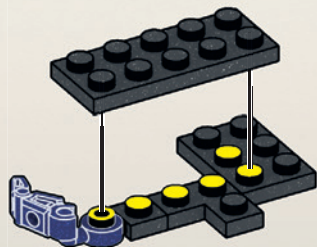
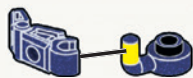



41



1X



1X



1X



1X



1X

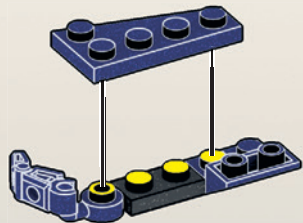

42

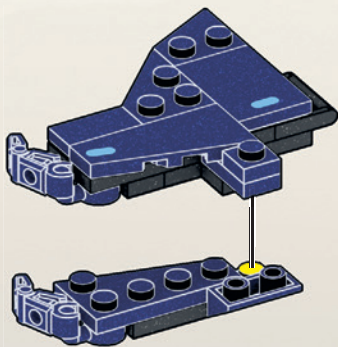

1

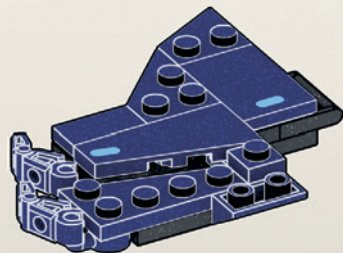

2

43

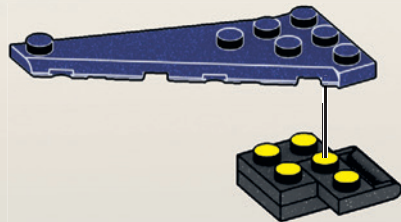
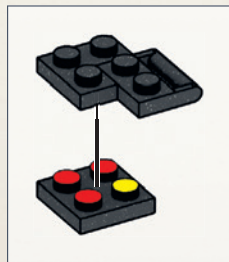
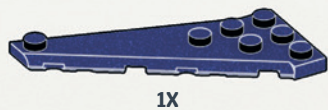

44

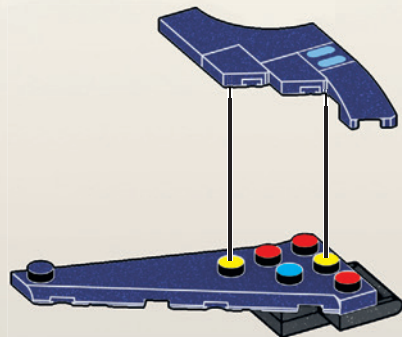

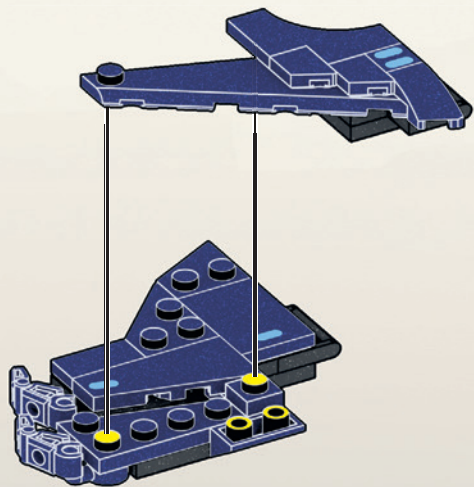

1

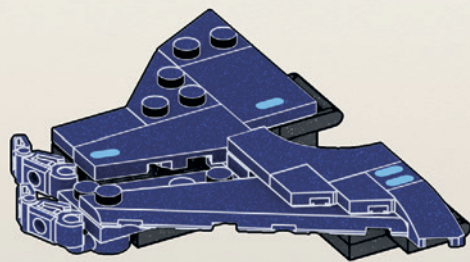

2

46



1X



1X



1X

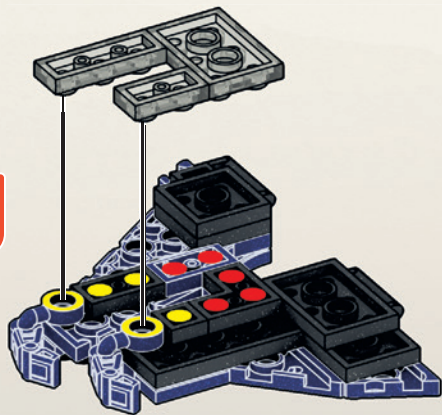

1

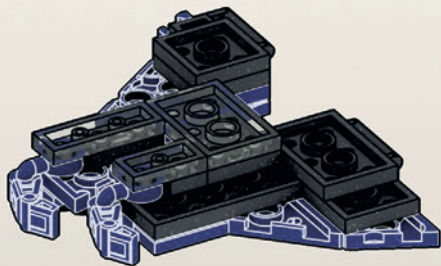

2

47

46

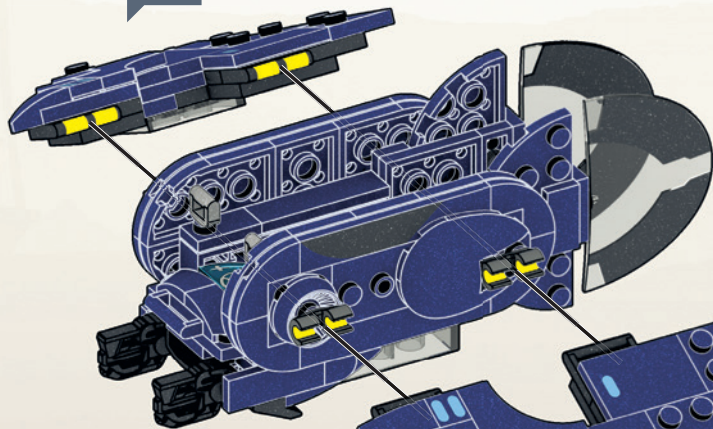

37

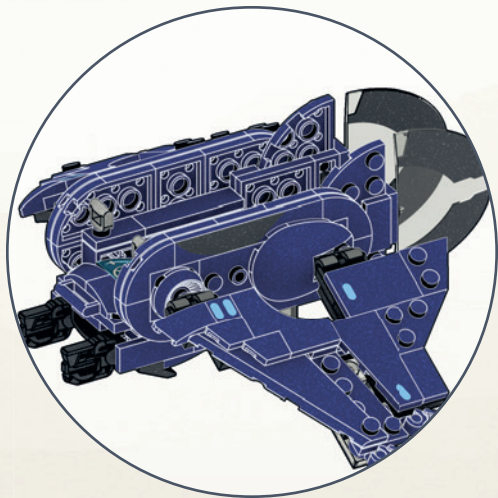
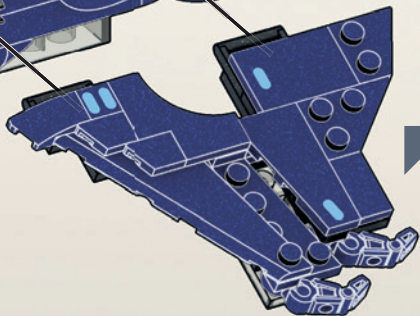





1X

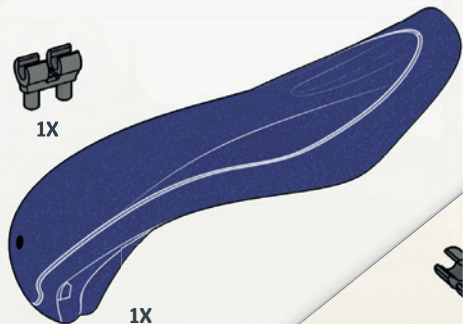

1X

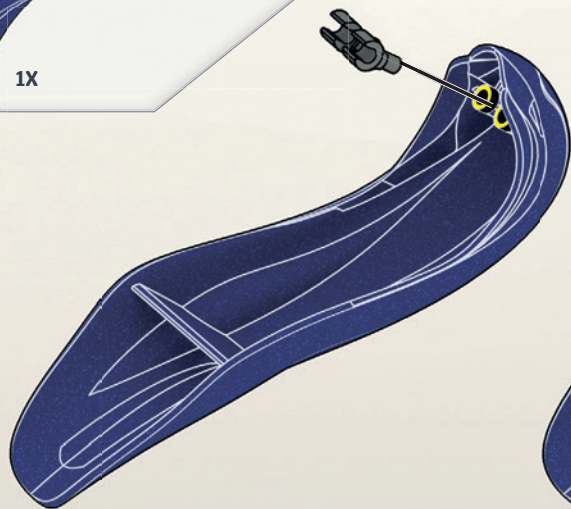

1

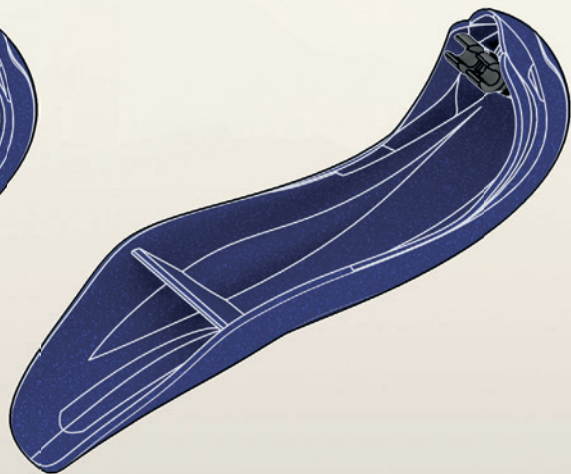

2

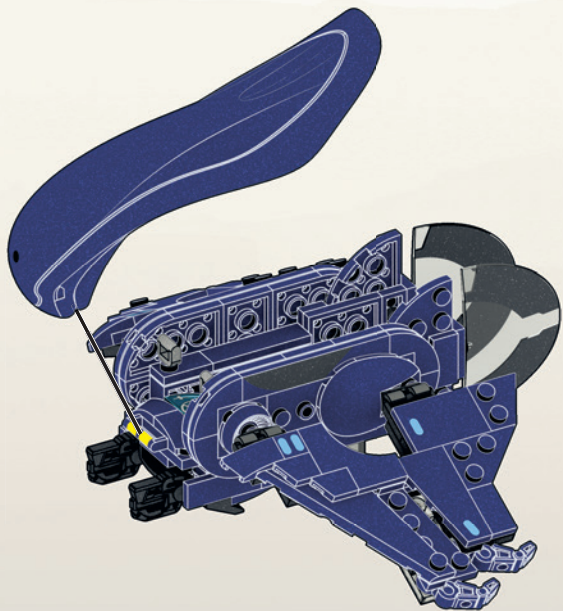

1

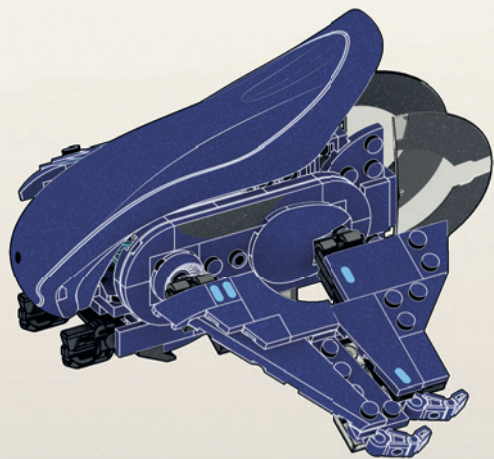

2

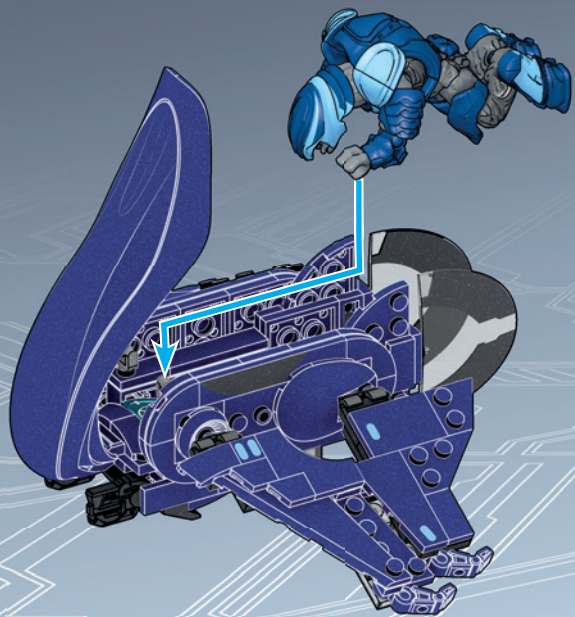

1

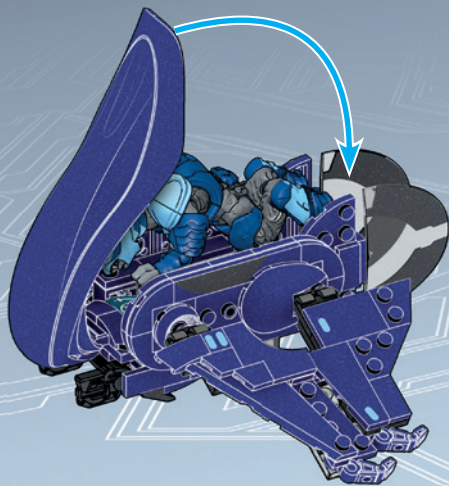

2



SOREN-066

ELITE  
MINOR

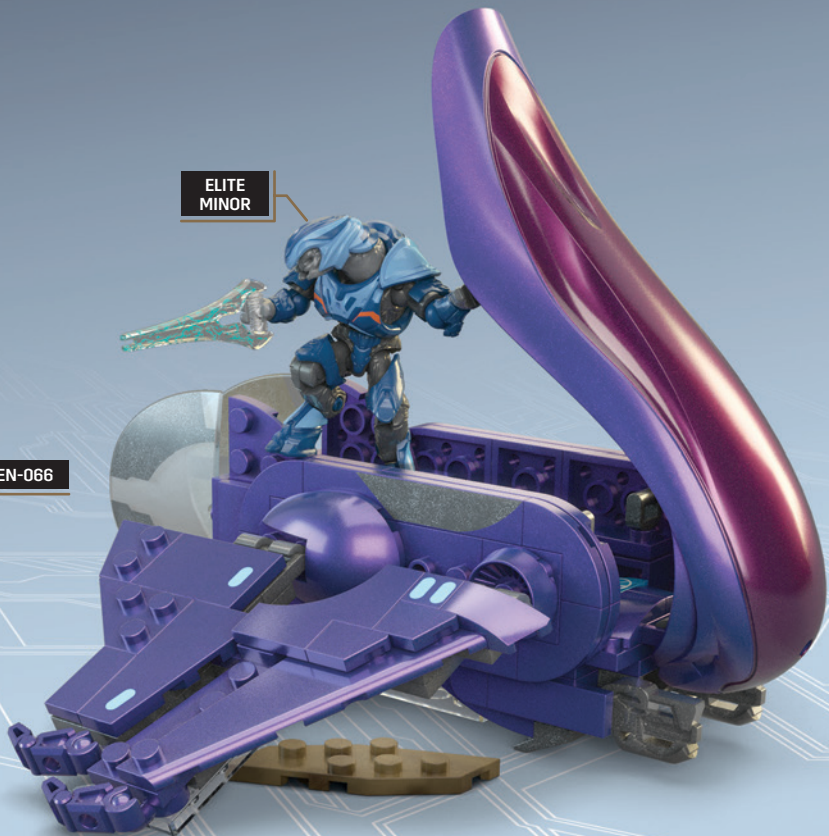



2x  
AM76204ARM

2x  
AS-HNC56-05

4x  
AM03328MM

4x  
AM03328ARM

4x  
AM79570ARM

2x  
AM76060APG

2x  
AM74299ARM

2x  
AM74300ARM

2x  
AM17018MM

2x  
AM18260BDG

3x  
AM72090BDG

2x  
AM74427ARM

2x  
AM74426ARM

4x  
AM22501ARM

2x  
AM73758ARM

6x  
AM07590ARM

5x  
AM09393ARM

2x  
AM09393MM

2x  
AM09393W

6x  
AM79070ARM

4x  
AM77174ARM

2x  
AM09013ARM

8x  
AM18667ARM

4x  
AM15484MM

4x  
AM72000MM

2x  
AM17010ARM

1x  
AM18665ARM

1x  
AM18666ARM

2x  
AM19015MM

2x  
AM77373MM

2x  
AM16954ARM

4x  
AM03773MM

2x  
AM03773ARM

1x  
AM01146ARM

2x  
AM18223ARM

1x  
AS-HNC56-09

1x  
AM72233W

2x  
AM80966ARM

2x  
AM01314W

2x  
AM80143ARM

2x  
AM81259ARM

1x  
AM18329ARM

1x  
AM19199MM

2x  
AM07230ARM

2x  
AS-HNC56-06

2x  
AM03772ARM

2x  
AM03772W

2x  
AM03772MM

1x  
AM76206ARM

1x  
AM76205ARM

4x  
AM17056ARM

2x  
AM09838ARM

2x  
AM09593ARM

2x  
AM17503ARM

2x  
AM78288ARM

1x  
AS-HNC56-04

1x  
AS-HNC56-03

1x  
AM74065ARM

1x  
AM74064ARM

4x  
AM03324ARM

4x  
AM03323ARM

2x  
AM01531ARM

2x  
AM09493ARM

2x  
AM09033W

2x  
AM78472ARM

2x  
AM80965MM

2x  
AM16331ARM

1x  
AS-HNC56-07

1x  
AS-HNC56-08

2x  
AM76357ANW

2x  
AS-HNC56-10

1x  
AM16654ARM

1x  
AM16659ARM

1x  
AM17845ARM





1x  
AS-HNC56-11



1x  
FIG-HNC56-A



1x  
FIG-HNC56-B



1x  
AS-HNC56-01



1x  
AS-HNC56-02



HNC55\*

HNC56\*

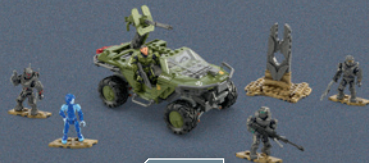

HNC57\*

### Missing pieces? Pièces manquantes?

¿Partes faltantes? • Perdeu peças?  
Fehlen Teile? • Не хватает деталей?



support.megabrand.com

Renegade Banshee / Banshee rebelle / Banshee  
Renegade / Banshee Renegada / Banshee Disertore /  
Abtrünniger Banshee / Renegade Banshee /  
Перебежник на "Баньши" / A renegát Banshee /  
Banshee-desertør / Renegade Banshee طائرة

Mattel Europa B.V., Gondel 1, 1186 MJ Amstelveen, Nederland. Mattel U.K. Limited, The Porter Building, 1Brunel Way, Slough SL1 1FQ, UK. Mattel France, Parc de la Cerisaie, 1/3/5 allée des Fleurs, 94260 Fresnes Cedex. N° Cristal 0969 36 99 99 (Numéro non surtaxé) ou www.lesjouetsmattel.com Mattel Belgium N.V. De Kleetaan 4, 1831 Machelen (Diegem) Belgium. Deutschland : Mattel GmbH, Solmsstraße 83, D-60486 Frankfurt am Main. Schweiz: Mattel AG, Kirchstrasse 24, CH-3097 Liebefeld. Österreich: Mattel Ges.m.b.H., Campus 21, Liebermannstraße A01 404, A- 2345 Brunn/Gebrige. Mattel Italia Srl, Via Turati 4, 20121 Milano, Italy. Servizio assistenza clienti: Customersrv.vitalia@mattel.com - Numero verde 800 11 37 11. Mattel España, S. A. Arlab 200 pl. 9, 08036 Barcelona. cservice.spain@mattel.com Tel: +34 933 06 79 00 http://www.service.mattel.com/es. Hong Kong: Kids Kingdom Limited, Room 1908-9, Gala Place, 56 Dundas Street, Mongkok, Kowloon, Hong Kong. Customer Care line: (02)2578-1188. Mainland China: Mattel Barbie (Shanghai) Trading Co., Ltd. Units 4701-4711, 47F, 2 Grand Gateway, 3 Hong Qiao Road, Shanghai, 200030, P.R.C. Customer Care line: 400-819-8658. Diimpört & Dieldarkan Oleh: Mattel Continental Asia Sdn Bhd. Level 19, Tower 3, Avenue 7, No. 8 Jalan Kerinchi, Bangsar South, 59200 Kuala Lumpur, Malaysia. Mattel South Africa (PTY) LTD, Office 102 13, 30 Melrose Boulevard, Johannesburg 2196. Dystrybutor: Mattel Poland Sp. z o.o., Budynek Skyliner 31 p., ul. Prosta 67, 00-838 Warszawa, Polska. Mattel Australia Pty. Ltd., 658 Church St., Richmond, Victoria, 3121. Consumer Advisory Service - 1300 135 312. Mattel AEBE, Εθνόρχου Μοκάρπιοι 1, Κτήριο Κ-2, ΤΚ 17561, Παλαιό Φάληρο, Mattel Oynuncaklıq Tic. Ltd. Şti. İçerençay Mah. Umüt Sokak No: 10- 12, Quick Tower kat:2 işkari no:15 Ataşehir 34752, İstanbul, Türkiye. Tel: 0216 570 75 00. Импортёр/Уполномоченная организация: ООО "МАТТЕЛ" Российская Федерация, 105120 Москва, 2-й Сыромятинский переулок, 1; +7 495 287 79 39. Mattel Czech Republic s.r.o., The Forum, Václavské nám. 19, 11000 Praha 1. Mattel, 333 Continental Boulevard, El Segundo, CA 90245, USA. Consumer Services: 1-800-465-MEGA (6342). Mattel Canada Inc., Mississauga, Ontario L5R 3W2. Consumer Services: You may call us free at / Composez sans frais le 1-800-524-8697. Importado y distribuido por Mattel de México, S.A. de C.V., Miguel de Cervantes Saavedra No. 193, Pisos 10 y 11, Col. Granada, Alcaldía Miguel Hidalgo, C.P. 11520, México, Ciudad de México. R.F.C. MME-020701-NB3. Tels.: 59-51-00 Ext. 5206 ó 01-800-463-59-89. Mattel Chile S.A., Pcte. Riesco 5561, Of. 203-204 PS2, Las Condes, Santiago. Servicio al consumidor Venezuela: Tel: 0-800-100-9123. Mattel Argentina, S.A., Av. Libertador 1000, Piso 11 – Oficinas 109 y 111, Vicente López – Prov. Buenos Aires. Tel: 0800-666-3373. Mattel Colombia, S.A., Calle 123#7-07 P5, Bogotá. Mattel Perú, S.A., Av. Juan de Arona # 151, Centro Empresarial Juan de Arona, Torre C, Piso 7, Oficina 704, San Isidro, Lima 27, Perú. RUC: 20425853865. Reg. Importador: 02350-12 JUE-DIGESA. Tel: 0800-54744. E-mail Latinoamerica: servicio.clientes@mattel.com. Mattel do Brasil Ltda. - CNPJ: 54.558.002/0001-20 - Rua Verbo Divino, 1488 - 2º Andar - 04719-904 - Chácara Santo Antônio - São Paulo - SP - Brasil. Serviço de Atendimento ao Consumidor: Contato: https://faleconosco.mattel.com.br/Contato. E-mail: sac.matteldobrazil@mattel.com.

\*Set(s) sold separately and subject to availability. / Ensemble(s) vendu(s) séparément. Certains produits peuvent ne pas être commercialisés. / Se vende(n) por separado y está(n) sujeto(s) a disponibilidad. / Conjunto(s) vendido(s) em separado e sujeito(s) à disponibilidade. / Set in vendita separatamente, secondo disponibilità. / Das/Die Set(s) sind separat erhältlich. / Zestaw(y) sprzedawany(e) oddzielnie w zależności od dostępności. / Set(s) apart verkrijgbaar en afhankelijk van beschikbaarheid. / Набор(-ы) продаются отдельно, при наличии. / Sæt sælges separat og så længe lager haves. / Seten säljs separat så länge lagret räcker. / Settet/settene selges separat så langt lagret rekker. / Pakkaus/pakkaukset myydään erikseen, saatavuus voi vaihdella. / Το(α) σετ πωλούνται ξεχωριστά και ανάλογα με τη διαθεσιμότητα. / Setler ayrı olarak satılır ve stoklara sinirlidir. / Set (sety) se prodává (prodávají) samostatně dle aktuální nabídky. / Súprava/-y sa predáva(jú) samostatne a podľa dostupnosti. / A készlet(ek) külön kapható(k), az elérhetőség változhat. / セット商品は別売りになります。在庫状況は別途ご確認お願いします。 /

بُاع المجموعة أو حدة وتخصم لتوافرها  
每套单独发售，按供货情况决定。

# BUILD BIGGER BATTLES

# IMAGINEZ DES BATAILLES TOUJOURS PLUS GRANDES



CONSTRUYE BATALLAS MÁS GRANDES • CONSTRUA BATALHAS MAIORES  
BAUE NOCH GRÖßERE SCHLACHTEN • ПОСТРОЙТЕ НОВЫЕ БИТВЫ

[MEGASHOWCASE.com](http://MEGASHOWCASE.com)



© 2023 Microsoft Corporation. All Rights Reserved. Microsoft, Halo, the Halo logo, Xbox, the Xbox logo, and 343 Industries are trademarks of the Microsoft group of companies.



™ & ©2023 Mattel. 1186 MJ, 1, NL

© D714,887, D841,101

©2023 MEGA Brands &™ MEGA Brands.  
Printed in China / Imprimé en Chine

AD-HNC56-01

Mattel Canada Inc. Mississauga, Ontario L5R 3W2.  
MADE IN CHINA. FABRIQUÉ EN CHINE. FABRICADO NA CHINA. HECHO EN CHINA.  
ИЗГОТОВЛЕНО В КИТАЕ. ÇIN'DE ÜRETİLMİŞTİR. صنع في الصين



Empowering the next generation through play.™

Inspirer les futures générations par le jeu.

