

MEGA™

HOT WHEELS

BUILDING SETS



WONDER BUILDERS™

GYG36

AMAZOOM™





Fuel their imagination with building toys that support creative thinking and problem solving.

Stimulez leur imagination avec des jouets de construction qui encouragent l'esprit créatif et la résolution de problèmes.

Alimenta su imaginación con juguetes de construcción que ayudan a desarrollar el ensamblaje creativo y la resolución de problemas. / Abasteça a imaginação dele com brinquedos de montar que suportam o pensamento criativo e a resolução de problemas. / Dieses Bauspielzeug beflügelt nicht nur die Phantasie, sondern unterstützt auch kreatives und lösungsorientiertes Denken. / Разжигайте воображение детей с помощью конструктора, развивающего творческие способности и логическое мышление.



Authentic details Détails authentiques

Detalles auténticos
Detalhes autênticos
Authentische Details
Реалистичные детали



Special pieces Pièces spéciales

Piezas especiales
Peças especiais
Spezielle Teile
Специальные детали

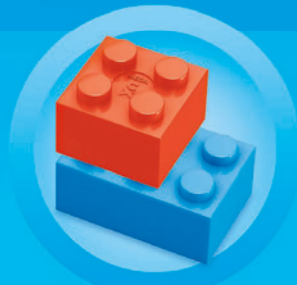

Compatible with major brands Compatible avec les grandes marques

Compatible with marcas líderes
Compatível com a maioria das marcas
Mit Bausteinen führender Marken kombinierbar
Совместимость с основными брендами

Learn more Pour en savoir plus

Más información · Sabe mais · Weiterere
Infos gibt es auf · Узнать больше

play.megaconstrux.com

MEGATM
CONSTRUX

MEGA
UNBOXED



Build Assemblez

Construye | Constrói
Bauen | Стройте



Share | Partagez

Comparte | Partilha
Teilen | Делитесь

Devices not included | Appareils non inclus | Dispositivos não incluído | Dispositivos não incluídos | Geräte nicht enthalten | Устройства не входят в комплект



Build ideas & challenges! Des idées de construction et des défis!

¡Crea ideas y desafíos!
Desafios e ideias para construções!
Verschiedene Bauideen und
Herausforderungen!
Открывайте новые
идеи и испытания!



Set(s) sold separately and subject to availability. / Ensemble(s) vendu(s) séparément. Certains produits peuvent ne pas être commercialisés. / Se vende(n) por separado y está(n) sujeto(s) a disponibilidad. / Conjunto(s) vendido(s) em separado e sujeito(s) à disponibilidade. / Set in vendita separatamente, secondo disponibilità. / Das/Die Set(s) sind separat erhältlich. Набор(-ы) продаются отдельно, при наличии.

unboxed.megaconstrux.com



1



1



2



2



2x

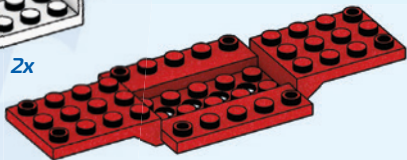

1x

3



1x

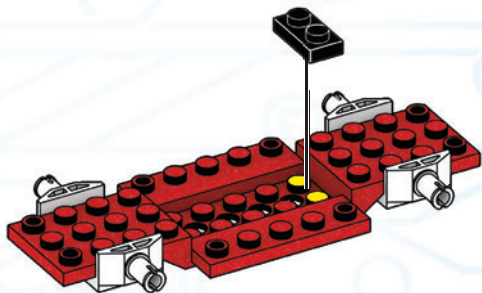
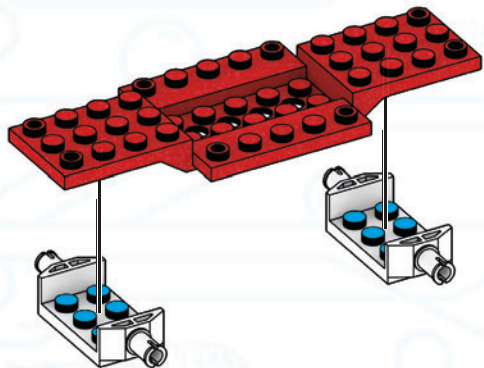

4

1x



1x

5

1x

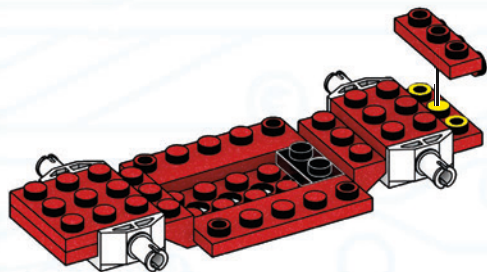
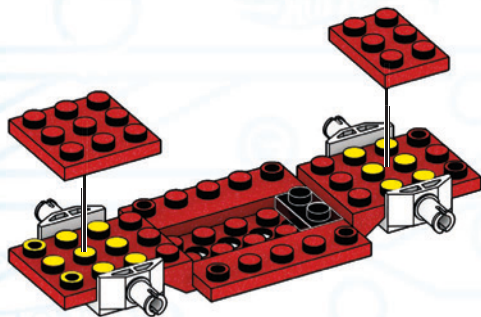



6



2x

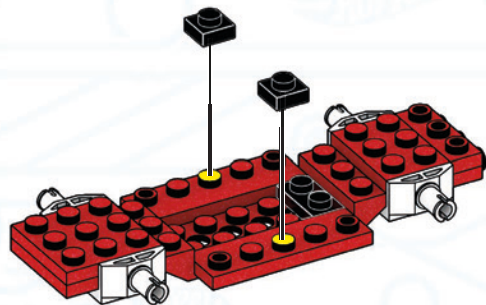

7



4x

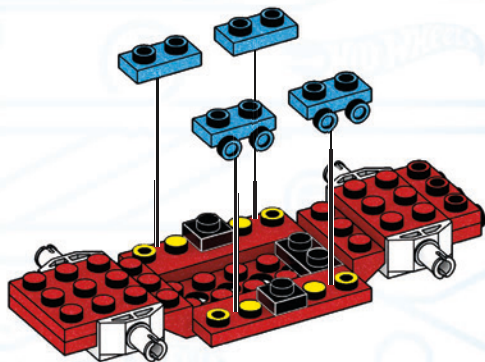

8



1x



1x

9



1x



1x



1x

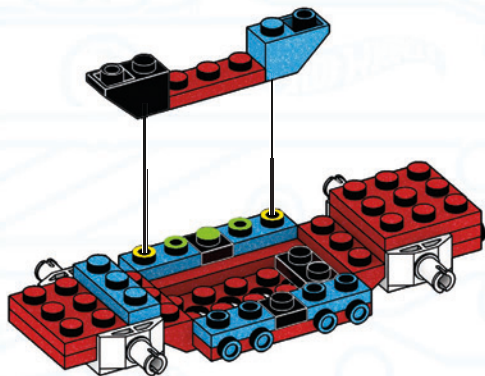
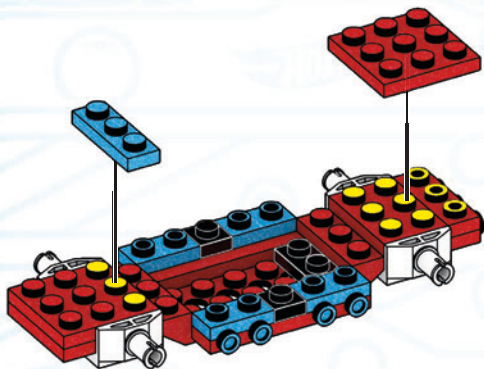



10



1x

11



1x

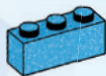

1x

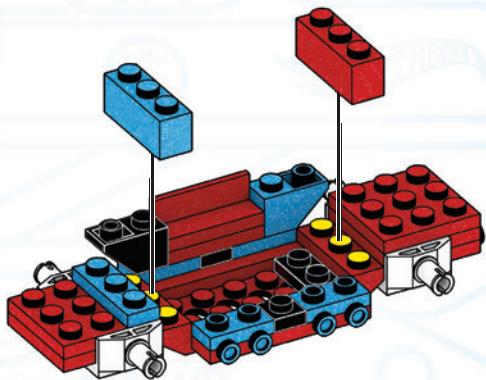
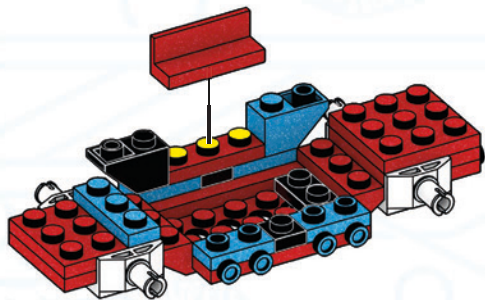

12

1x

13

1x



1x



1x

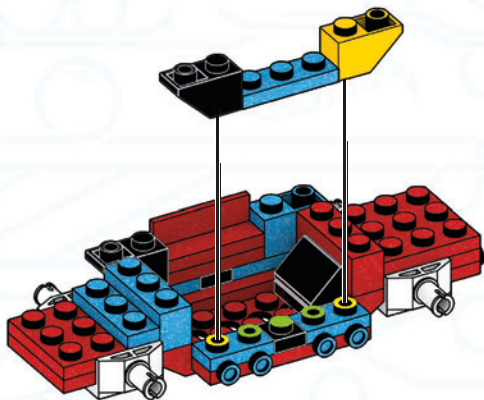
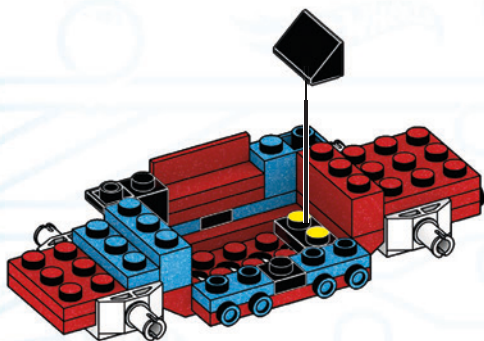



14

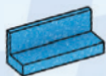

1x

15



1x

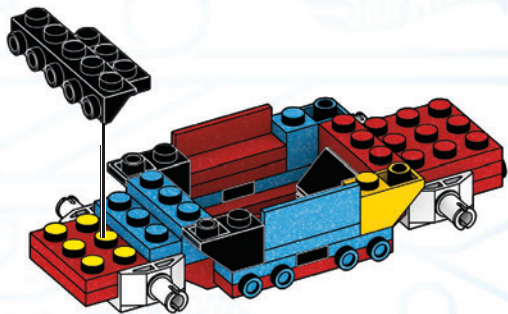
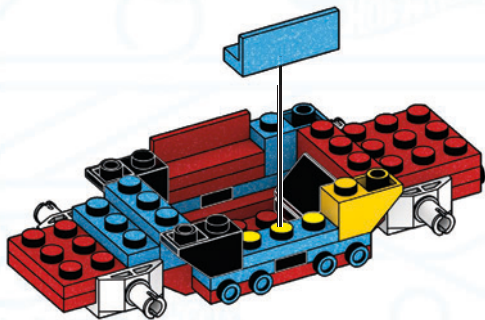

16



1x



1x

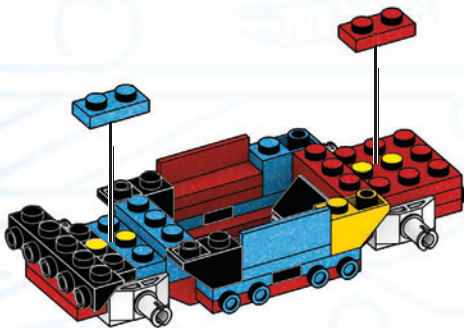

17



4x

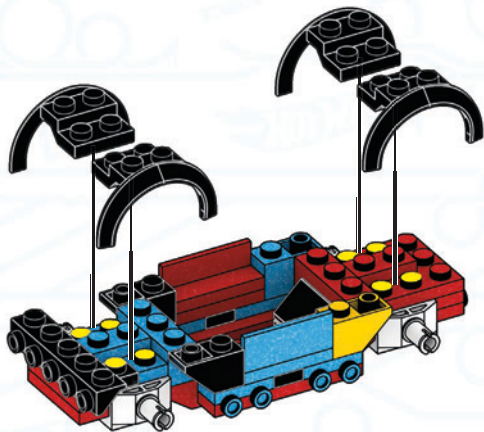



18



1x



1x

19



1x



1x



1x



1x

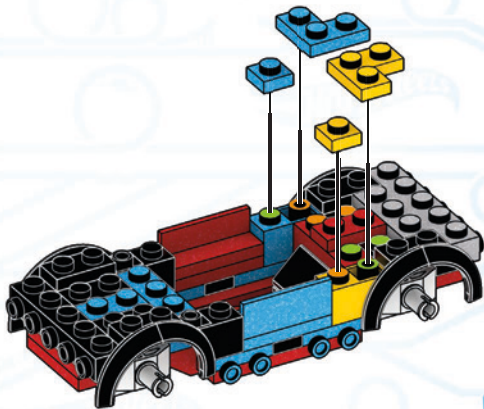
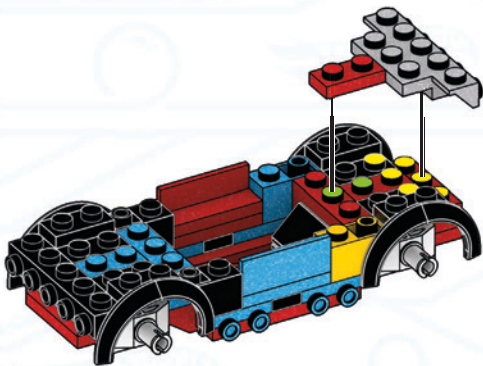

20



1x



1x

21



1x



1x

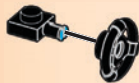

1



2

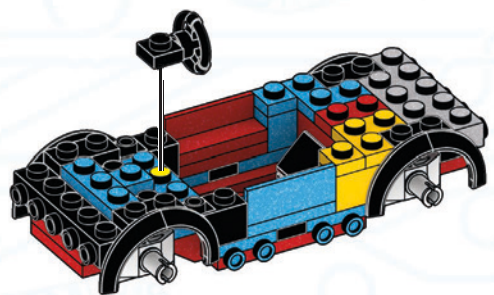
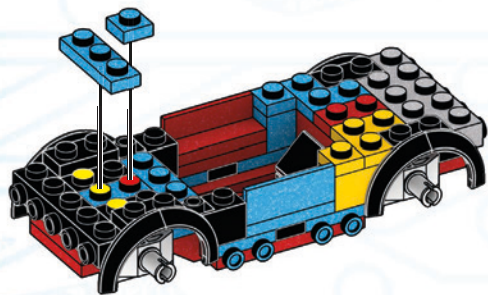



22



2x



2x

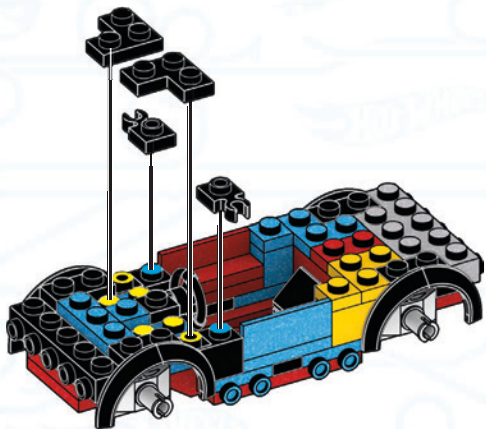

1

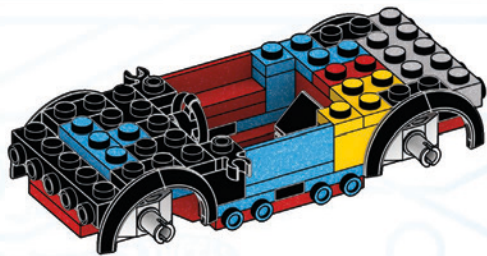

2

23

1x



1x

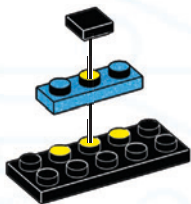

1x

**24**

1x

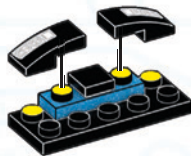

1x

**25**

1x

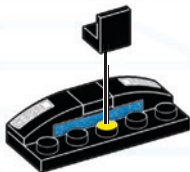
**26**

1x

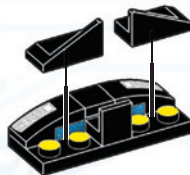

1x

**1****2**



27

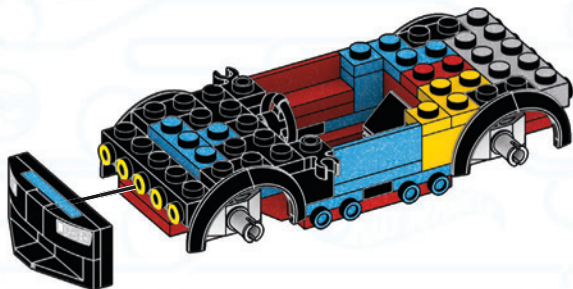

1

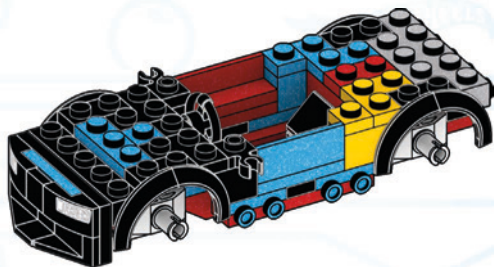

2

28



2x



1x

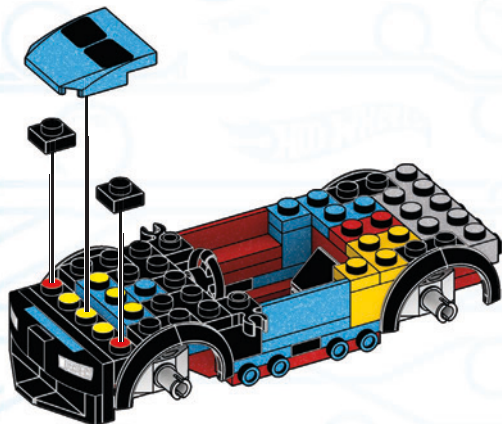

29



1x



1x

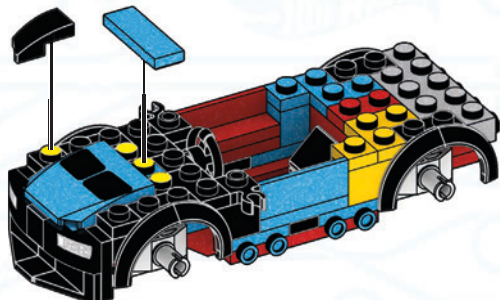



AMAZOOM™

30



1x

1x

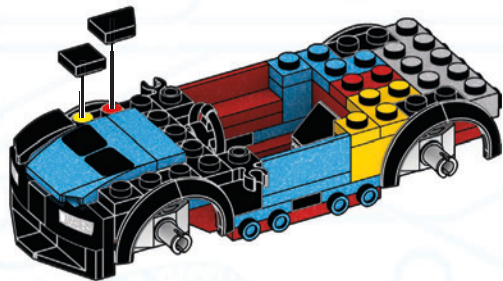

31



1x

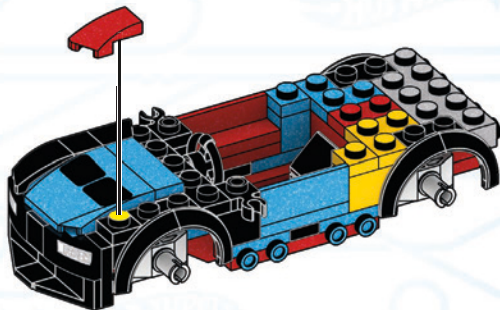

32



1x



1x

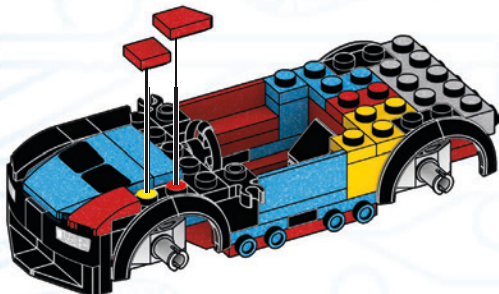

1

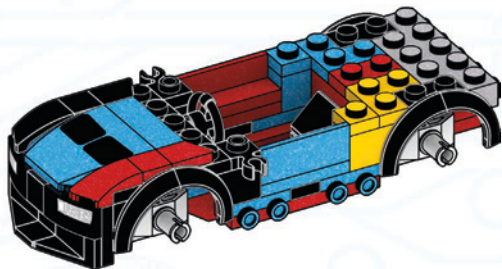

2



33



1x

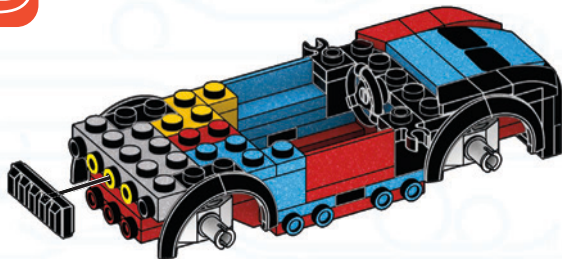

34



2x

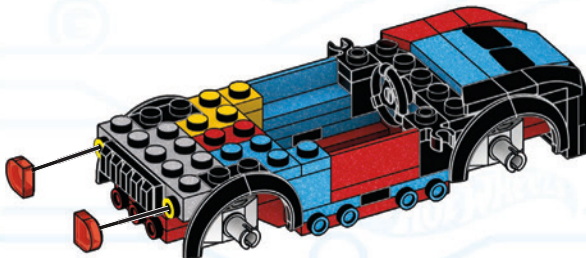

35



1x

1x

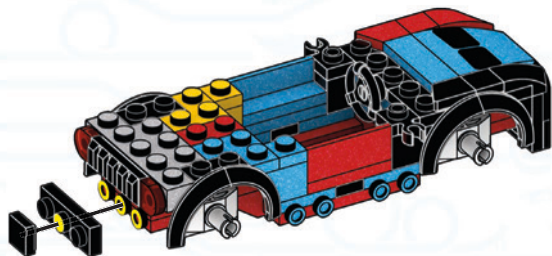

36



1x

1x

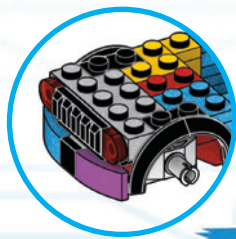
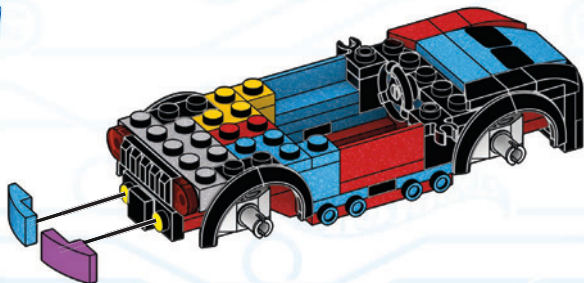



AMAZOOM™

37



1x



1x

38



1x

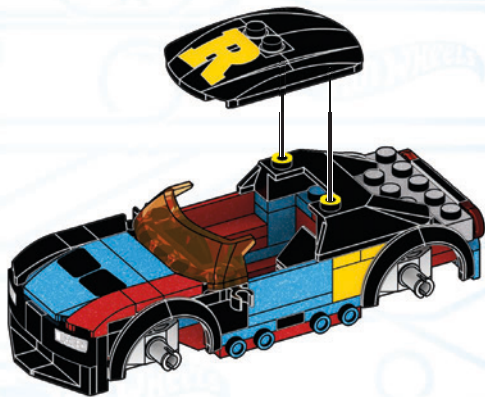
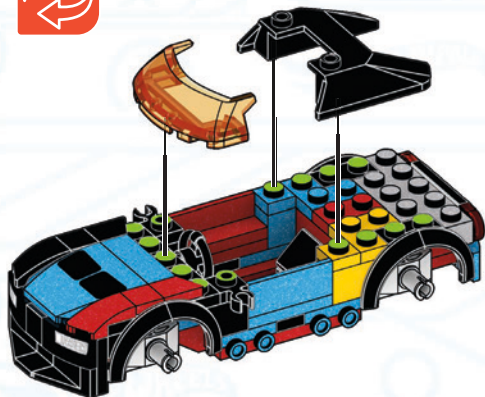

39



1x

1x

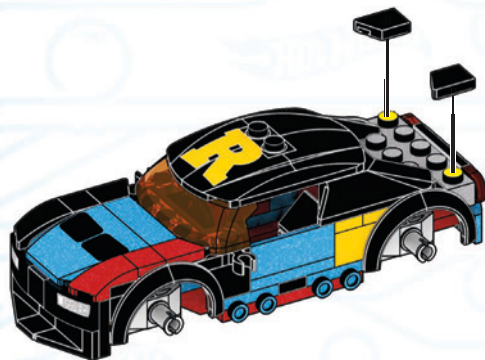

40



2x

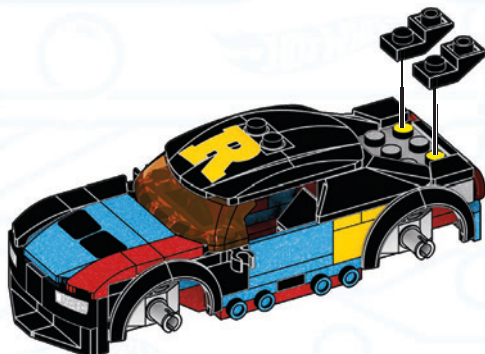



AMAZOOM™

41



2x

42



1x

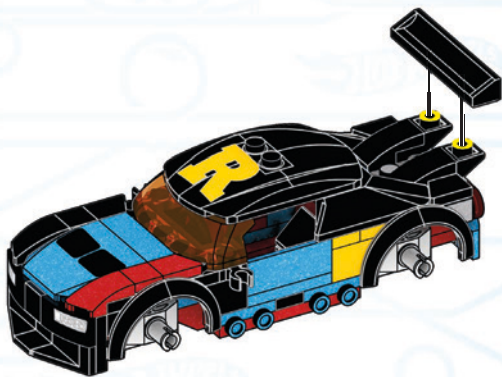
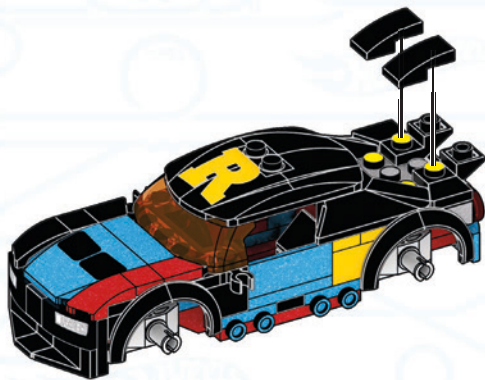

43



1x



1x

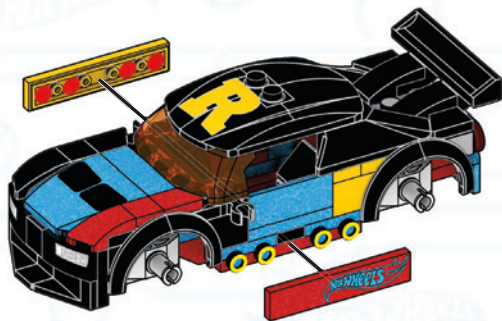



44



2x



2x

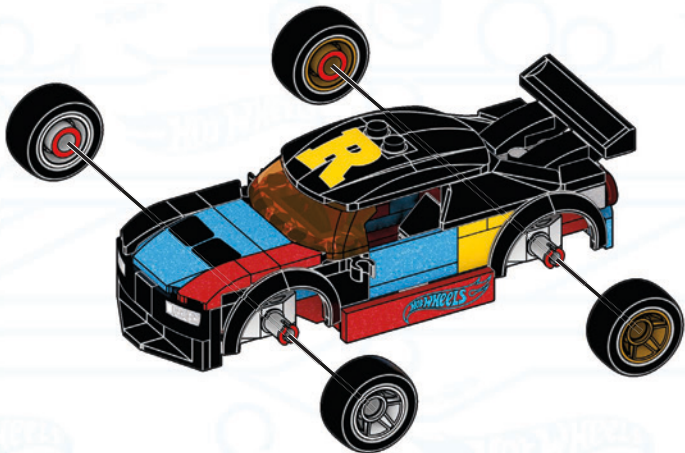

45



1x



1x

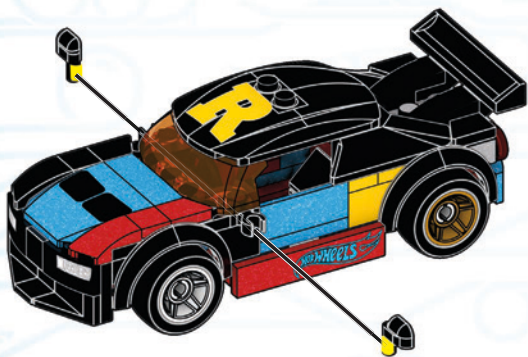

1

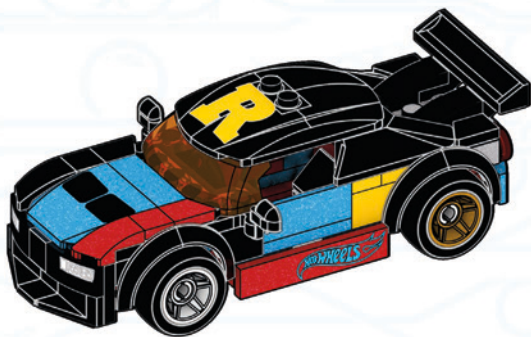

2

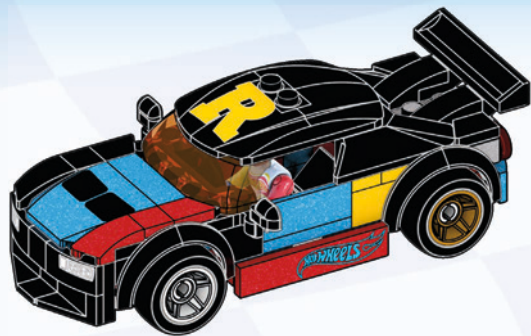
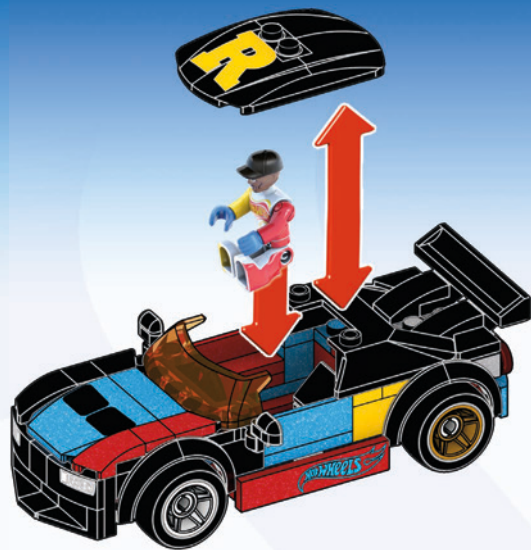

Rebuild your cars into monster trucks * Réassemble tes voitures pour en faire des Monster Trucks

Convierte tus coches en "Monster Trucks"

Transforma os seus carros em Monster Trucks

Fahrzeuge in Monster Trucks umbauen

Перестраивай свои машинки в монстр-траки



* Set(s) sold separately and subject to availability. / Ensemble(s) vendu(s) séparément. Certains produits peuvent ne pas être commercialisés. / Se vende(n) por separado y está(n) sujeto(s) a disponibilidad. / Conjunto(s) vendido(s) em separado e sujeito(s) à disponibilidade. / Set in vendita separatamente, secondo disponibilità. / Das/Die Set(s) sind separat erhältlich. / Zestaw(y) sprzedawany(e) oddzielnie w zależności od dostępności. / Set(s) apart verkrijgbaar en afhankelijk van beschikbaarheid. / Набор(-ы) продаются отдельно, при наличии. / Sæt sælges separat og så længe lager haves. / Seten säljs separat så länge lagret räcker. / Settet/settene selges separat så langt lageret rekker. / Pakkaus/pakkaukset myydään erikseen, saatavuus voi vaihdella. / Το(α) σετ πωλούνται ξεχωριστά και ανάλογα με τη διαθεσιμότητα. / Setler ayrı olarak satılır ve stoklarla sınırlıdır. / Set (sety) se prodává (prodávají) samostatně dle aktuální nabídky. / Súprava/-y sa predáva(jú) samostatne a podľa dostupnosti. / A készlet(ek) külön kapható(k), az elérhetőség változhat. /

セッ商品は別売りになります。在庫状況は別途ご確認をお願いします。 / 每套单独发售，按供货情况决定。
تباع المجموعة أو المجموعات على حدة وتخضع لتوافرها.

Additional purchase required. / Achat additionnel requis. / Zusätzlicher Kauf erforderlich. / Richiede acquisto addizionale. / Aanvullende aankoop vereist. / Requiere compra adicional. / Requier compra adicional. / Ytterligere kjøp kreves. / Edellyttää lisäosien ostamista. / Supplerende køb nødvendigt. / Ekstra kjøp kreves. / Wymagany dodatkowy zakup. / Vyžaduje dodatečný nákup. / Vyžaduje sa dokúpenie. / További vásárlás szükséges. / Неообходима допълнителна покупка. / Απαιτείται επιπλέον αγορά. / Ek ürün satın alınması gerekir.

تتطلب شراء القطع الإضافية.

Most models can be built one at a time. / La plupart des modèles peuvent être construits un à la fois. / La mayoría de modelos se pueden construir de uno en uno. / A maioria dos modelos pode ser construída separadamente. / La maggior parte dei modelli possono essere realizzati uno per volta. / Die meisten Modelle können eines nach dem anderen gebaut werden. / Większość modeli nie da się budować jednocześnie z innymi. / De meeste modellen kunnen één voor één gebouwd worden. / Большинство моделей могут быть собраны по одной за раз. / De fleste modeller kan bygges enkeltvis. / De flesta modeller kan byggas en i taget. / De fleste modellene kan bygges en om gangen. / Seimmat mallit voidaan rakentaa yksi kerrallaan. / Τα περισσότερα μοντέλα μπορούν να κατασκευασθούν ένα ένα. / Modellerein çoğu ayrı ayrı inşa edilmeyi gerektirebilir. / Většina lze najednou sestavit pouze jeden model. / Väčšina modelov môže byť zostavená iba raz. / A modellek többségéből egyszerre csak egy építhető.

ほとんどのモデルは、一度に一つを組み立てることができます。

يمكن تركيب التصاميم الواحد تلو الآخر.

大多數型號可一次性建構。 29

2X AM76204X
 3X AM07223F
 1X AM07223AXW
 4X AM03328F
 1X AM03328BYE
 2X AM03328AYP
 1X AM15485F
 1X AM80546F
 2X AM18591F
 1X AM74299AXW
 1X AM74299F
 2X AM74300F
 1X AM74401F
 1X AM74400F

1X AM18220F
 2X AM09393AXW
 1X AM09393AYP
 1X AM09393F
 4X AM76467AYP
 2X AM72002F
 1X AM74427F
 1X AM74426AXW
 1X AM03019F
 1X AM81255F
 1X AM81256F

1X AM78486AYP
 1X AM78486AEN
 2X AM78486F
 1X AS-GYG36-05
 1X AS-GYG36-06
 2X AM01417F
 1X AM01417AYP
 1X AM01417BYE
 1X AM15484AYP
 1X AM15484BYE
 2X AM15484F
 1X AM80966AYP
 1X AM74103F

4X AM01314AYP
 1X AM01314AXW
 1X AM01314F
 1X AM81260AXW
 1X AM80967AXW
 1X AM80967AYP
 1X AM16384AXW
 1X AM16384AYP
 1X AM03772AXW
 4X AM80972F

2X AS-GYG36-08
 2X AS-GYG36-07
 1X AS-GYG36-02
 2X AM81163AXW
 2X AM80971E
 1X AS-GYG36-03
 1X AS-GYG36-04
 1X AM81253F
 1X AM80965F

1X AM80969APG
 1X AM80970F
 1X AM80538KC
 1X AS-GYG36-01
 1X AM80975AXW

1x FIG-GYG36-A

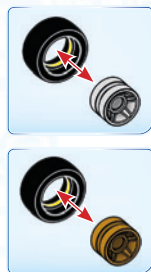

**Missing pieces?
 Pièces manquantes?
 ¿Partes faltantes? · Perdeu peças?
 Fehlen Teile? · Не хватает деталей?**

support.megabrands.com

Mattel Europa B.V., Gondel 1, 1186 MJ Amstelveen, Nederland. Mattel U.K. Limited, The Porter Building, 1 Brunel Way, Slough SL1 1FQ, UK. Mattel France, Parc de la Cerisaie, 1/3/5 allée des Fleurs, 94260 Fresnes Cedex. N° Cristal 0969 36 99 99 (Numéro non surtaxé) ou www.Jesjouetsmattel.fr Mattel Belgium, Trade Mart, Atomiumsquare, Bogota 202 – B 275, 1020 Brussels. Gratis nummer België: 0800 – 16 936 – Gratis nummer Luxemburg: 800 – 22 784 – Gratis nummer Nederland: 0800 – 262 88 35. Deutschland : Mattel GmbH, Solmsstraße 4, D-60486 Frankfurt am Main. Schweiz: Mattel AG, Kirchstrasse 24, CH-3097 Liebefeld. Österreich: Mattel Ges.m.b.H., Campus 21, Liebermannstraße A01 404, A- 2345 Brunn/Gebirge. Mattel Italy Srl, Via Bracco, 6-MAC 6, 20159 Milano, Italy. Servizio assistenza clienti: Customersrv.italia@mattel.com - Numero verde 800 11 37 11. Mattel España, S.A., Aribau 200. 08036 Barcelona. cservice.spain@mattel.com Tel: 902203010 http://www.service.mattel.com/es. Mattel East Asia Ltd., Room 503-09, North Tower, World Finance Centre, Harbour City, Tsimshatsui, HK, China. Tel.: (852) 3185-6500. Diimpört & Diedarkan Oleh: Mattel Continental Asia Sdn Bhd. Level 19, Tower 3, Avenue 7, No. 8 Jalan Kerinchi, Bangsar South, 59200 Kuala Lumpur, Malaysia. Mattel South Africa (PTY) LTD, Office 102 B, 30 Melrose Boulevard, Johannesburg 2196. Dystrybutor: Mattel Poland Sp. z o.o., Warsaw Trade Tower 34 p., ul. Chłódna 51, 00-867 Warszawa. Mattel Australia Pty. Ltd., 658 Church St., Richmond, Victoria, 3121. Consumer Advisory Service - 1300 135 312. Mattel AEBE, Εθνογύου Μακρορίου 1, Κτηριο Κ-2, ΤΚ 17561, Παλαιό Φάληρο. Mattel Oyuncakçılık Tic. Ltd. Şti. İçerenköy Mah., Erkut Sok. A Blok No:12 Üner Plaza Kat:9-10 34752 Ataşehir İstanbul. Tel: 0216 570 75 00. Импортер/Уполномоченная организация: ООО "МАТТЕЛ" Российская Федерация, 105120 Москва, 2-й Сыромятинский переулок, 1; +7 495 287 79 39. Forg.: Mattel Toys Hungary Kft 1139 Budapest Váci út 91. +36 1 270 0223. Mattel Czech Republic s.r.o., The Forum, Václavské nám. 19, 11000 Praha1. Mattel, 333 Continental Boulevard, El Segundo, CA 90245, USA. Consumer Services: 1-800-465-MEGA (6342). Importado y distribuido por Mattel de México, S.A. de C.V., Miguel de Cervantes Saavedra No. 193, Pisos 10 y 11, Col. Granada, Alcaldía Miguel Hidalgo, C.P. 11520, México, Ciudad de México. R.F.C. MME-920701-NB3. Tel.: 59-05-51-00 Ext. 5206 ó 01-800-463-59-89. Mattel Chile, S.A., Avenida América Vespucio 501-B, Quilicura, Santiago. Tel.: 1230-020-6213. Servicio al consumidor Venezuela: Tel.: 0-800-100-9123. Mattel Argentina, S.A., Av. Libertador 1000, Piso 11 – Oficinas 109 y 111, Vicente López – Prov. Buenos Aires. Tel.: 0800-666-3373. Mattel Colombia, S.A., Calle 12347-07 P5, Bogotá. Tel.: 01800-710-2069. Mattel Perú, S.A., Av. Juan de Arona # 151, Centro Empresarial Juan de Arona, Torre C, Piso 7, Oficina 704, San Isidro, Lima 27, Perú. RUC: 20425853865. Reg. Importador: 02350-12-JUE-DIGESA. Tel.: 0800-54744. E-mail Latinoamérica: servicio.clientes@mattel.com. Mattel do Brasil Ltda.- CNPJ : 54.558.002/0001-20 – Rua Verbo Divino, 1488 – 2ª. Andar - 04719-904 – Chácara Santo Antônio - São Paulo - SP - Brasil. Serviço de Atendimento ao Consumidor: fone 0800 575 0780. E-mail: sac.matteldobrazil@mmattel.com

⚠ WARNING:
CHOKING HAZARD. - Small parts.
Not for children under 3 years.

⚠ ATTENTION:
DANGER D'ÉTOUFFEMENT. - Présence de petits éléments.
Ne convient pas aux enfants de moins de 3 ans.

⚠ 警告:
のどにつまる危険 小さな部品が含まれています
3歳以下の子供には与えないで下さい。
غير مناسبة للأطفال دون 36 شهراً - قطع صغيرة.

⚠ 警告!
不适合3岁以下儿童使用。
内含小零件。

ADVERTENCIA: PELIGRO DE ATRAGANTAMIENTO. Juguete no recomendado para menores de 3 años, porque contiene piezas pequeñas que podrían provocar asfixia en caso de ser ingeridas o inhaladas por el/la niño/a.

ATENÇÃO! Não indicado / não recomendável para crianças menores de 3 (três) anos por conter parte(s) pequena(s) que pode(m) ser engolid(a)s ou aspirada(s) podendo provocar asfixia.

AVVERTENZA: Contiene pezzi di piccole dimensioni.

ACHTUNG: Kleine Teile.

OSTRZEŻENIE: Małe części. Niebezpieczeństwo zadławienia.

WAARSCHUWING: Kleine onderdelen

ПРЕДУПРЕЖДЕНИЕ: Мелкие детали.

ADVARSEL: Indeholder små dele.

VARNING: Smådelar

ADVARSEL: Små deler

VAROITUS: Pieniä osia

ΠΡΟΣΟΧΗ: Περιλαμβάνονται μικρά κομμάτια.

UVARI: Kūčūik parçalar.

UPOZORNĚNÍ: Malé díly

UPOZORNENIE: Malé časti

FIGYELMEZTETÉS: Kis alkatrészek.





AMAZOOM™



Are you ready for the next challenge?
Prêt pour le prochain défi?

¿Estás listo para el siguiente desafío?
Você está pronto para o próximo desafio?
Bist du bereit für die nächste Herausforderung?
Вы готовы к следующему испытанию?

MORE TO BUILD! ENCORE PLUS À CONSTRUIRE!
¡MÁS PARA CONSTRUIR! - MAIS PARA CONSTRUIR!
MEHR ZUM BAUEN! - КОНСТРУИРУЙ БОЛЬШЕ!



GVM27



GYG34



GYG37



GYG35



GVM26



Set(s) sold separately and subject to availability. / Ensemble(s) vendu(s) séparément. Certains produits peuvent ne pas être commercialisés. / Se vende(n) por separado y está(n) sujeto(s) a disponibilidad. / Conjunto(s) vendido(s) em separado e sujeito(s) à disponibilidade. / Set in vendita separatamente, secondo disponibilità. / Das/Die Set(s) sind separat erhältlich. / Zestaw(y) sprzedawany(e) oddzielnie w zależności od dostępności. / Set(s) apart verkrijgbaar en afhankelijk van beschikbaarheid. / Набор(-ы) продаются отдельно, при наличии. / Sæt sælges separat og så længe lager haves. / Seten säljs separat så länge lagret räcker. / Settet/settene selges separat så langt lageret rekker. / Pakkaus/pakkaukset myydään erikseen, saatavuus voi vaihdella. / Το(α) σ(ε)τ πωλύνται ξεχωριστά και ανάλογα με τη διαθεσιμότητα. / Setler ayrı olarak satılır ve stoklarla sınırlıdır. / Set (sety) se prodává (prodávají) samostatně dle aktuální nabídky. / Súprava/-y sa predáva(jú) samostatne a podľa dostupnosti. / A készlet(ek) külön kapható(k), az elérhetőség változhat. / セット商品は別売りになります。在庫状況は別途ご確認ください。 / ُباع المجموعة أو المجموعات على حدة وتخضع لتوافرها.

每套单独发售，按供货情况决定。

1186 MJ, 1, NL

© 2020, MEGA Brands &™ MEGA Brands; HOT WHEELS and associated trademarks and trade dress are owned by and used under license from Mattel. HOT WHEELS ainsi que les marques et designs y afférents appartiennent à, et sont utilisés sous licence de Mattel. © 2020 Mattel.
Printed in China / Imprimé en Chine AD-GYG36-01A

