



# POKÉMON



SCAN TO SEE  
**MOVEMENT**  
SCANNEZ POUR LE VOIR EN  
**MOUVEMENT**



HMW05

## MOTION CHARIZARD DRACAUFEU EN MOUVEMENT

CHARIZARD CON MOVIMIENTO / CHARIZARD MÓVEL  
BEWEGLICHER GLURAK / ДВИЖУЩИЙСЯ CHARIZARD



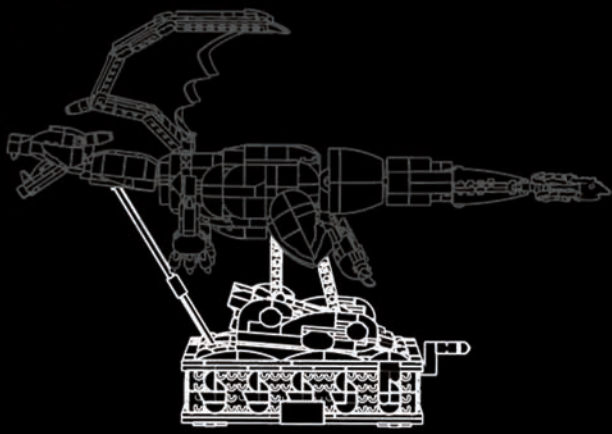



4

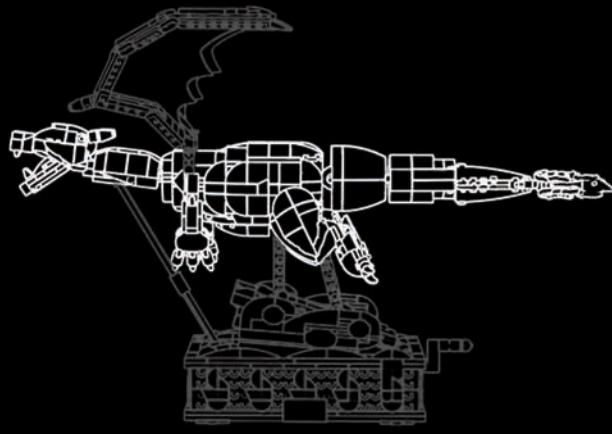

1 → 13



94



14 → 27

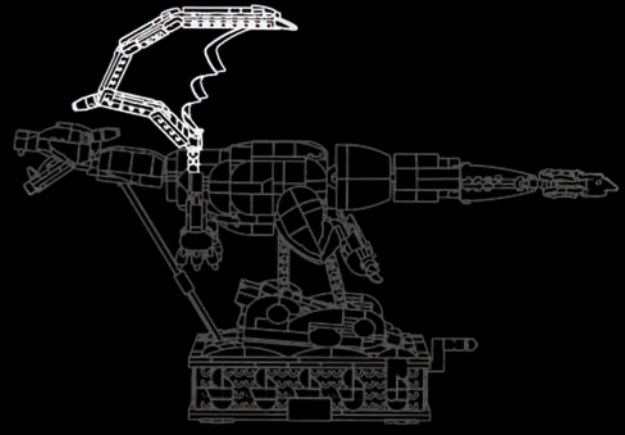

160



28

# BUILDING TOOL OUTIL DE CONSTRUCTION

HERRAMIENTA DE CONSTRUCCIÓN  
BAUWERKZEUG  
FERRAMENTA DE MONTAGEM  
ИНСТРУМЕНТ ДЛЯ КОНСТРУИРОВАНИЯ

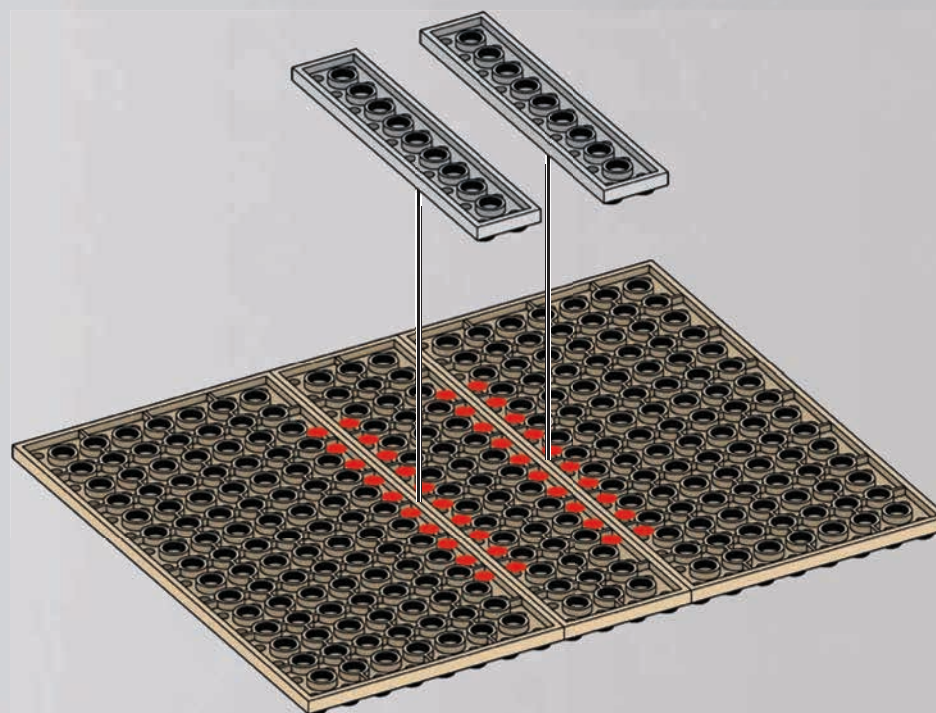
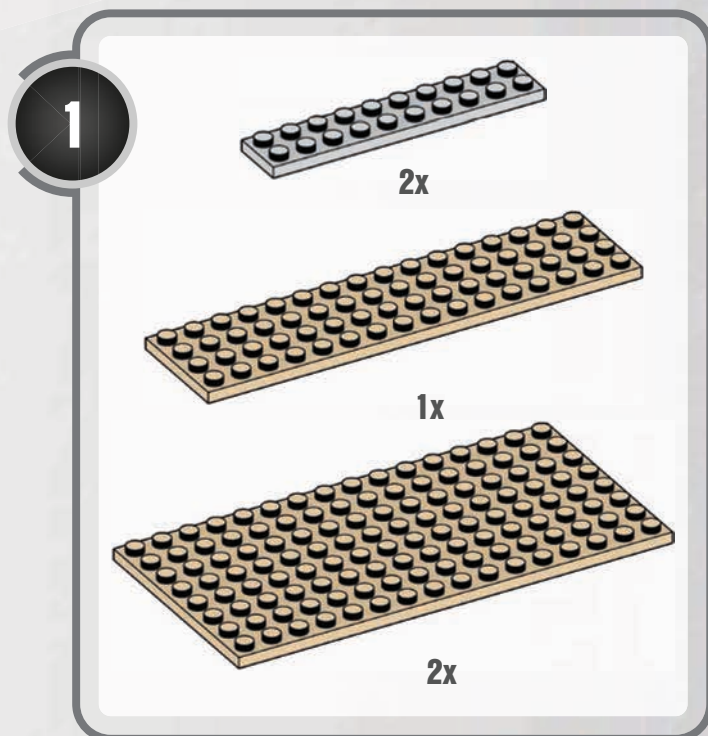
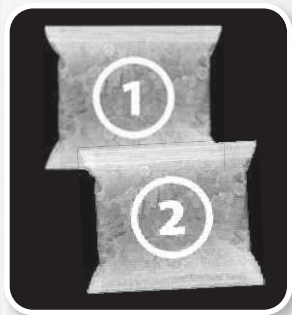
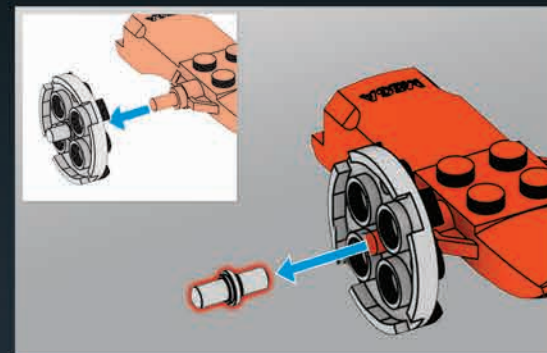
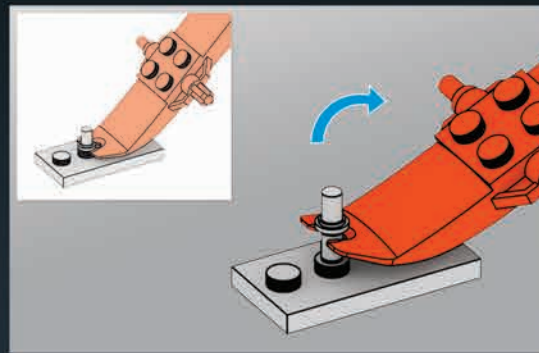
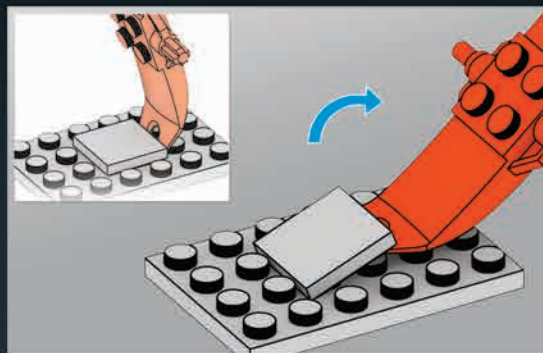
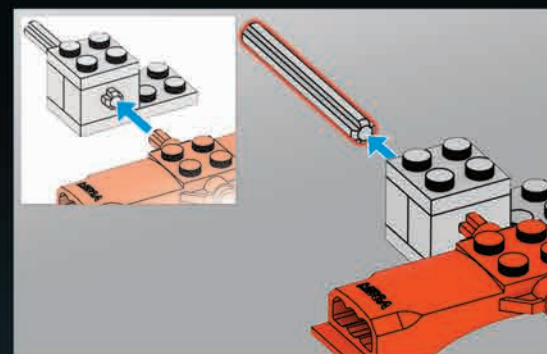
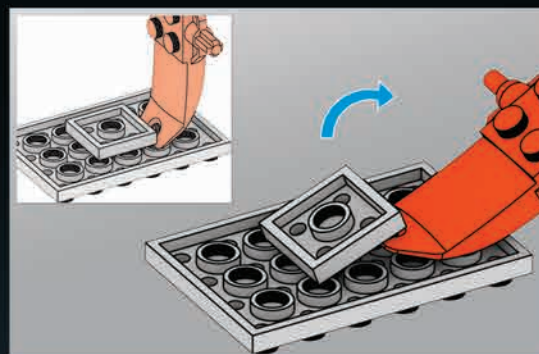
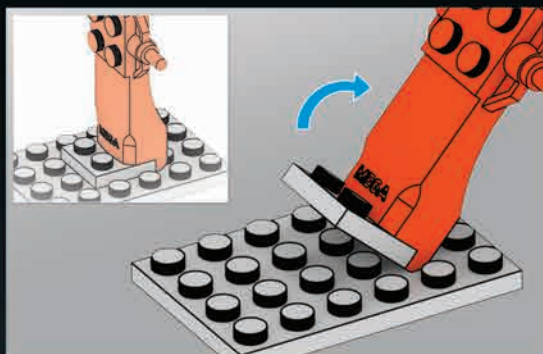

2

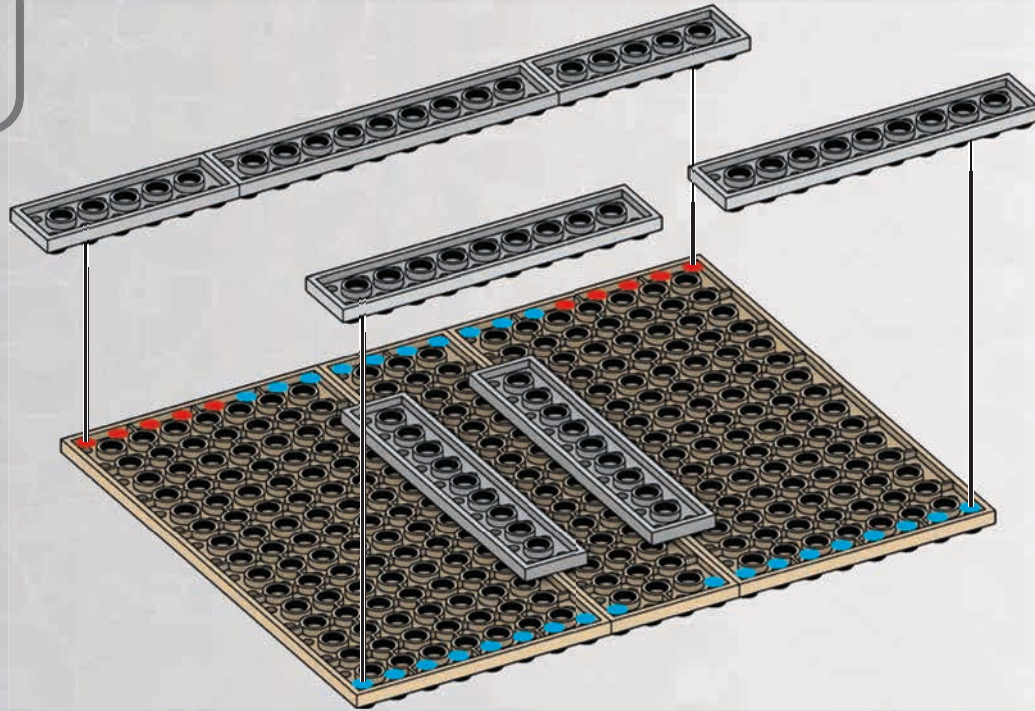

3

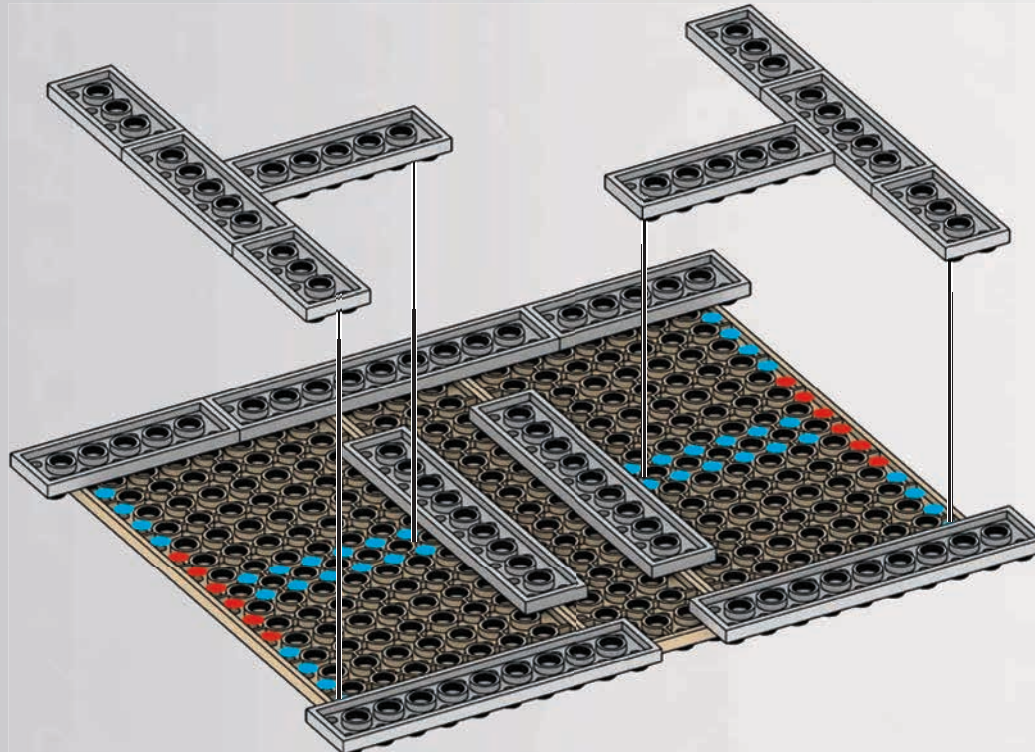
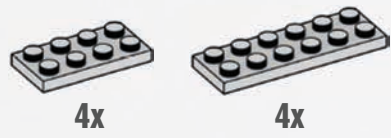

4



4x



1x

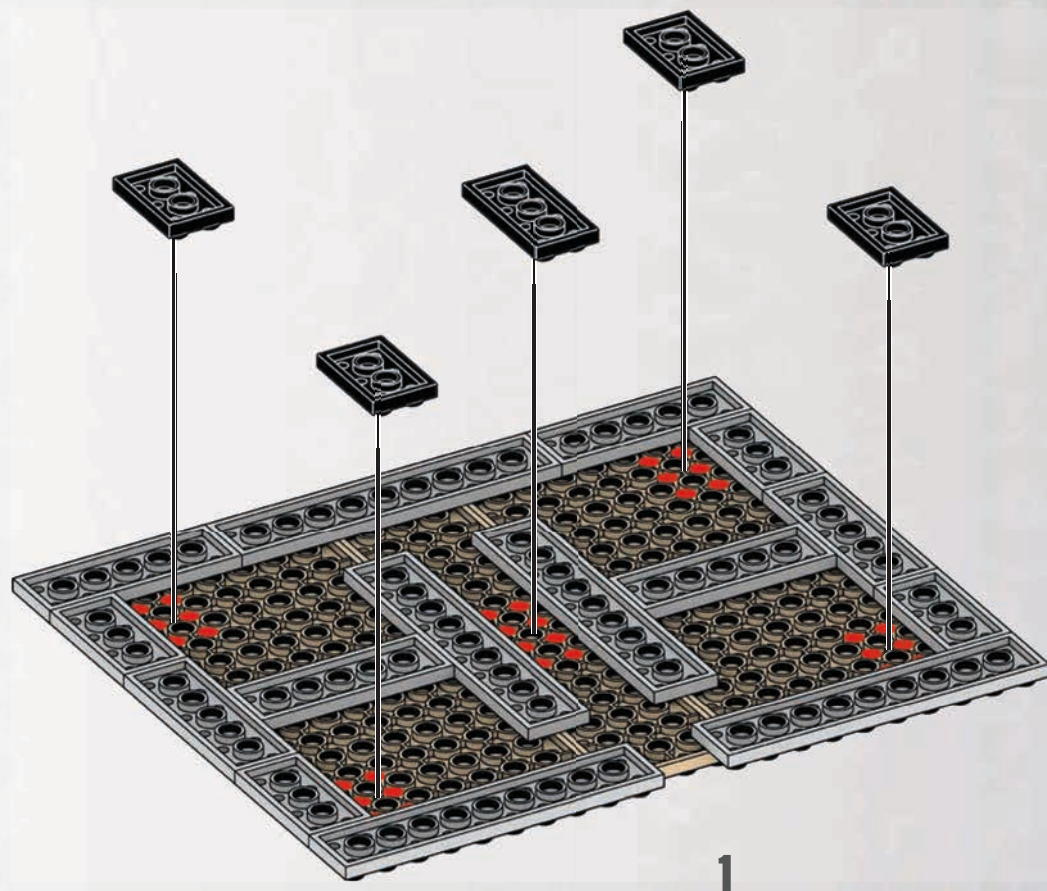

1

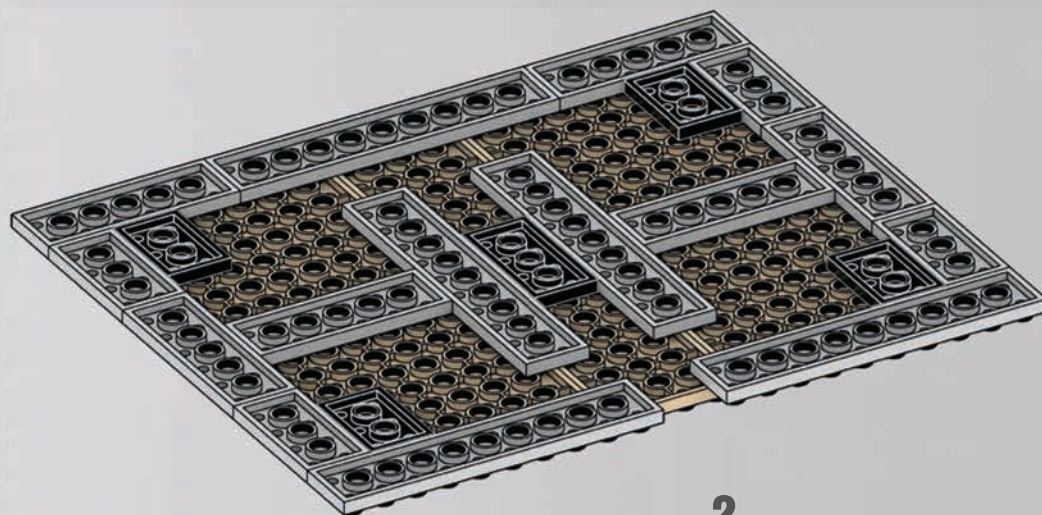

2

5

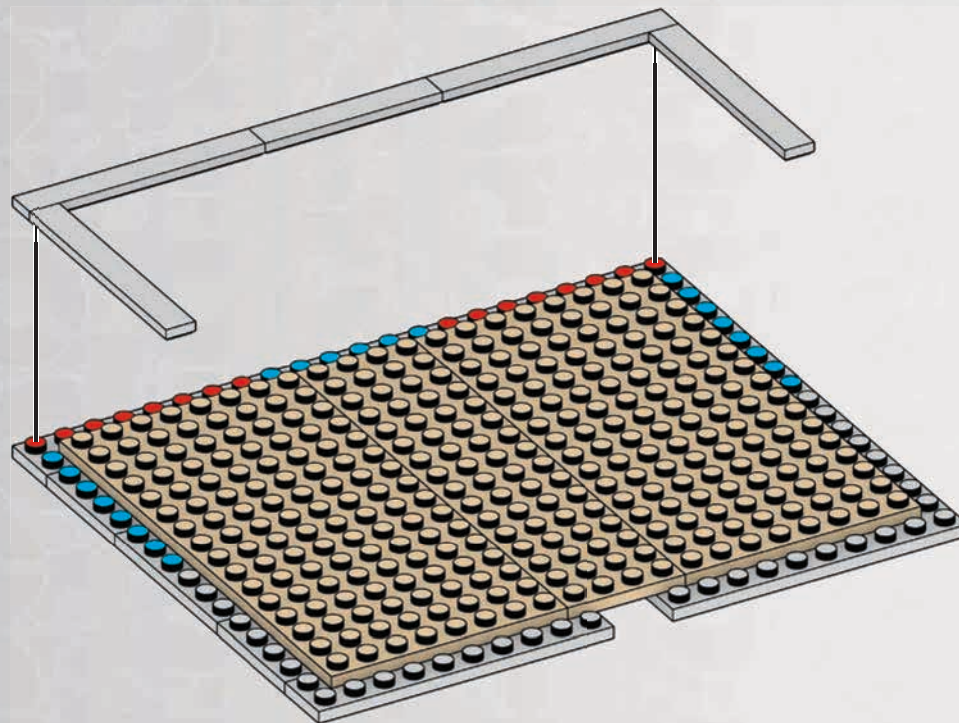
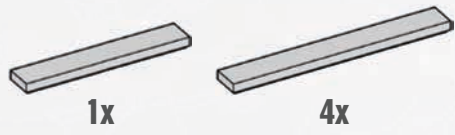

6

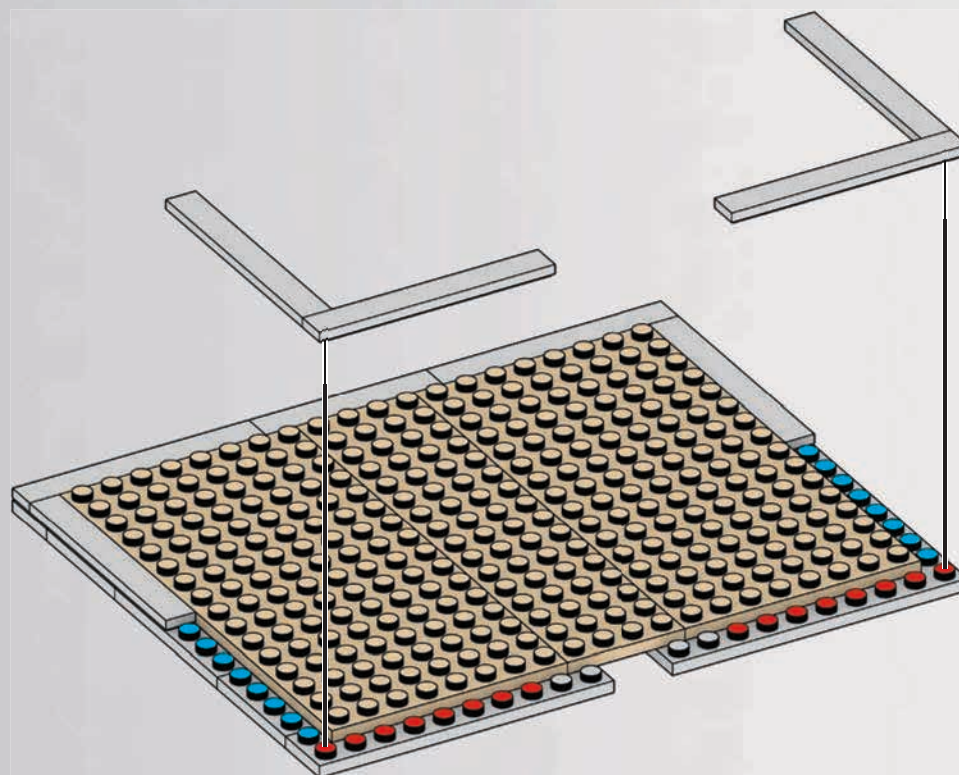
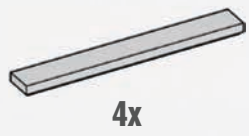

7



1x



1x

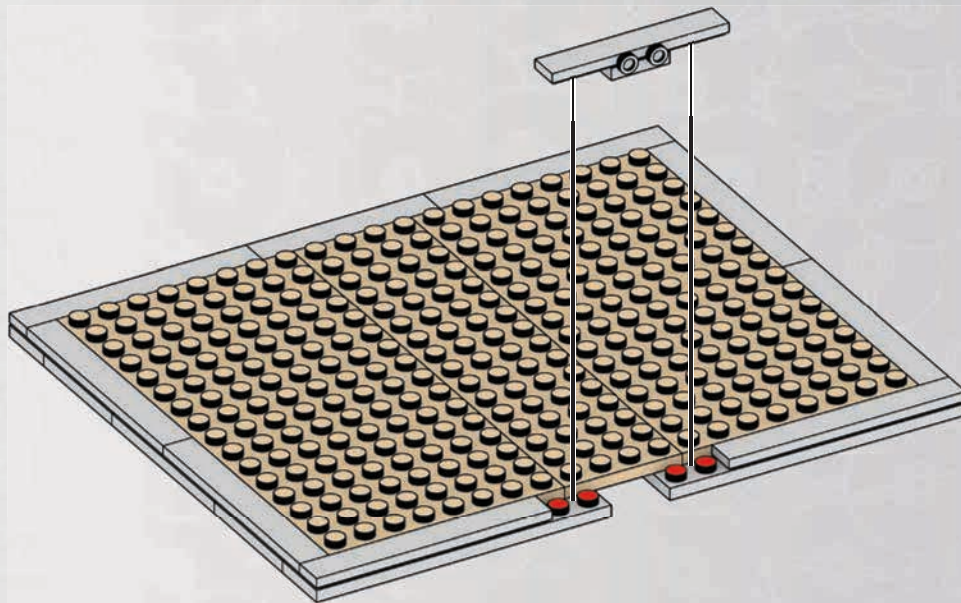
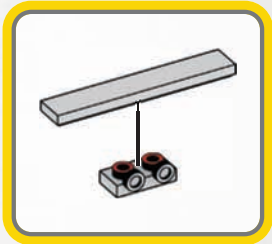

8



2x



3x

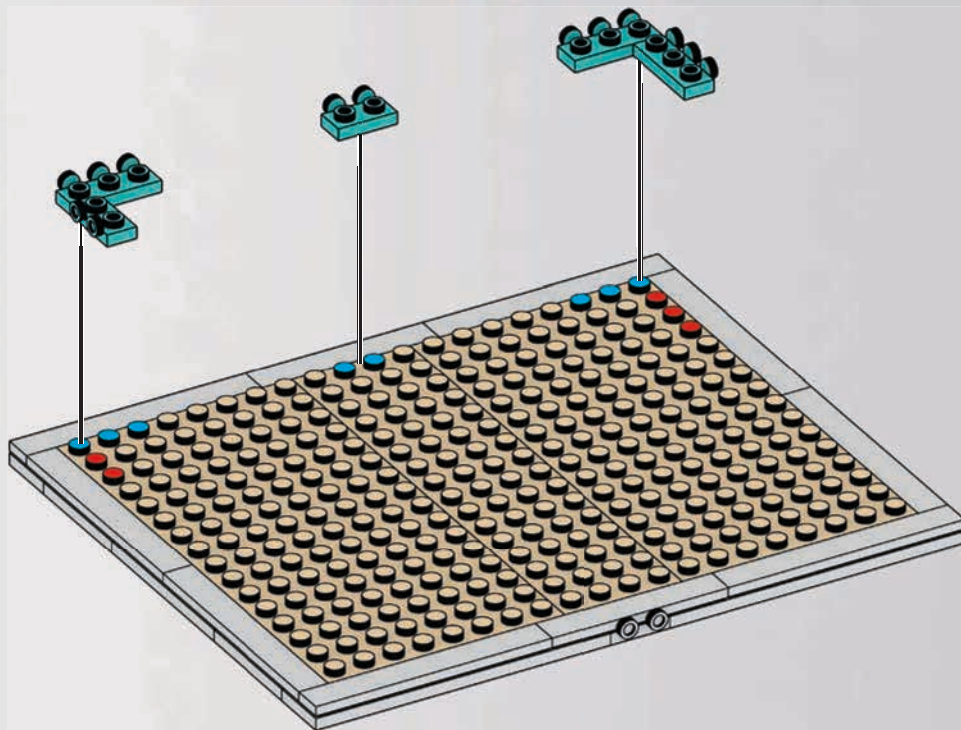



9



3x



4x

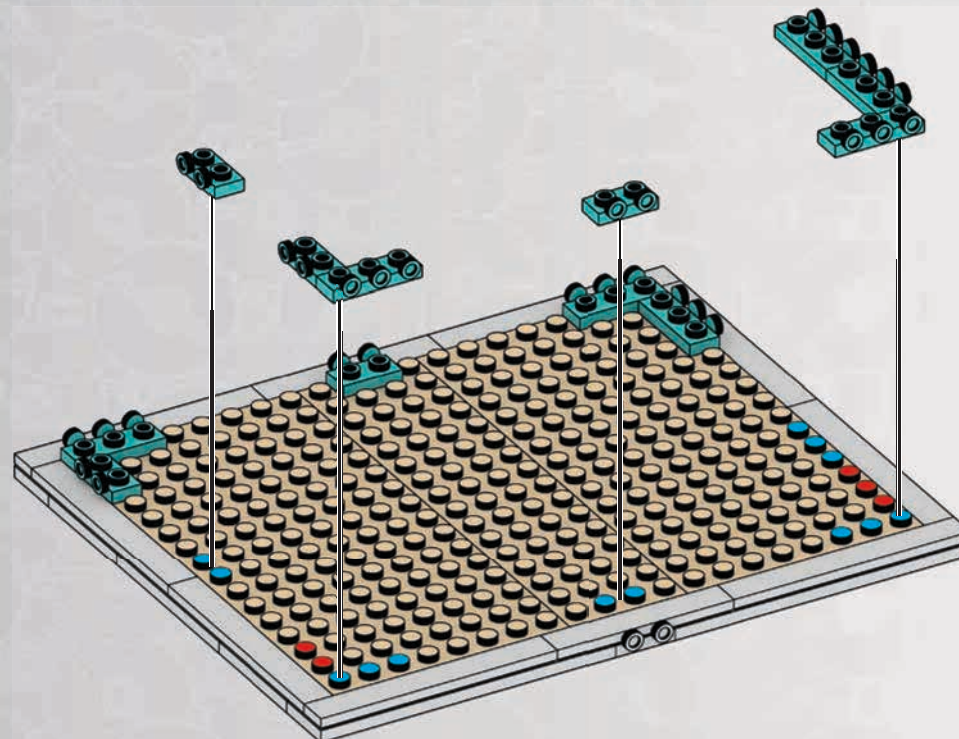

10



1x



2x



3x

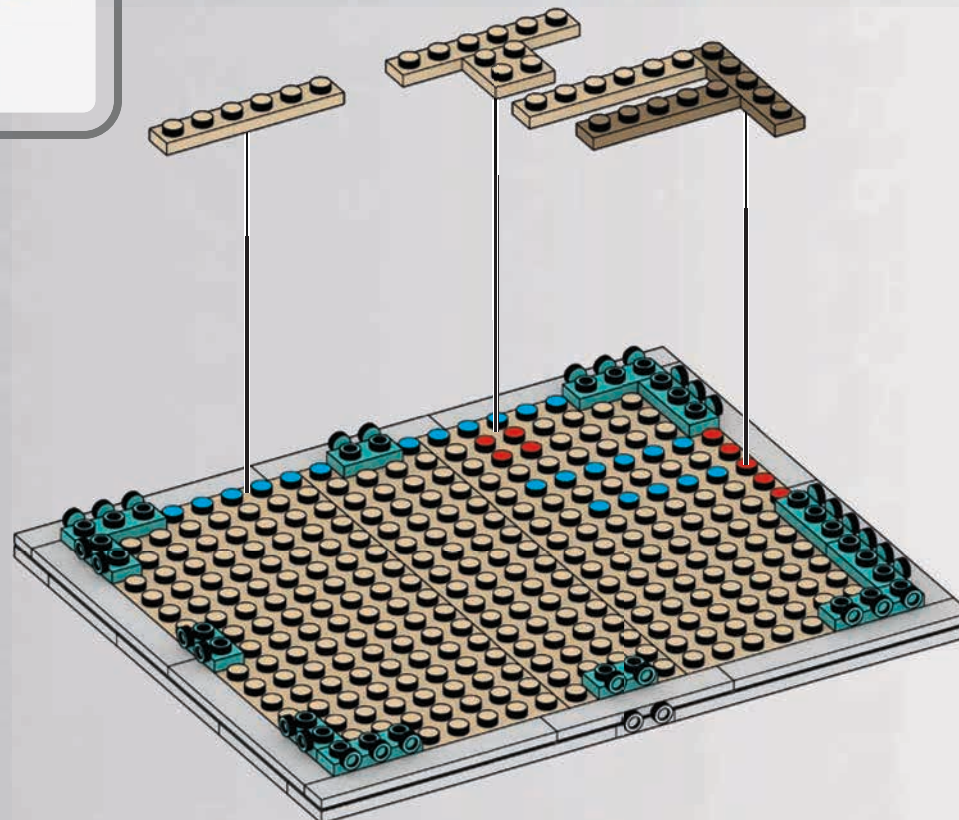

11

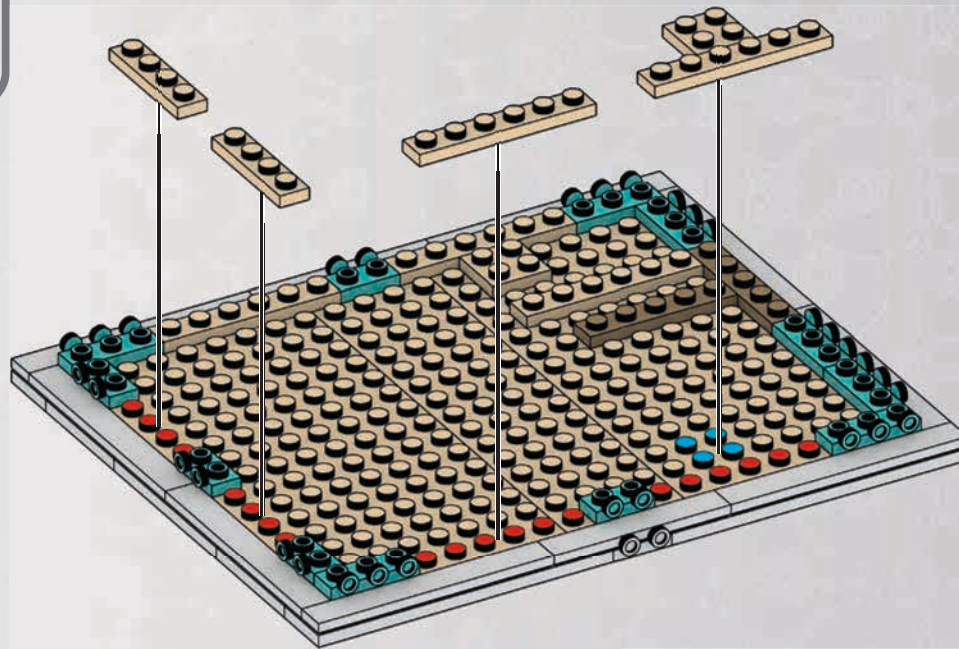

12

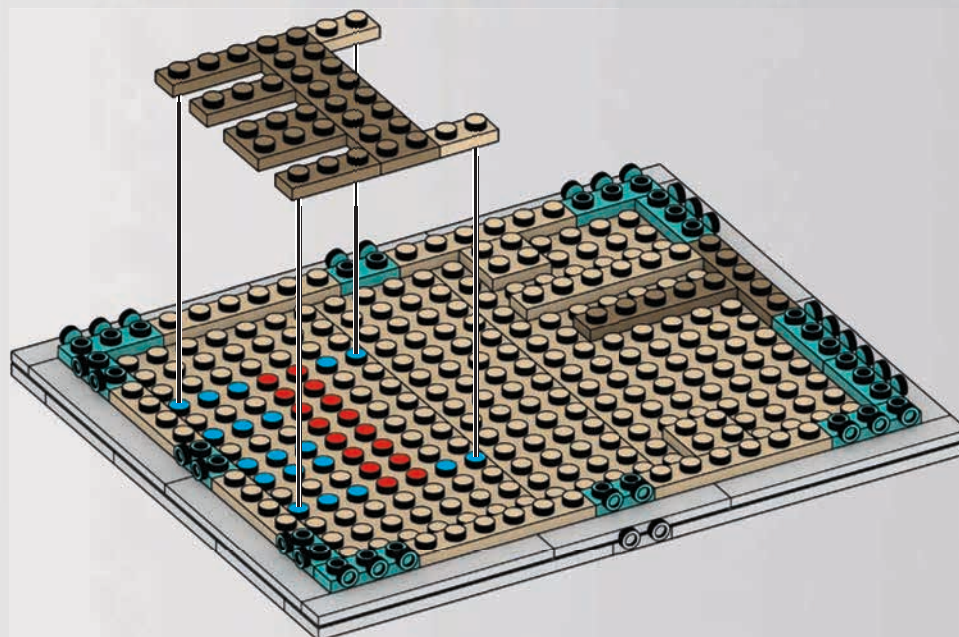
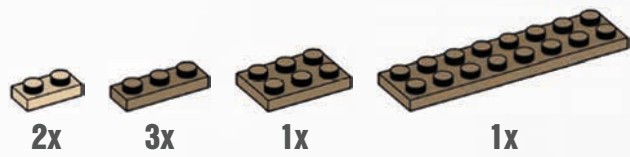

13



1x

1x

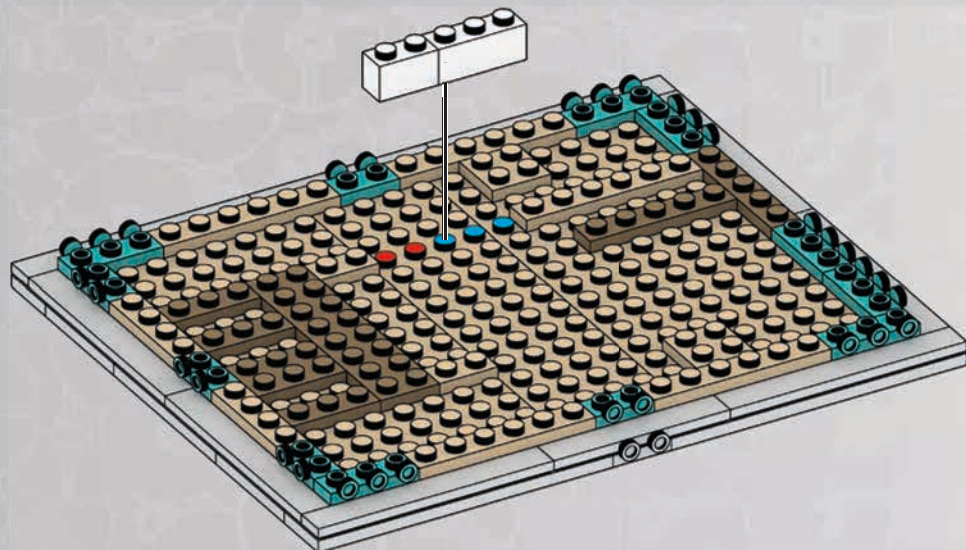

14



1x



1x



2x



1x



1x

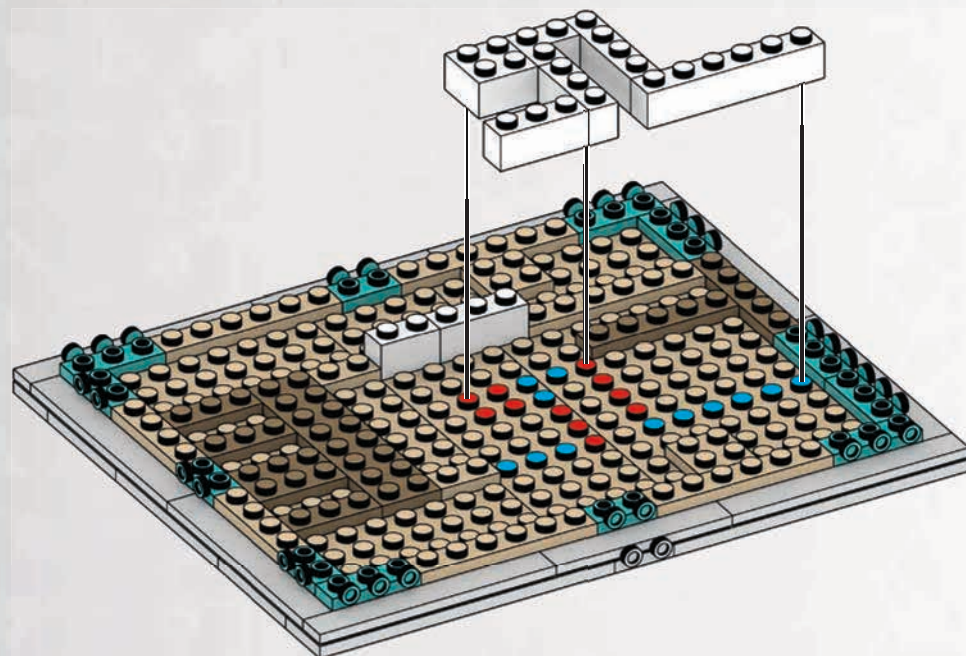

15



2x



2x

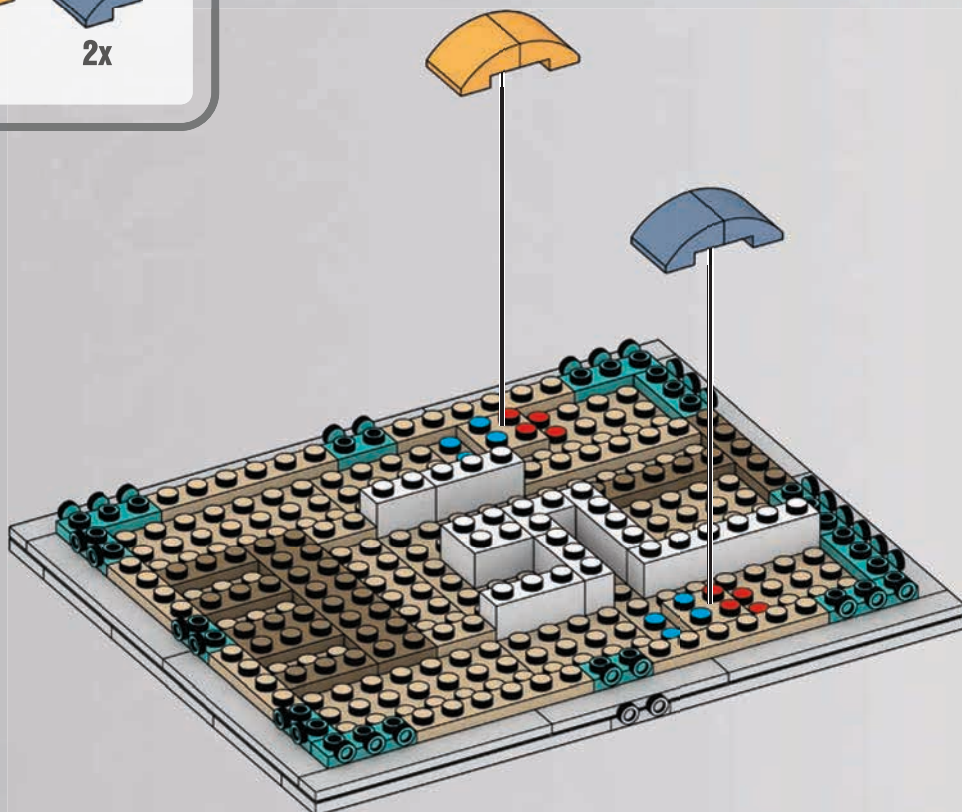

16

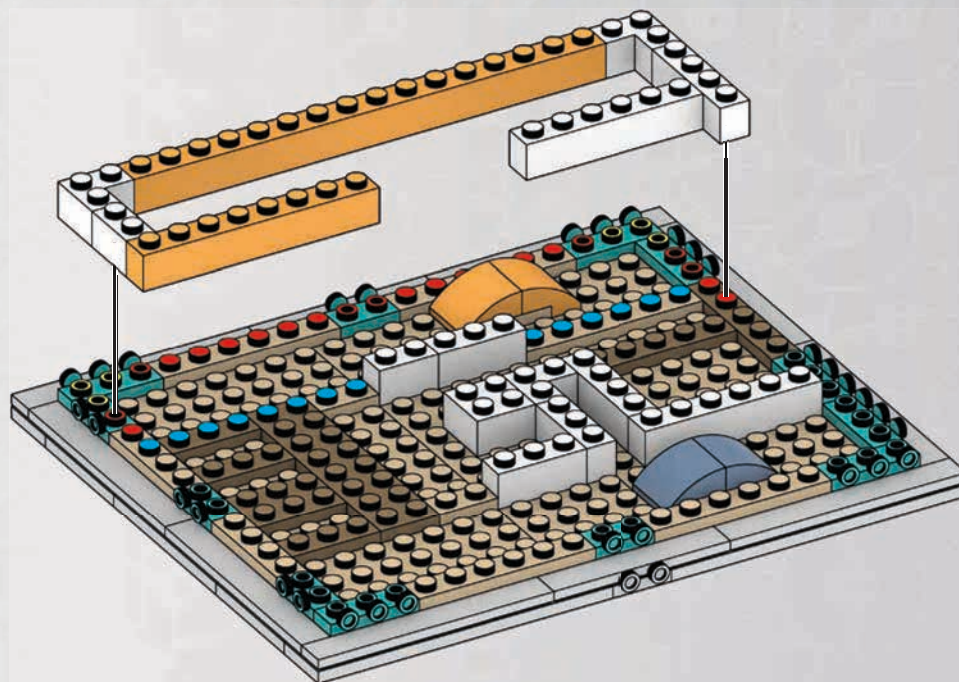
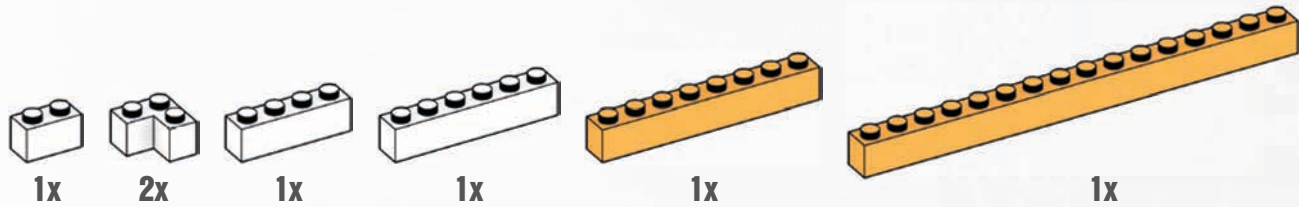

17

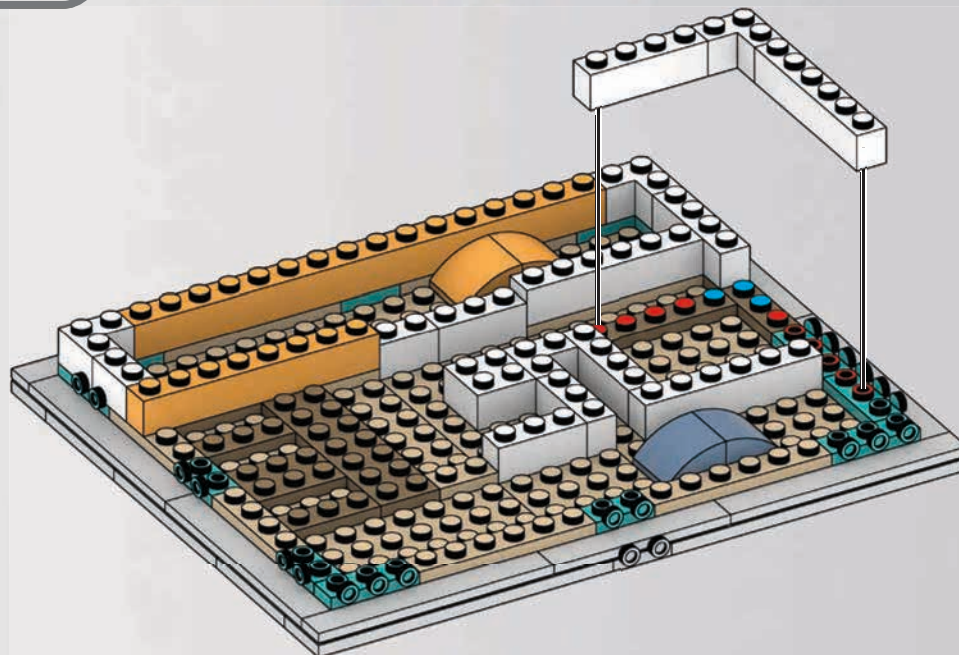
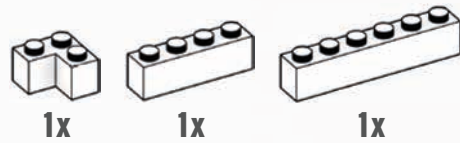

18

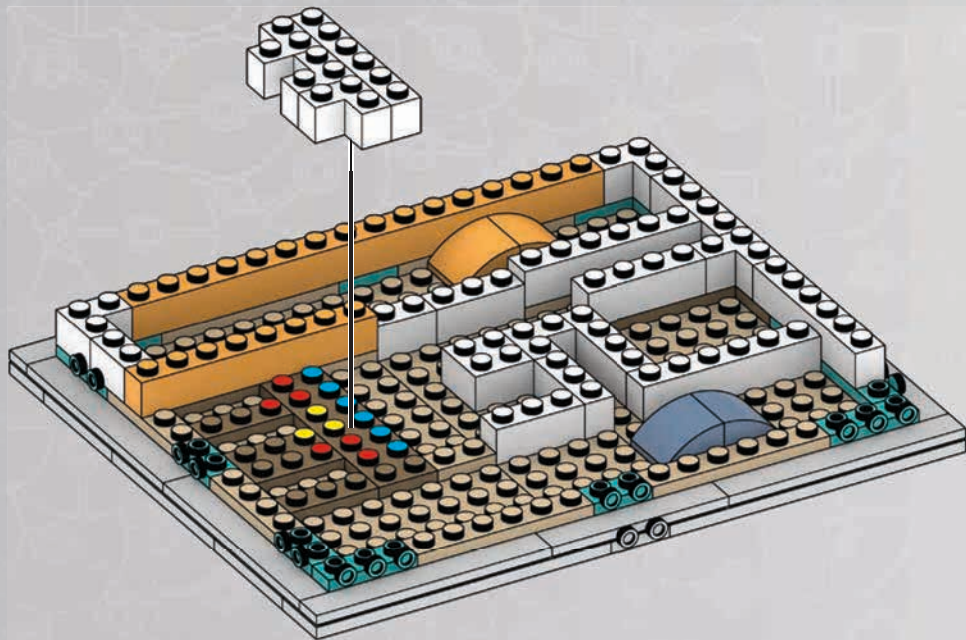
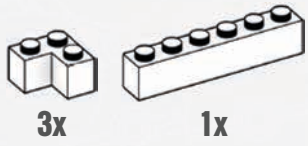

19

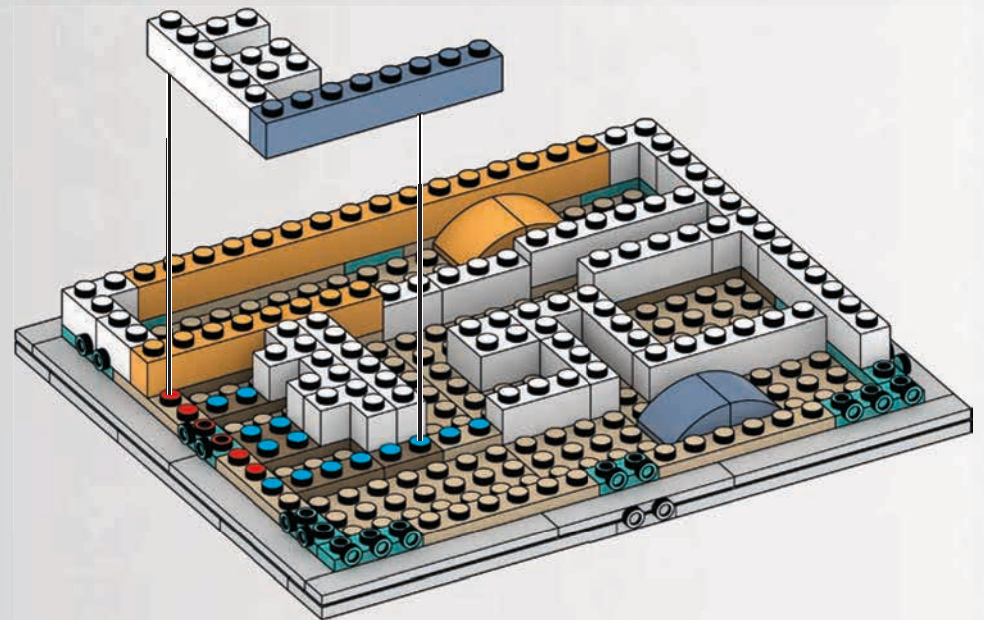
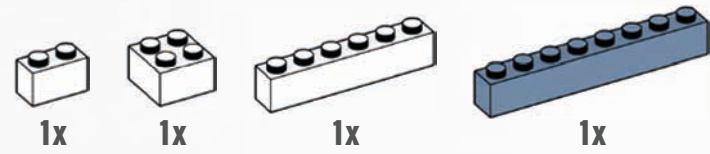

20

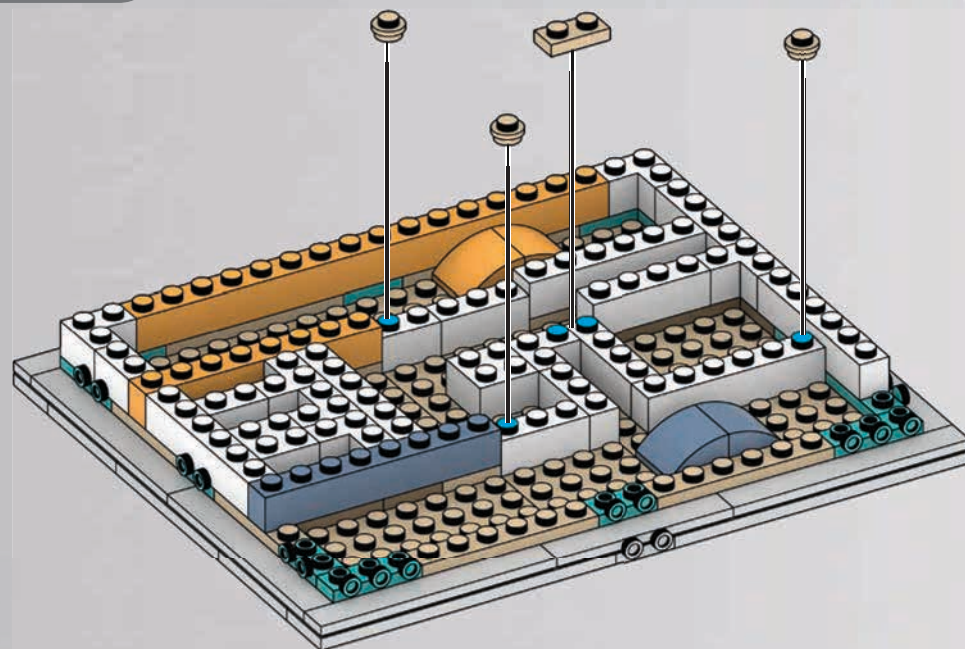
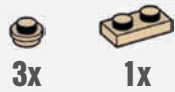

21

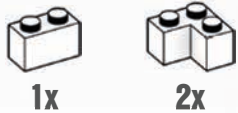

1x

2x

1x

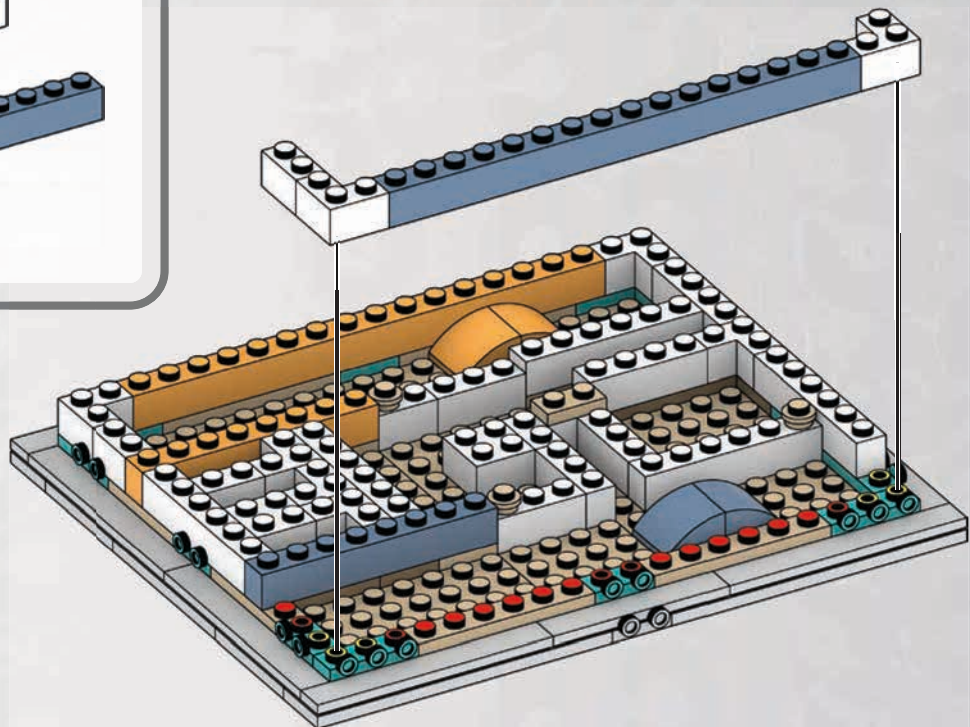

22

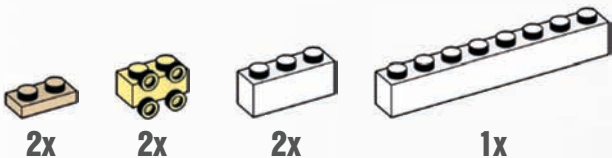

2x

2x

2x

1x

23

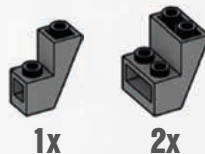

1x

2x

x2

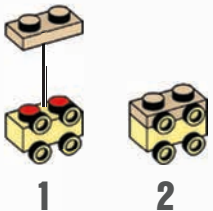

1

2

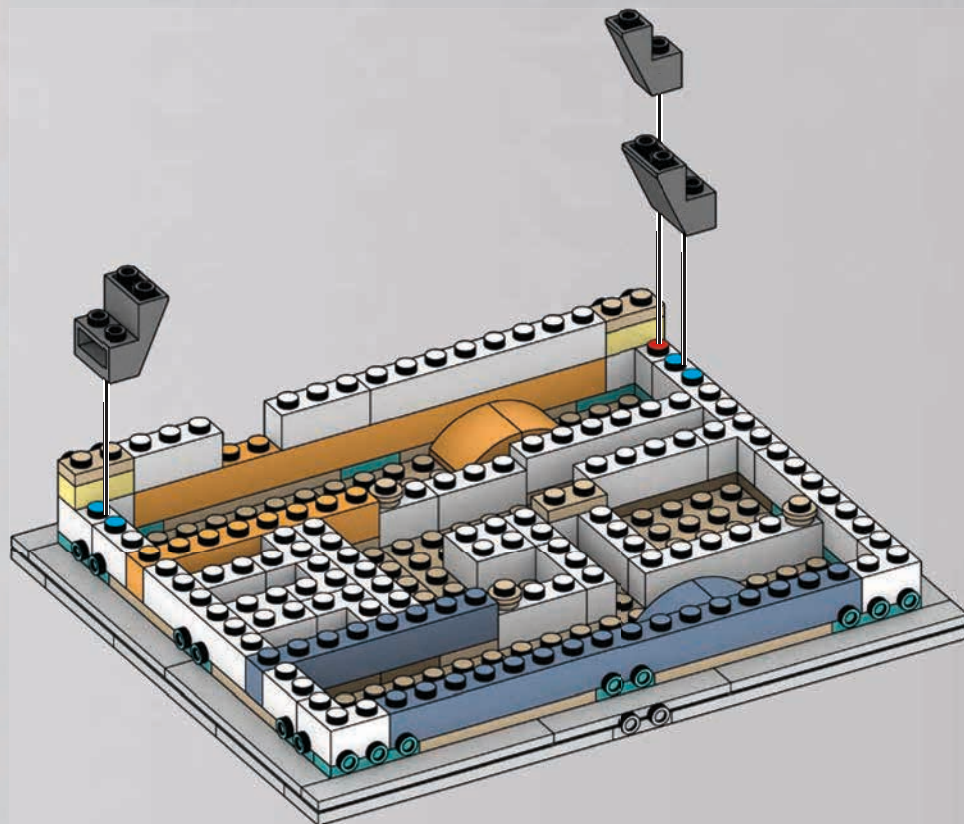
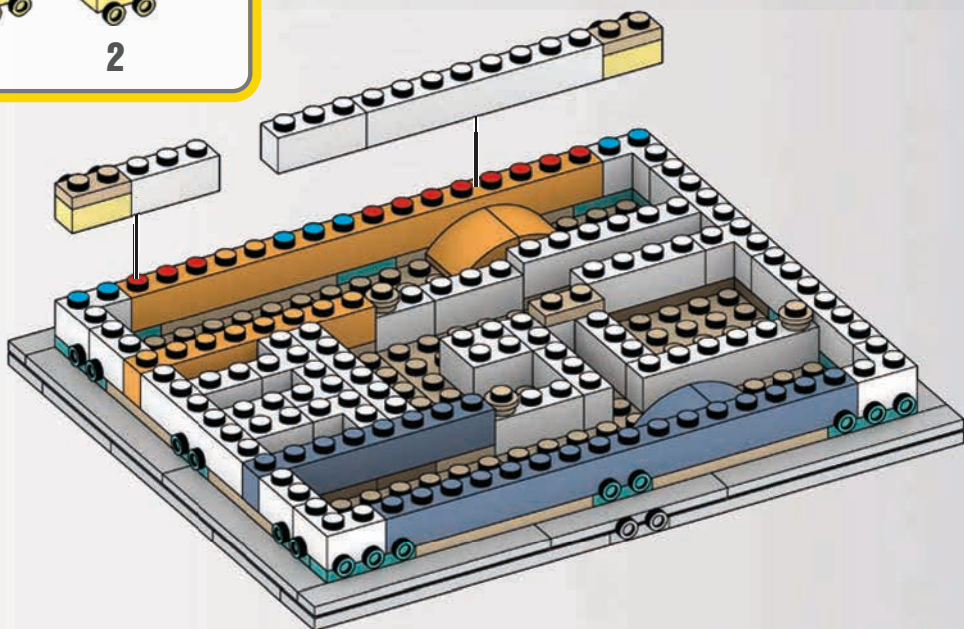

24

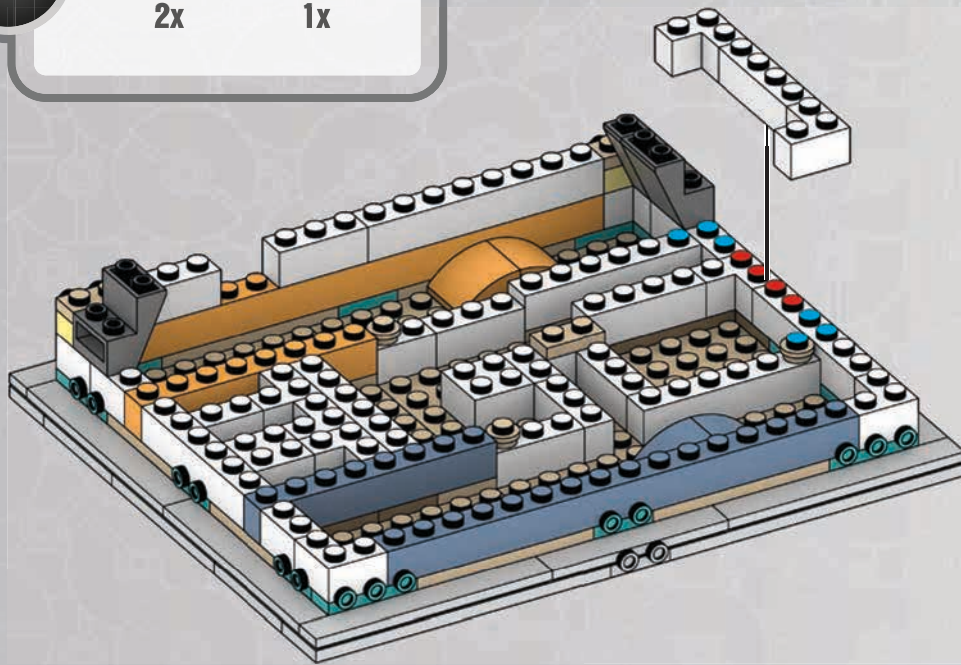
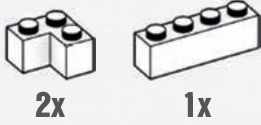

25

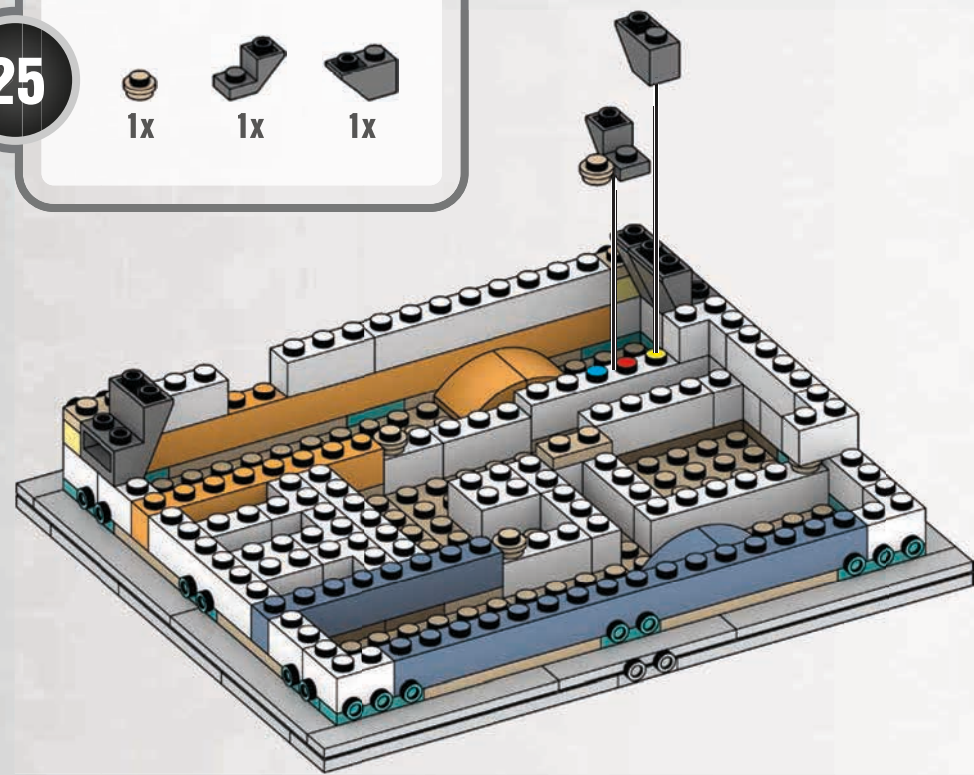

26

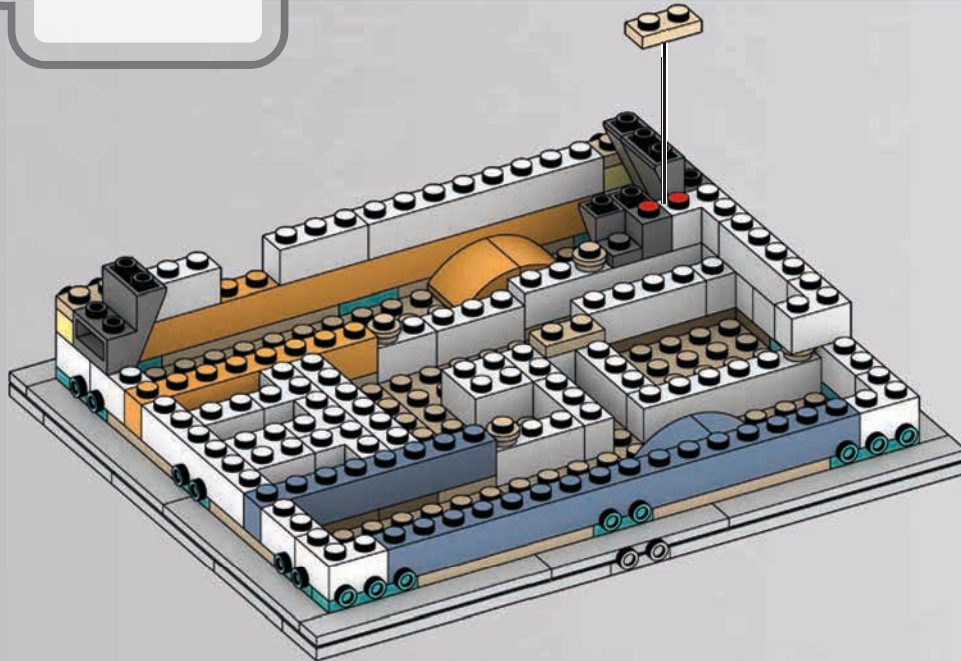

1

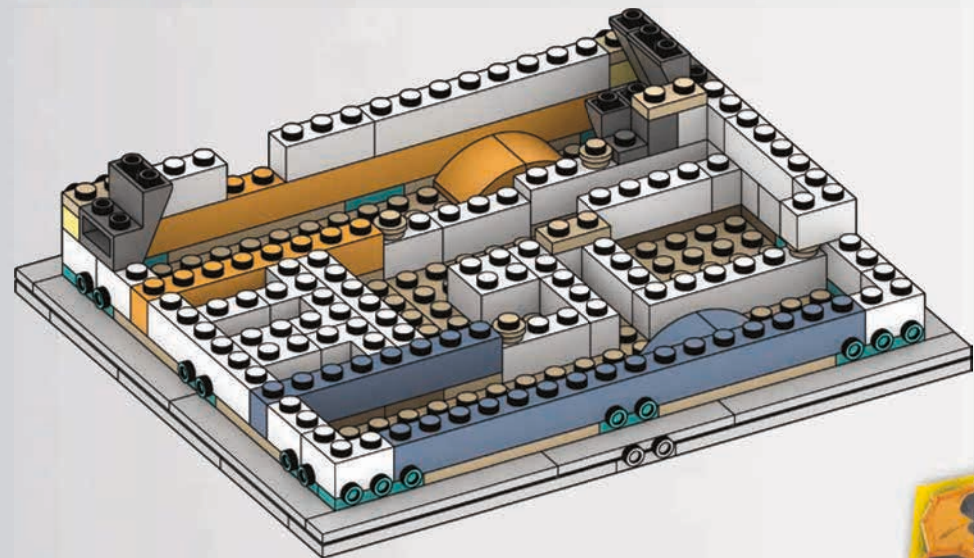

2



27

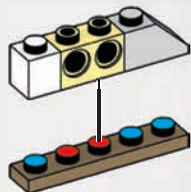

28

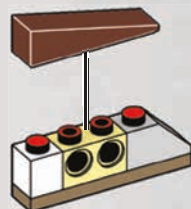

29

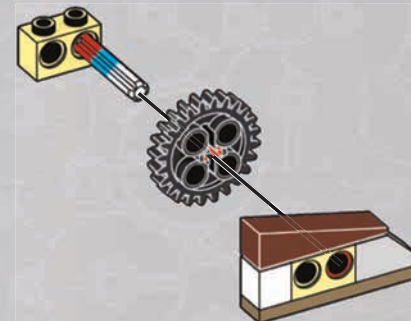
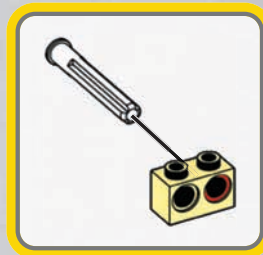
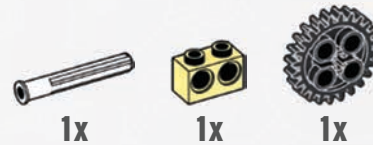

30

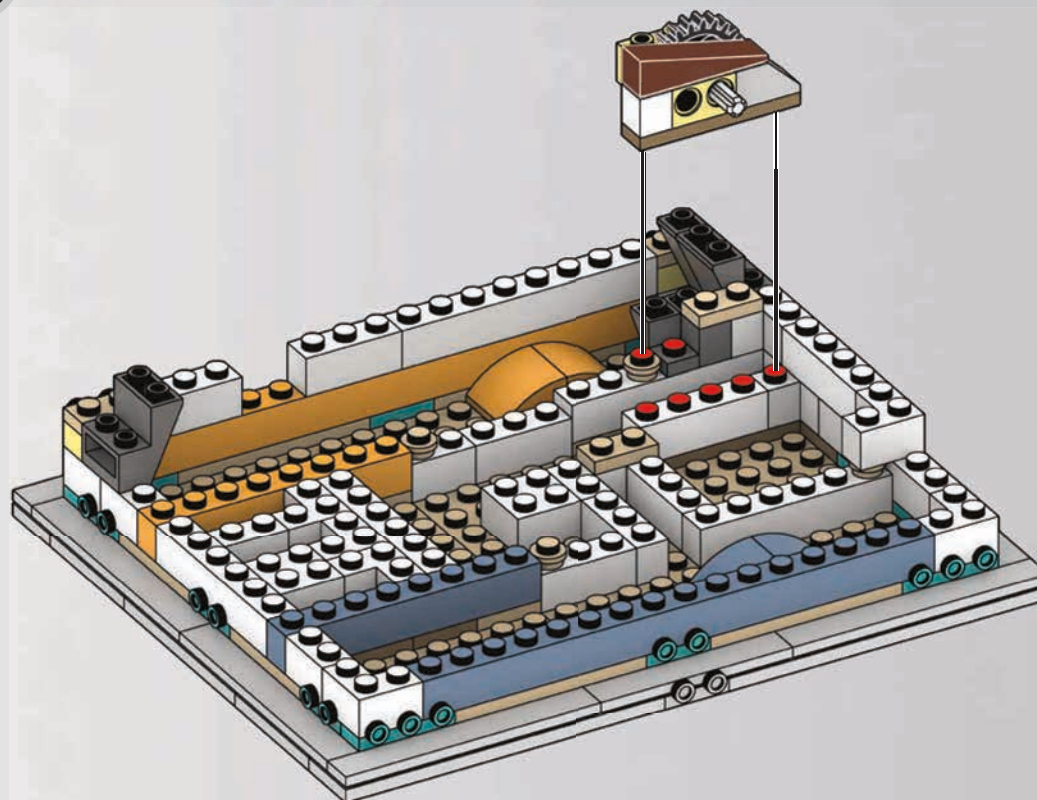



31

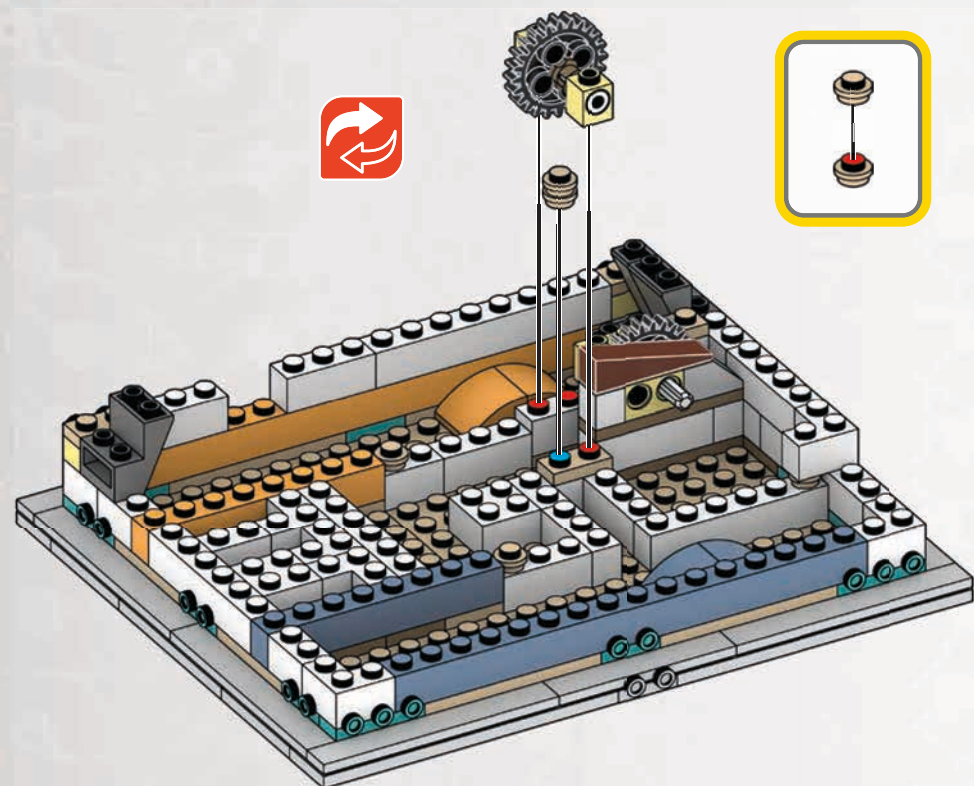
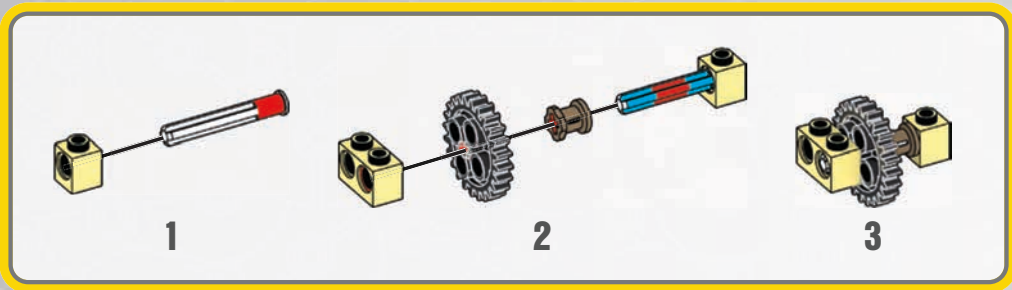
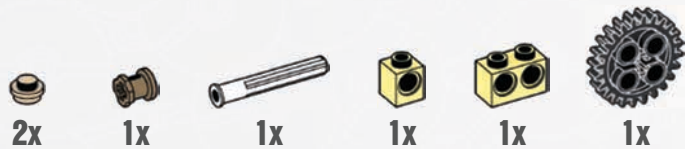

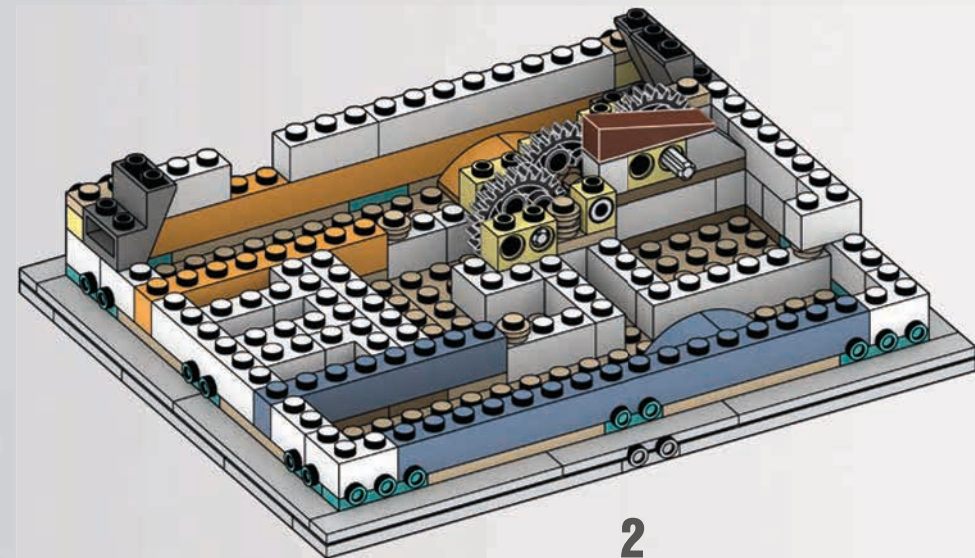
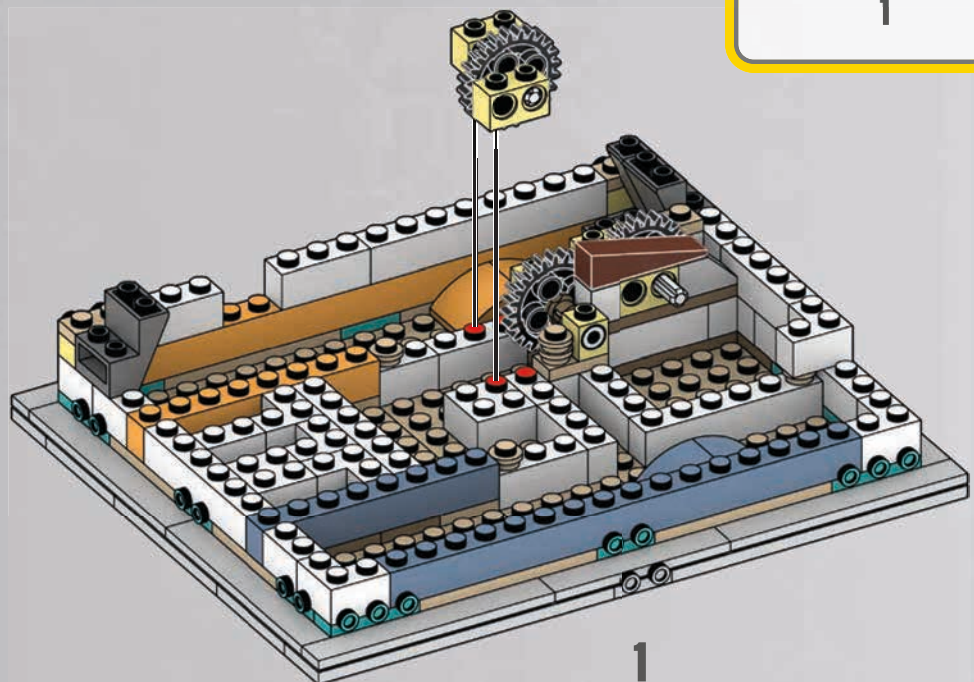
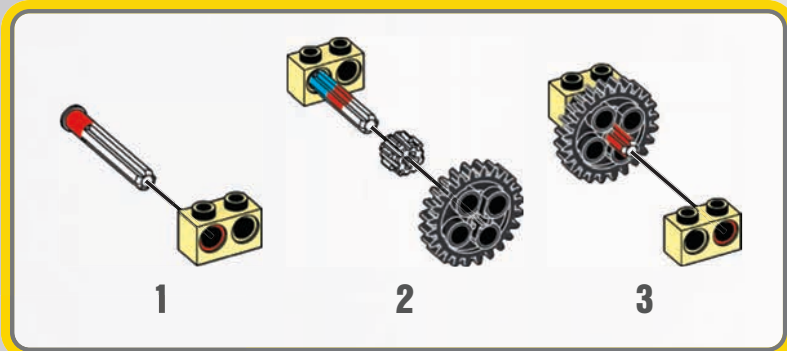
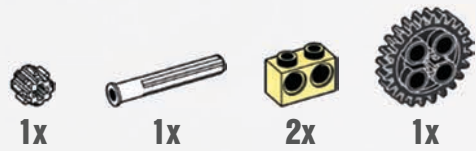

32







**33**

1x  1x 



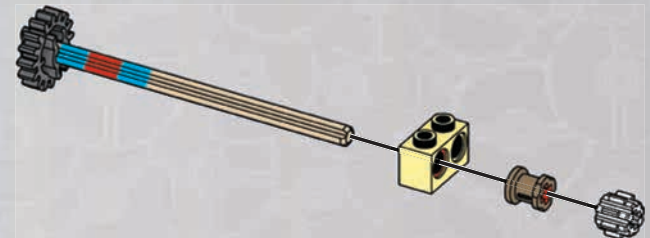

**34**

1x  1x  1x 



**35**

1x  1x  2x 

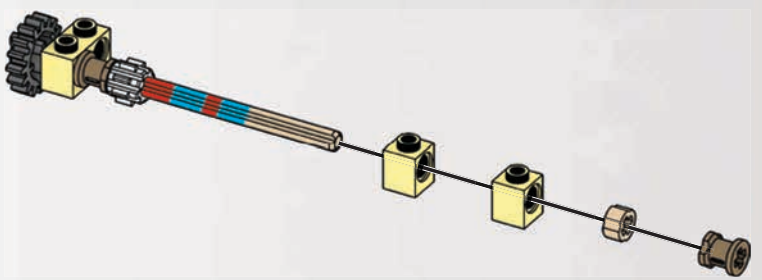

**36**

1x  1x  1x 

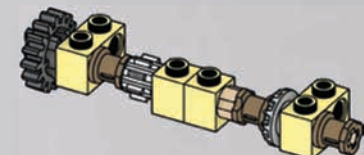
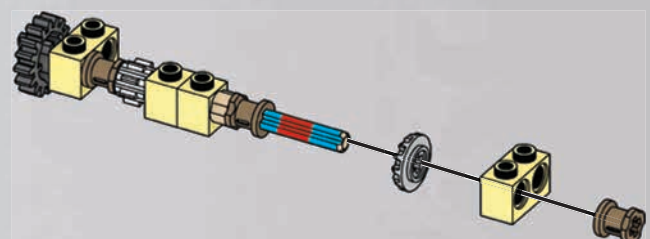

37

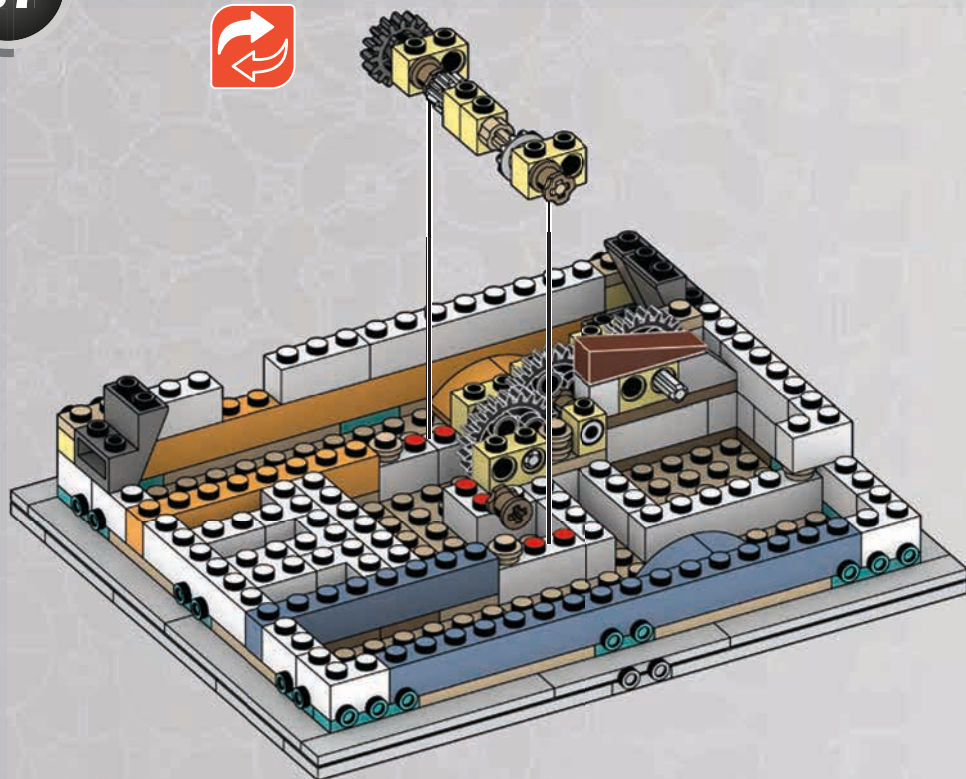

38

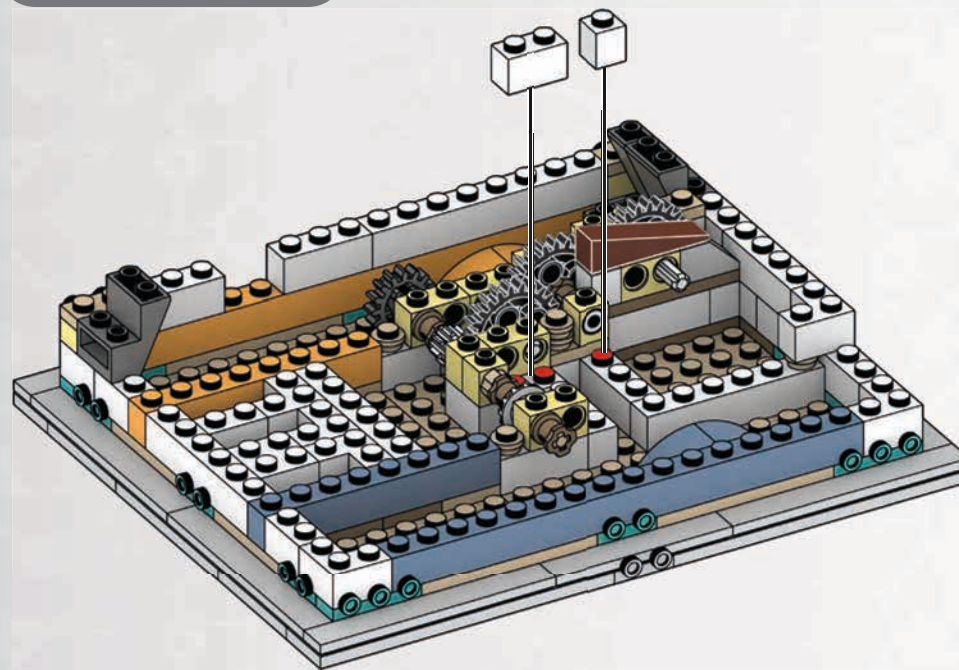
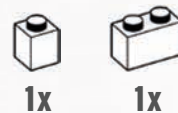

39

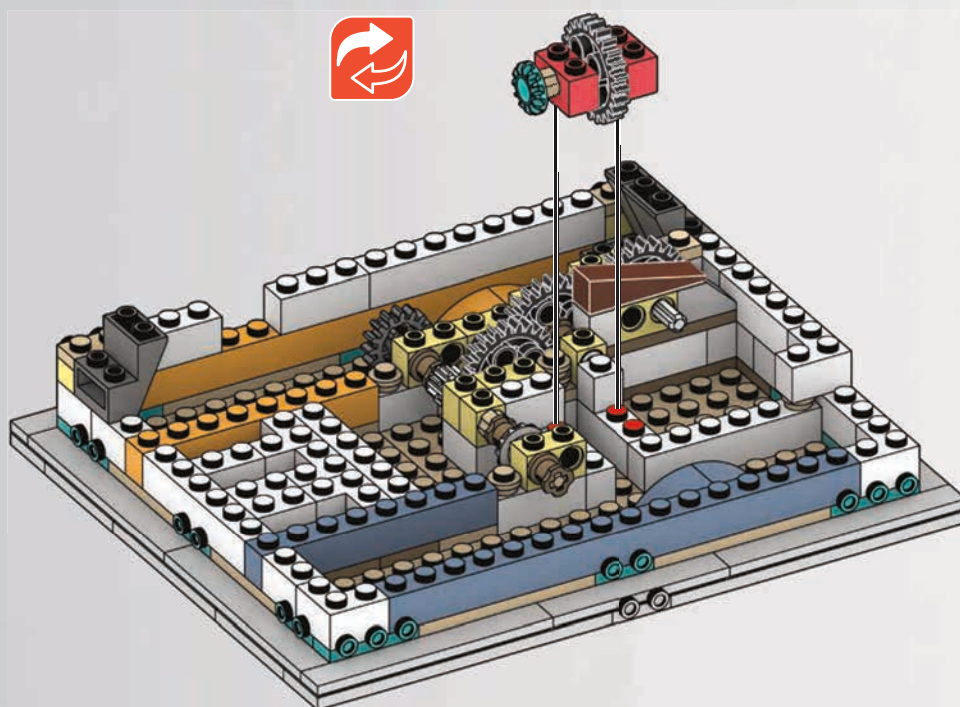
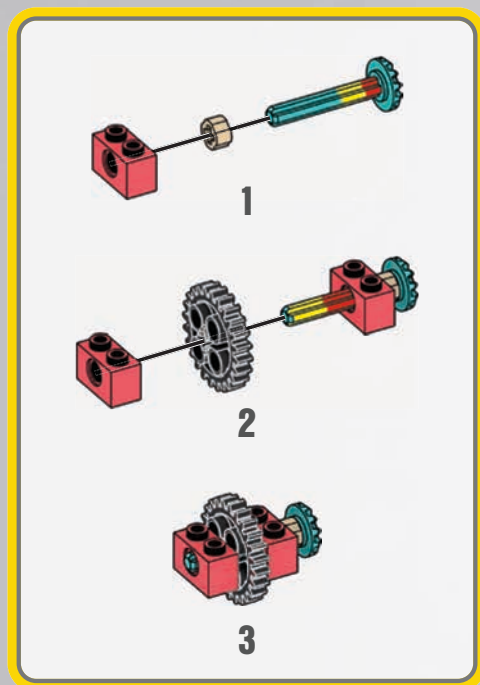
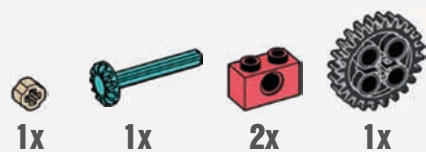

40



1x



1x



1x

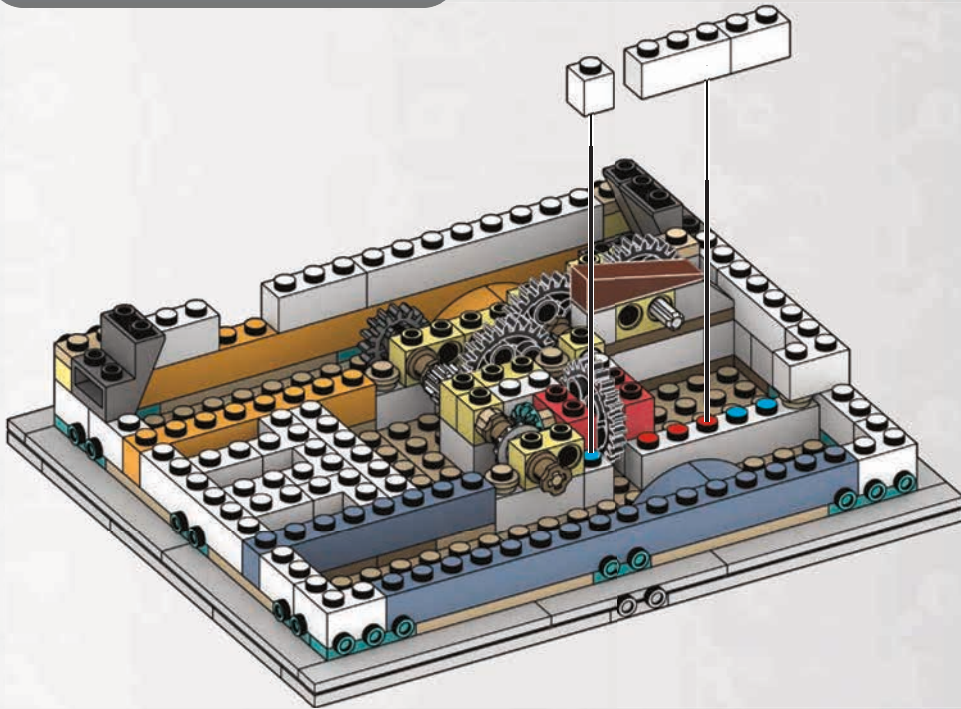

41



4x

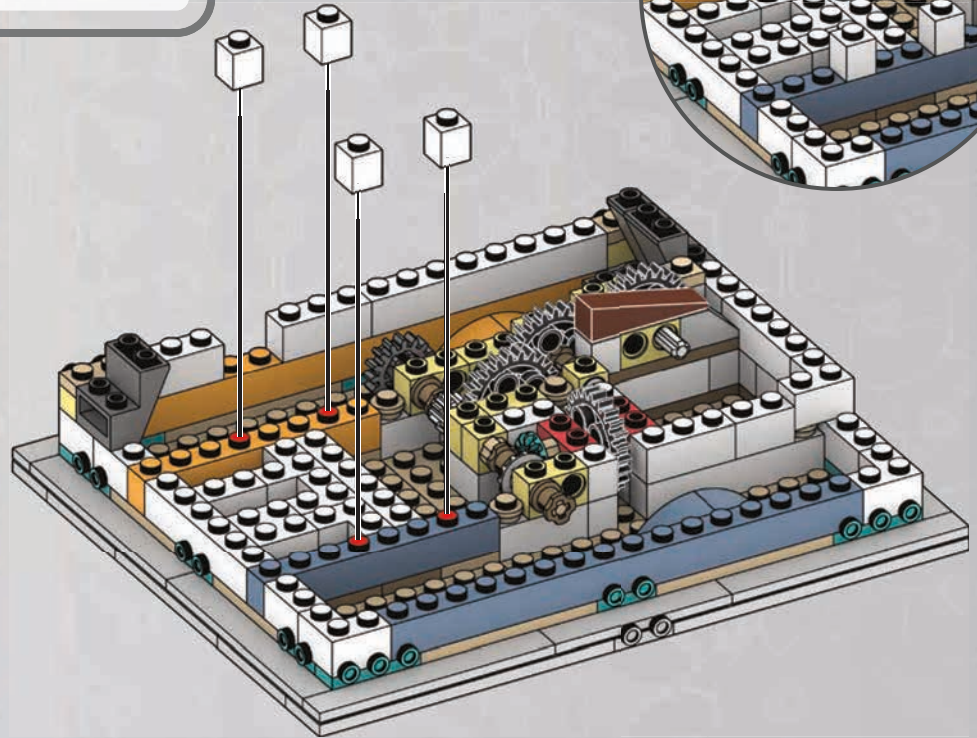

42



1x



2x

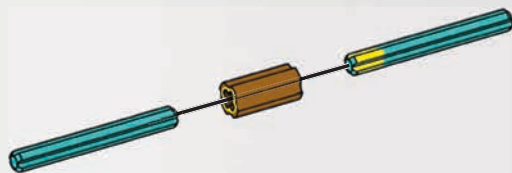

43



2x



2x

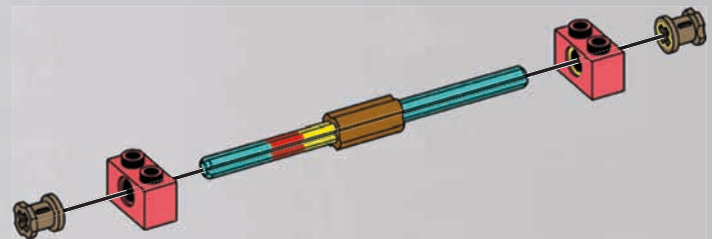

44



2x



2x

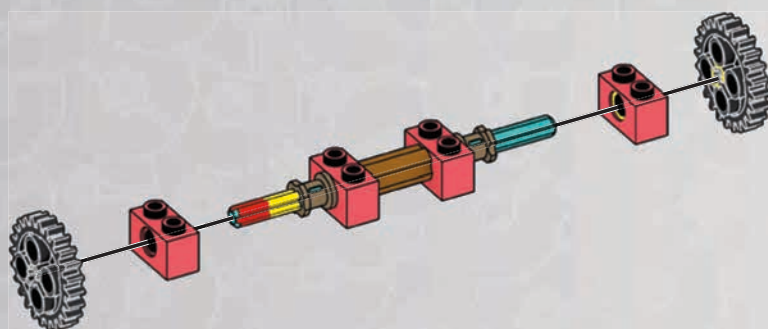

1

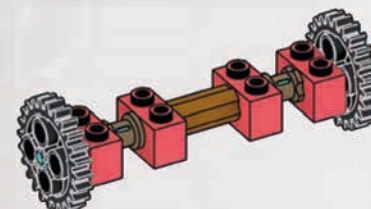

2

45

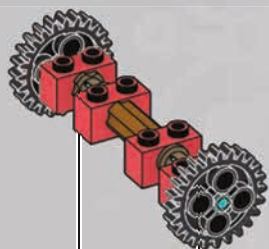

46



2x

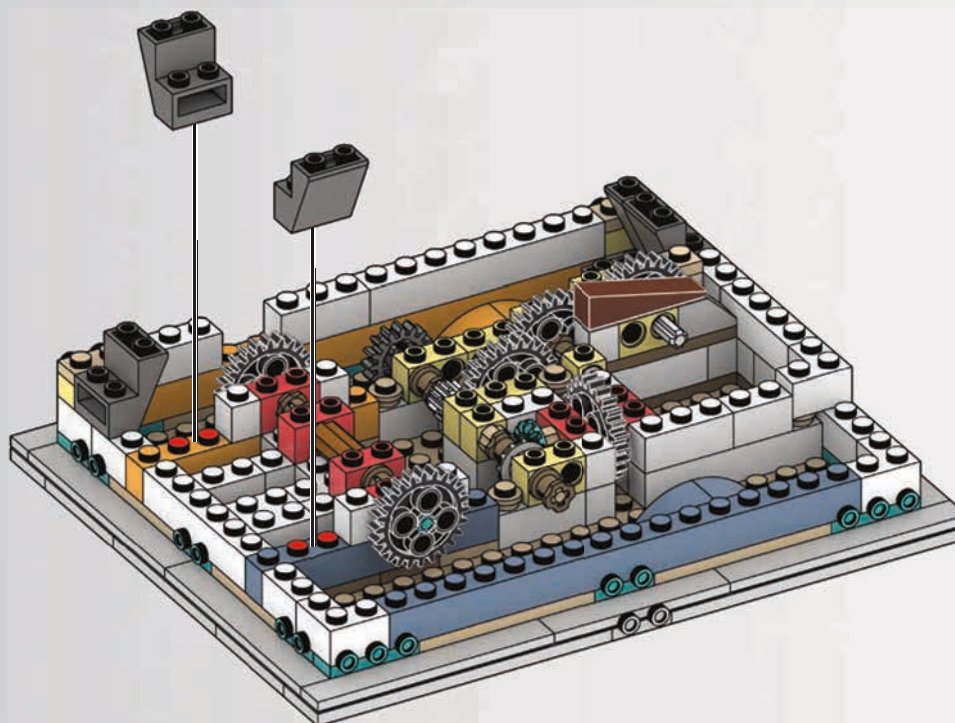

47

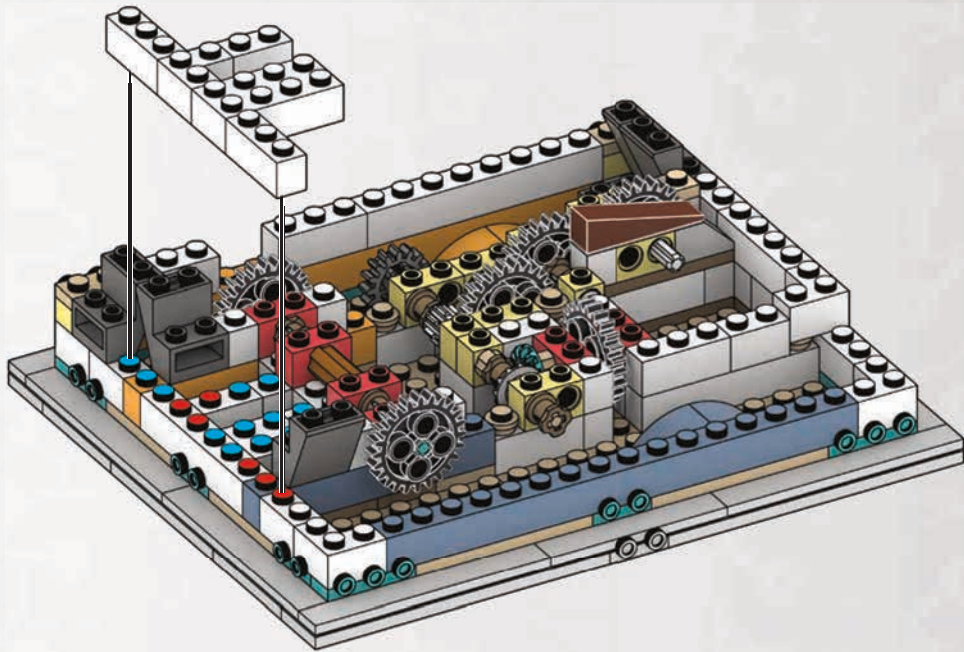
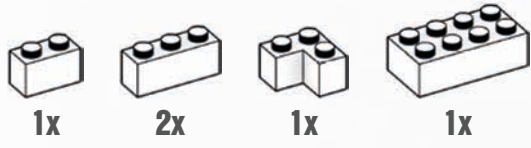

48

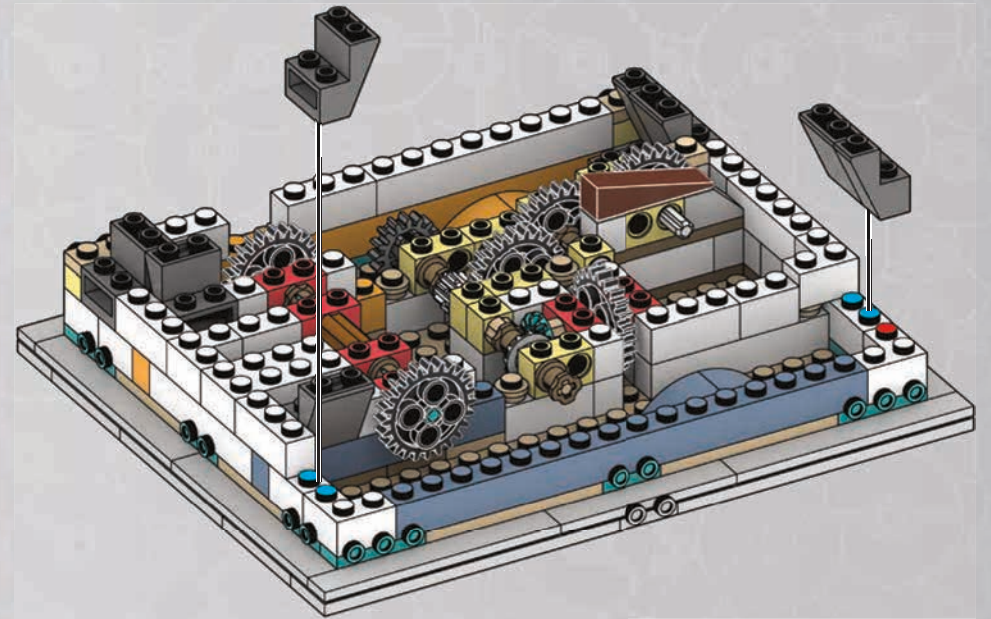
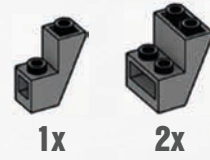

49

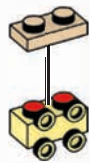
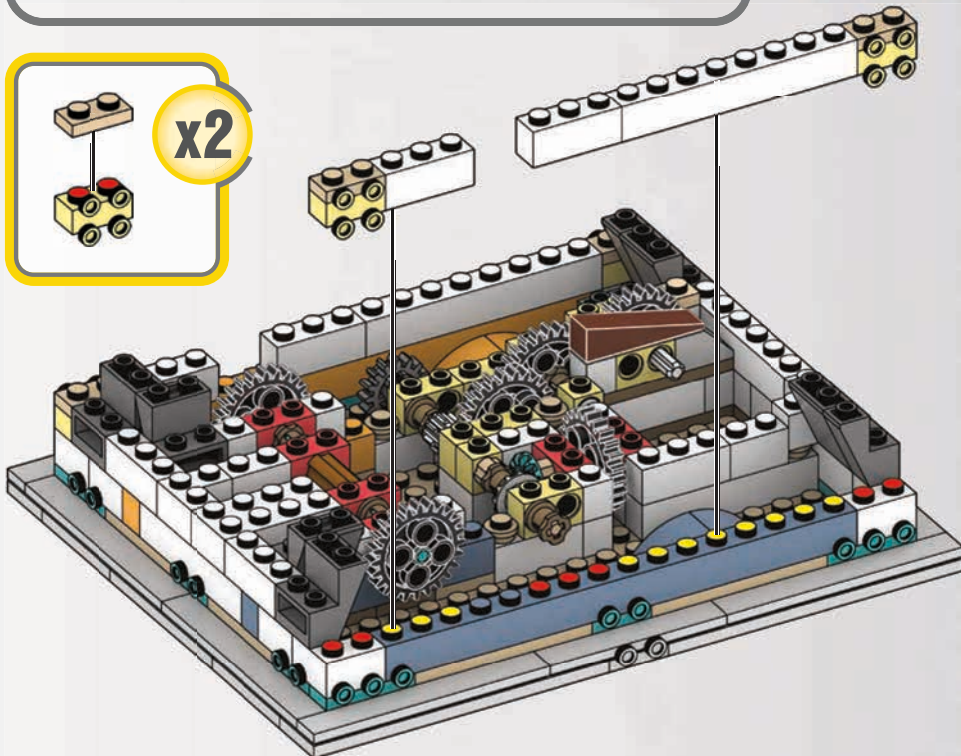
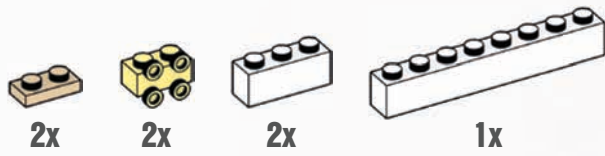

x2

50

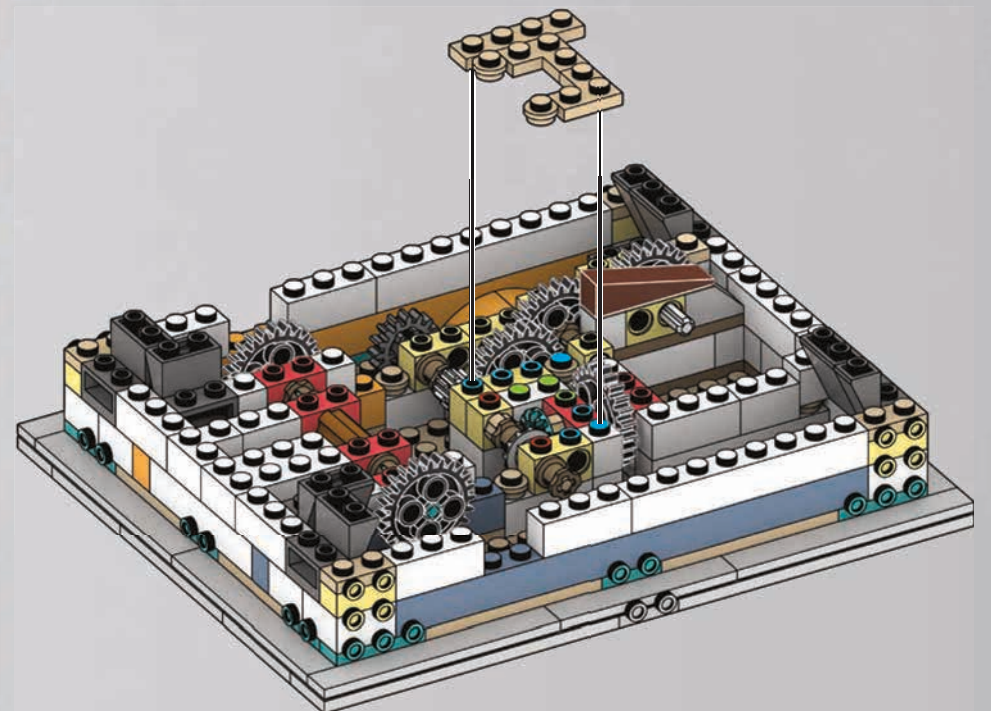
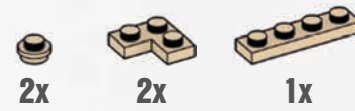

51

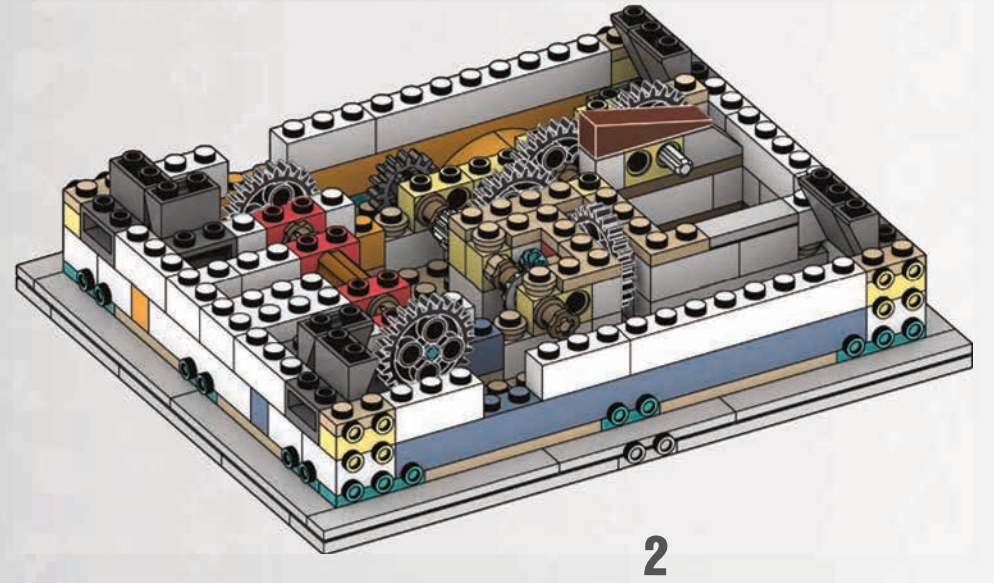
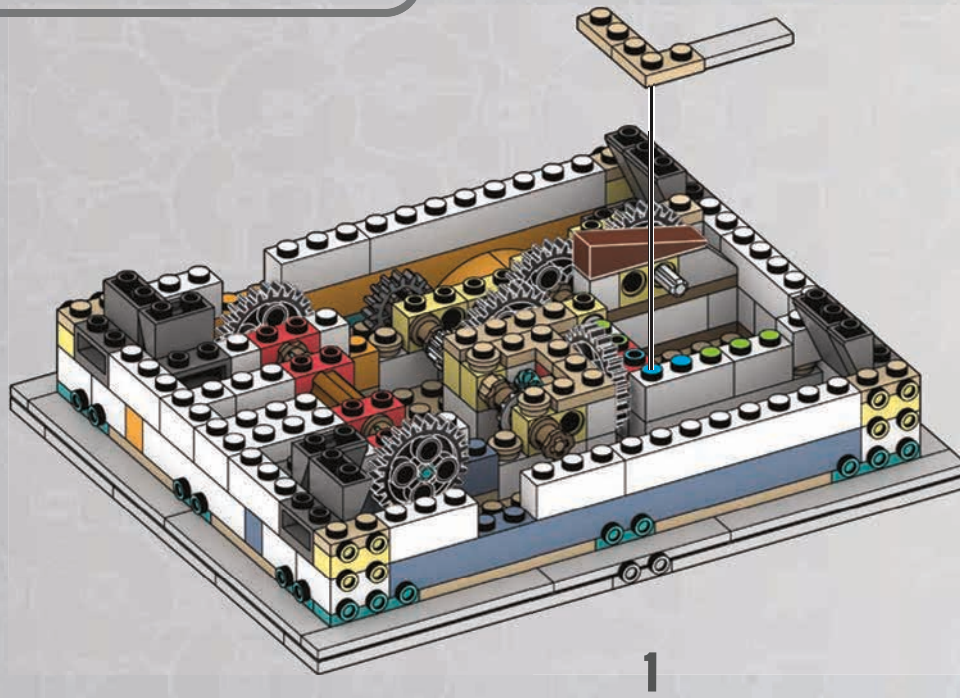

52

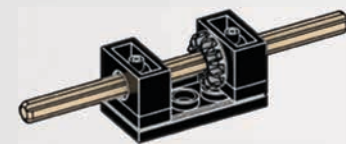
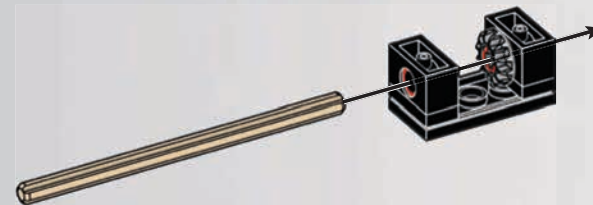
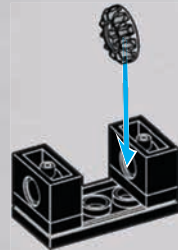
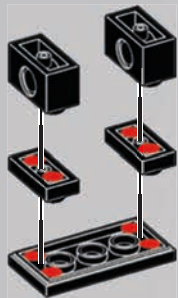

53

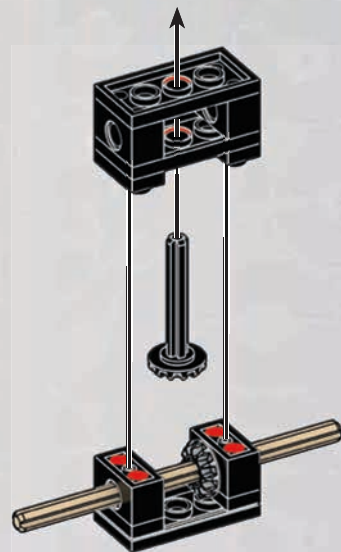
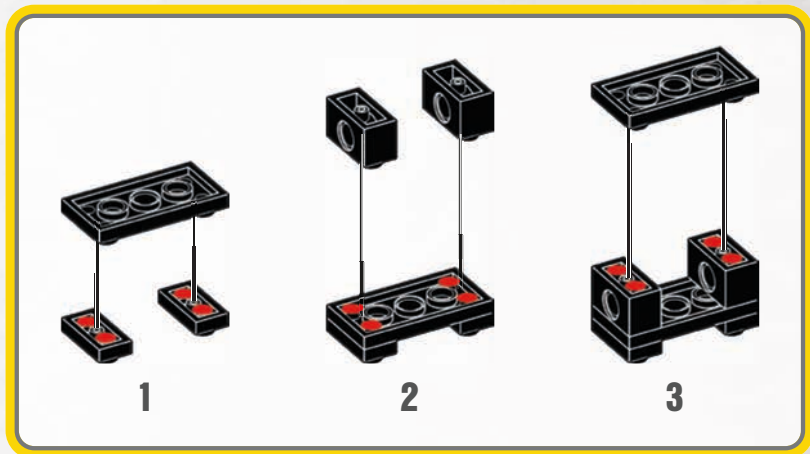

54

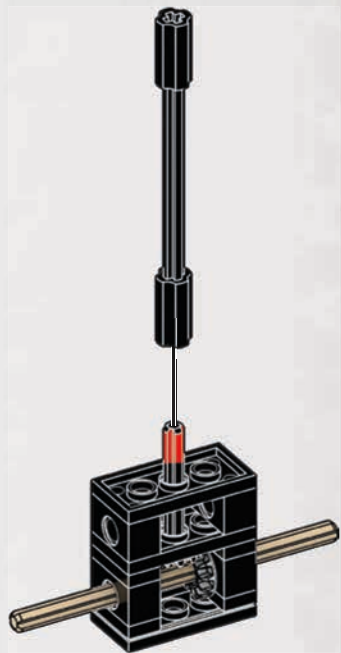

55

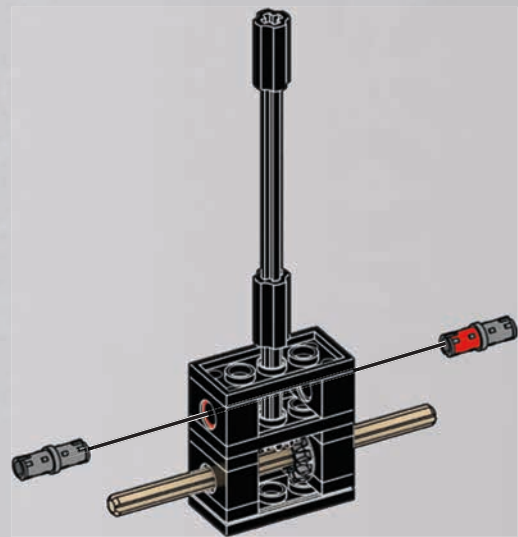



56

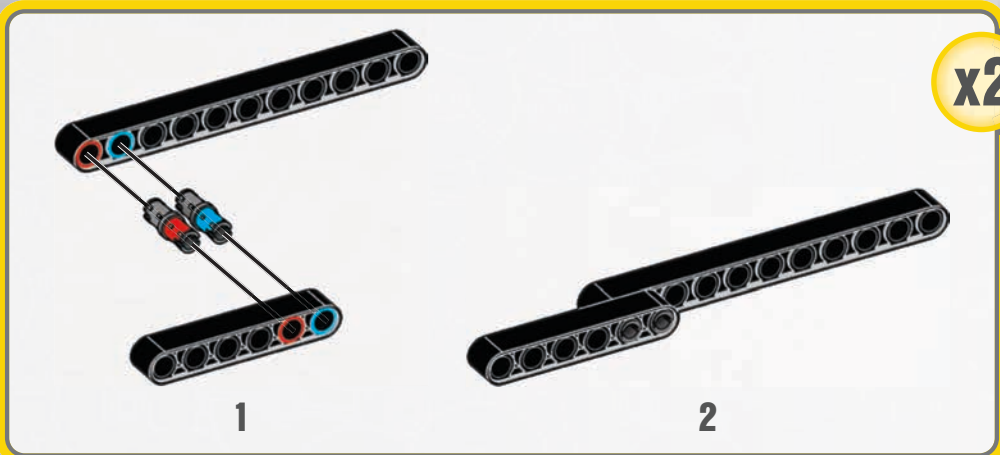

x2

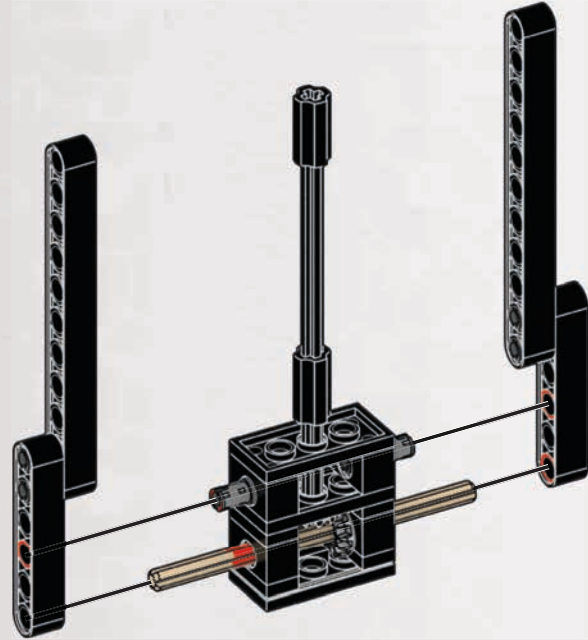

57

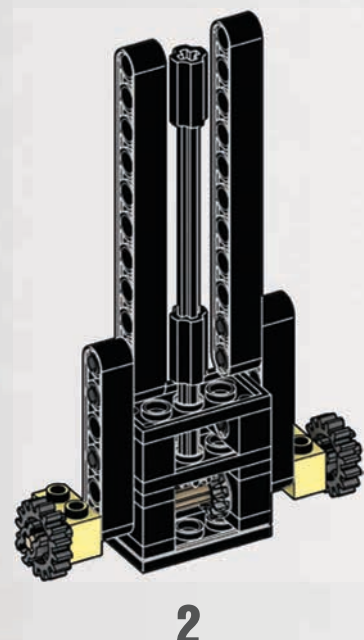
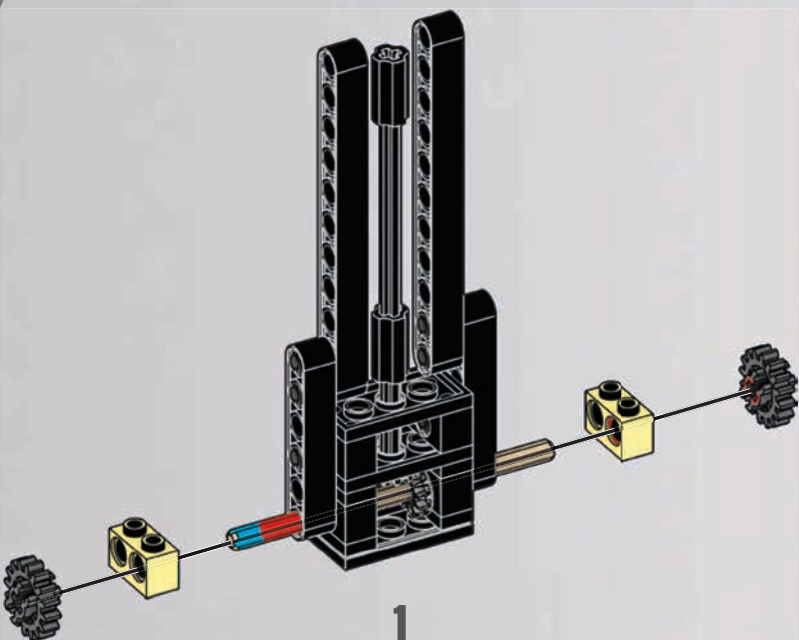

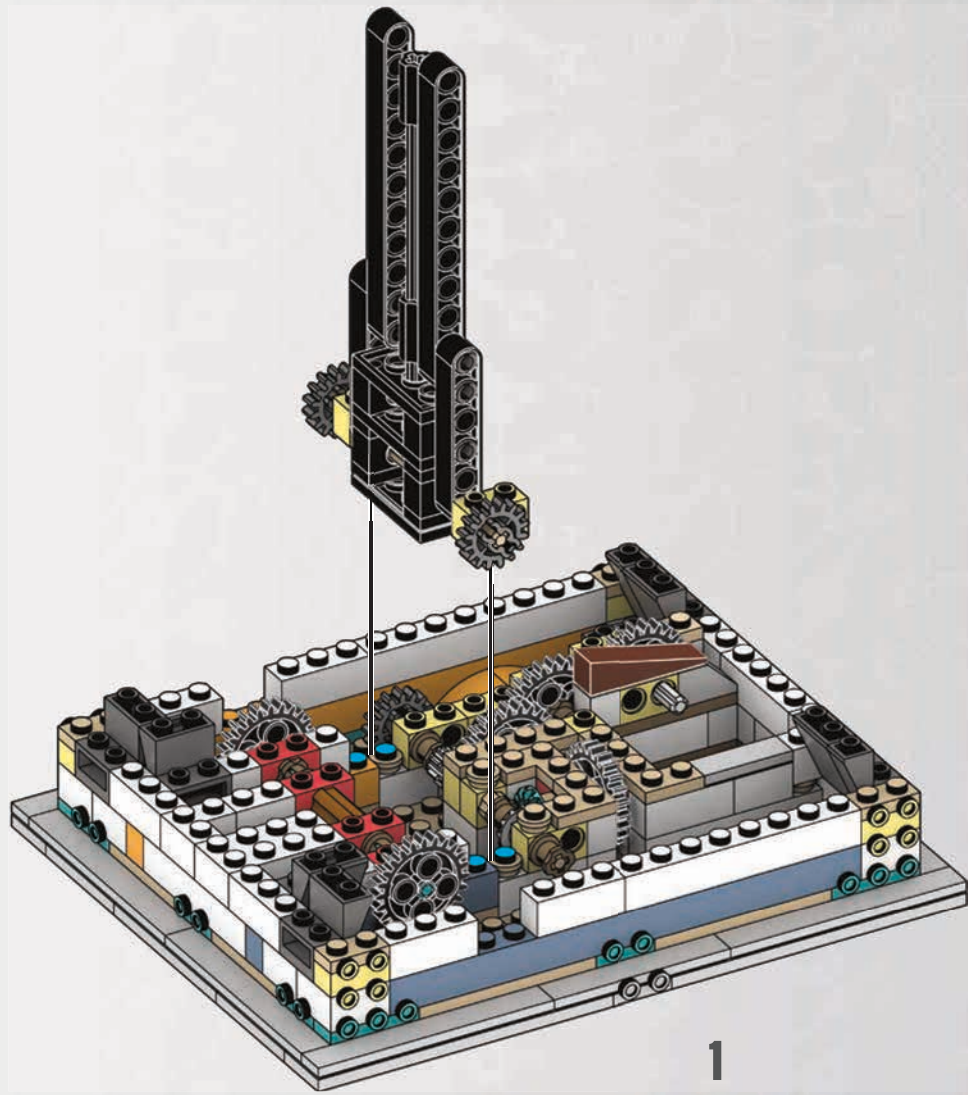

1

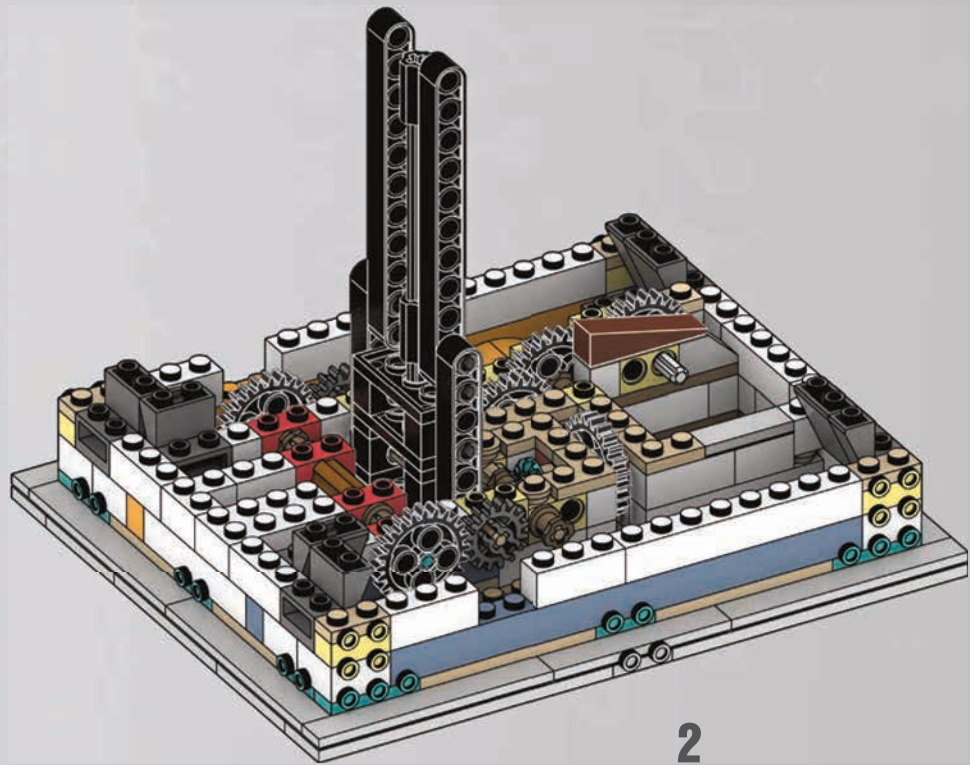

2

59

1x

1x

1x

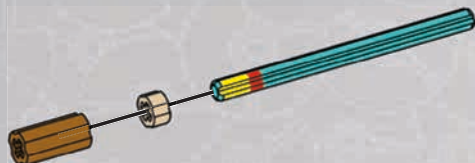

60

2x

2x

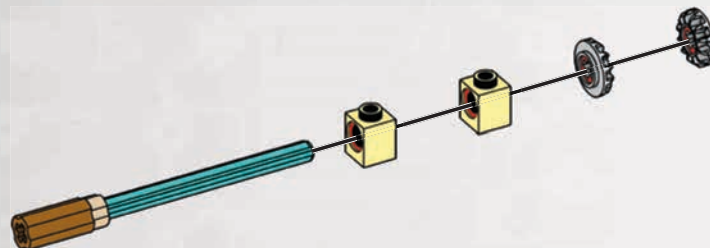

61

3x

1x

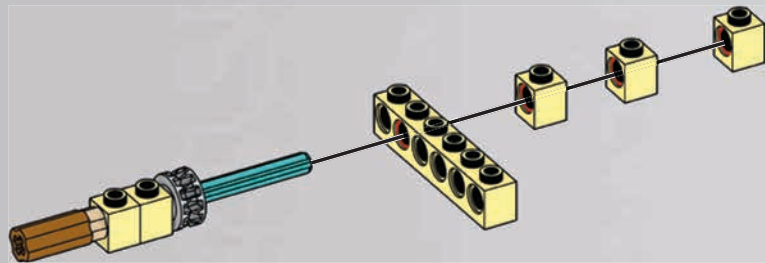

1

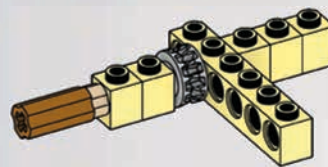

2



62

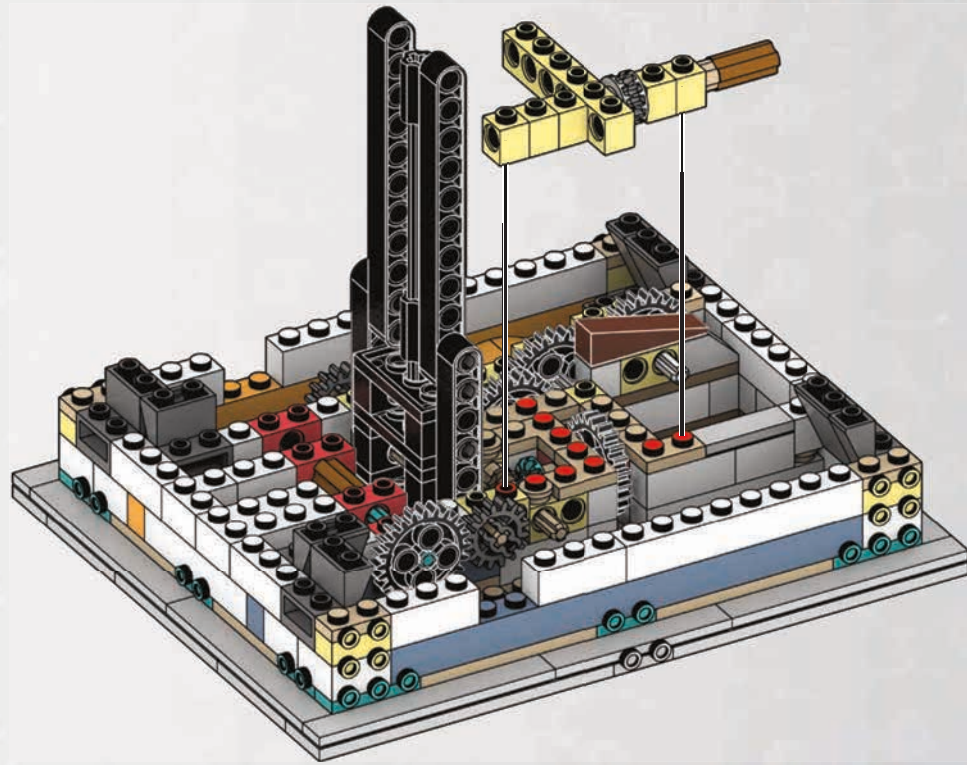

63

1x 1x 1x

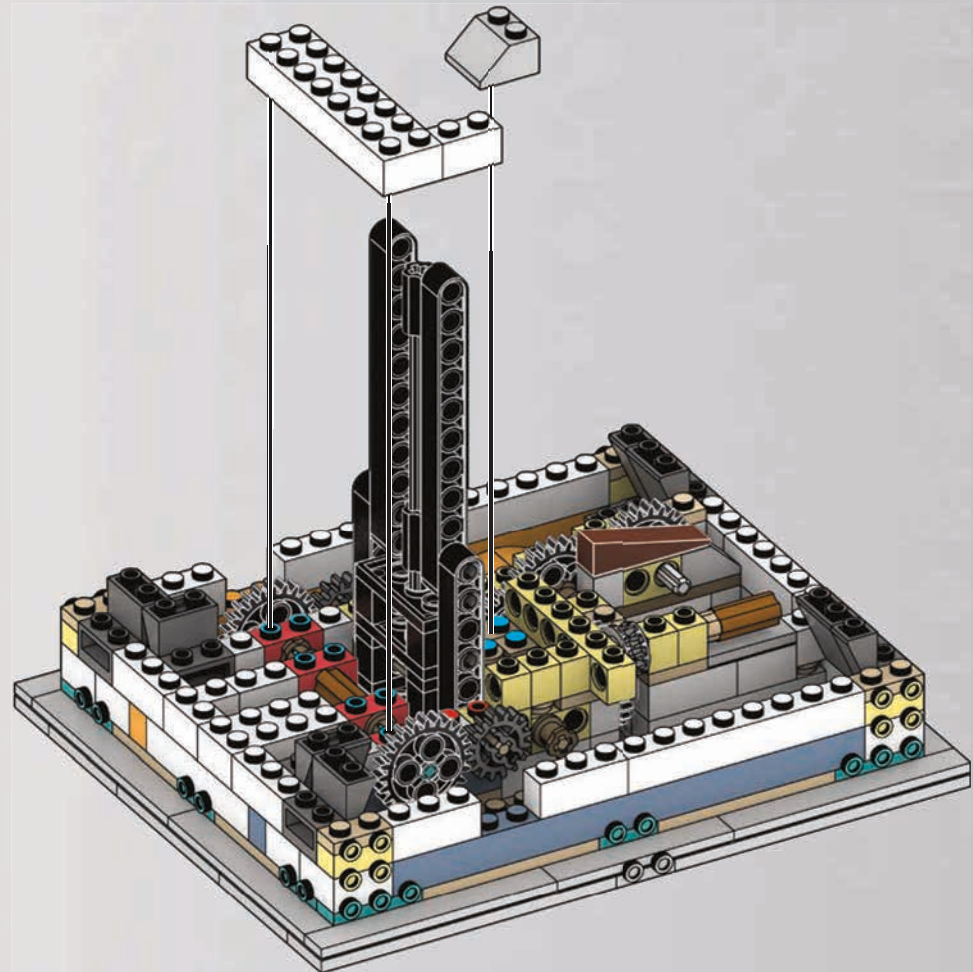
A parts list for step 63. It shows three items: a white 1x2 Technic Technic axle connector, a grey 1x2 Technic Technic axle connector, and a white 1x4 Technic Technic axle connector. Each item is accompanied by the text '1x'.



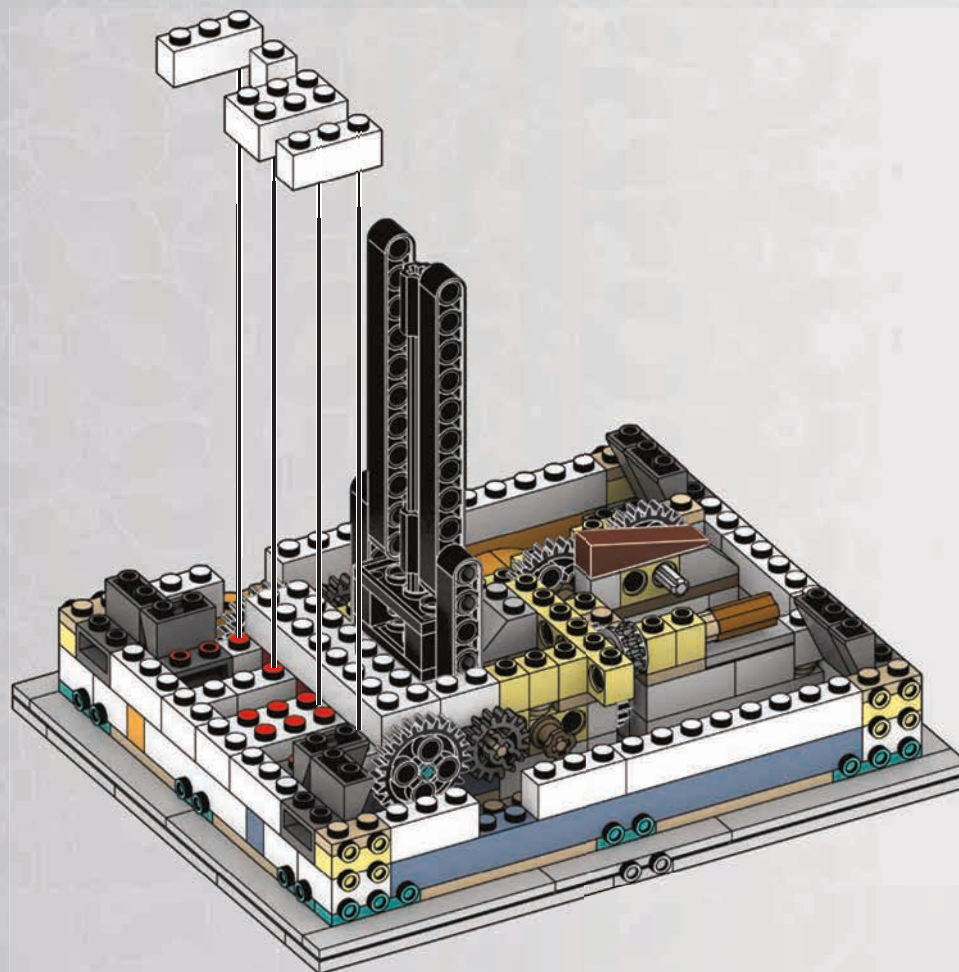
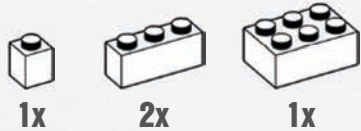

64

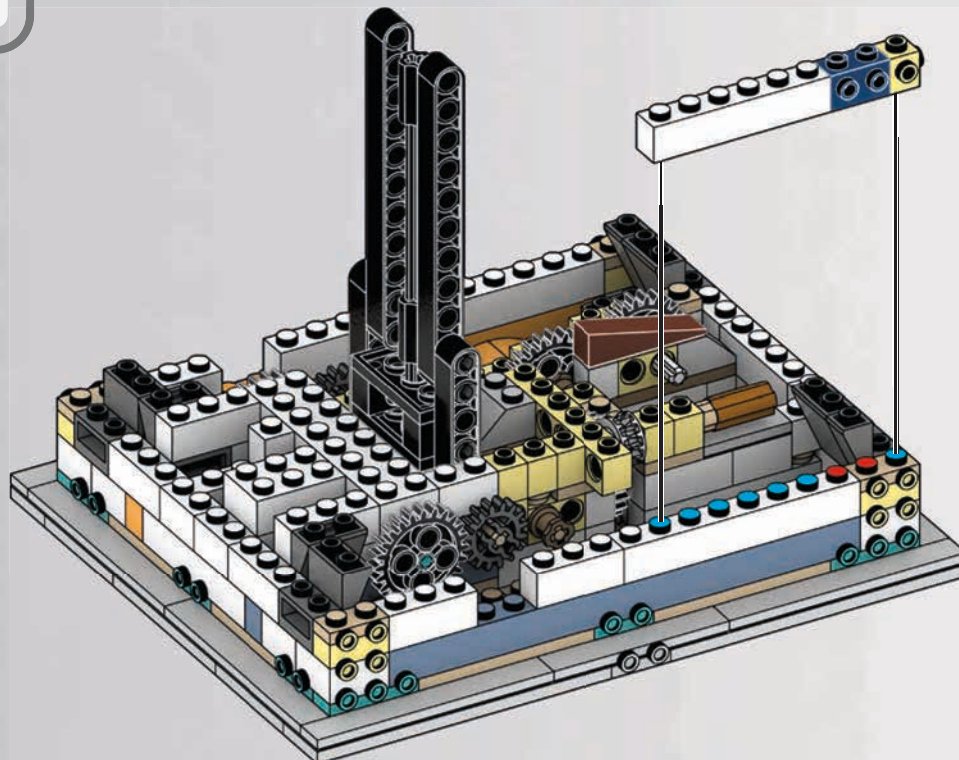
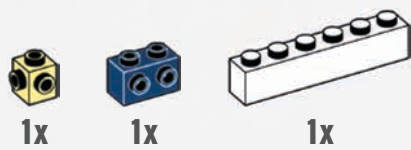

65



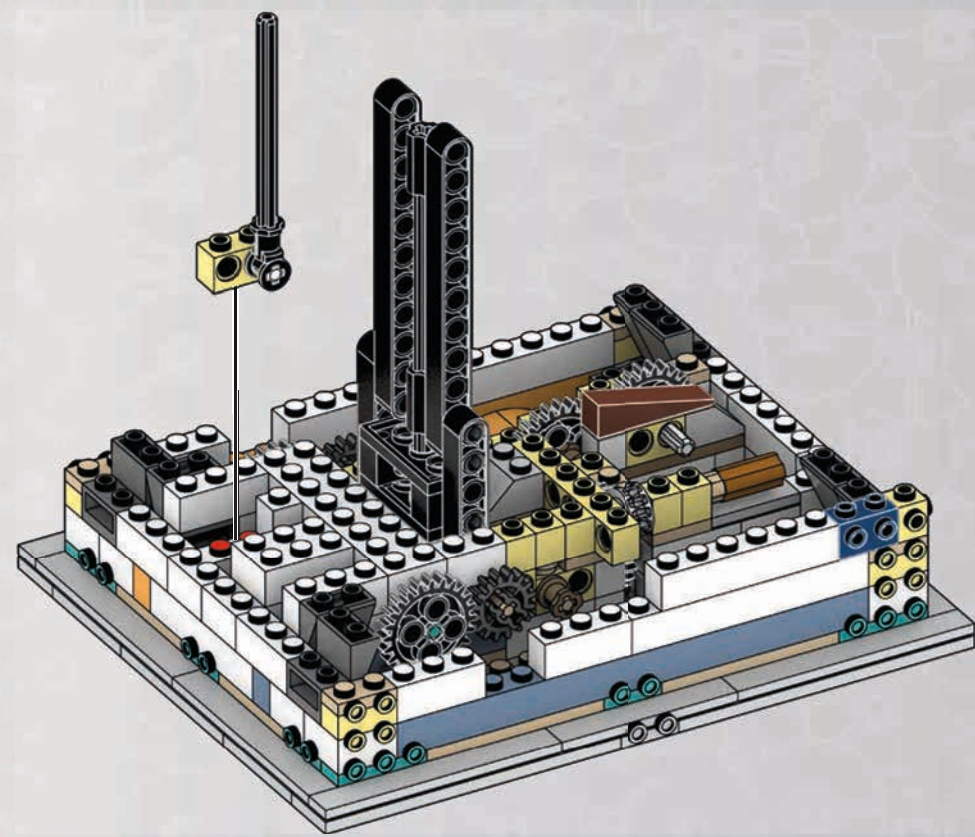
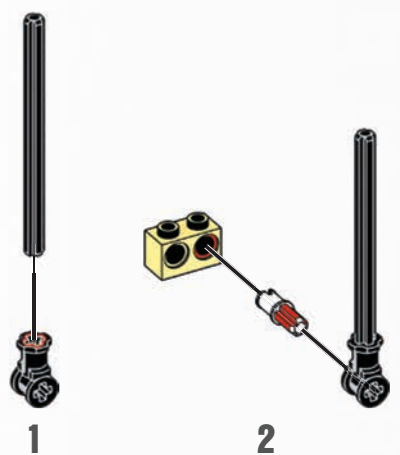

66

- 1x 
- 1x 
- 1x 
- 1x 

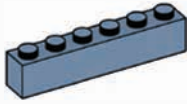

67

- 2x 
- 1x 
- 1x 
- 1x 

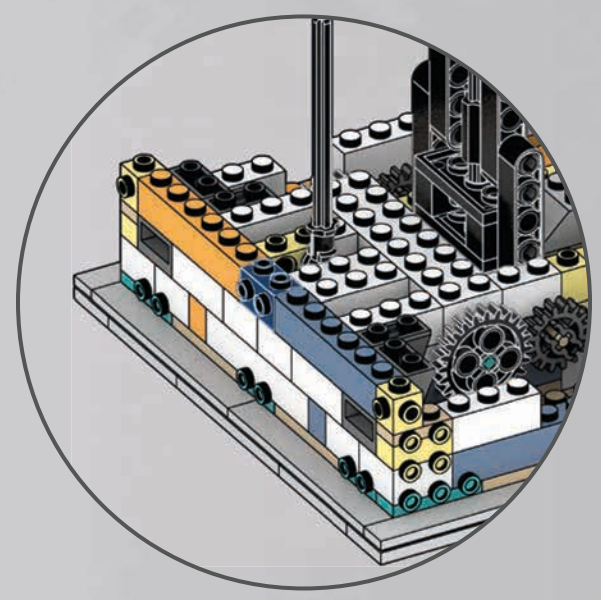
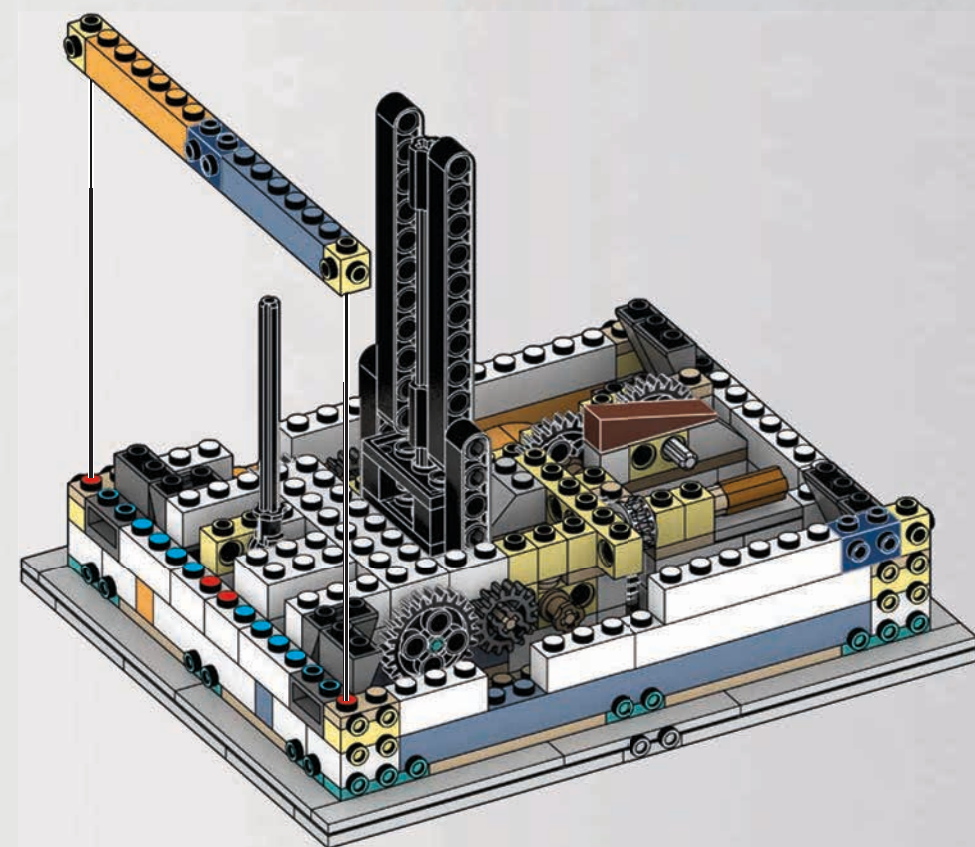

68



1x

1x

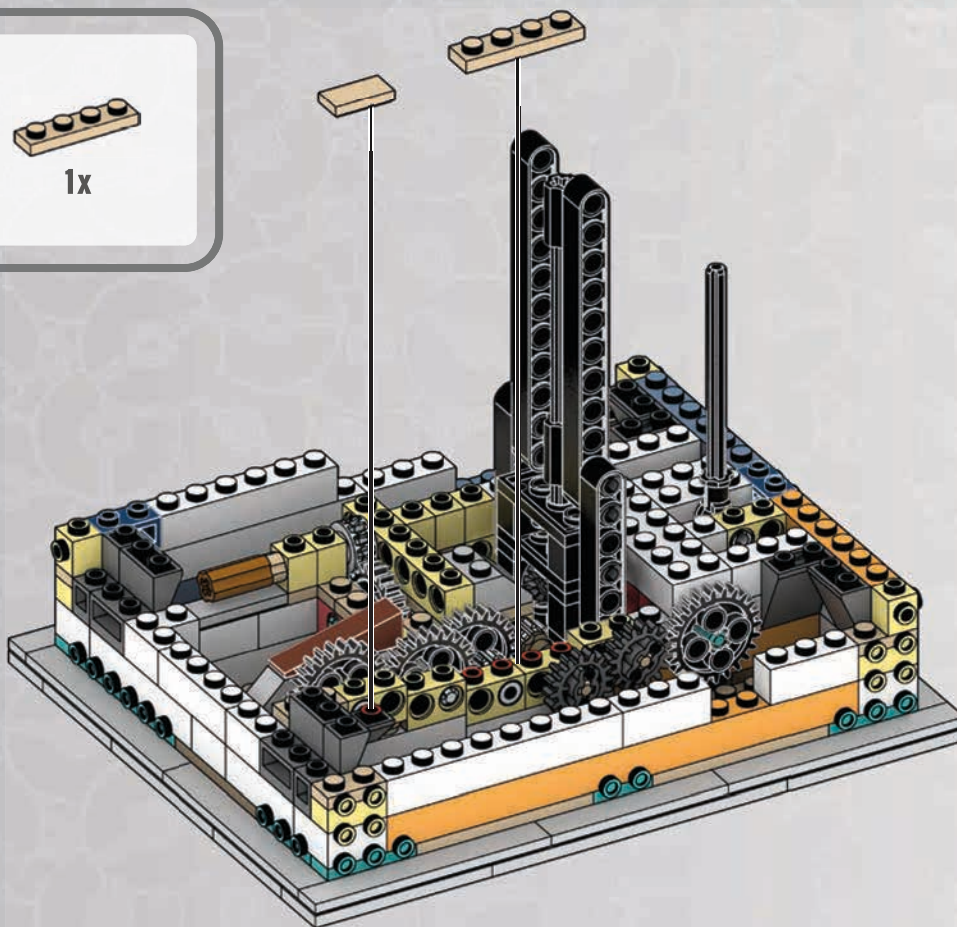

69

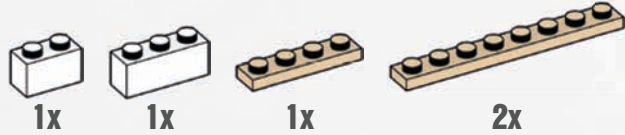

1x

1x

1x

2x

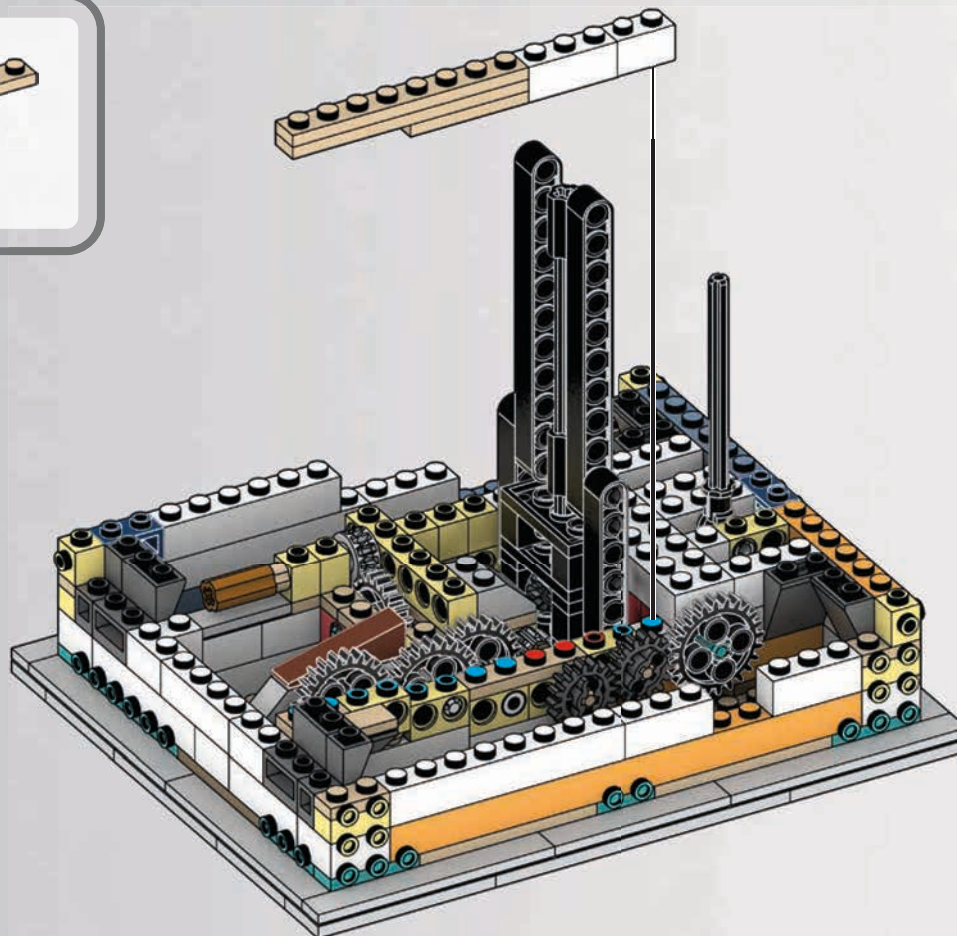
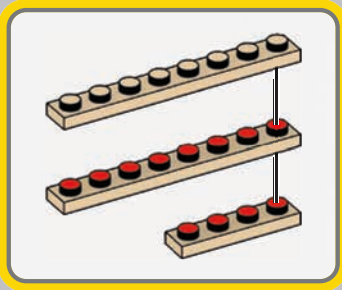

70



1x



1x

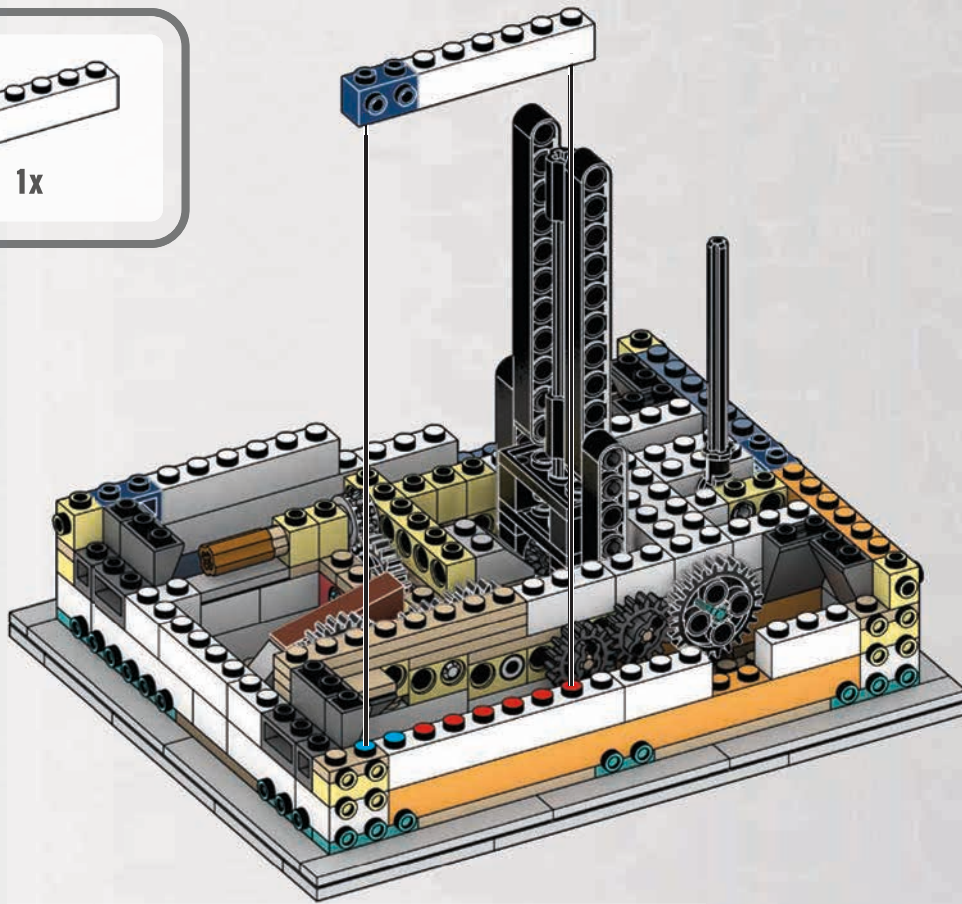

71



1x



1x



2x



1x



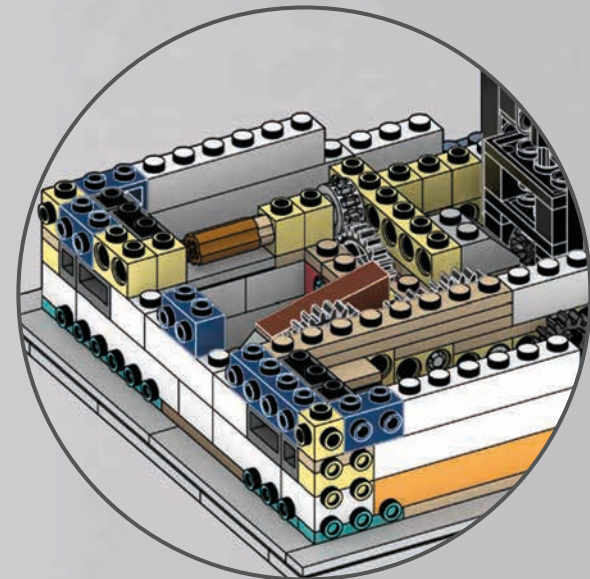
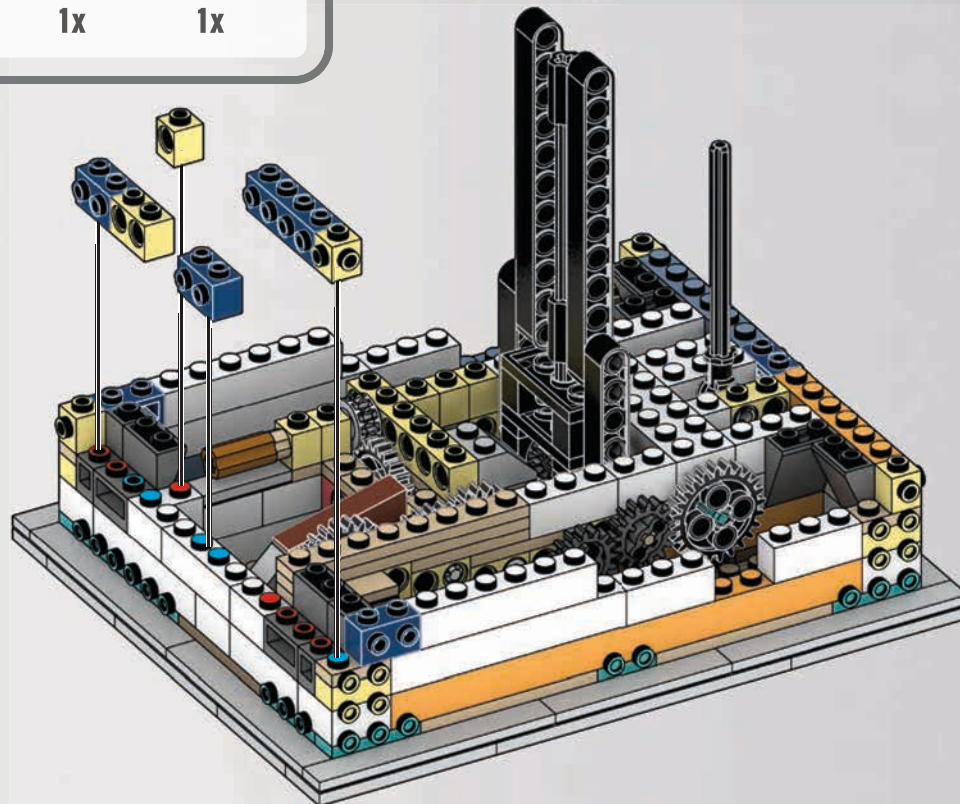

1x







**72**

4x  1x 

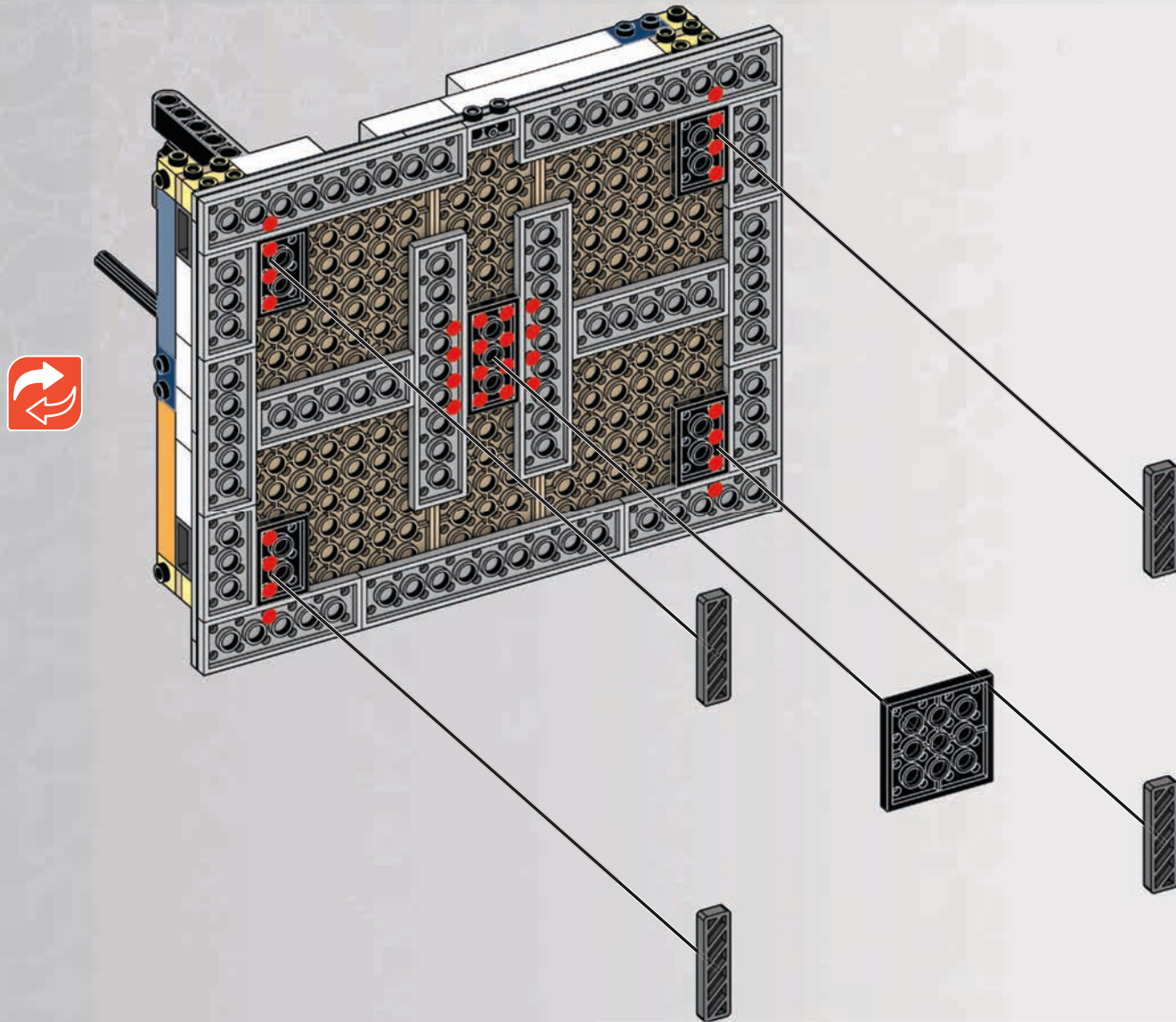

73



8x

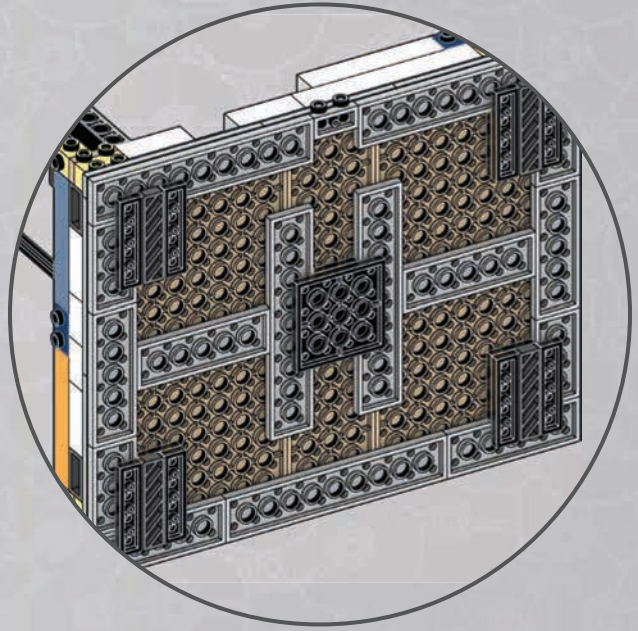
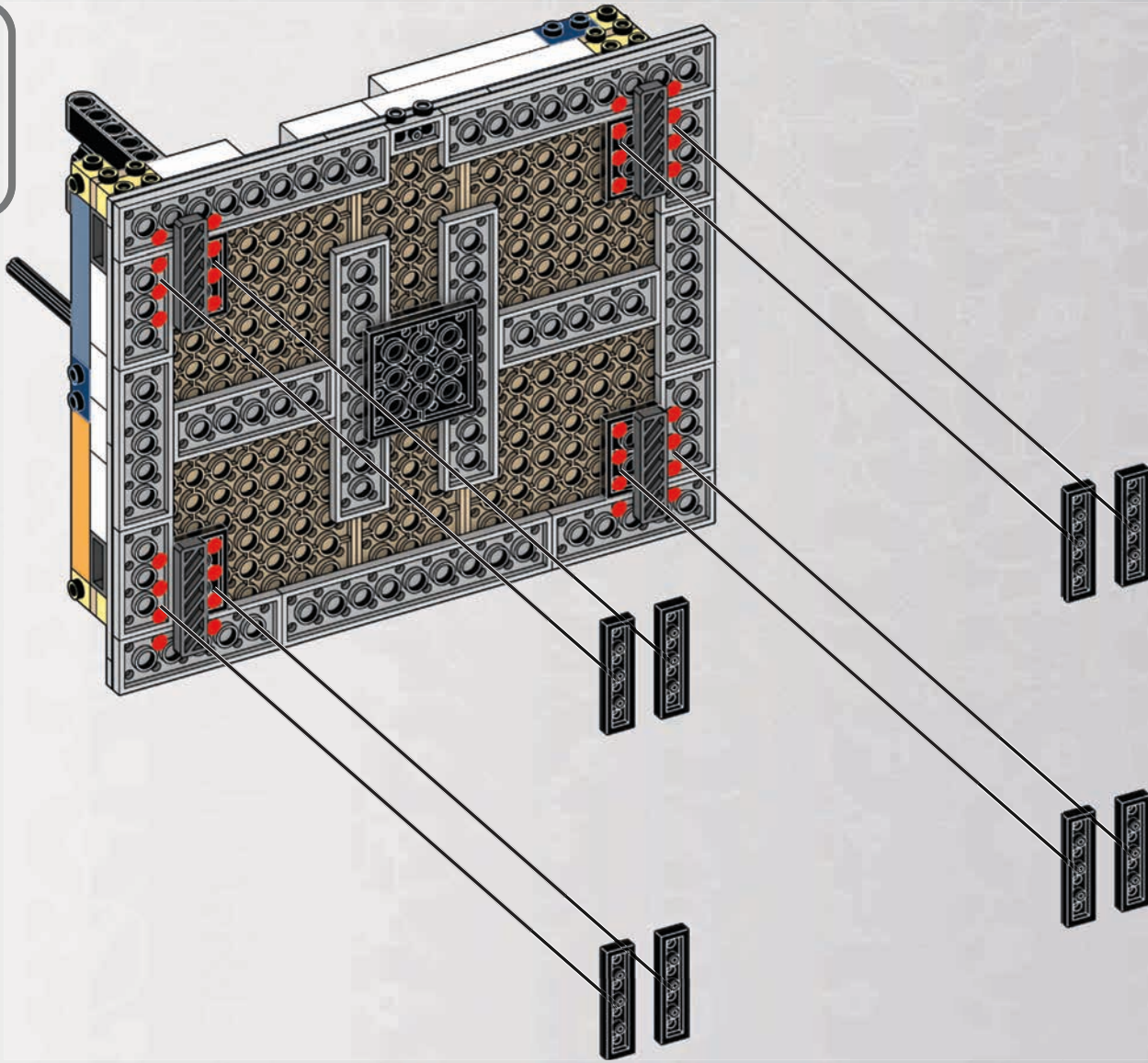

74



1x 1x 1x 1x

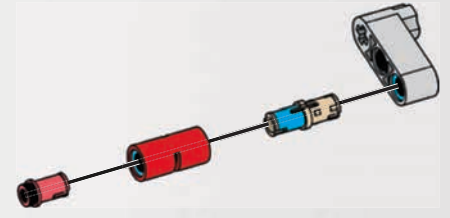

75



1x 1x 1x

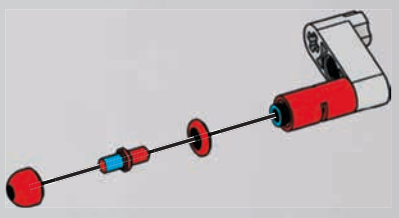

76

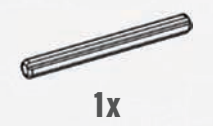

1x

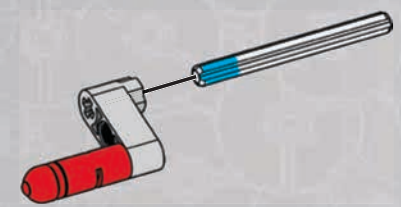

77



1x

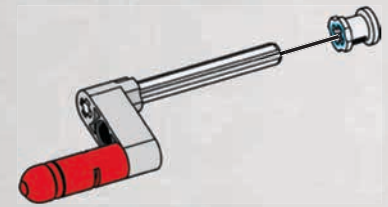

1

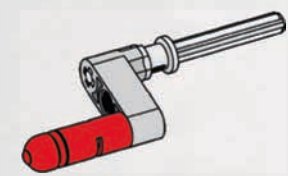

2

78

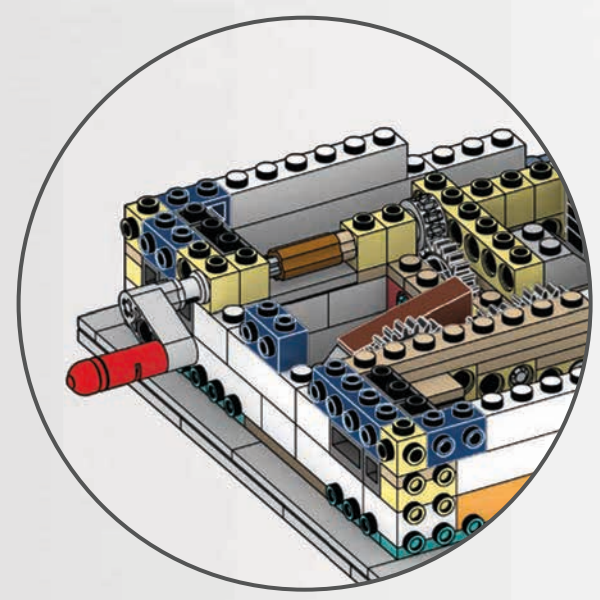
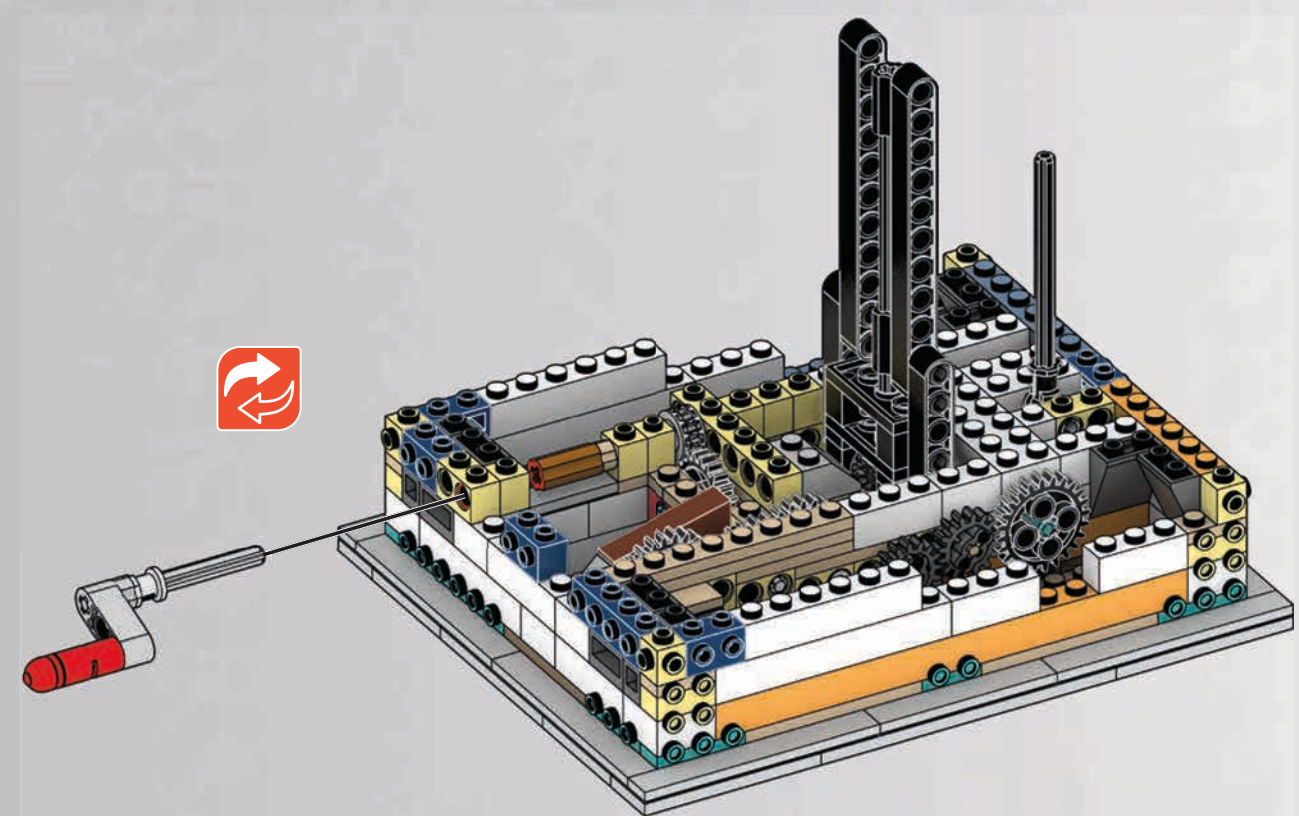

79

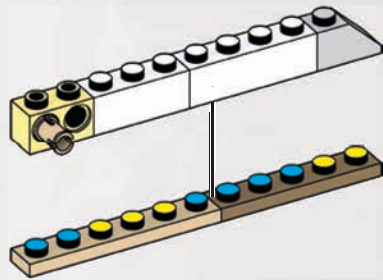
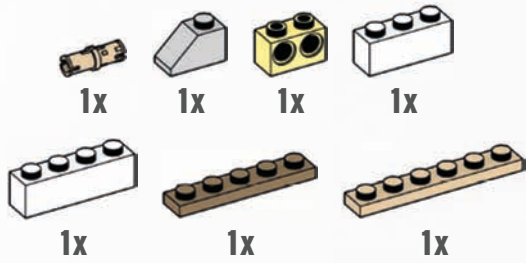

80

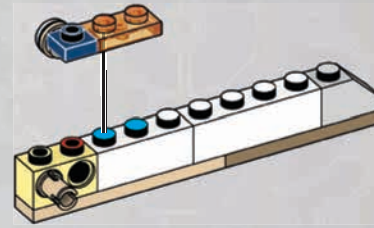
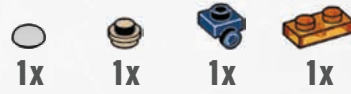

81

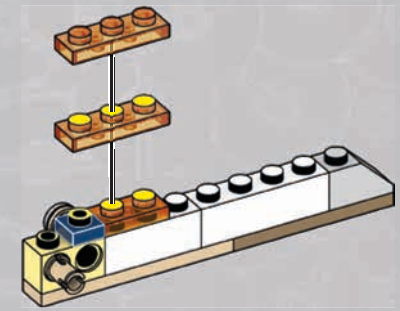

82

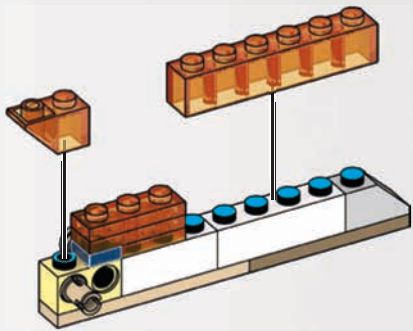
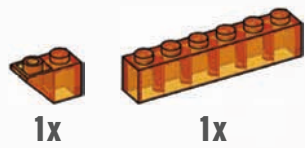

83

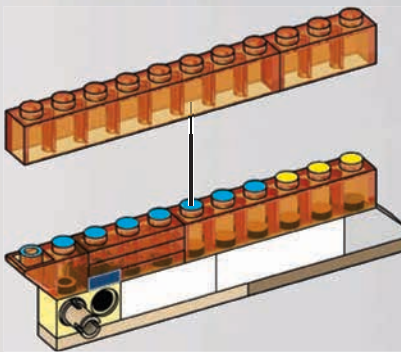
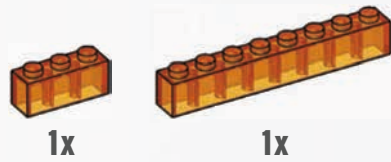

84

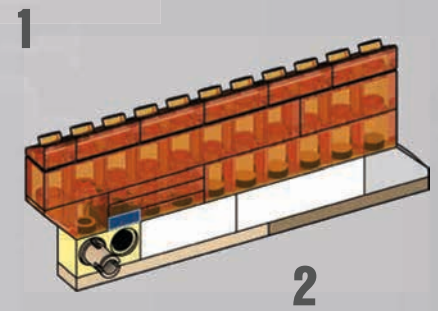
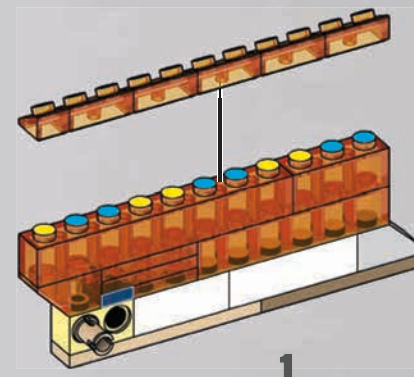
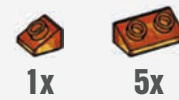

85

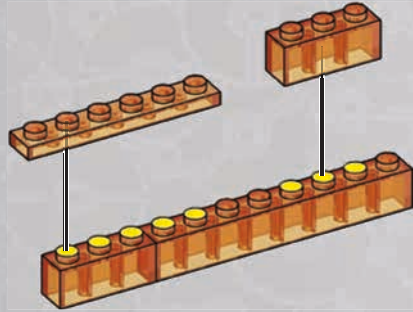

86

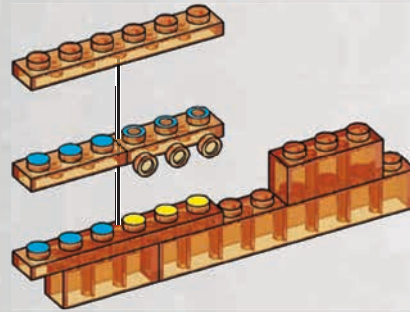

87

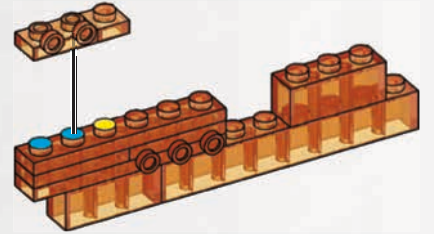
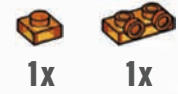

88

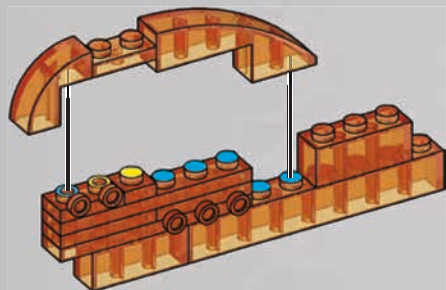

89

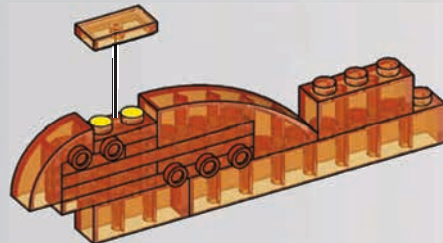

90

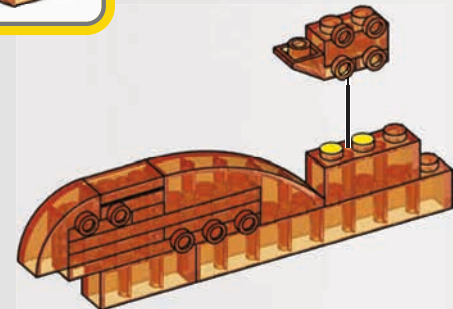
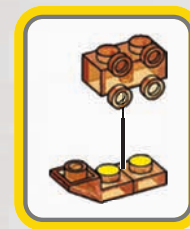

91

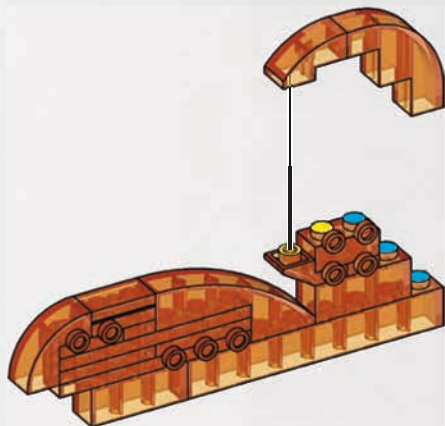
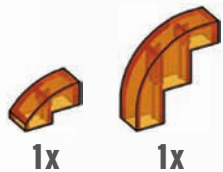

92

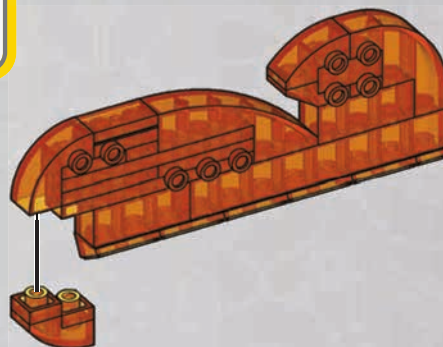

93

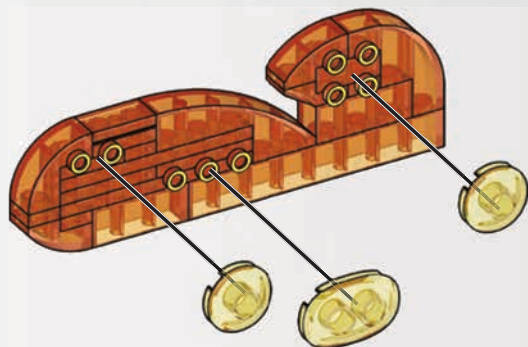
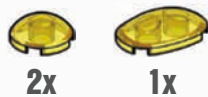

1

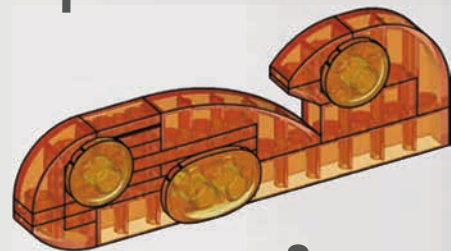

2

94

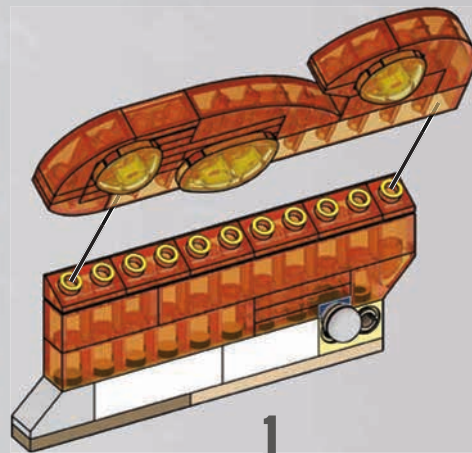

1

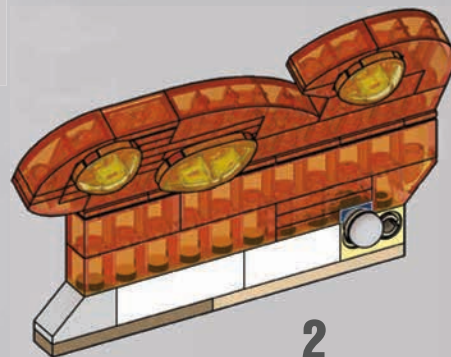

2

95

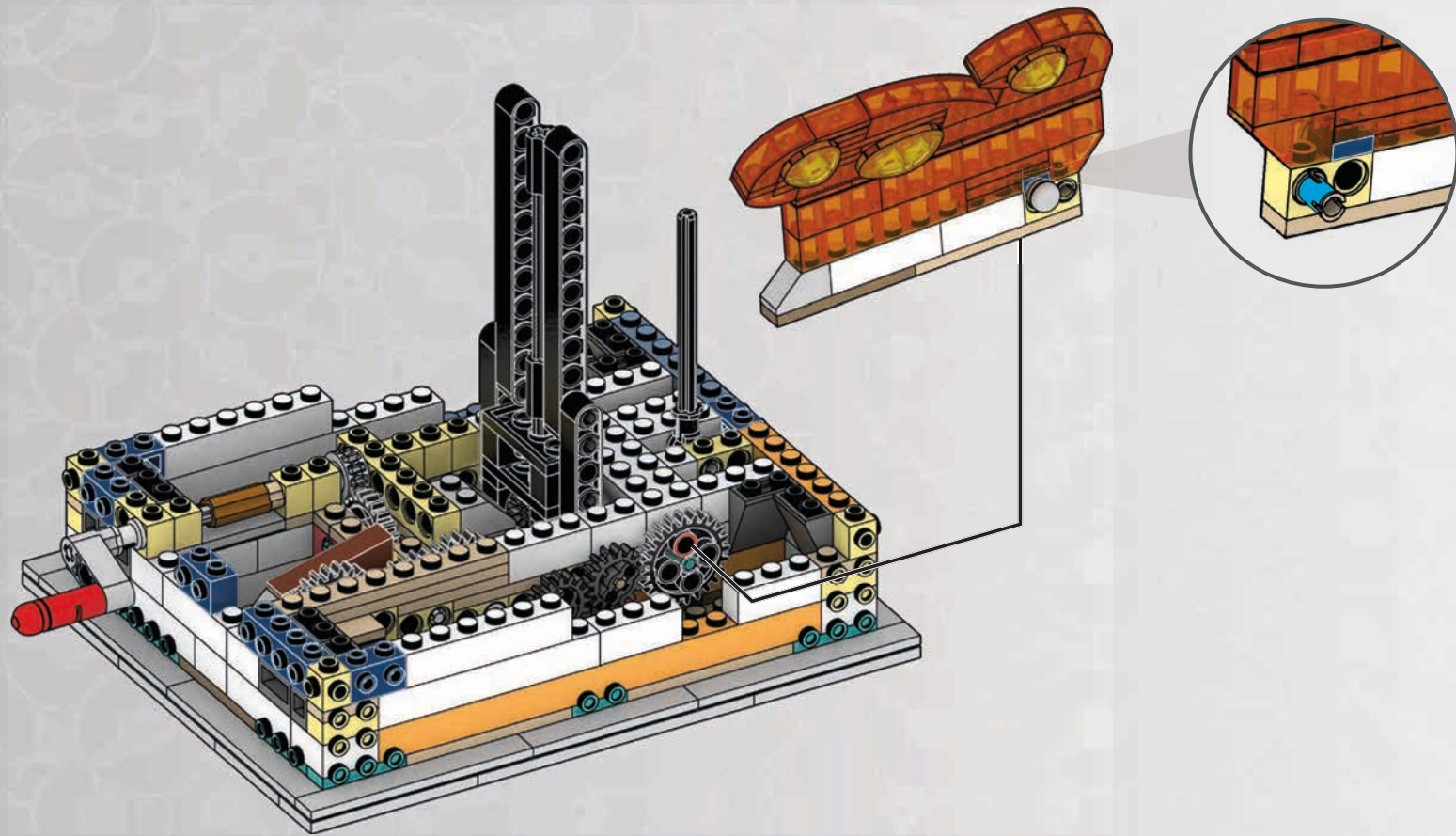

96

-  2x
-  2x
-  1x

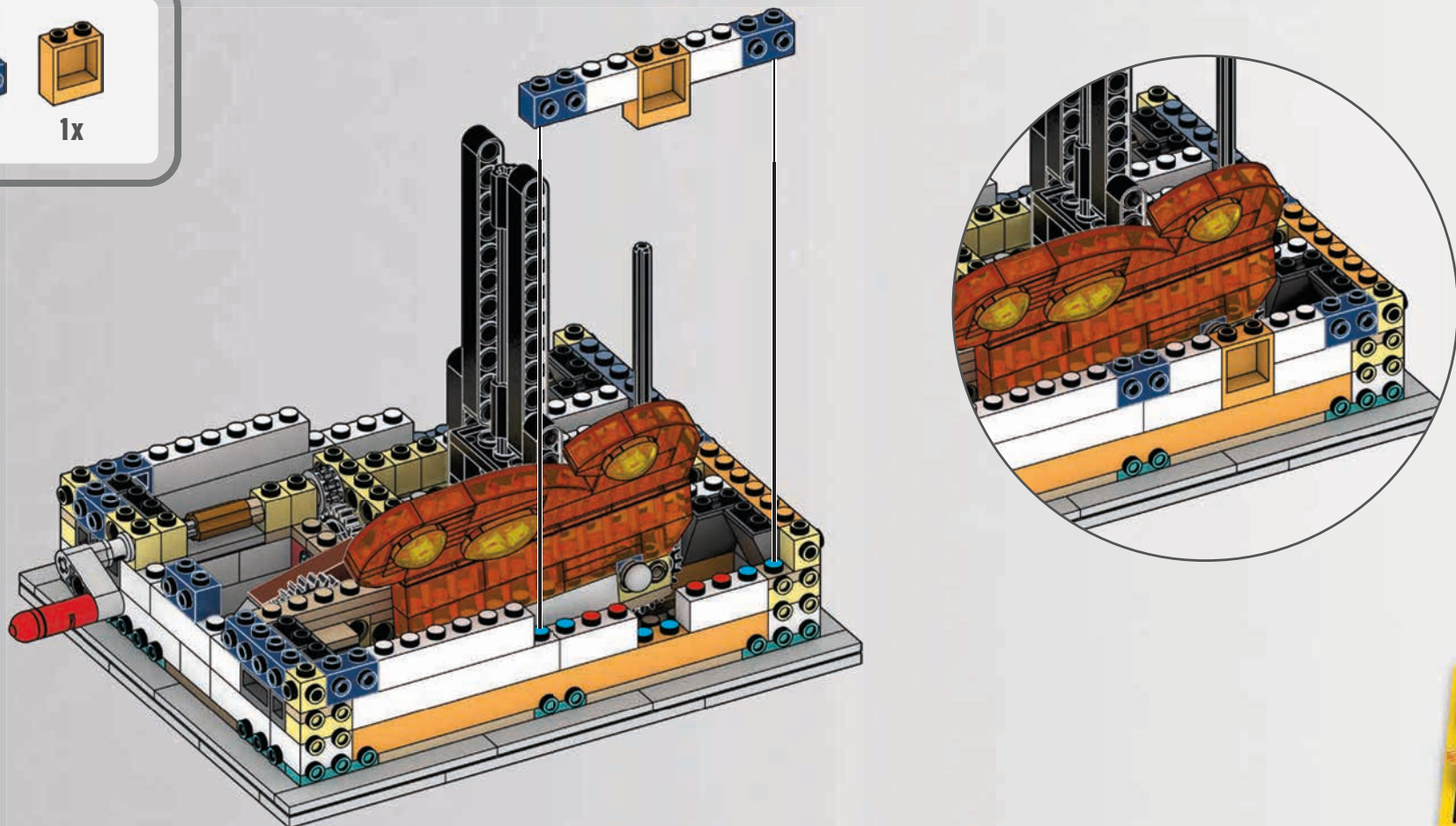

97

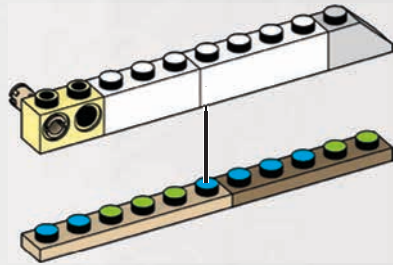
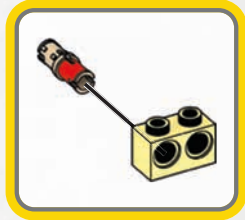
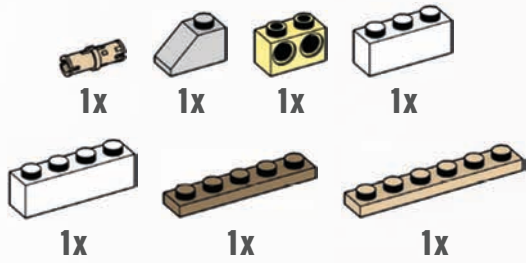

98

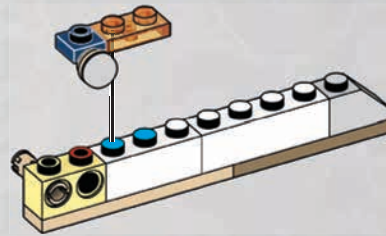
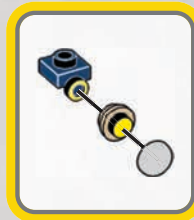

99

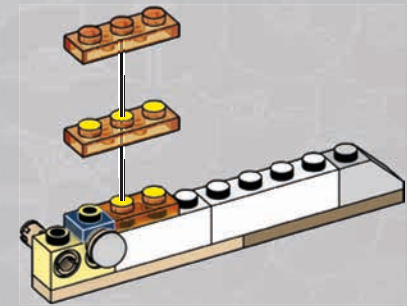

100

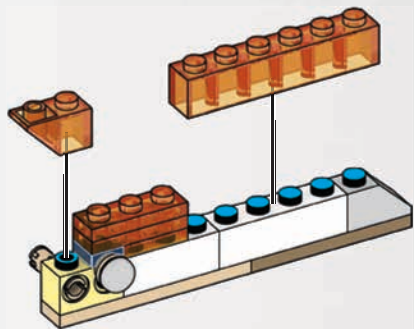
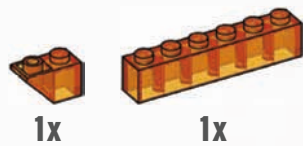

101

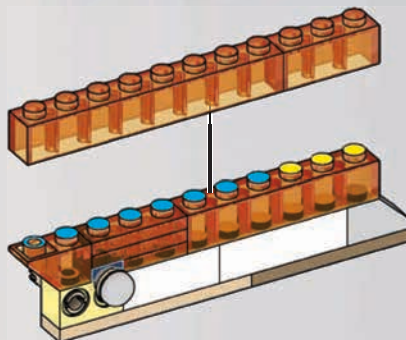
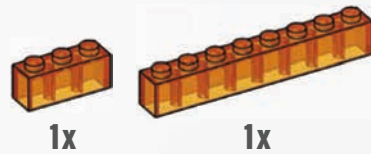

102

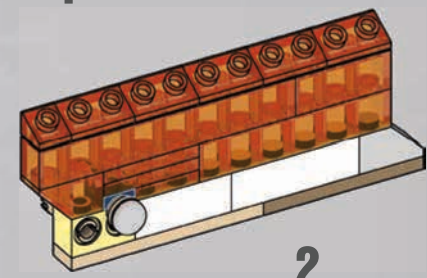
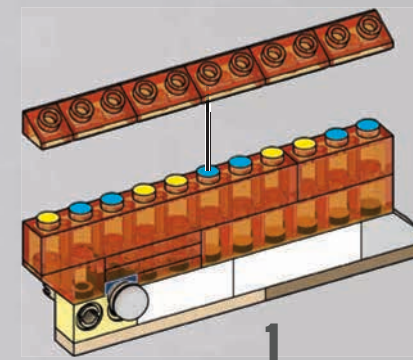
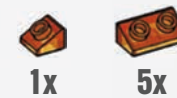



103

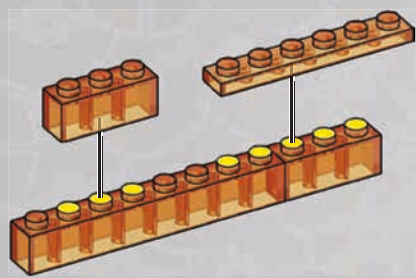

104

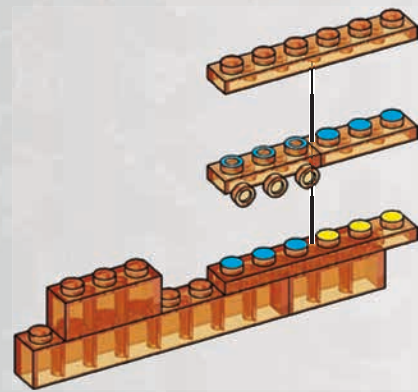

105

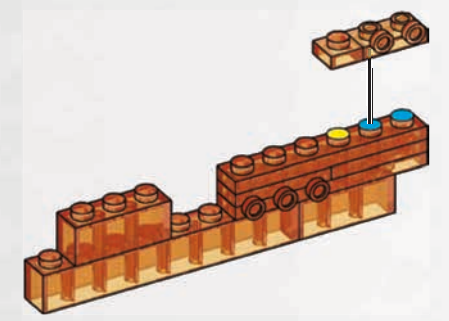

106

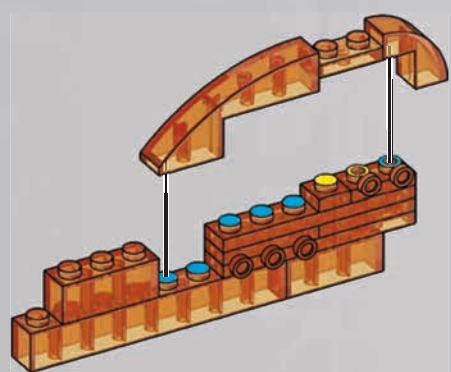

107

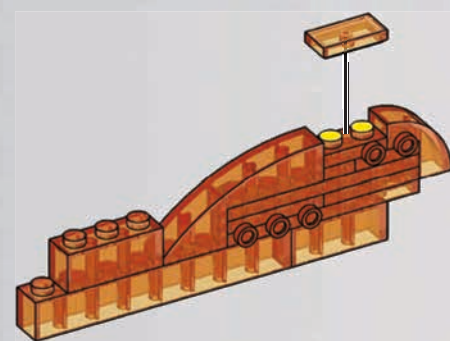

108

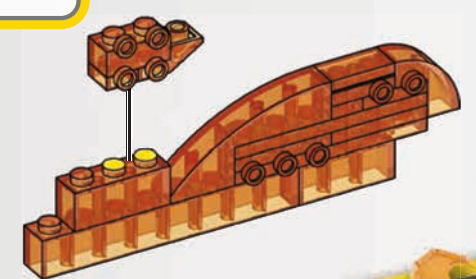
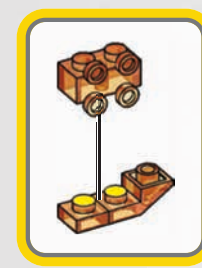

109

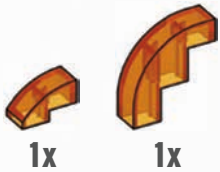

1x

1x

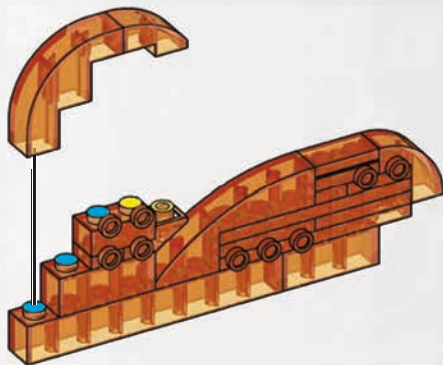

110



2x

1x

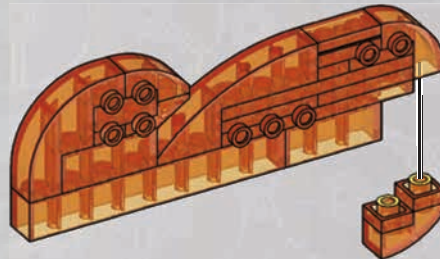

111



2x

1x

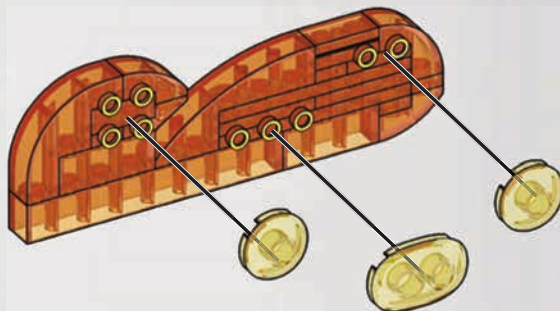

1

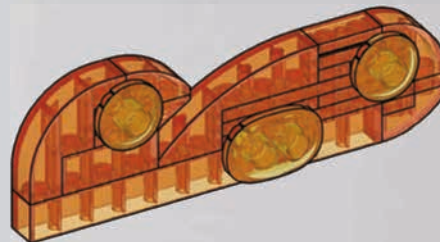

2

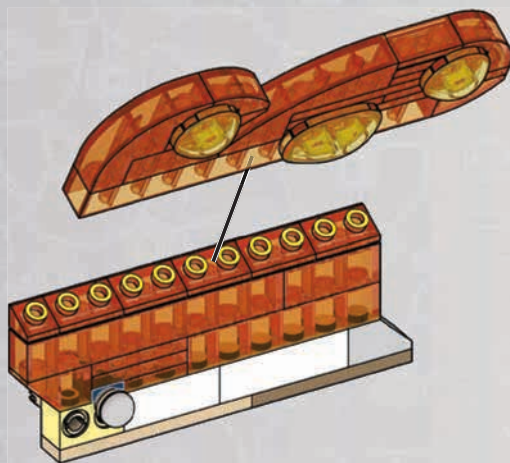

1

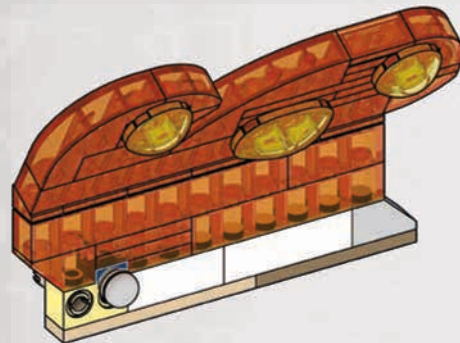

2

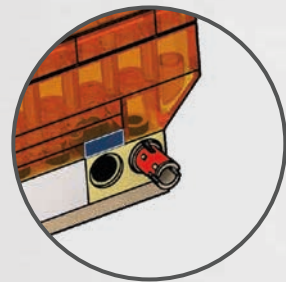
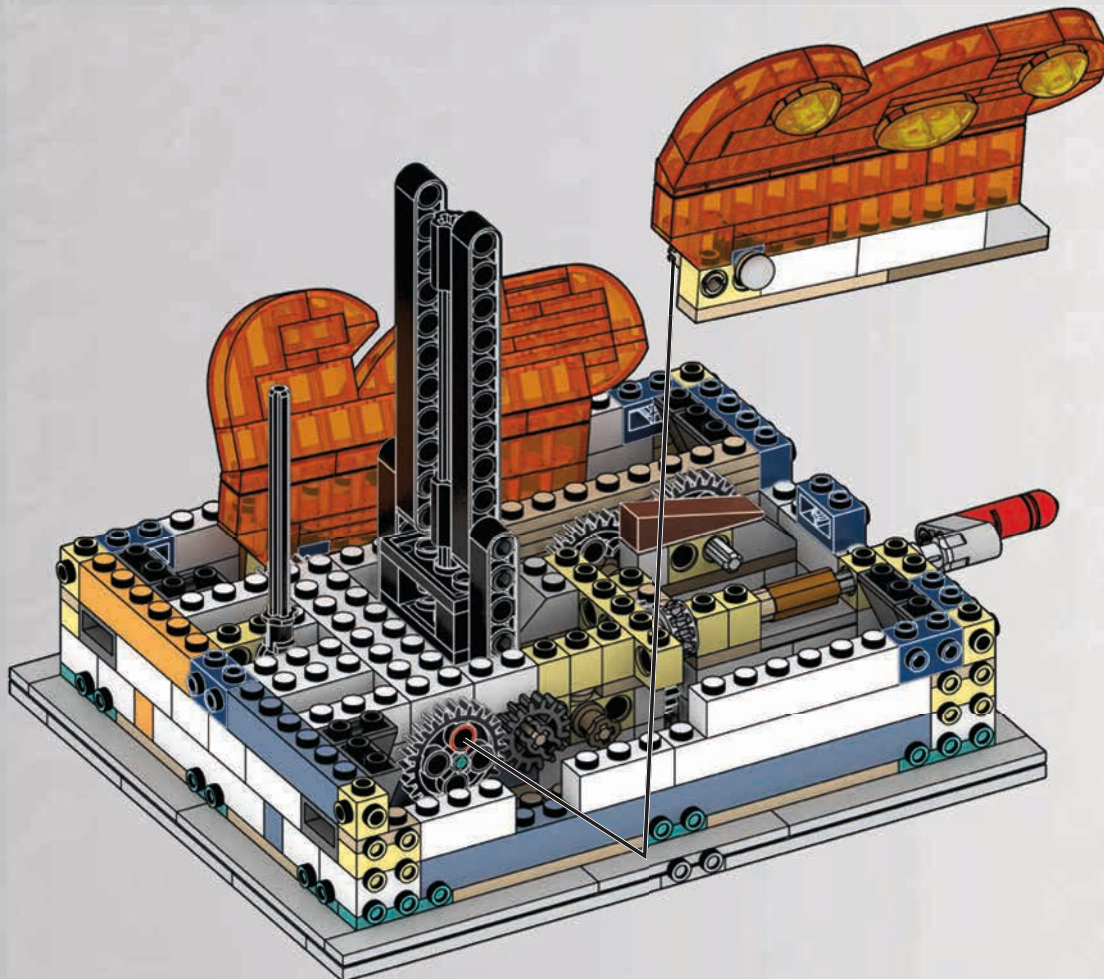



2x



2x



1x

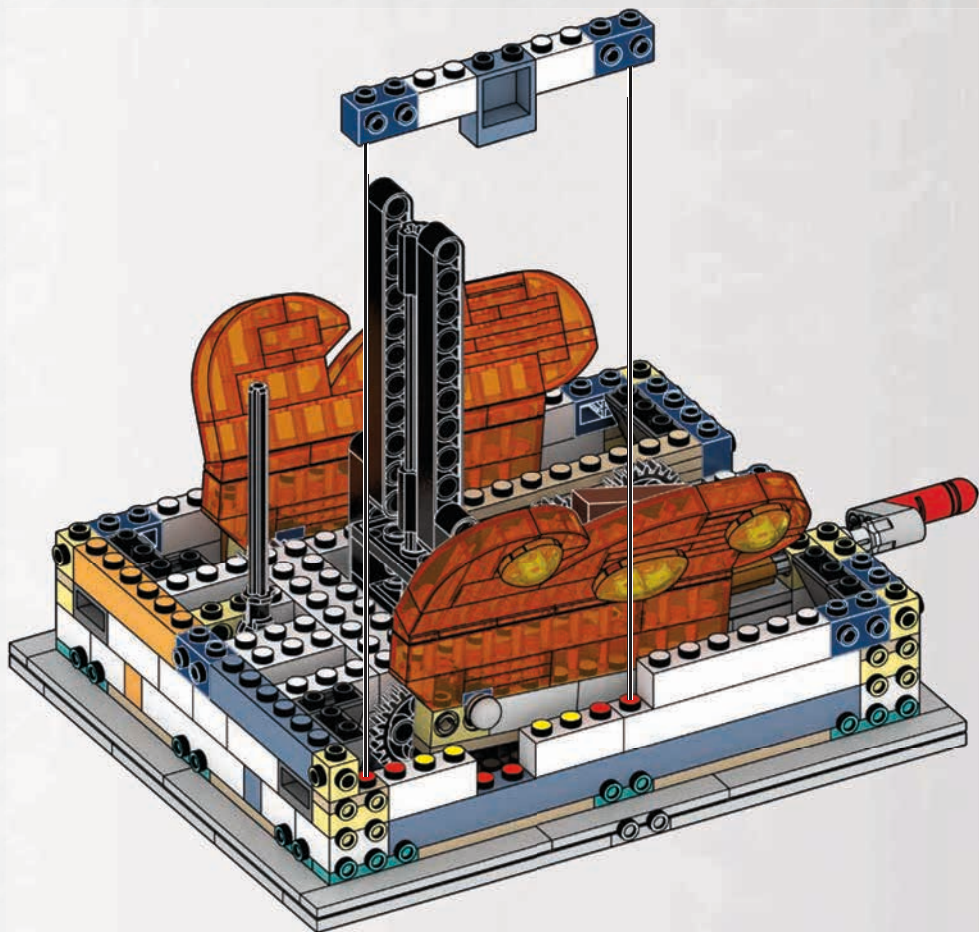

1

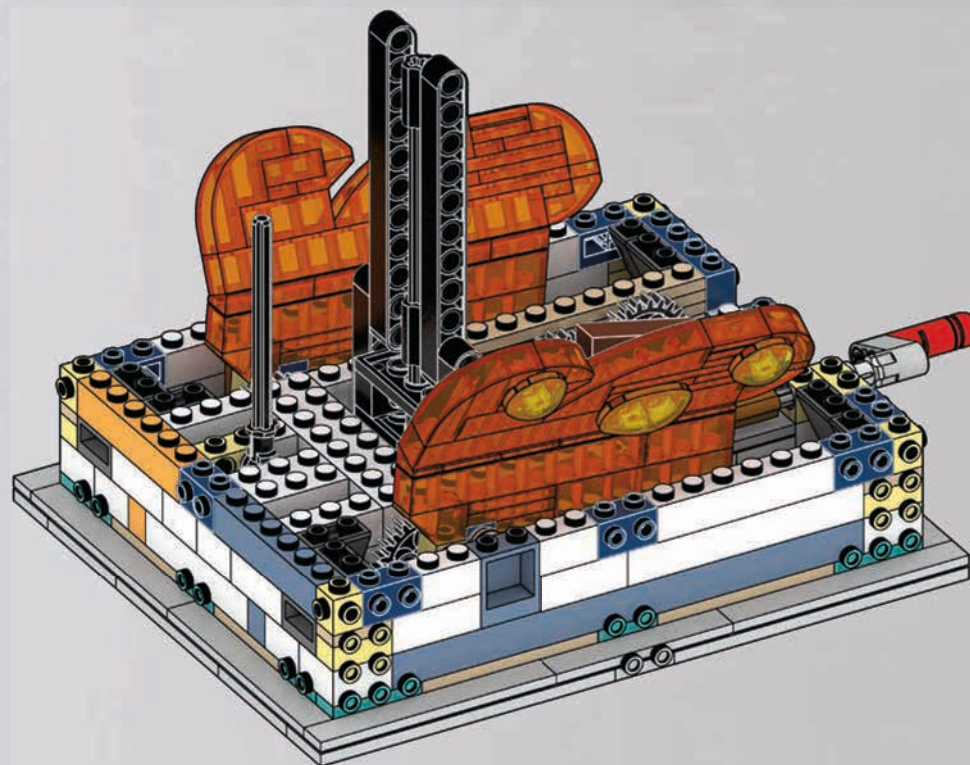

2

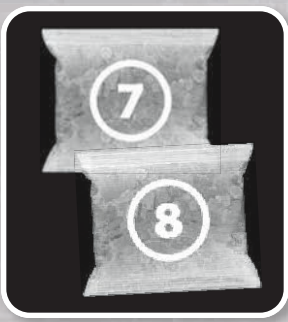

115

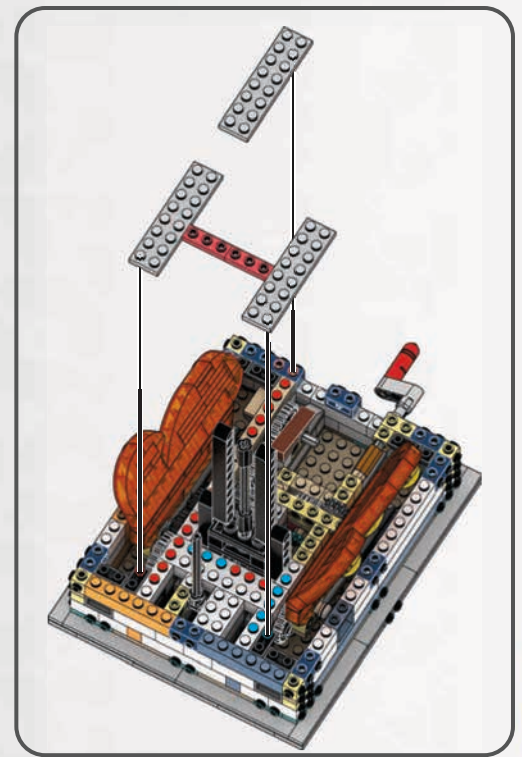
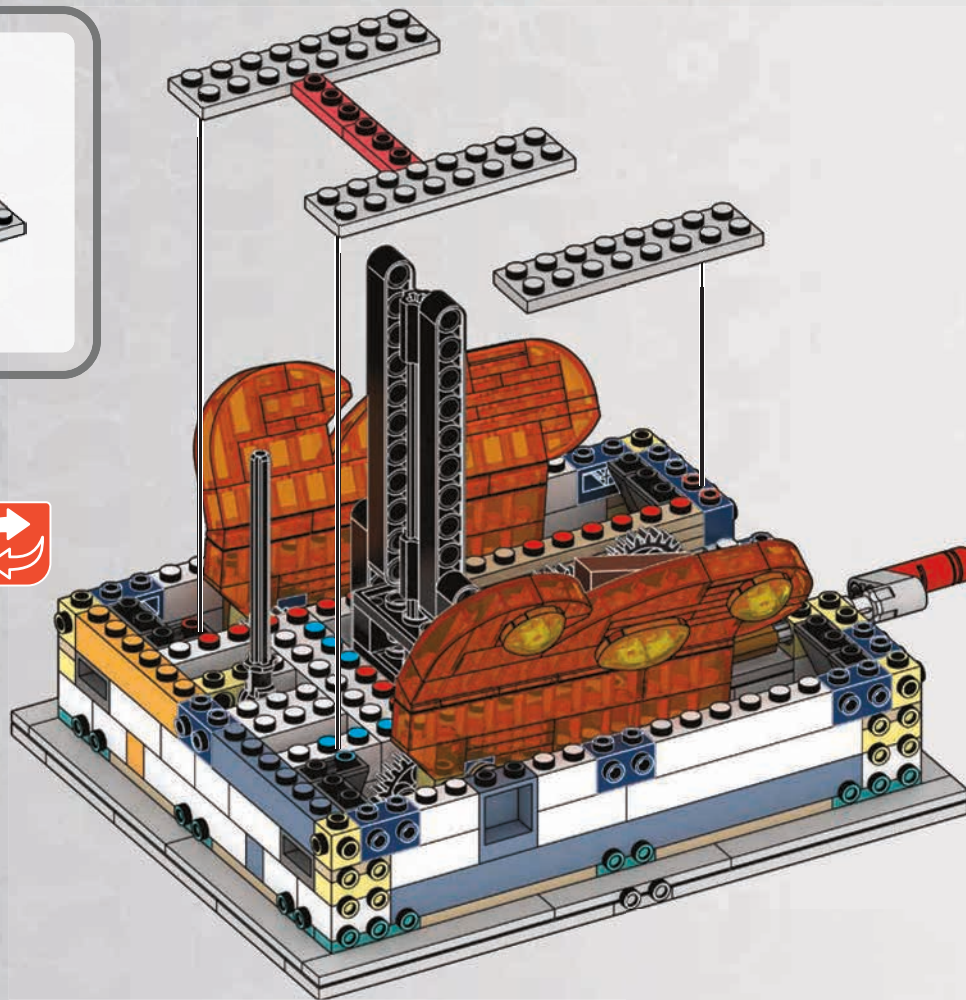
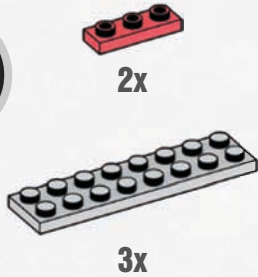

116

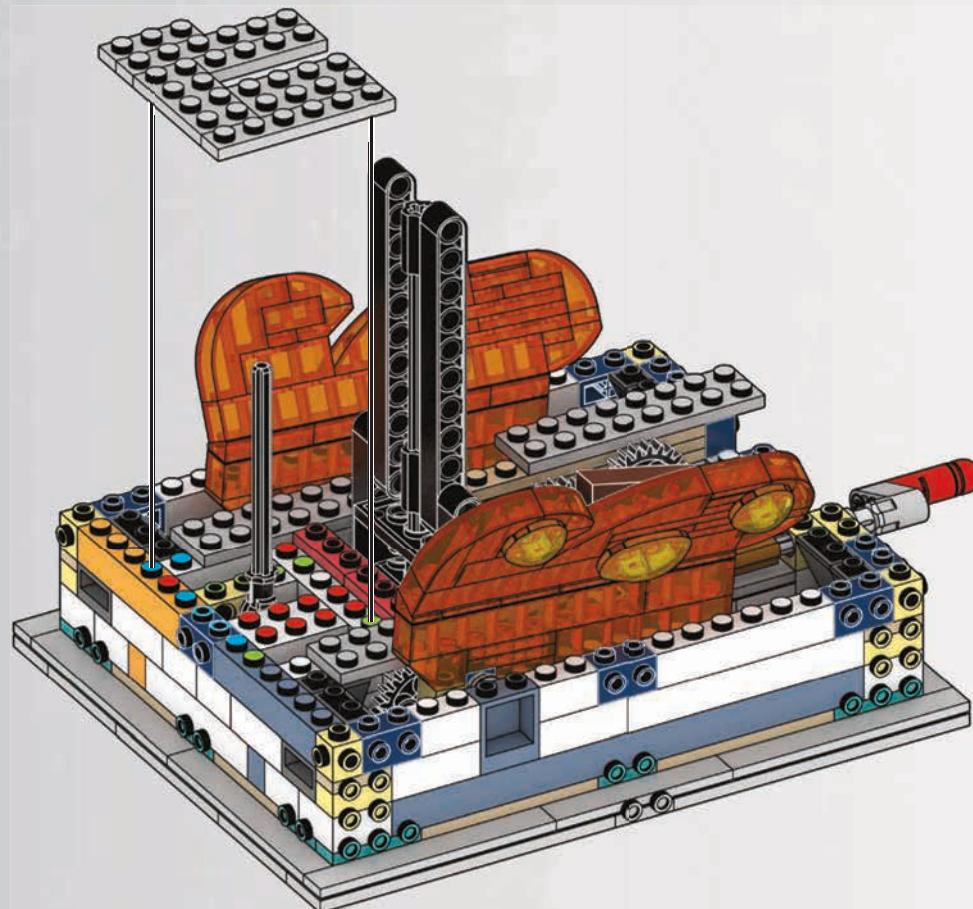

117



2x

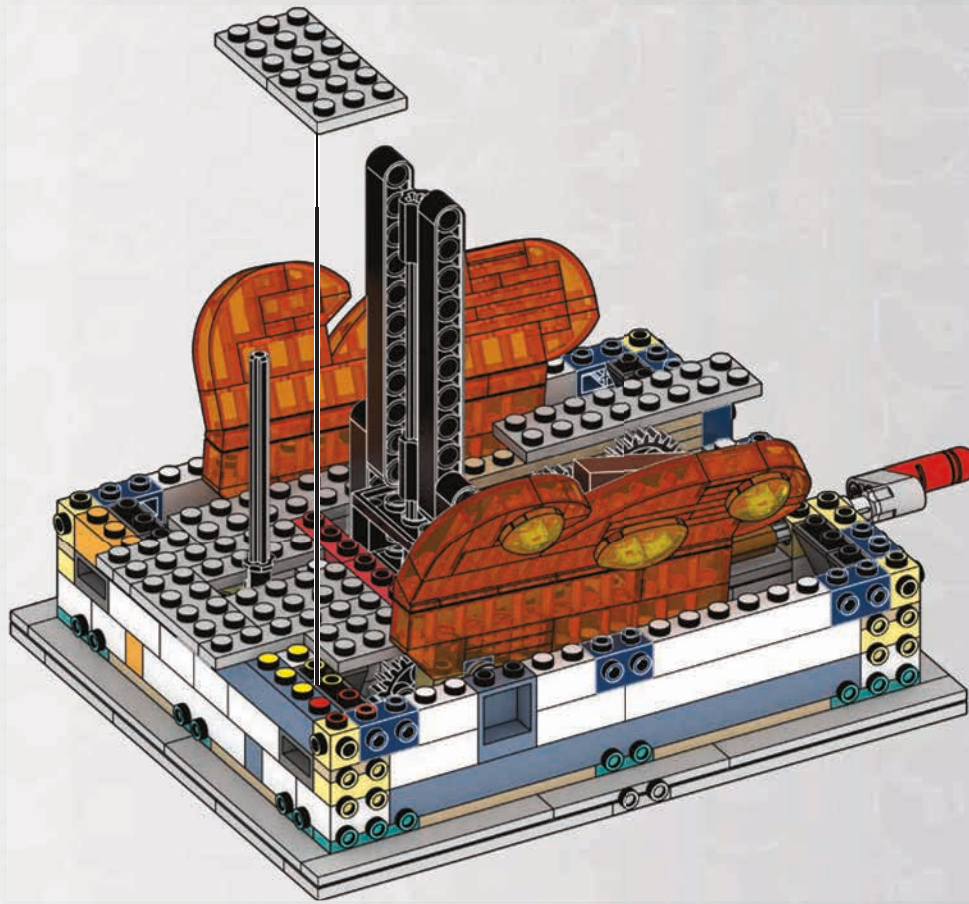

118



1x



1x



1x

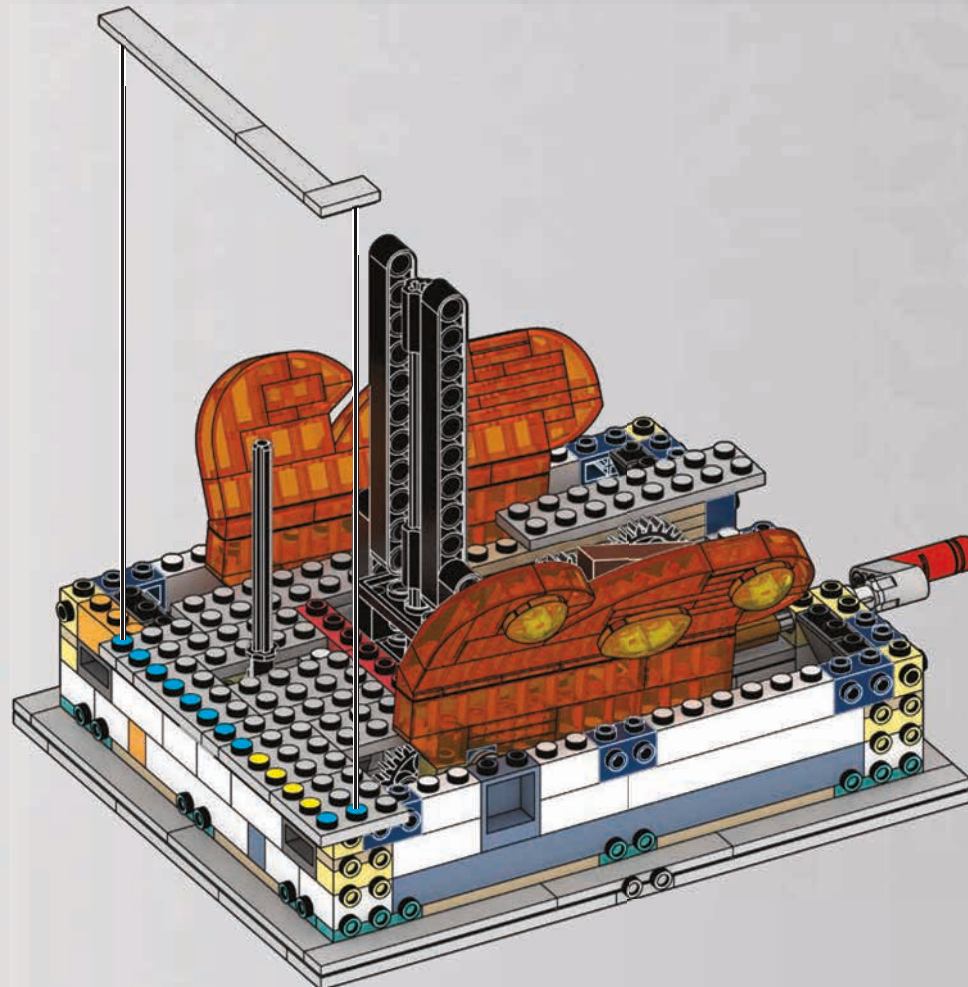

119



3x



1x

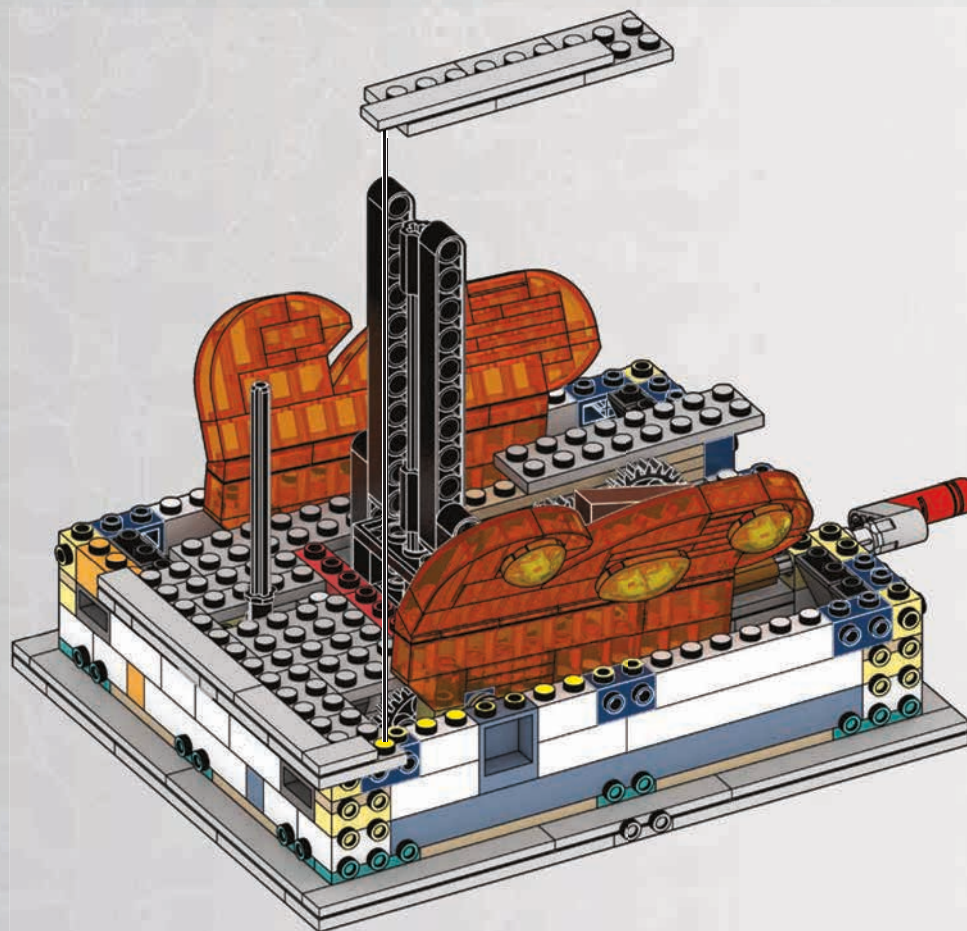
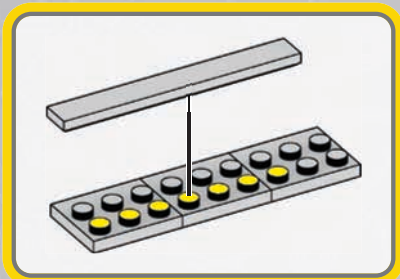

120



2x



1x

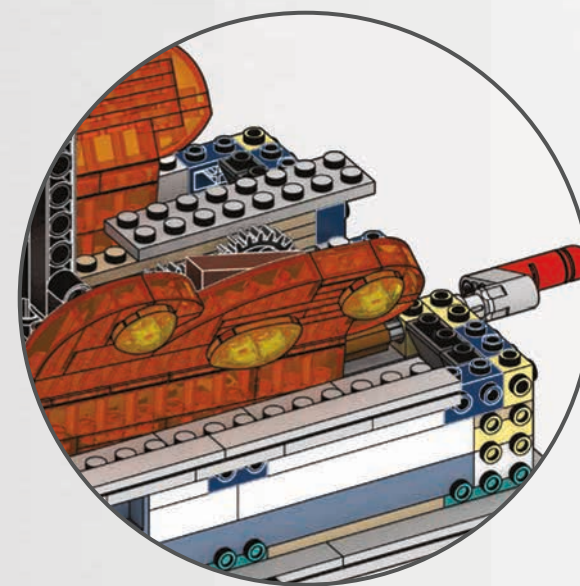
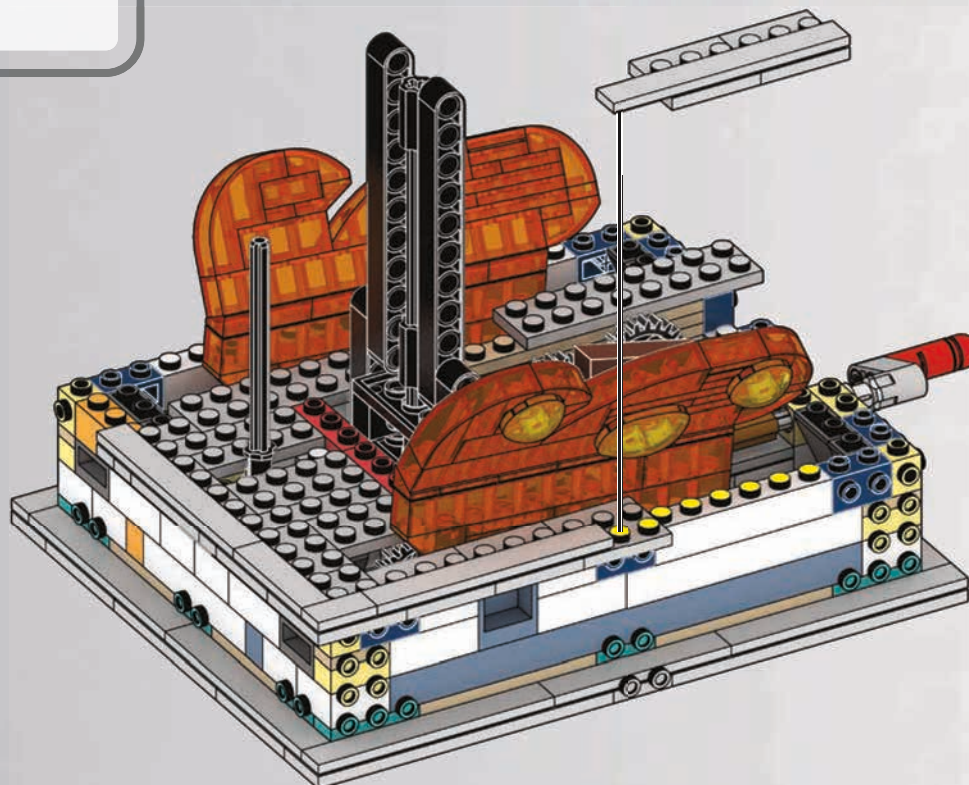
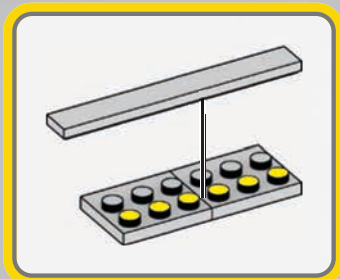

121

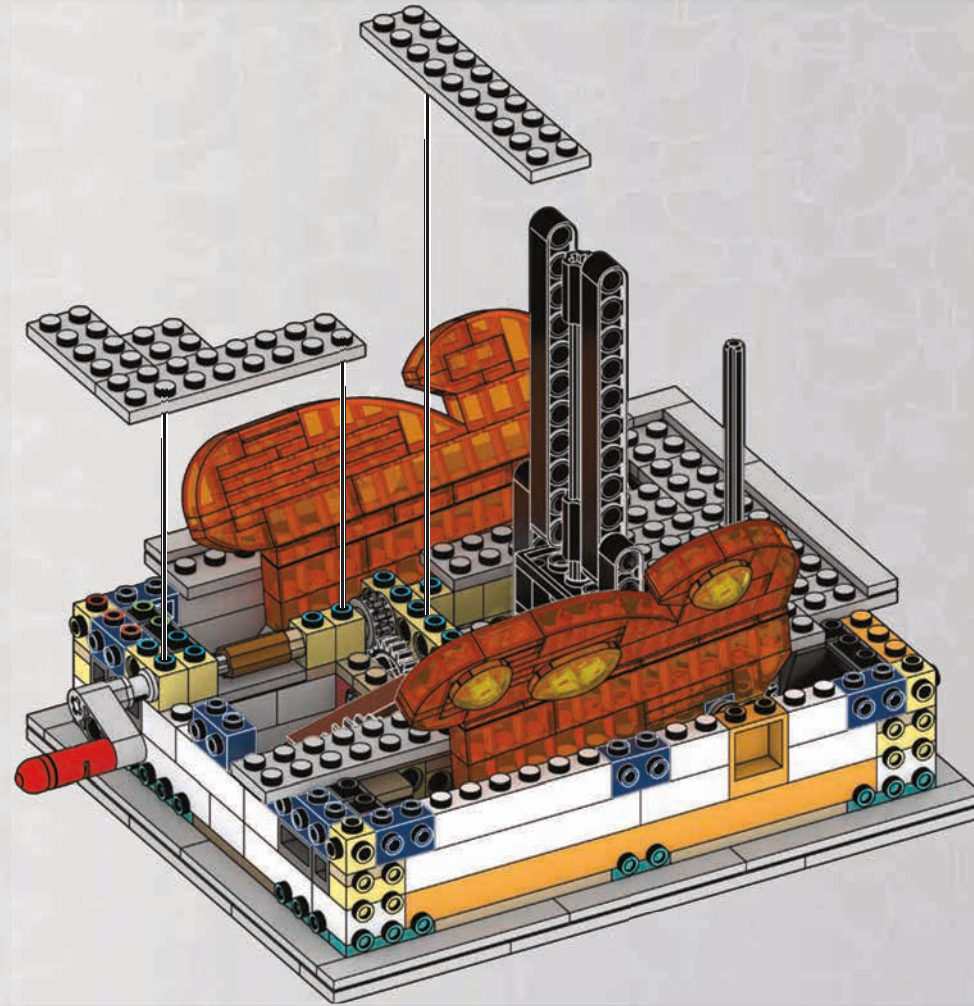
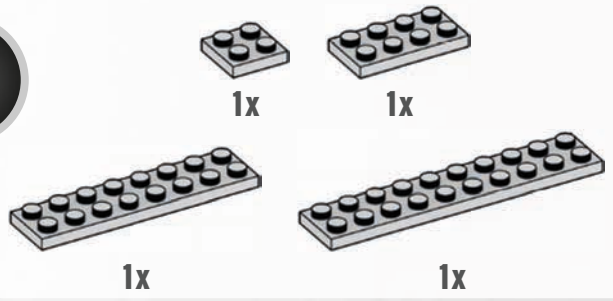

122

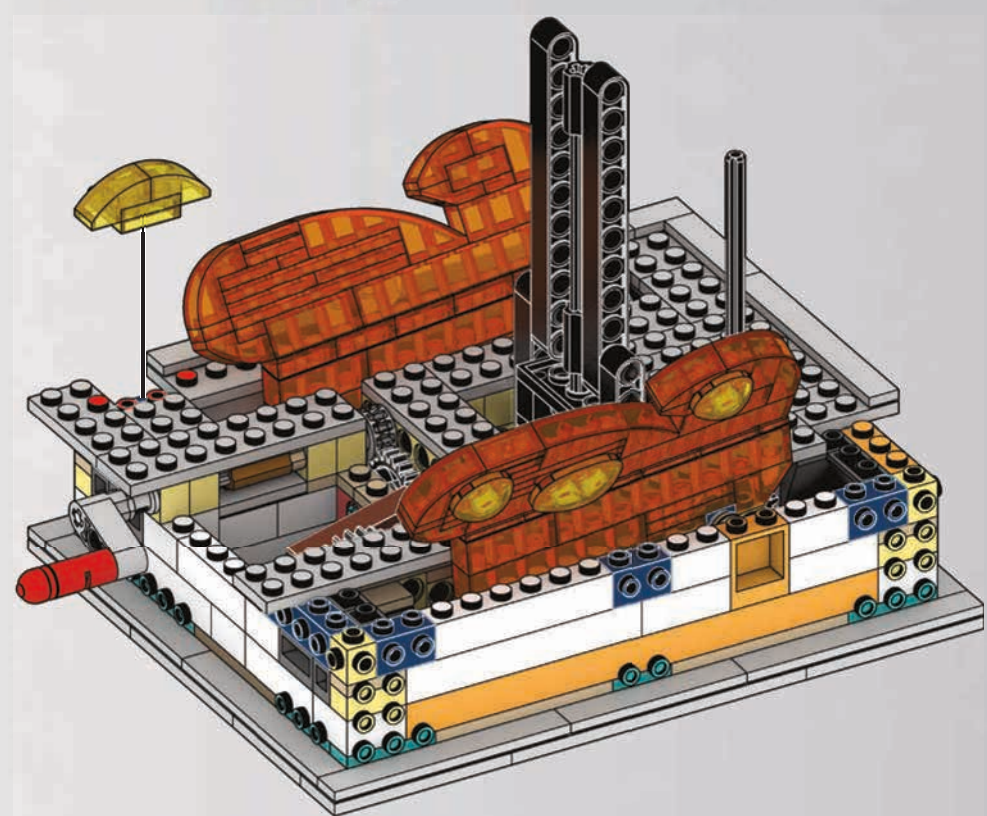
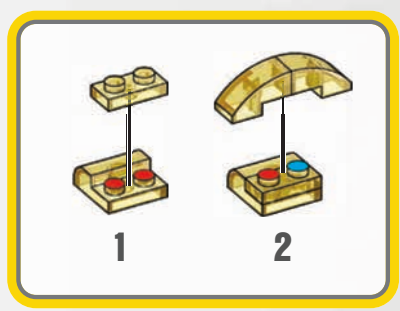



123

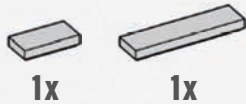

1x

1x

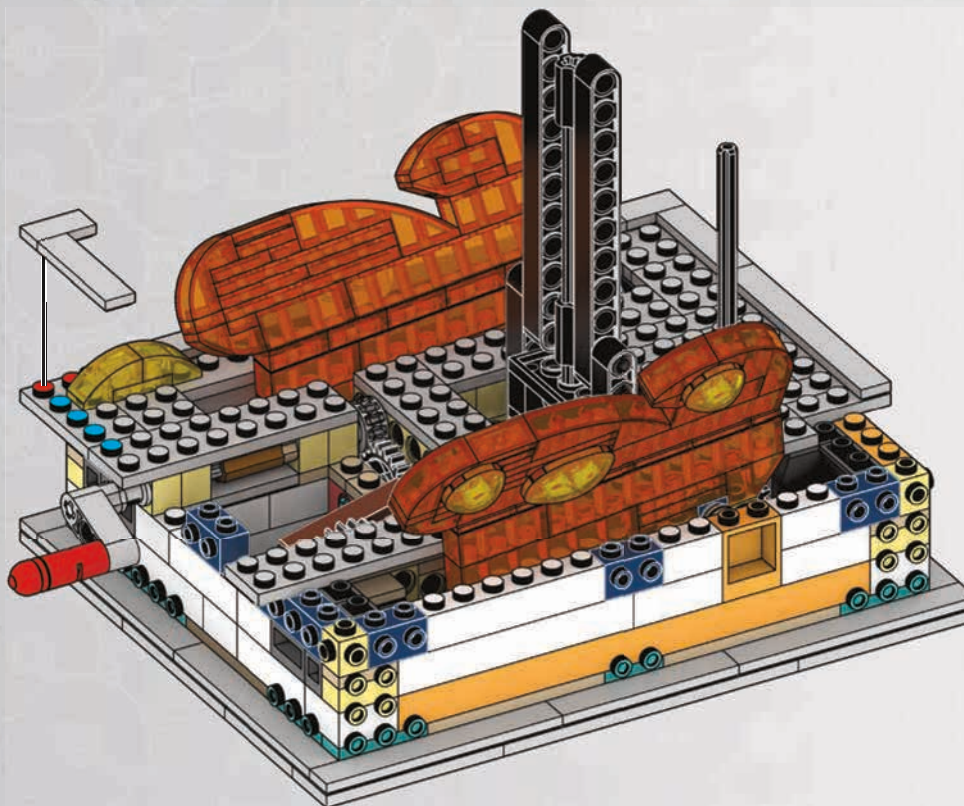

124

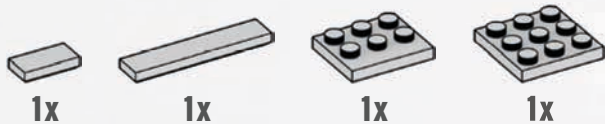

1x

1x

1x

1x

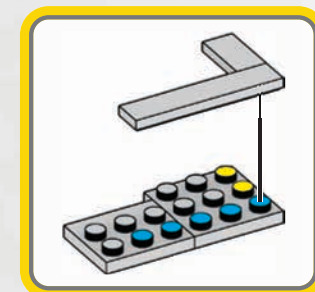
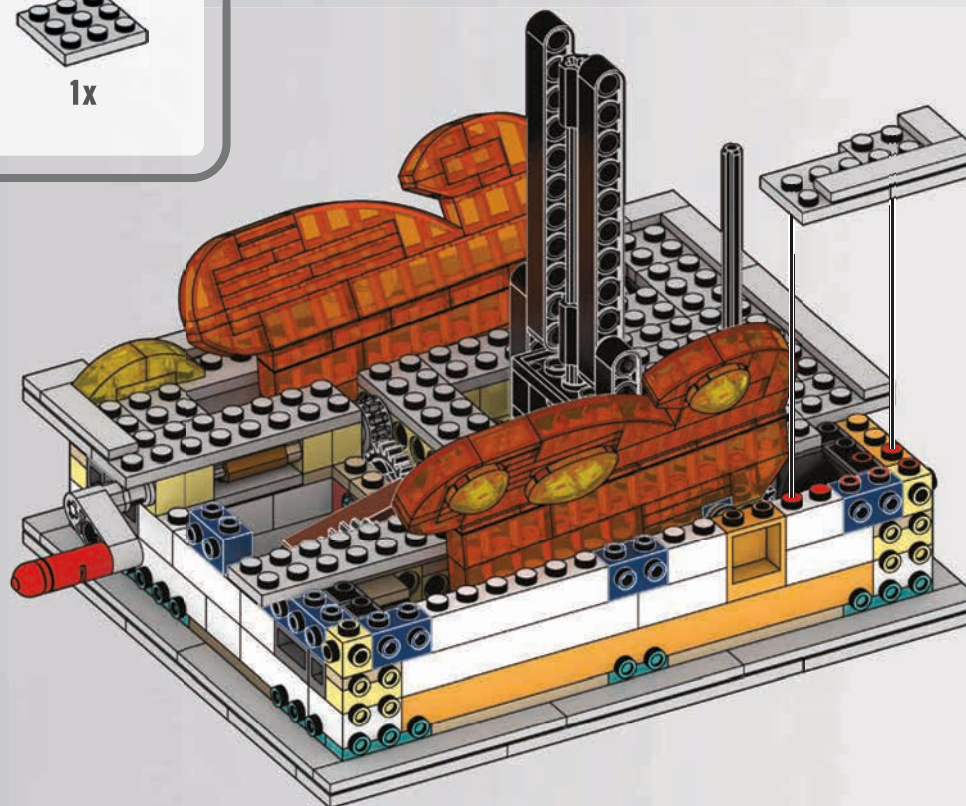

125

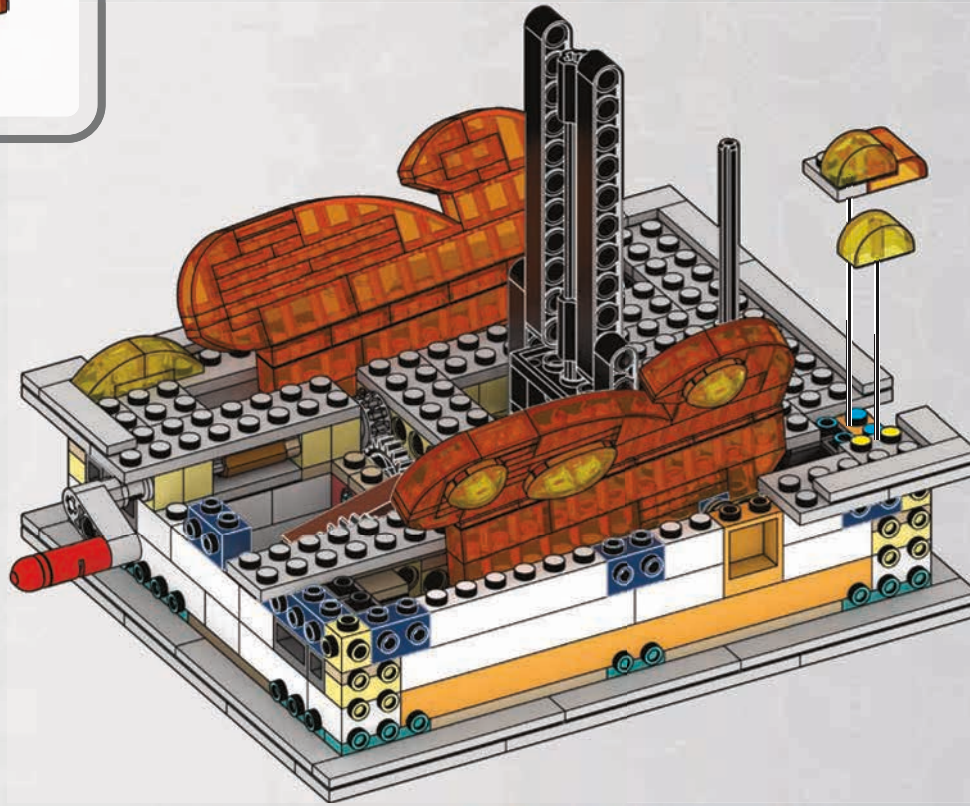

126

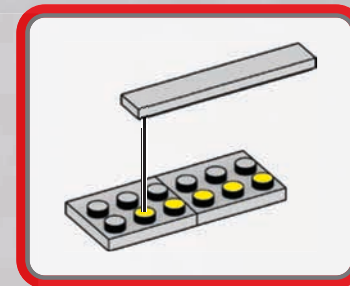
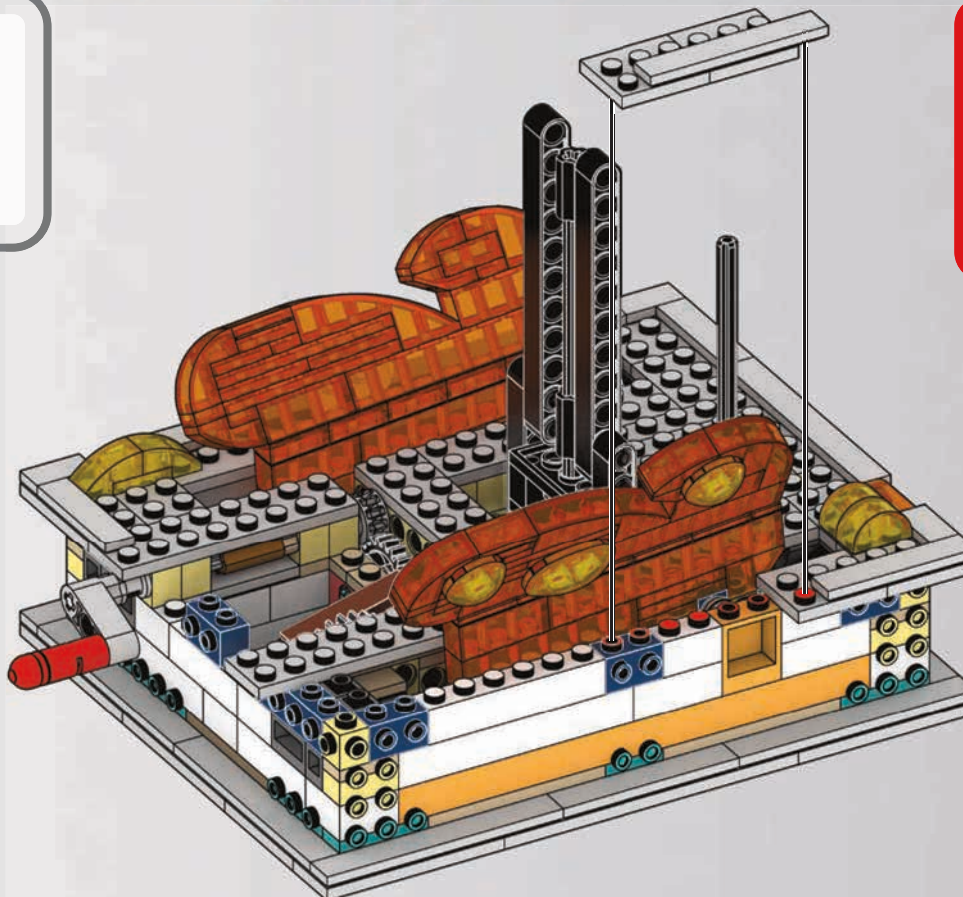
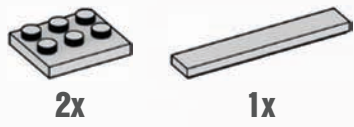

127

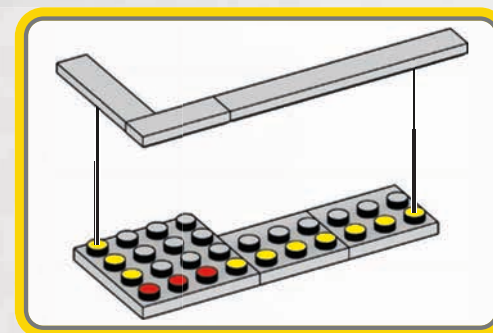
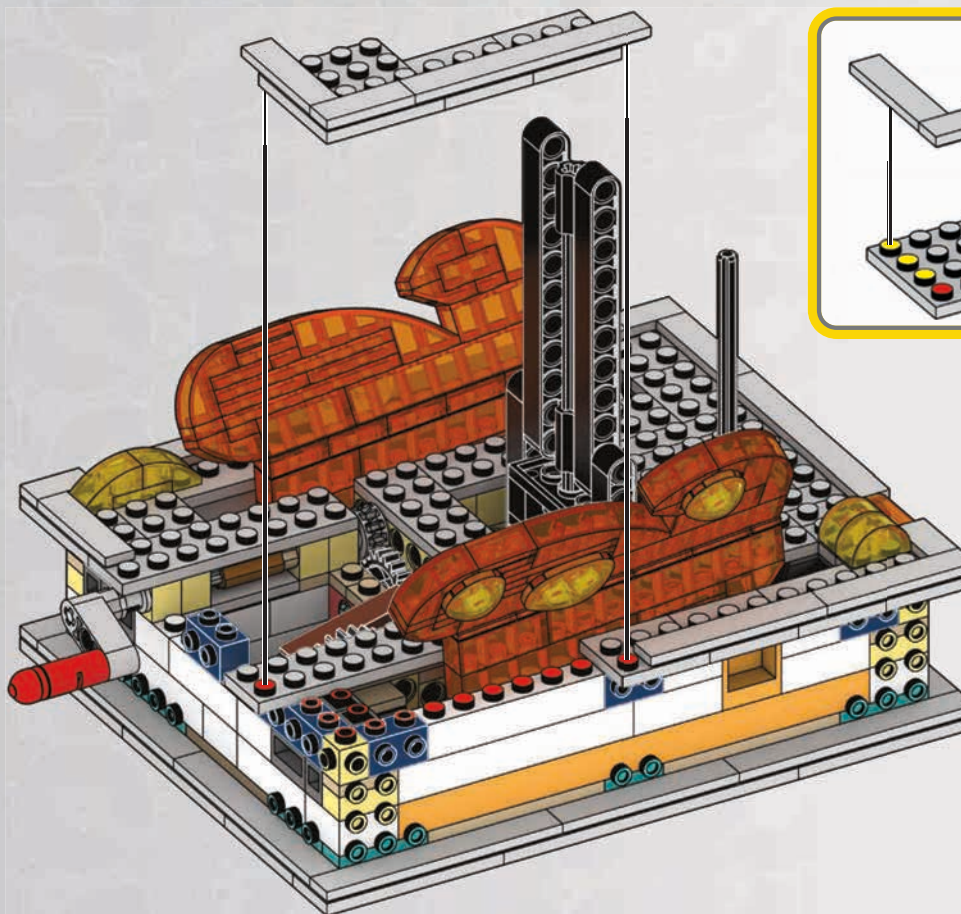
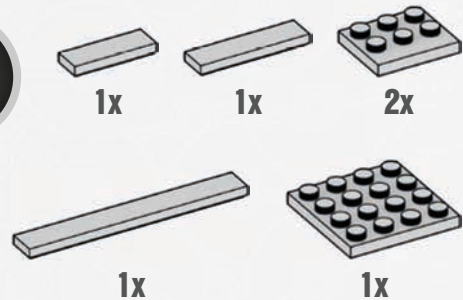

128

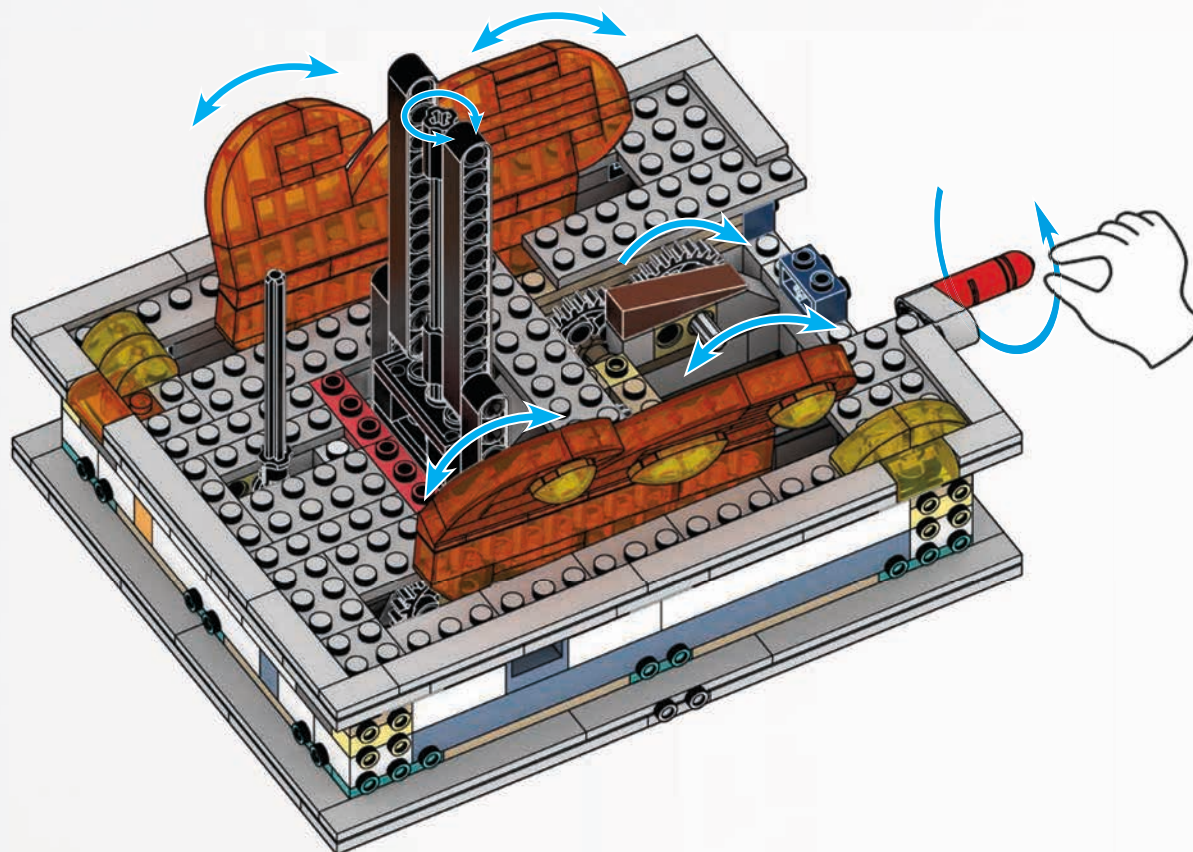

129

- 1x
- 1x
- 1x
- 2x
- 2x

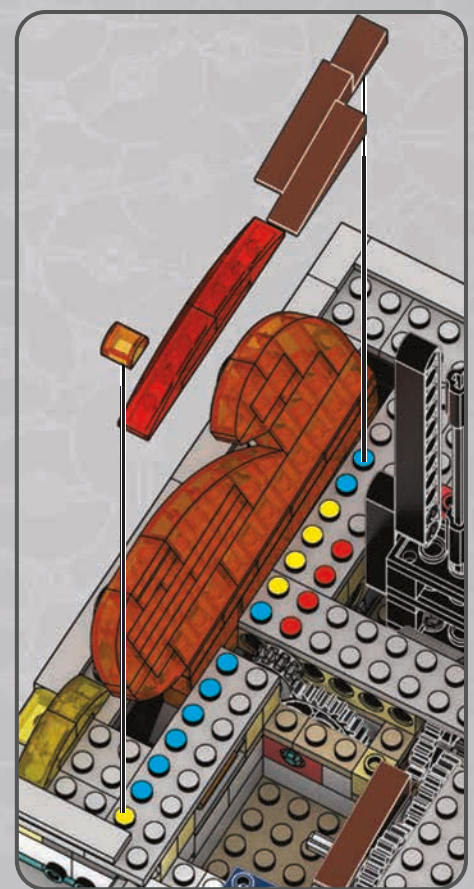
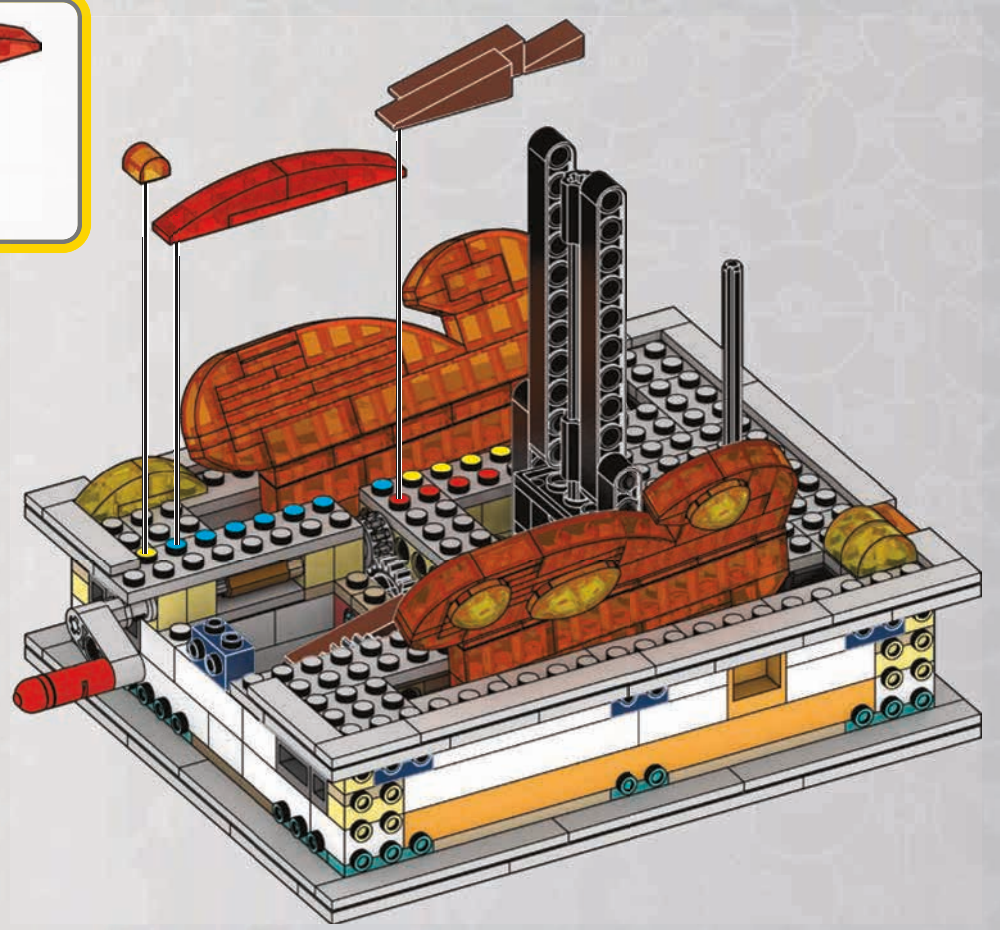
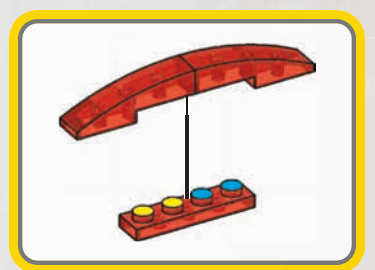

130

- 1x
- 1x
- 1x
- 1x

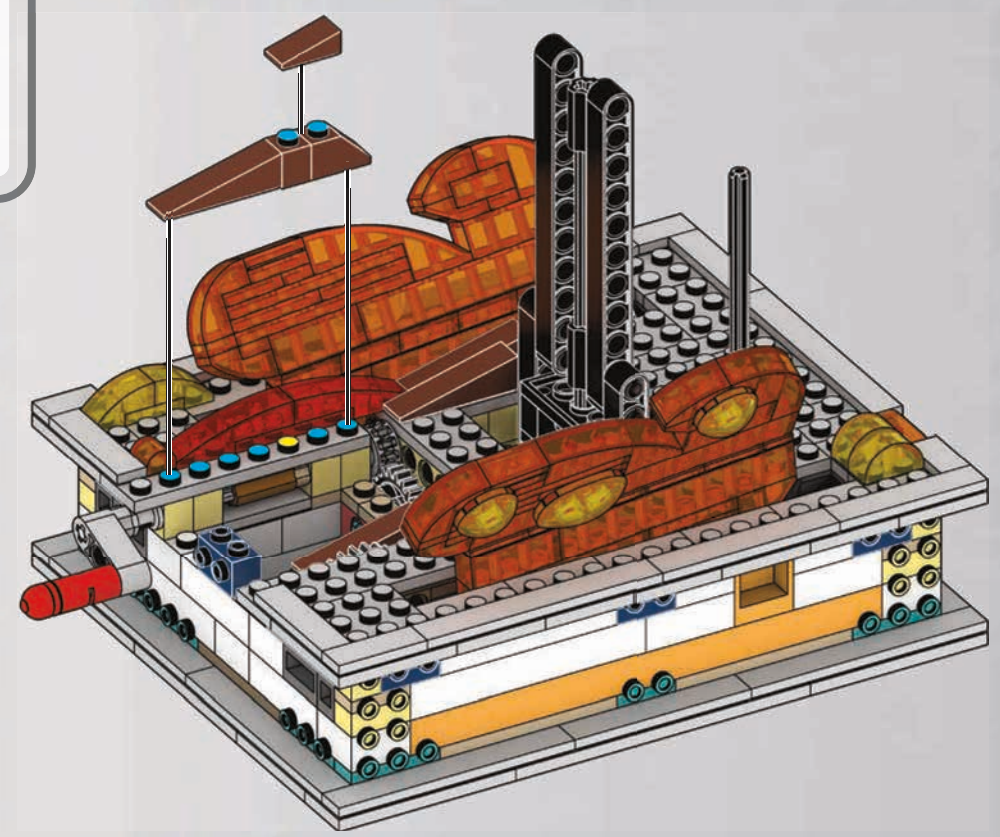

131



1x



1x

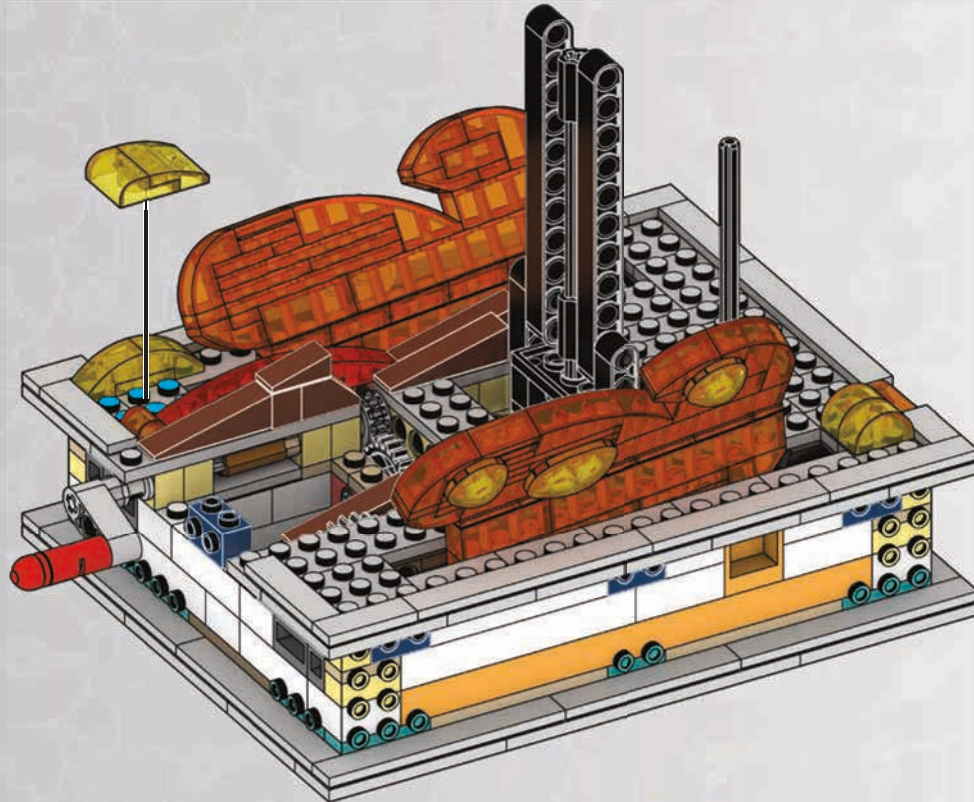

132



1x



1x

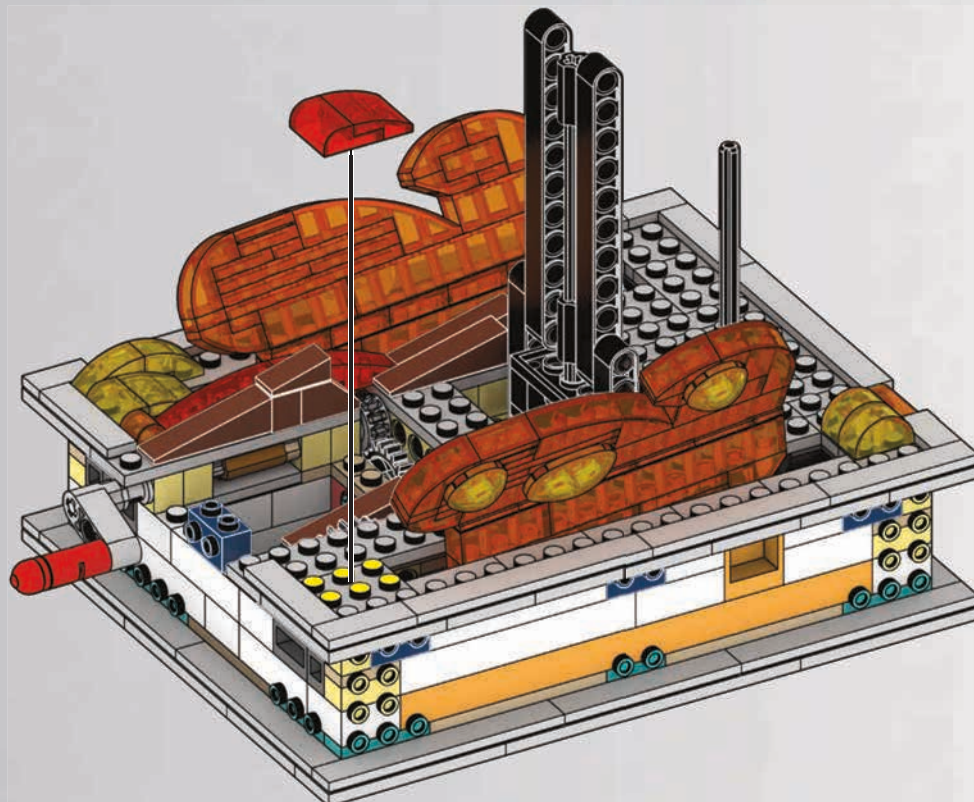
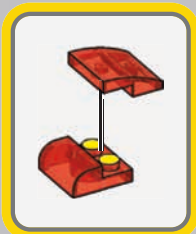

133

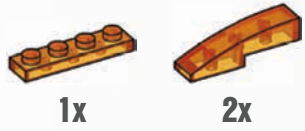

1x

2x

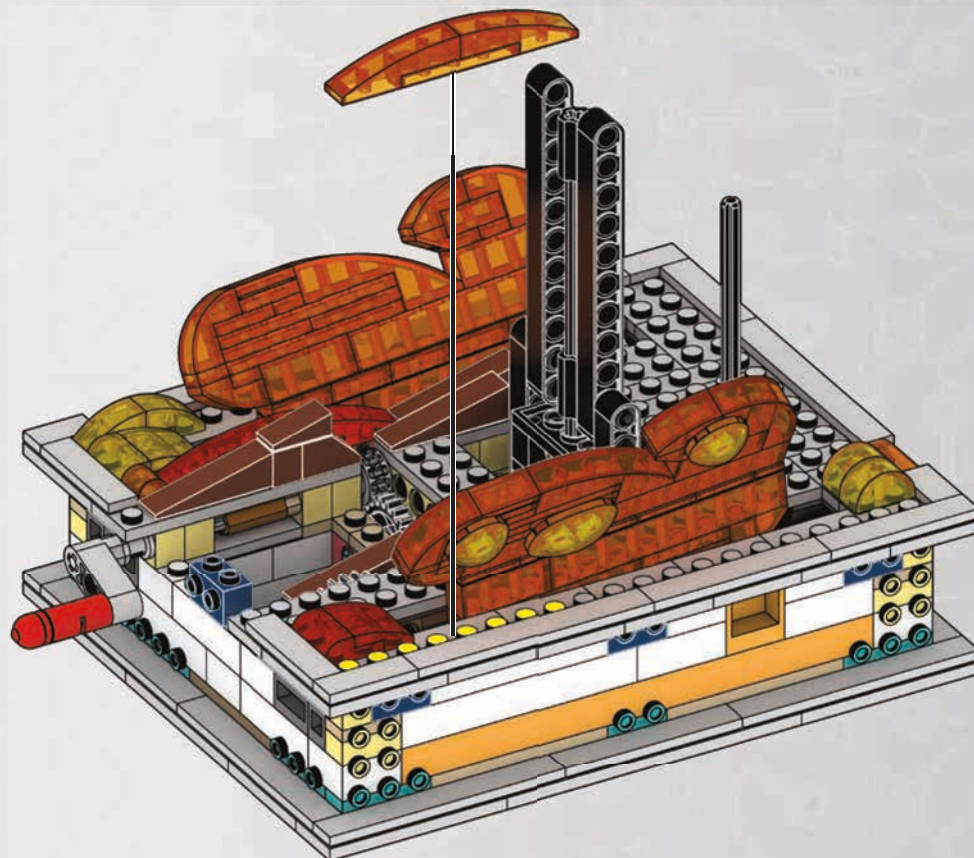
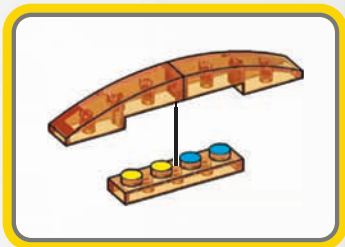

134



1x

2x

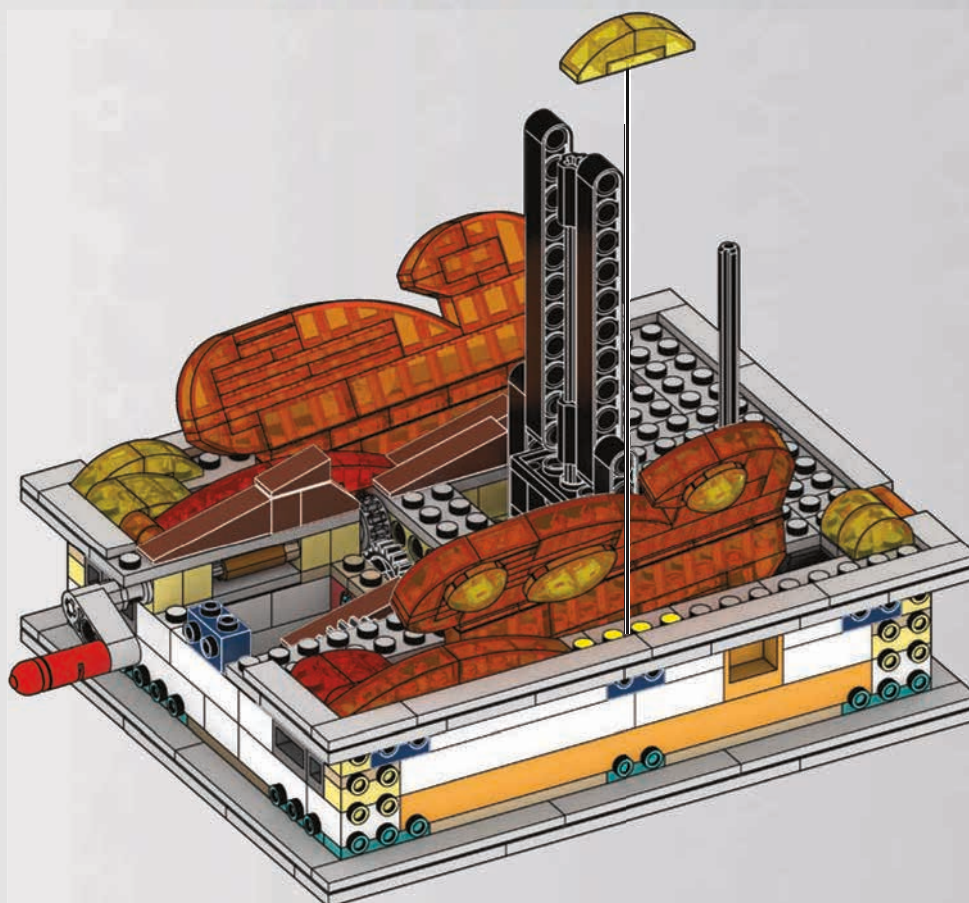

135



1x



2x

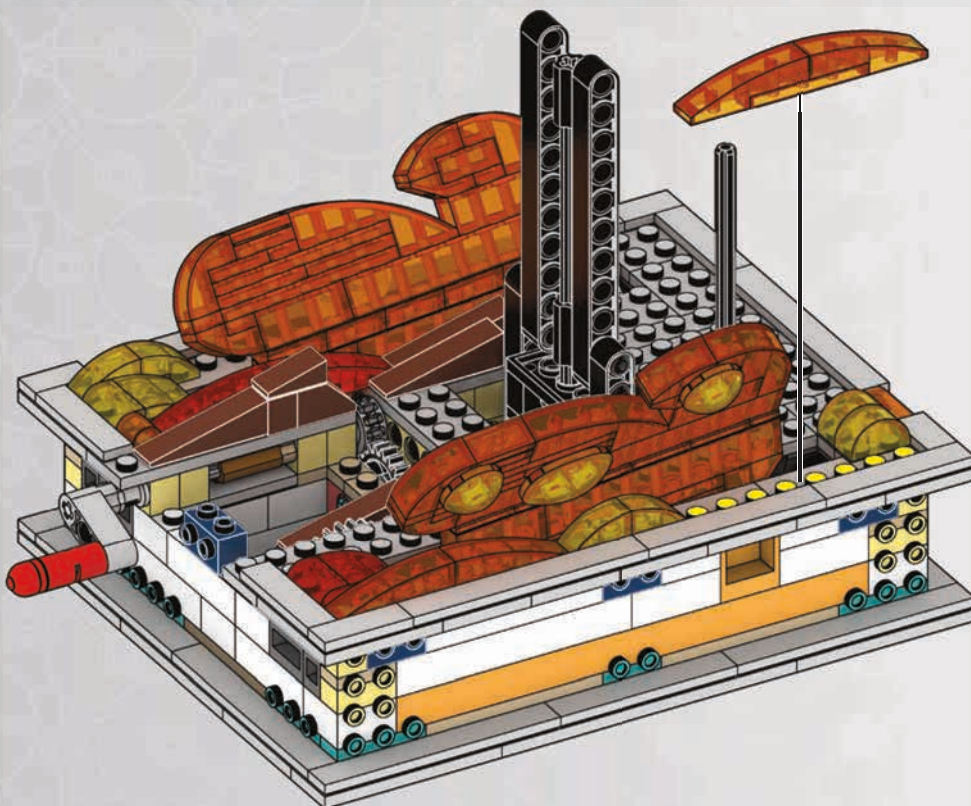
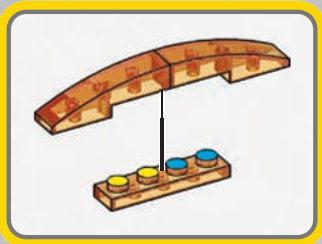

1

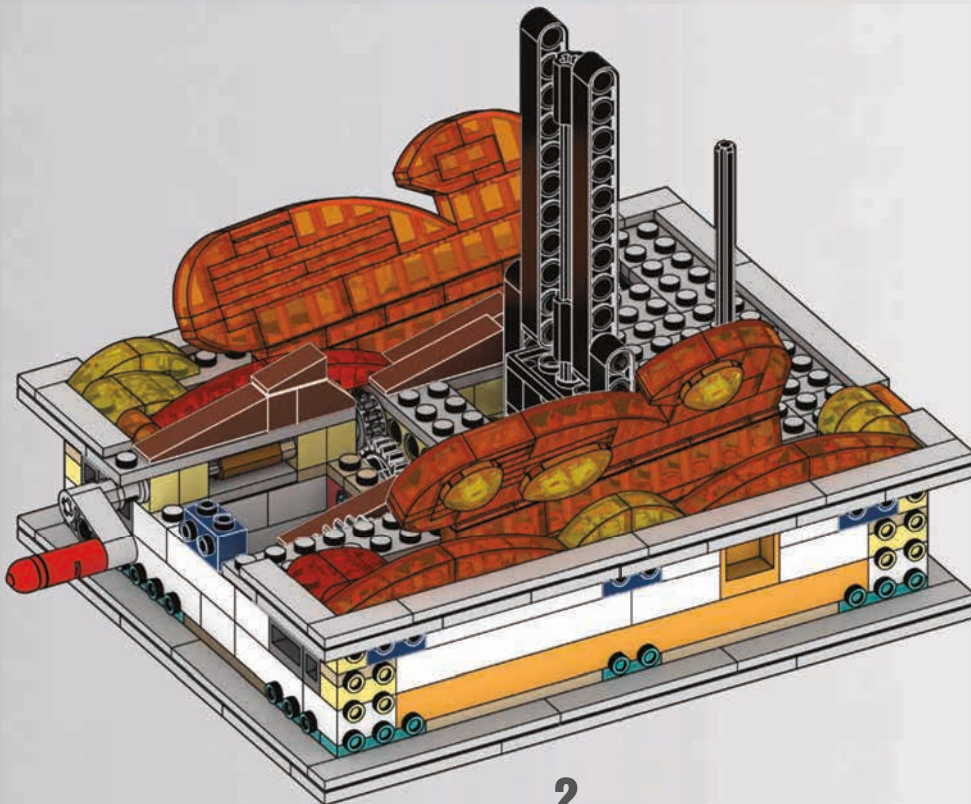

2



136

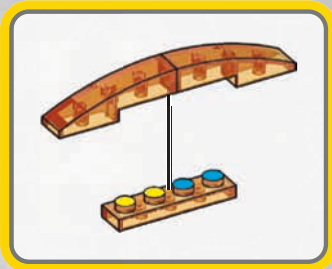
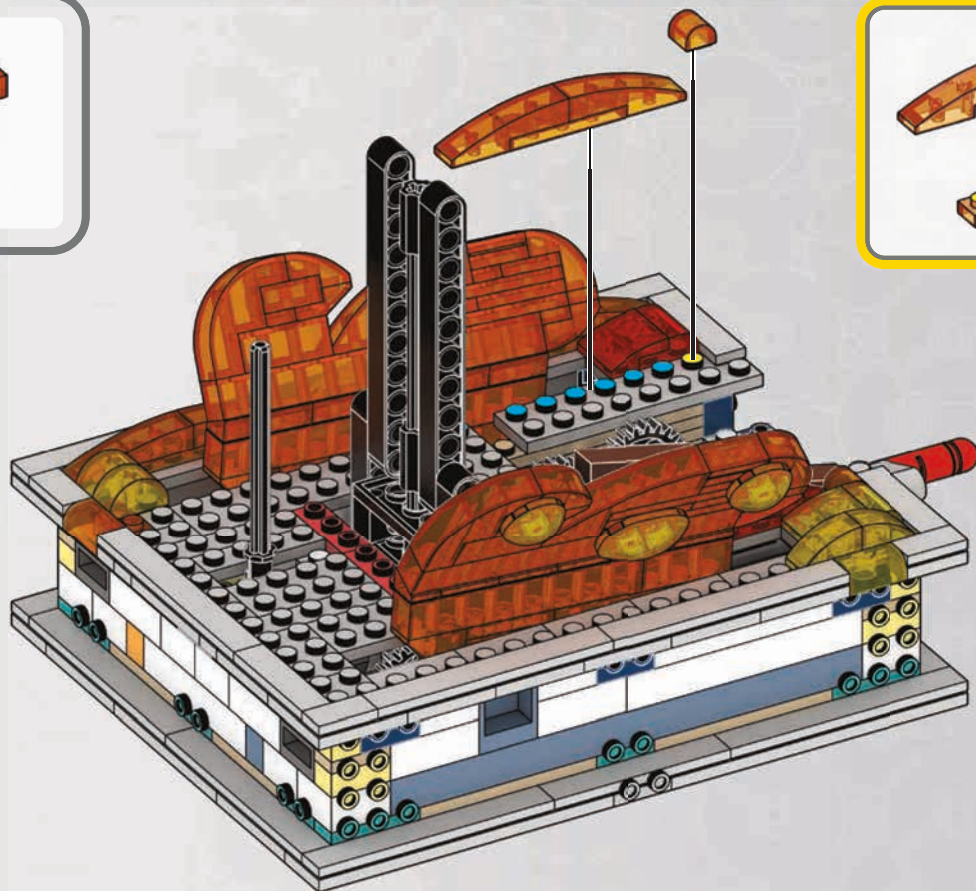

137

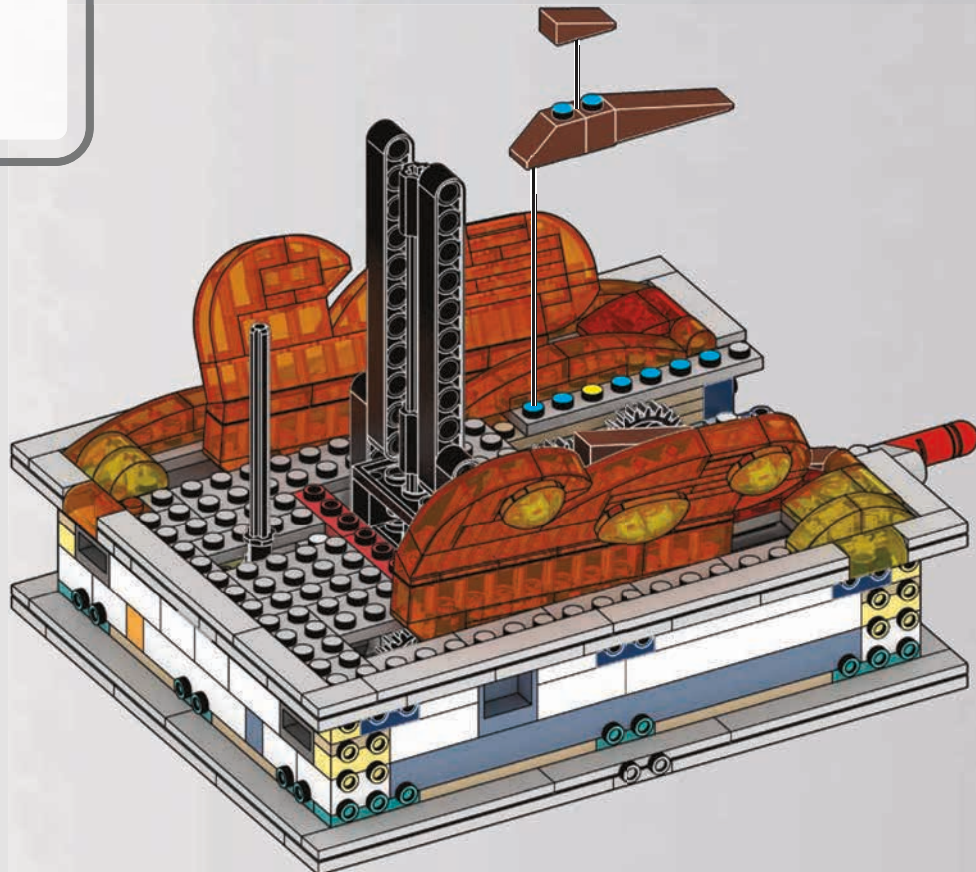
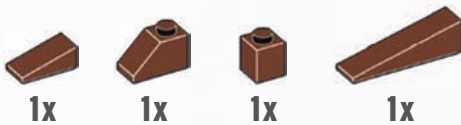



138

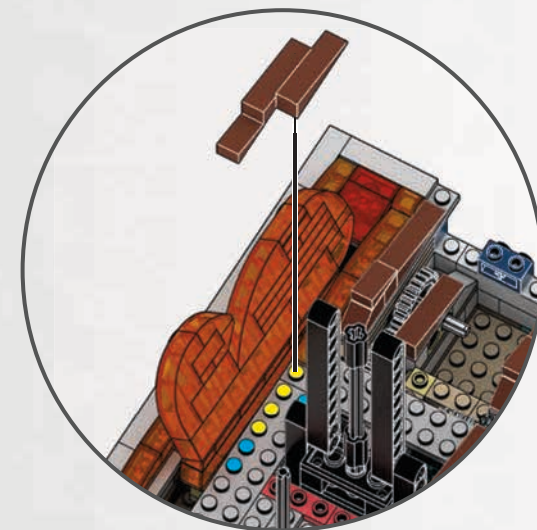
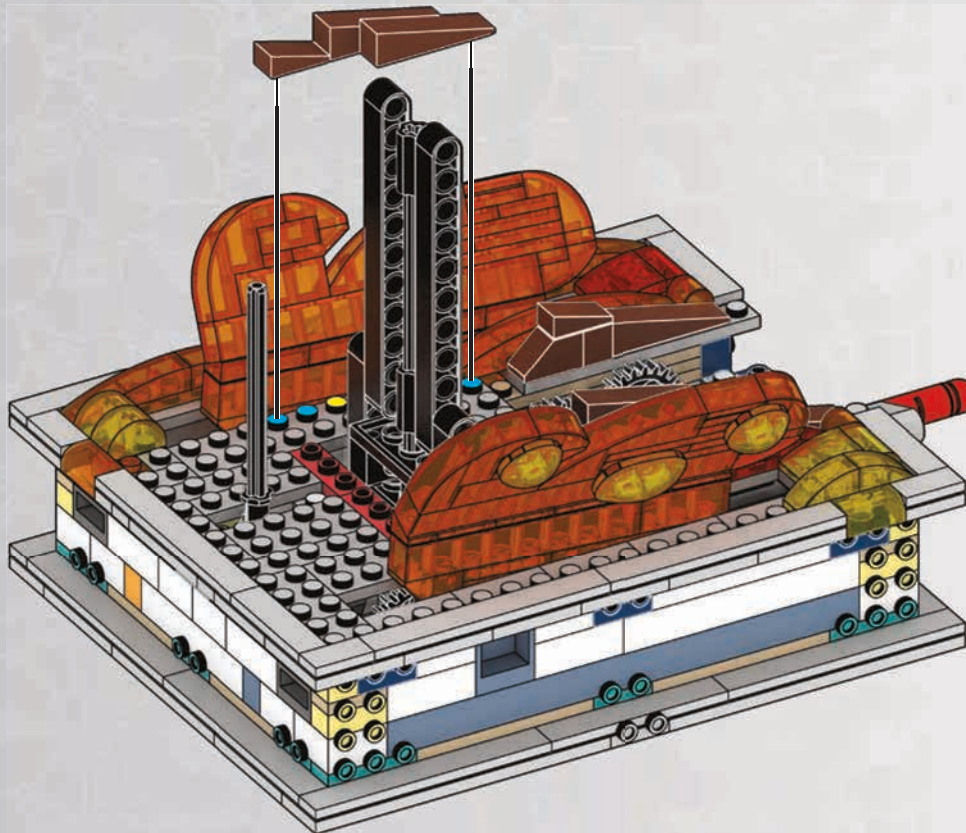
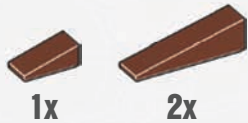

139

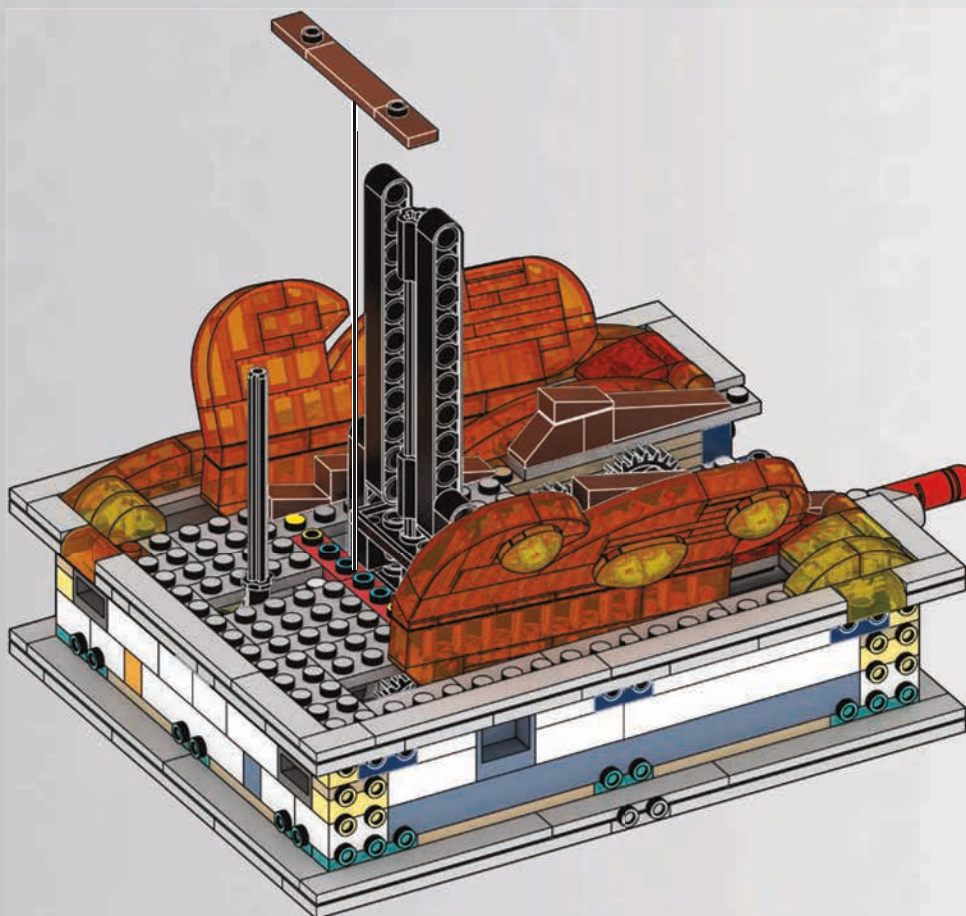

140



2x

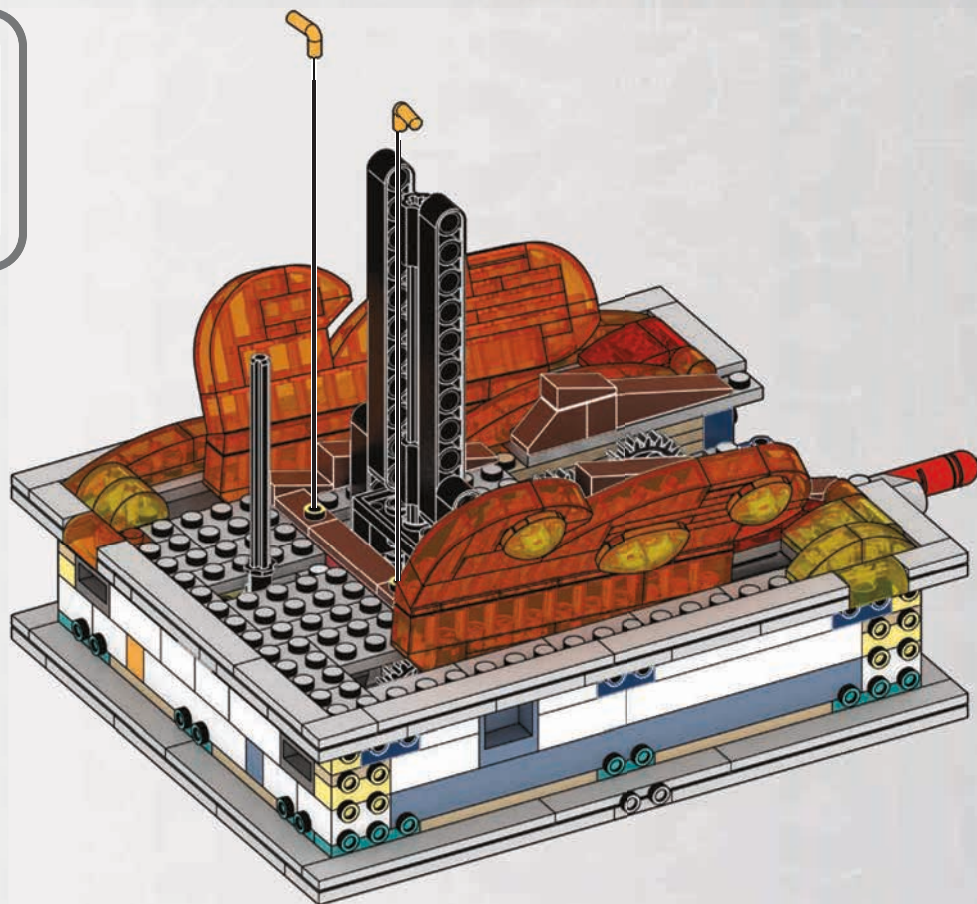

141



1x



1x



1x

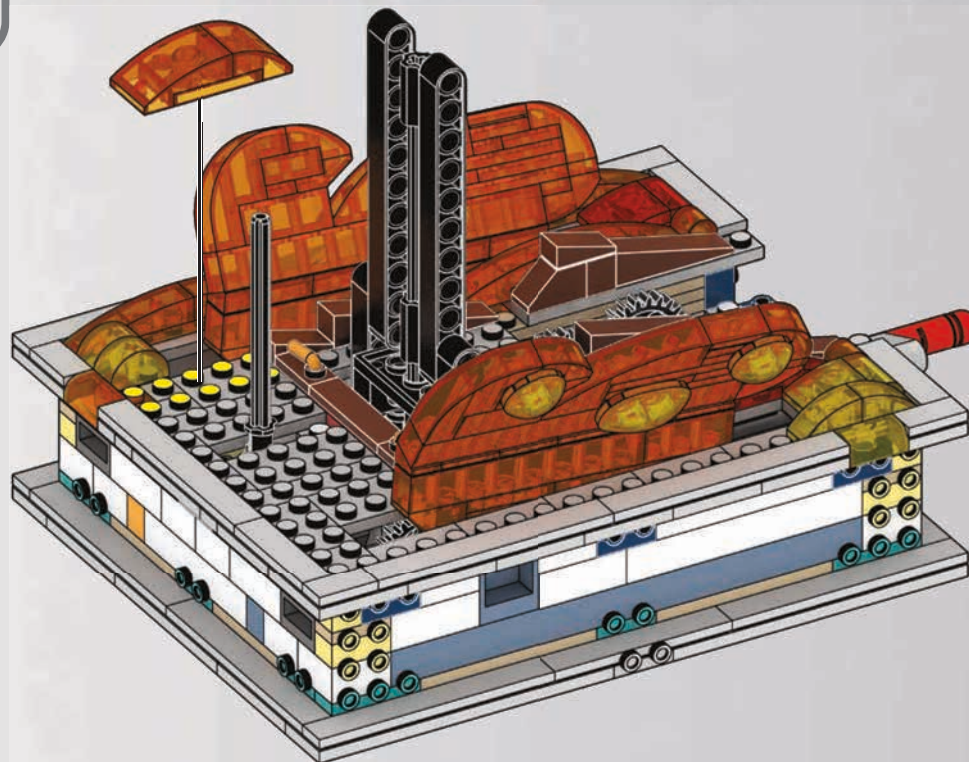

142

- 2x
- 1x
- 1x
- 2x

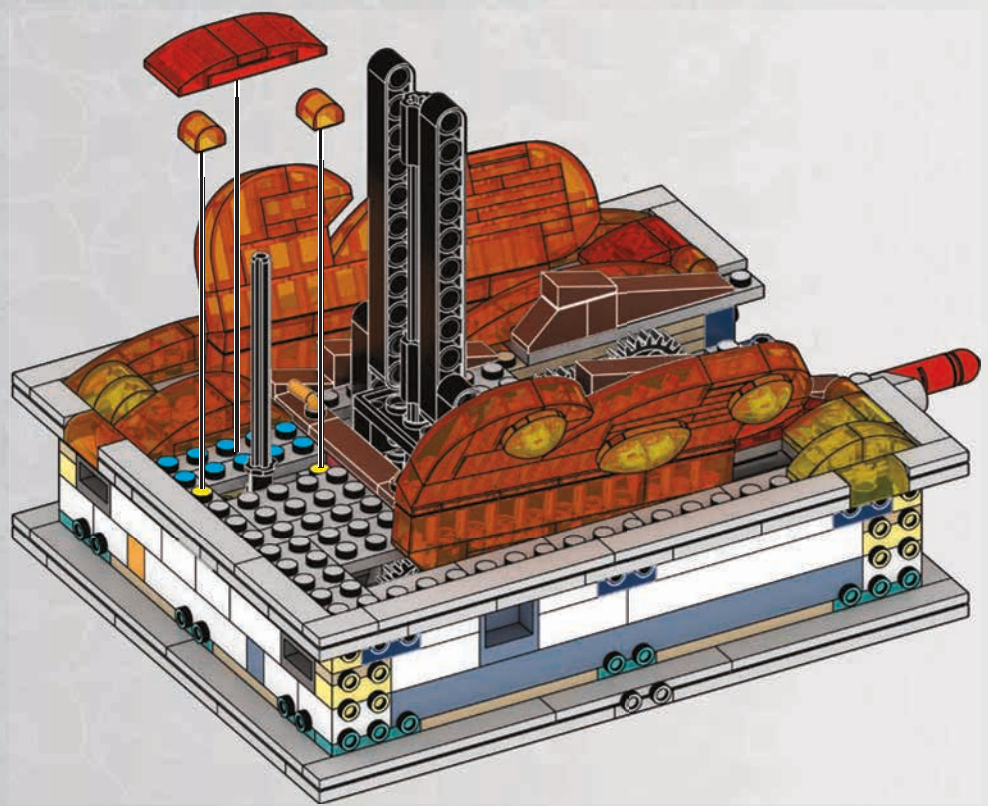

143

- 1x
- 1x
- 1x
- 1x

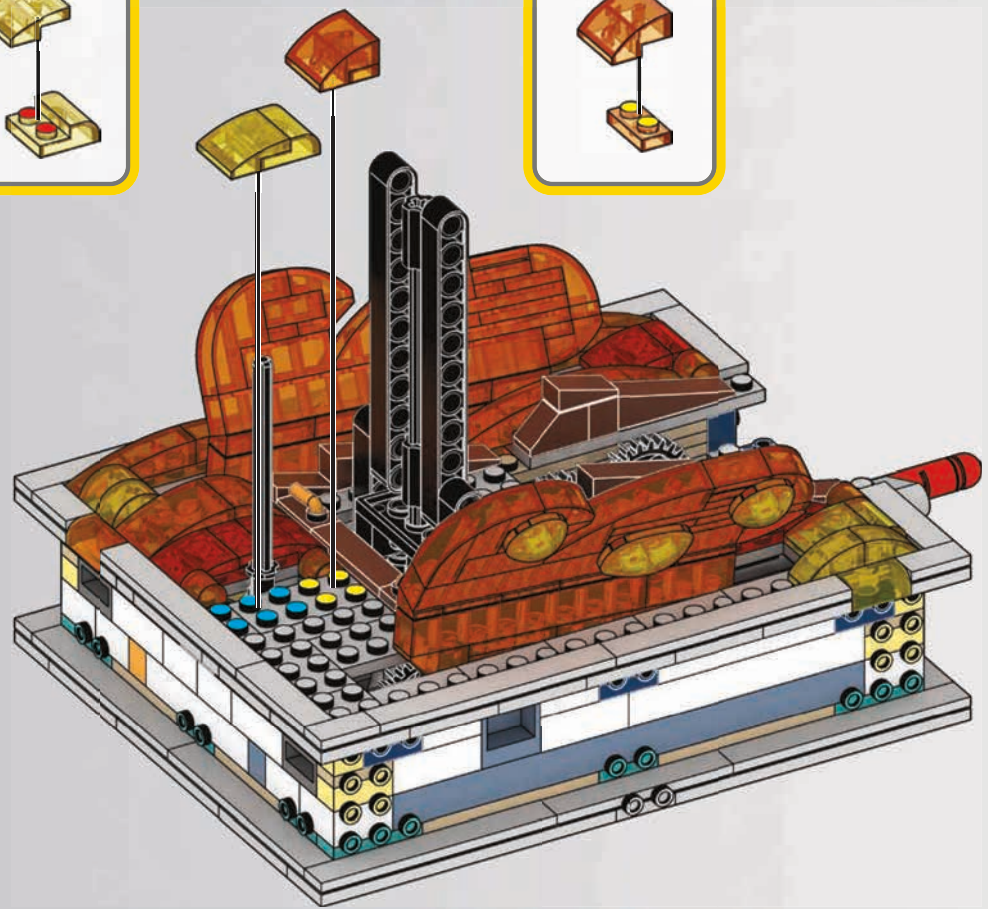

144



1x



1x



1x

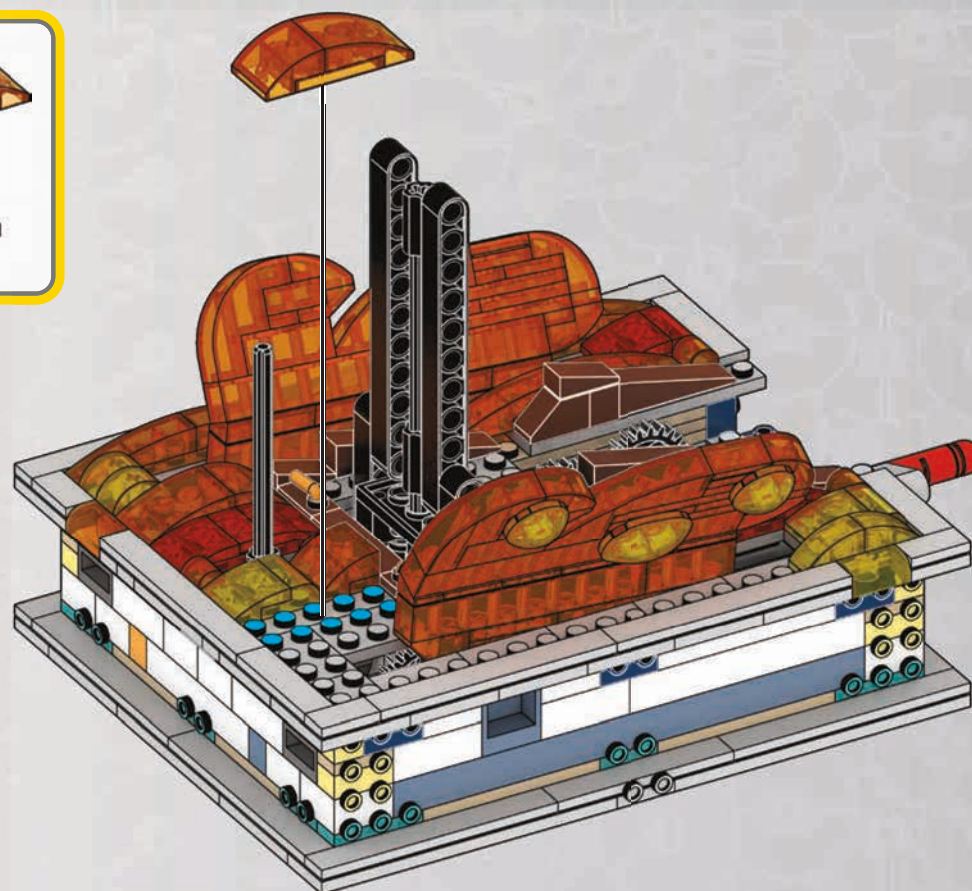

145



1x



1x



2x



1x

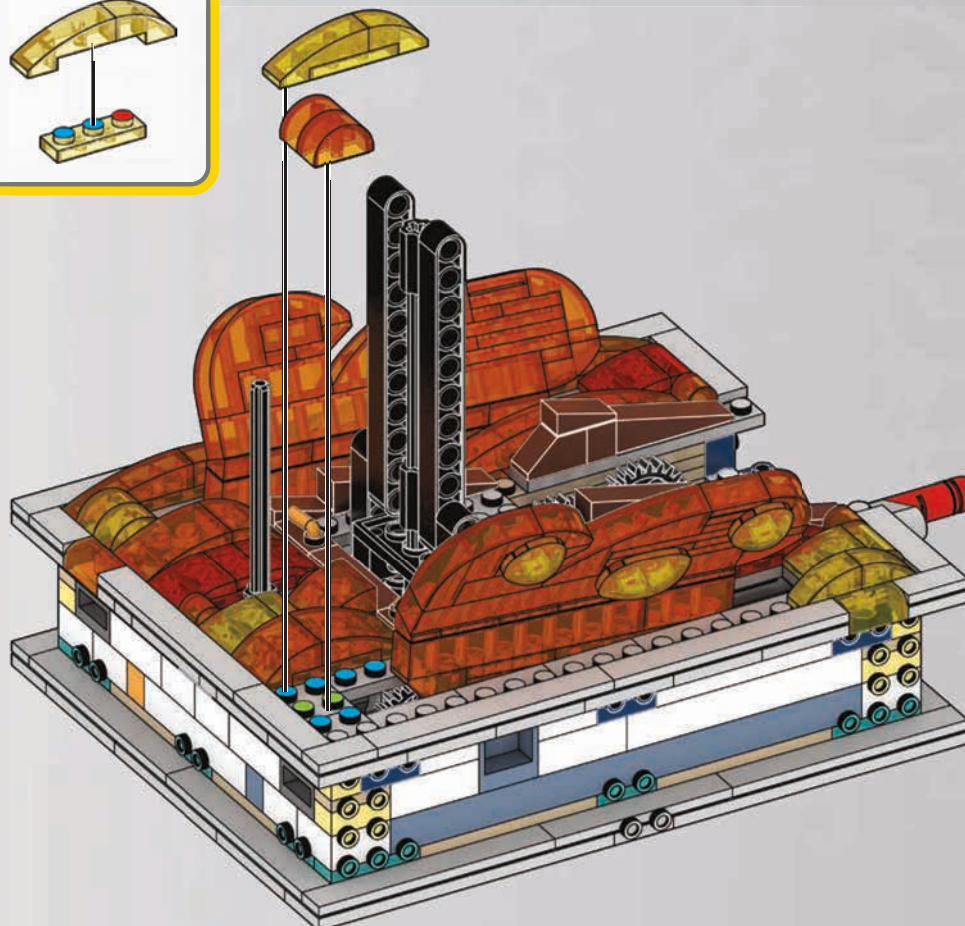

146



1x



2x

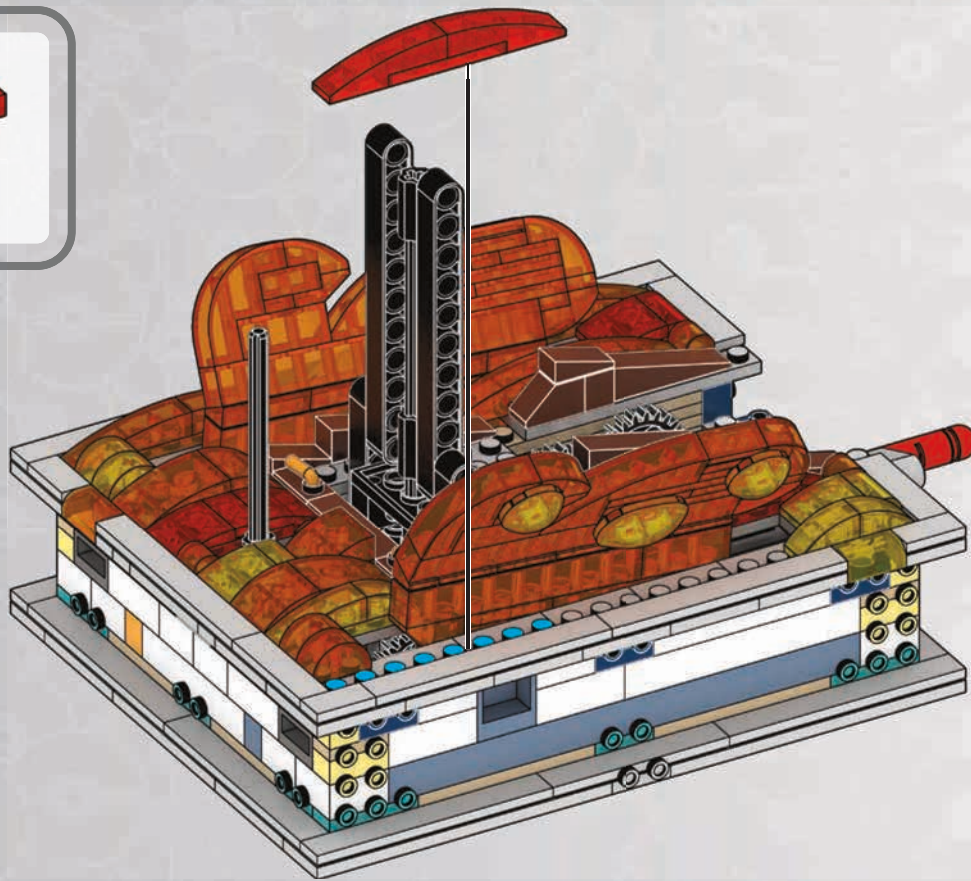
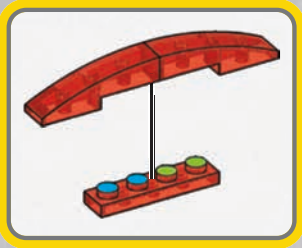

147



1x



2x

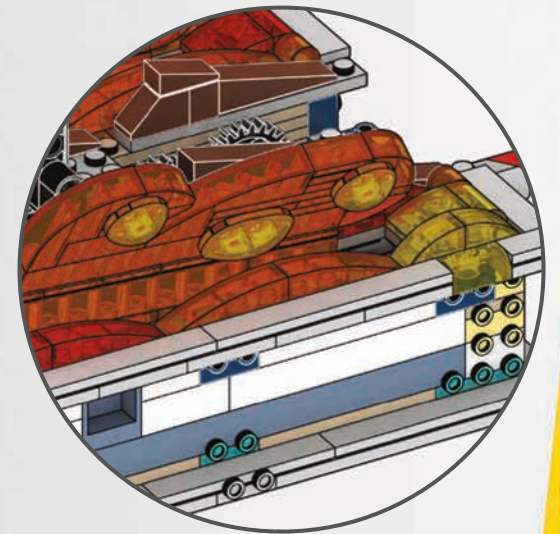
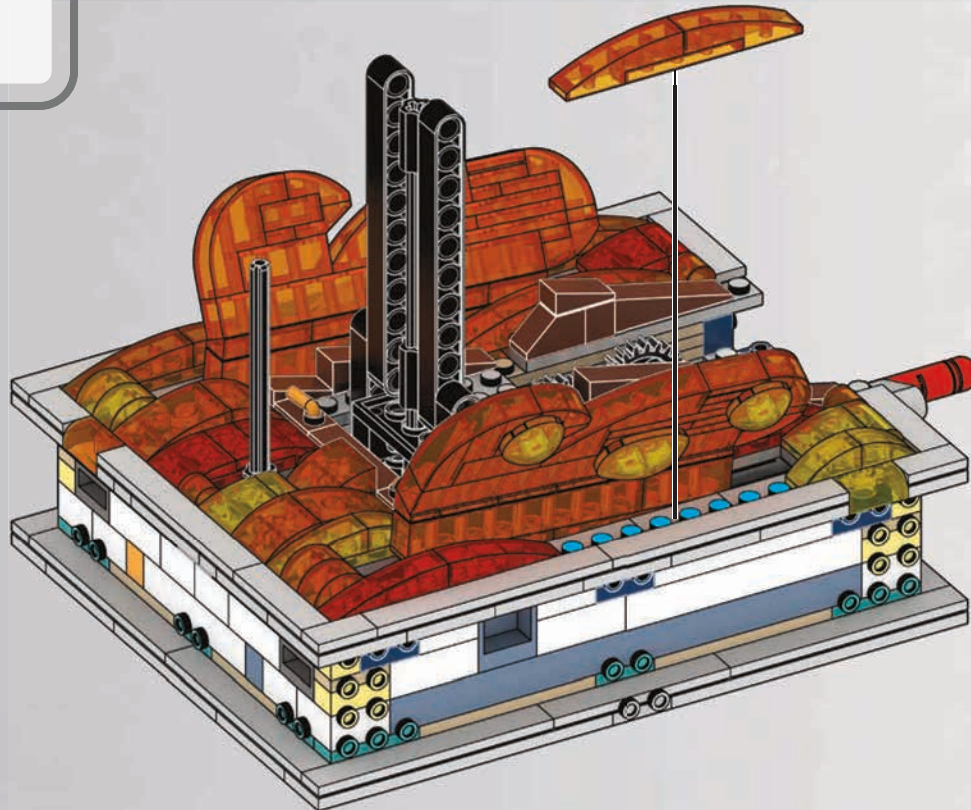
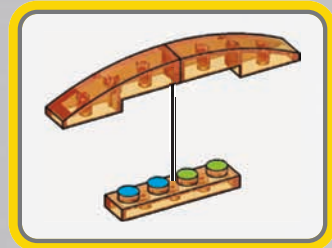

148

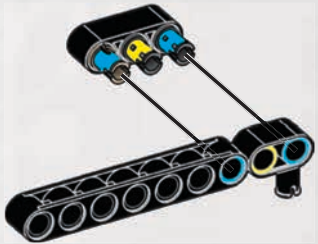
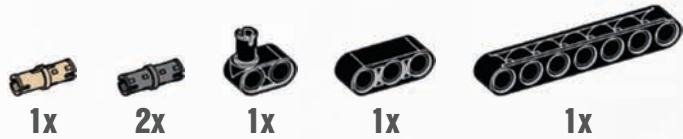

149

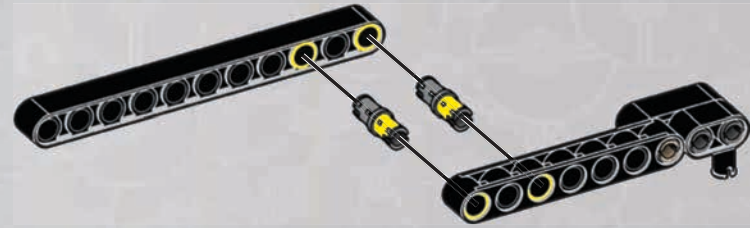

150

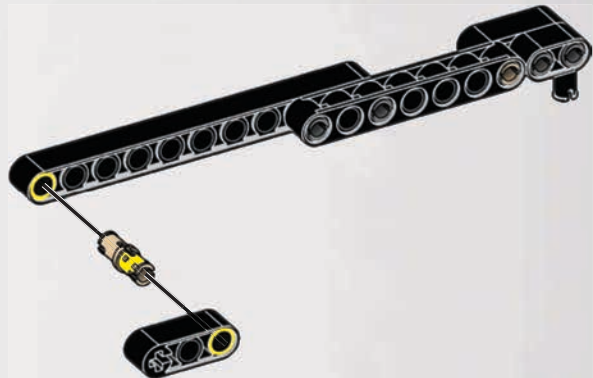

1

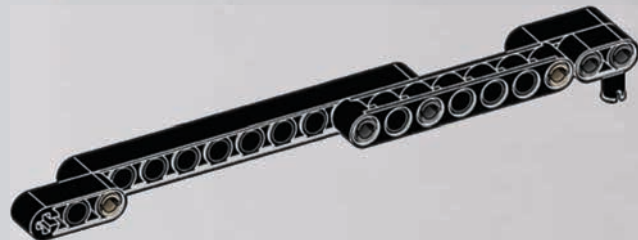

2

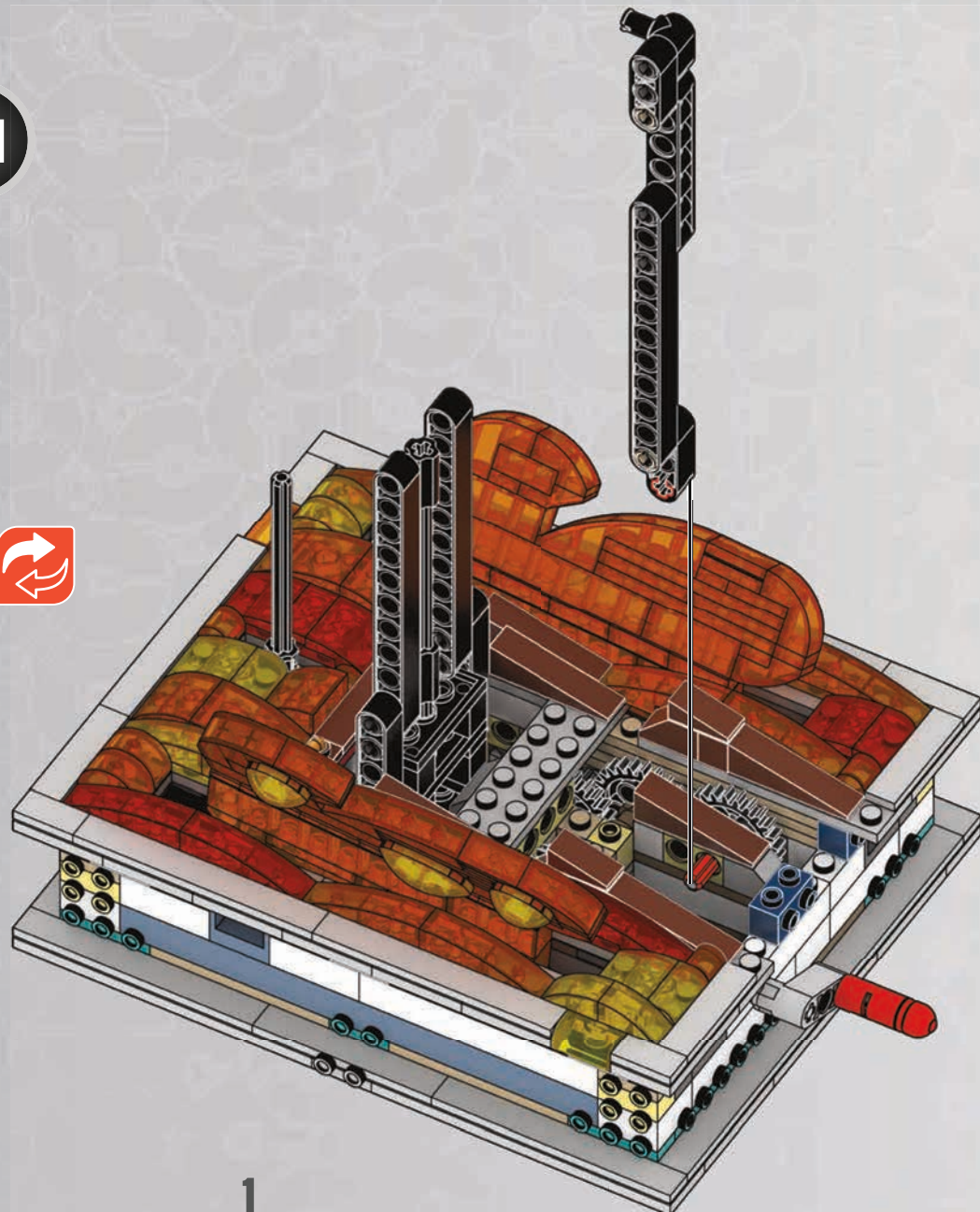

1

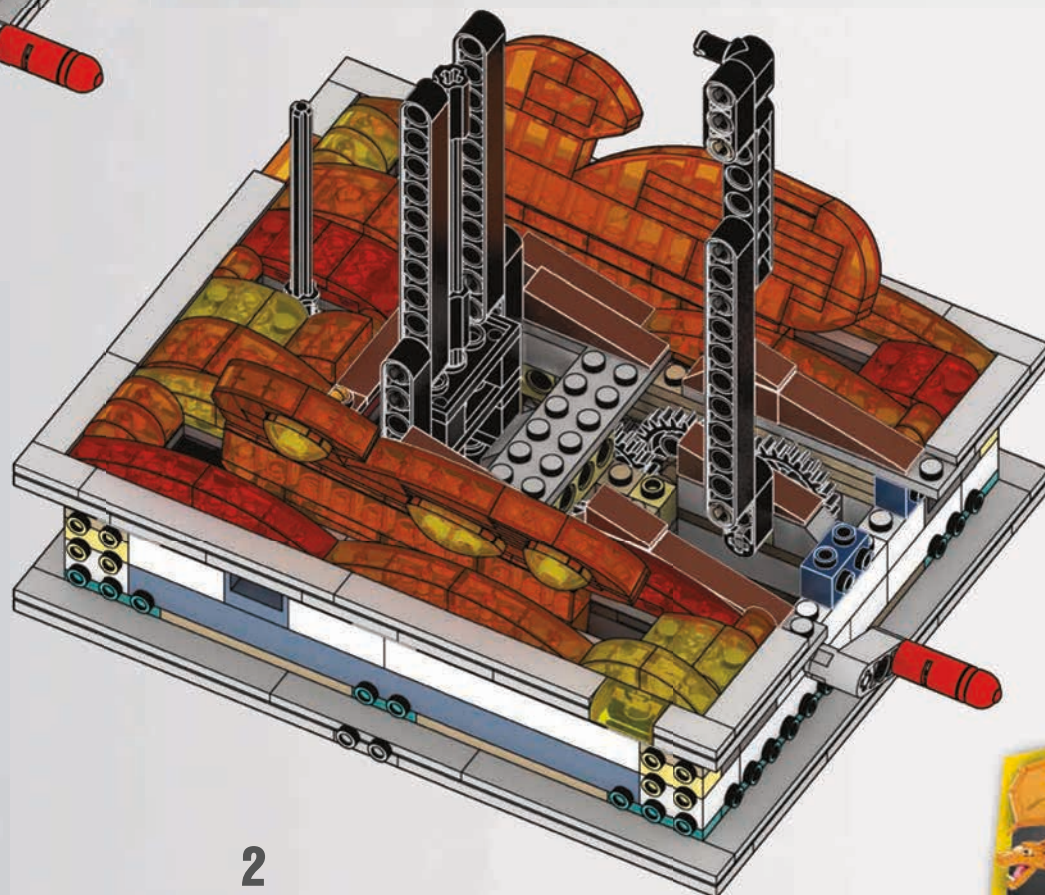

2



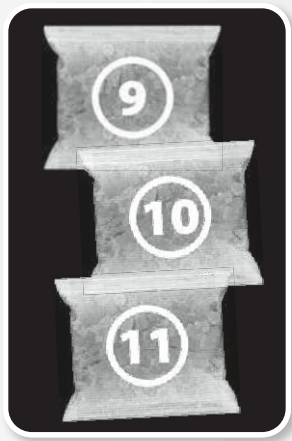

**152**

2x 1x 2x 2x

A parts list for step 152. It includes: 2x black 1x2 Technic brick, 1x black 1x5 Technic brick, 2x yellow 1x2 Technic brick with hole, and 2x black 1x2 Technic brick with hole.

**153**

2x 2x

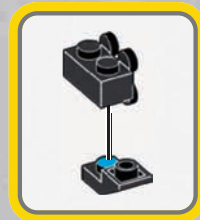
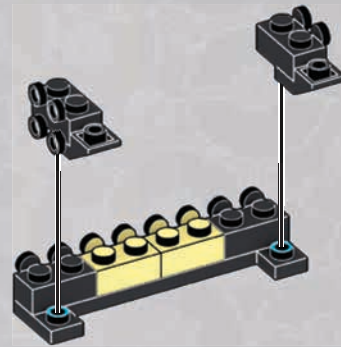
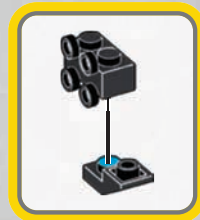
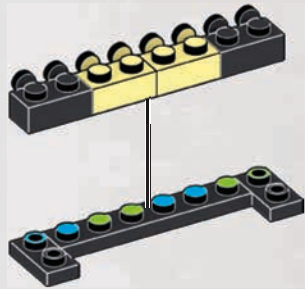
A parts list for step 153. It includes: 2x black 1x2 Technic brick with hole, and 2x black 1x2 Technic brick with hole.

**154**

2x 4x 2x 1x

A parts list for step 154. It includes: 2x grey Technic axle, 4x yellow 1x2 Technic brick with hole, 2x black 1x2 Technic brick with hole, and 1x black 1x5 Technic brick.

**155**

1x 2x

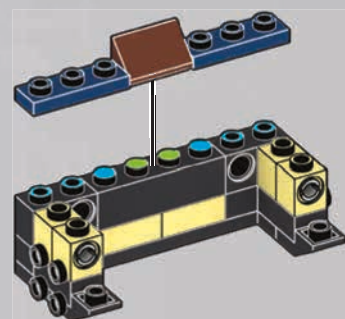
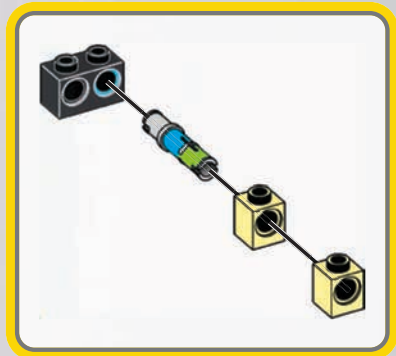
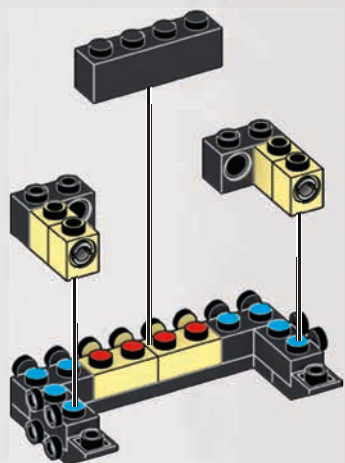
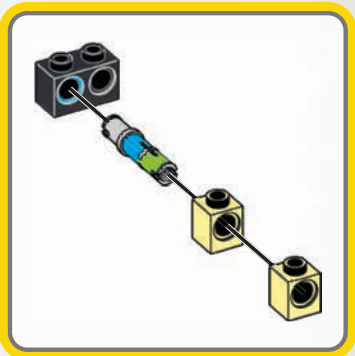
A parts list for step 155. It includes: 1x brown 1x2 Technic brick, and 2x blue 1x2 Technic brick.



156

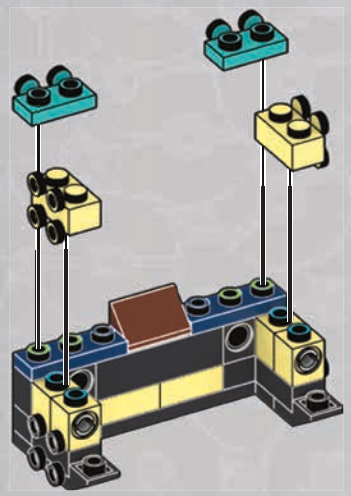

1

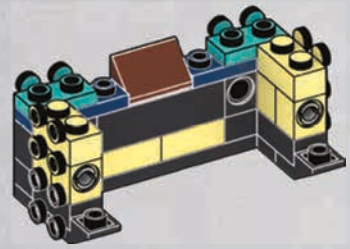

2

157

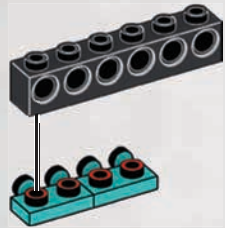

158

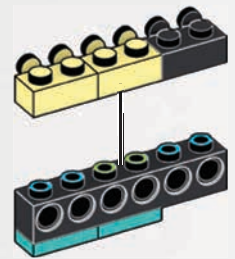
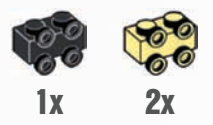

159

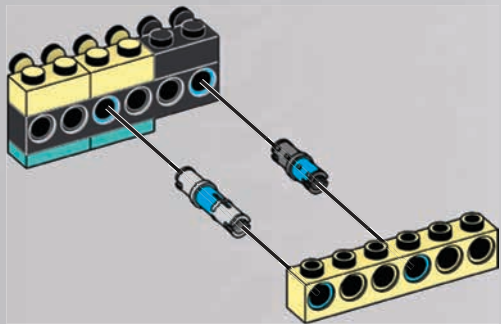

160

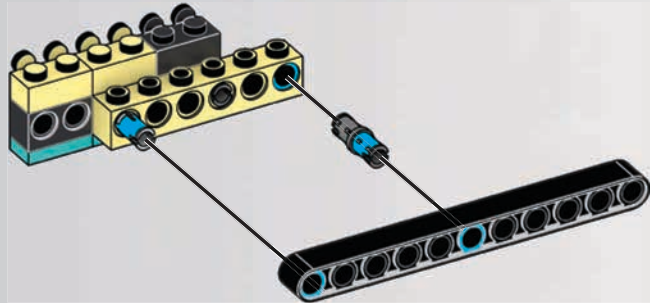

1



2



161



2x 1x



162



2x 1x

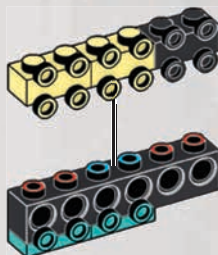

163



1x 1x 1x

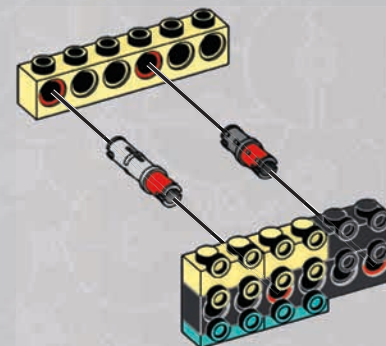

164



1x 1x

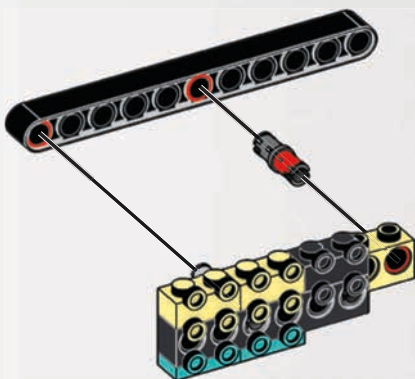

1

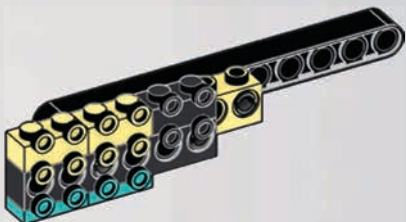

2

165



1x 1x

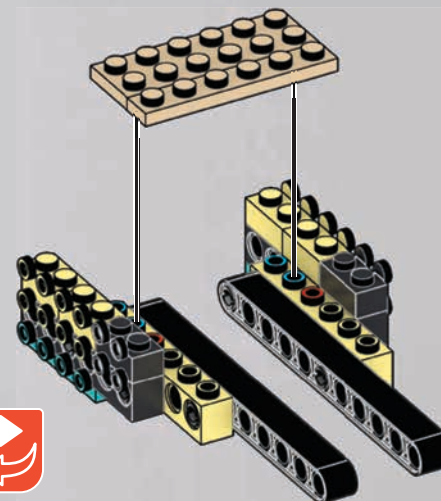

166



2x

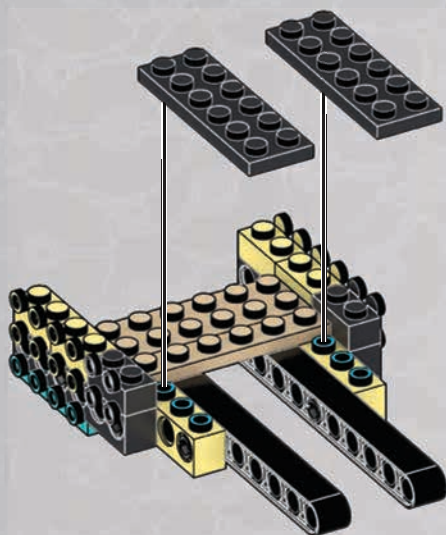

167



2x

1x

2x

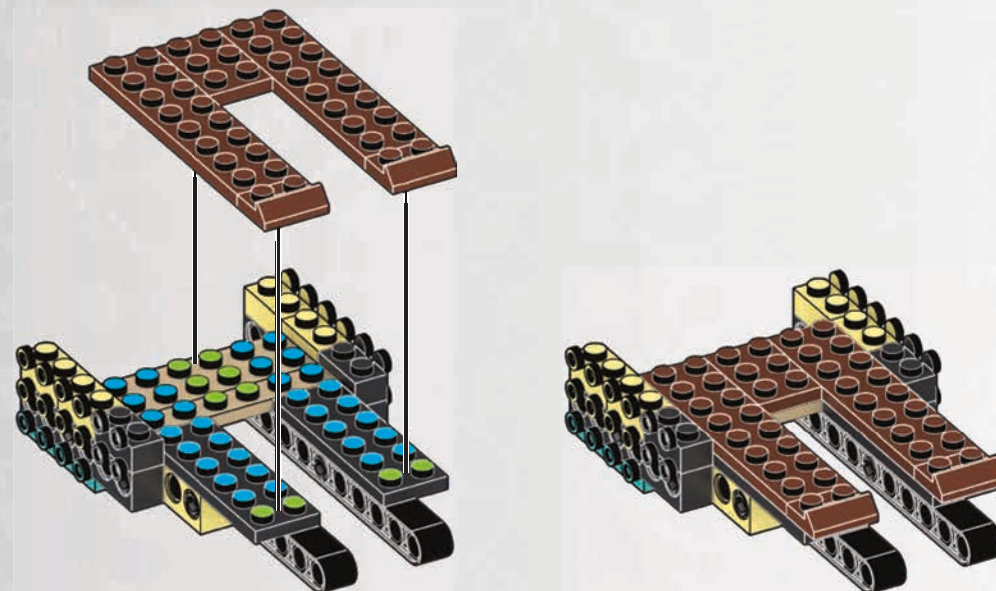

1

2

168

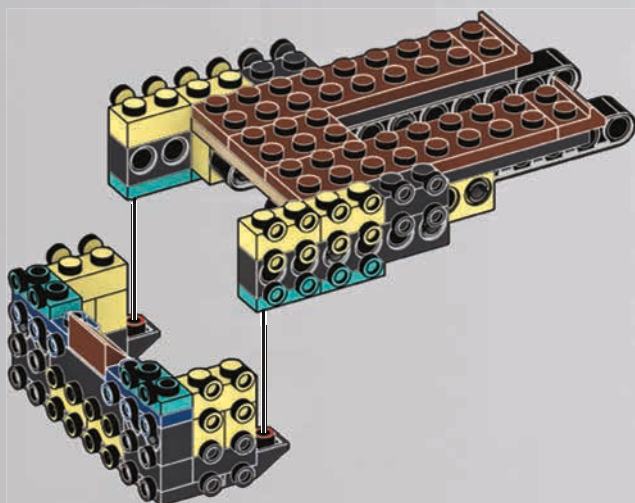

169



1x

1x

2x

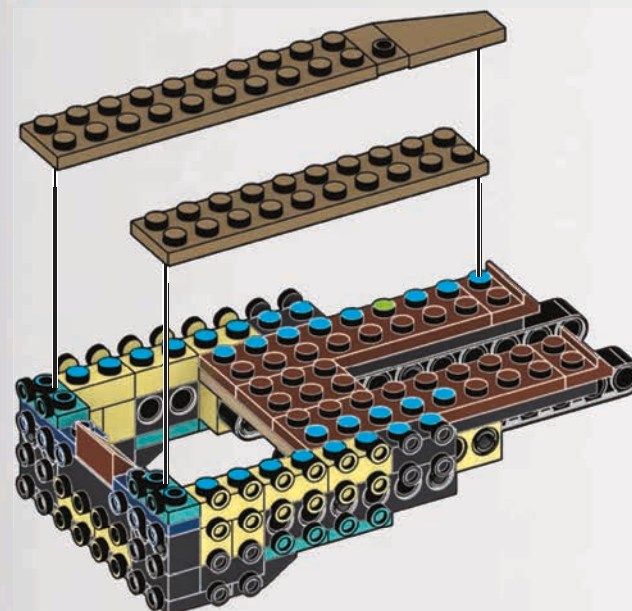

170

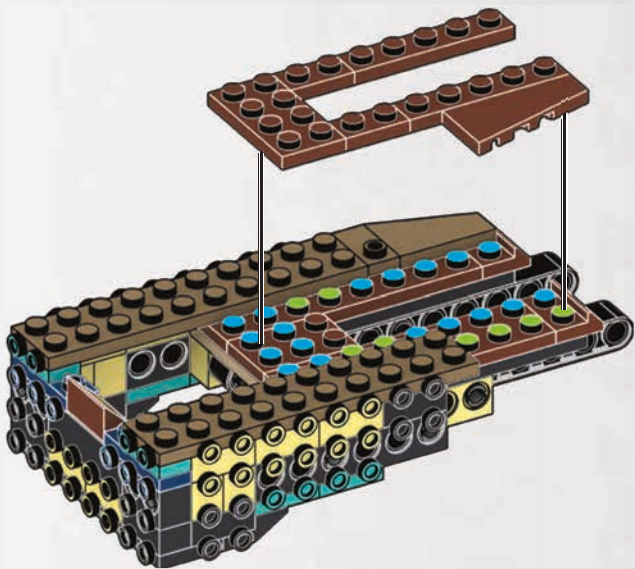

171

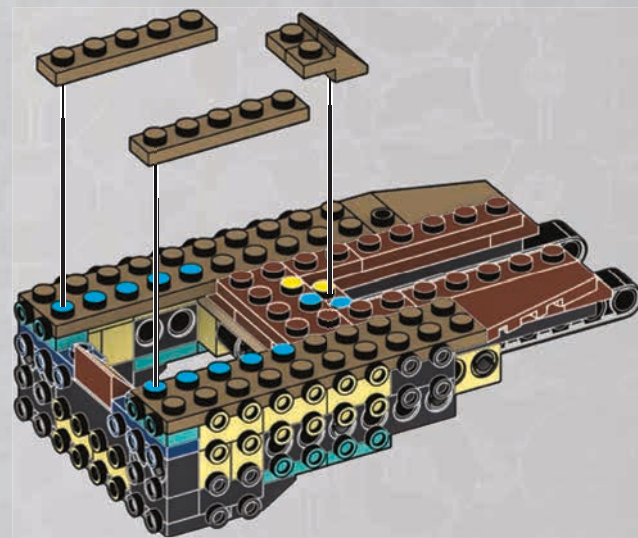

172

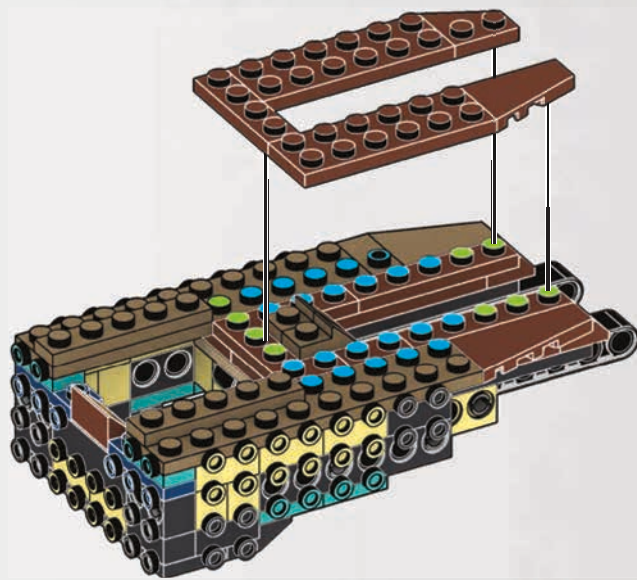

173

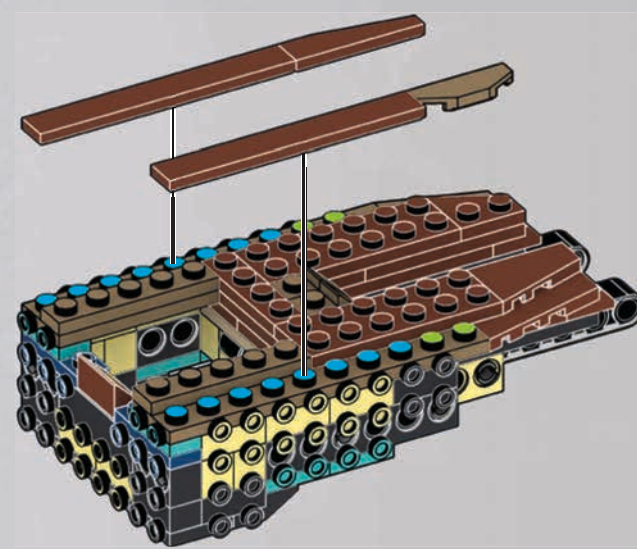

174

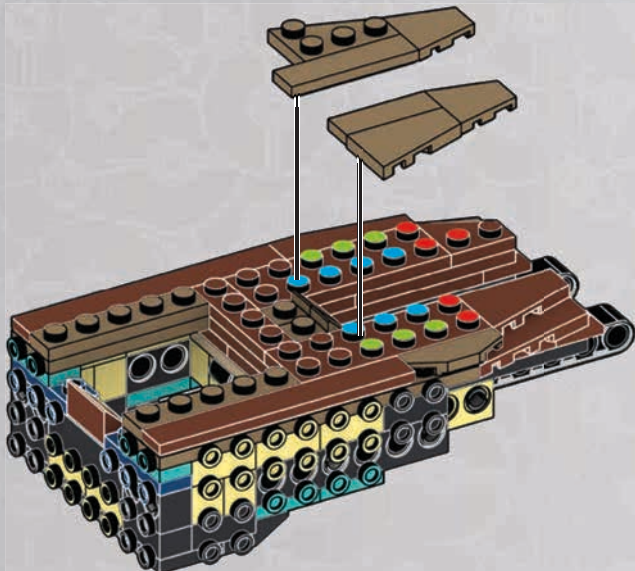
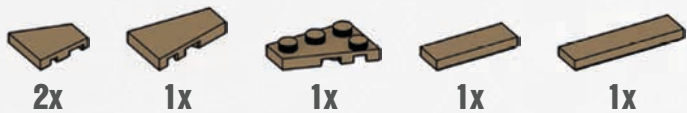

175

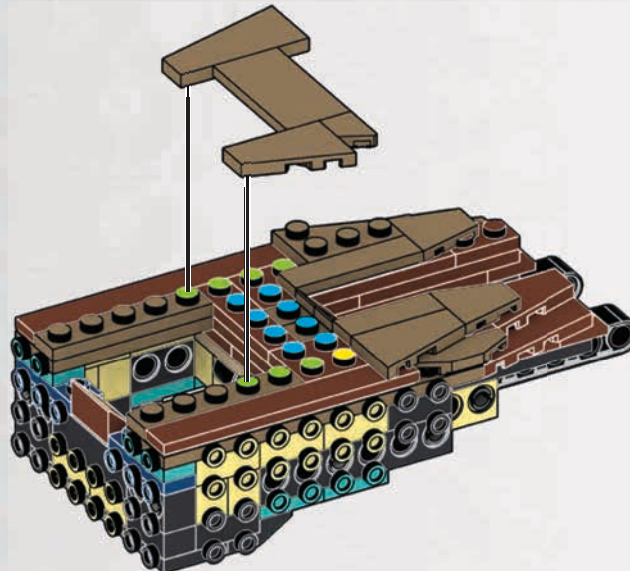
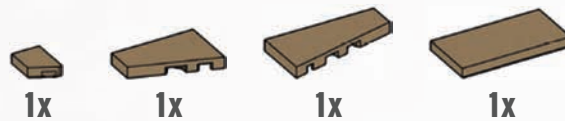

176

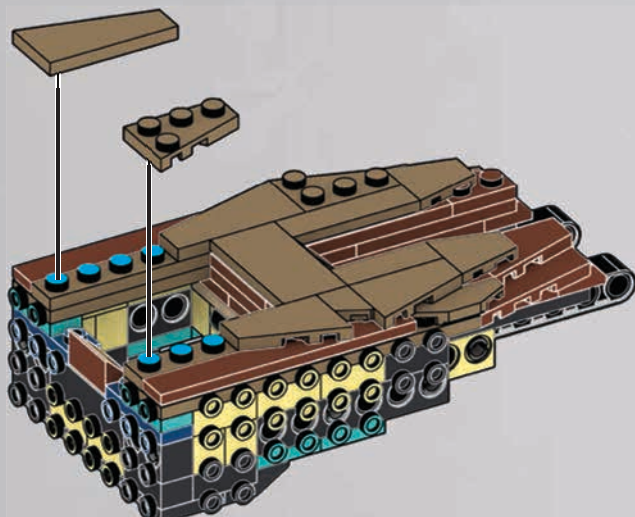
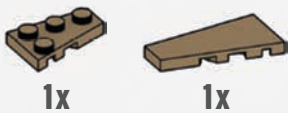

177

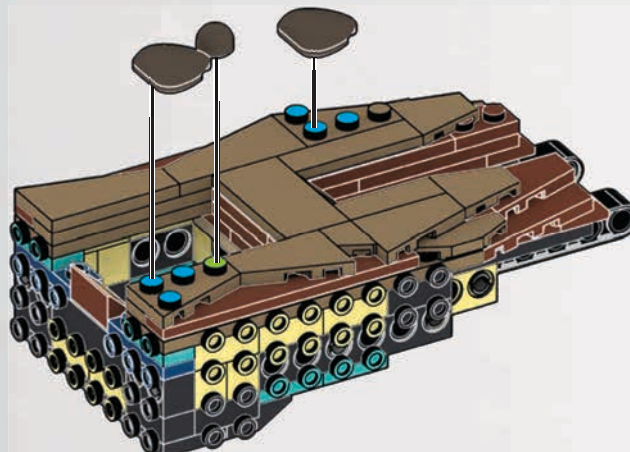

178



2x

1x

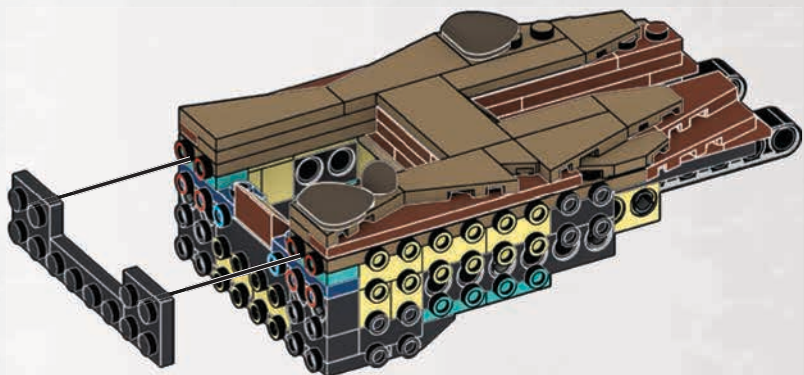

179



2x

1x

1x

1x

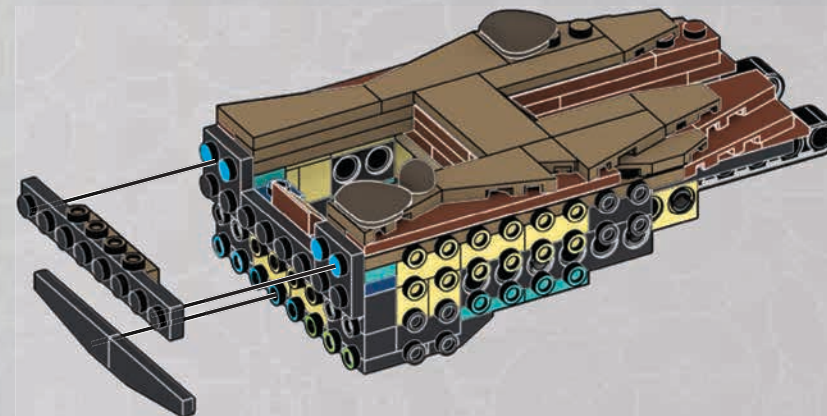
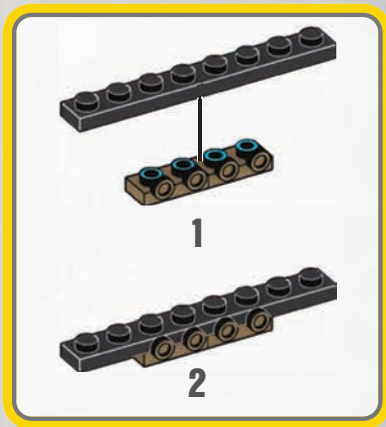

180



1x

1x

1x

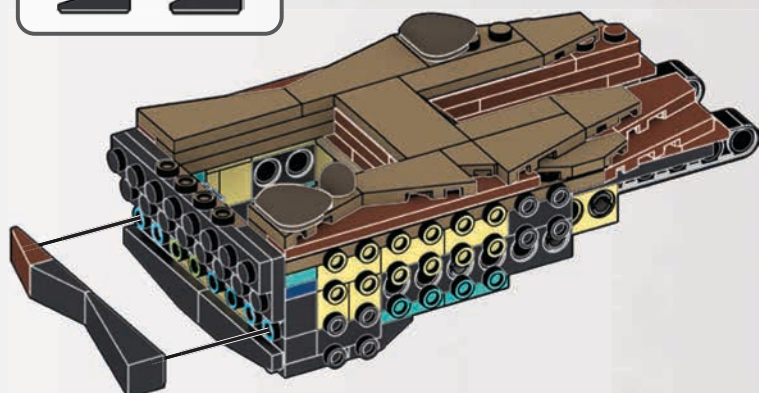

181



2x

1x

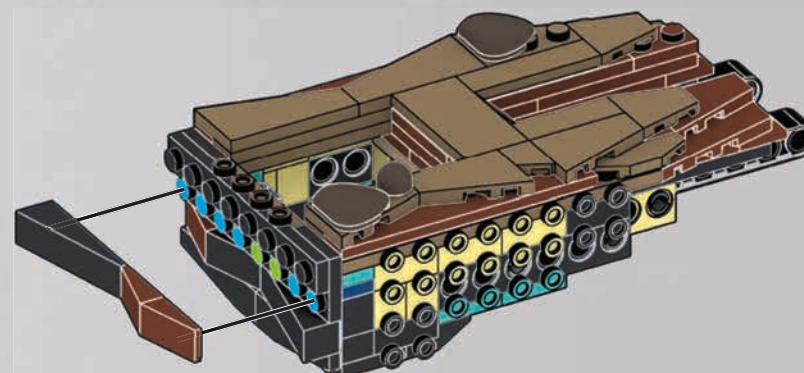

182

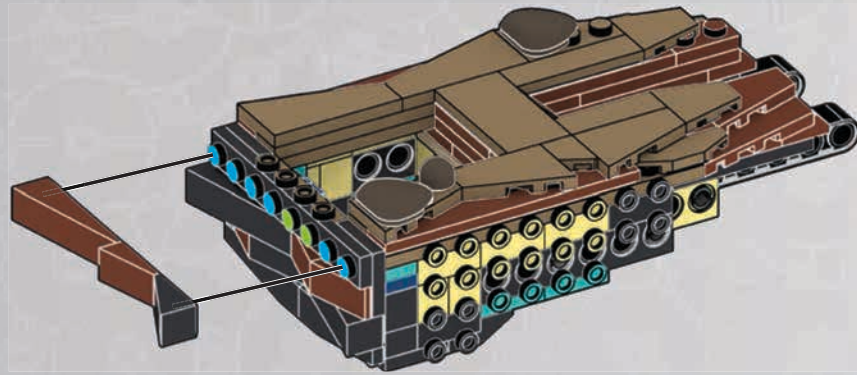
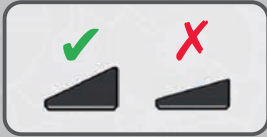

183

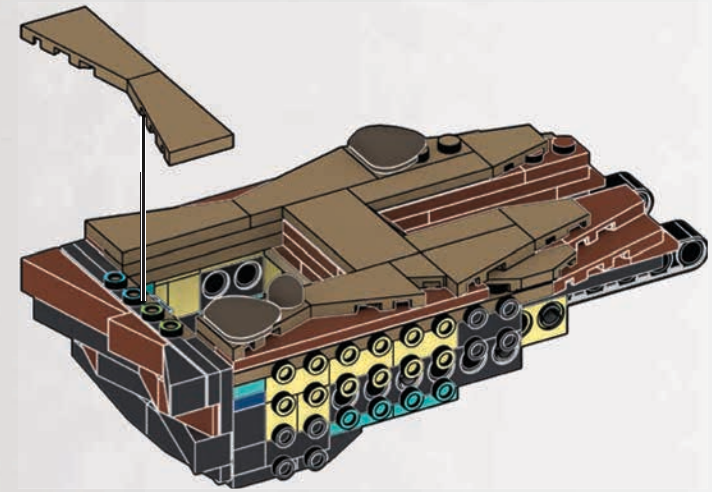

184

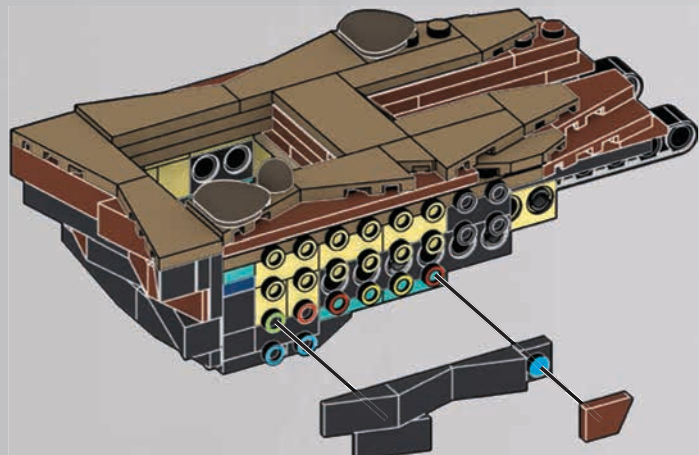

185

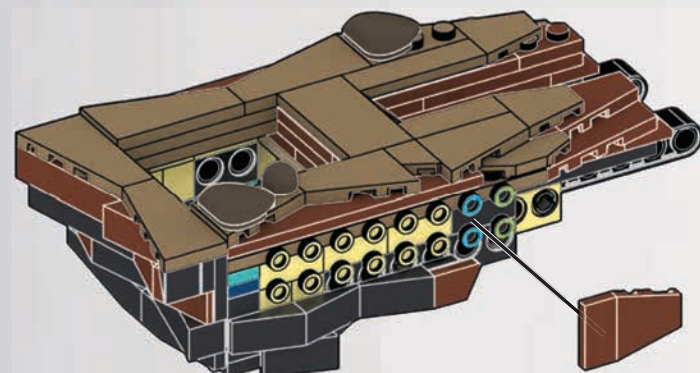

186

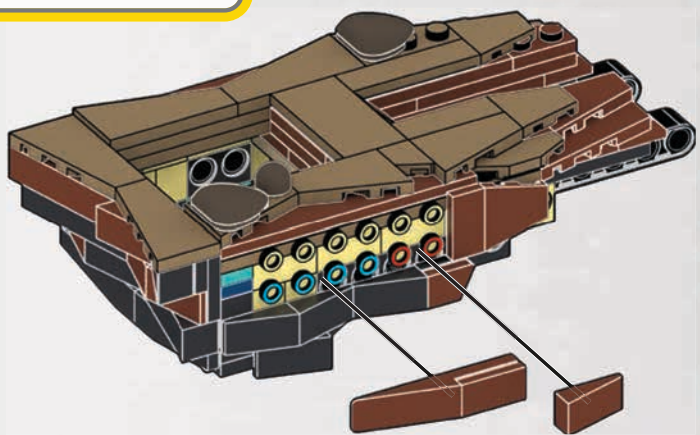
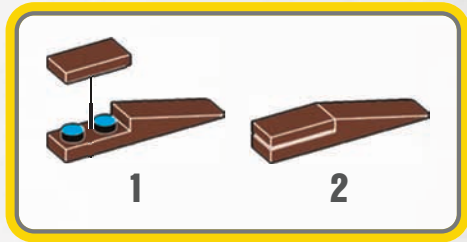

187

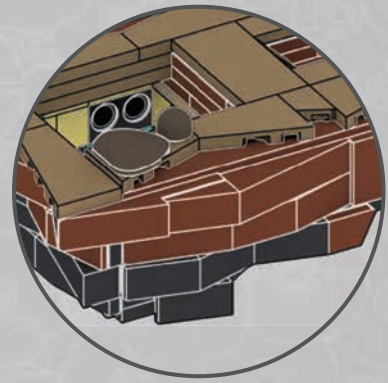
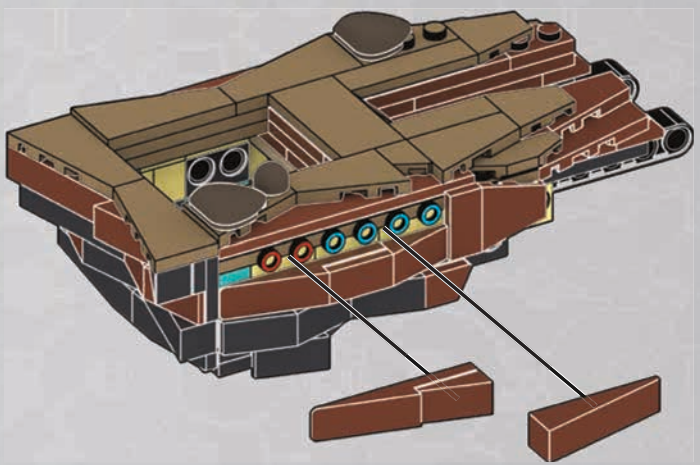
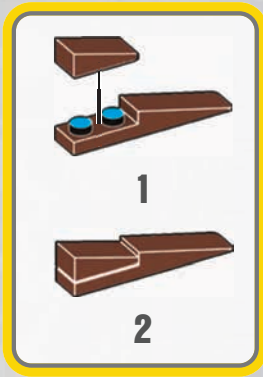

188

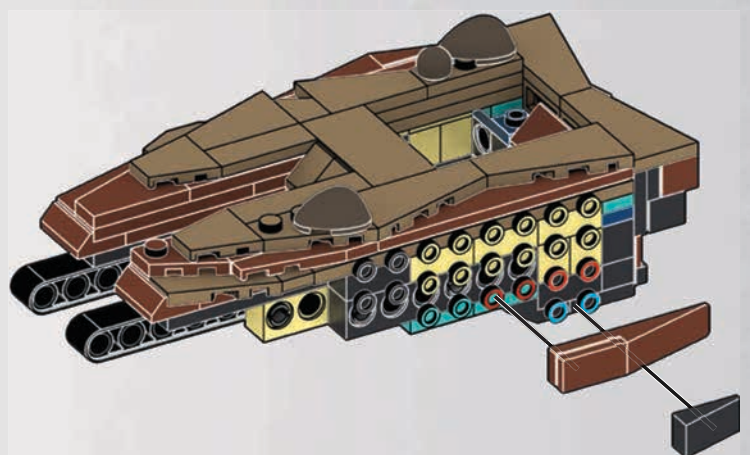
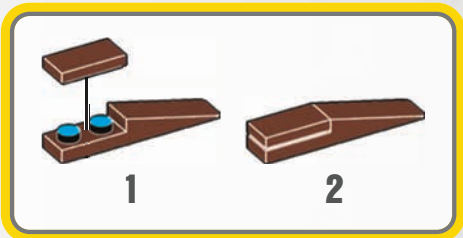
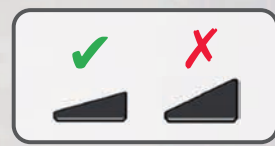



189

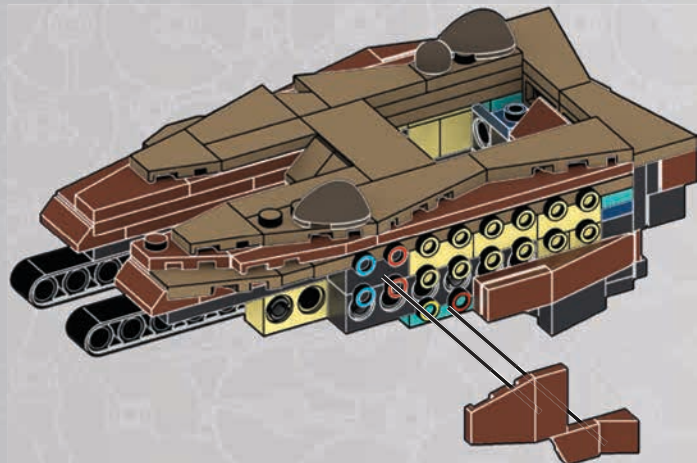

190

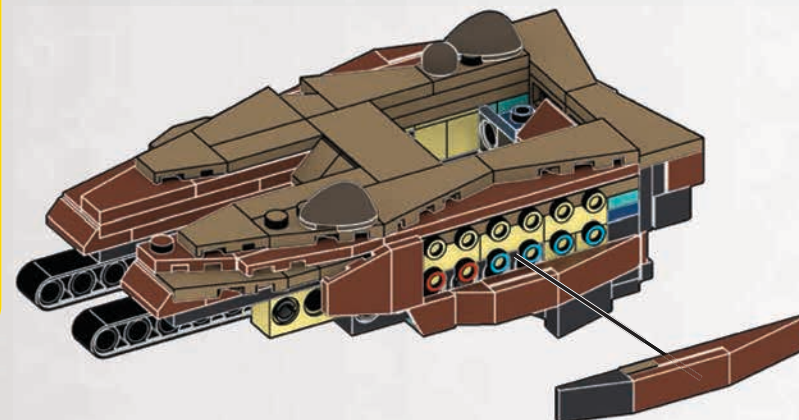
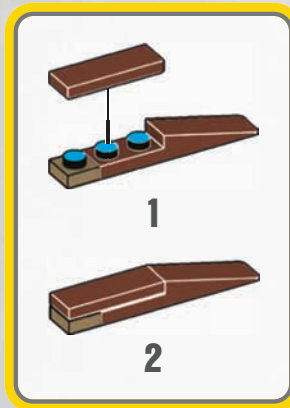
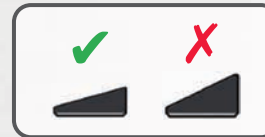

191

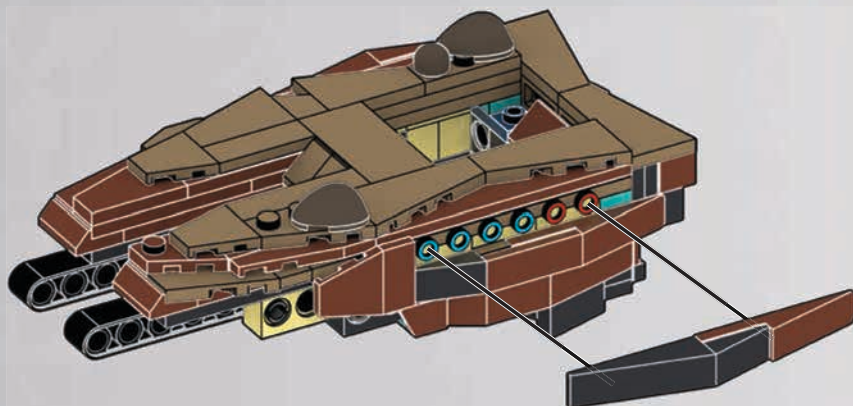
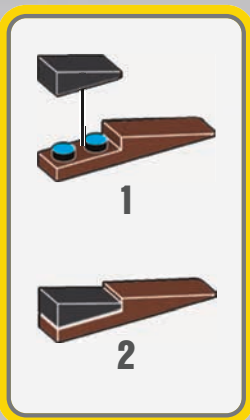

1

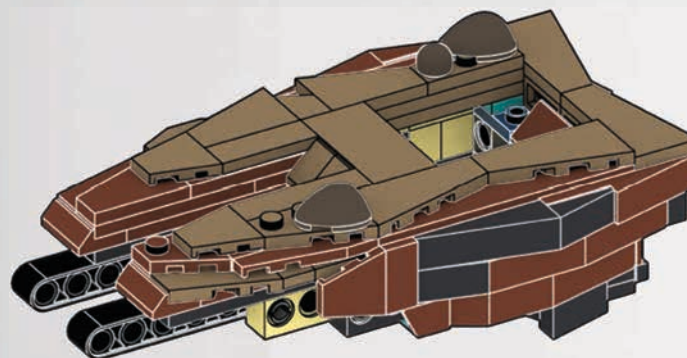

2



192



1x



3x

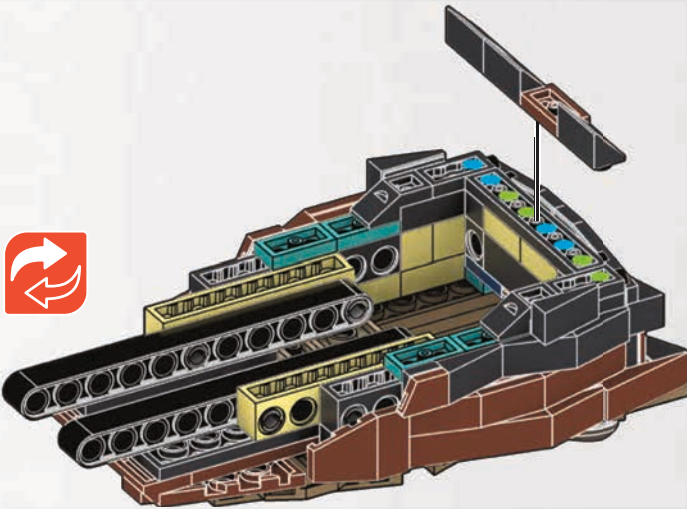

193



2x



2x

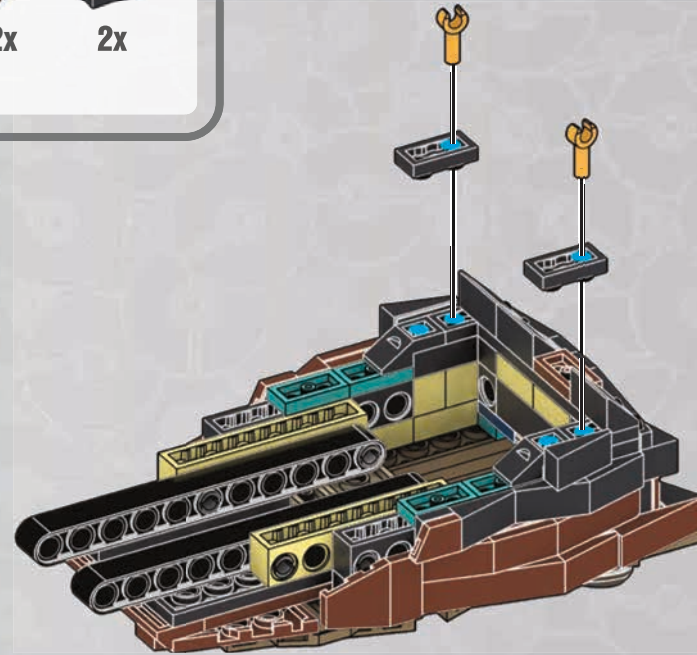

194



2x



2x

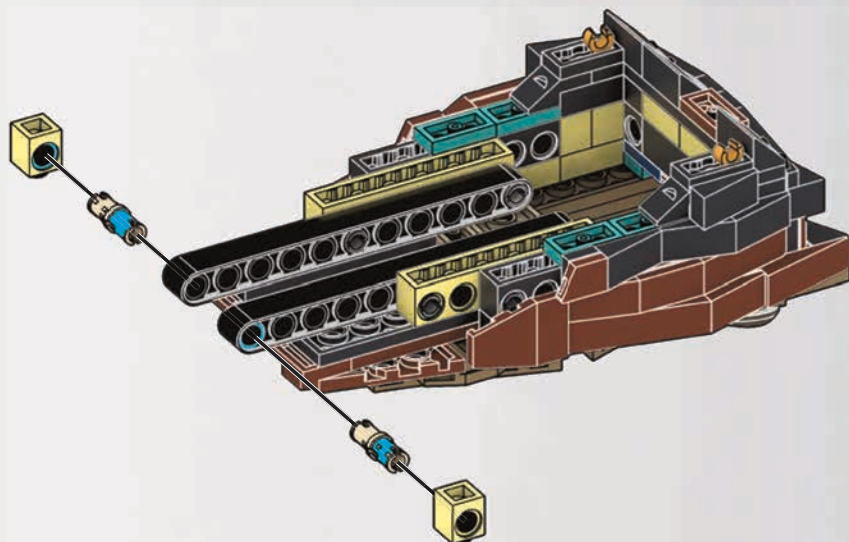

1

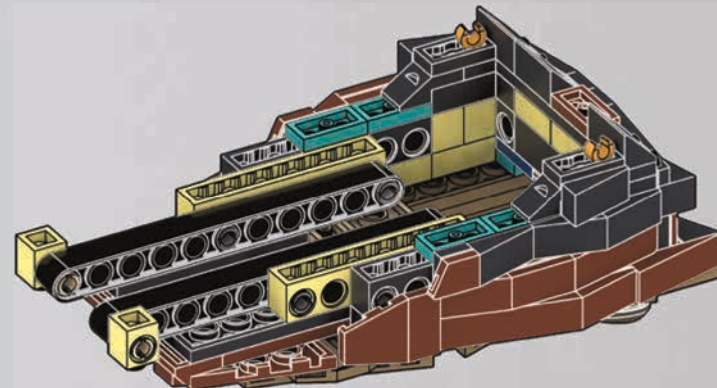

2

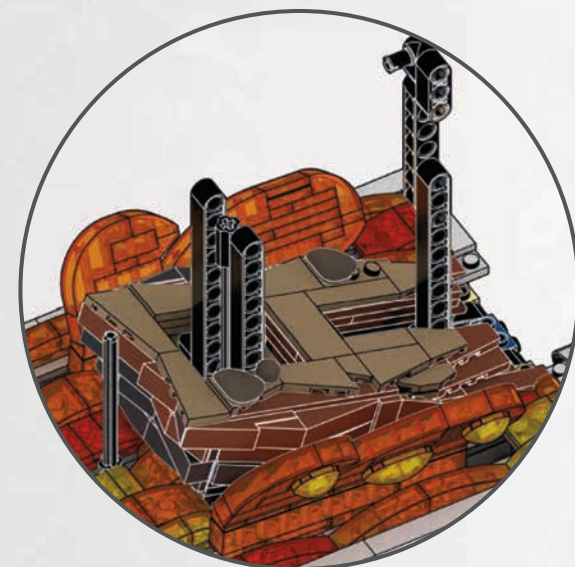
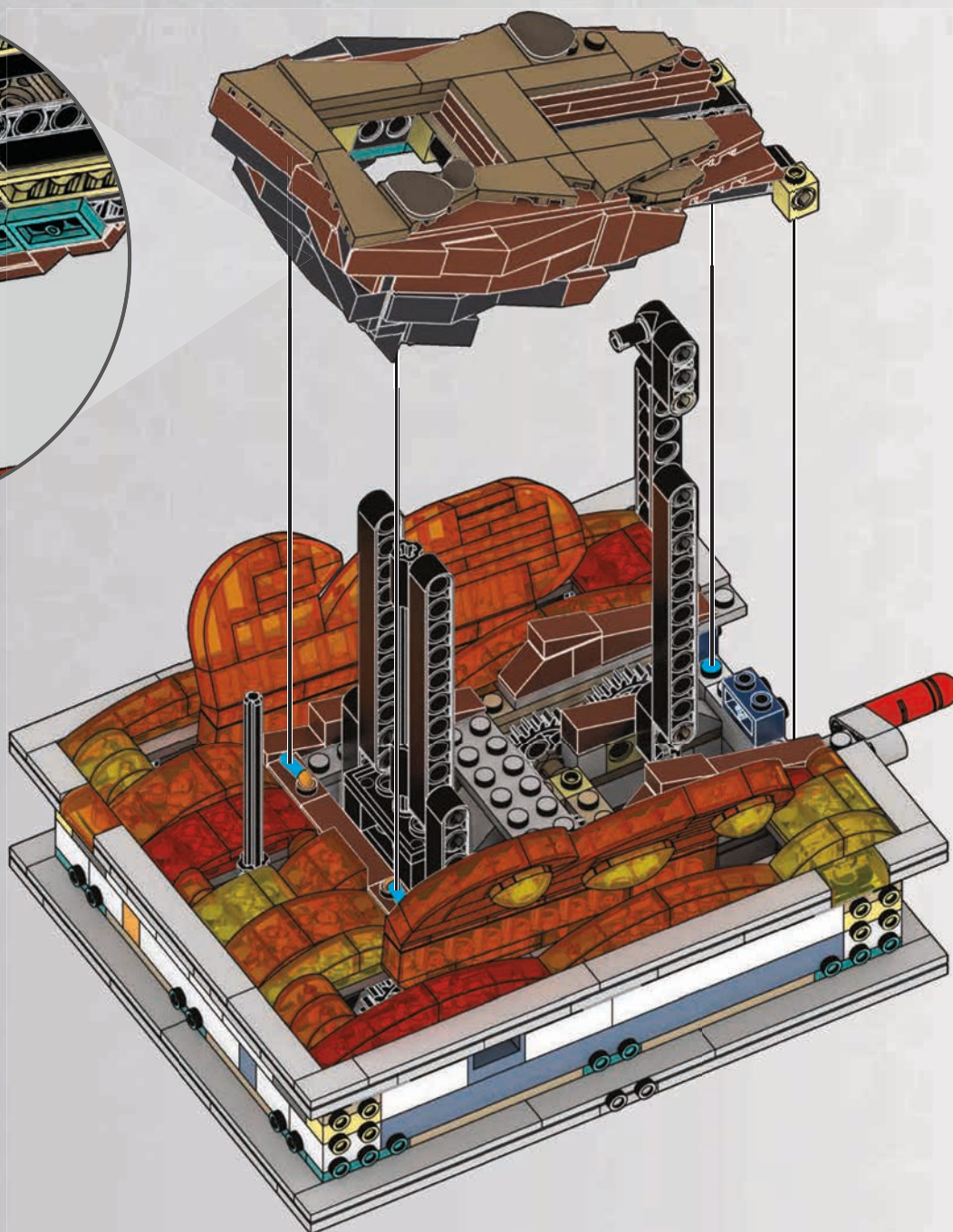
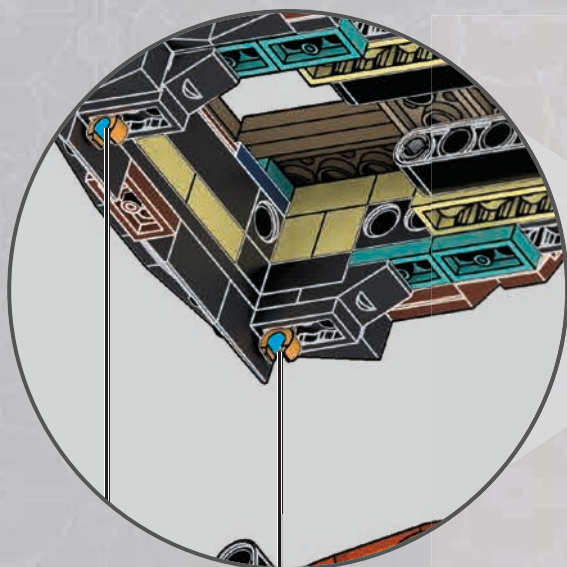

- 2x
- 1x
- 1x
- 1x

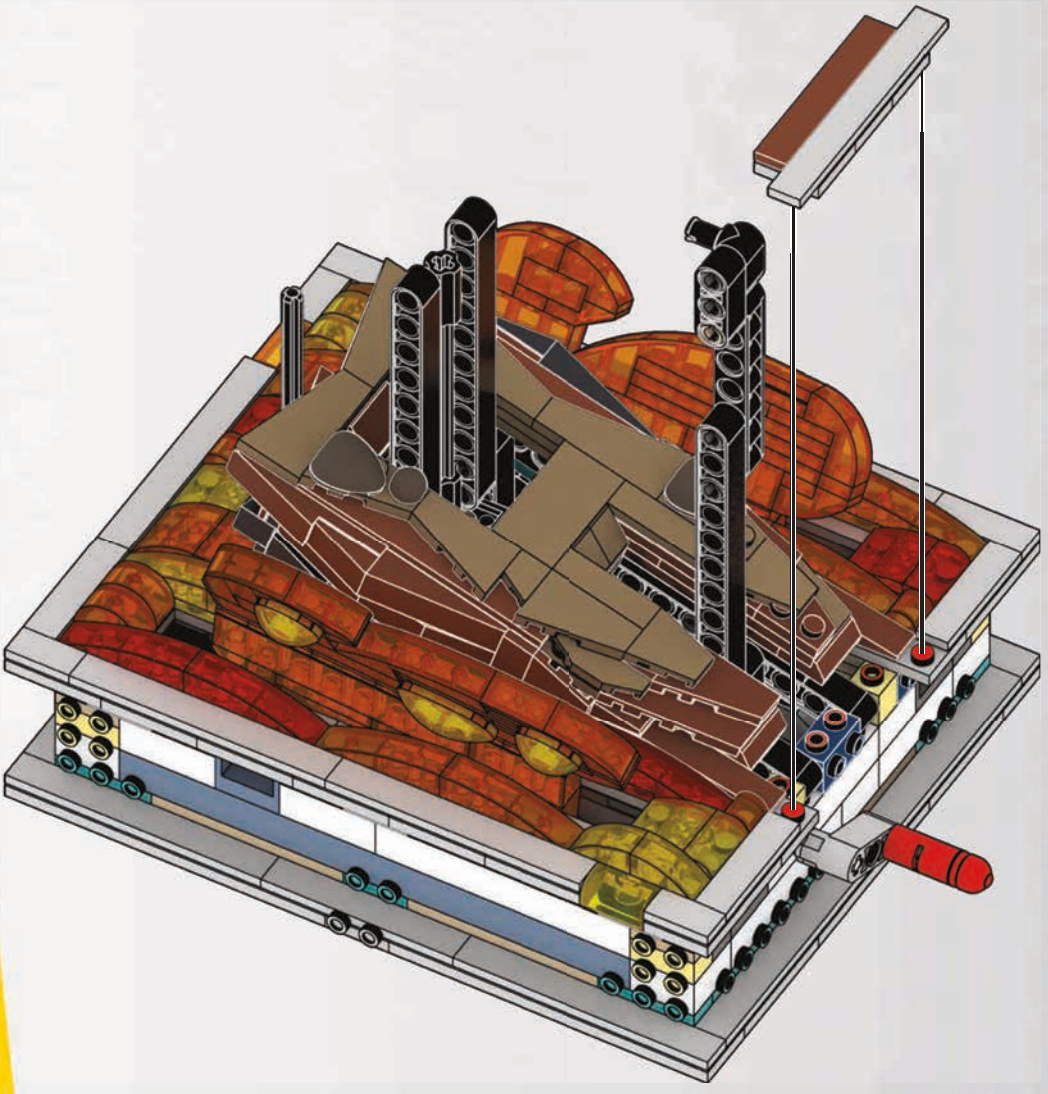
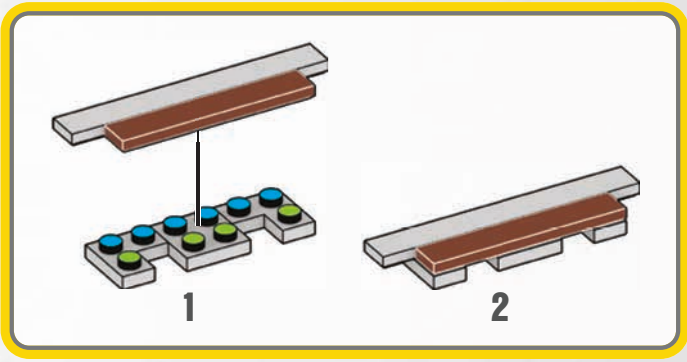

1

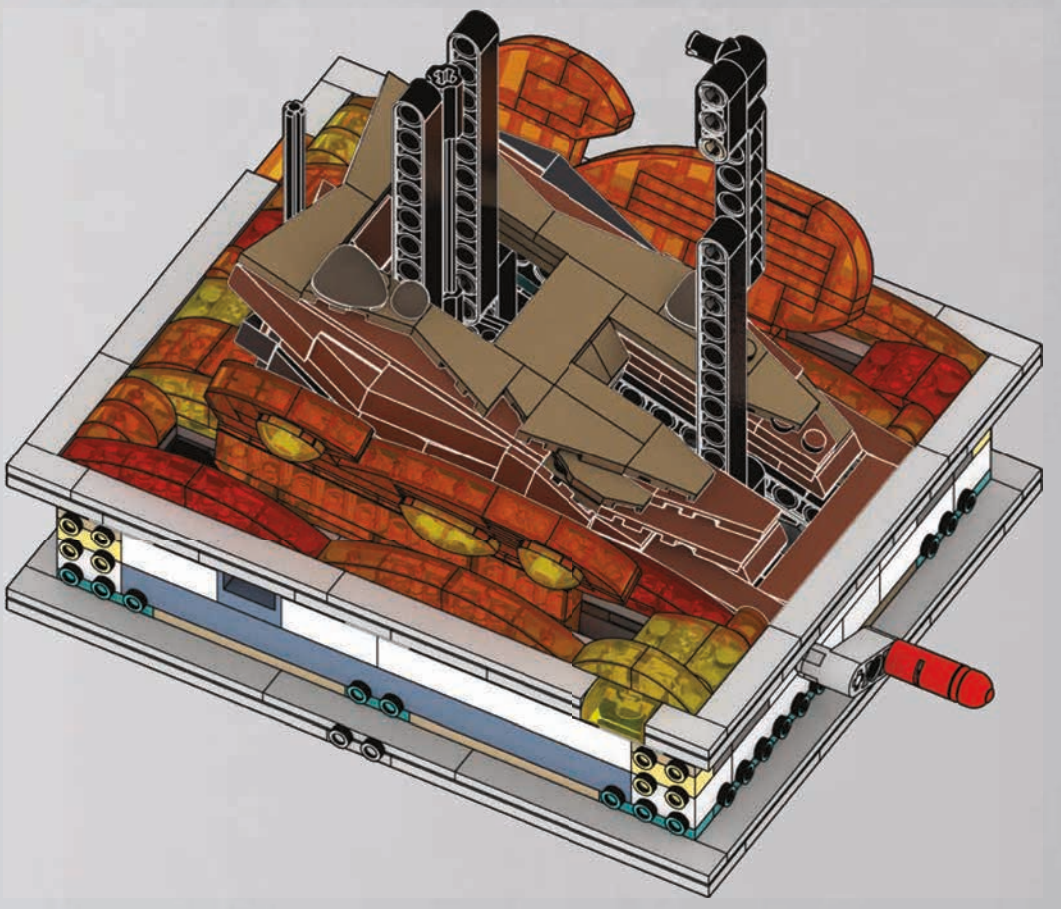

2

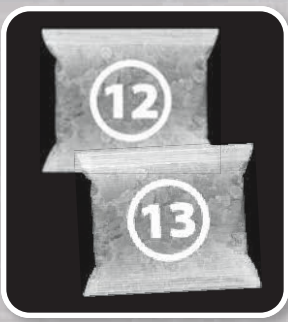

**197**

1x 1x 1x 2x 1x

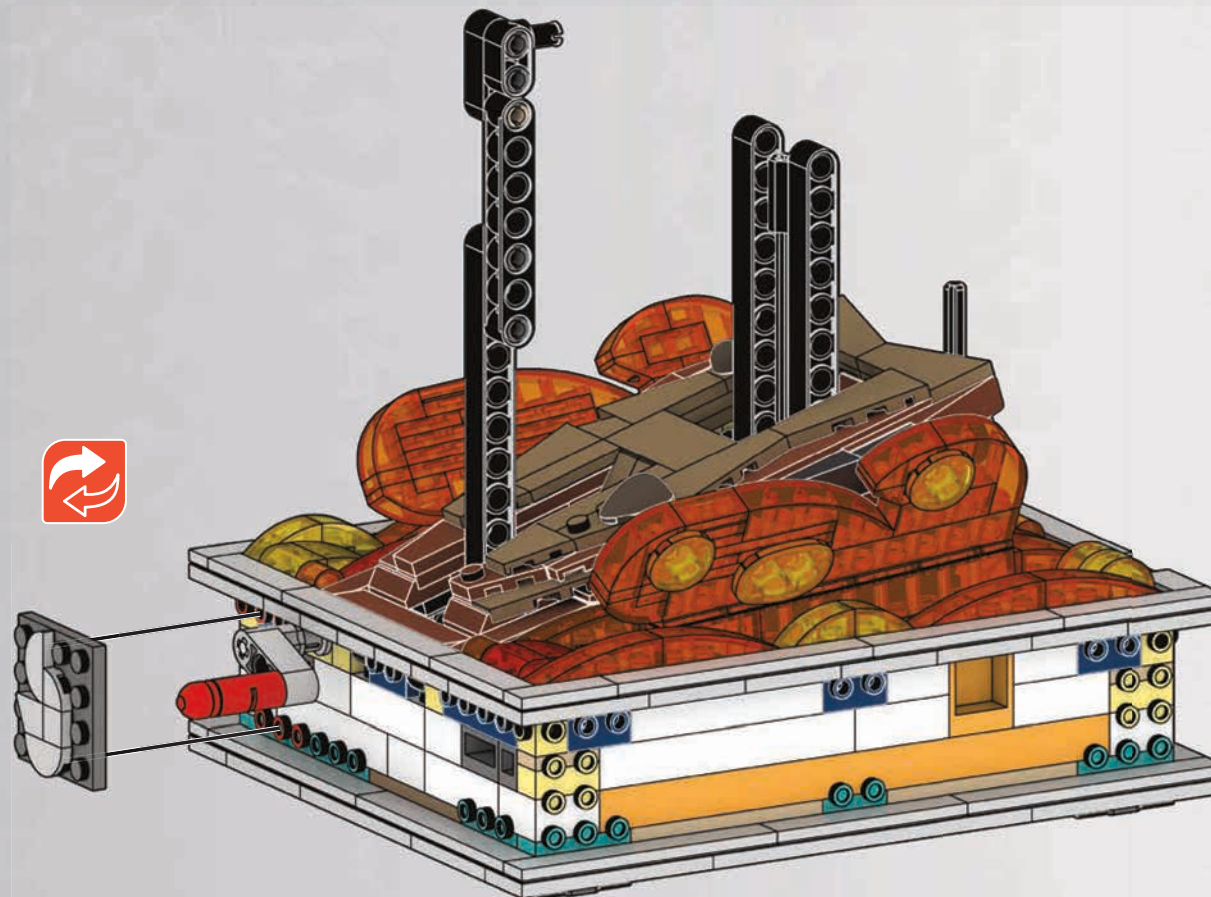
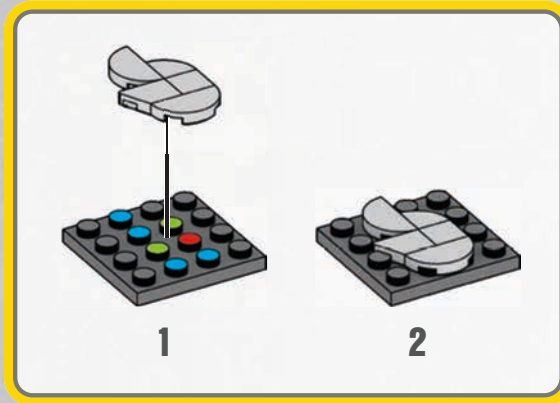
A white rounded rectangle containing the step number '197' in a black circle. To the right are five small icons of LEGO parts: a white 1x2 Technic brick with a hole, a white 1x2 Technic brick, a white 1x2 Technic brick with a hole, a white 1x2 Technic brick with a hole, and a grey 1x4 Technic plate with 8 holes.

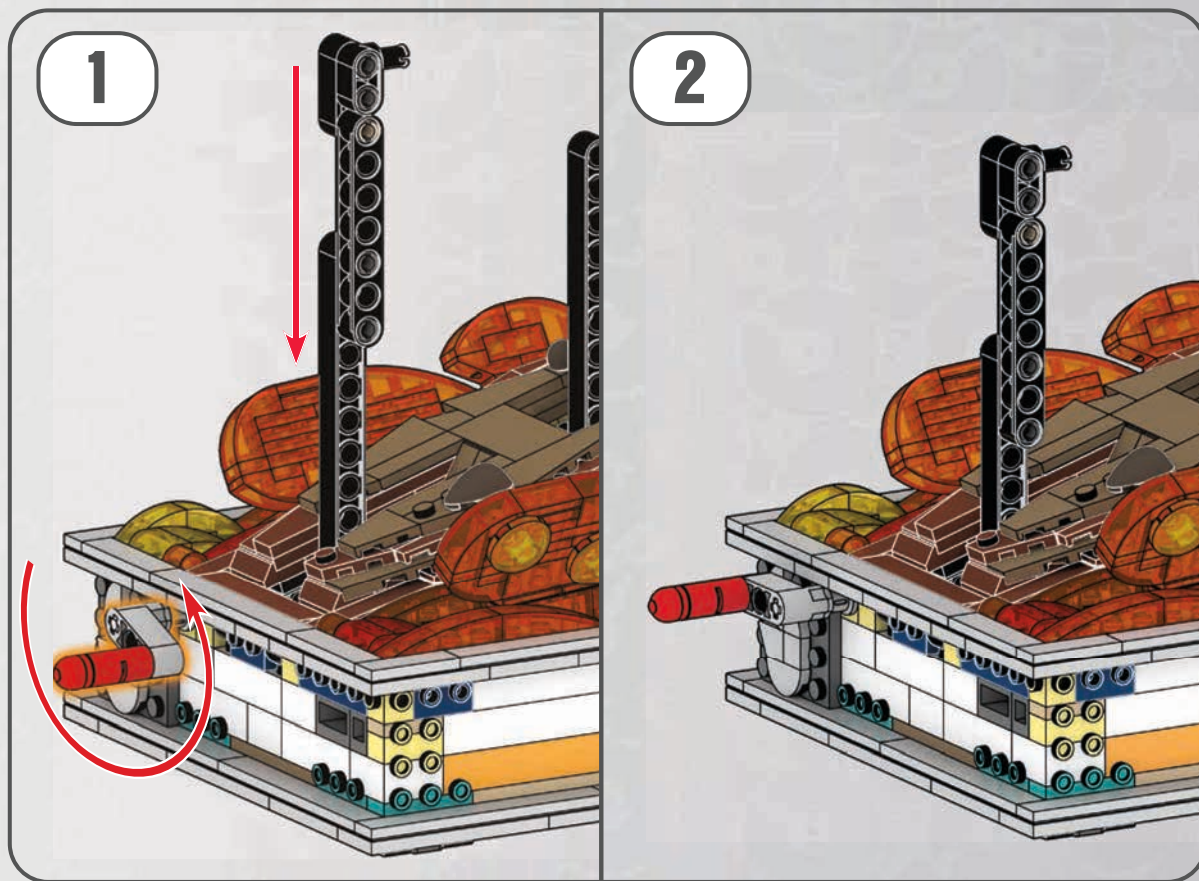

1x

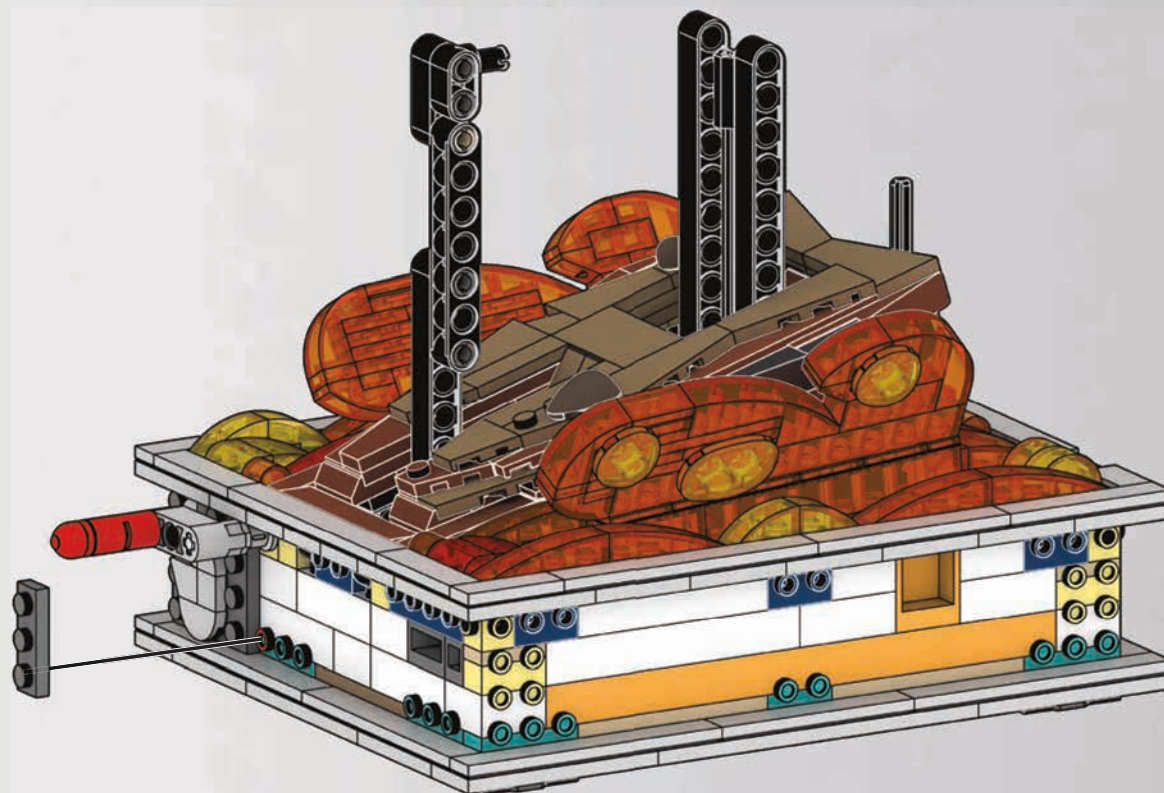

200

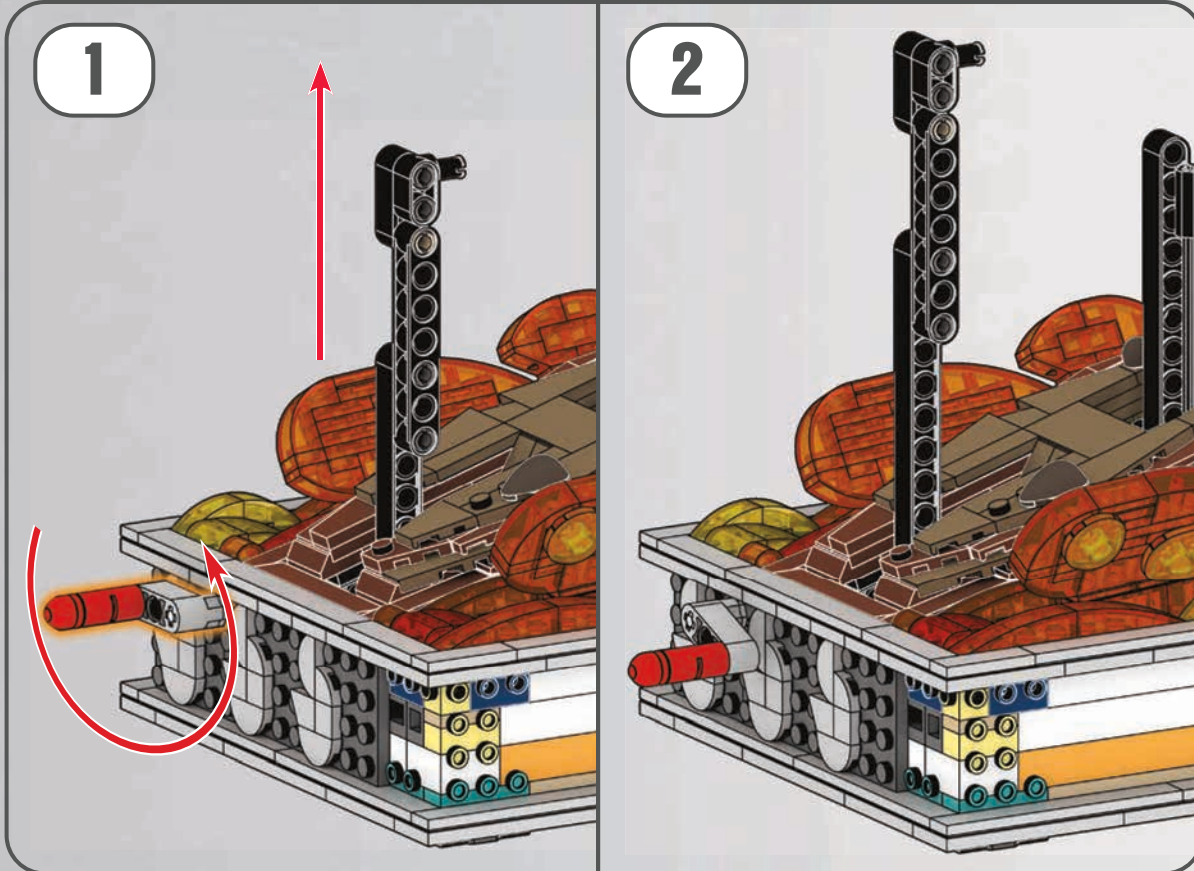
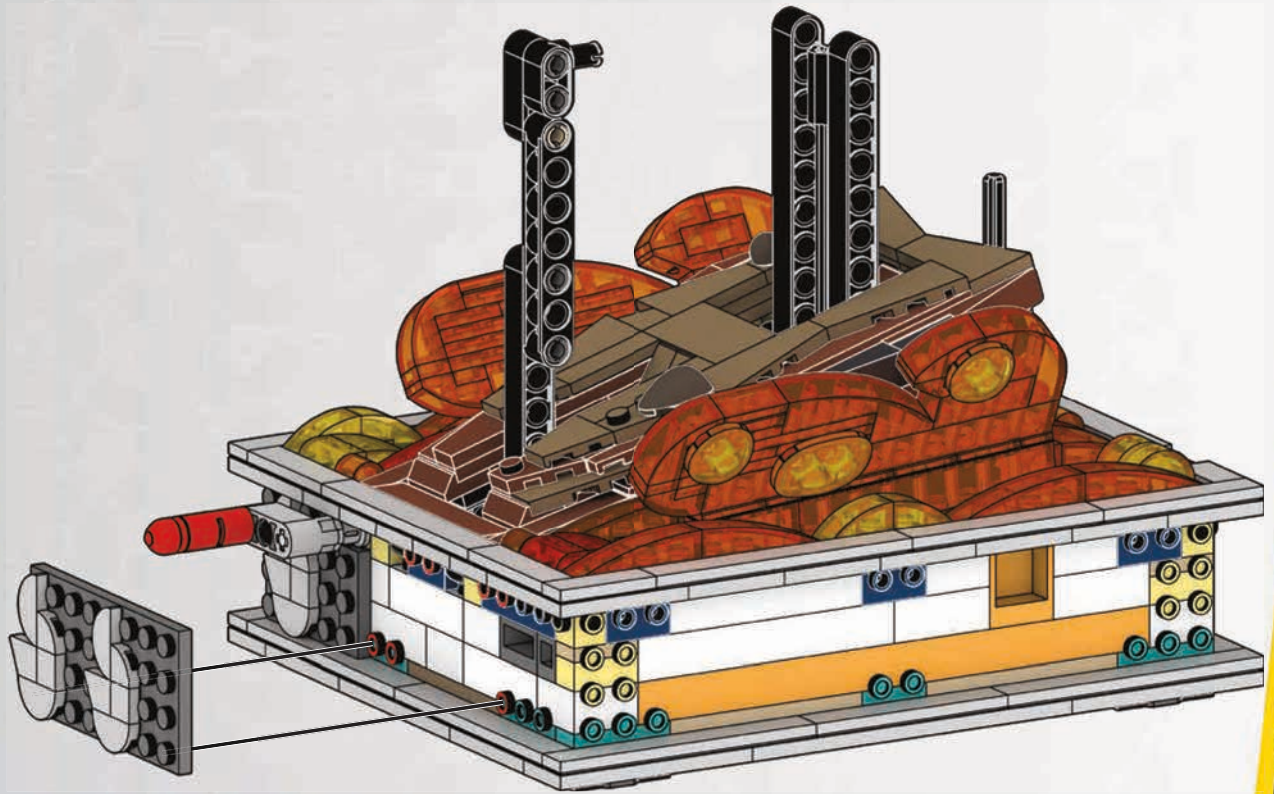
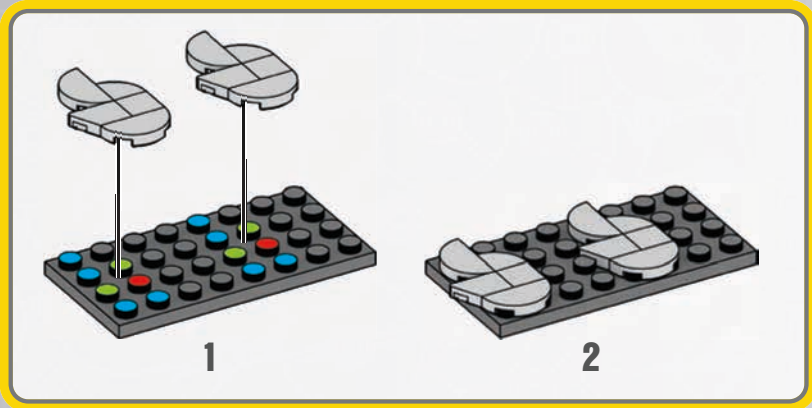

201

- 1x
- 1x
- 1x
- 2x
- 1x
- 1x

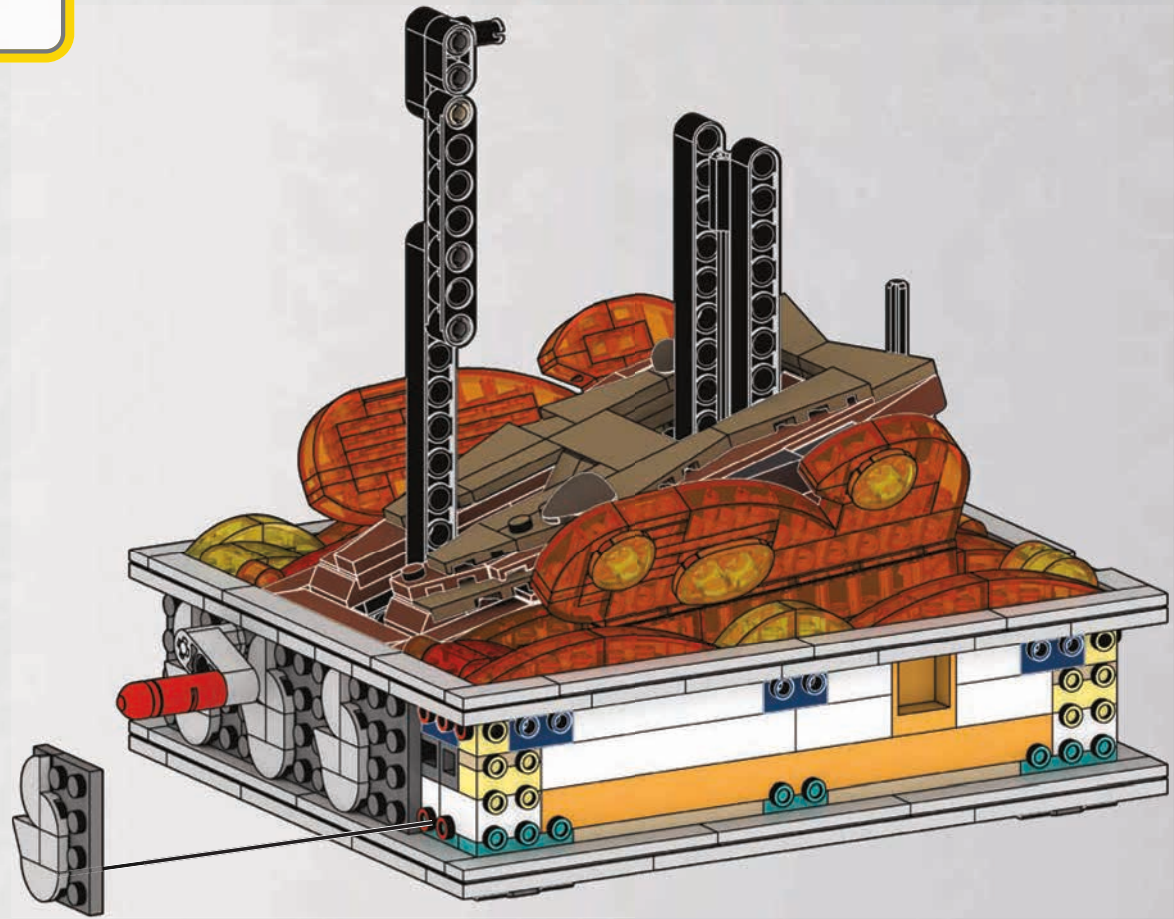
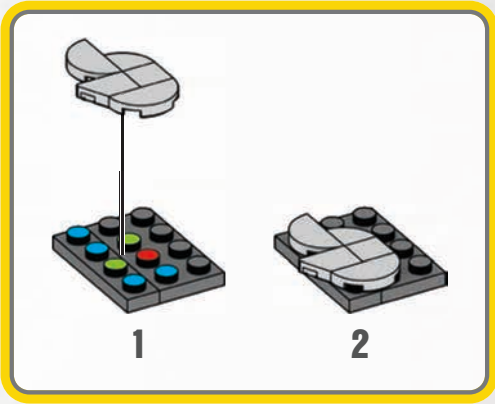



202



4x



2x

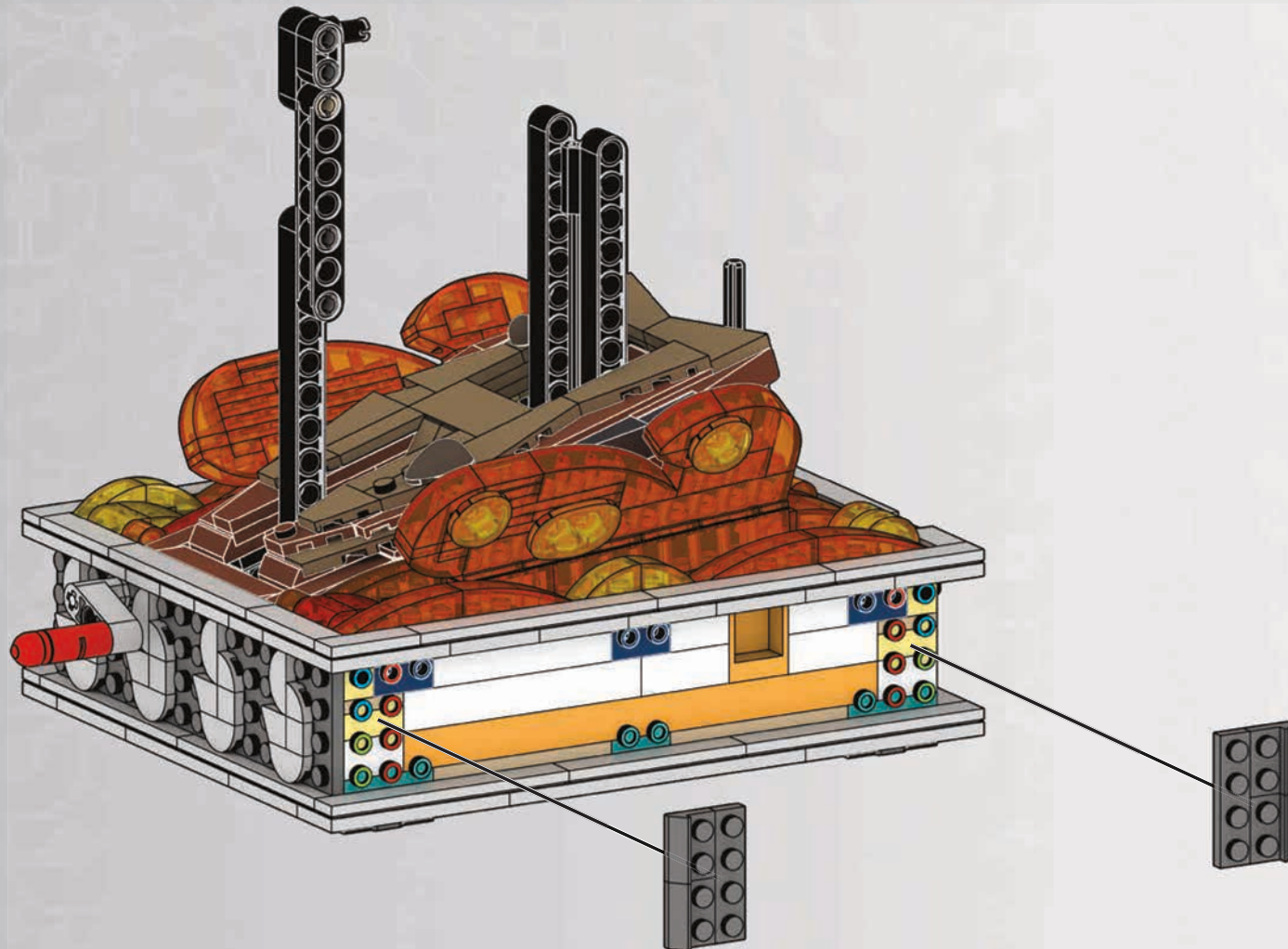

203

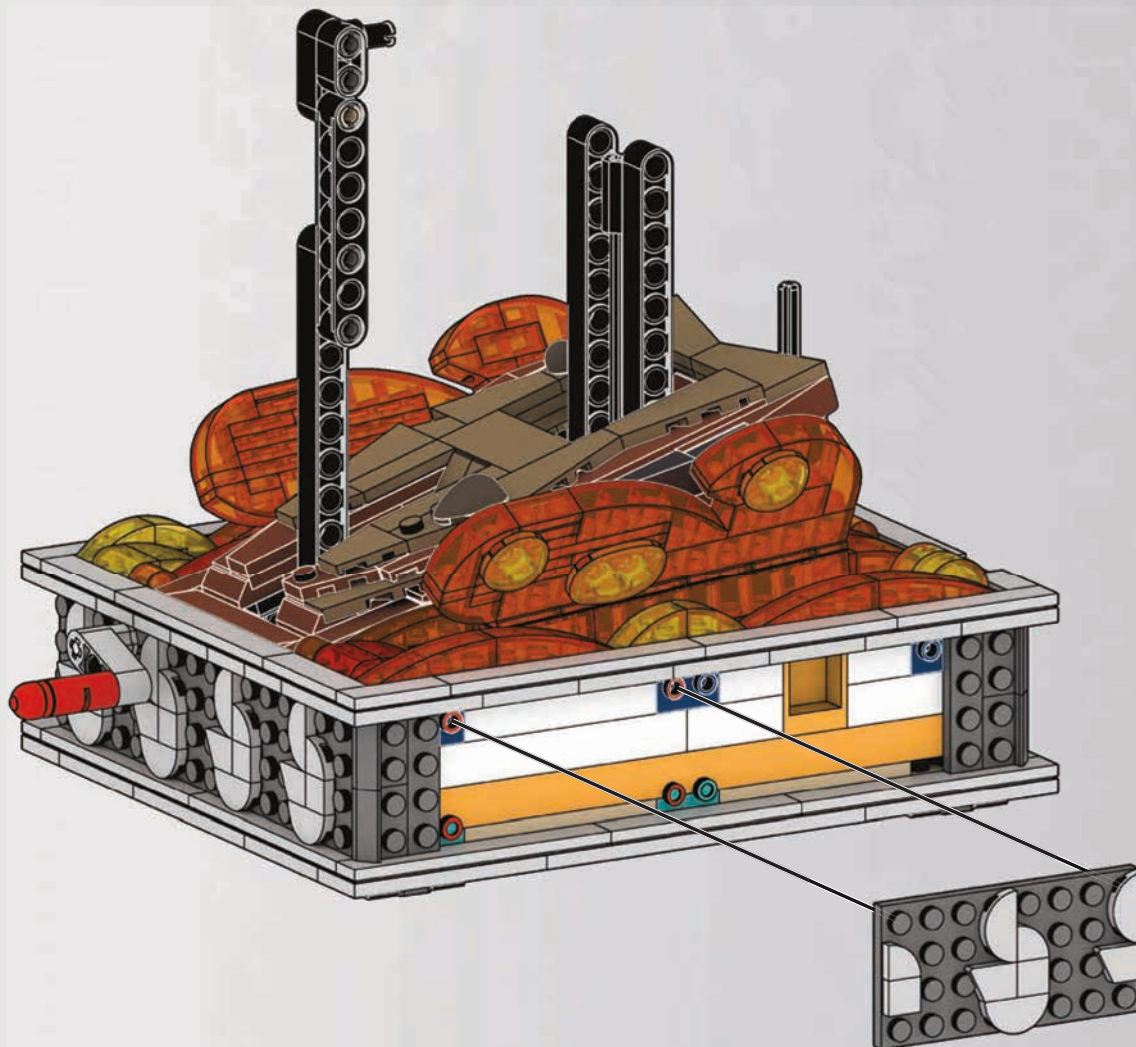
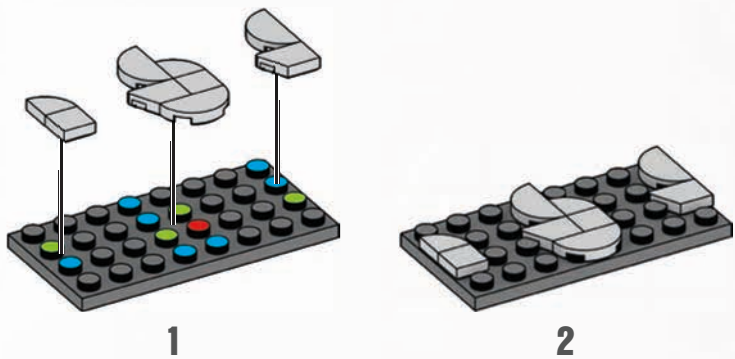
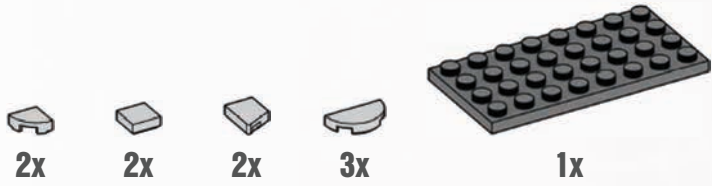

204

- 2x
- 2x
- 2x
- 3x
- 1x

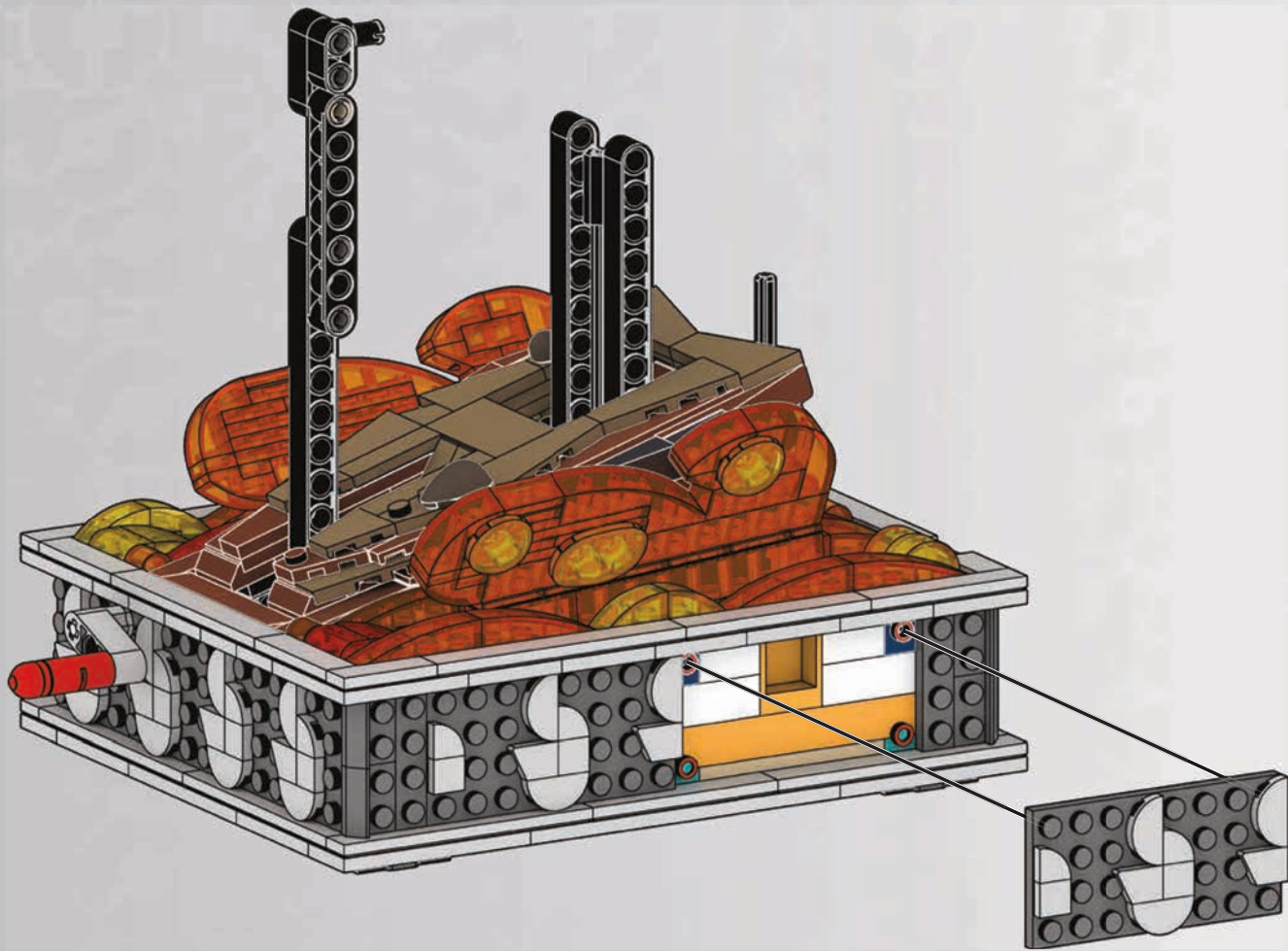
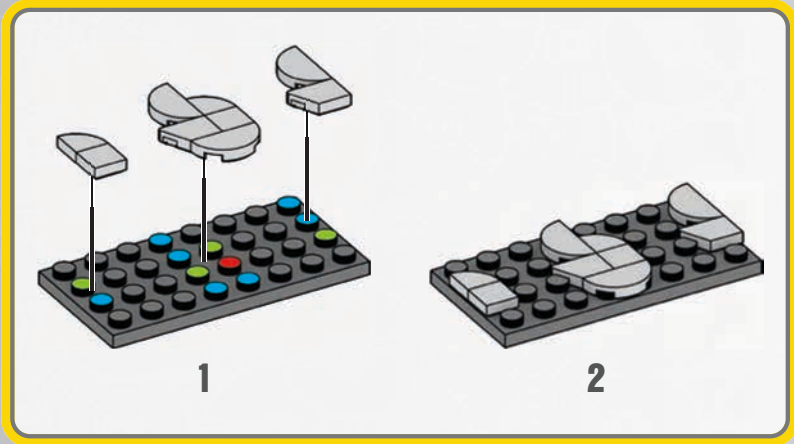

205



1x

1x

1x

4x

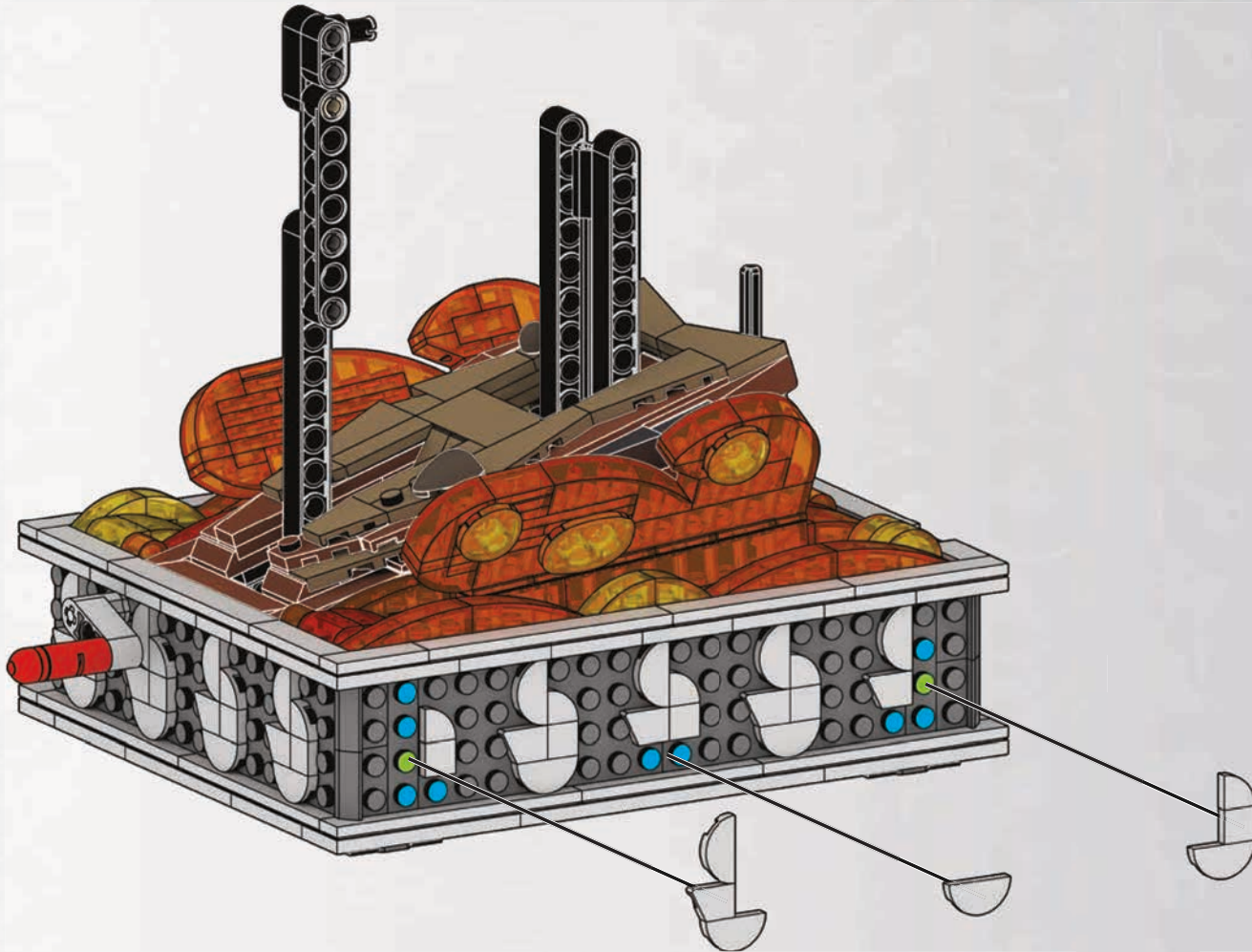

1

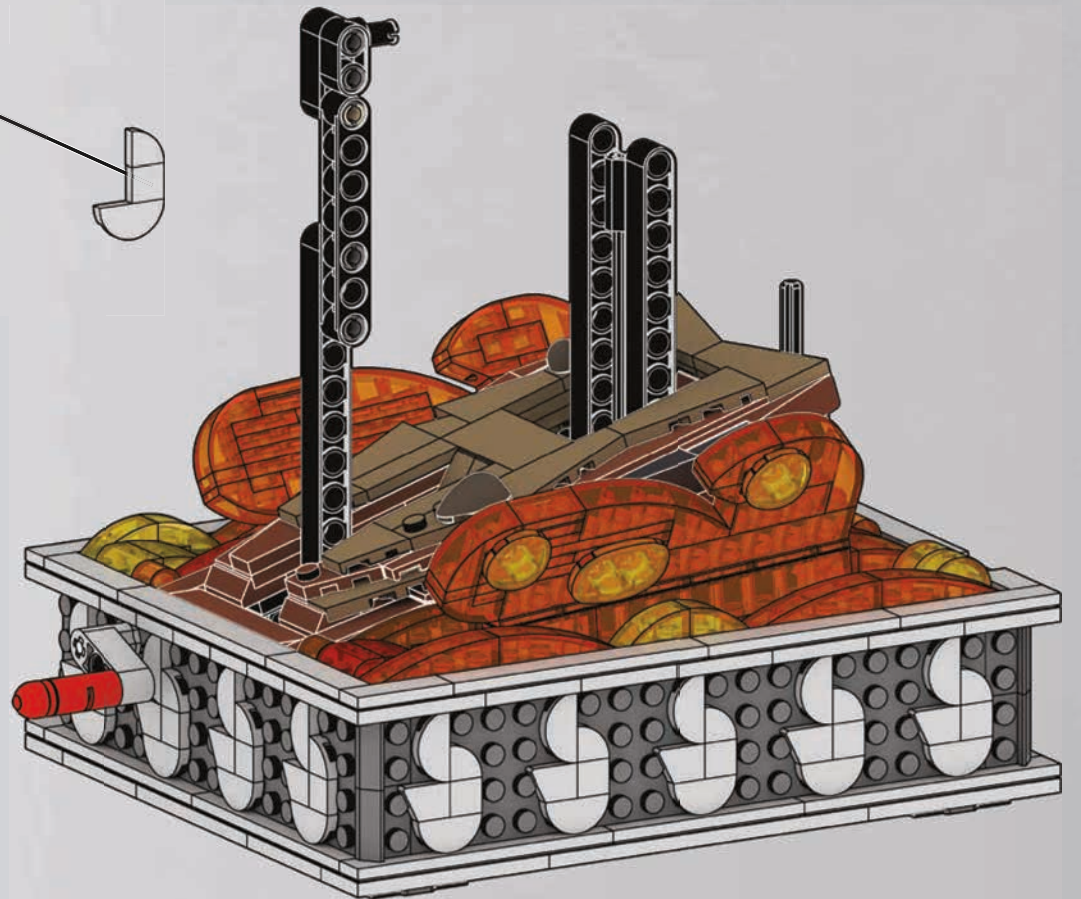

2

206

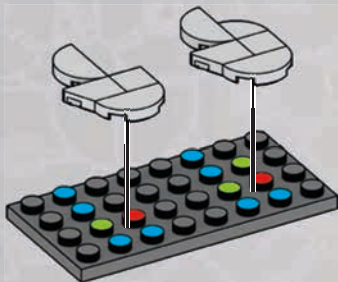
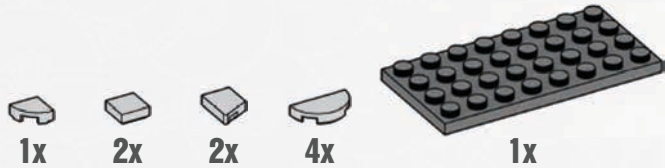

207

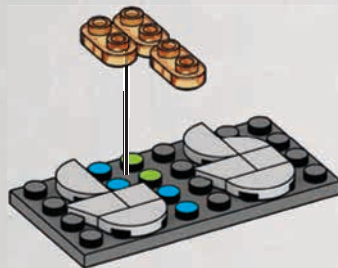

208

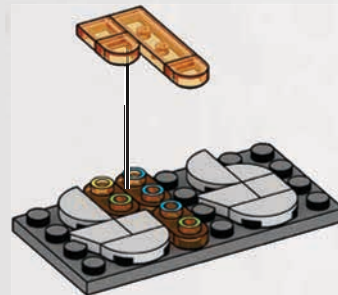
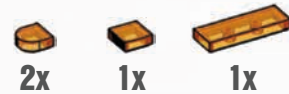

1



2

209

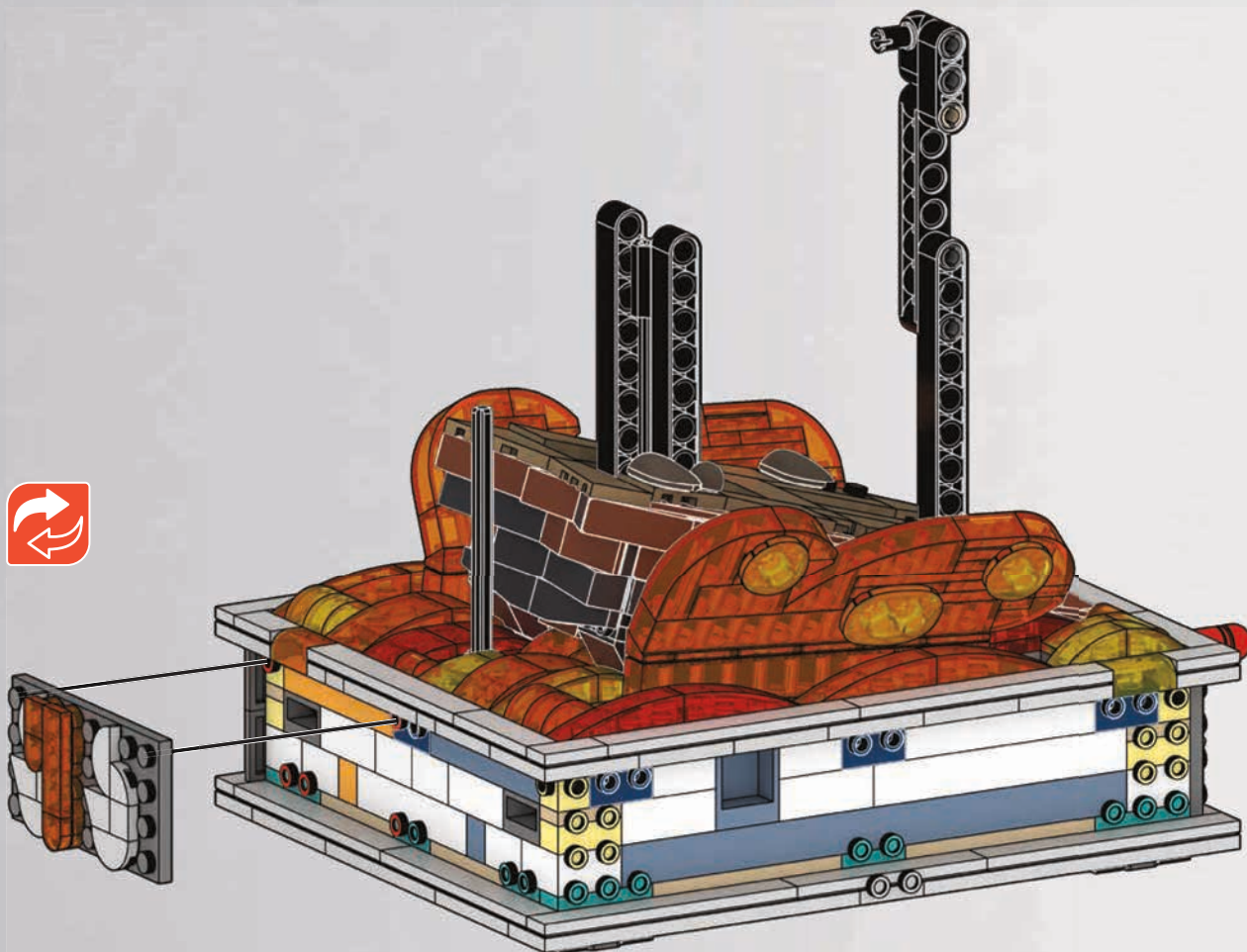

210

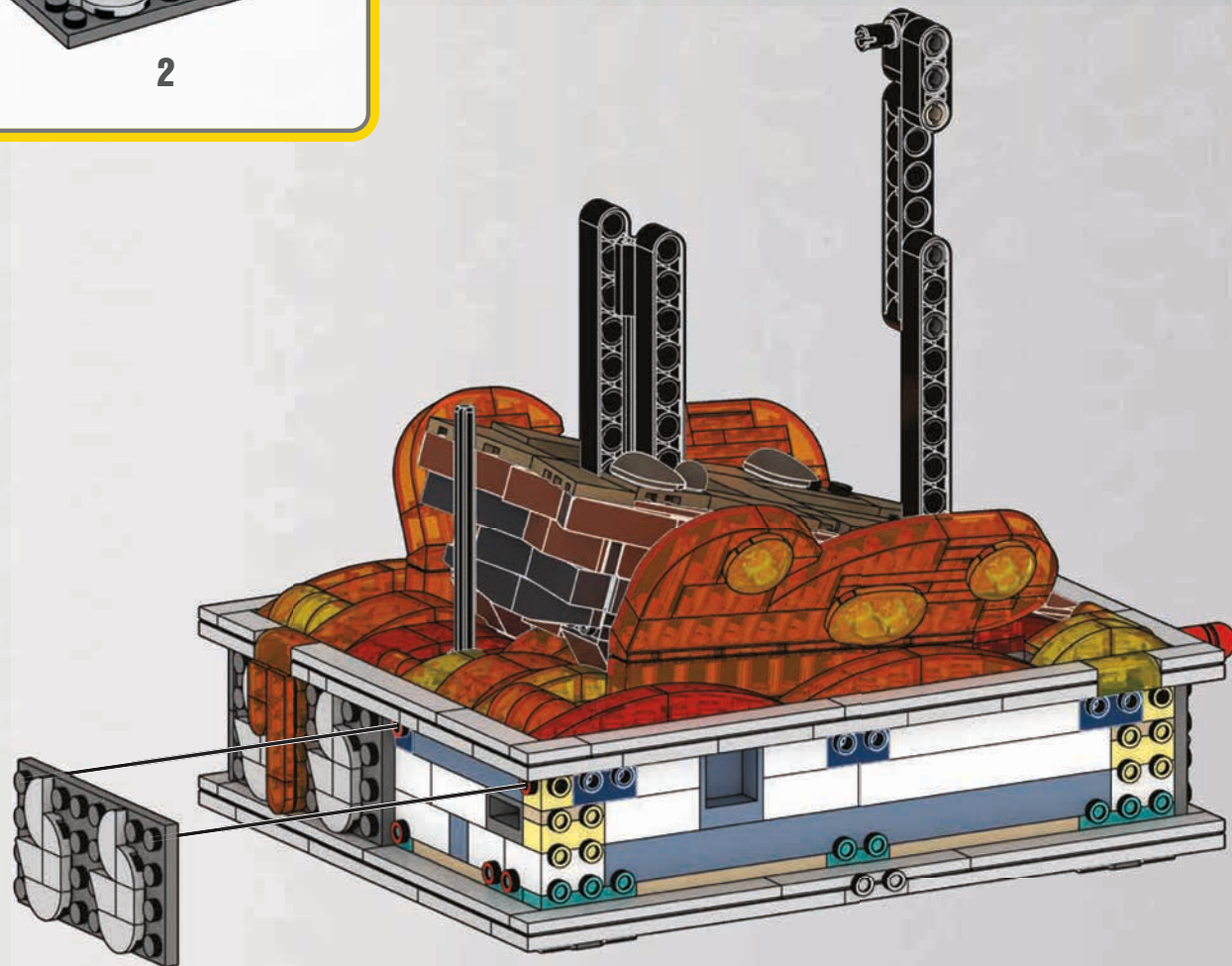
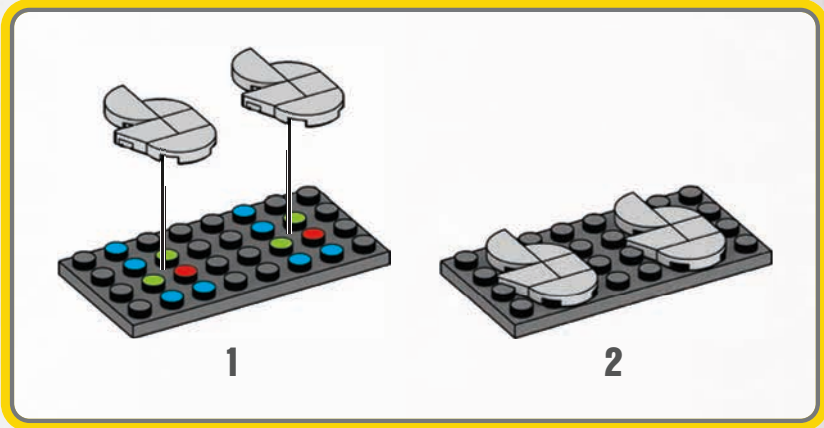
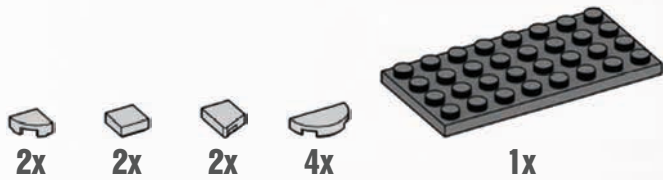

211



4x



2x

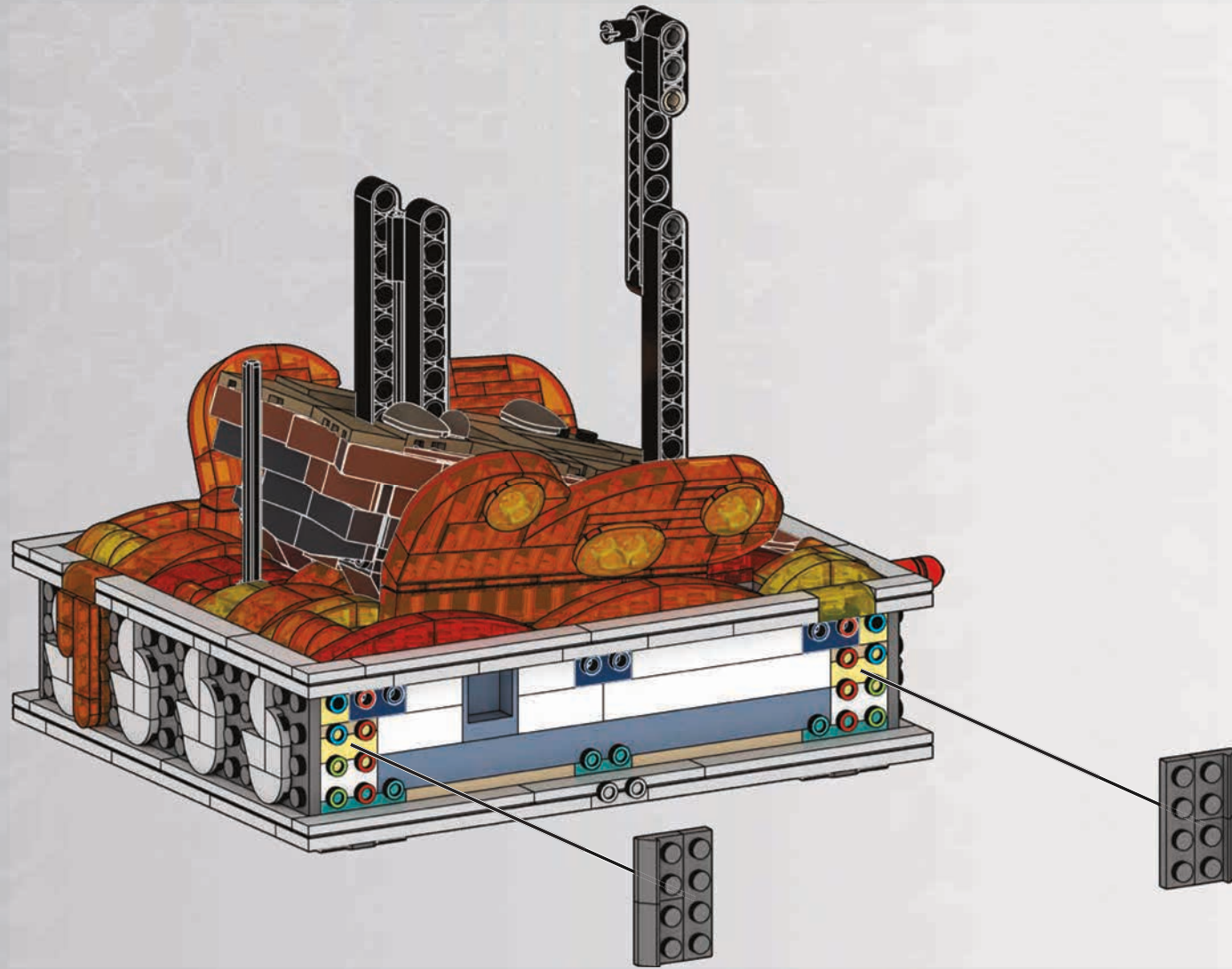

212

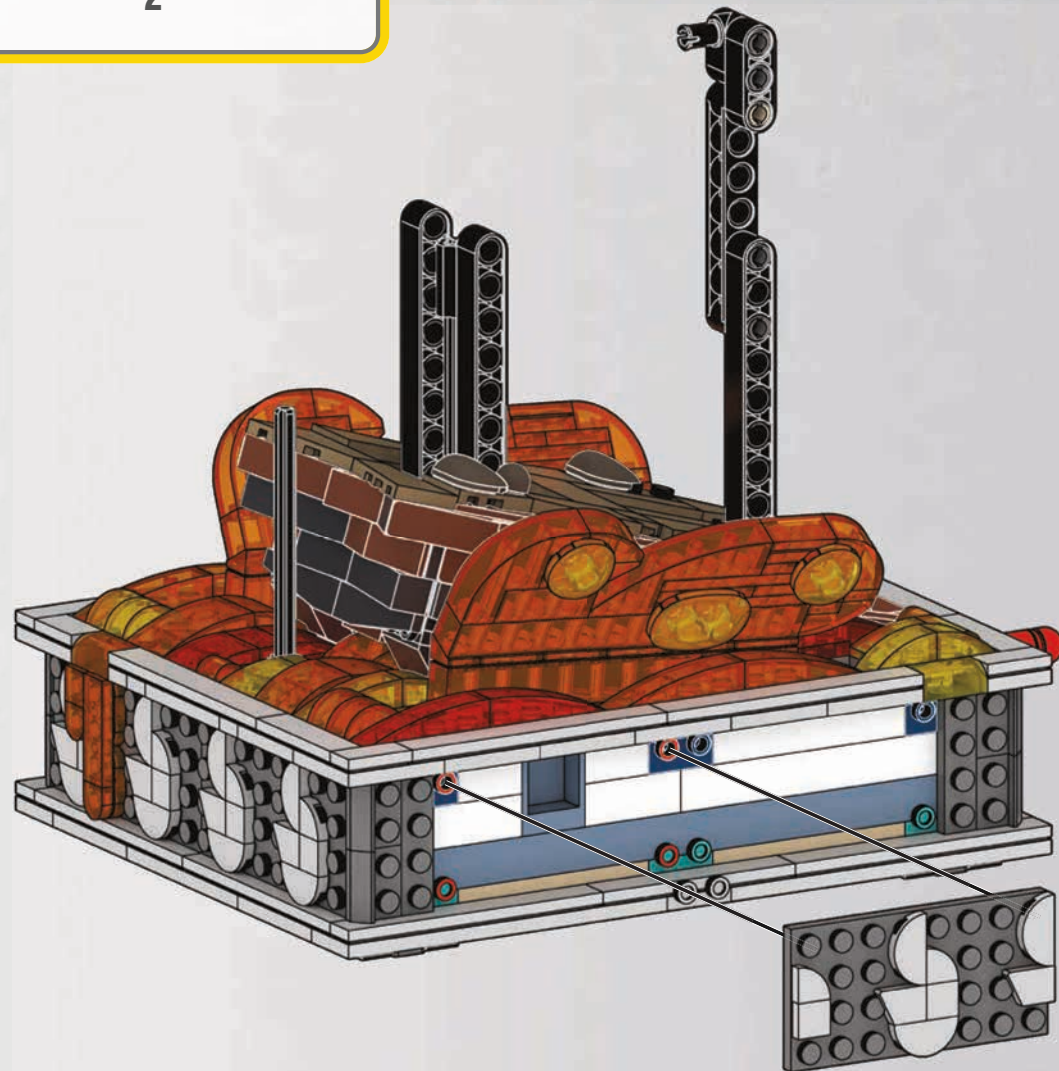
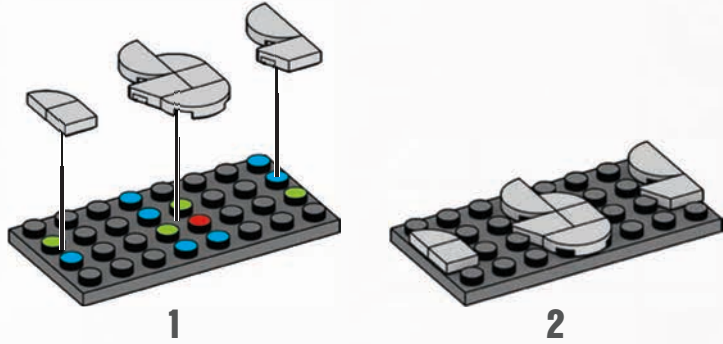
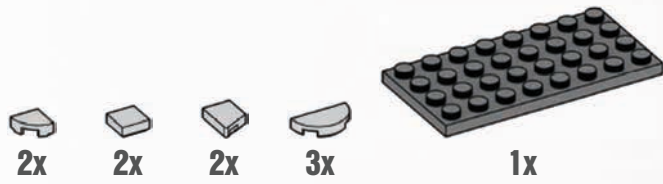



213

- 2x
- 2x
- 1x
- 2x
- 1x

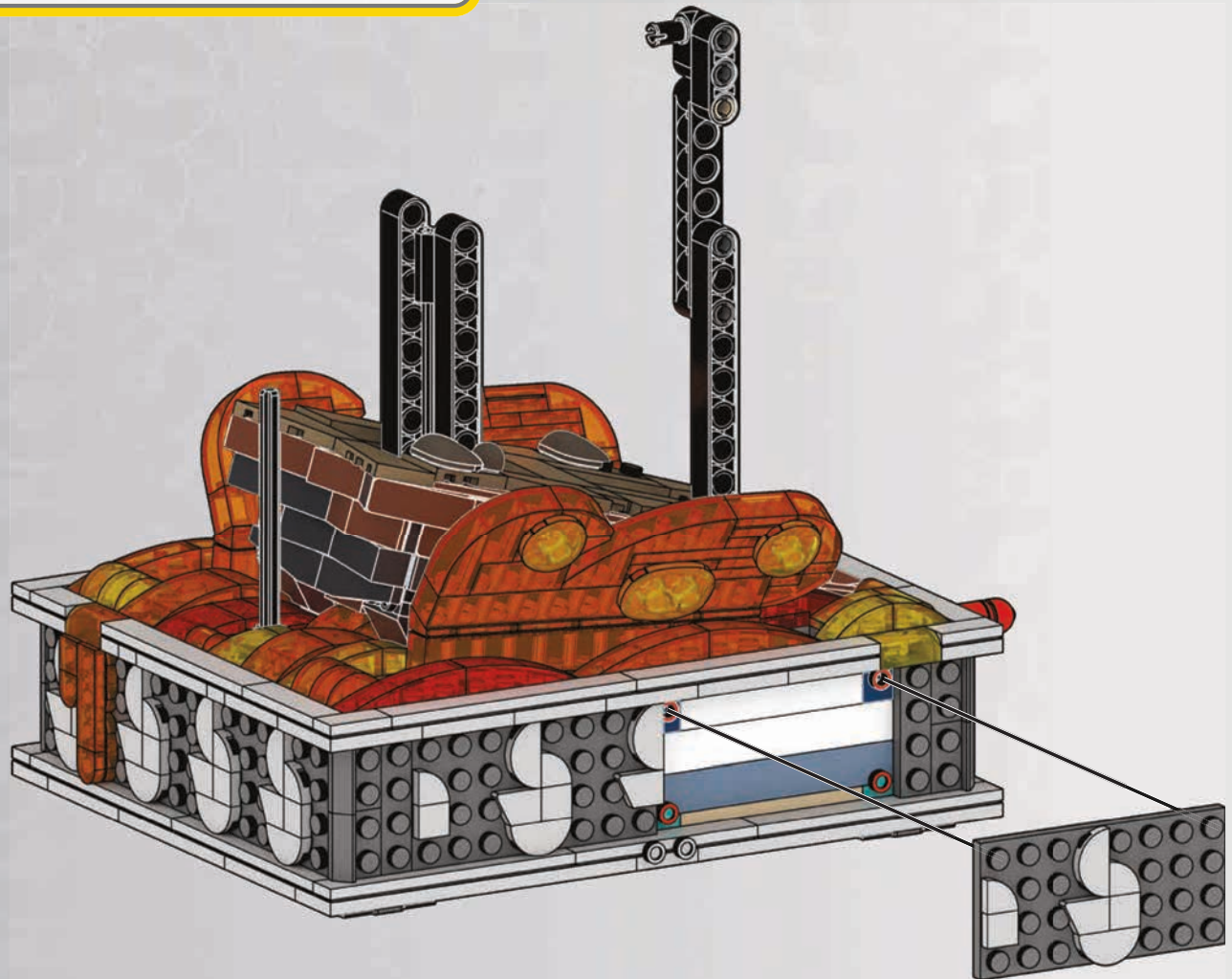
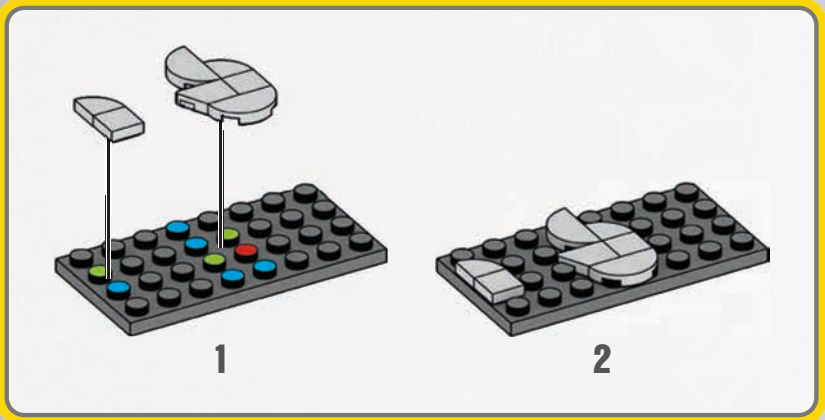

214



1x



1x



1x



4x



2x

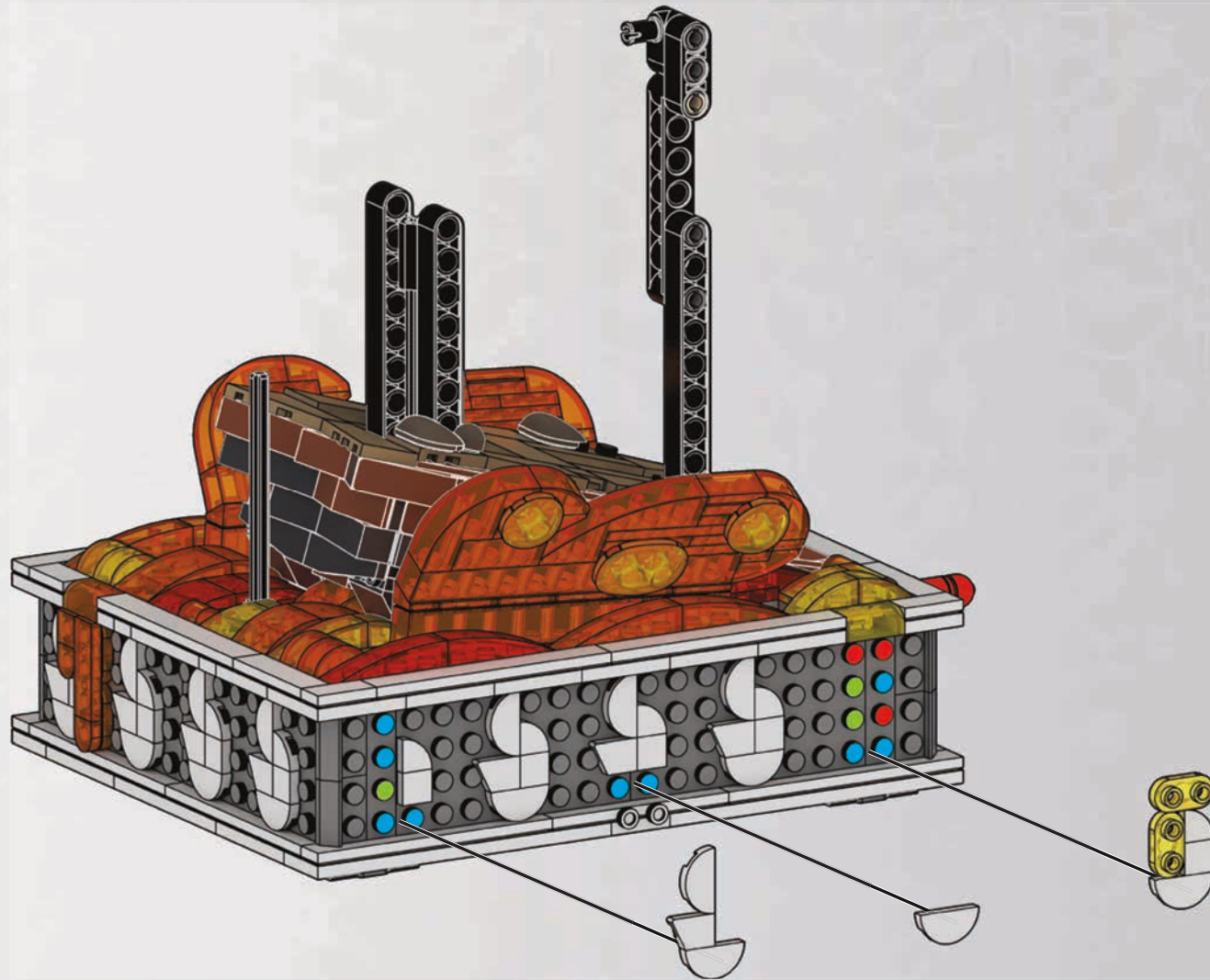

215



2x



1x

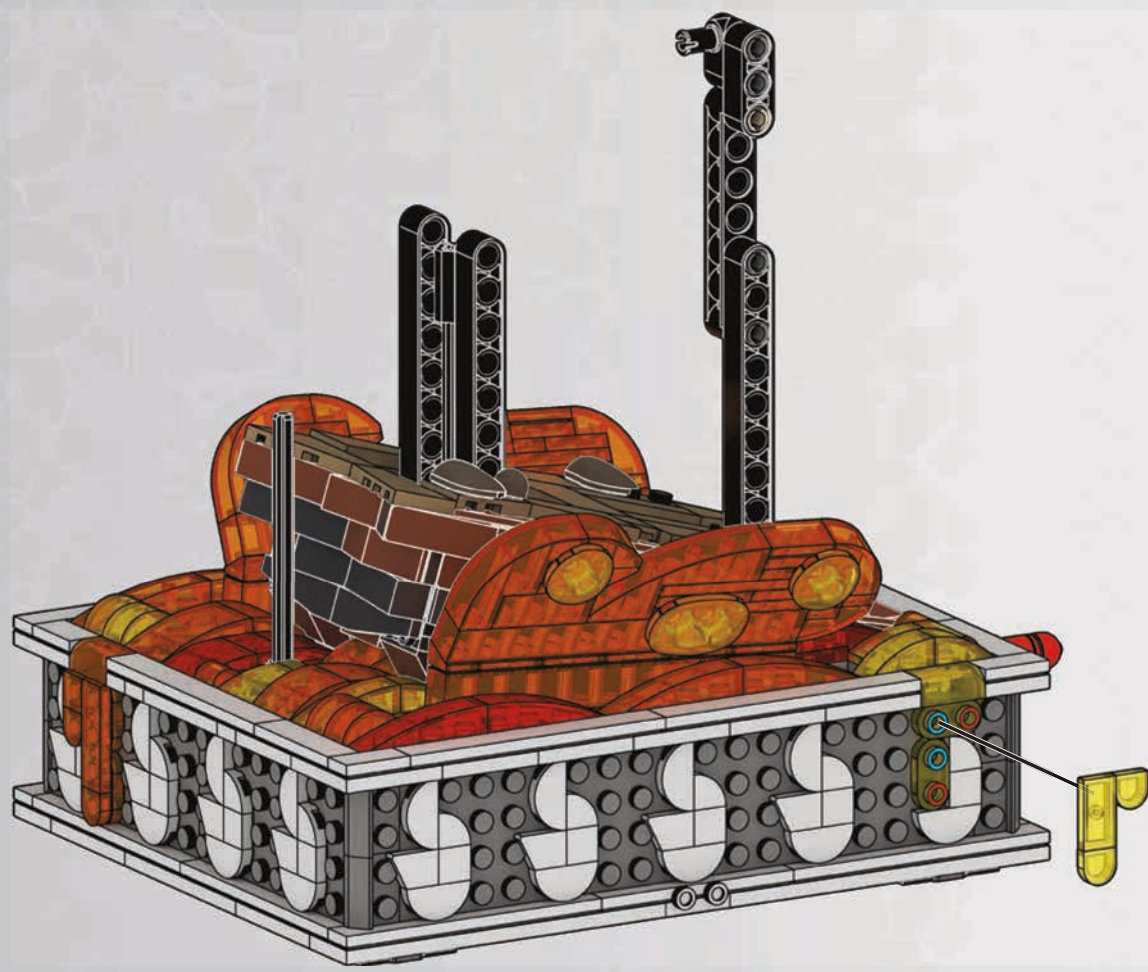

216



1x



or/o/ou/oder  
of/lub/или

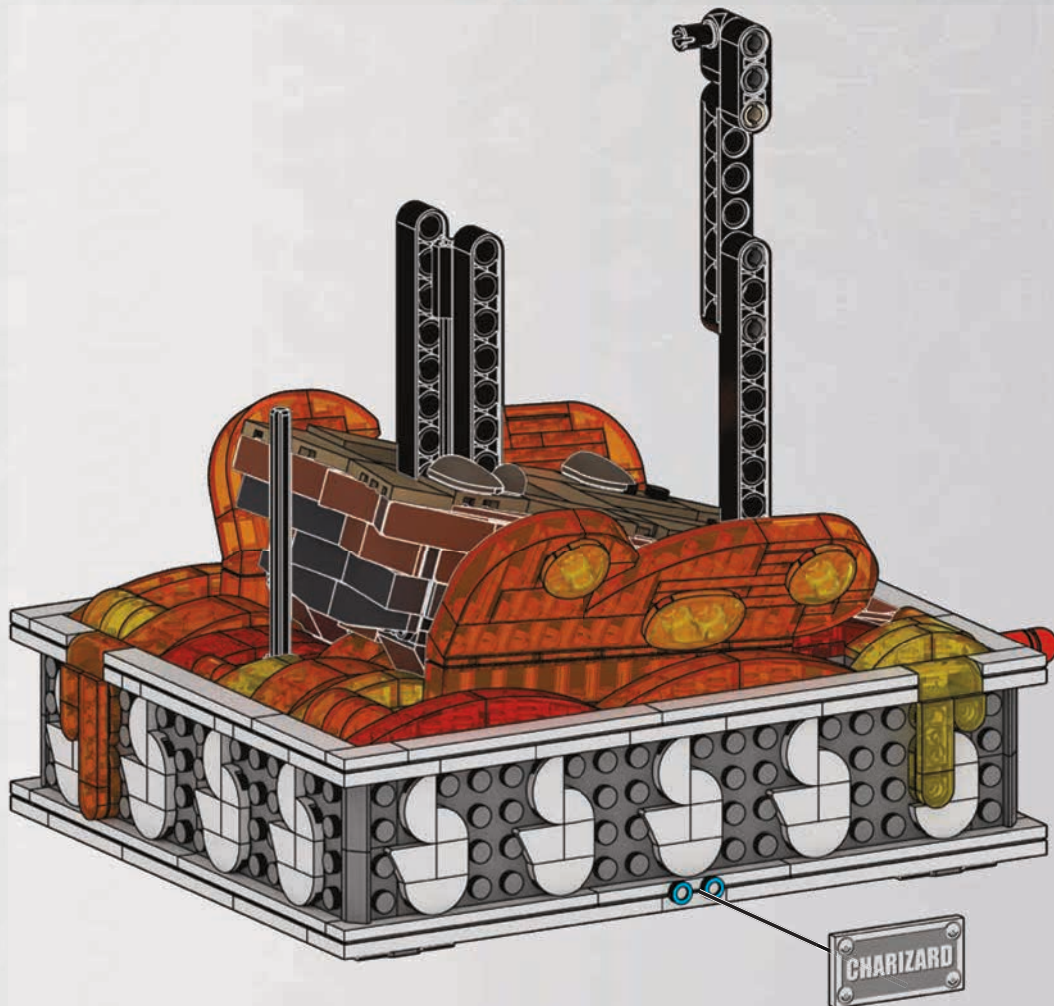

217



1x



1x

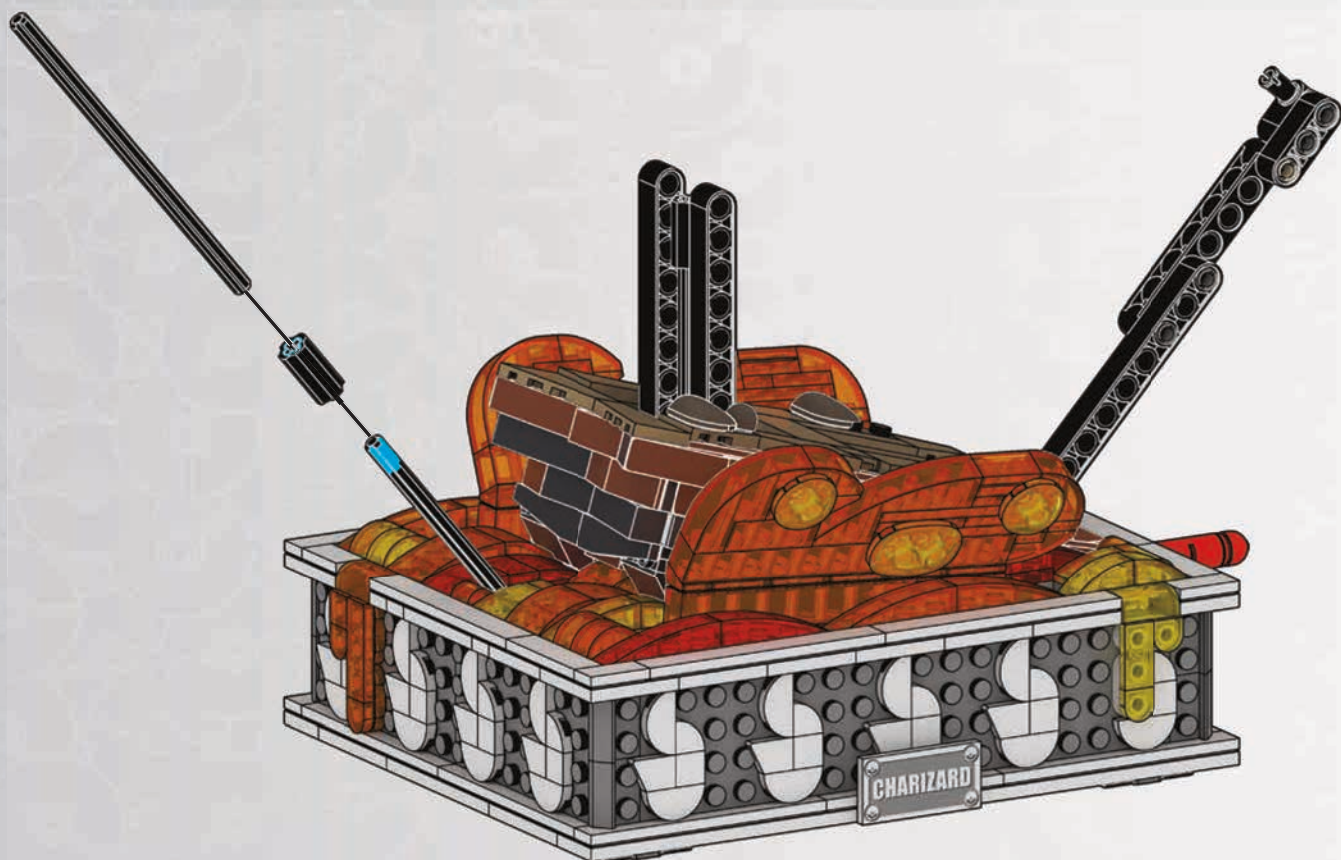

1

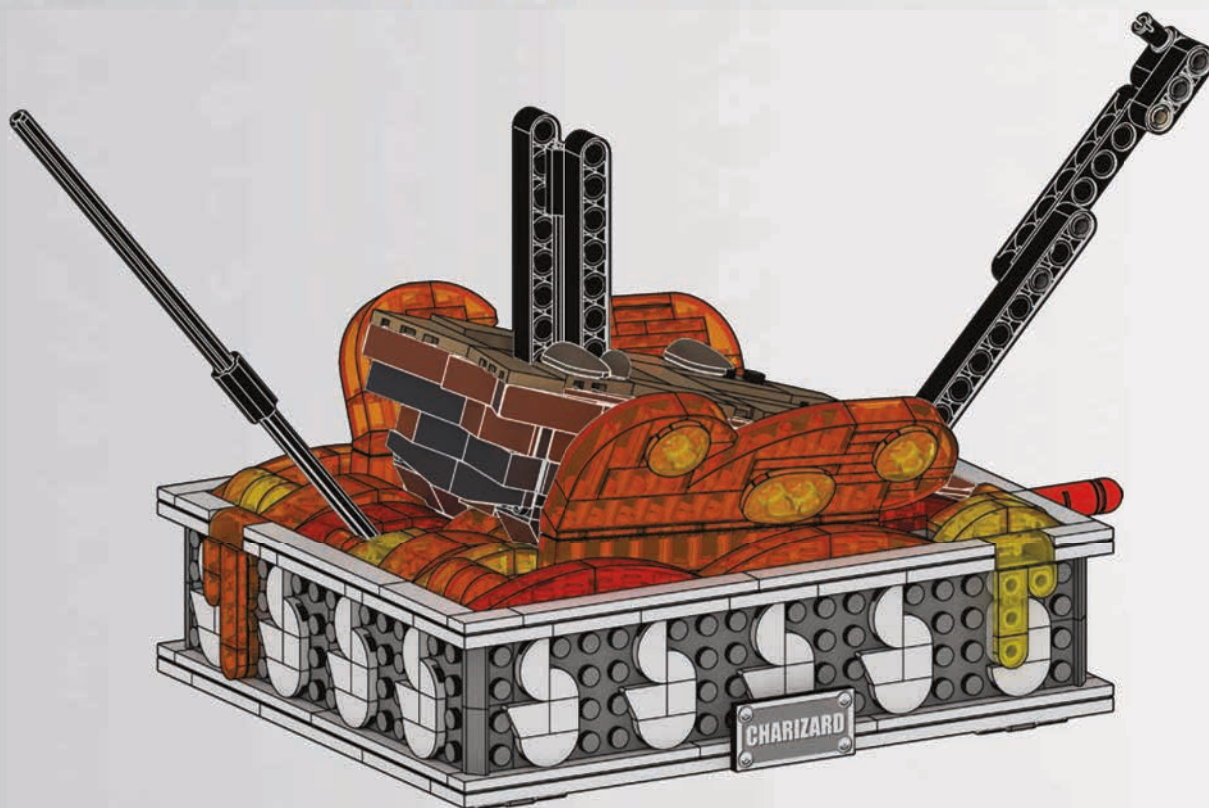

2



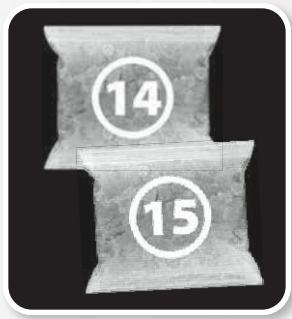

**218**

1x 2x 1x 1x 1x

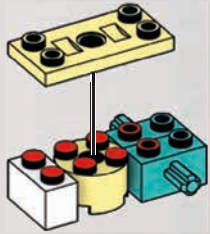
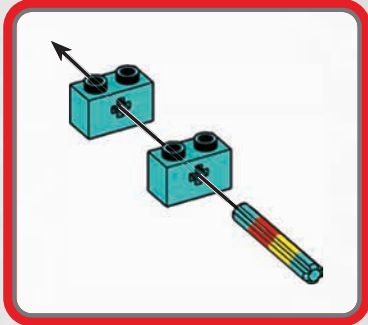

**219**

2x 2x

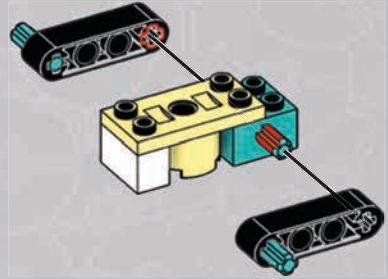
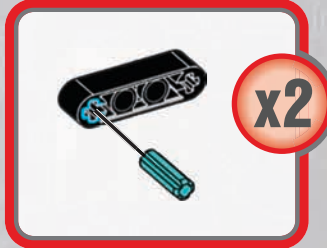

**220**

1x 2x 2x 1x

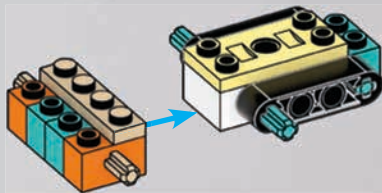
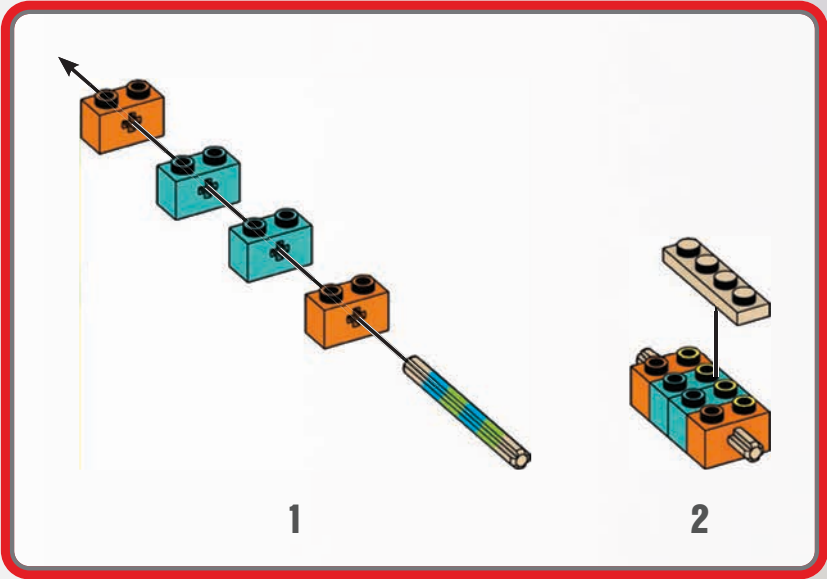

221



2x 1x

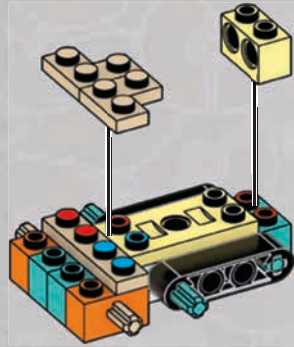

1

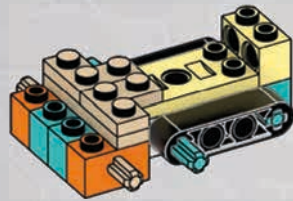

2

222



2x 2x 1x

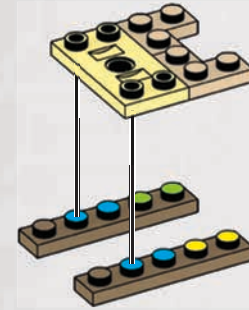

223



2x 4x 1x 1x 2x

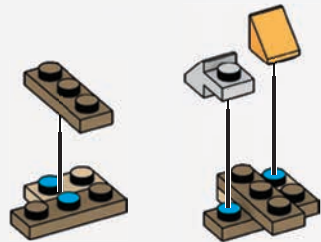

1

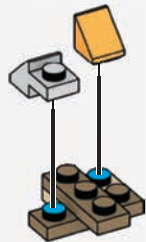

2

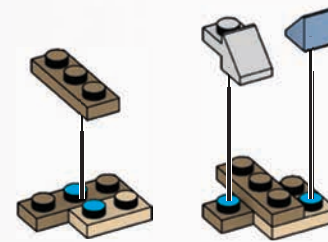
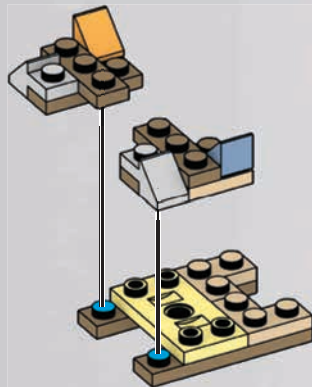

1

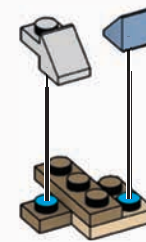

2



224

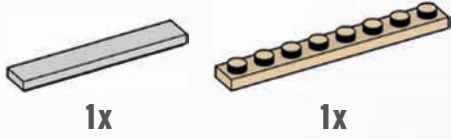

1x

1x

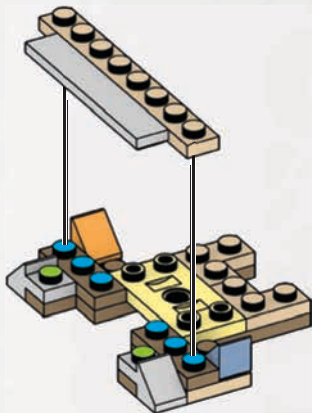

1

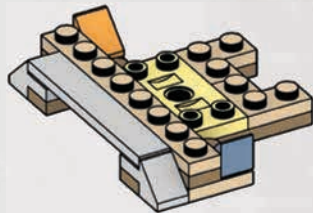

2

225

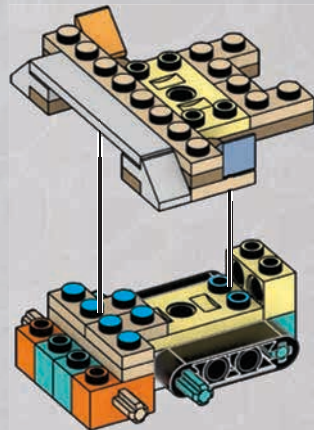

226



2x

2x

227



3x

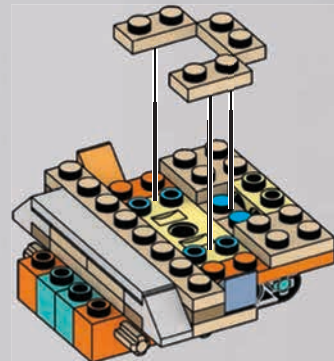
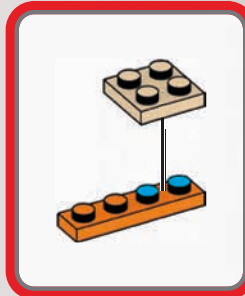
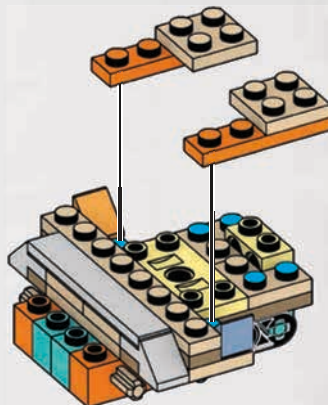
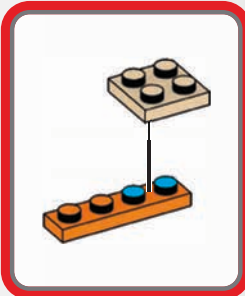



228

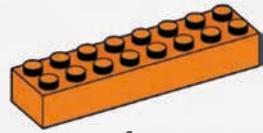

1x

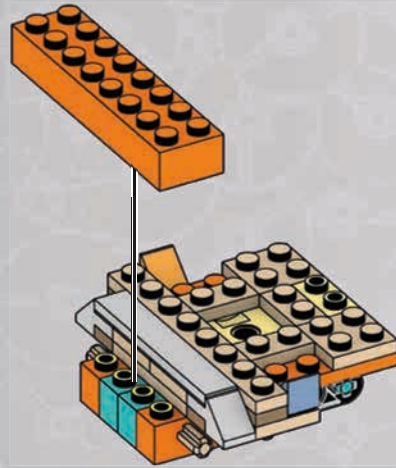

229

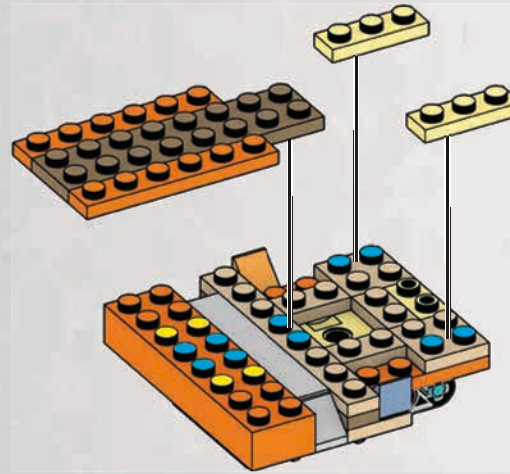
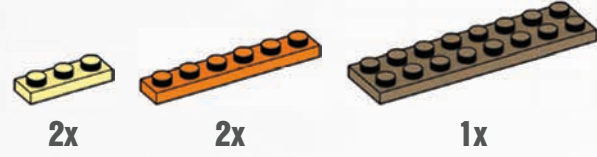

1

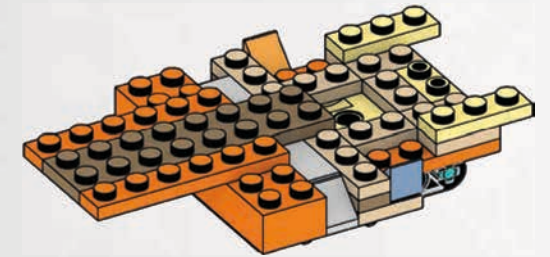

2

230



2x

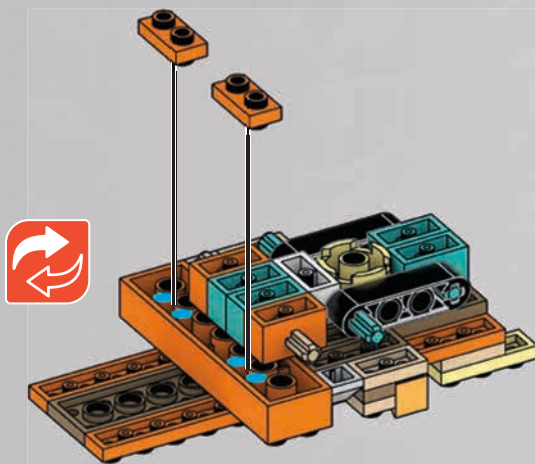

231



1x

4x

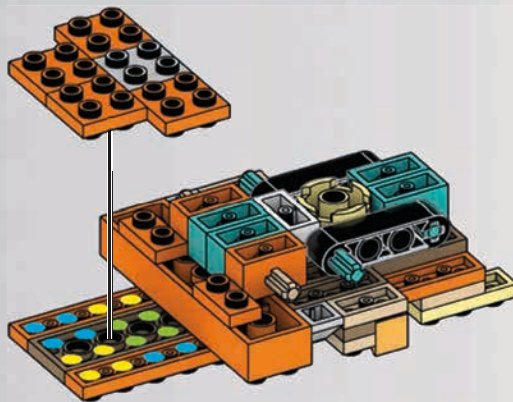

232



1x

1x

1x

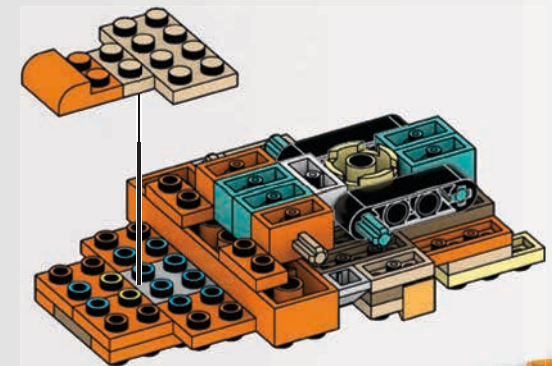

233



1x 1x

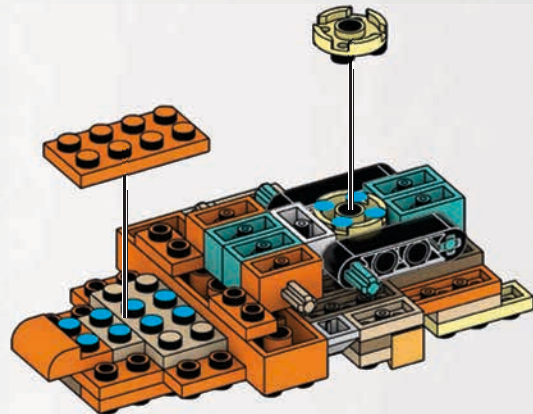

234

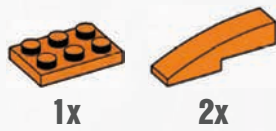

1x 2x

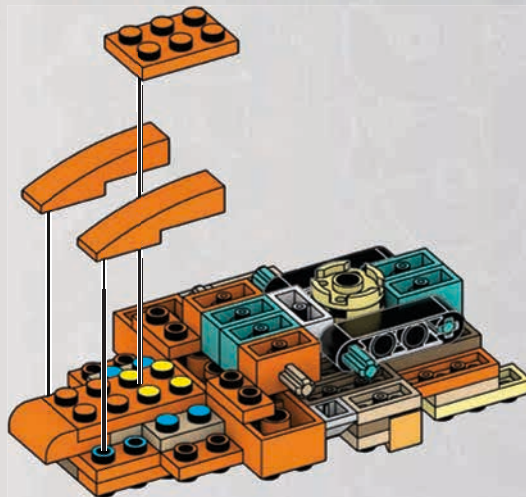

235

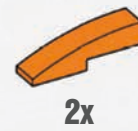

2x

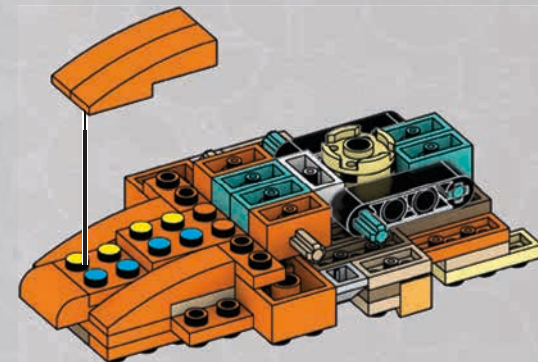

236

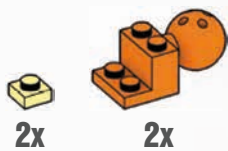

2x 2x

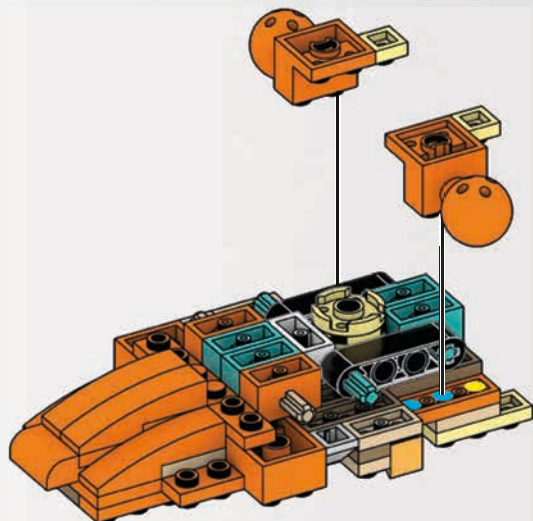

237



2x 2x

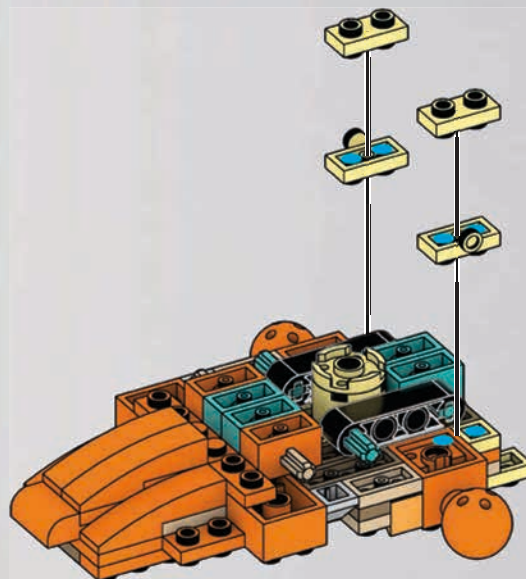

1

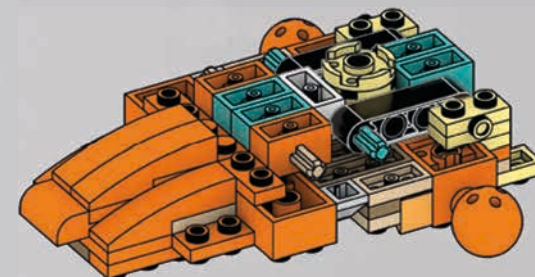

2

238



1x

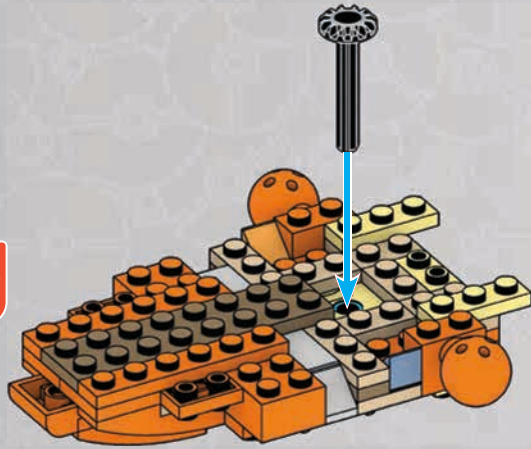

239

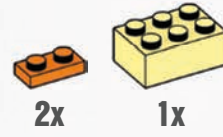

2x

1x

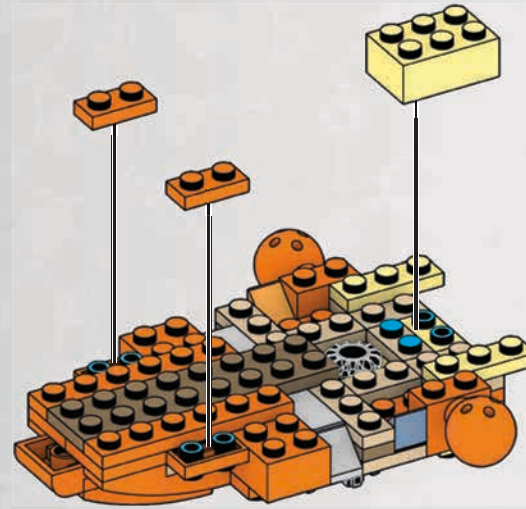

1

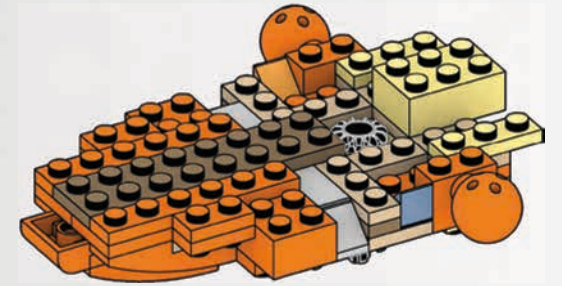

2

240



2x

1x

2x

1x

1x

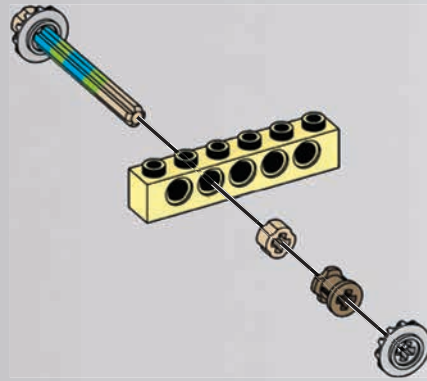
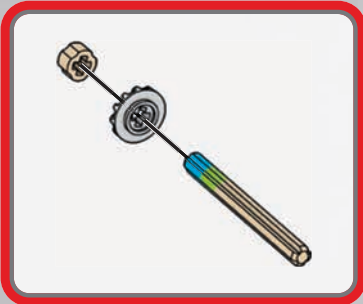

241



1x

1x

1x

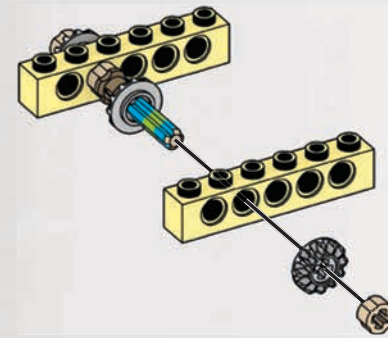

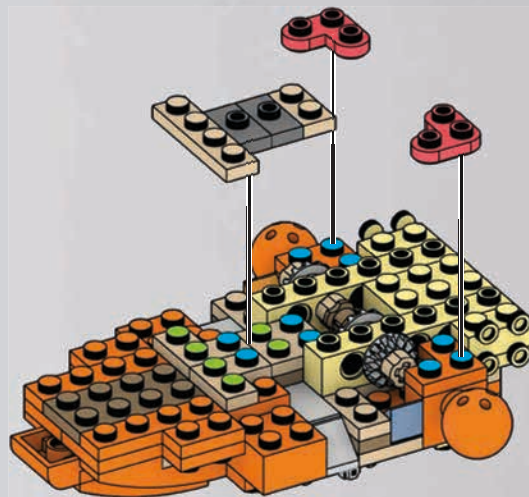
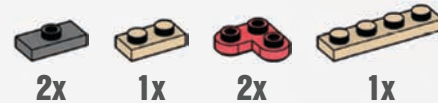
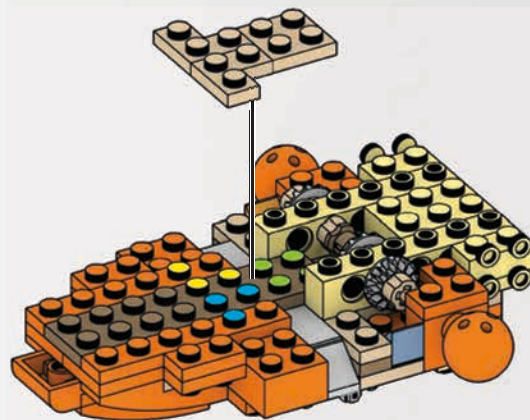
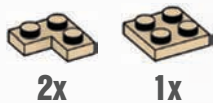
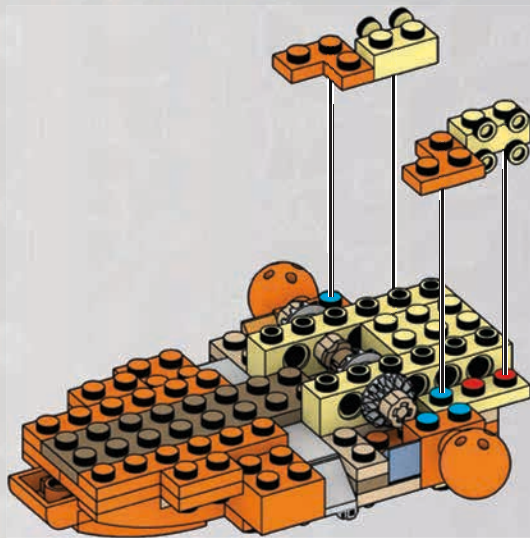
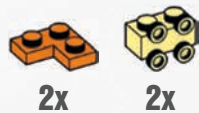
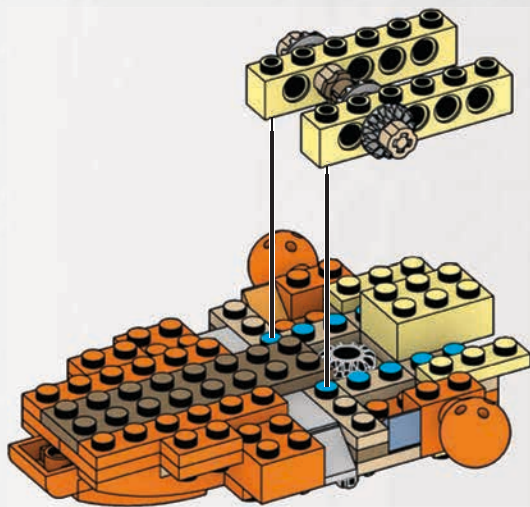

246

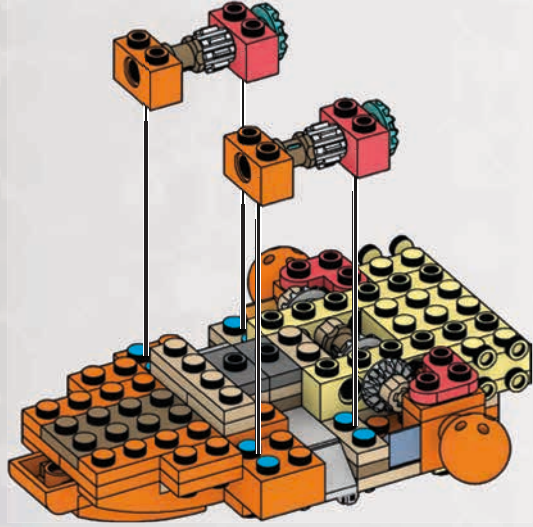
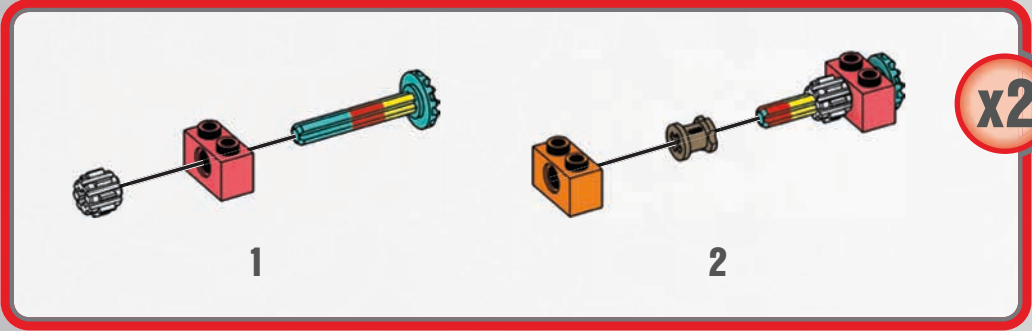

247

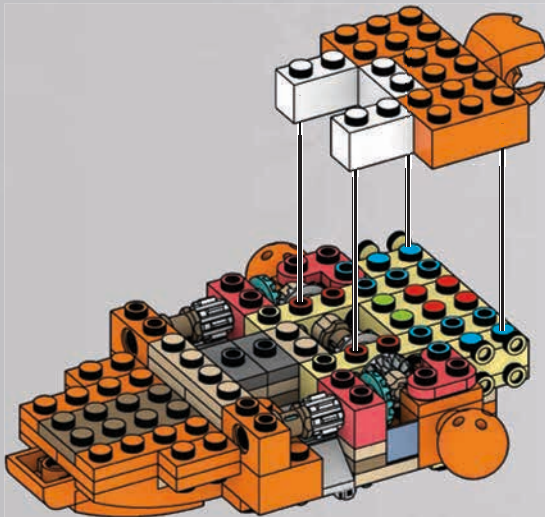

248

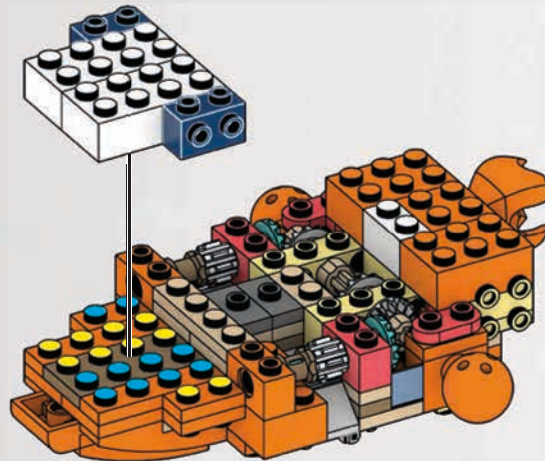
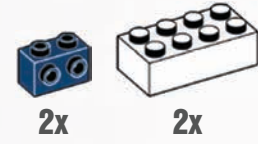

249



2x

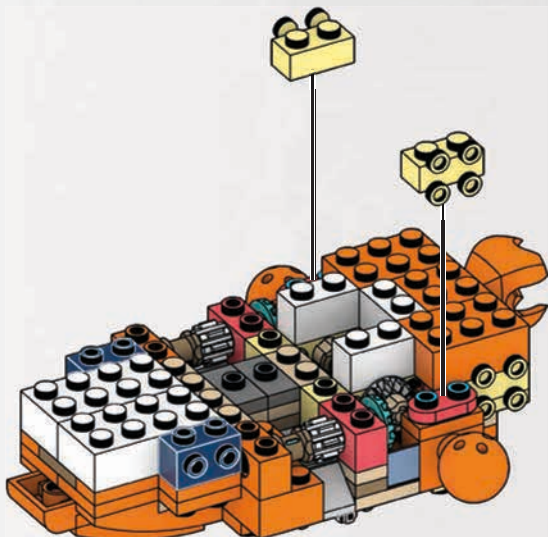

250



1x



2x



2x



1x

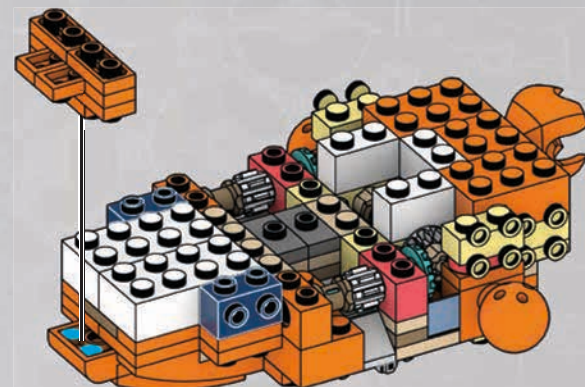
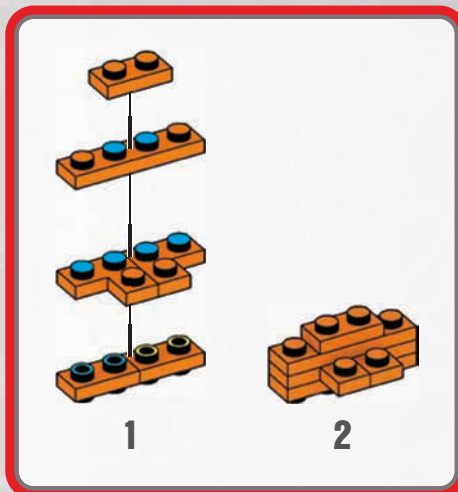

251



1x



2x

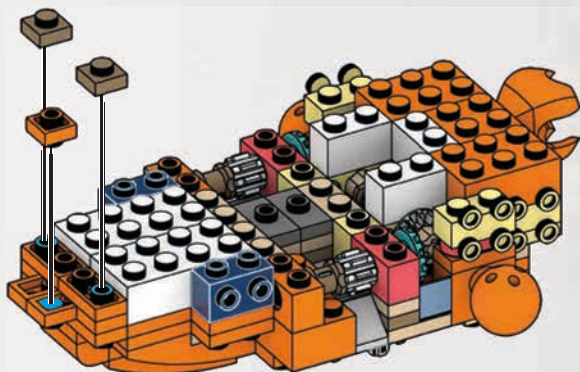

252



1x

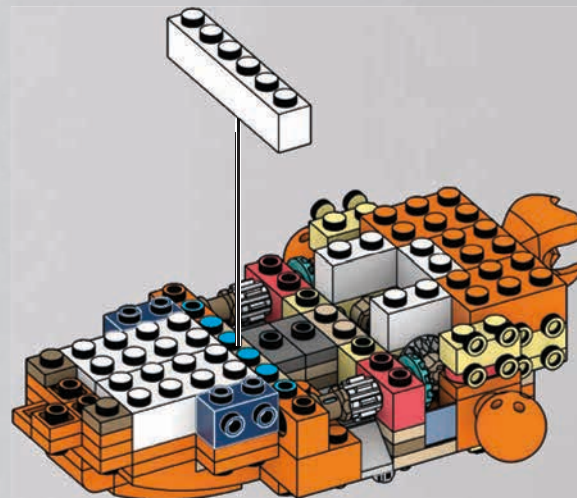

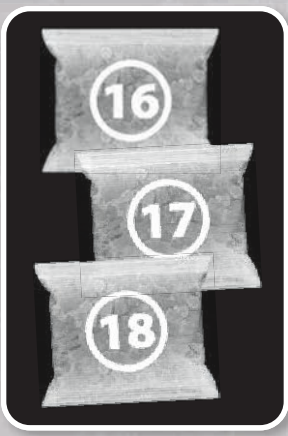

253

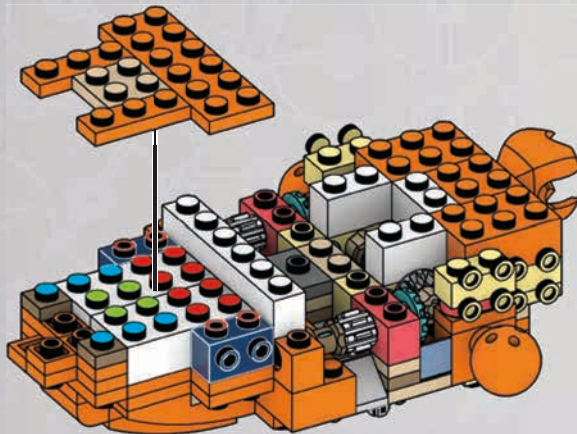

254

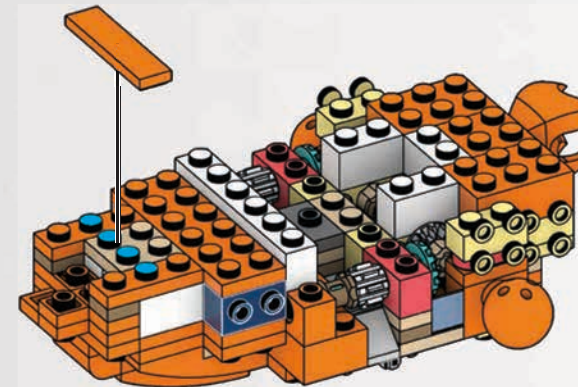
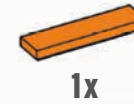

255

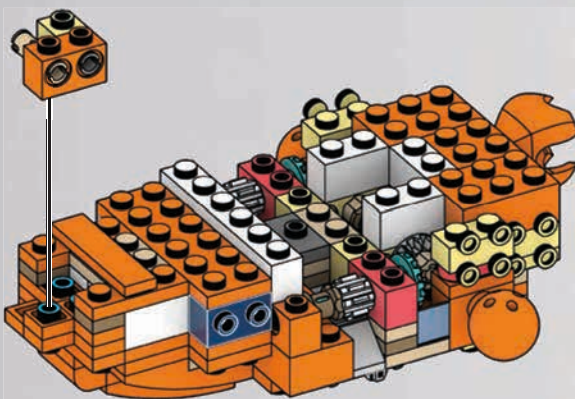
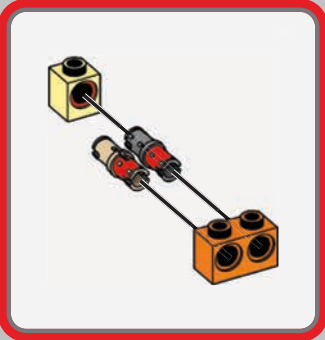

1

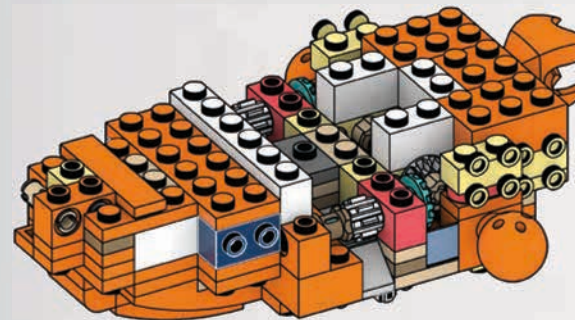

2



256

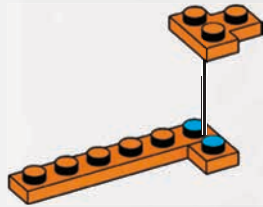
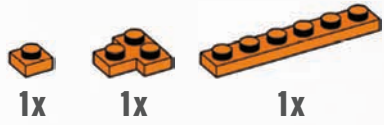

257

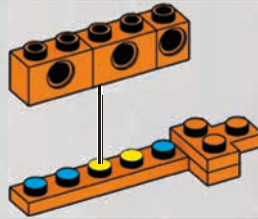

258

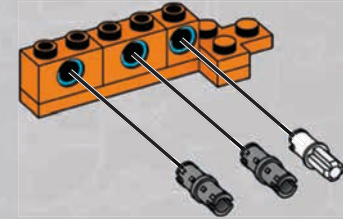

259

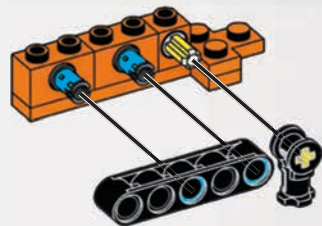

260

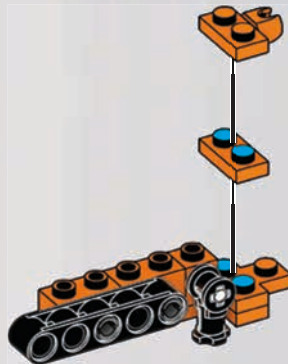
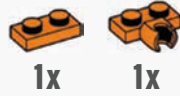

261

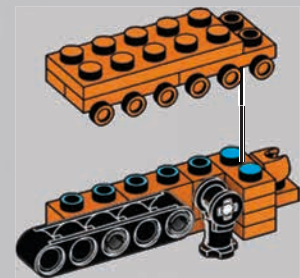
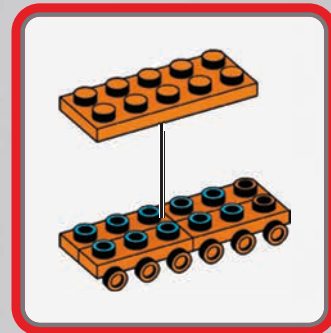



262

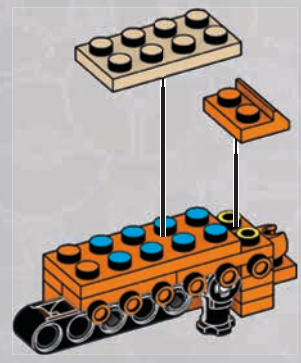
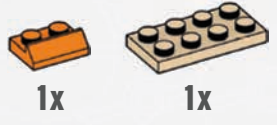

263

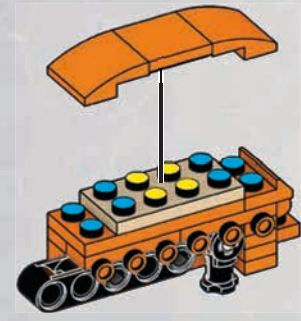
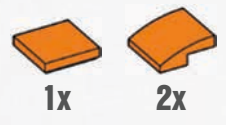

264

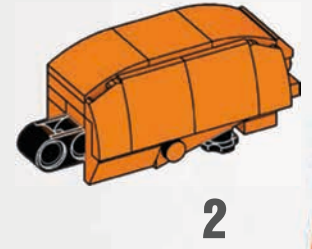
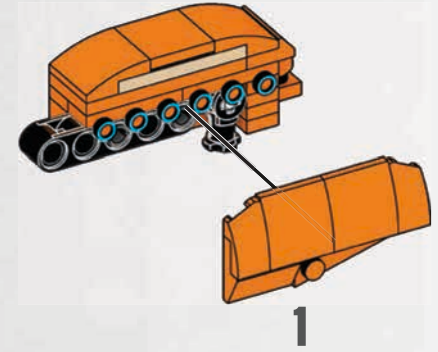
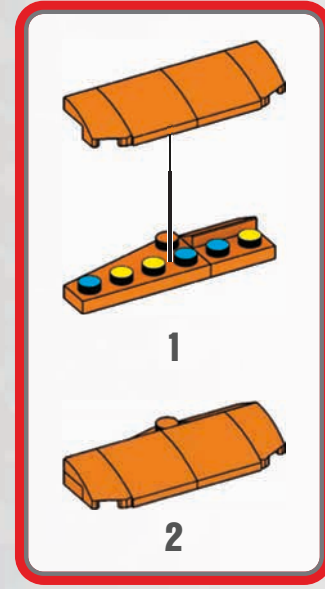
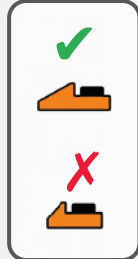
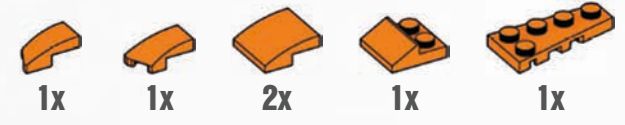

265

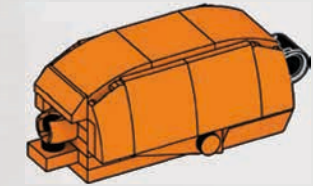
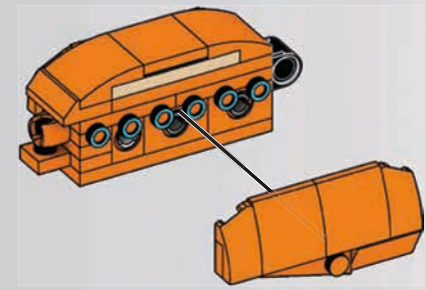
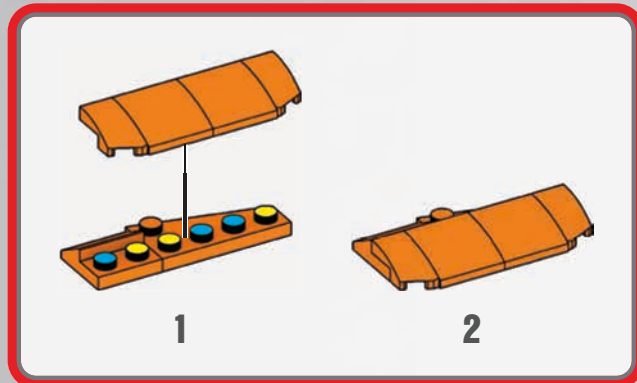
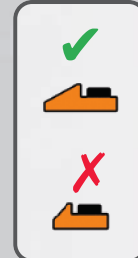

266

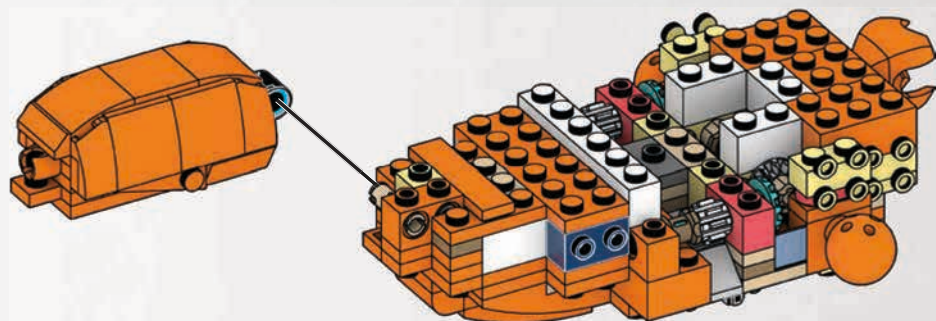

267

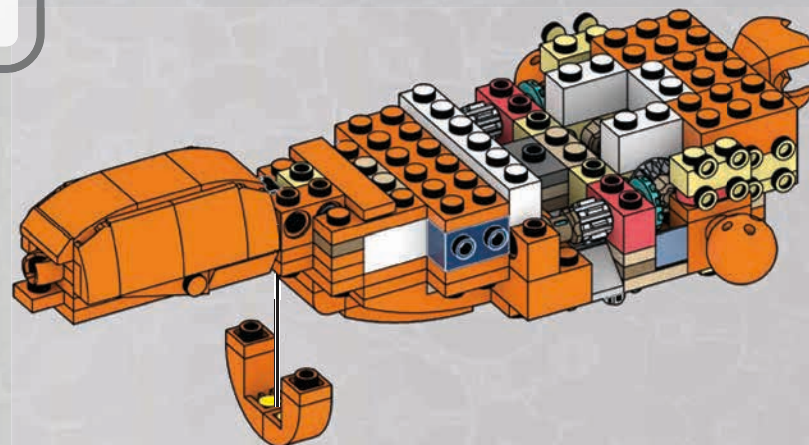
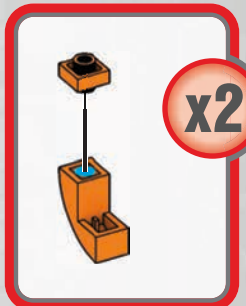

268

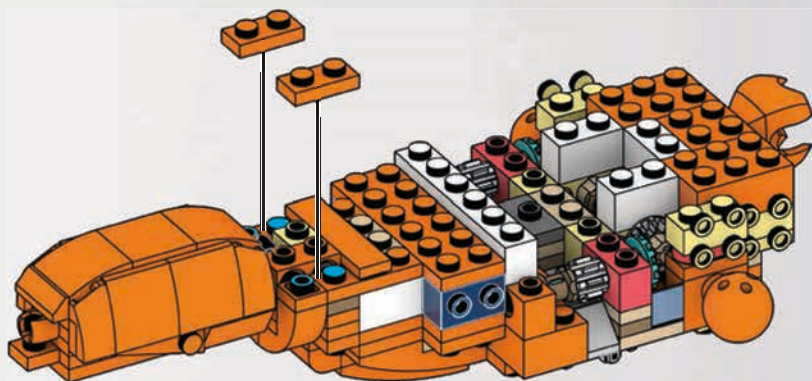

1

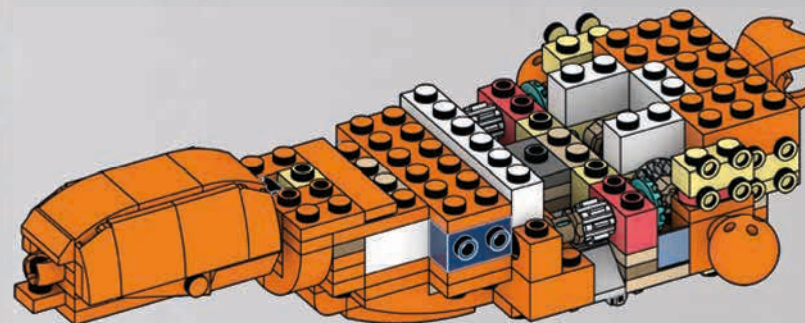

2

269

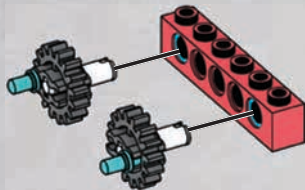
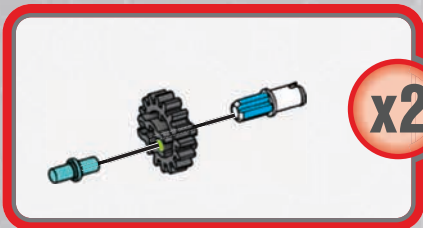

270

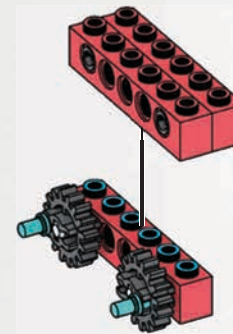
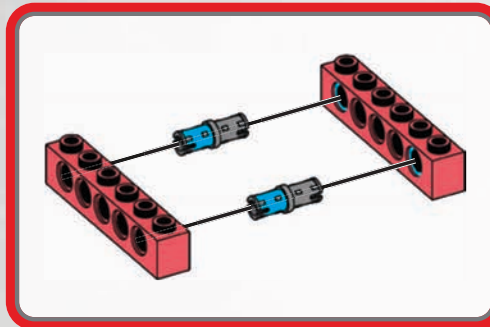
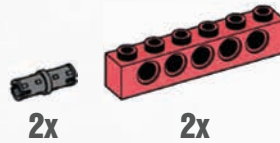

271

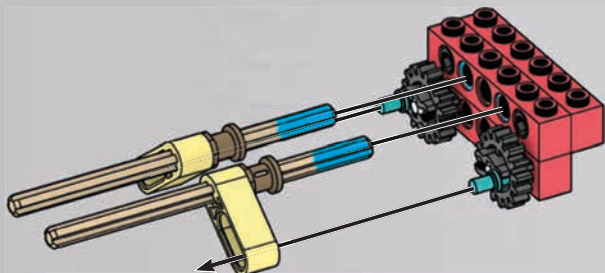
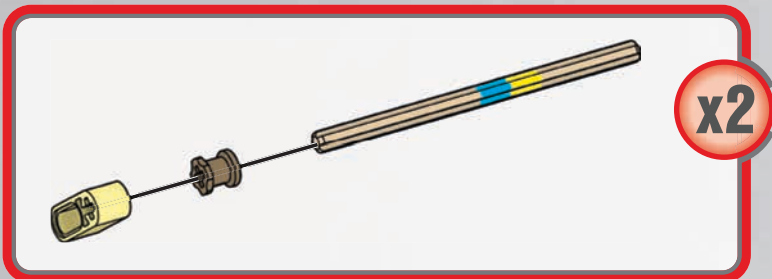

272

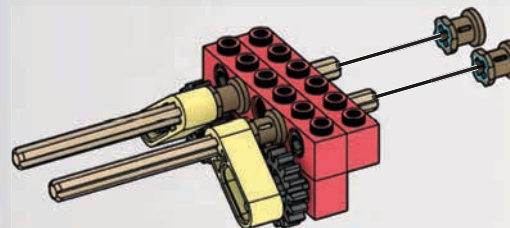

273

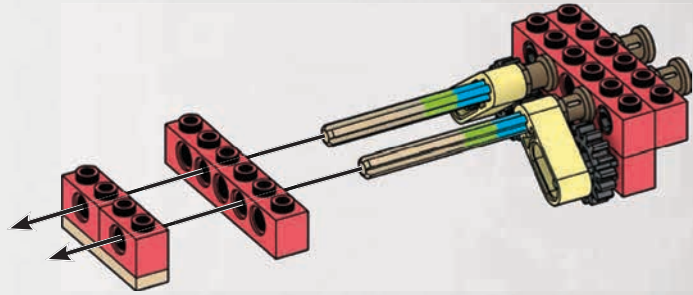
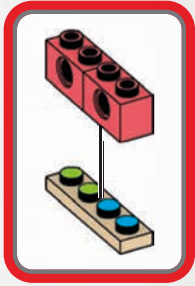
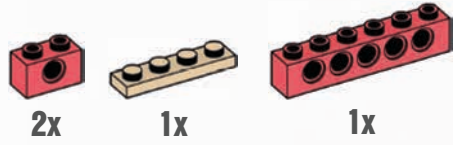

274

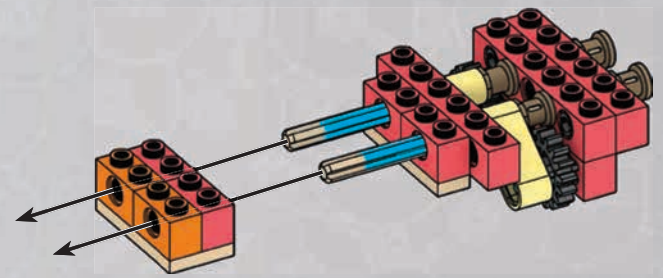
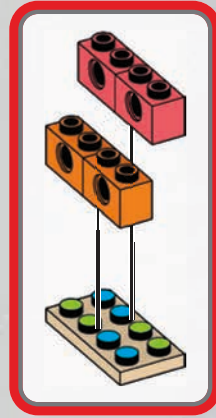

275

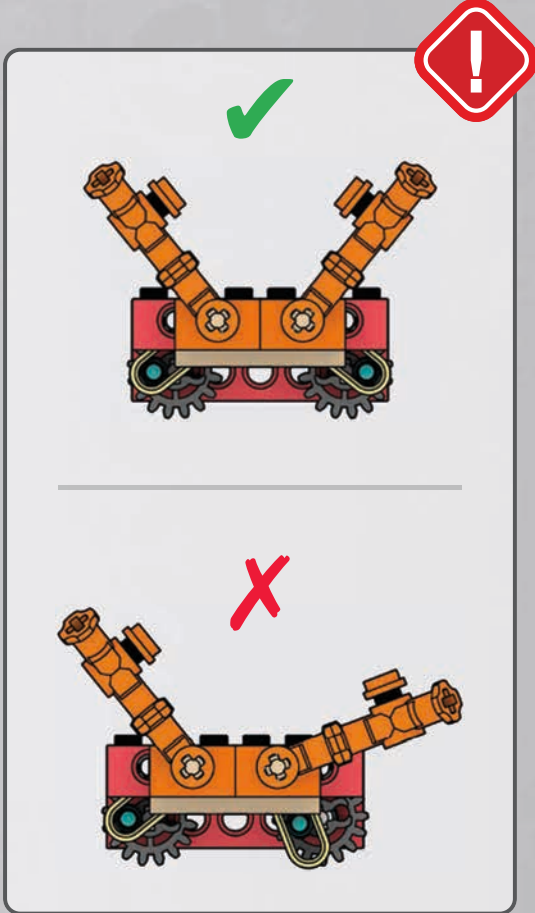
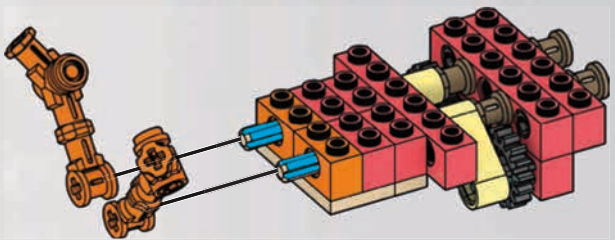
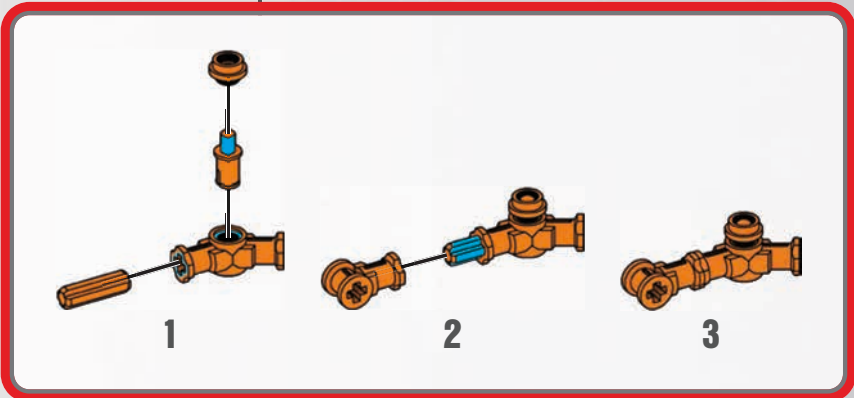
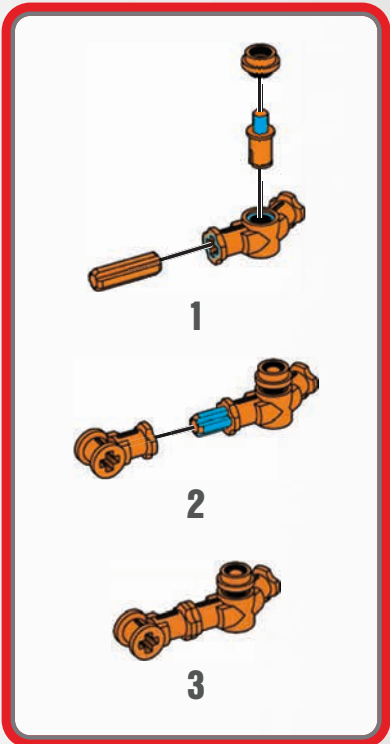
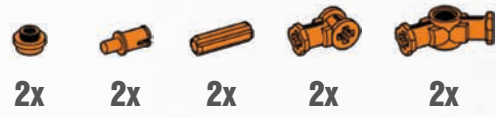

276

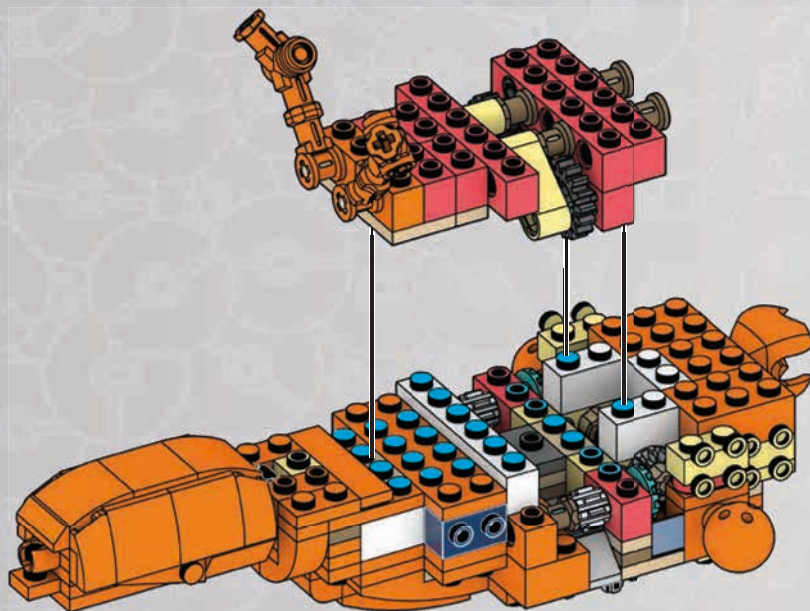

277

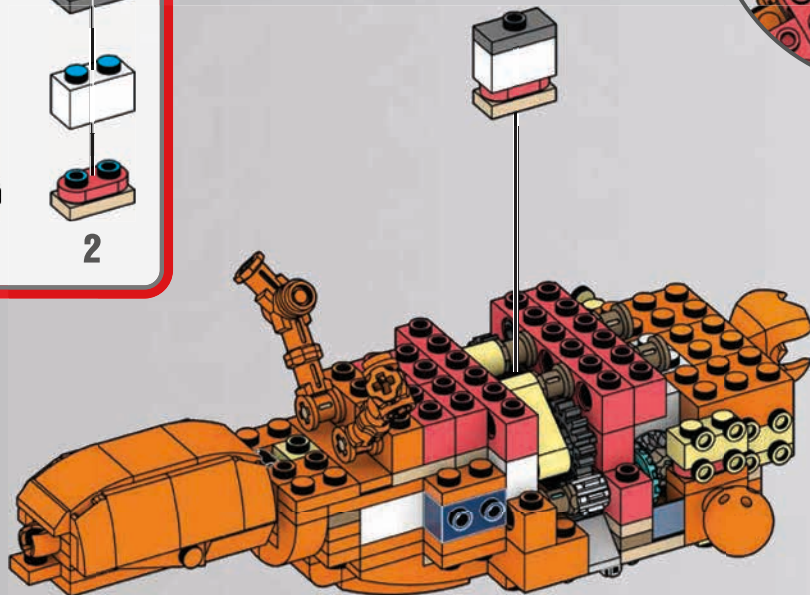
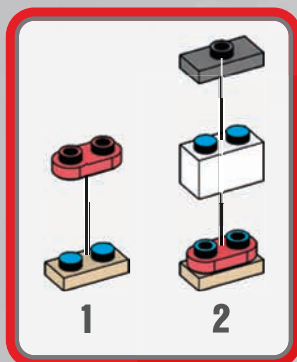
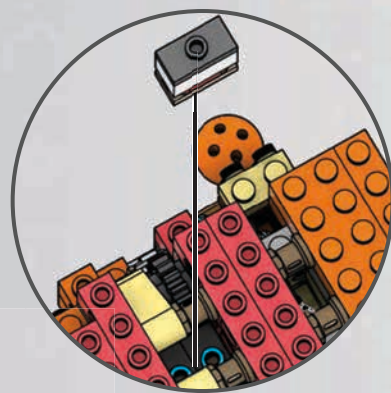



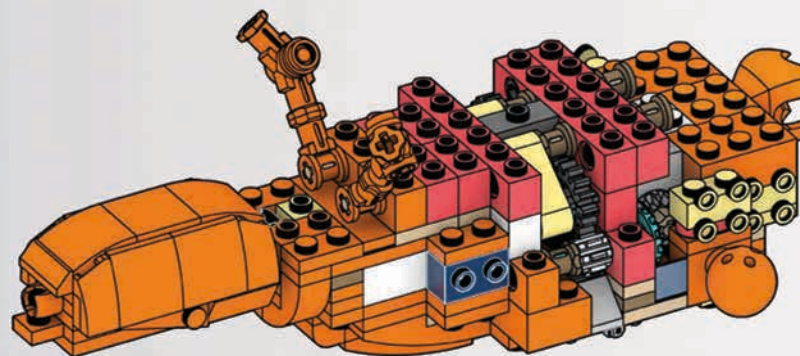



1



2



278

-   
1x
-   
1x
-   
1x
-   
2x
-   
1x
-   
2x
-   
2x

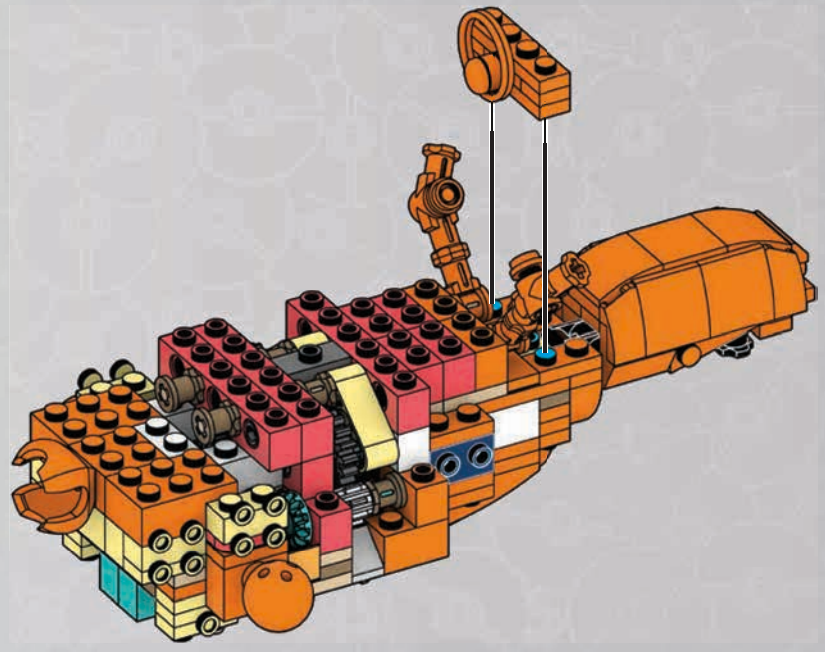
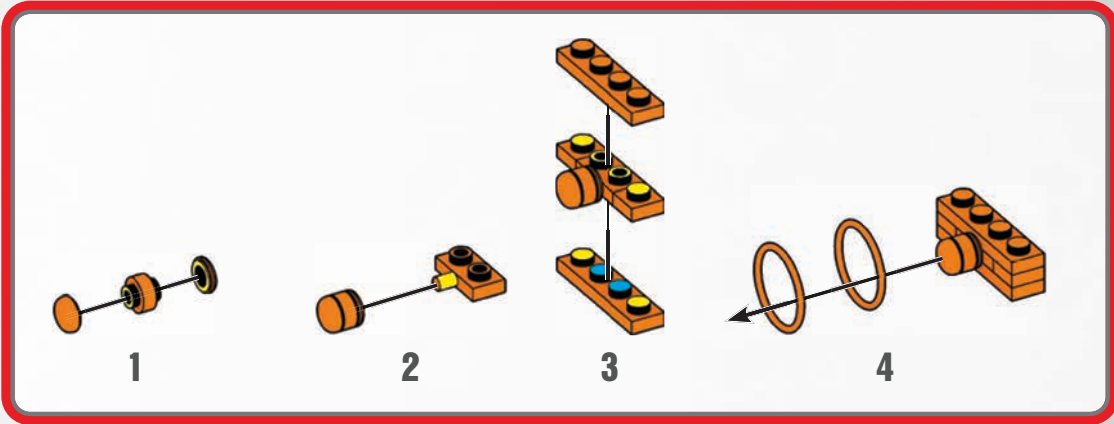

279

1

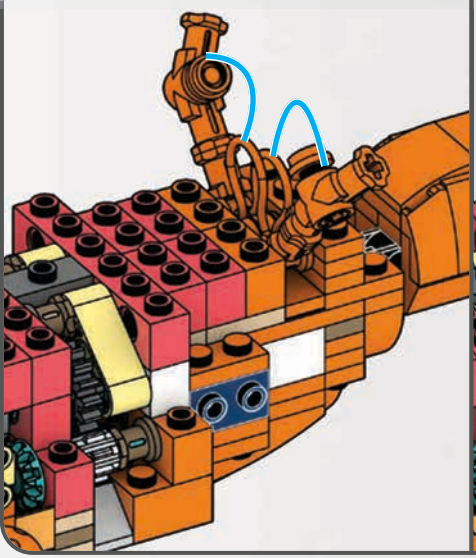

2

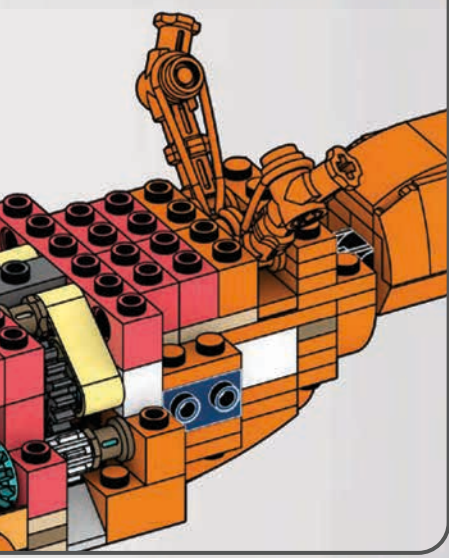

280

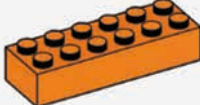
-   
1x
-   
1x

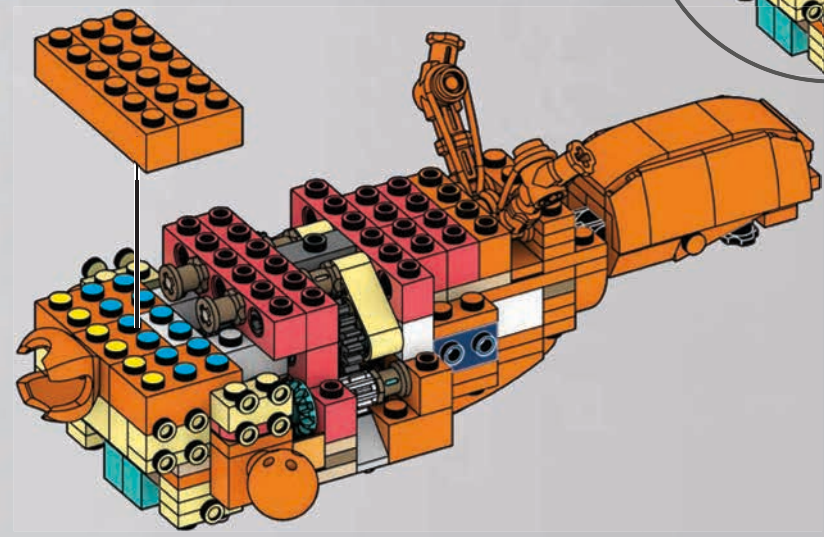
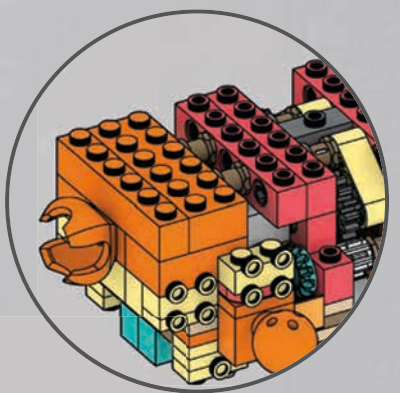

281

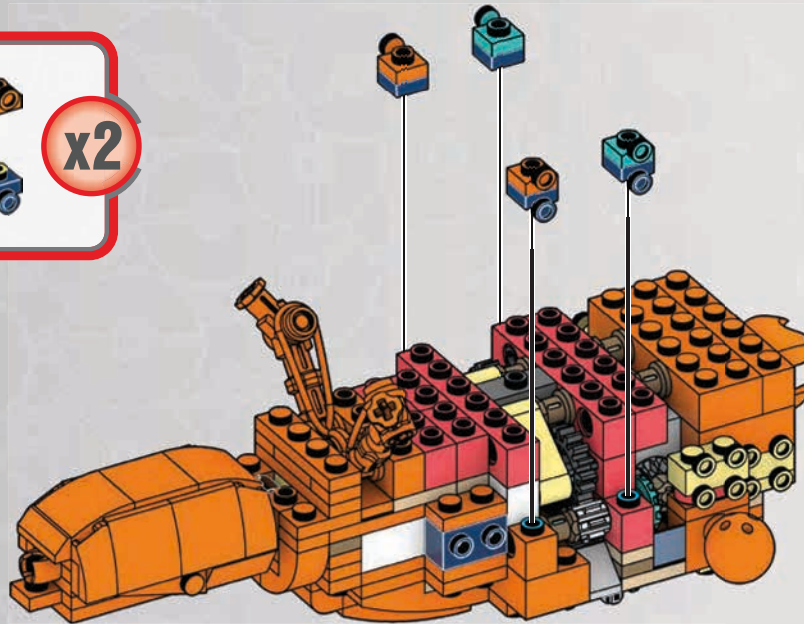
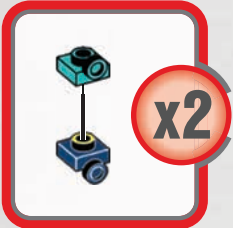
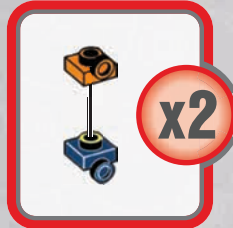

282

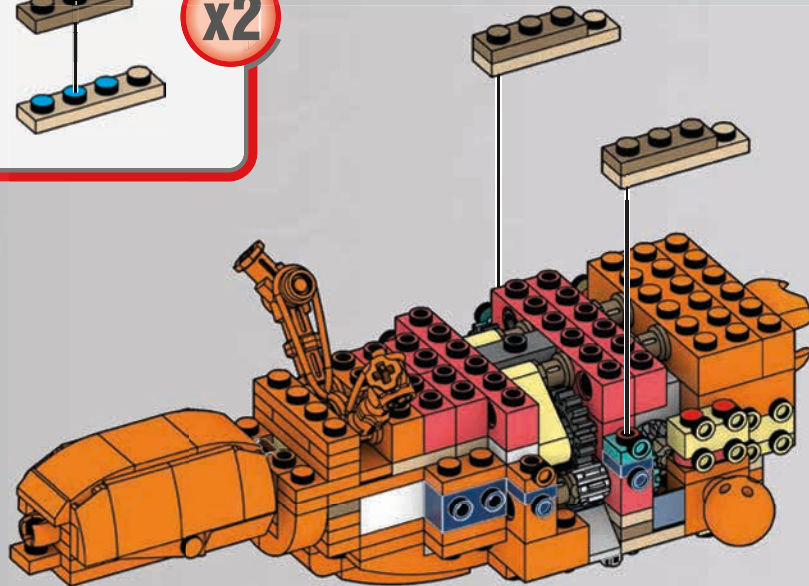
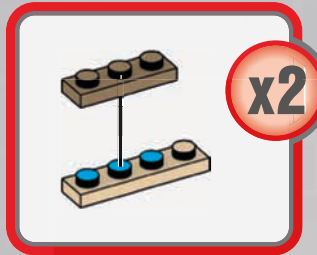

283

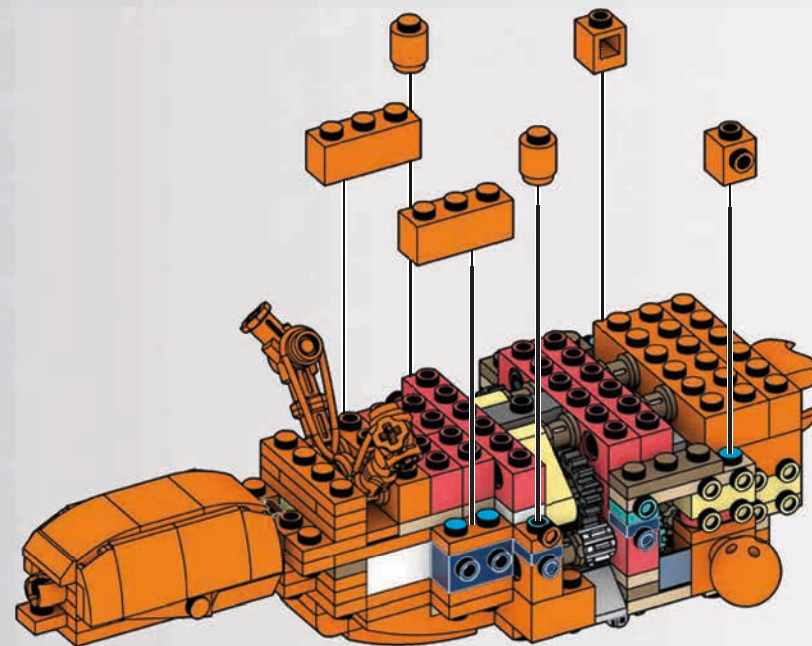
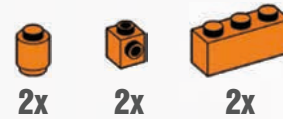

284

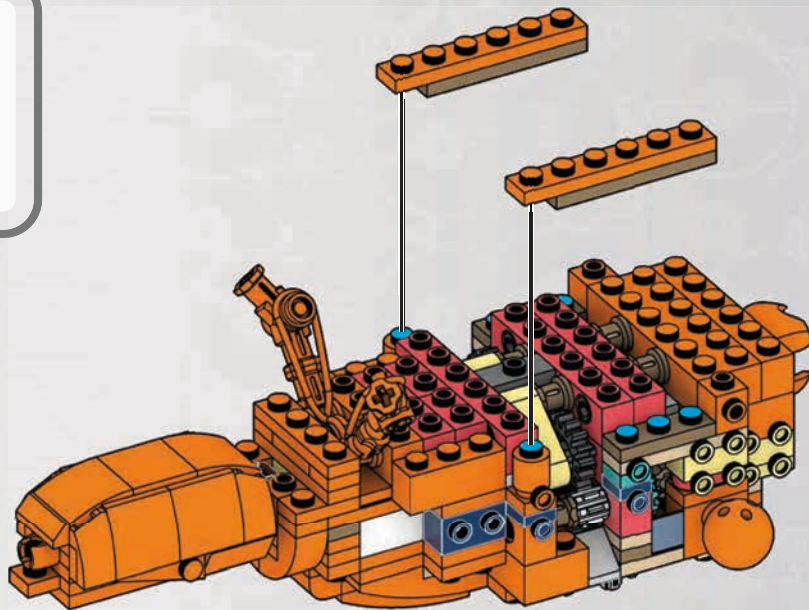
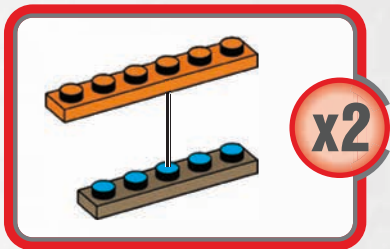
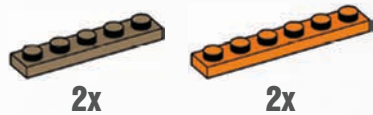

1

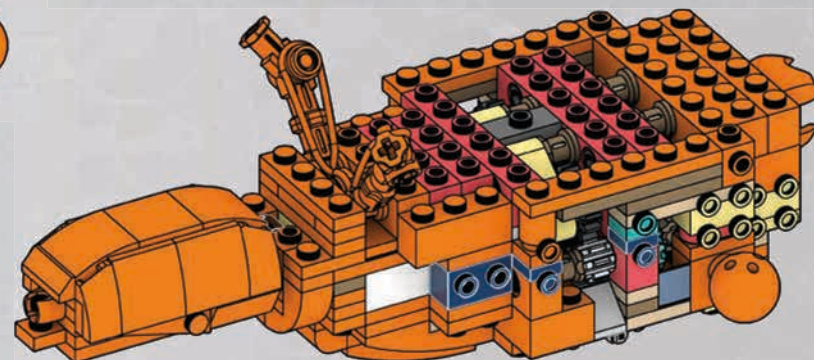

2

285

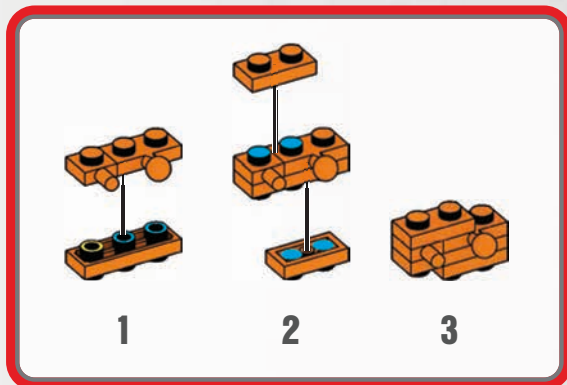

1

2

3

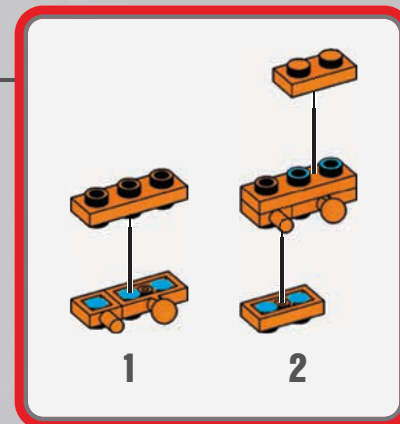
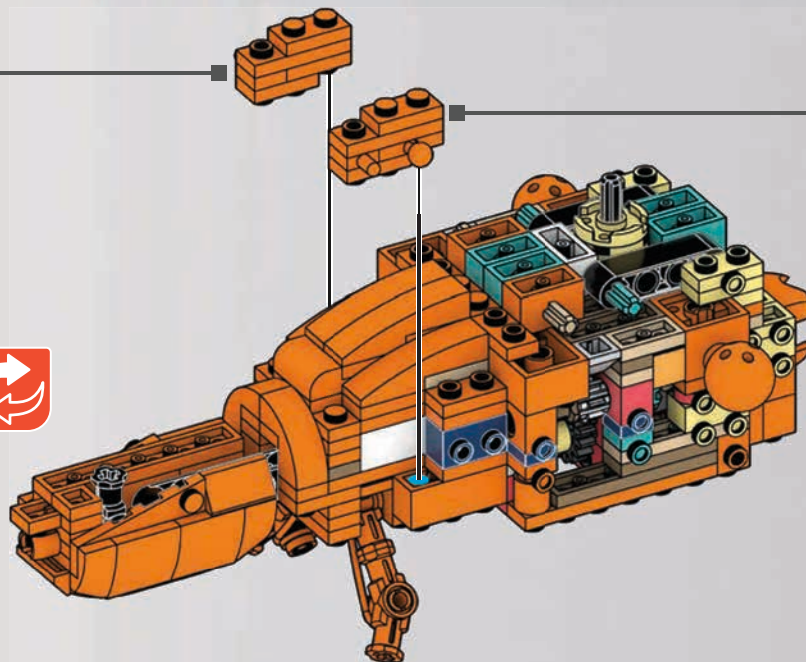

1

2



286



2x

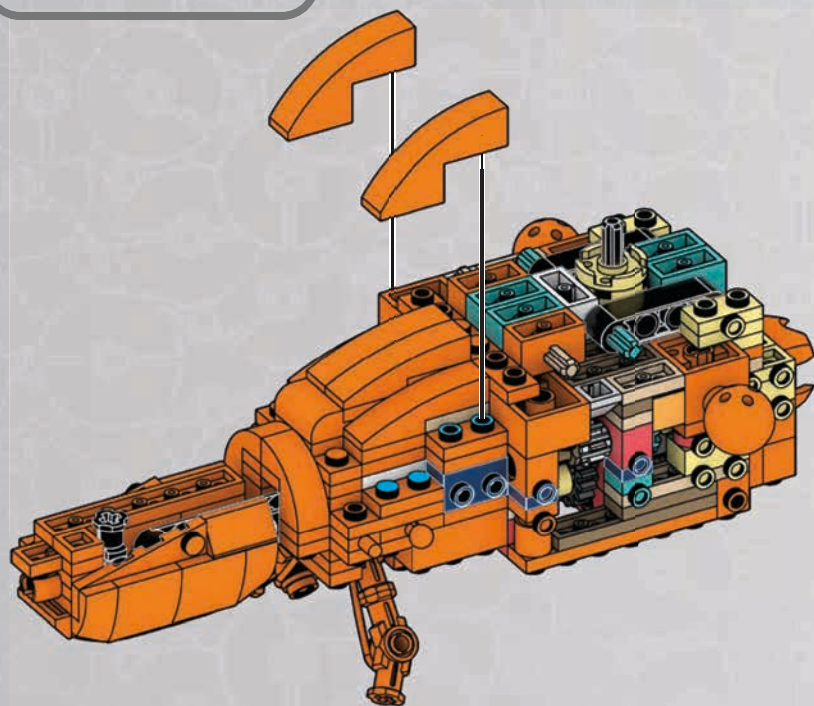

287

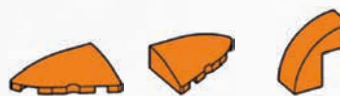

1x

1x

2x

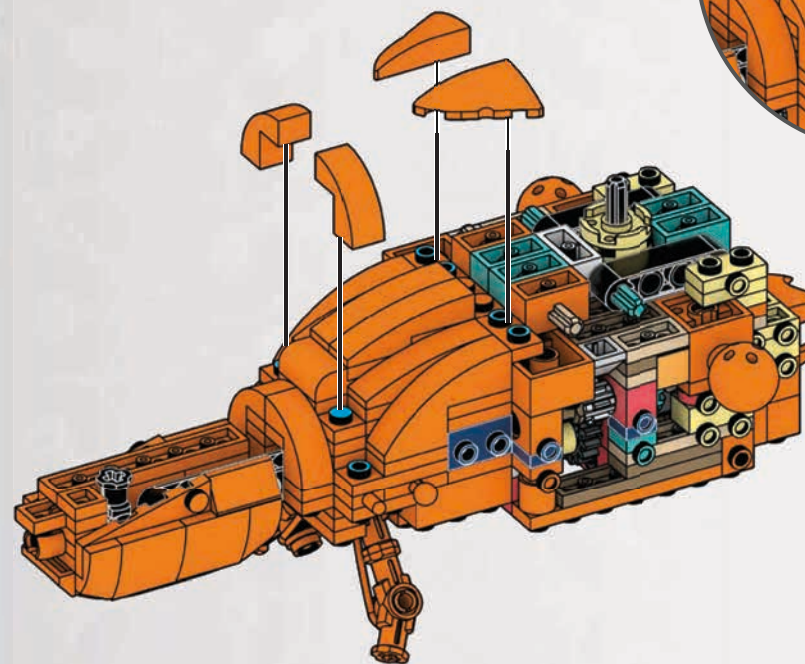
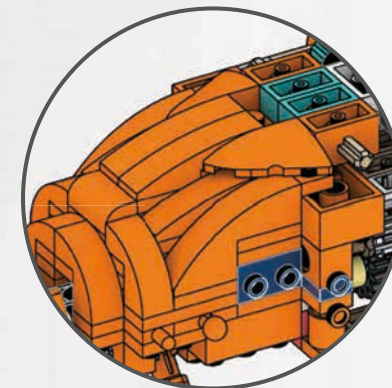

19

20

288



1x



1x



1x

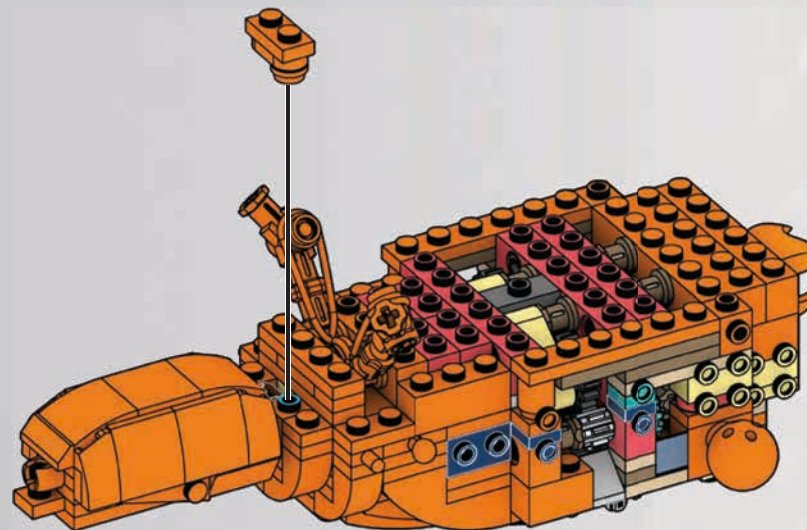
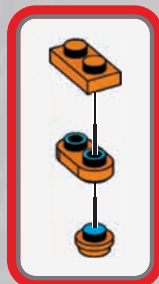

289

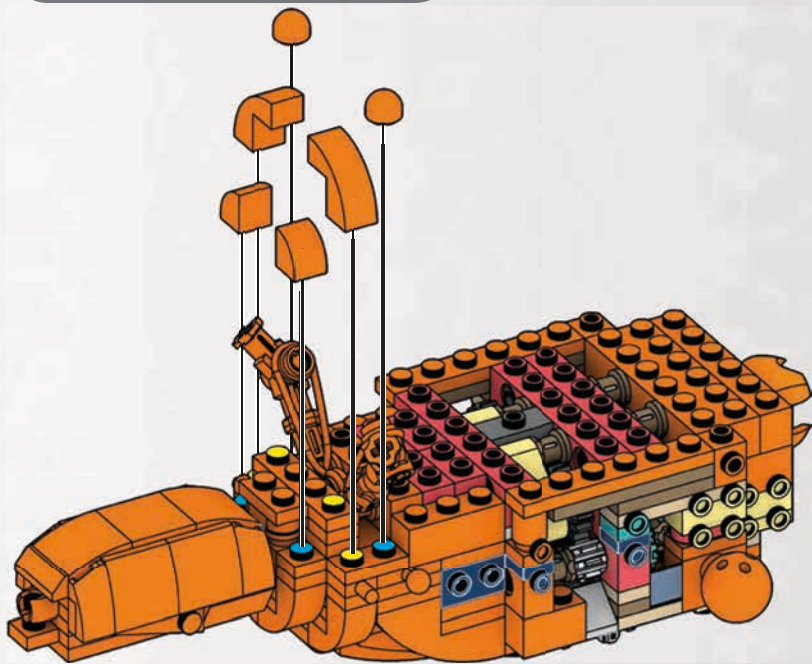

290

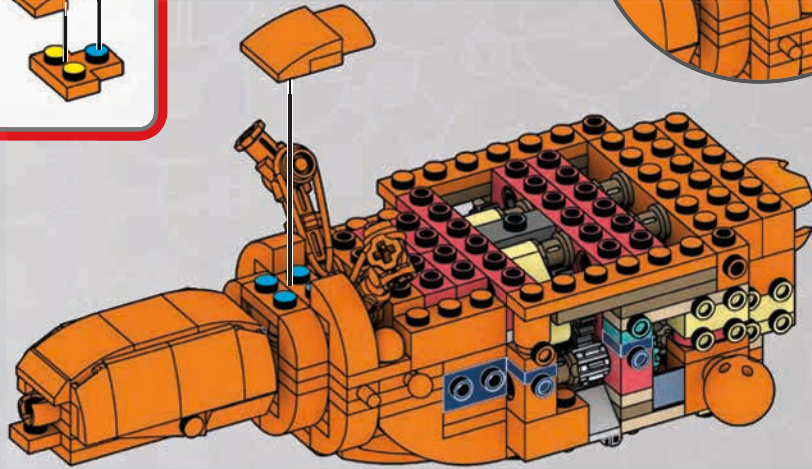
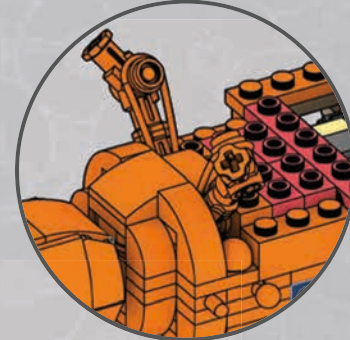
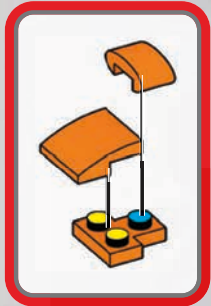
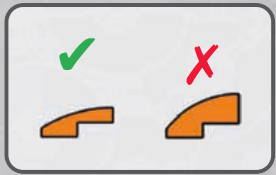

291

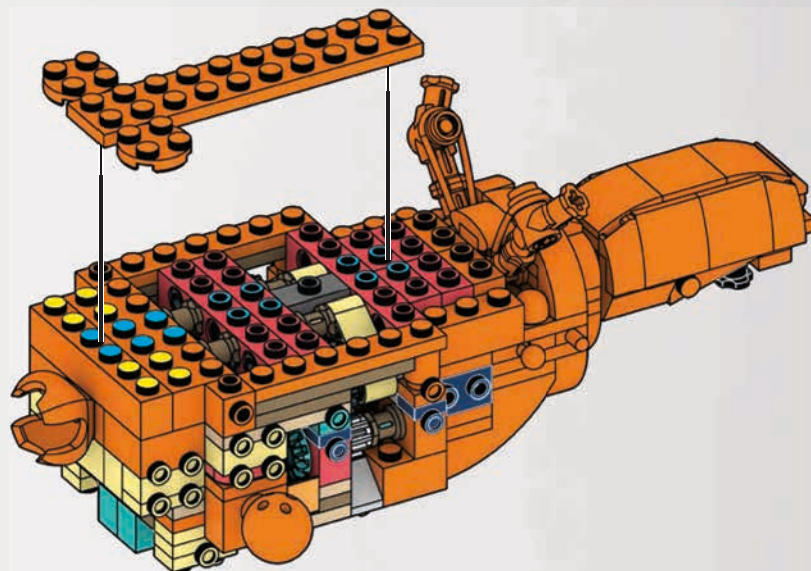
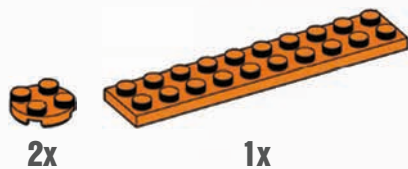

292

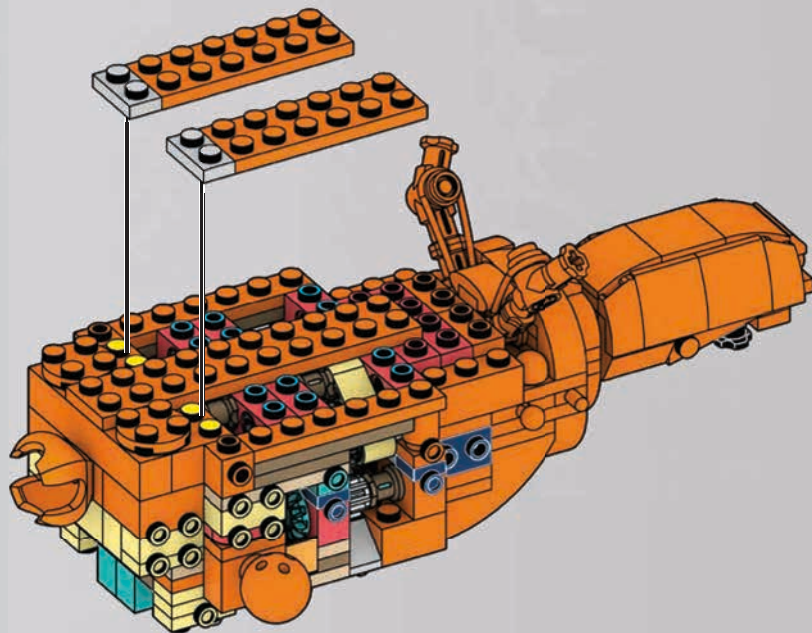
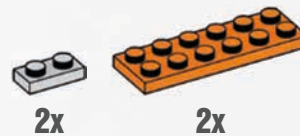

293



2x

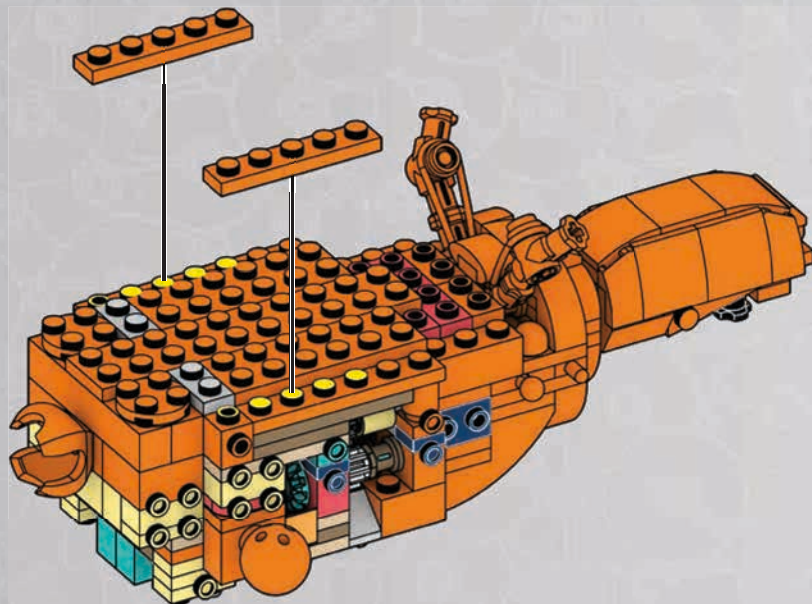

294



1x



2x



2x

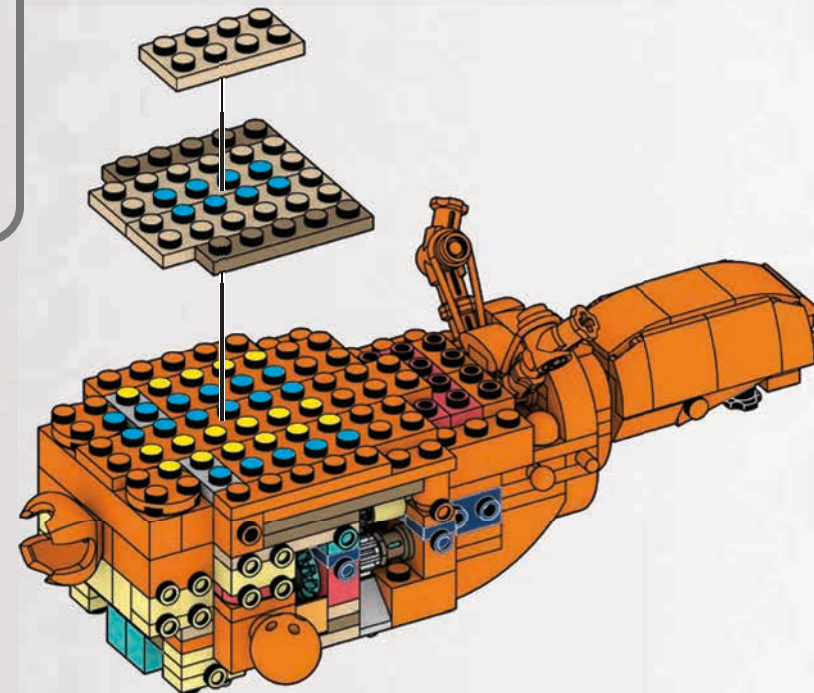

295



2x



2x

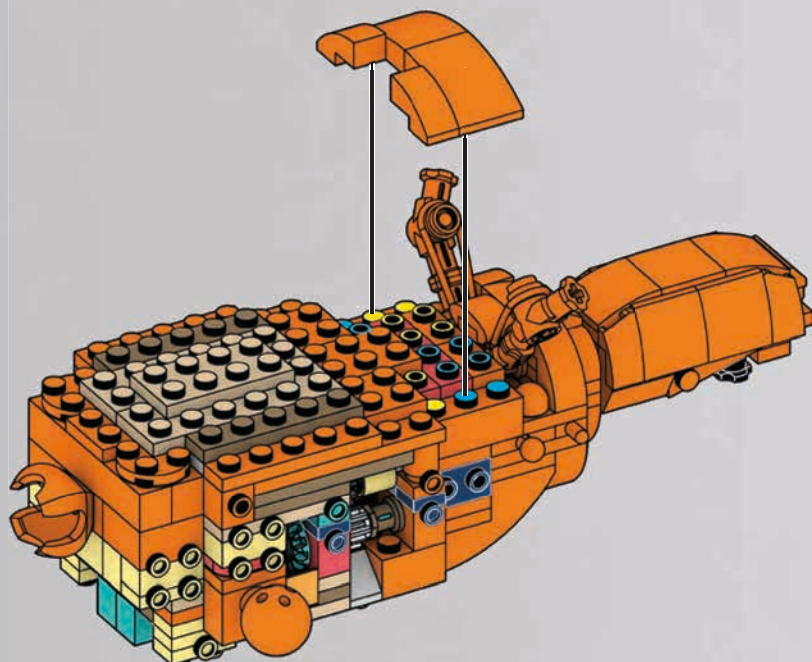

296



2x



2x

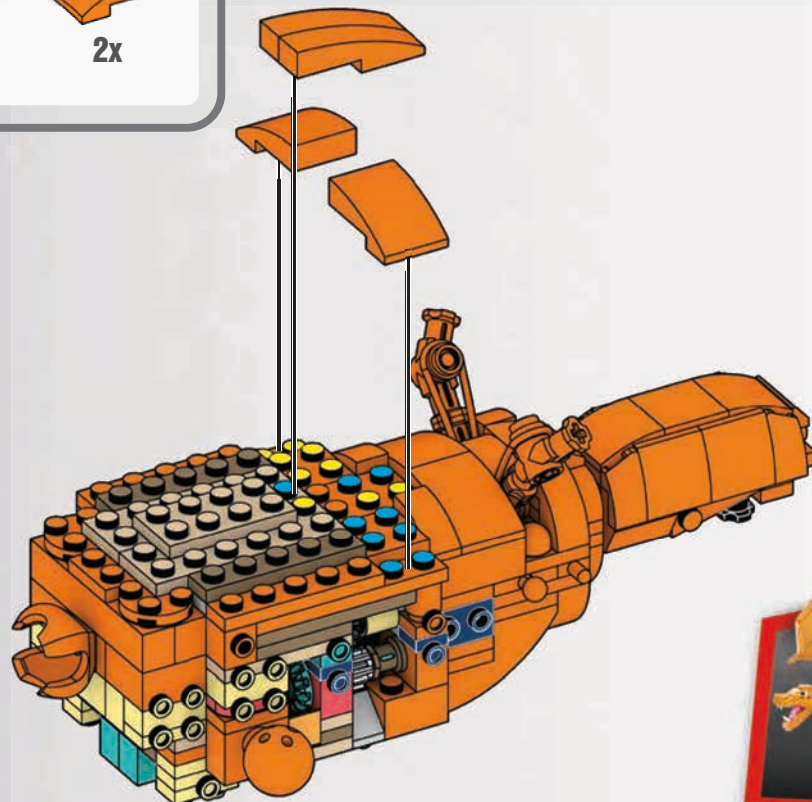

297

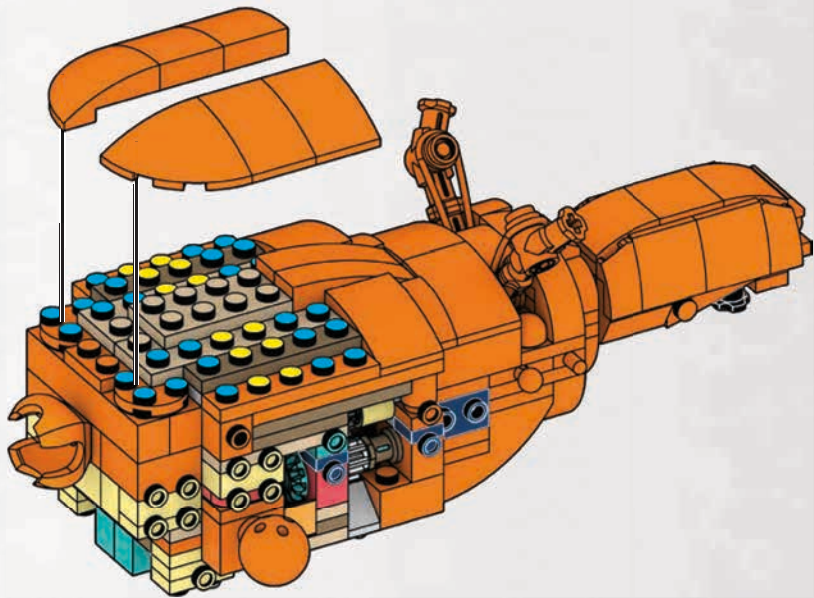
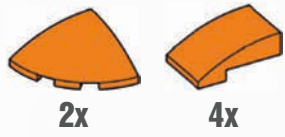

298

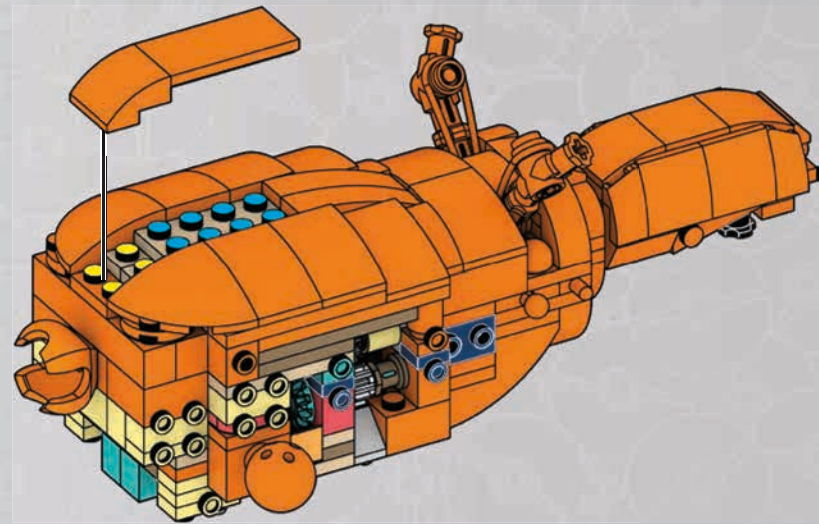
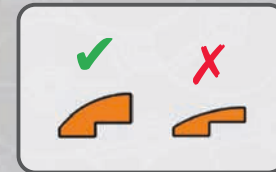
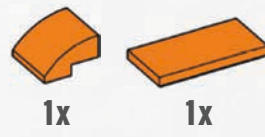

299

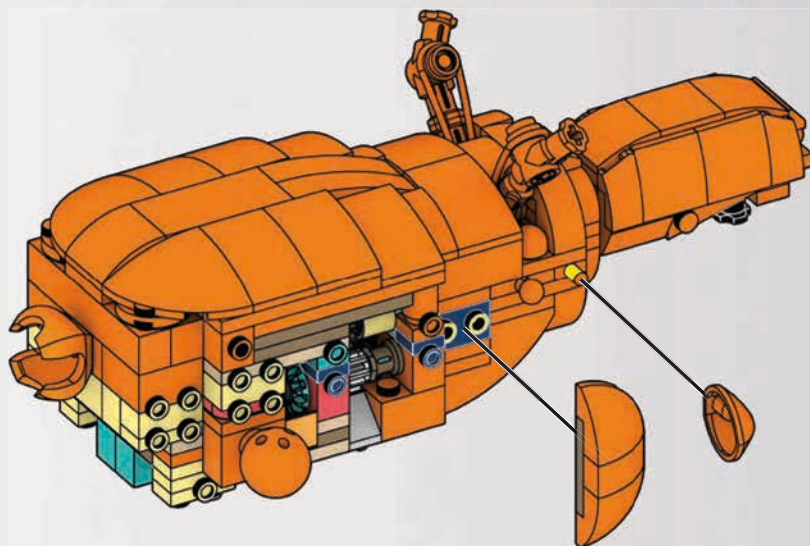
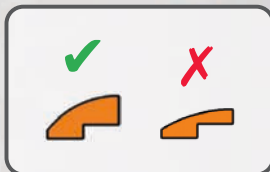

300

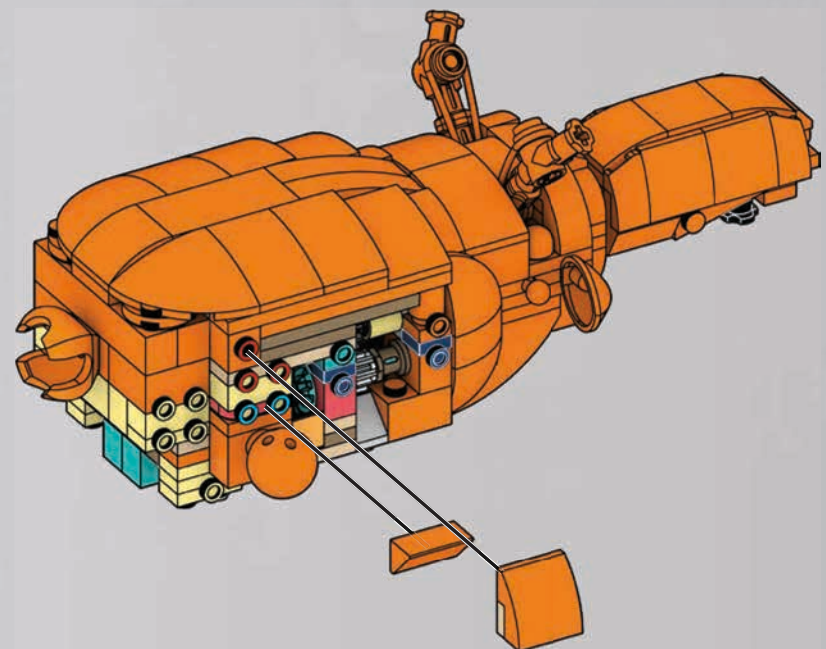

301

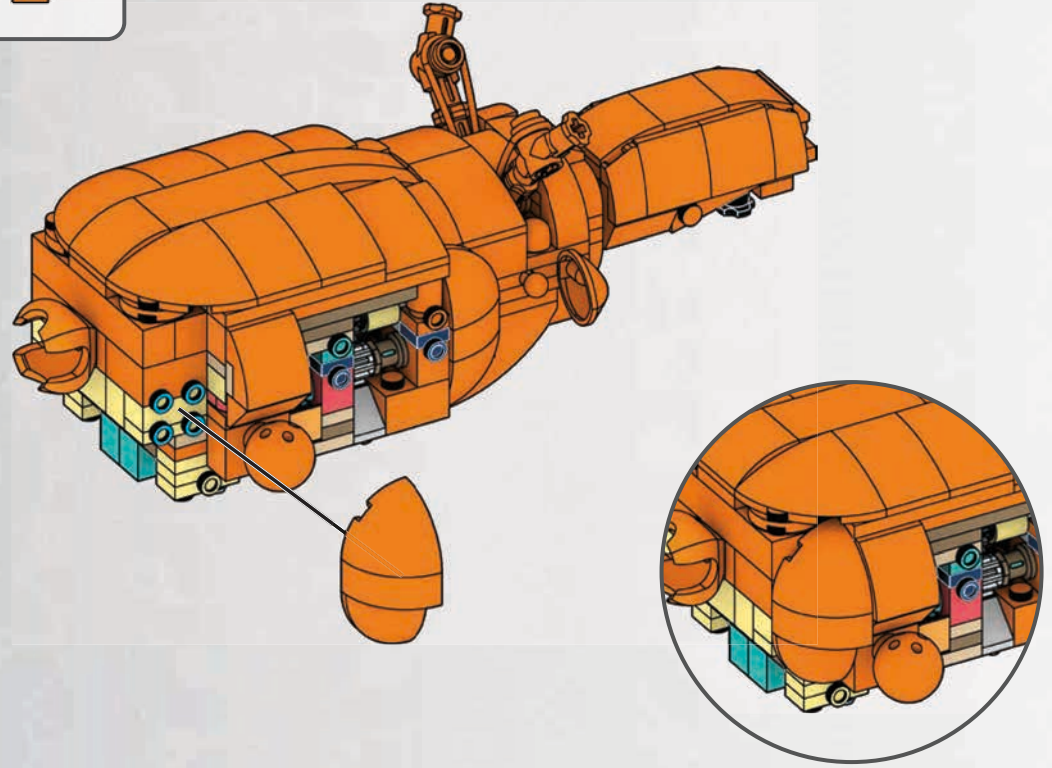
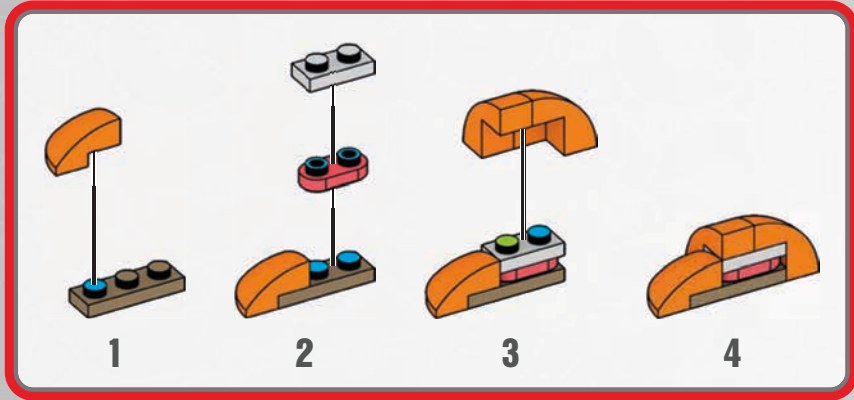
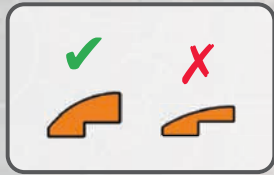
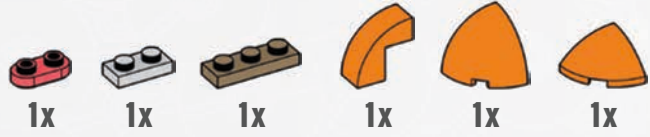

302

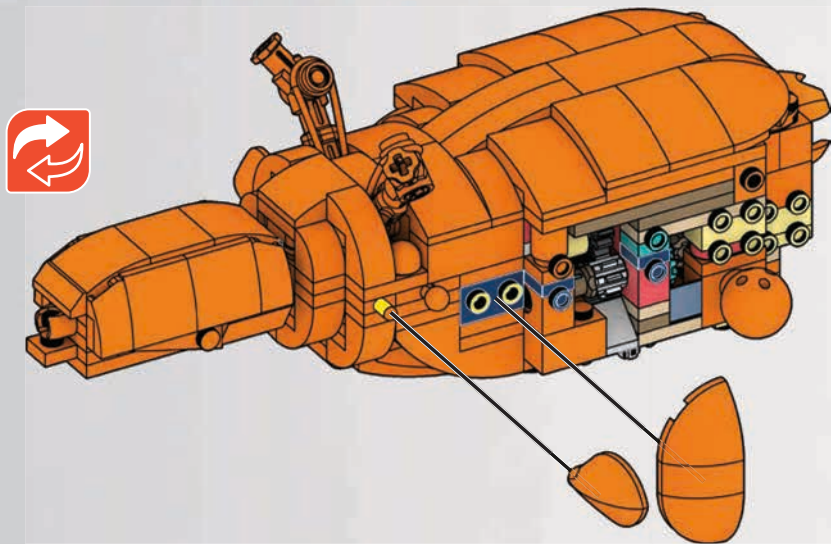
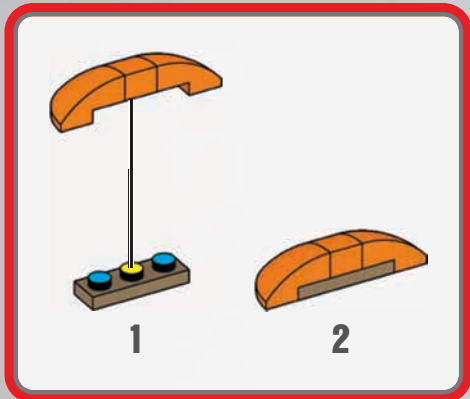
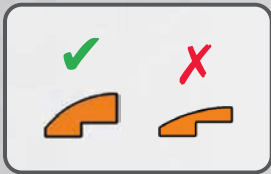

303

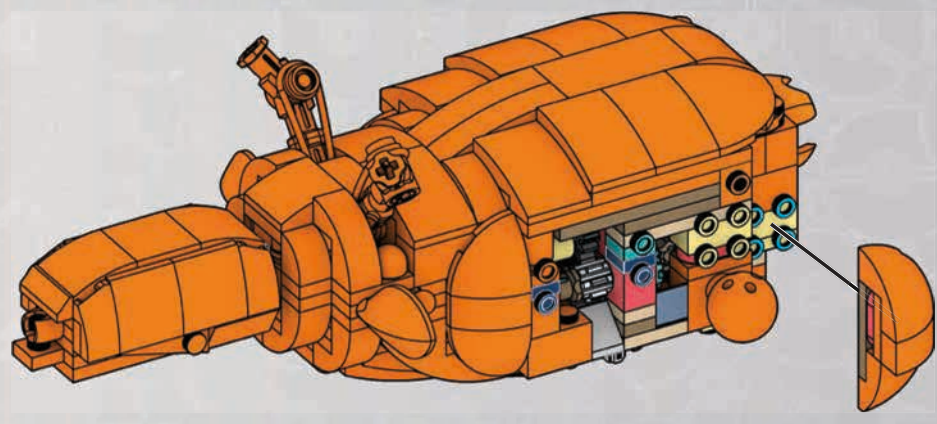
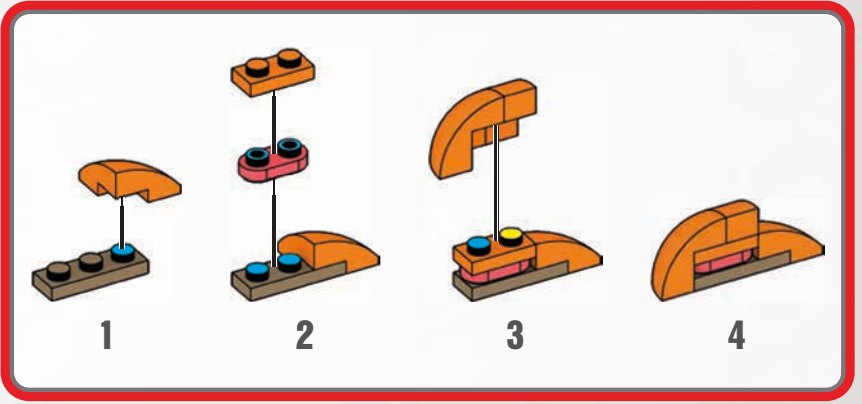
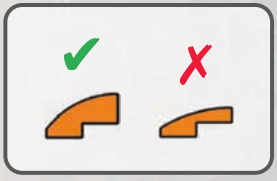

304

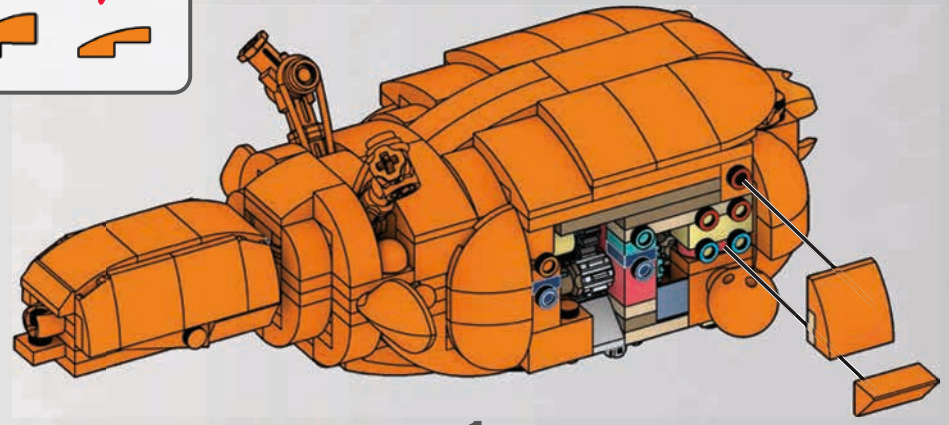
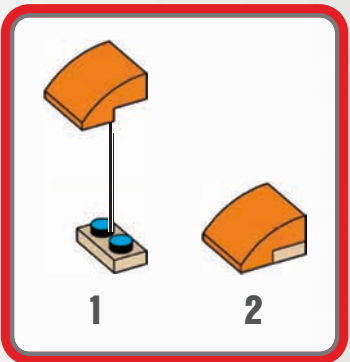
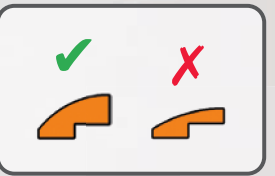

1

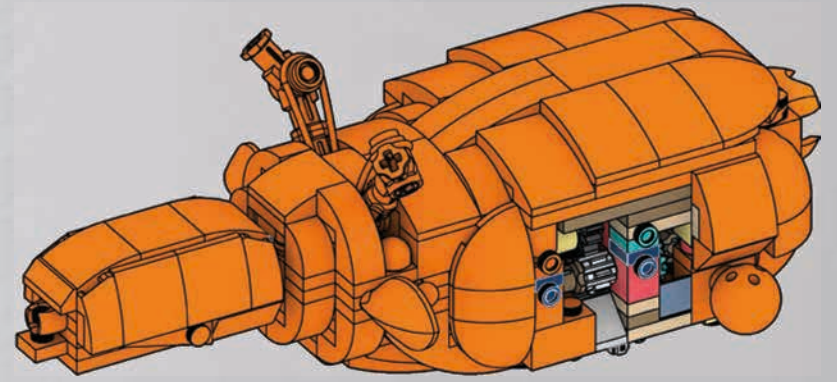

2

305



1x

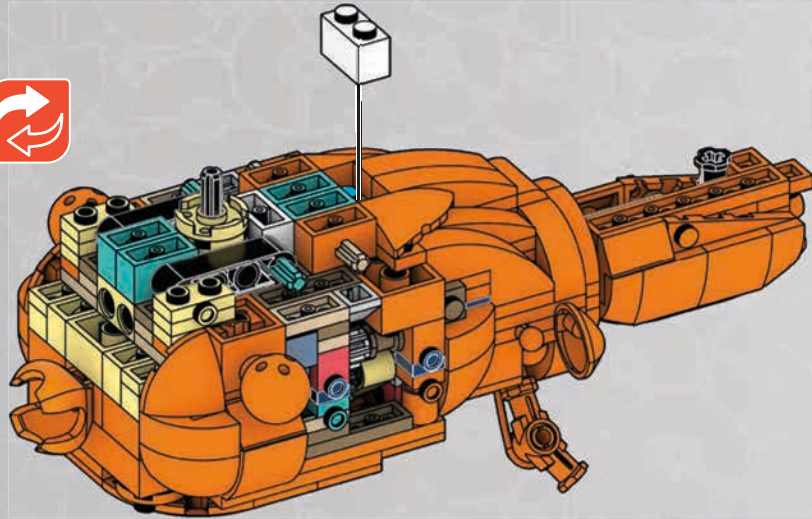

306



2x



1x



2x

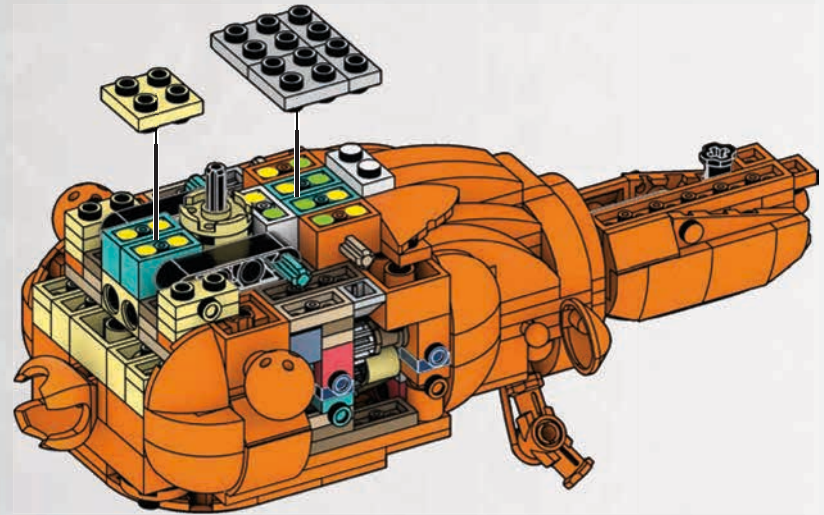

307



2x



2x



2x

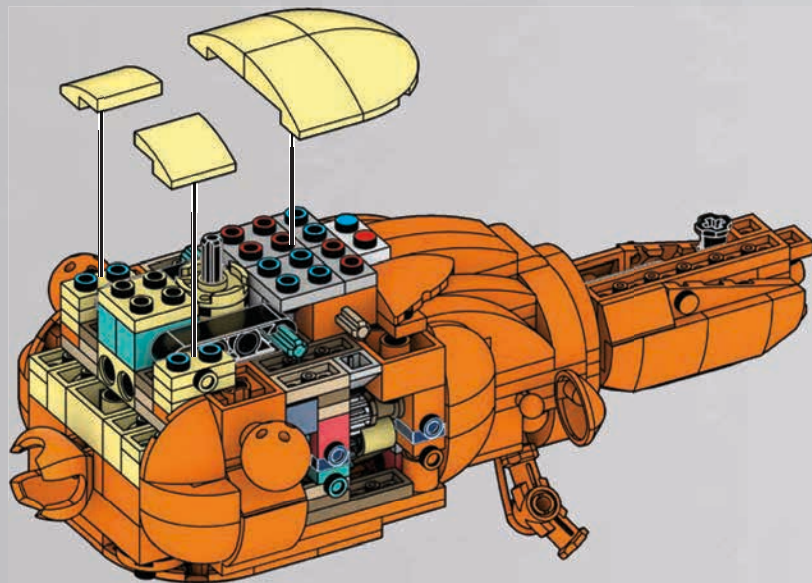

308



1x



2x

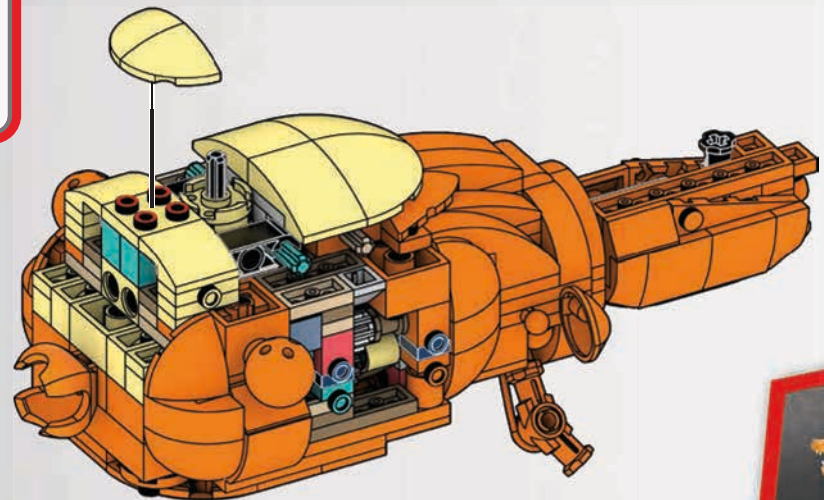
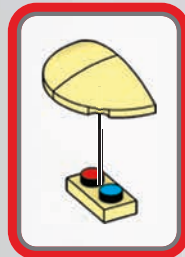

309

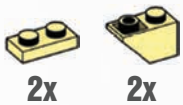

2x

2x

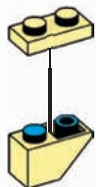

1



2

x2

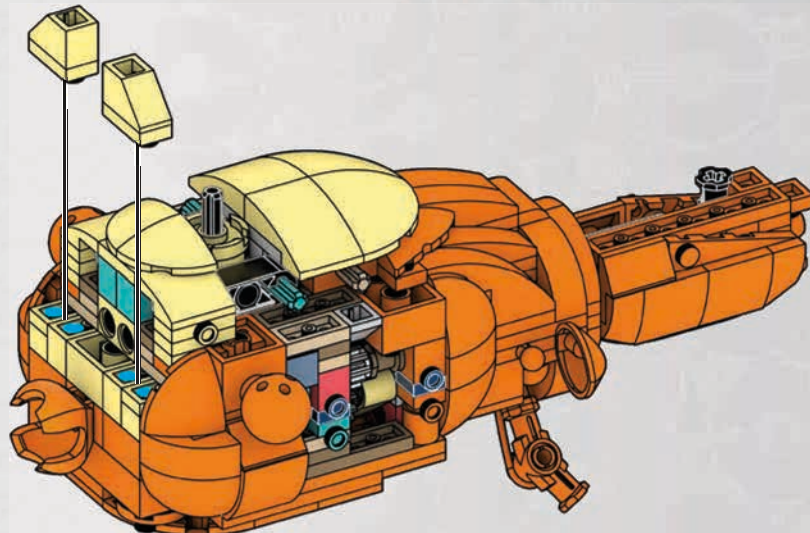

1

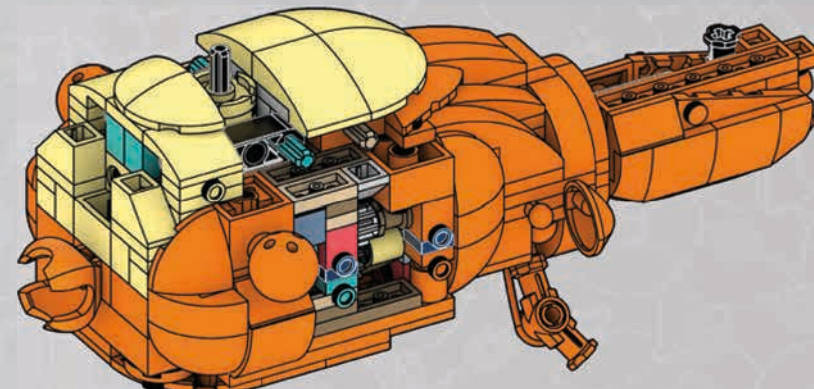

2

310

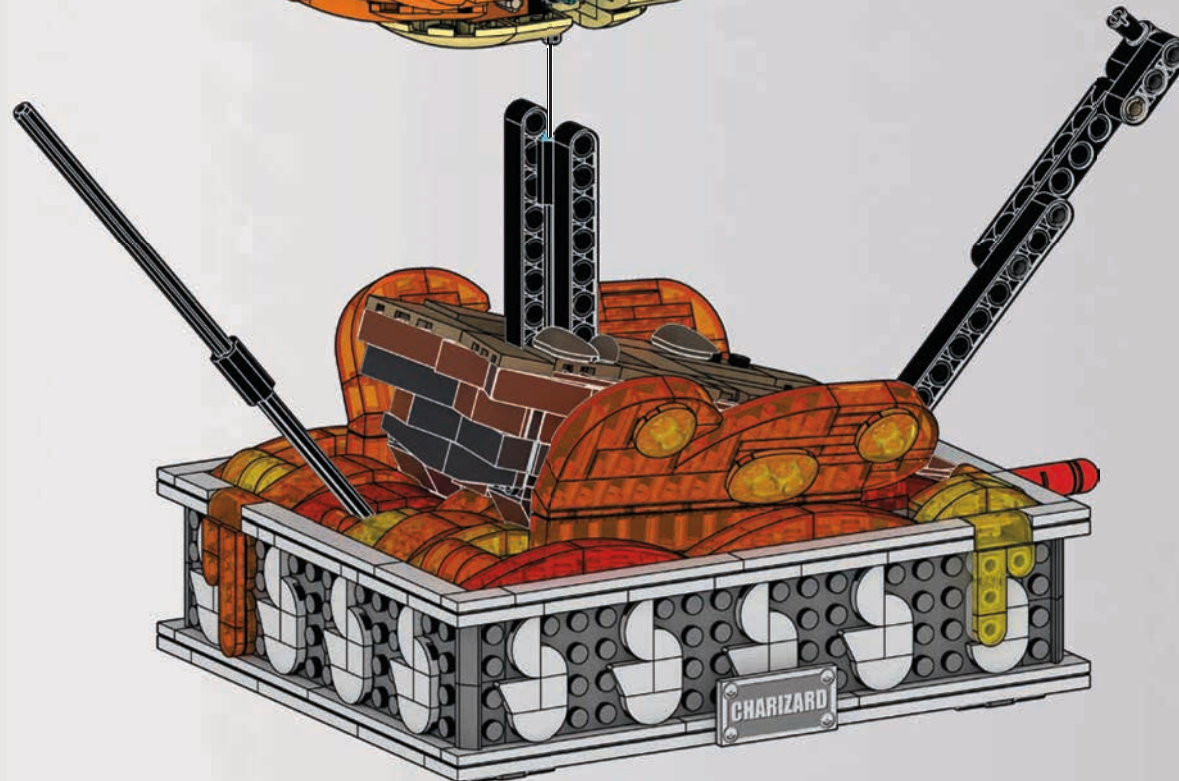
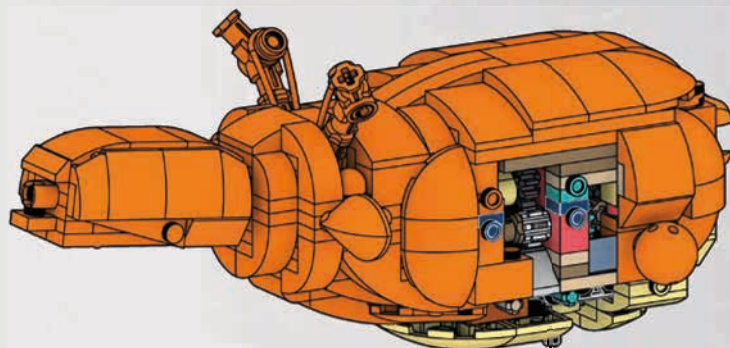



311

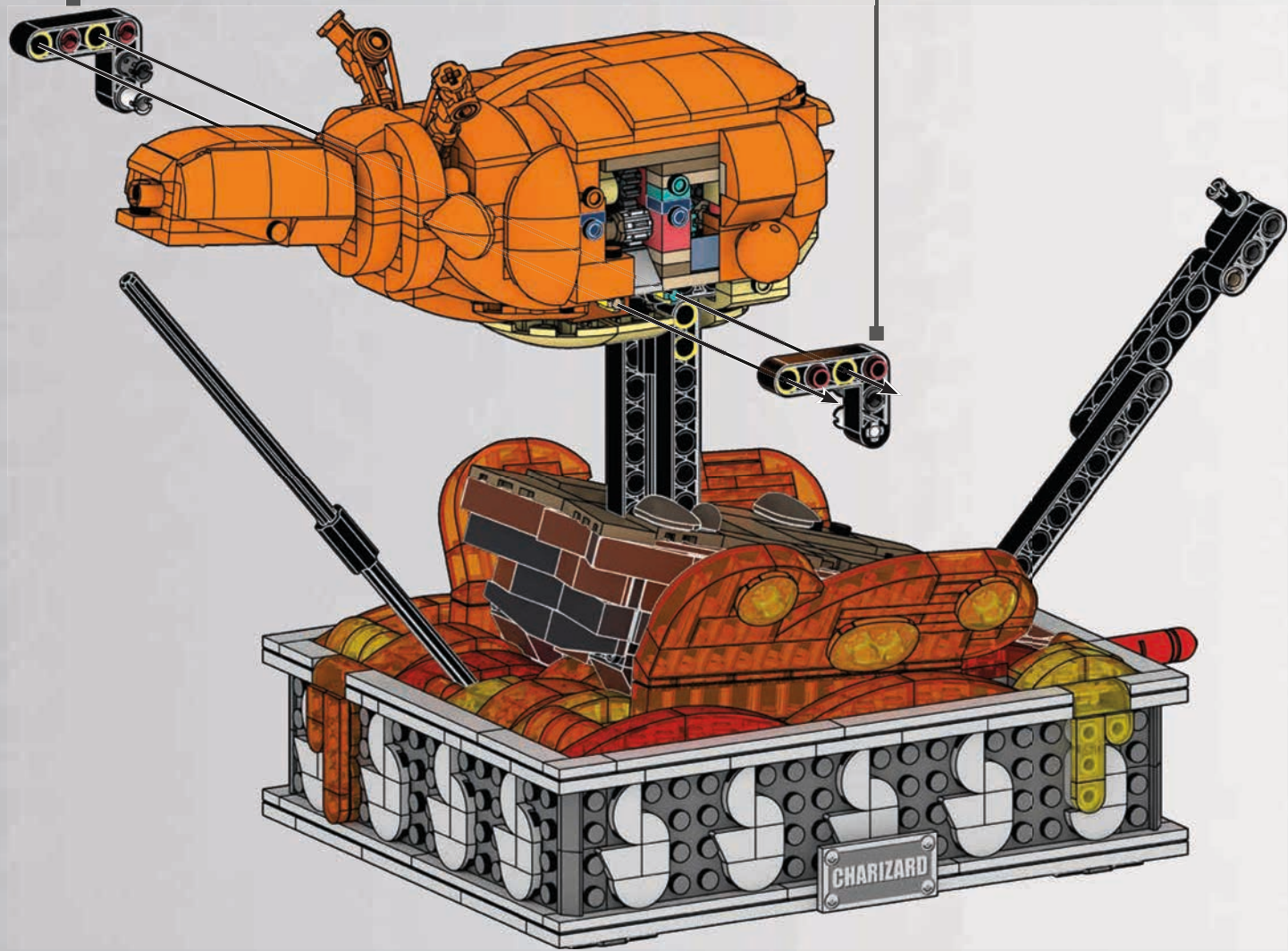
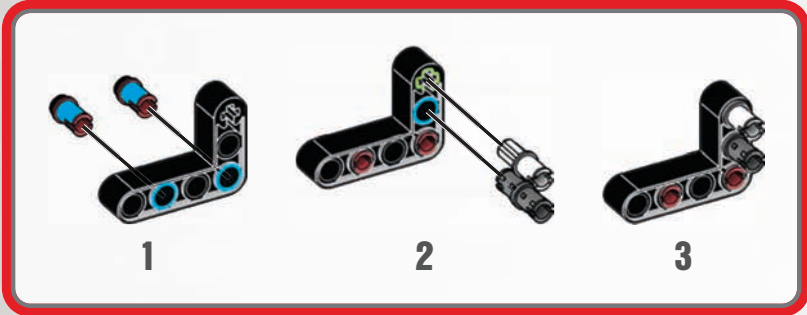
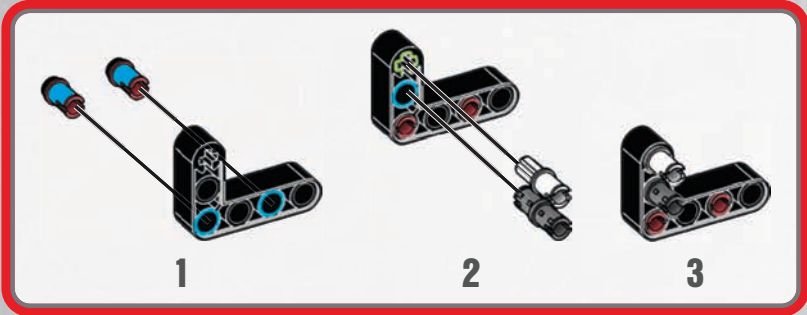

312

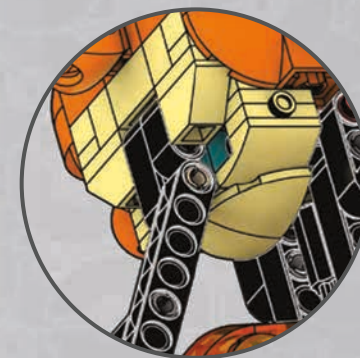
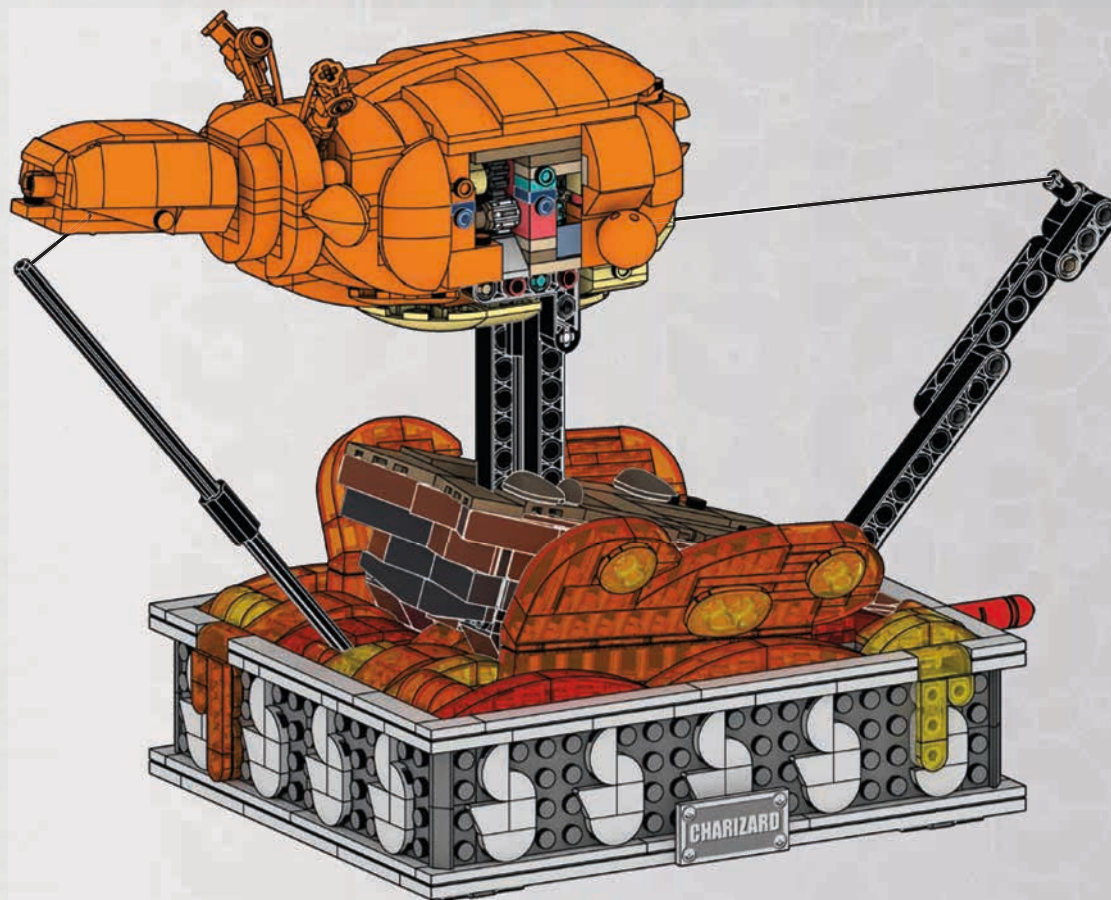
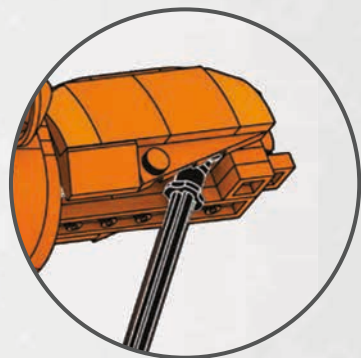

313

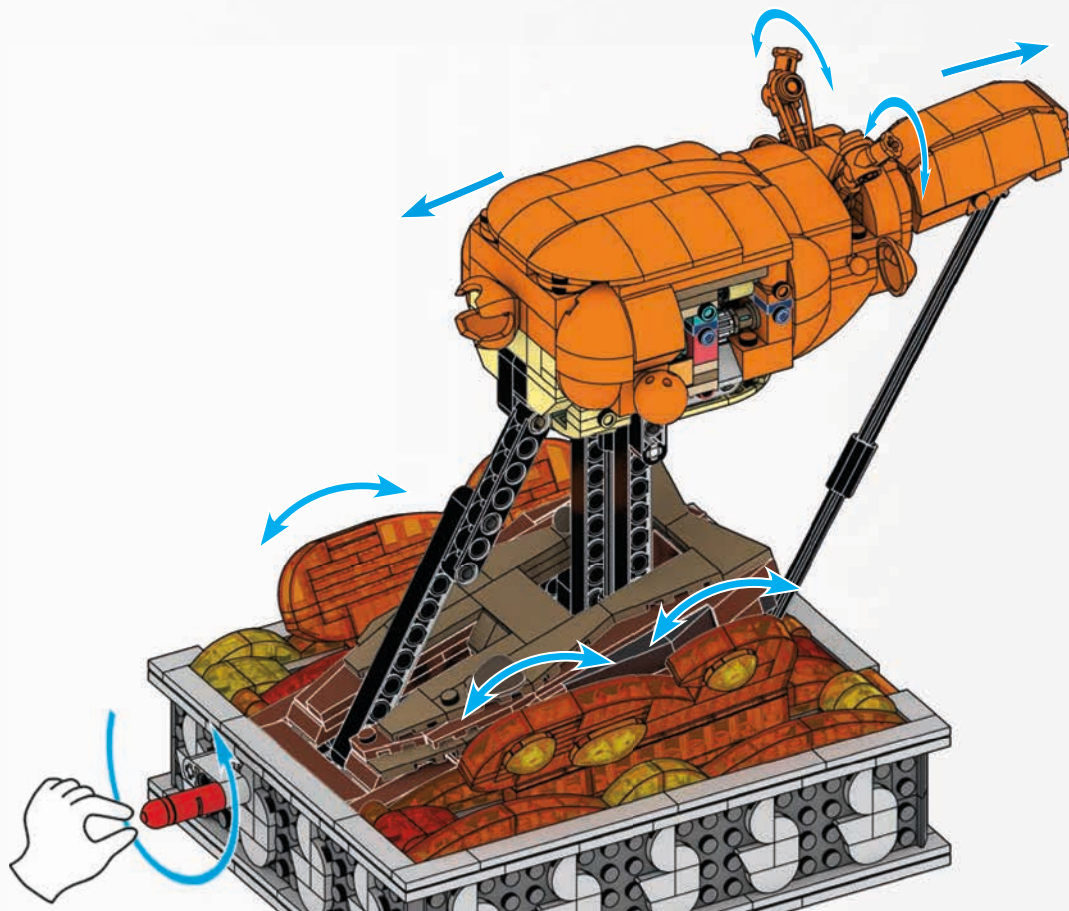

314

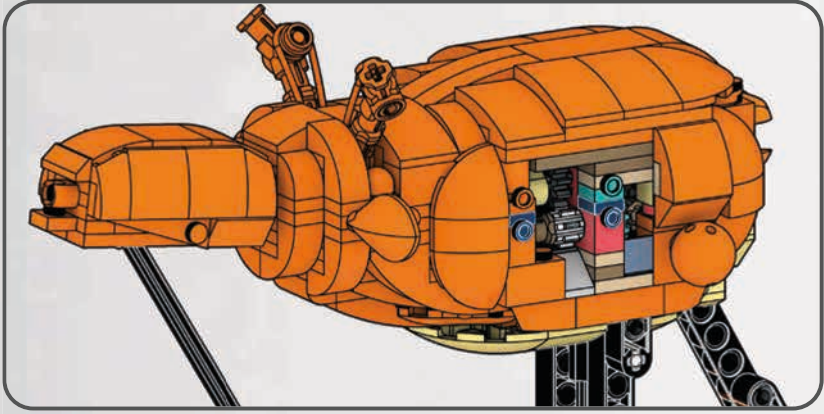
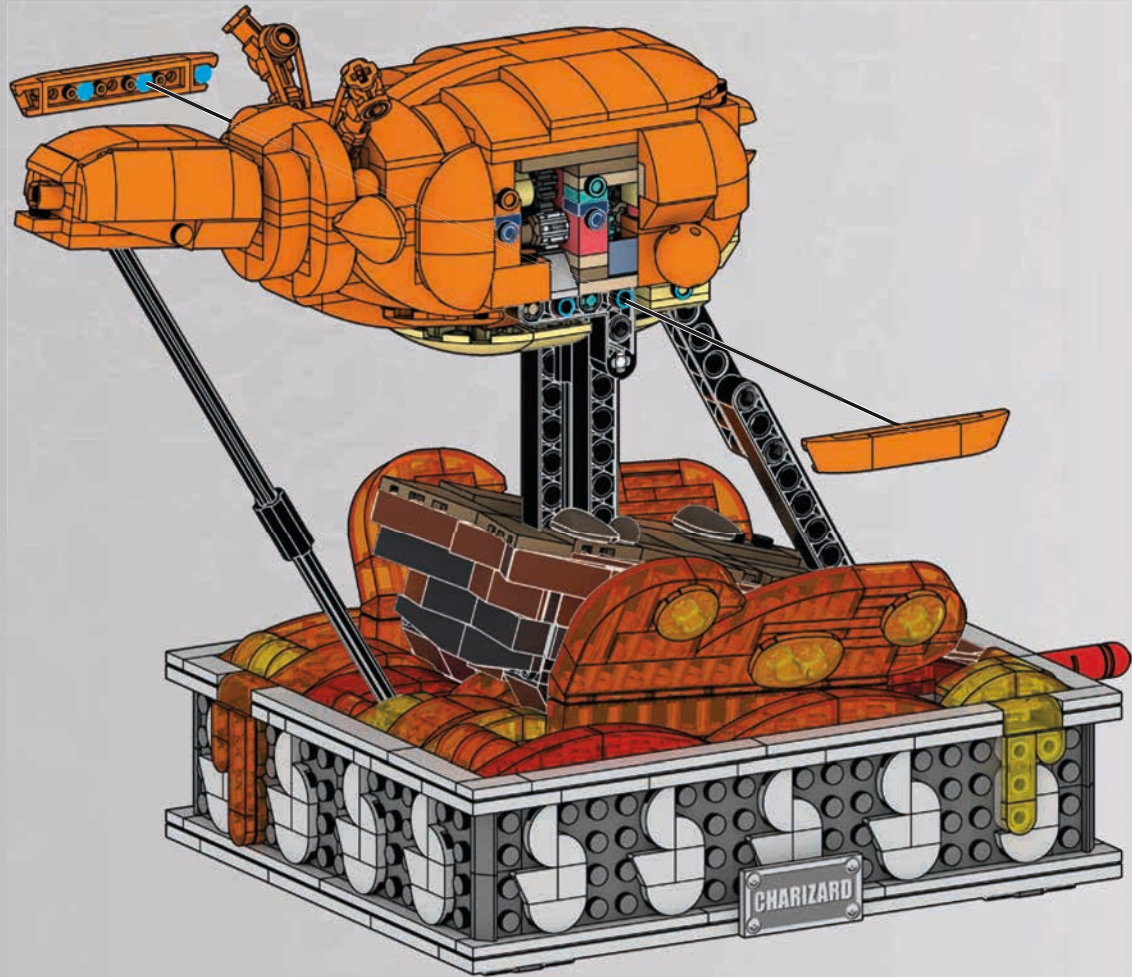
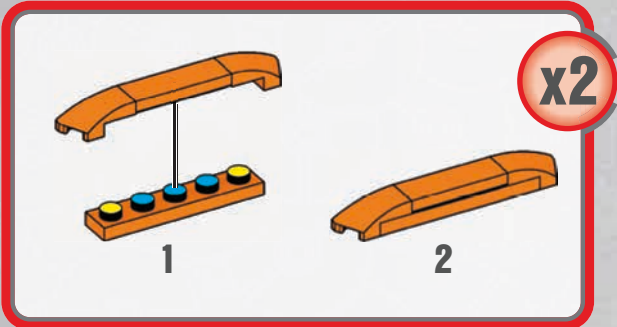

315

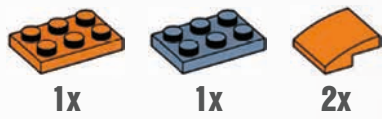

316

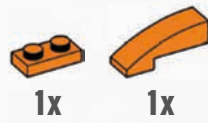

317



318

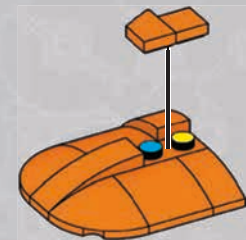
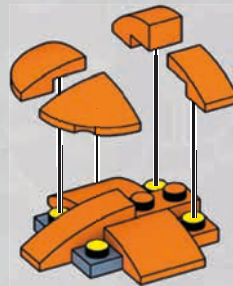
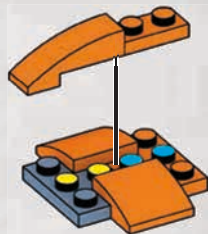
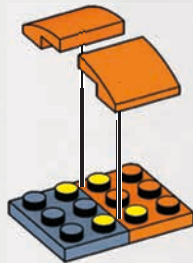
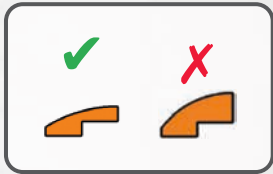

1



2

319

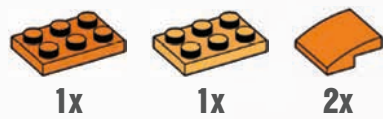

320



321



322

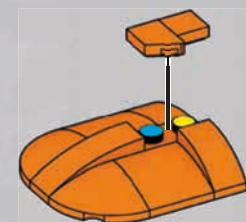
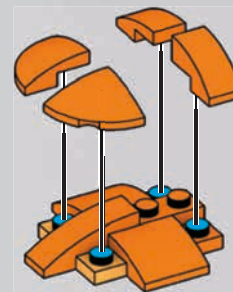
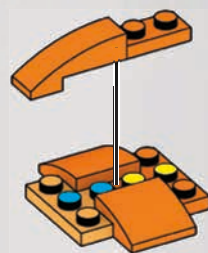
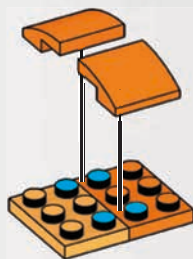
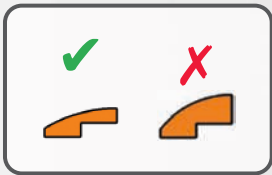

1



2

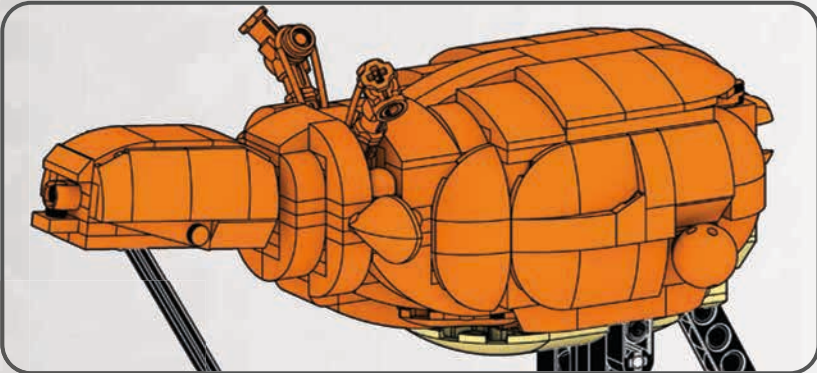
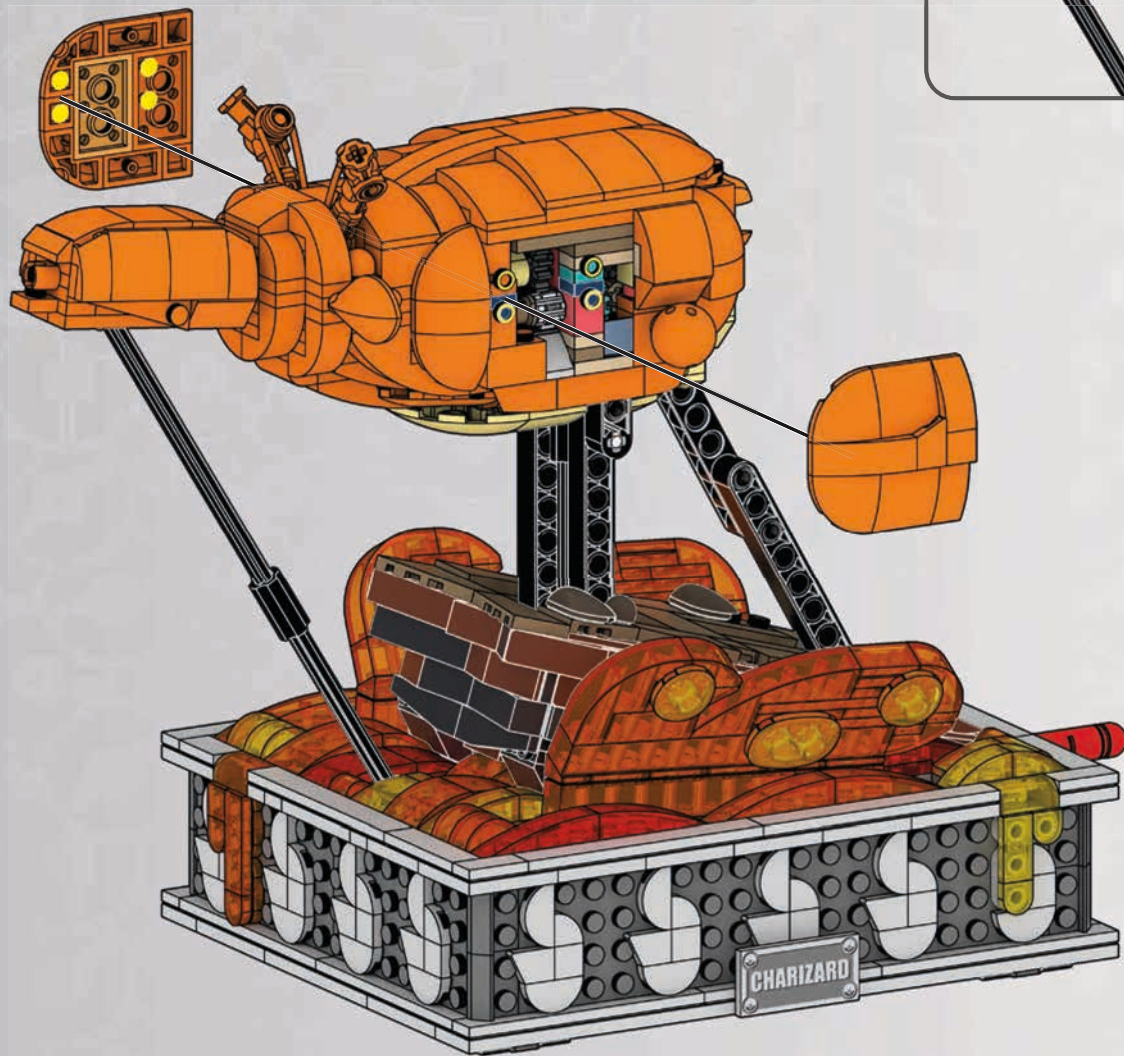

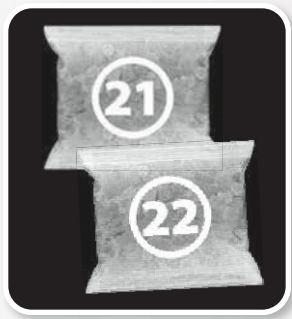

324

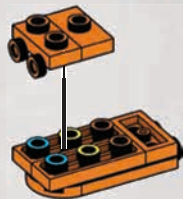

325

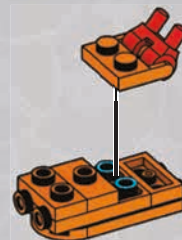
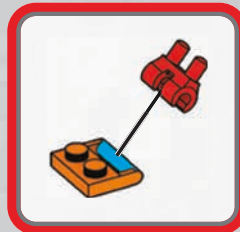

326

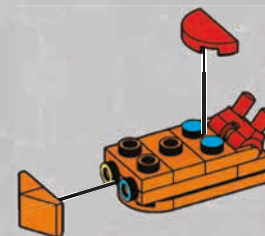

327

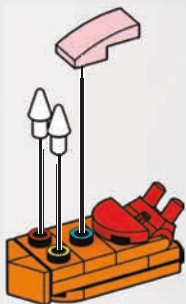

1



2

328

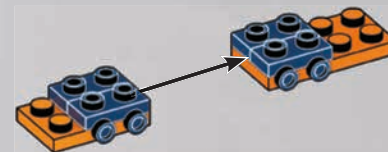
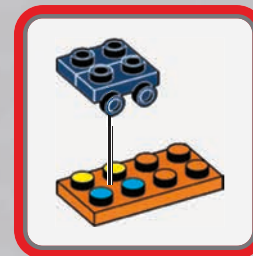
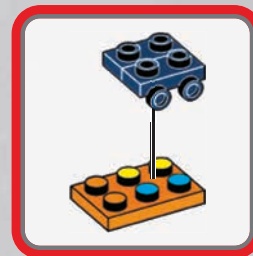

329



1x

1x

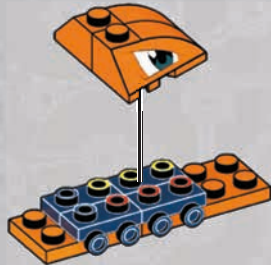

330



2x

1x

1x

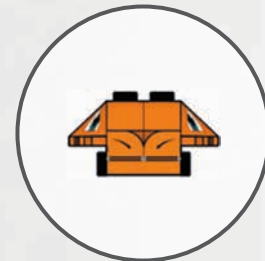
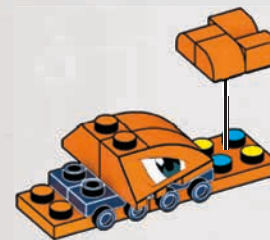

331



1x

1x

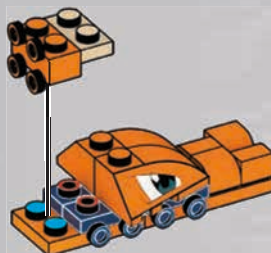

332

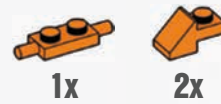

1x

2x

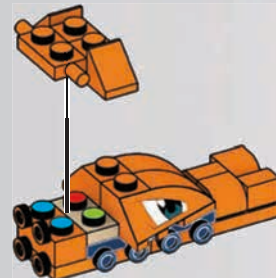

333



1x

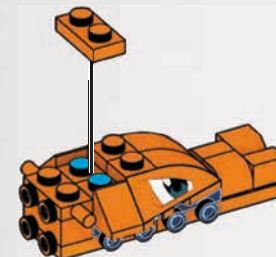

334



1x

1x

1x

335



1x

336



2x

2x

2x

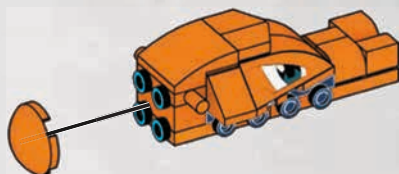
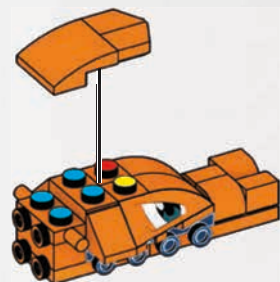

1

2

x2

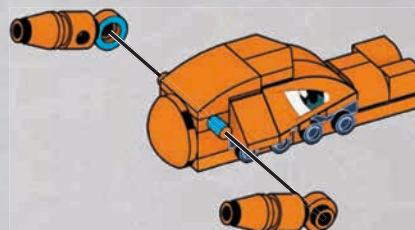

1

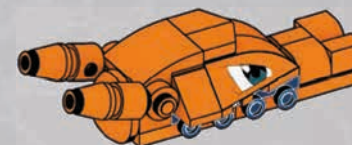

2

337



2x

1x

1x

338



2x

1x

339



1x

1x

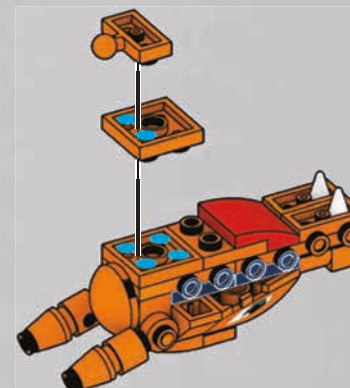
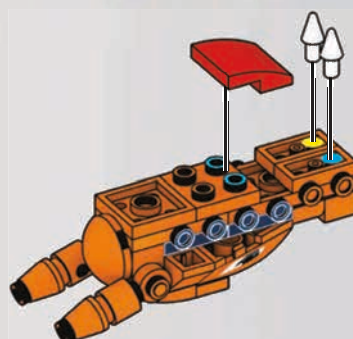
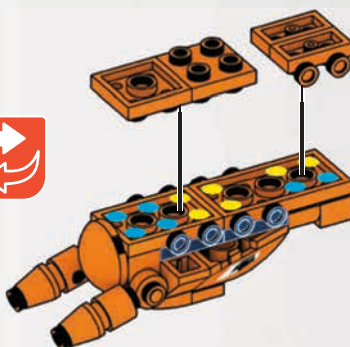



340



1x

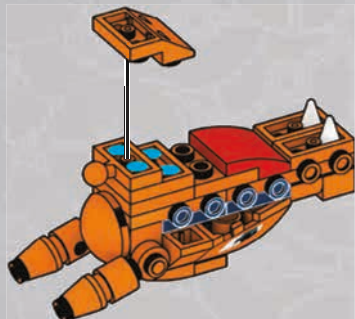

341



2x



1x



1x

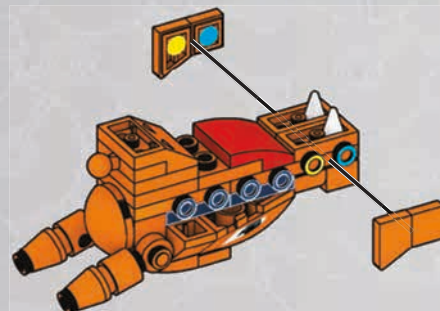

342



1x



1x



2x



1x



1x



1x

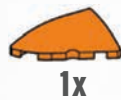

1x

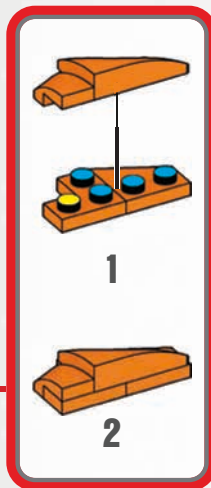
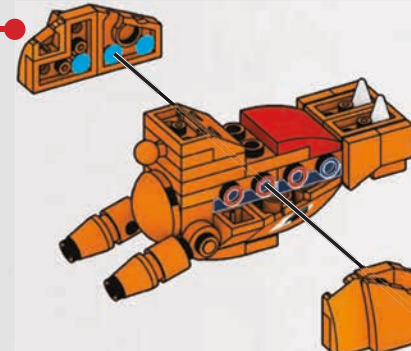
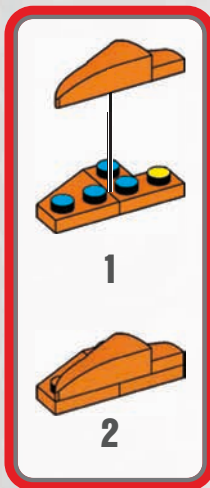

343



1x



1x

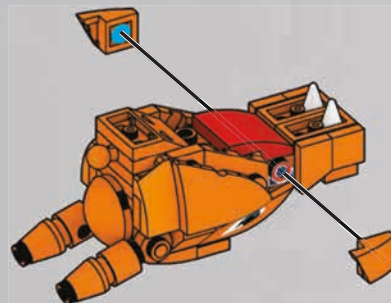

344

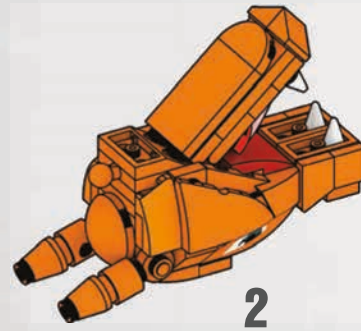
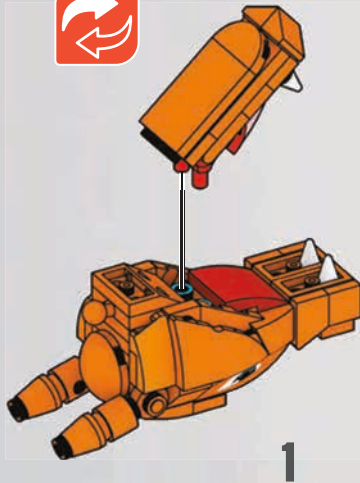

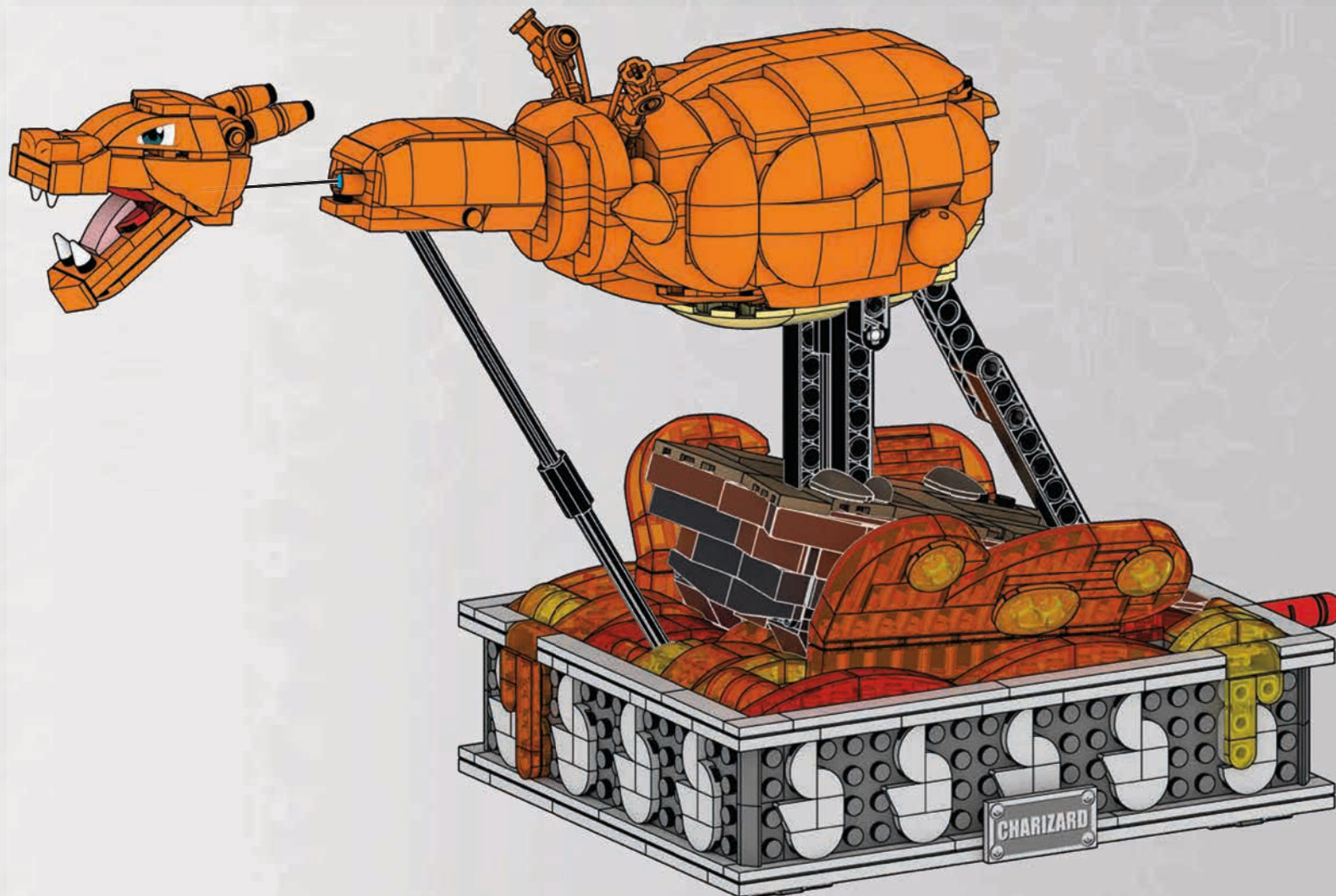

1

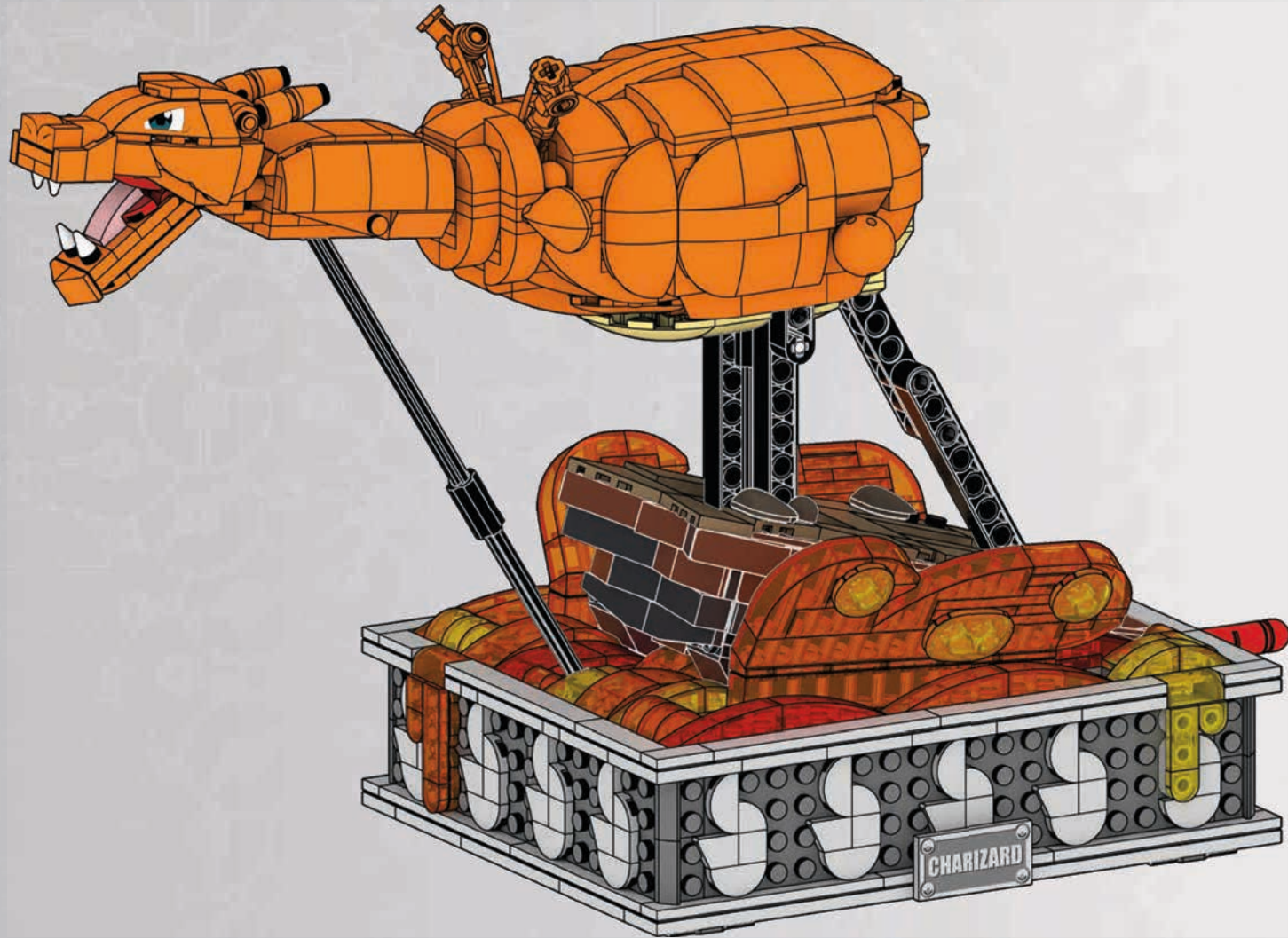

2





346

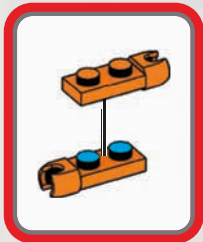

1



2

347

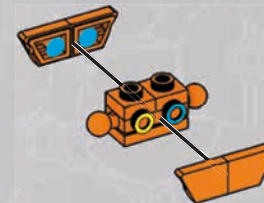
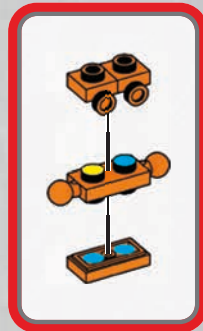

345

351

x2

348

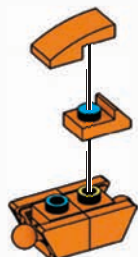

1



2

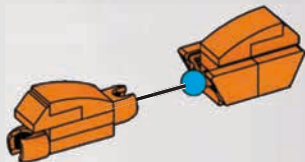

1

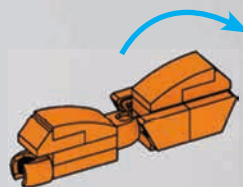

2

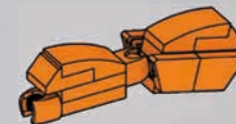

3

349



350



351

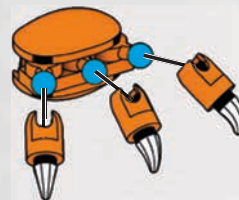
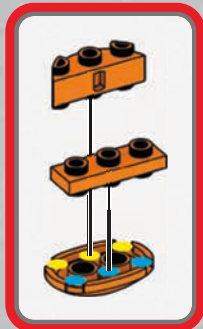
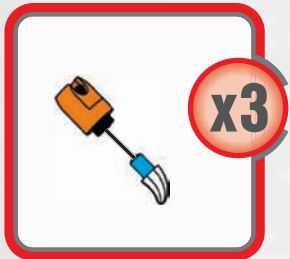
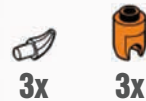

1

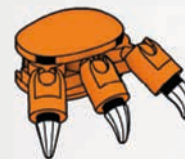

2

352

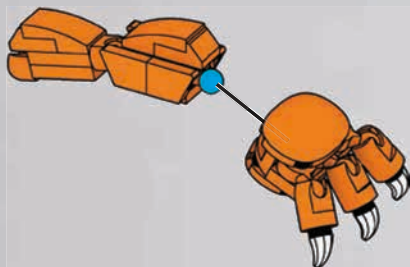

1

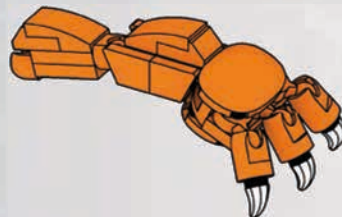

2



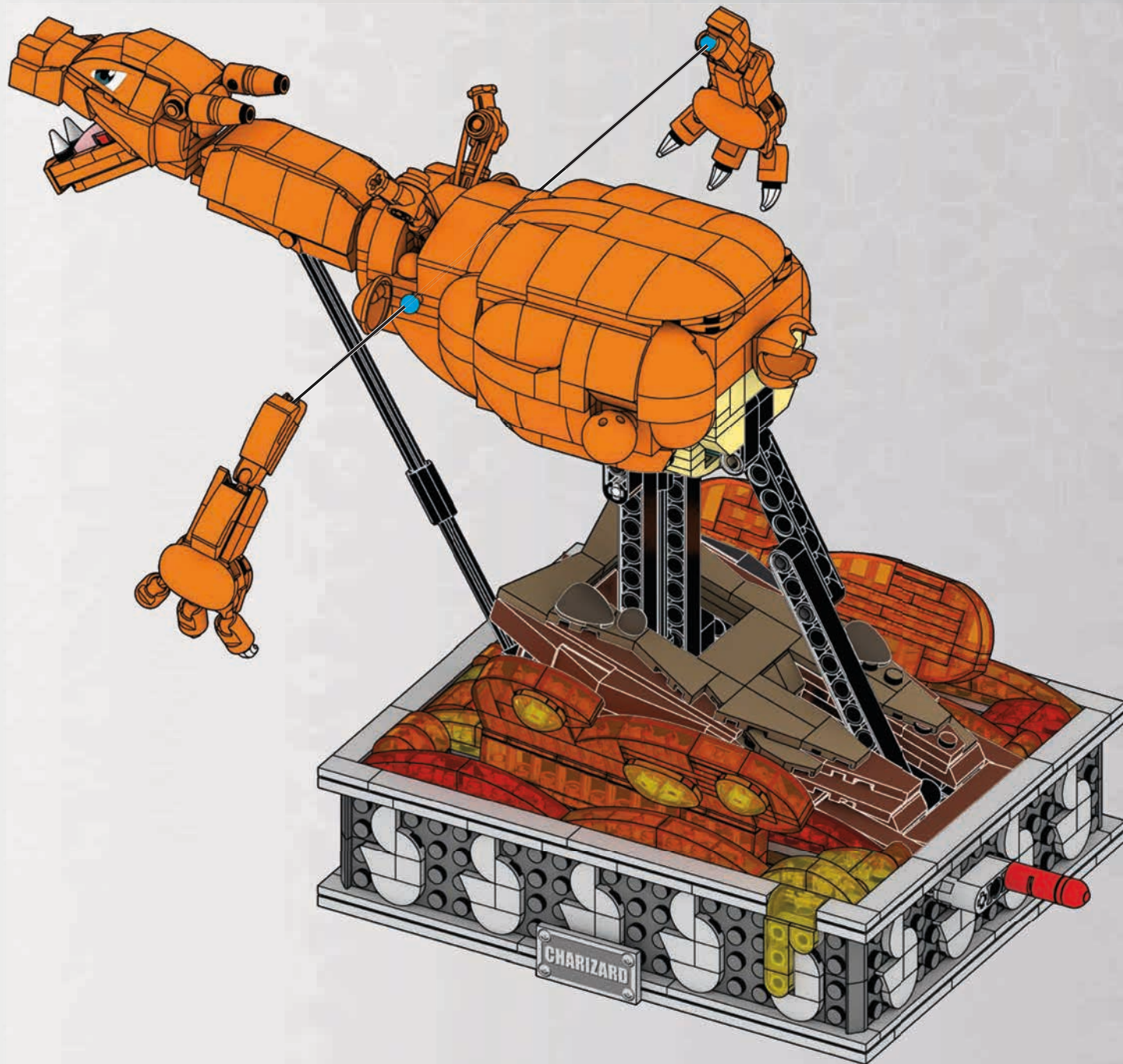

1

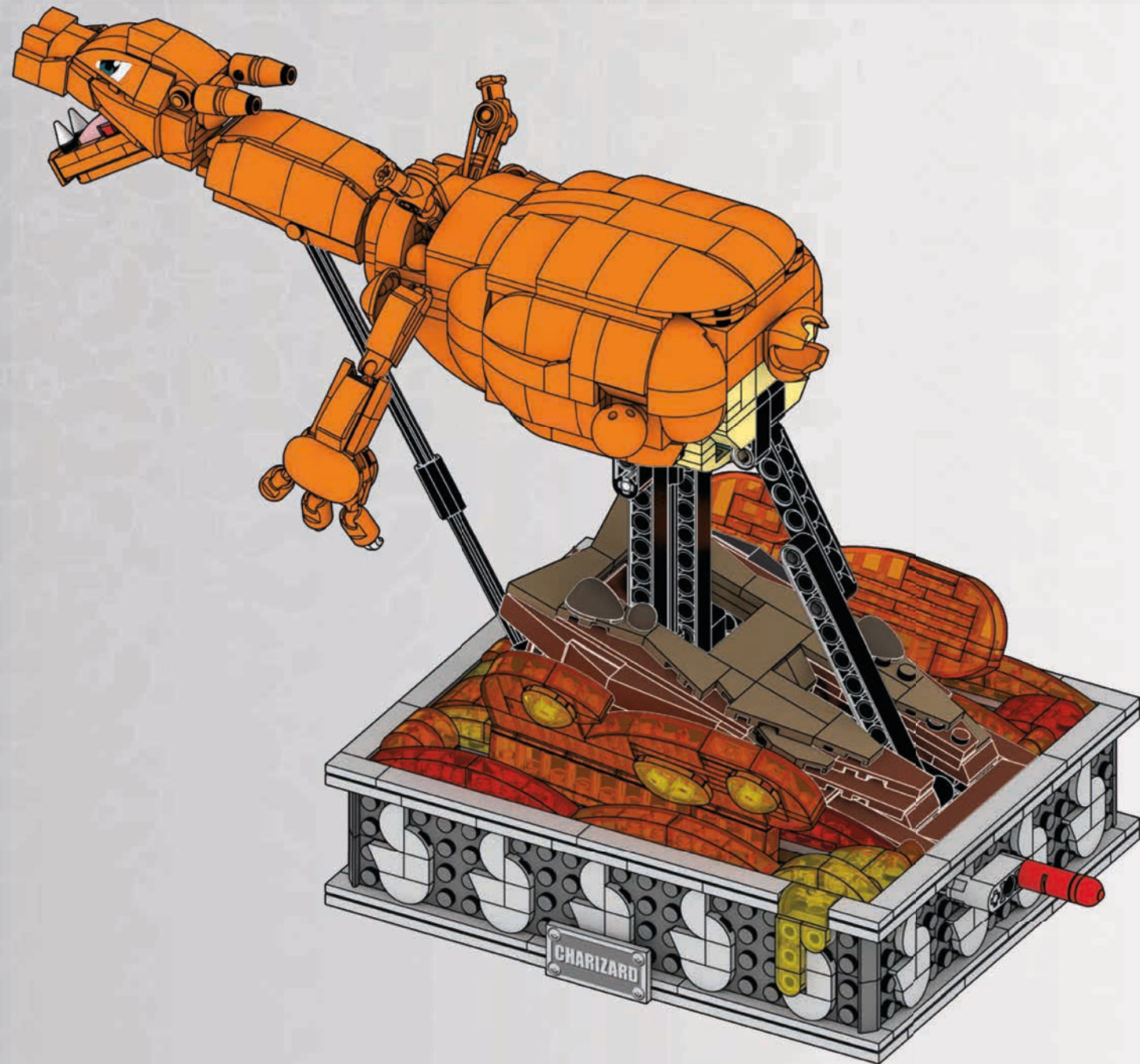

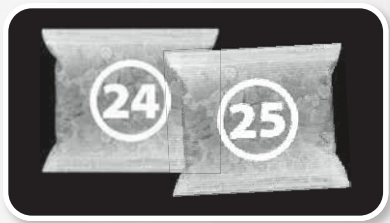

**354** 1x 2x 1x

**355** 1x

**356** 2x

**357** 1x 1x

353 → 360  
**x2**

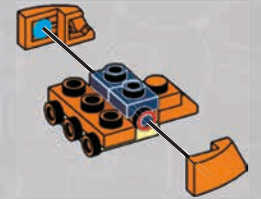
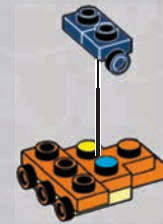
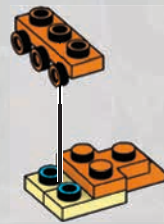

**358** 1x 1x

**359** 2x 2x 1x

**360** 3x

**361** 1x

1 2 **x2**

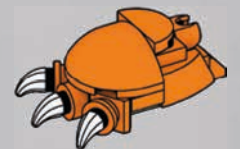
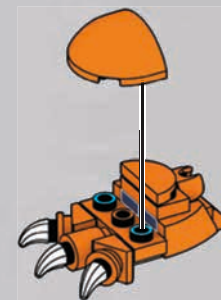
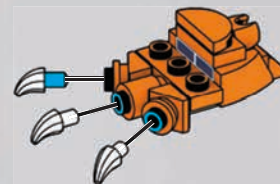
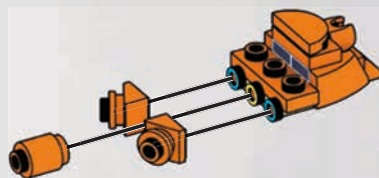
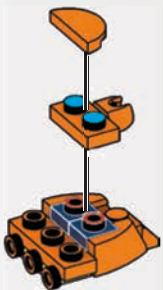

1

2



362

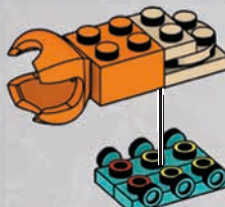
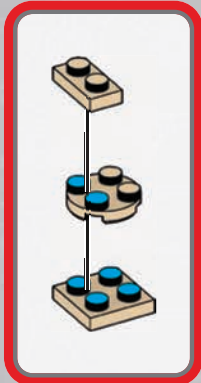

363



364

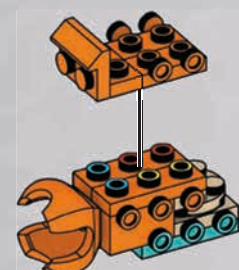
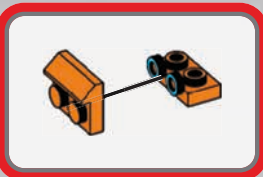
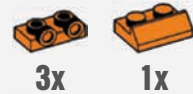

365

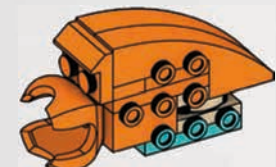
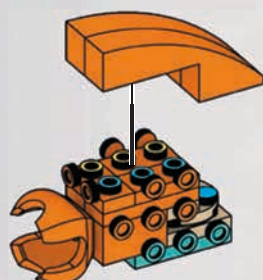
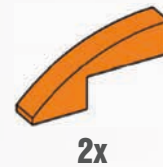

1

2



366



1x

1x

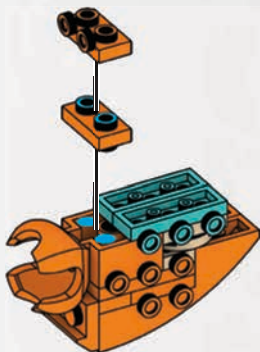

367



1x

1x

1x

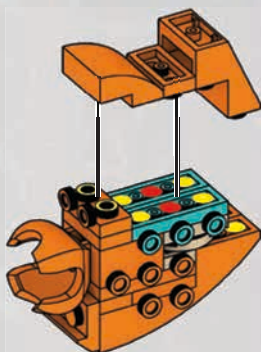

368



1x

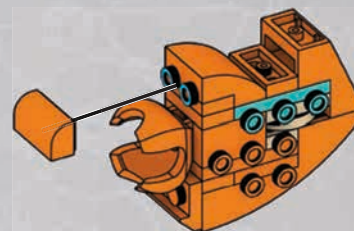

369

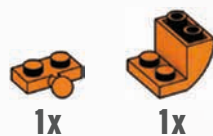

1x

1x

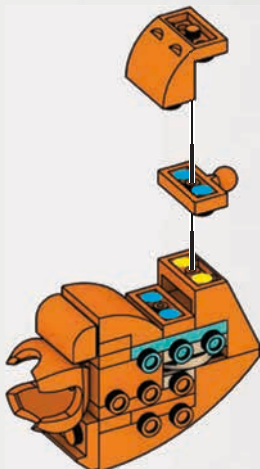

1

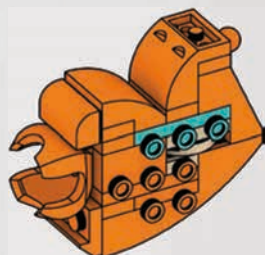

2

370



1x

1x

1x

1x

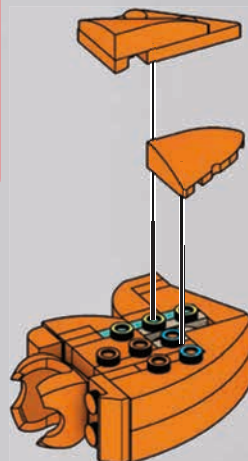
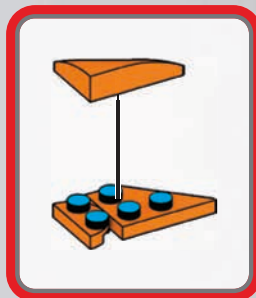

1

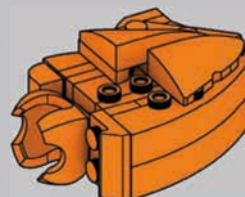

2

371

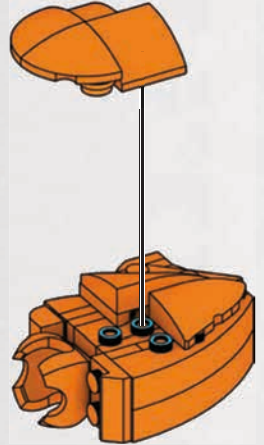
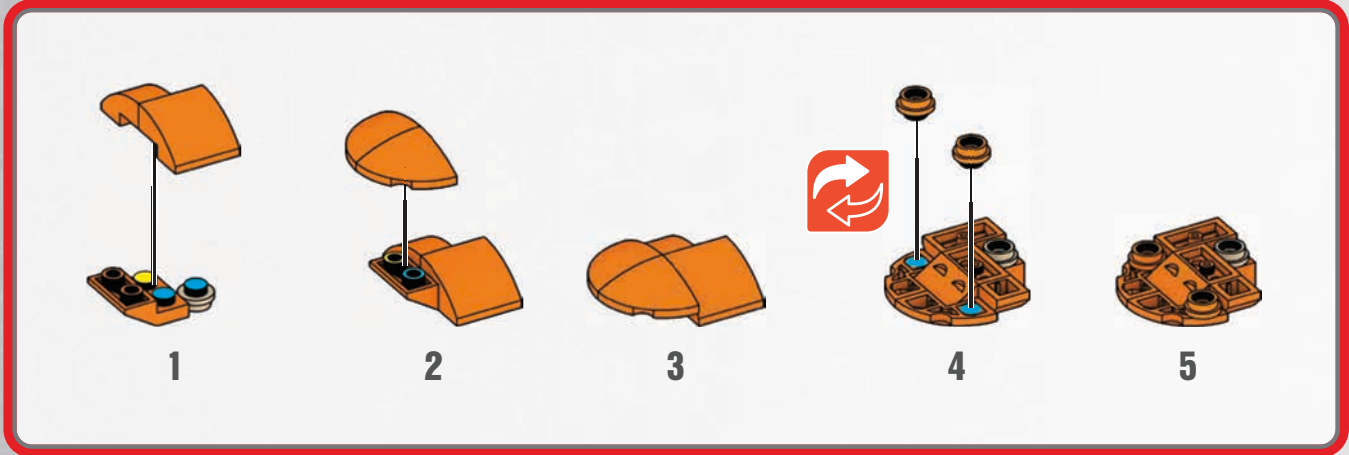
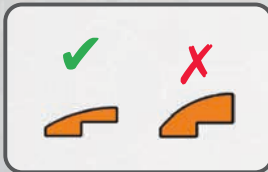
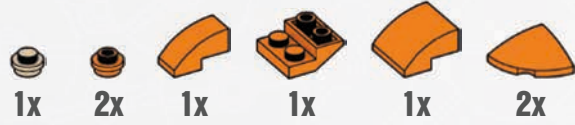

1

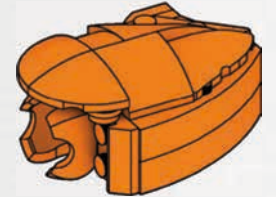

2

372

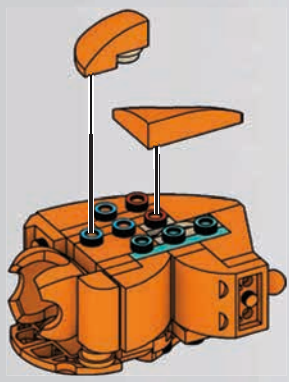
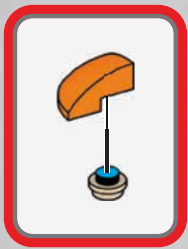
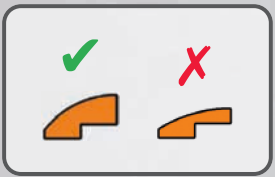

373

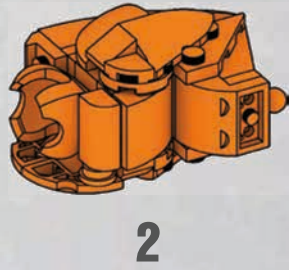
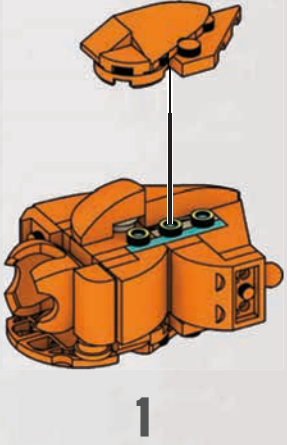
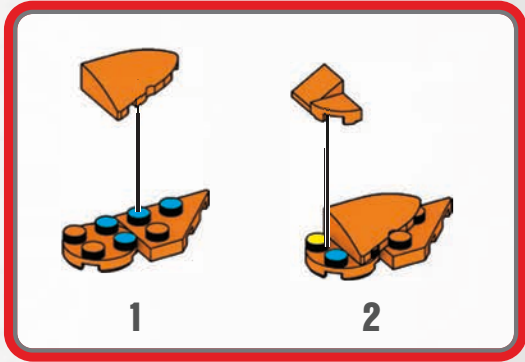

374

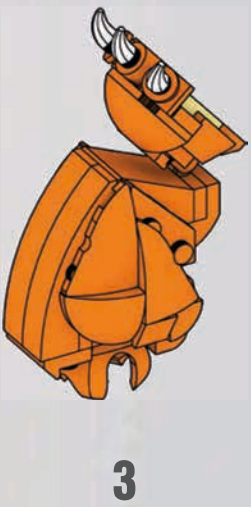
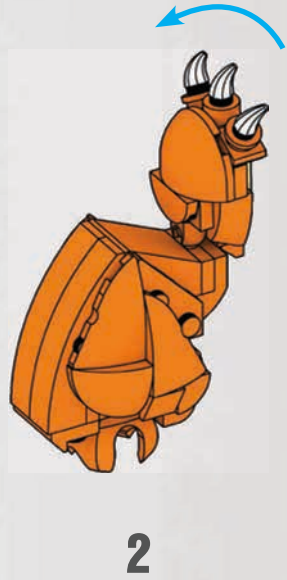
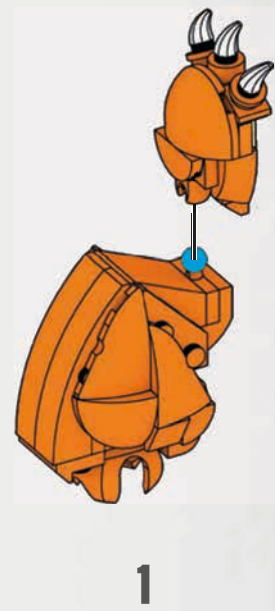

375



1x

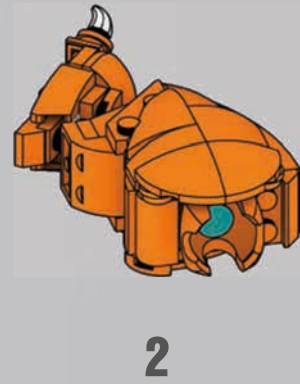
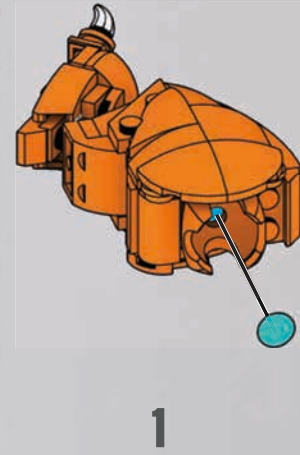

376

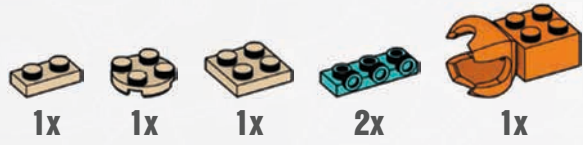

377

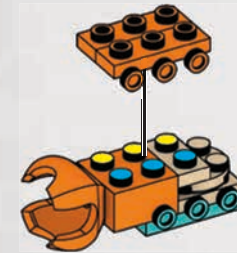
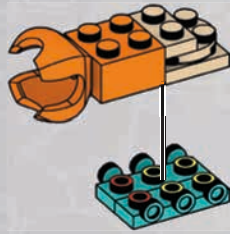
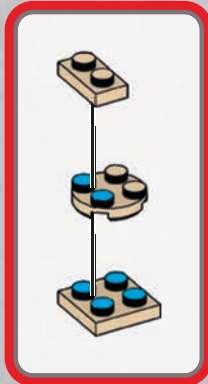

378



379

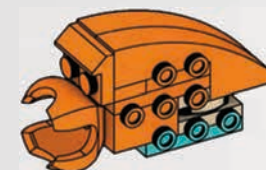
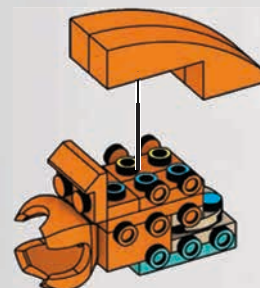
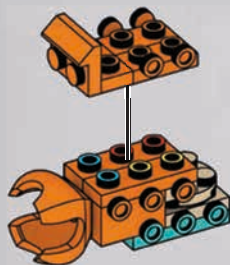
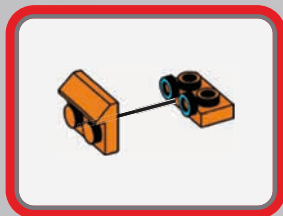
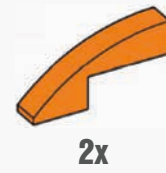

1

2



380



1x

1x

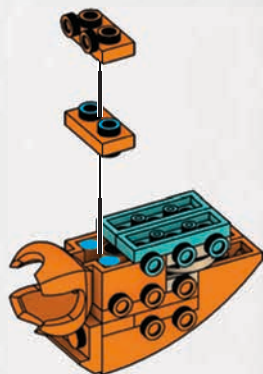

381

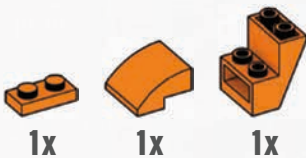

1x

1x

1x

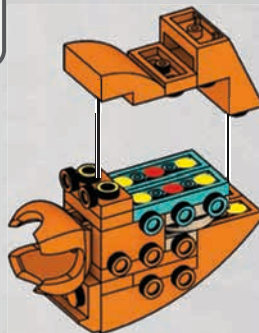
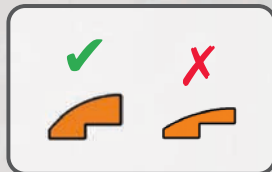

382



1x

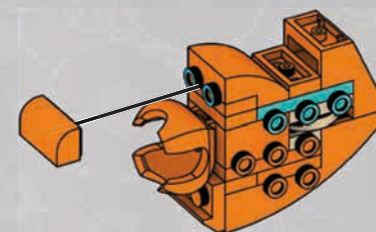

383

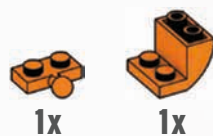

1x

1x

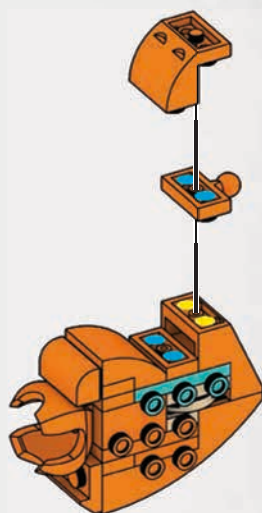

1

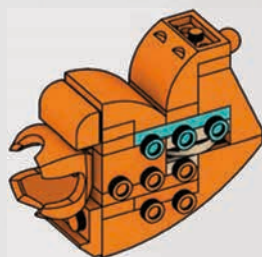

2

384



1x

1x

1x

1x

1x

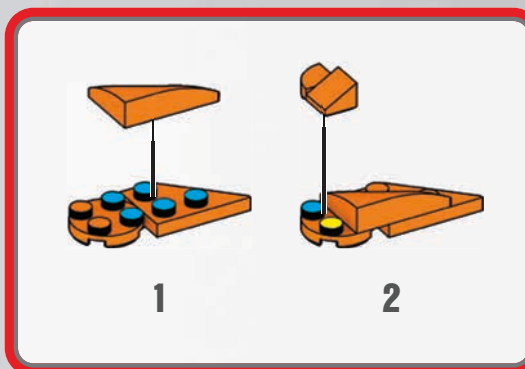

1

2

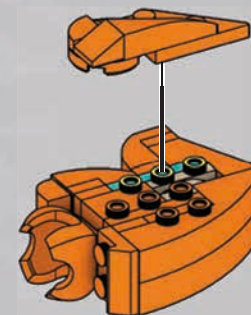

385

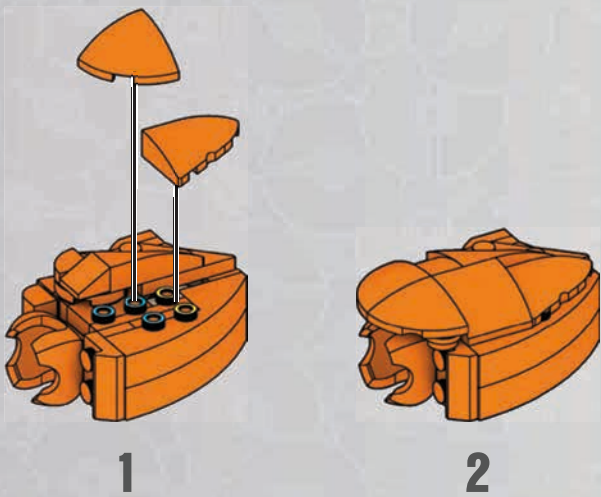
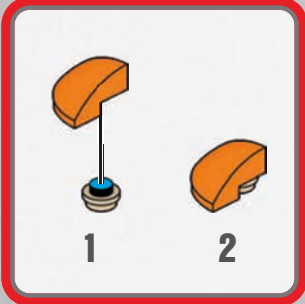
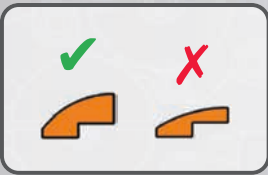

386

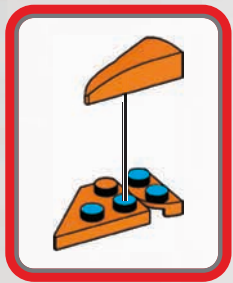

387

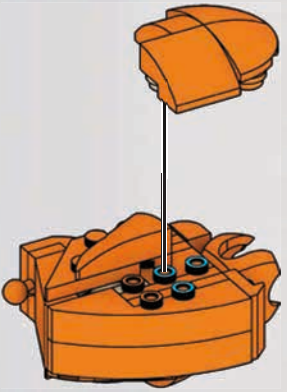
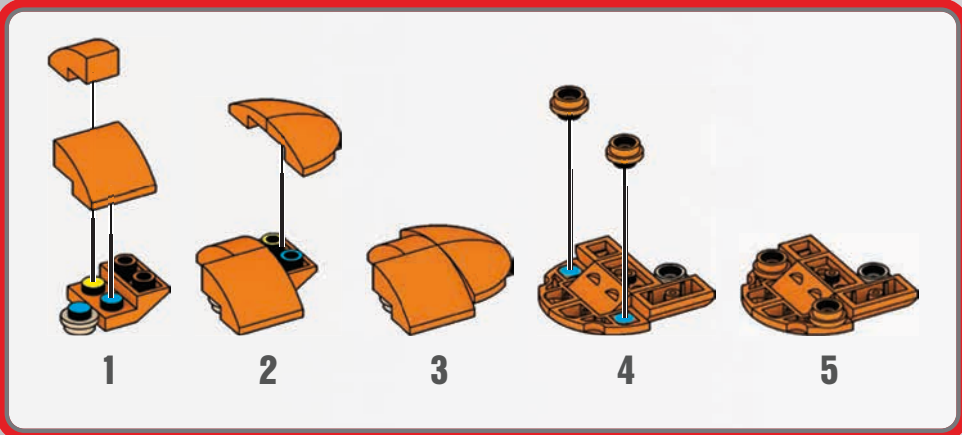
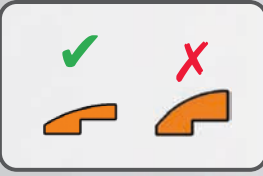
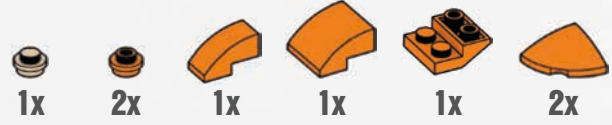

388



1x



1



2

389

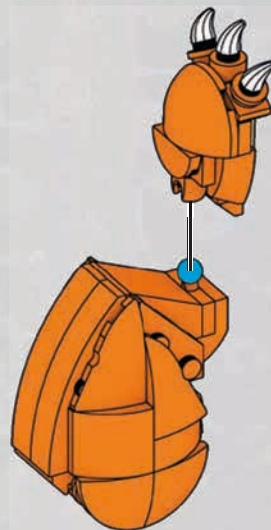

1

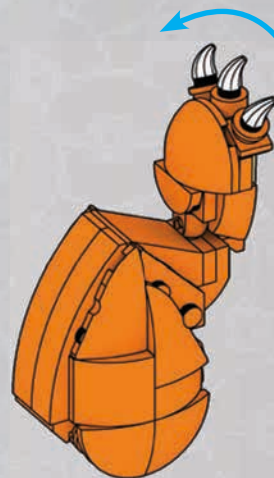

2



3

390



1x



1



2



391

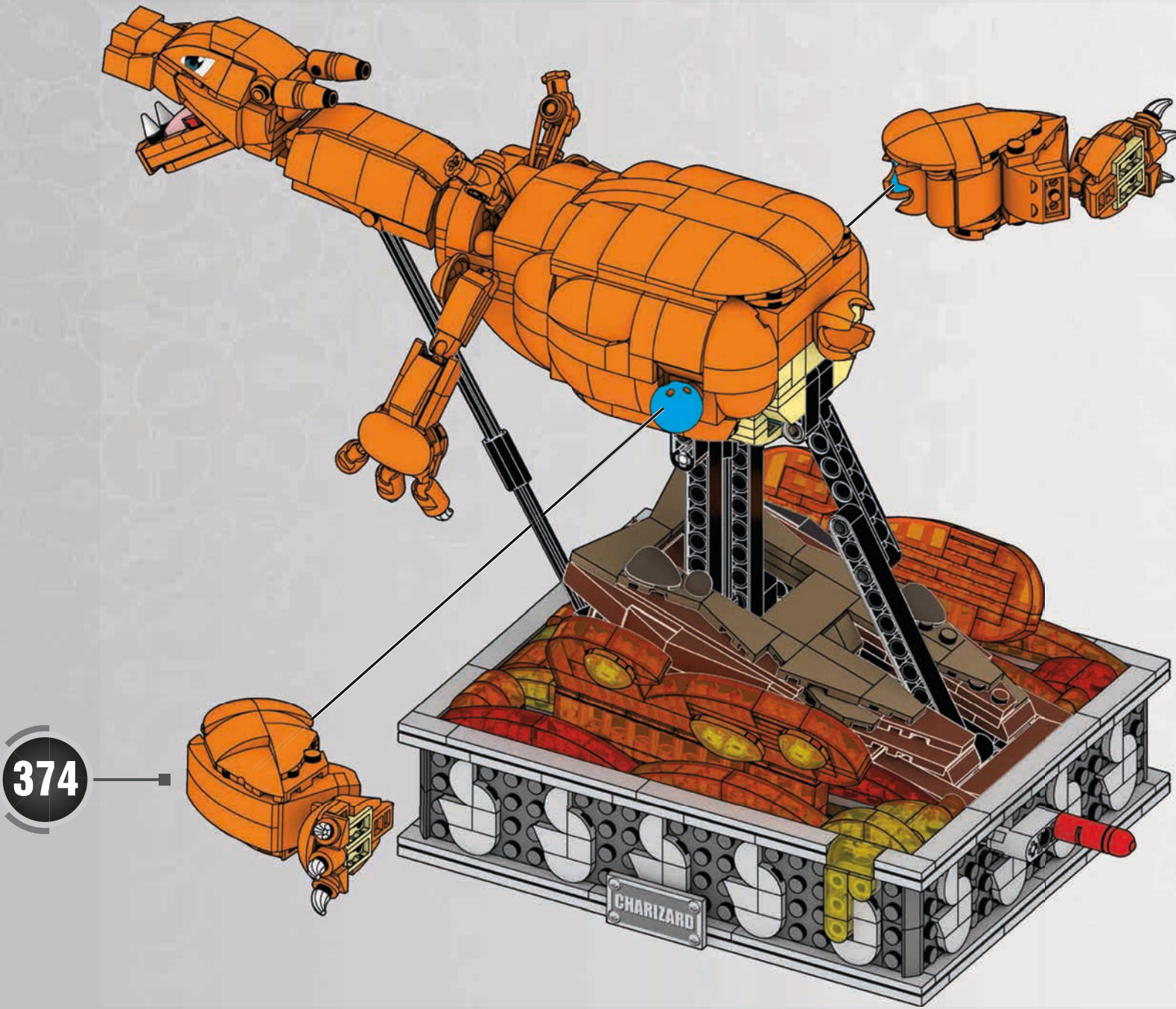

374

389



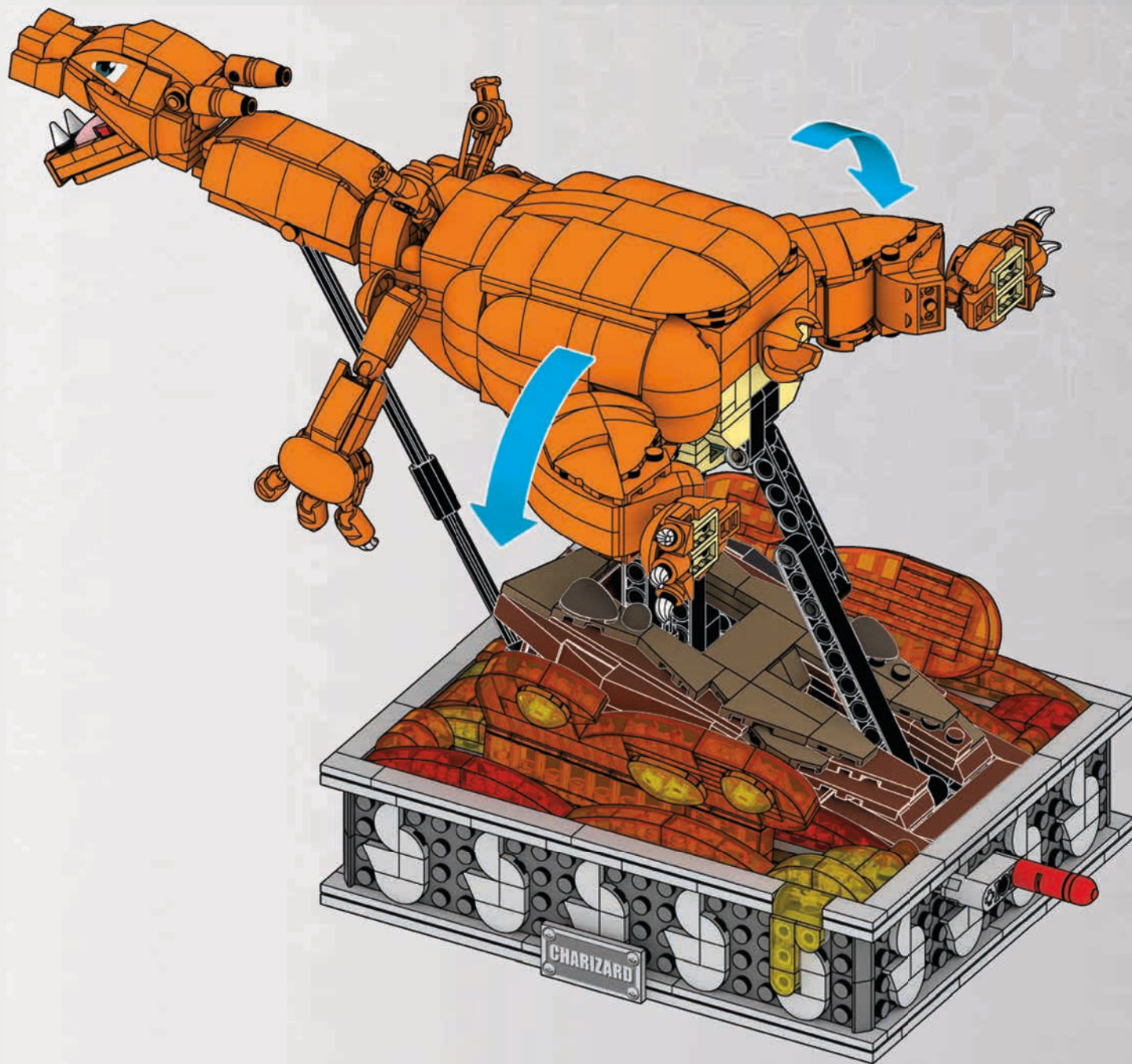

1

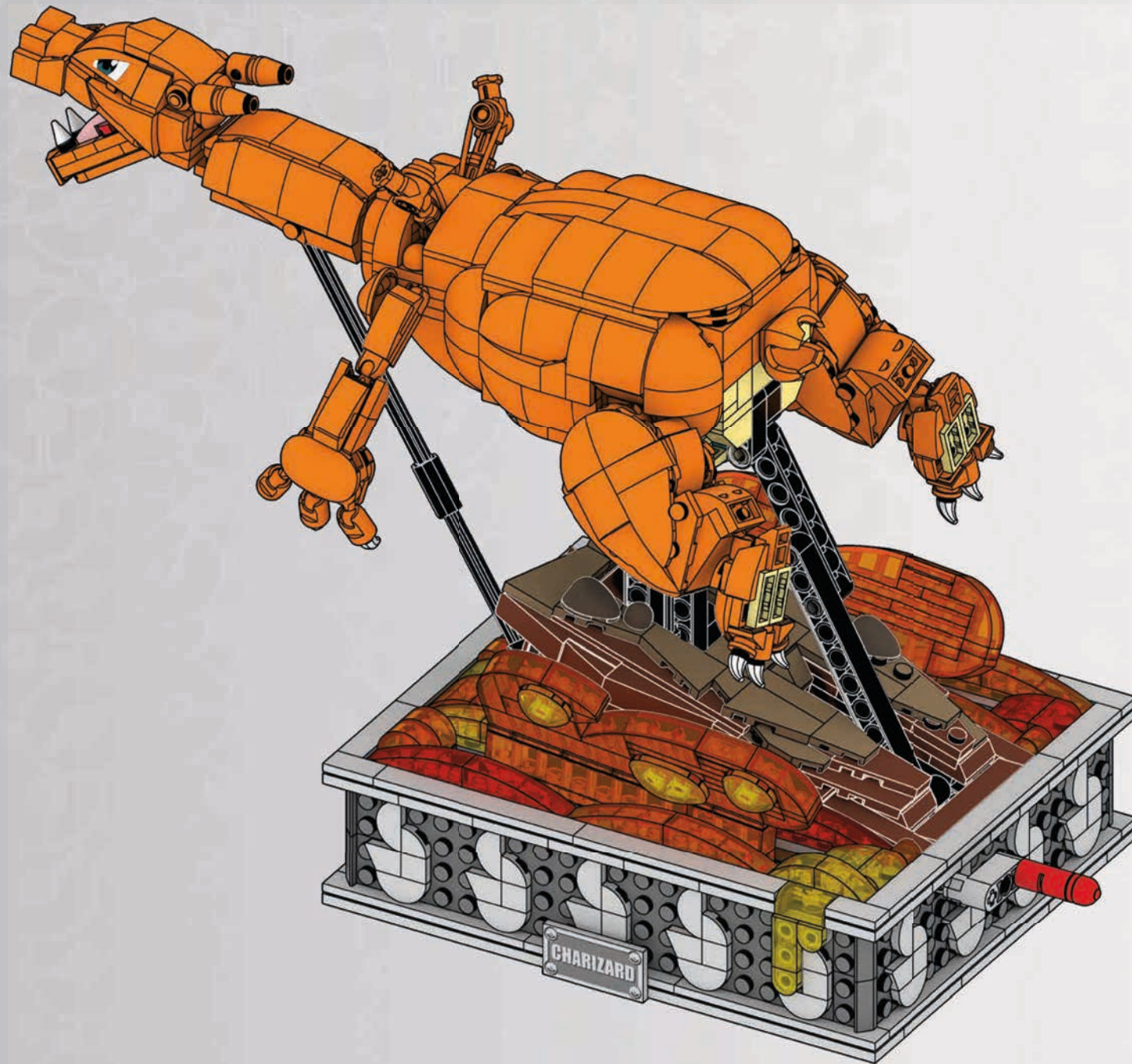

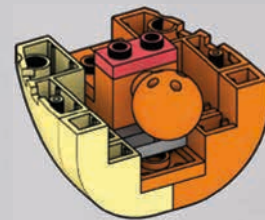
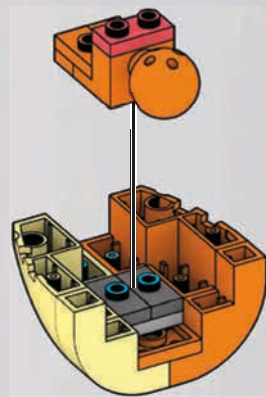
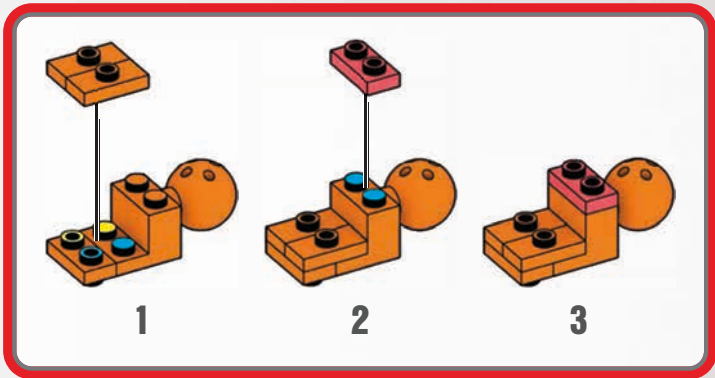
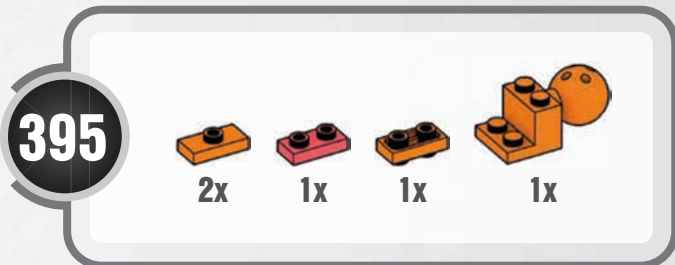
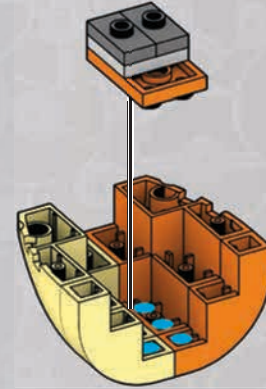
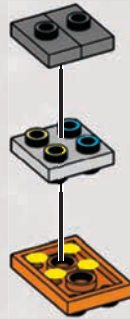
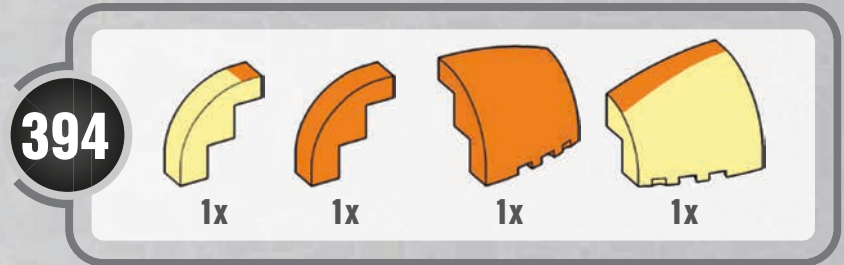
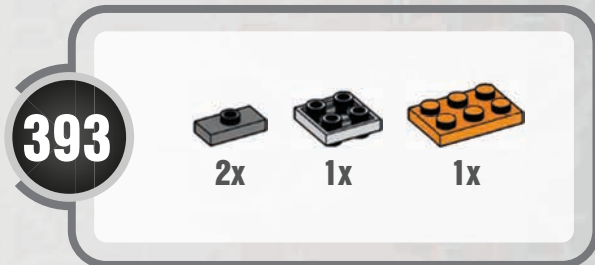
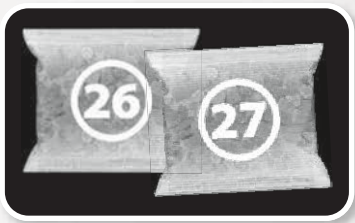

1

2

396

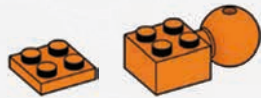

1x

1x

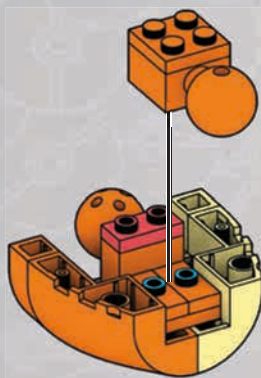
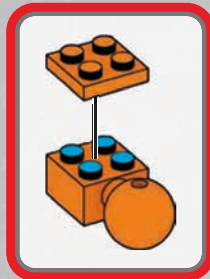

1

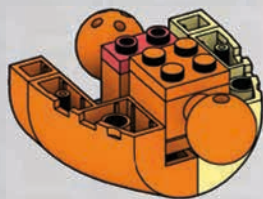

2

397



2x

4x



1

2

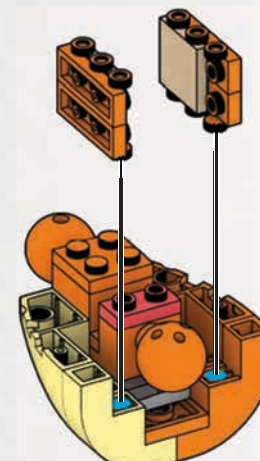

398



2x

2x

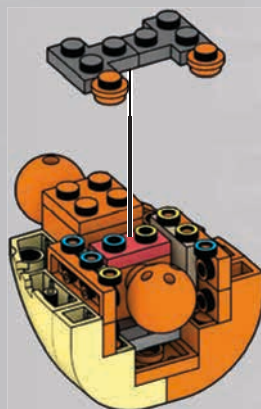

1

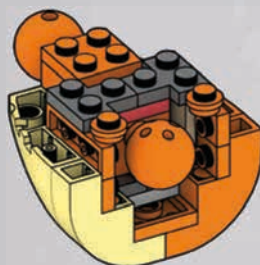

2

399

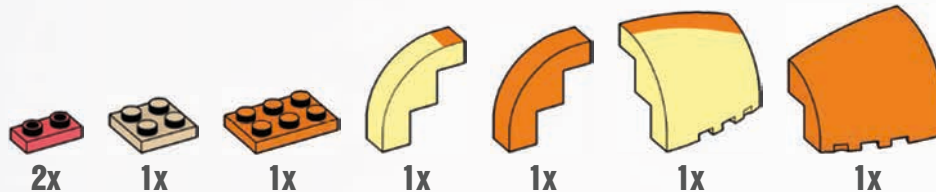

2x

1x

1x

1x

1x

1x

1x

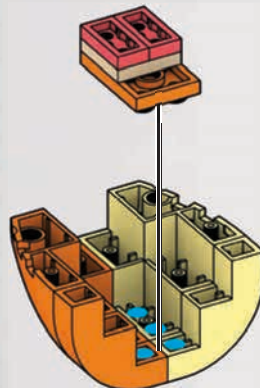
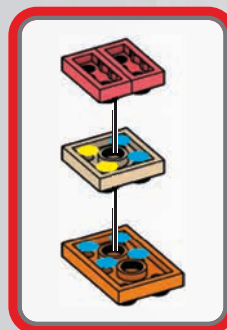

1

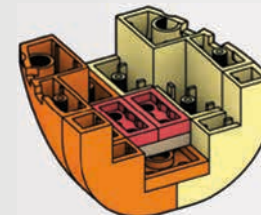

2



400

398

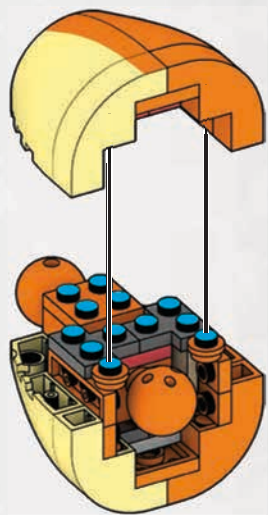

1

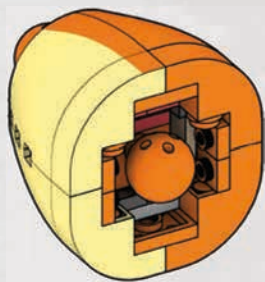

2

401



1x

1x

1x

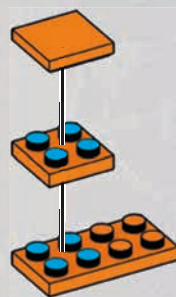

402



2x

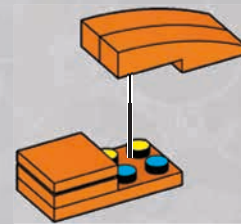

1

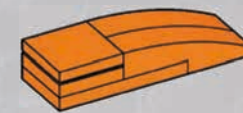

2

403



2x

2x

1x

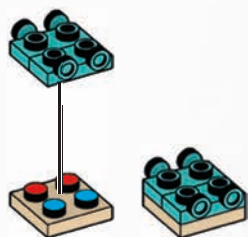

1



2

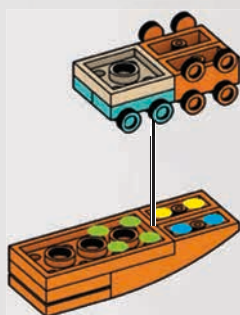

404



1x

1x

1x

1x

1x

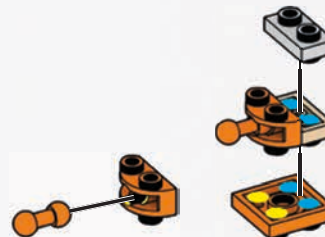

1

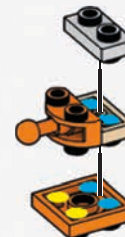

2



3



4

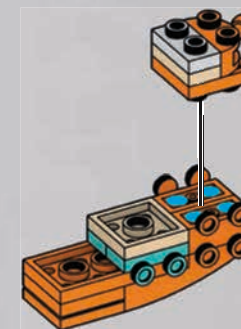

405



1x

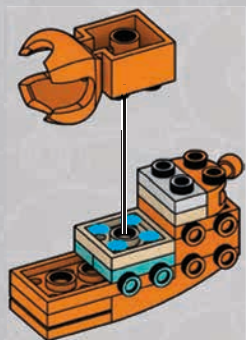

406



1x

2x

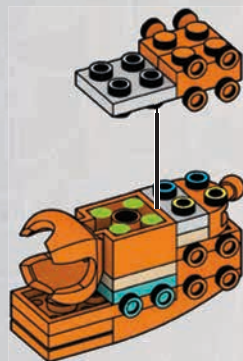

407



1x

2x

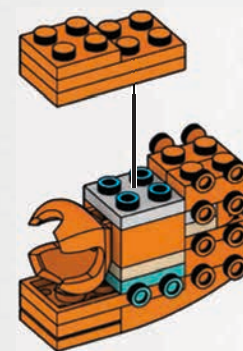
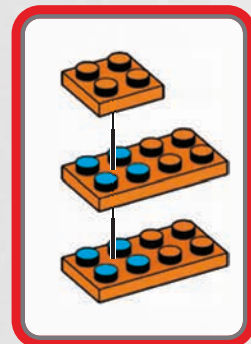

408



1x

2x

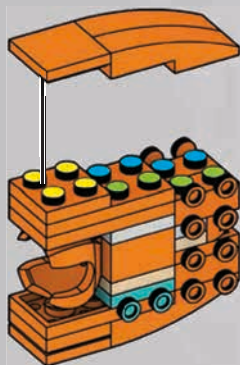

1

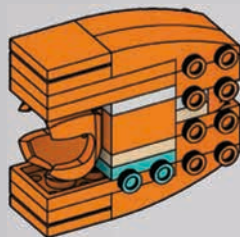

2

409

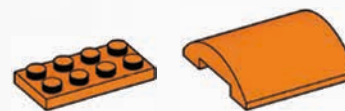

1x

1x

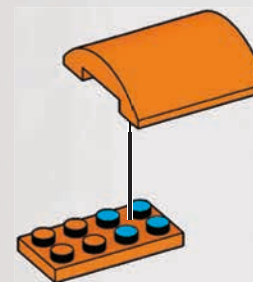

410

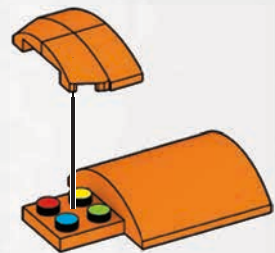

1

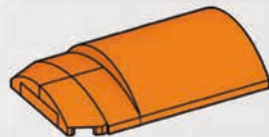

2

411

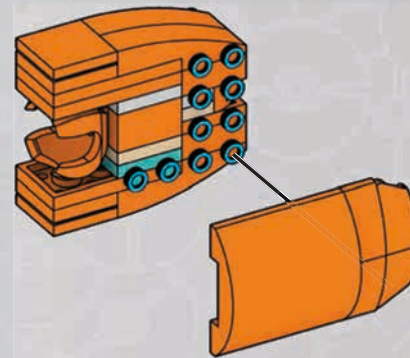

1

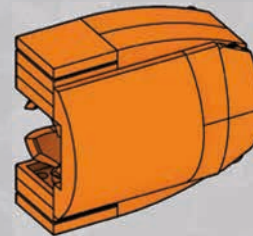

2

412

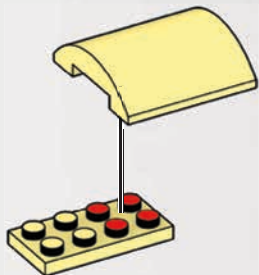
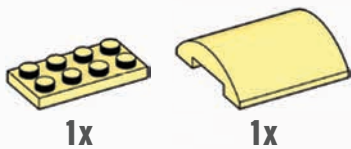

413

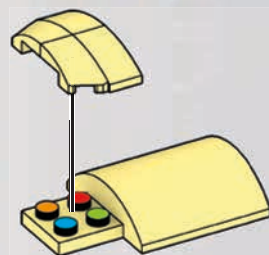
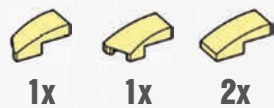

1

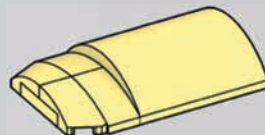

2



414

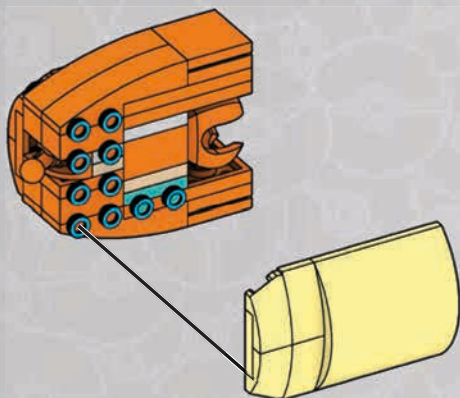

1

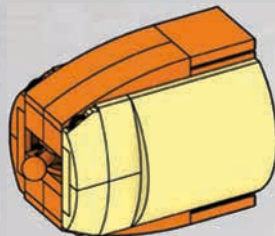

2

415

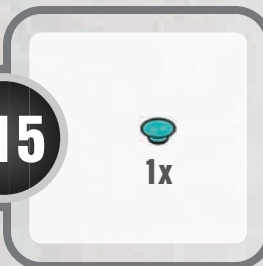

1x

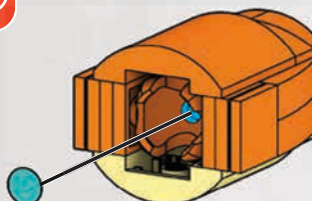

1

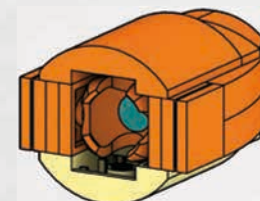

2

416

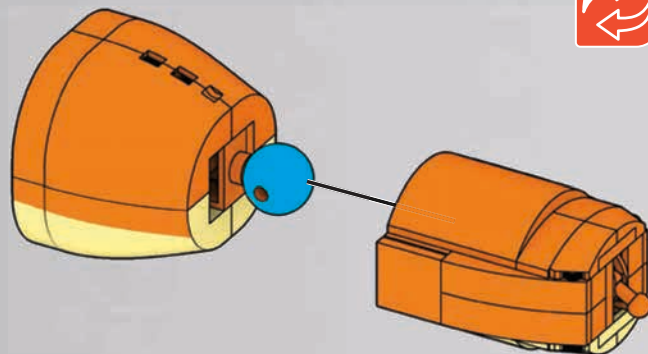

1

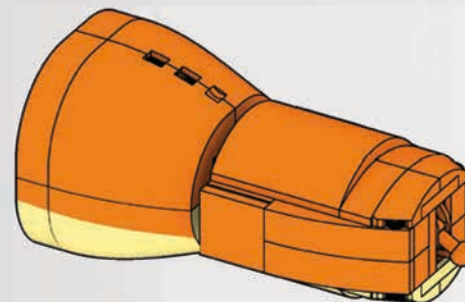

2



417

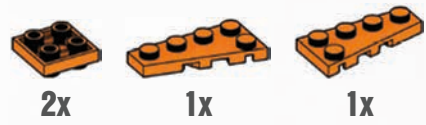

418

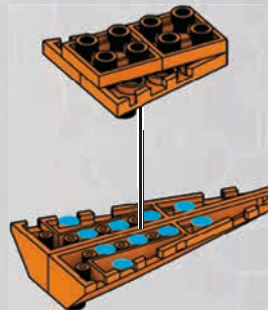
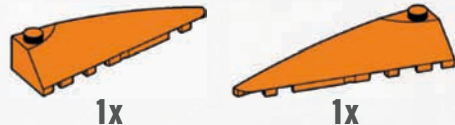

419

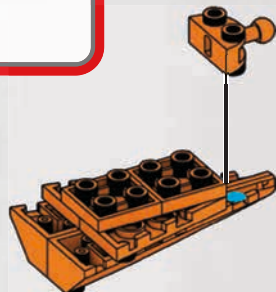
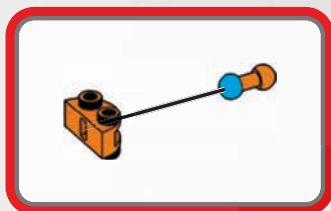
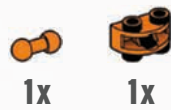

420

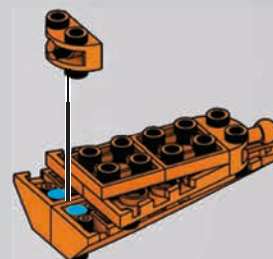

421

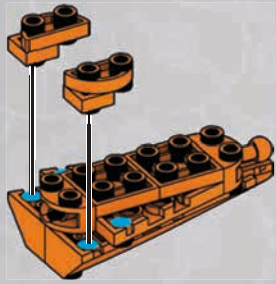
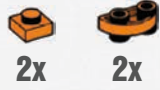

422

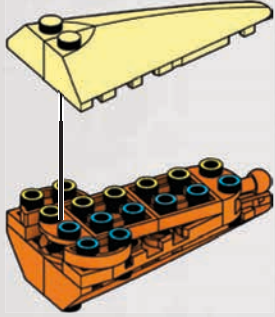
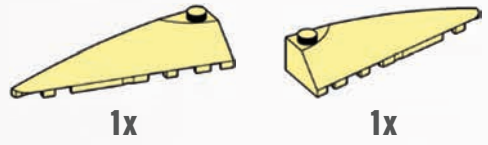

1

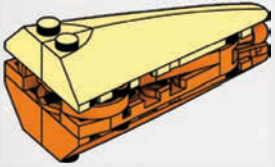

2

423

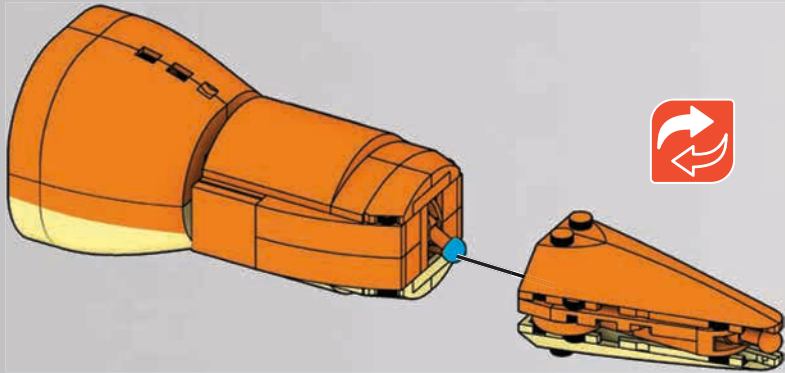

1

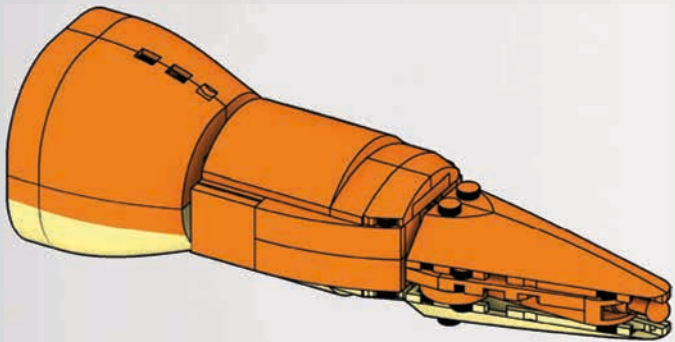

2



424

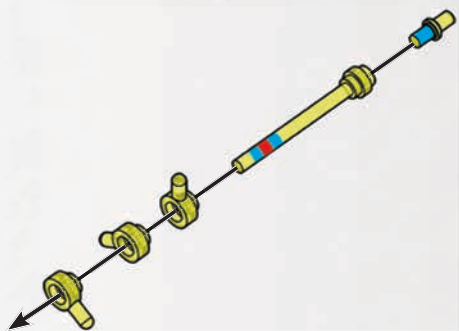
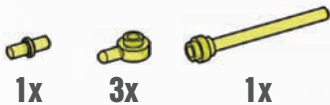

425

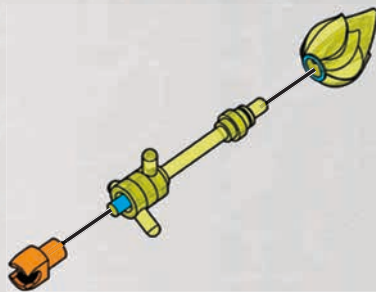
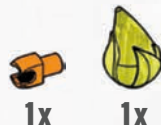

426

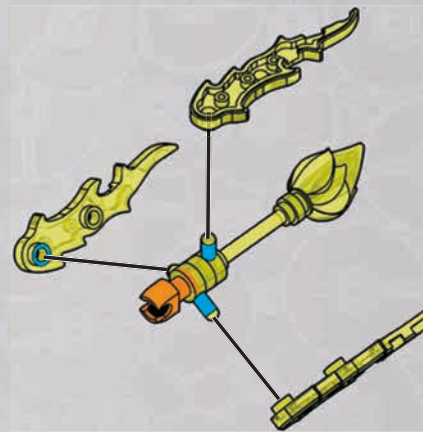

1

2

427

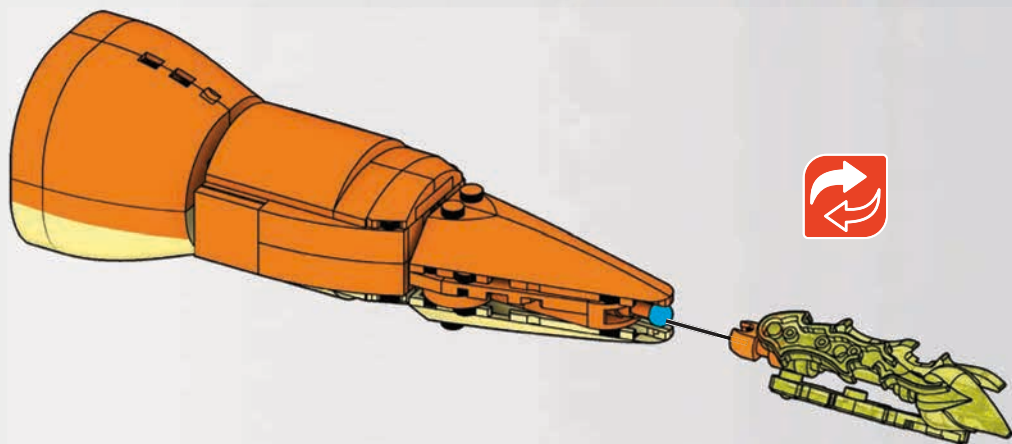

1

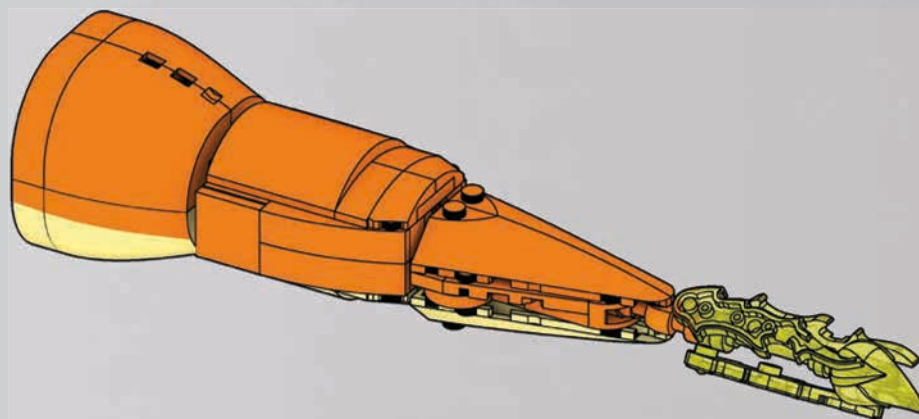

2

428



1x

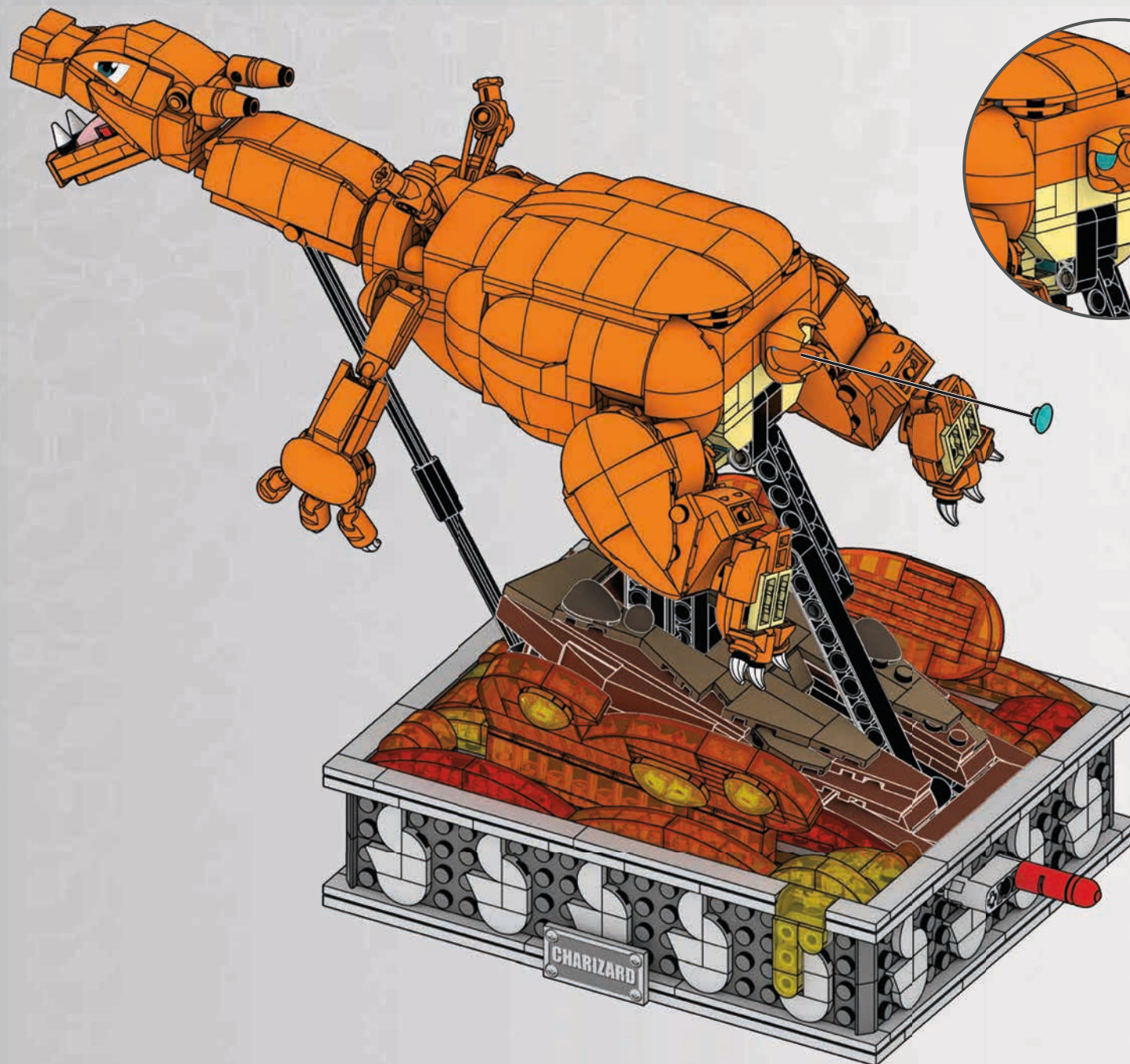

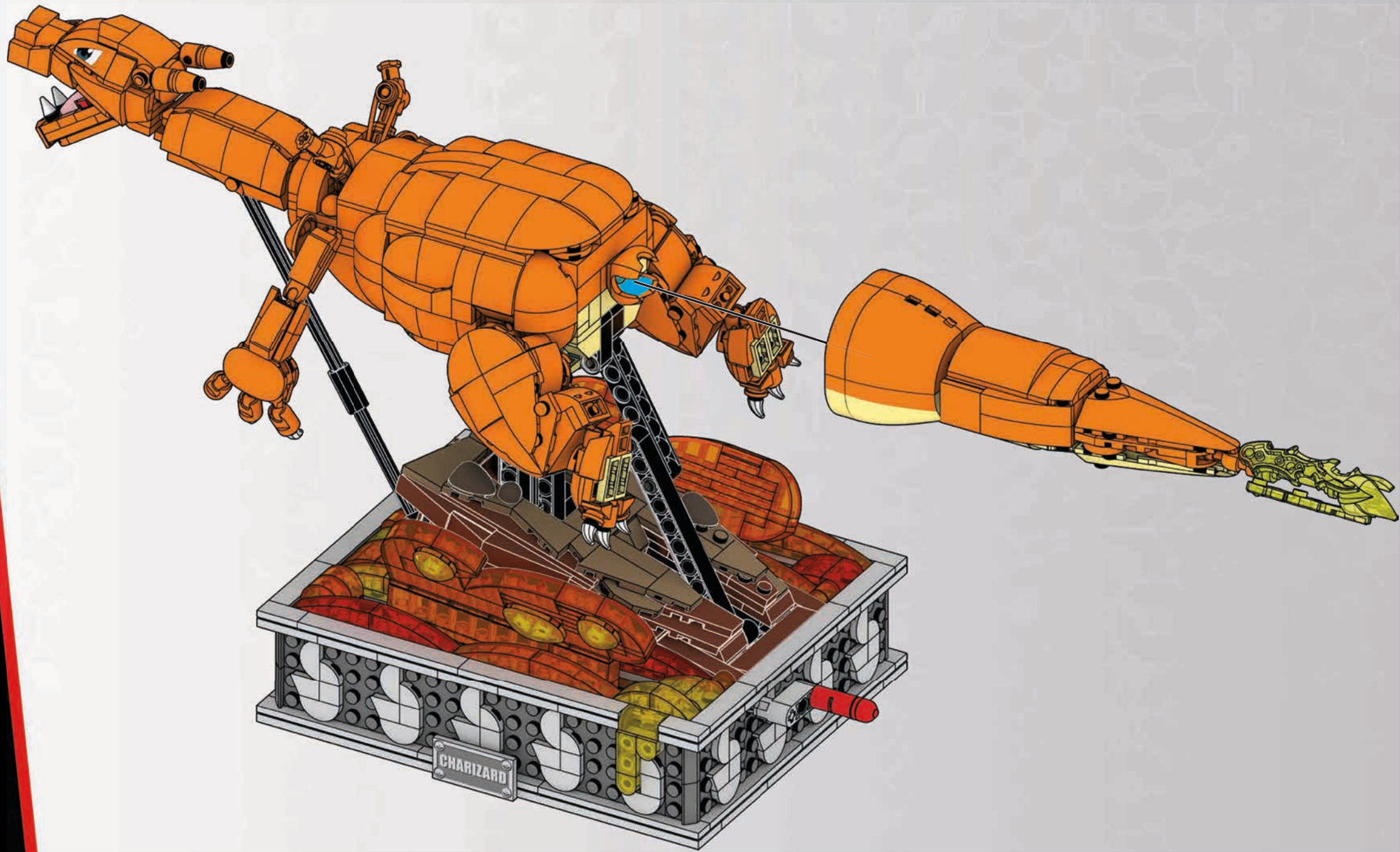

1

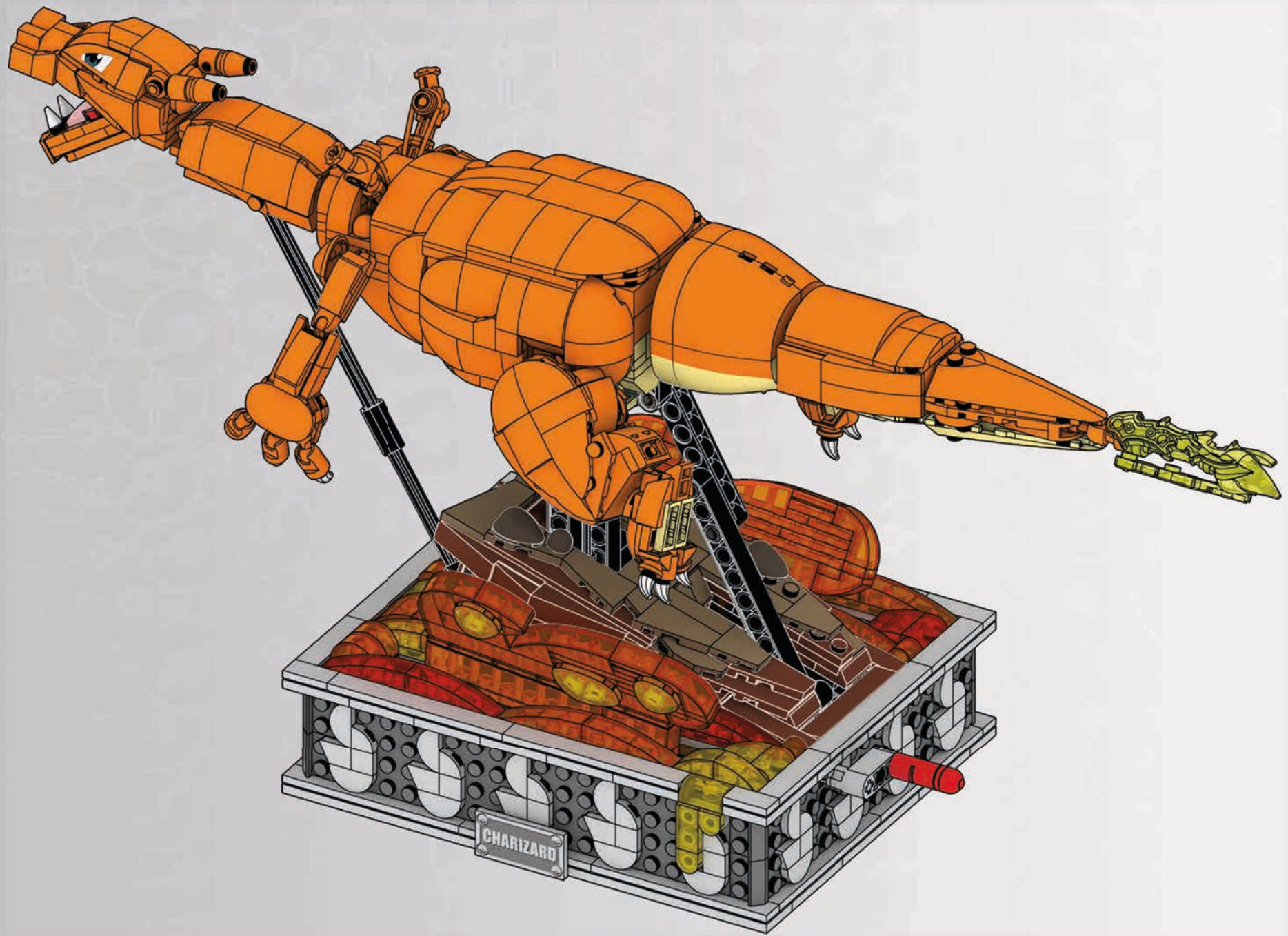

2





430

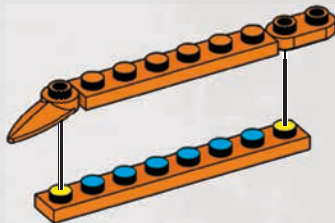
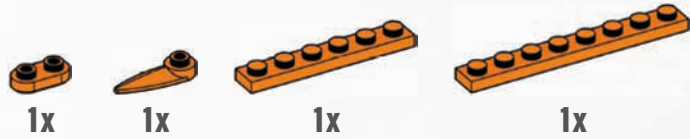

431

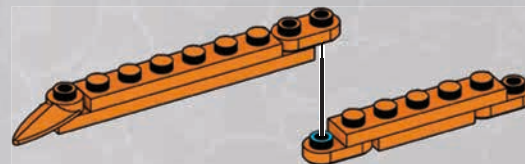
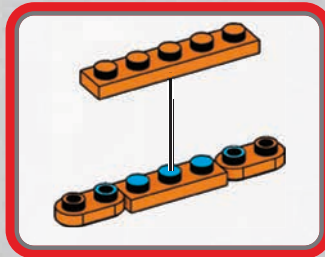

432

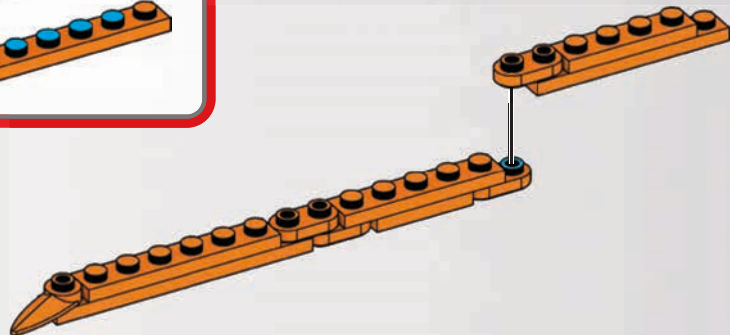
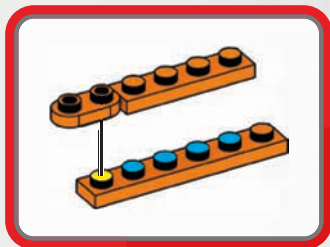

1

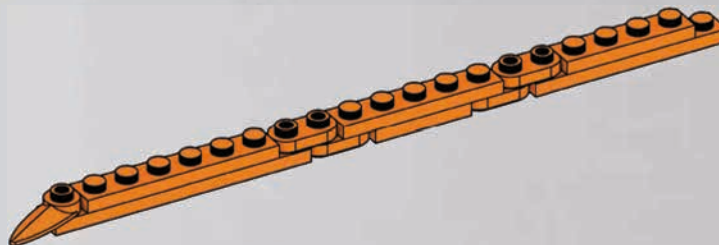

2



433

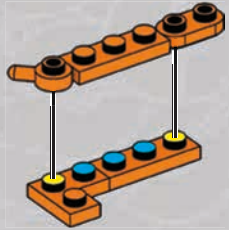

434

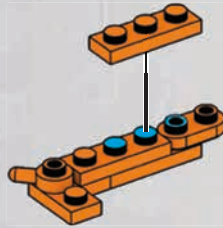

435



1

2

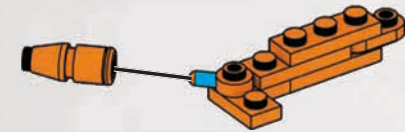

1

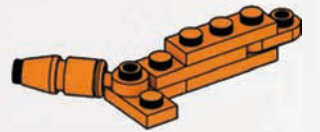

2

436

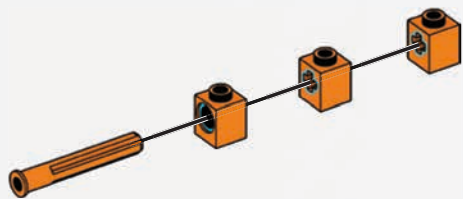

1

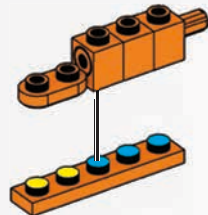

2

437

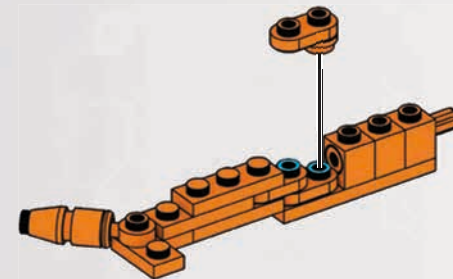

1

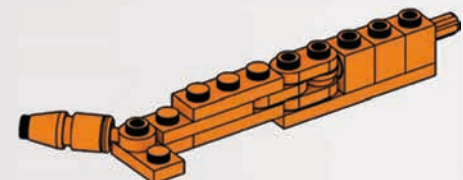
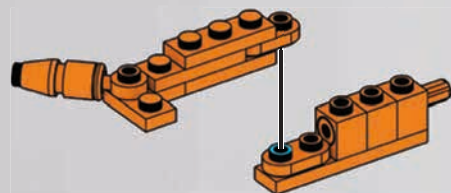

2



438

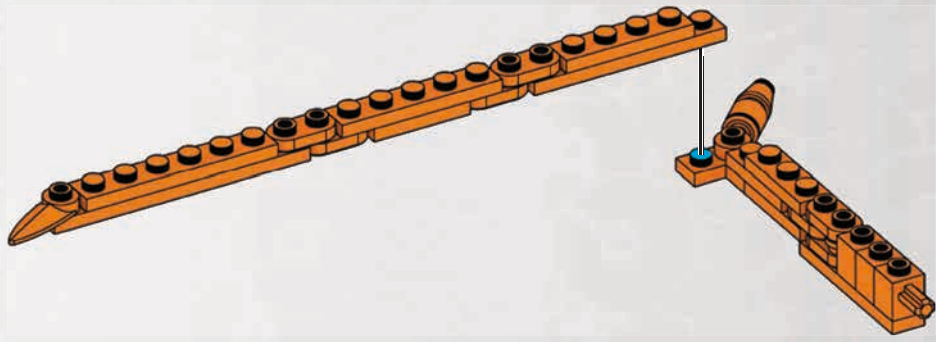

439



1x

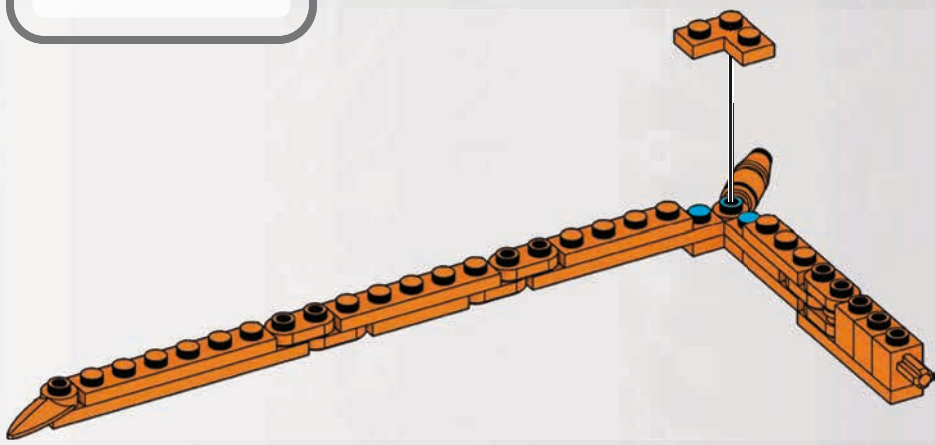

1

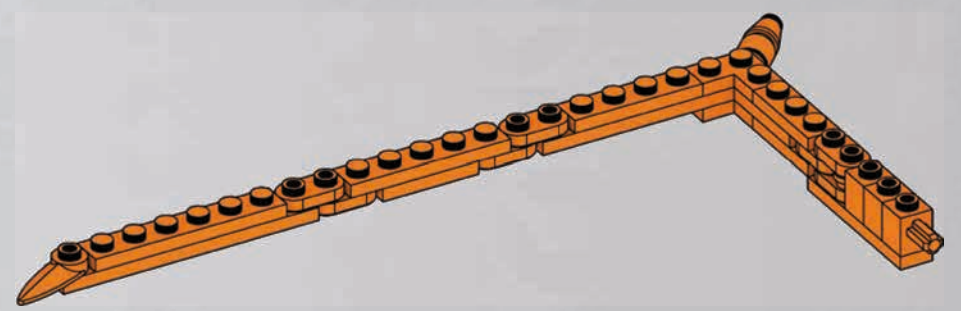

2

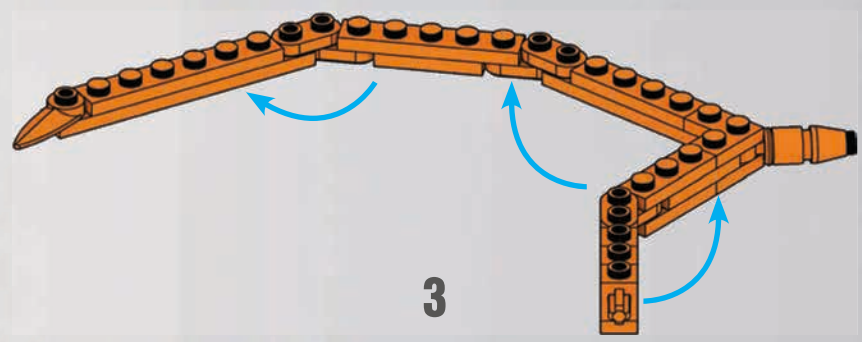

3

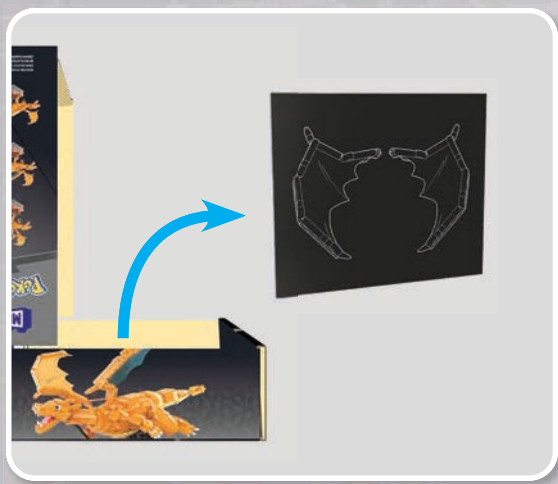

440

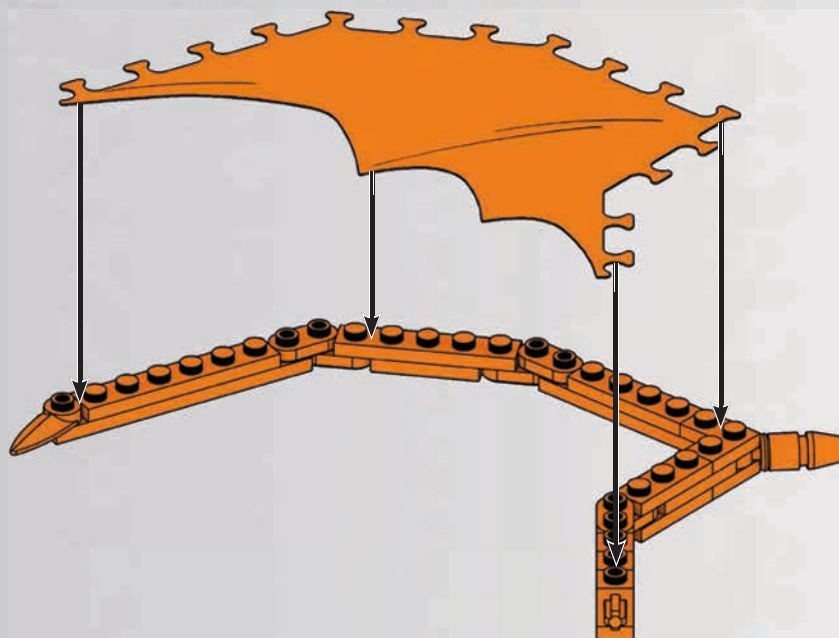
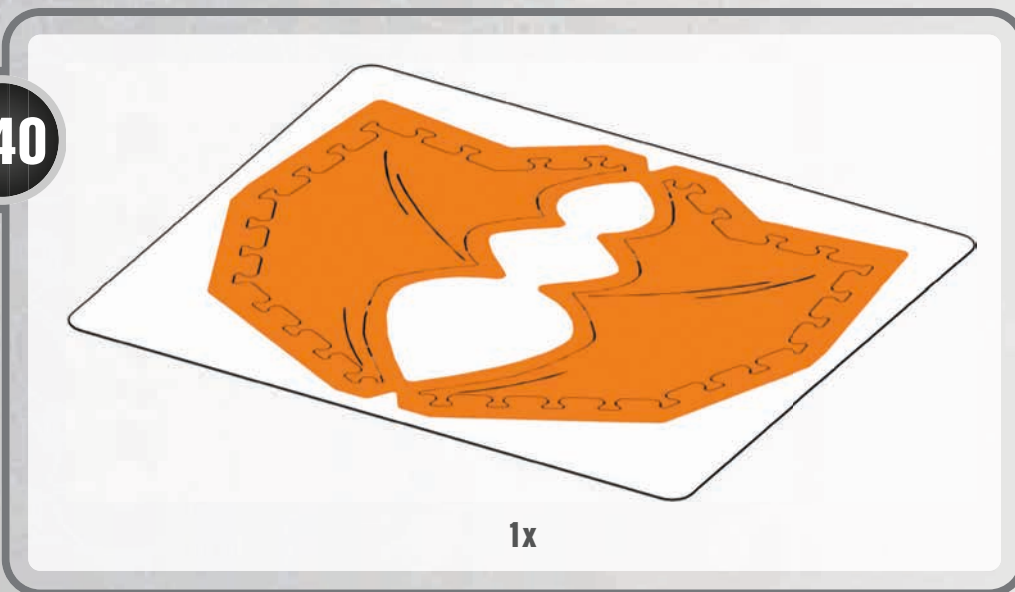

441

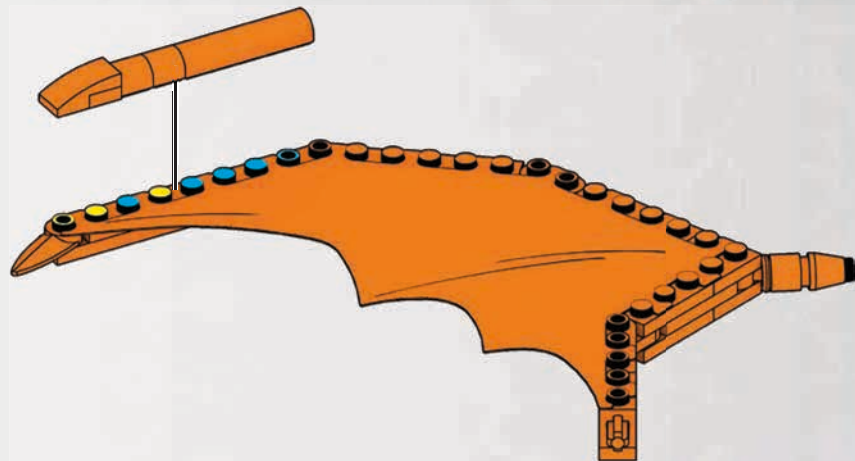
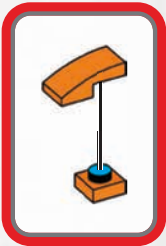

442

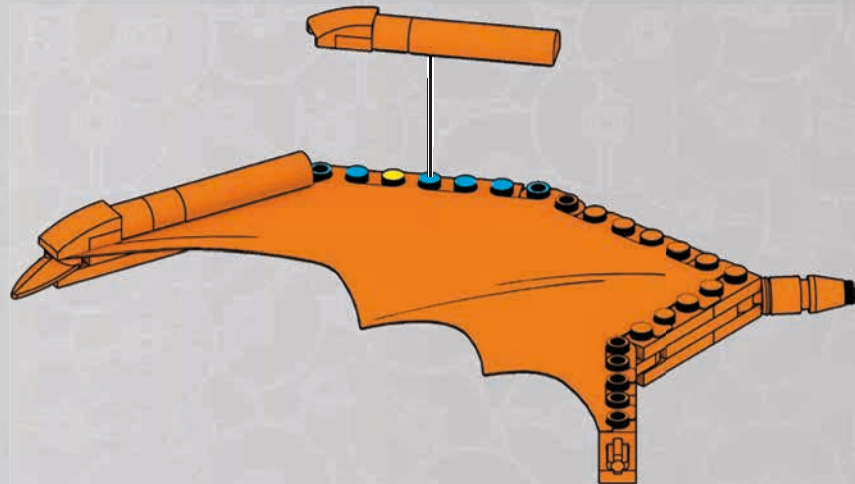

443

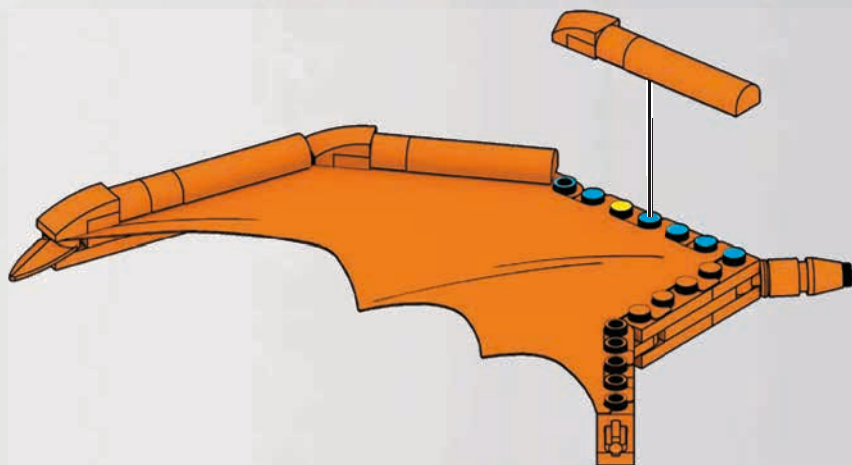

444



1x

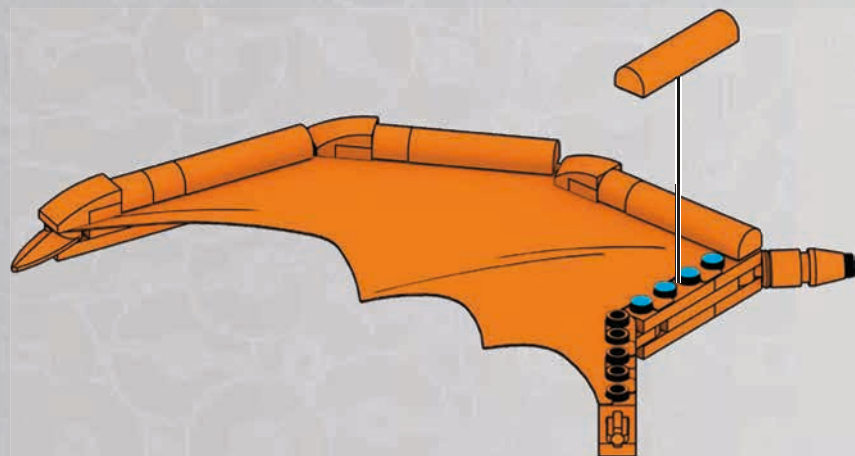

1

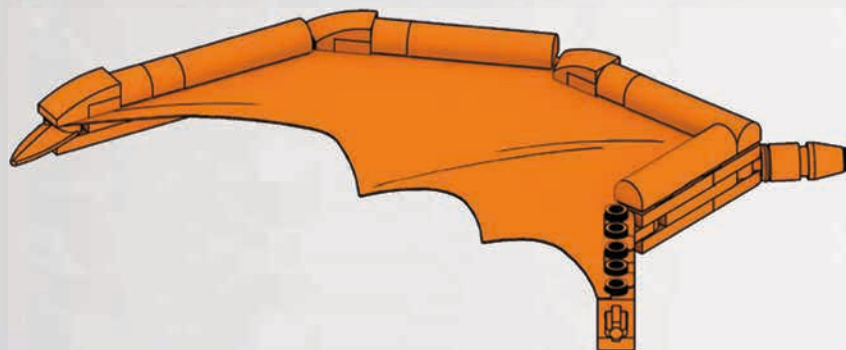

2

445



1x



1x



1x

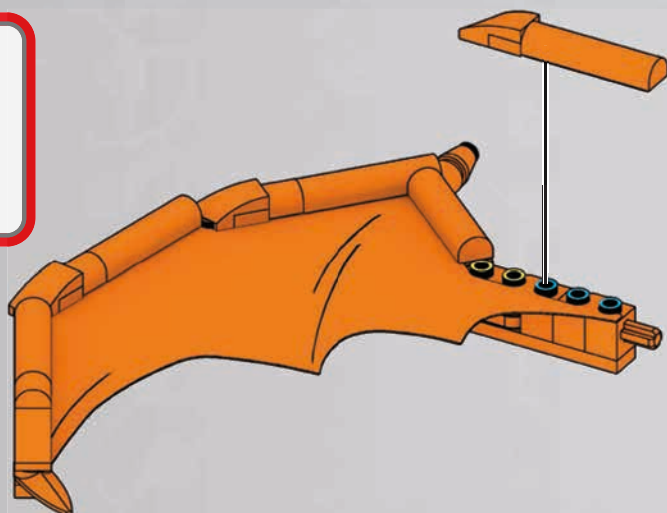
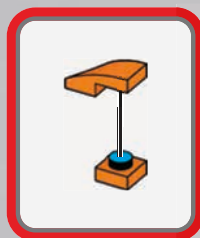

1

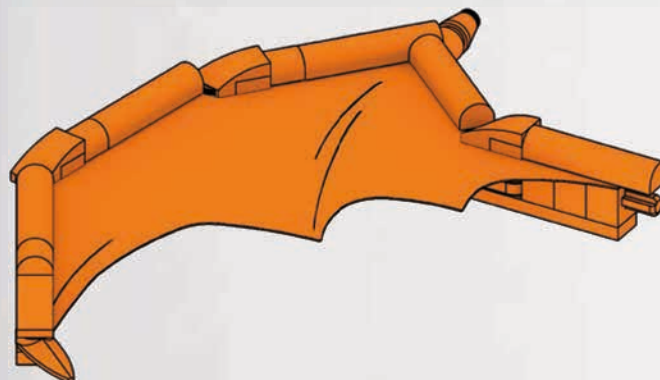

2



446

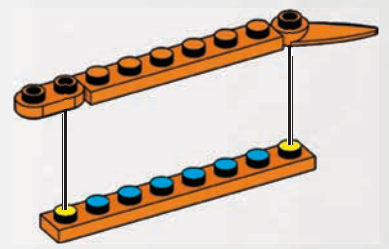
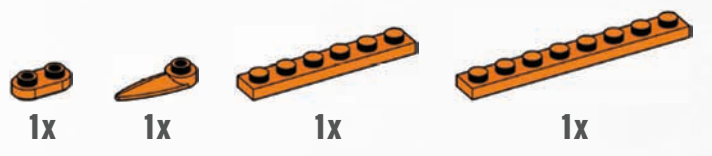

447

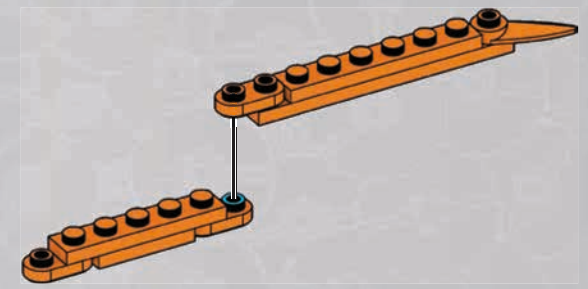
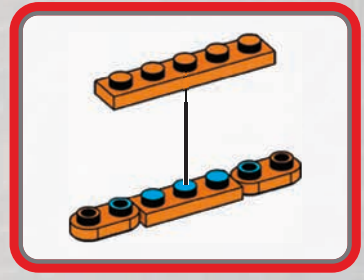

448

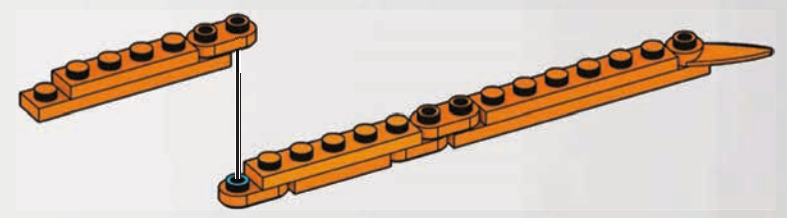
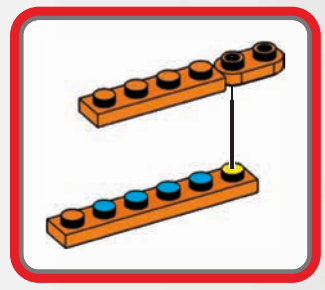

1

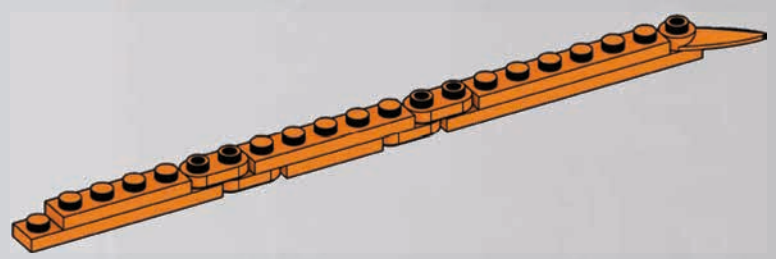

2

449

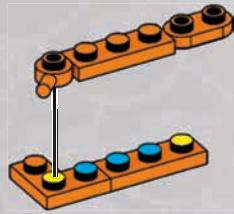

450

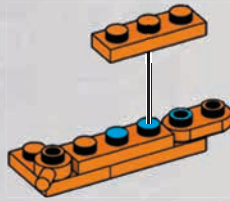

451

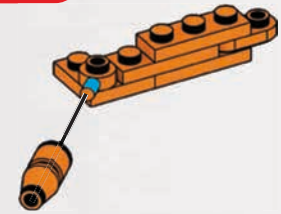

452

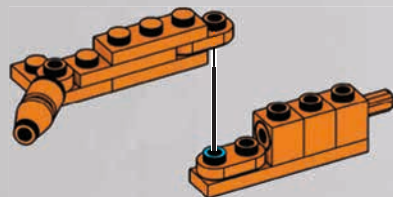
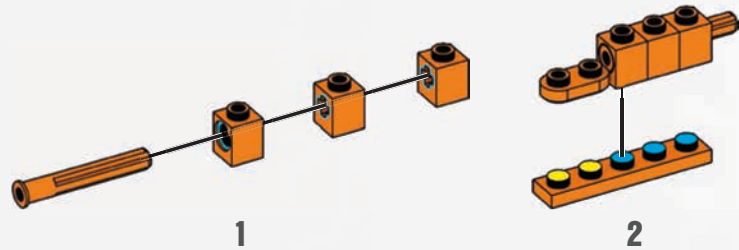
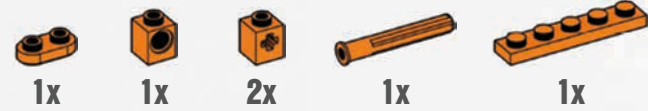

453

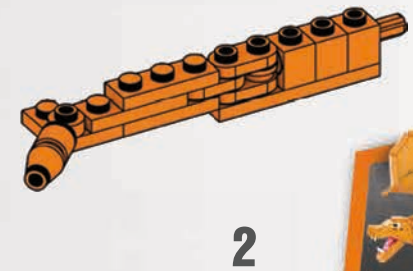
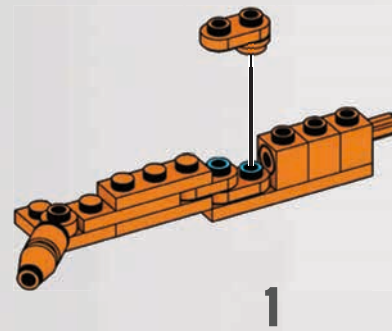

454

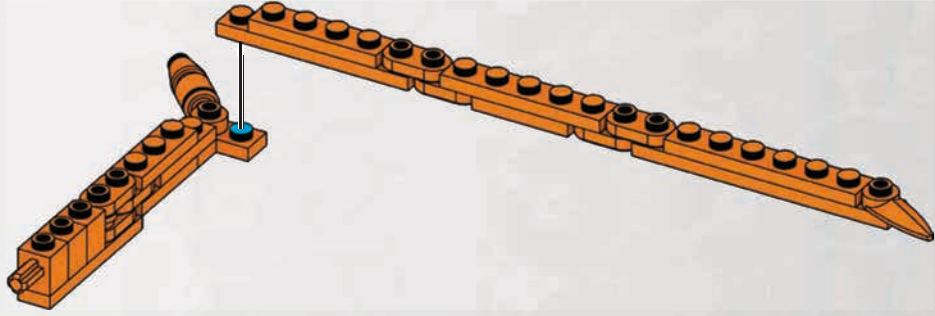

455



1x

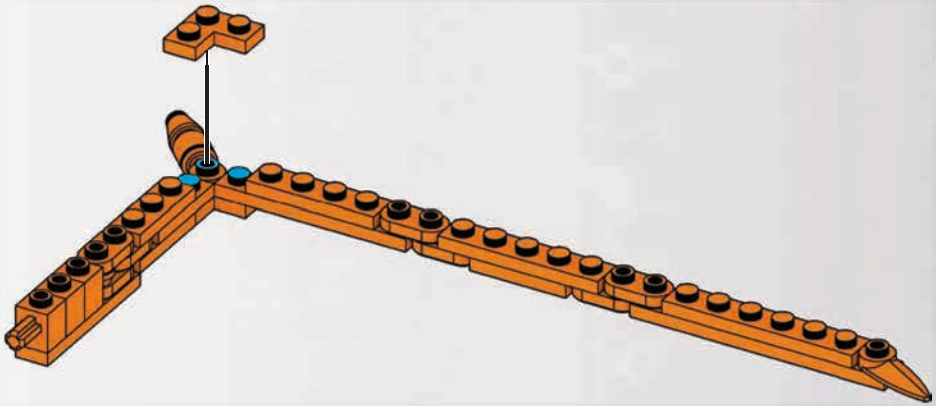

1

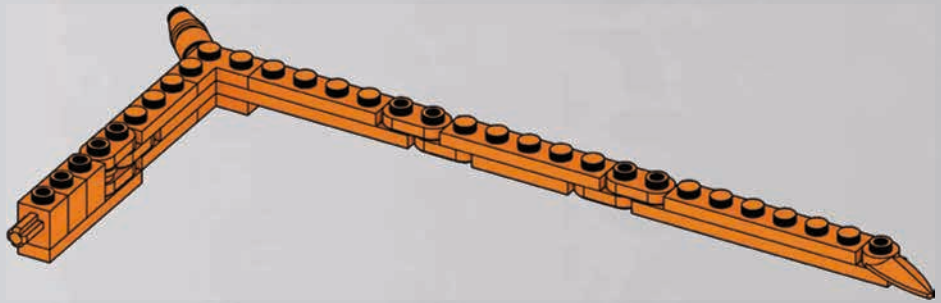

2

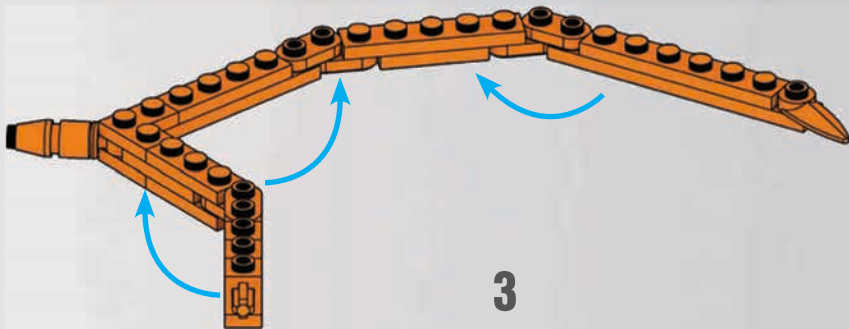

3



456

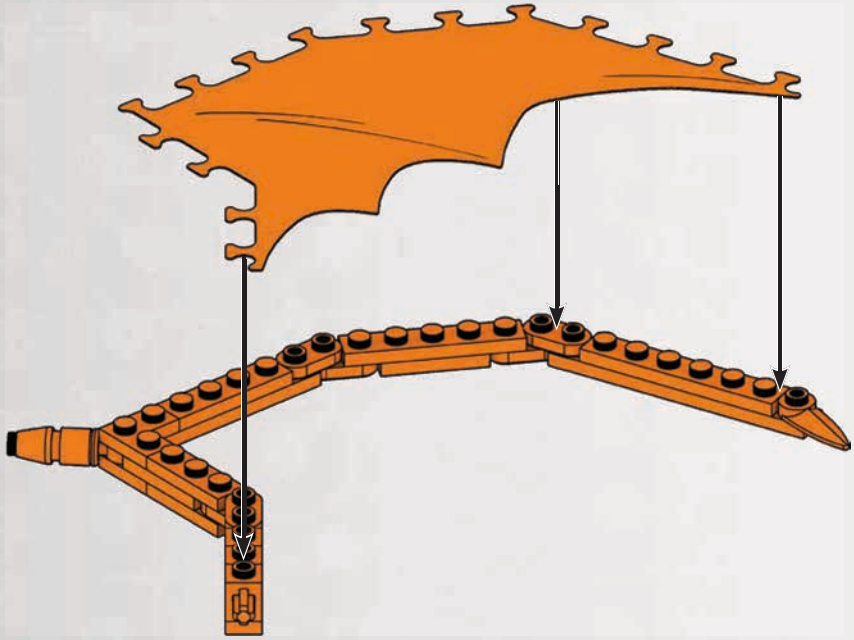
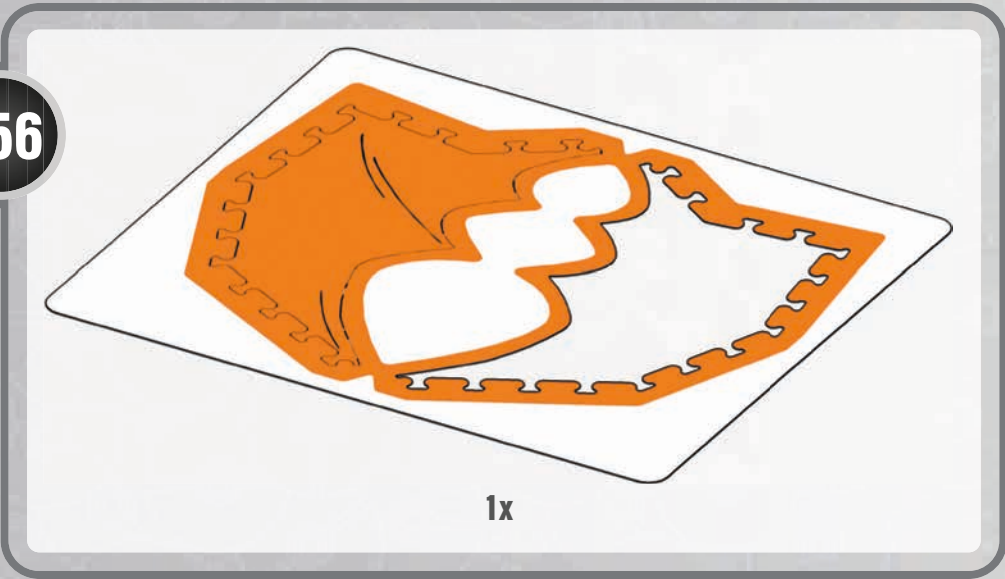

457

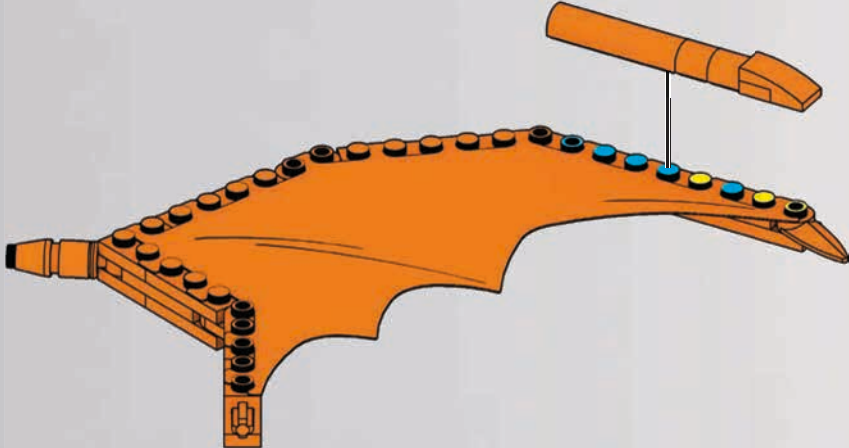
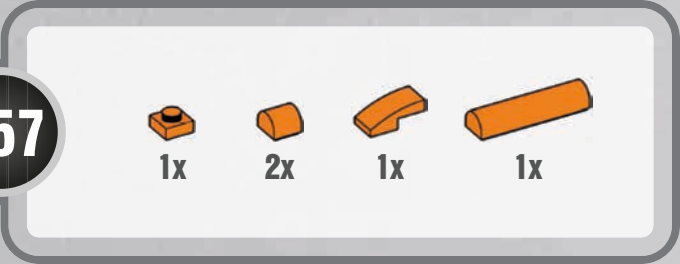

458



459

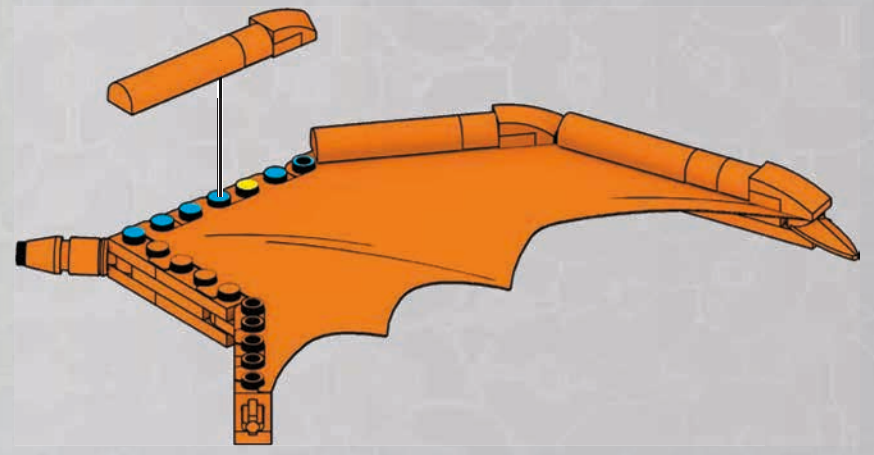
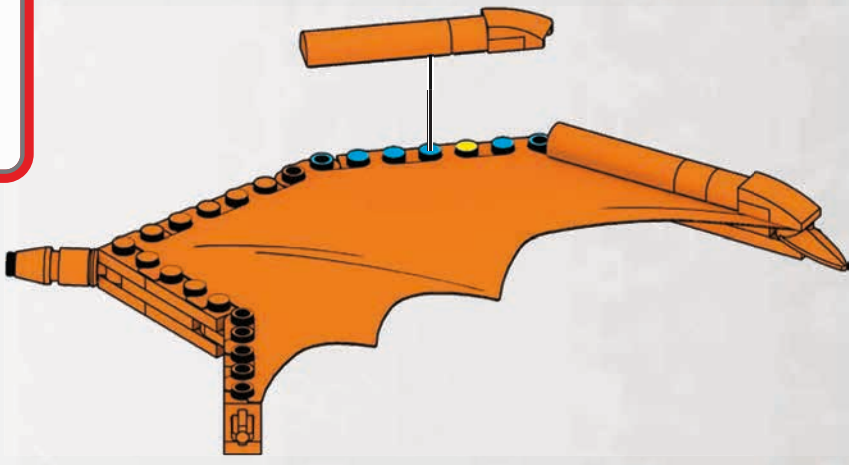
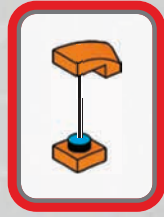

460

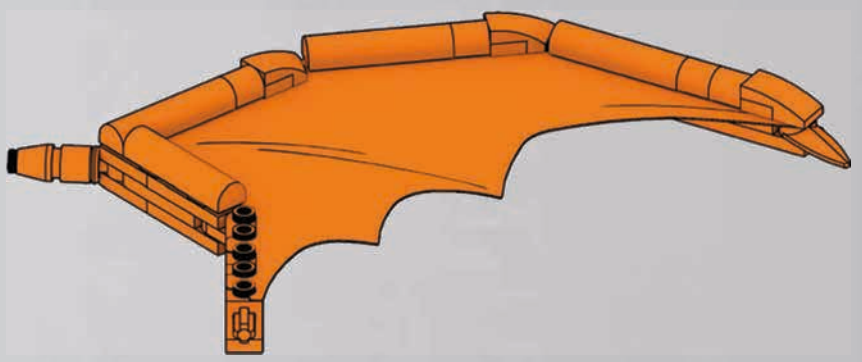
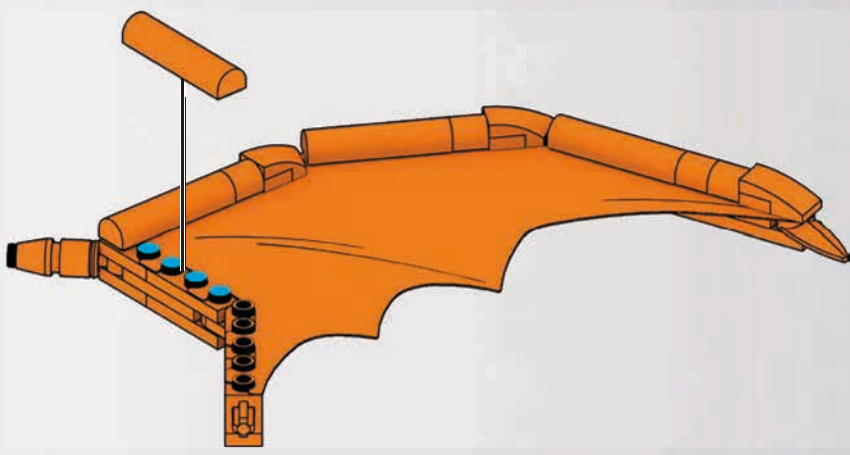
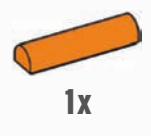

1

2

461

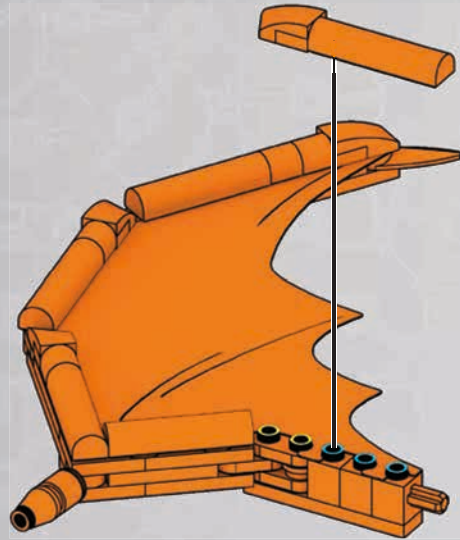
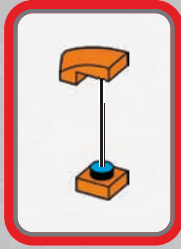

1

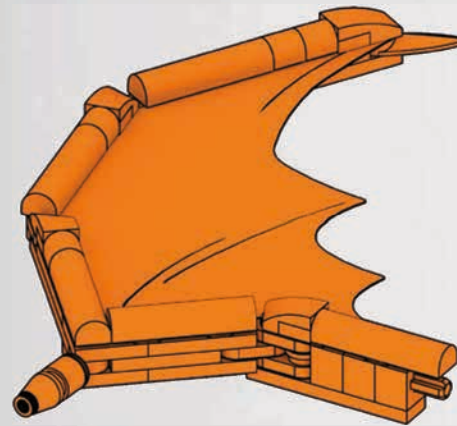

2



462

460

444

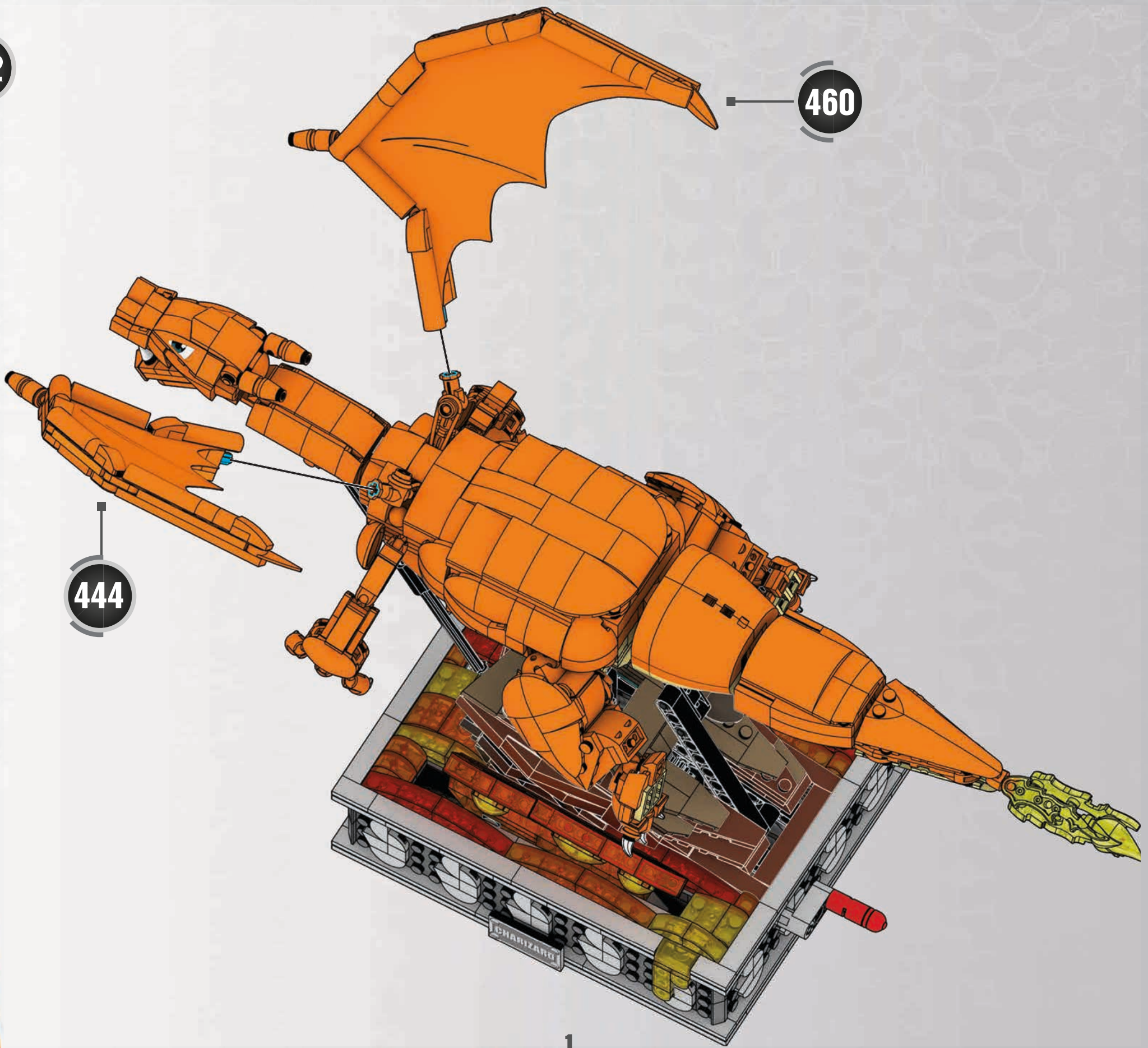

1

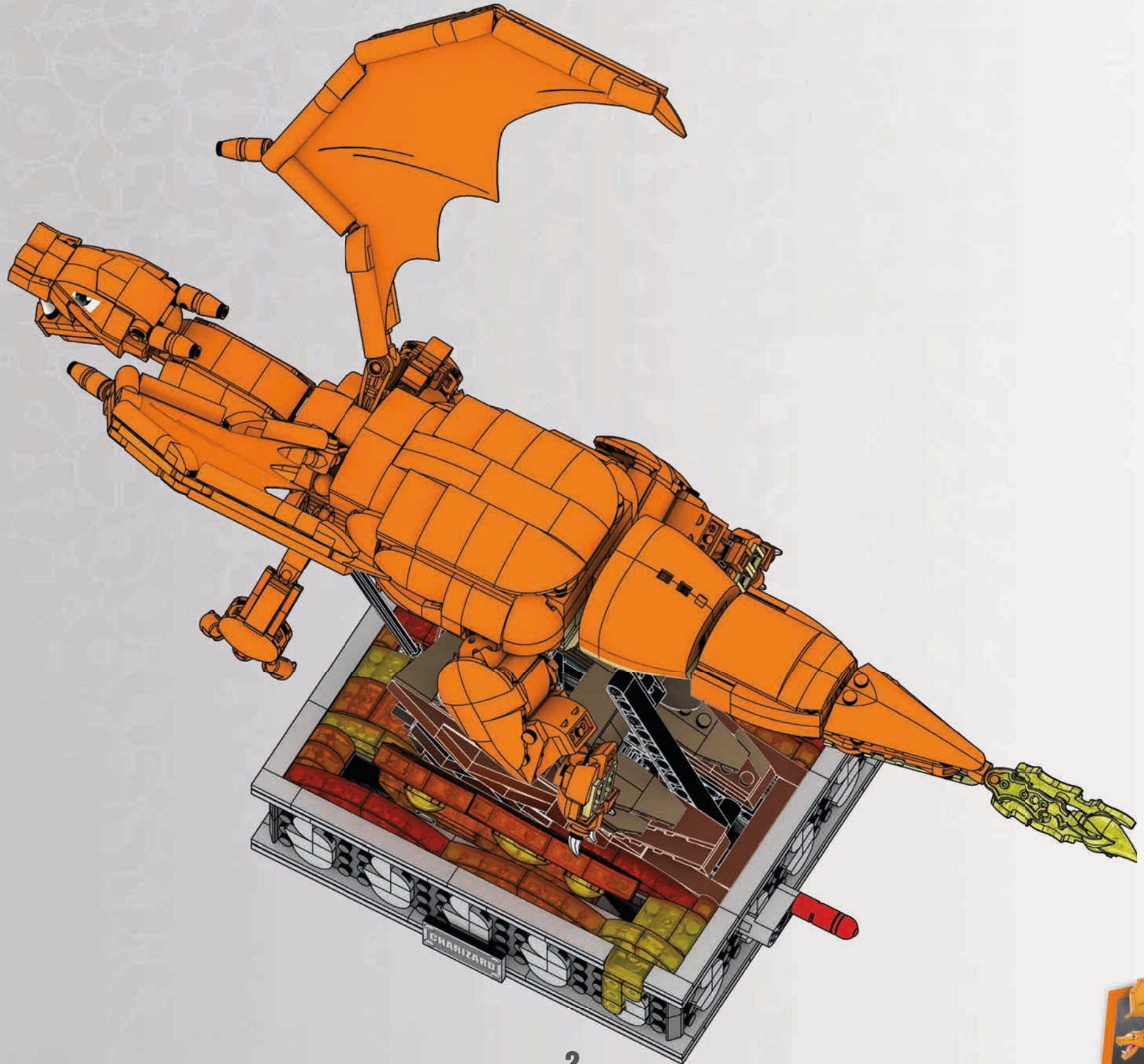

2



MEGA

POKÉMON





**SCAN TO SEE MOVEMENT**  
**SCANNEZ POUR LE VOIR EN MOUVEMENT**

ESCANEA EL CÓDIGO PARA VER A PIKACHU EN MOVIMIENTO  
LÊ PARA VERES MOVIMENTO / FÜR EINEN EINDRUCK DER  
BEWEGUNGEN SCANNEN / ОТСКАНИРУЙТЕ, ЧТОБЫ УВИДЕТЬ ДВИЖЕНИЕ

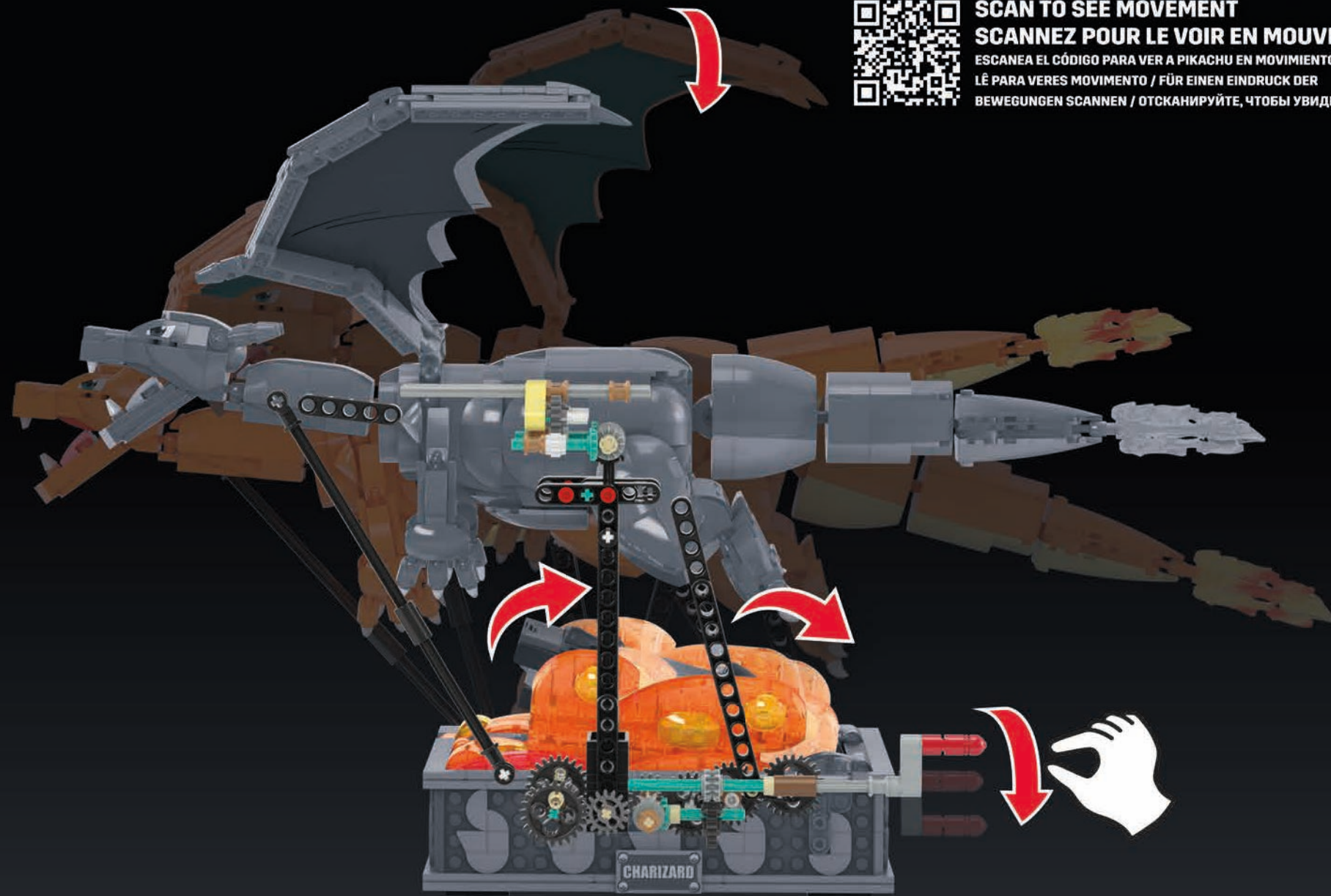

4x AM80524CV  
 1x AM77341AMC  
 3x AM77341JU  
 2x AM75332BLG  
 1x AM75332JU  
 14x AM01113BTN  
 5x AM01113JU  
 10x AM18560JU  
 6x AM79915BTN  
 1x AM78219AAZ  
 2x AM78219JU  
 1x AM78802AMC  
 1x AM76558JU  
 2x AM76204KC  
 2x AM76204ZD  
 4x AM07223JU  
 18x AM07223BLG  
 1x AM07223KC

3x AM03328ASE  
 1x AM03328AYB  
 2x AM03328CS  
 13x AM03328JU  
 4x AM03328KC  
 3x AM81529JU  
 4x AM81529KC  
 17x AM81716BLG  
 2x AM81716JU  
 2x AM79590JU  
 2x AM79590CV  
 10x AM77574MD  
 2x AM17787JU  
 1x AS-HMW05-03  
 1x AS-HMW05-04  
 8x AM16980JU  
 4x AM16980KC

1x AM17003AMC  
 1x AM17003AMZ  
 2x AM17003CV  
 12x AM79425E  
 2x AM80263JU  
 2x AM19617FM  
 2x AM72244JU  
 3x AM01312AMZ  
 4x AM01312JU  
 2x AM01140JU  
 2x AM19392FM  
 4x AM80181E  
 5x AM81718RQ  
 1x AM81712BLG  
 13x AM81712ASE  
 4x AM79487JU  
 4x AM80170E  
 4x AM17127JU  
 1x AM17127DH

6x AM79562JU  
 1x AM81546JU  
 1x AM81545JU  
 7x AM74299JU  
 17x AM74299BLG  
 1x AM74299DH  
 1x AM74300ASE  
 1x AM74300DH  
 7x AM74300JU  
 6x AM19530JU  
 4x AM78273JU  
 2x AM81433JU  
 2x AM81433CV  
 6x AM79704E  
 8x AM72534BTN  
 21x AM73534BDG  
 1x AM80485JU

4x AM72001JU  
 2x AM72001KC  
 1x AM15258FM  
 1x AM15258NV  
 2x AM07659JU  
 4x AM81215JU  
 2x AM80144JU  
 2x AM00910JU  
 6x AM78275JU  
 8x AM01086E  
 2x AM01086DH  
 16x AM80356CS  
 3x AM80356JU  
 4x AM81432JU  
 2x AM07629JU  
 4x AM18286CS

7x AM79873BLG  
 1x AM72090AMC  
 2x AM80174ZD  
 3x AM80174KC  
 3x AM80174RQ  
 15x AM80174JU  
 3x AM79288JU  
 35x AM79288BLG  
 1x AM79288AMC  
 2x AM79375JU  
 2x AM22501JU  
 3x AM22501BLG  
 2x AM22501KC  
 1x AM22501BTN  
 4x AM22501DH  
 1x AM22501ZD  
 1x AM22501X

1x AM73758ASE  
 2x AM73758DH  
 5x AM07590BDG  
 3x AM07590JU  
 17x AM09393JU  
 23x AM09393BTN  
 4x AM09393BLG  
 4x AM09393F  
 5x AM09393KC  
 3x AM09393DH  
 2x AM09393ZD  
 3x AM79246RQ  
 3x AM09393CS  
 4x AM79246CS  
 4x AM79246AYB  
 7x AM16680JU  
 2x AM16680CS

3x AM16680BLG  
 2x AM79070KC  
 2x AM79070ASE  
 1x AM79070BLG  
 11x AM79070JU  
 13x AM79070CV  
 2x AM78926CS  
 1x AM76467JU  
 2x AM81713F  
 2x AM81713JU  
 4x AM76467MD  
 1x AM15555JU  
 11x AM74426JU  
 11x AM74427JU  
 1x AM74427CS  
 1x AM74426CS  
 1x AM18665DH  
 1x AM18665JU  
 1x AM18666JU

2x AM78391JU  
 2x AM72002KC  
 2x AM72002AYB  
 1x AM79563JU  
 5x AM78397JU  
 3x AM78277JU  
 2x AM81713F  
 2x AM81713JU  
 1x AM17522BDG  
 2x AM18740ASE  
 2x AM18740BLG  
 2x AM18740JU  
 1x AM18665DH  
 1x AM18665JU  
 1x AM18666JU

4x AM78285ZD  
 1x AM78285JU  
 2x AM74677BTN  
 4x AM74677JU  
 1x AM79815CS  
 10x AM78486JU  
 2x AM78486CS  
 1x AM78486NU  
 3x AM78281JU  
 3x AM16679AYB  
 2x AM03017JU  
 10x AM18272KC  
 1x AM03019DH  
 2x AM03019JU  
 1x AM04430AYB

2x AM17834ZD  
 2x AM17834KC  
 8x AM17788JU  
 4x AM17788KC  
 5x AM17788ZD  
 3x AM01322BLG  
 2x AM01322DH  
 2x AM0147KC  
 1x AM0147BDG  
 2x AM0147CS  
 2x AM79721JU  
 1x AM04217CS  
 5x AM79702BDG



|                  |                   |                  |                  |                  |                  |                   |                  |                  |                  |
|------------------|-------------------|------------------|------------------|------------------|------------------|-------------------|------------------|------------------|------------------|
| 4x<br>AM80259CV  | 2x<br>AM16972RQ   | 2x<br>AM03773AYB | 1x<br>AM81473JU  | 3x<br>AM81438F   | 4x<br>AM18265BLG | 13x<br>AM01314ASE | 2x<br>AM76206JU  | 1x<br>AM07230ZD  | 1x<br>AM78381AMZ |
| 2x<br>AM80259JU  | 9x<br>AM15484BTN  | 6x<br>AM03773JU  | 1x<br>AM81473KC  | 2x<br>AM81438MY  | 2x<br>AM81714JU  | 1x<br>AM01314BLG  | 2x<br>AM76205JU  | 1x<br>AM19899ASE | 1x<br>AM03872FM  |
| 12x<br>AM79877RQ | 2x<br>AM15484BLG  | 7x<br>AM01146JU  | 3x<br>AM81473ZD  | 1x<br>AM81797AMC | 2x<br>AM78282JU  | 1x<br>AM01314BDG  | 2x<br>AM03772KC  | 2x<br>AM19898ASE | 1x<br>AM03872NV  |
| 4x<br>AM79877F   | 10x<br>AM15484JU  | 5x<br>AM01146BLG | 1x<br>AM81473X   | 2x<br>AM81526AAZ | 1x<br>AM81429F   | 2x<br>AM01314CS   | 1x<br>AM03772X   | 1x<br>AM19899DH  | 2x<br>AM16682KC  |
| 6x<br>AM79877JU  | 2x<br>AM18293BDG  | 1x<br>AM01146CS  | 3x<br>AM74106X   | 2x<br>AM79565JU  | 2x<br>AM81719CS  | 10x<br>AM01314JU  | 4x<br>AM03772F   | 1x<br>AM17073ASE | 8x<br>AM16682JU  |
| 19x<br>AM09013E  | 4x<br>AM18293JU   | 8x<br>AM76525JU  | 2x<br>AM74106ZD  | 1x<br>AM80745F   | 1x<br>AM79703F   | 6x<br>AM01314KC   | 1x<br>AM03772FM  | 1x<br>AM17074ASE | 2x<br>AM08480BDG |
| 1x<br>AM79878JU  | 3x<br>AM09835JU   | 2x<br>AM76525CS  | 2x<br>AM74106CS  | 12x<br>AM17153E  | 1x<br>AM81715BLG | 1x<br>AM01314ZD   | 1x<br>AM03772NV  | 1x<br>AM81639JU  | 2x<br>AM08482JU  |
| 14x<br>AM79878CS | 2x<br>AM09835DH   | 8x<br>AM09835BDG | 1x<br>AM74106AMC | 1x<br>AM10273BLG | 6x<br>AM80143JU  | 2x<br>AM72600RQ   | 6x<br>AM03772JU  | 2x<br>AM03873JU  | 2x<br>AM80634JU  |
| 2x<br>AM79878AYB | 1x<br>AM72000JU   | 8x<br>AM80799JU  | 12x<br>AM74106JU | 2x<br>AM09023E   | 4x<br>AM80765JU  | 1x<br>AM80966KC   | 1x<br>AM03772DH  | 1x<br>AM03873E   | 1x<br>AM80223CV  |
| 11x<br>AM17502MD | 2x<br>AM76456ASE  | 2x<br>AM78189JU  | 7x<br>AM81484JU  | 2x<br>AM78280JU  | 11x<br>AM81259CV | 2x<br>AM80966JU   | 1x<br>AM03772ASE | 15x<br>AM16384E  | 3x<br>AM80483E   |
| 16x<br>AM81353CS | 2x<br>AM76456DH   | 3x<br>AM18223JU  | 2x<br>AM81484NV  | 1x<br>AM76450ASE | 10x<br>AM81260JU | 2x<br>AM80966BLG  | 15x<br>AM16384E  | 1x<br>AM03873CS  | 2x<br>AM80483JU  |
| 5x<br>AM81353JU  | 2x<br>AM00948BTN  | 2x<br>AM78286ZD  | 2x<br>AM81484NV  | 1x<br>AM18705JU  | 2x<br>AM81260KC  | 2x<br>AM80966BLG  | 6x<br>AM16384KC  | 1x<br>AM03873CS  | 2x<br>AM81293F   |
| 2x<br>AM81353KC  | 3x<br>AM00948JU   | 4x<br>AM78286JU  | 2x<br>AM81484FM  | 2x<br>AM78412JU  | 4x<br>AM81259JU  | 1x<br>AM80966ASE  | 2x<br>AM16384JU  | 6x<br>AM75526JU  | 1x<br>AM73439JU  |
| 6x<br>AM81353AYB | 10x<br>AM03773BTN | 2x<br>AM79532JU  | 3x<br>AM81484KC  | 2x<br>AM78412JU  | 2x<br>AM81260MD  | 1x<br>AM80966DH   | 2x<br>AM07230JU  | 6x<br>AM75525JU  |                  |

1x AM76451AYB  
 1x AM76452DH  
 1x AM76452AYB  
 1x AM09593AYB  
 4x AM09593KC  
 2x AM09593X  
 8x AM09593F  
 4x AM81640BDG  
 7x AM09593JU  
 10x AM09593BTN  
 5x AM09593BDG  
 1x AM09593BLG  
 1x AM09593DH  
 10x AM79678JU  
 1x AM16764AMZ

1x AS-HMW05-01  
 1x AS-HMW05-02  
 3x AS-HMW05-14  
 2x AS-HMW05-15  
 3x AM09838BLG  
 1x AM09838ASE  
 1x AM09838DH  
 1x AM09838JU  
 10x AM74139BLG  
 3x AM81163BLG  
 8x AM19323KC  
 4x AM19323X  
 10x AM19323JU  
 1x AM77650CS  
 1x AM77650JU

6x AM80171AYB  
 2x AM17021KC  
 8x AM17021JU  
 2x AM17021CS  
 2x AM19324JU  
 2x AM19324CS  
 3x AM76856JU  
 2x AM15488JU  
 6x AM15488BDG  
 2x AM80874F  
 1x AM17054BDG  
 1x AM17054BLG  
 1x AM17054F

9x AM16959DH  
 3x AM16959AYB  
 1x AM17503MD  
 6x AM01087E  
 1x AM01087AYB  
 2x AM80260CV  
 1x AM17793BLG  
 13x AM07475ASE  
 2x AM07475DH  
 8x AM07475JU  
 2x AM74065JU  
 2x AM74064JU  
 1x AM77321DH  
 2x AM77321ASE  
 2x AM77320ASE

2x AM79871F  
 2x AM79871CS  
 1x AS-HMW05-09  
 1x AS-HMW05-12  
 1x AS-HMW05-11  
 1x AS-HMW05-10  
 1x AM77463JU  
 1x AM77463F  
 1x AM77463ASE  
 1x AM09493DH  
 1x AM09493F  
 1x AM09493CS  
 6x AM09493JU  
 4x AM09493BTN  
 7x AM09493BLG  
 1x AM09493BDG

4x AM73414JU  
 3x AM09033E  
 1x AM80965JU  
 5x AM15492DH  
 1x AM73472F  
 1x AM79705BLG  
 2x AM79705BTN  
 4x AM16331BLG  
 1x AM16331DH  
 8x AM09292BTN  
 4x AM09292KC  
 1x AM09292AYB  
 2x AM09292BLG  
 9x AM09292JU  
 3x AM78388AMZ

2x AM18657JU  
 1x AS-HMW05-06  
 1x AS-HMW05-07  
 2x AM72257JU  
 2x AM72257KC  
 1x AS-HMW05-08  
 1x AS-HMW05-05  
 1x AM81010JU  
 1x AM81009JU

2x AM81294F  
 8x AM01313E  
 1x AM01313JU  
 1x AM01313FM  
 1x AM01313NV  
 2x AM01313KC  
 4x AM19325JU  
 2x AM19325KC  
 3x AM01480JU  
 6x AM01480BLG  
 2x AM01480DH  
 3x AM01480BTN  
 2x AM01480AYB  
 1x AM04983JU





# POKÉMON



## DISCOVER THE MOTION POKÉMON LINE! DÉCOUVREZ LA GAMME MOTION POKÉMON !

¡DESCUBRE LA LÍNEA EN MOVIMIENTO DE POKÉMON!!  
DESCOBRER A LINHA MOVIMENTO POKÉMON!  
DAS MOTION POKÉMON SORTIMENT ENTDECKEN!  
ОТКРОЙТЕ ДЛЯ СЕБЯ КОЛЛЕКЦИЮ ПОКЕМОНОВ В ДВИЖЕНИИ!



HGC23



HKT22

Set(s) sold separately and subject to availability. / Ensemble(s) vendu(s) séparément. Certains produits peuvent ne pas être commercialisés. / Se vende(n) por separado y está(n) sujeto(s) a disponibilidad. / Conjunto(s) vendido(s) em separado e sujeito(s) à disponibilidade. / Set in vendita separatamente, secondo disponibilità. / Das/Die Set(s) sind separat erhältlich. / Zestaw(y) sprzedawany(e) oddzielnie w zależności od dostępności. / Set(s) apart verkrijgbaar en afhankelijk van beschikbaarheid. / Набор(-ы) продаются отдельно, при наличии. / Sæt sælges separat og så længe lager haves. / Seten säljs separat så länge lagret räcker. / Settet/settene selges separat så langt lageret rekker. / Pakkaus/pakkaukset myydään erikseen, saatavuus voi vaihdella. / Το(α) σετ πωλούνται ξεχωριστά και ανάλογα με τη διαθεσιμότητα. / Setler ayrı olarak satılır ve stoklarla sınırlıdır. / Set (sety) se prodává (prodávají) samostatně dle aktuální nabídky. / Súprava/-y sa predáva(jú) samostatne a podľa dostupnosti. / A készlet(ek) külön kapható(k), az elérhetőség változhat. / セット商品は別売りになります。在庫状況は別途ご確認をお願いします。 / تباع المجموعة أو المجموعات على حدة وتخضع لتوافرها. / 每套单独发售，按供货情况决定。

©2022 MEGA Brands &™ MEGA Brands.  
Printed in China / Imprimé en Chine

AD-HMW05-01

Mattel Canada Inc. Mississauga, Ontario L5R 3W2.  
MADE IN CHINA. FABRIQUÉ EN CHINE. FABRICADO NA CHINA. HECHO EN CHINA.  
ИЗГОТОВЛЕНО В КИТАЕ. ÇIN'DE ÜRETİLMİŞTİR. صنع في الصين

1186 MJ, 1, NL

© D781,964, D797,203, D799,607, D799,608,  
D835,727, D841,101, D834,105



**BUILD & SHARE!**  
**CONSTRUIRE ET PARTAGER**  
**CONSTRUYE Y COMPARTE**  
MONTAR E COMPARTILHAR / BAUEN UND MIT ANDEREN TEILEN / СОЗДАВАЙ И ДЕЛИСЬ  
[megaunboxed.com](http://megaunboxed.com)

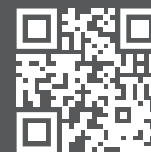

**JOIN THE COMMUNITY**  
**REJOIGNEZ LA COMMUNAUTÉ**  
**ÚNETE A LA COMUNIDAD**

ENTRE NA COMUNIDADE  
DER COMMUNITY BEITRETEN  
ПРИСОЕДИНЯЙТЕСЬ К СООБЩЕСТВУ

