

INSTRUCCIONES DE ENSAMBLE

Encuétranos en: www.practimac.com y [YouTube/practimac](https://www.youtube.com/practimac)

BIBLIOTECA QUADRATA 80CM P00220BI-RO

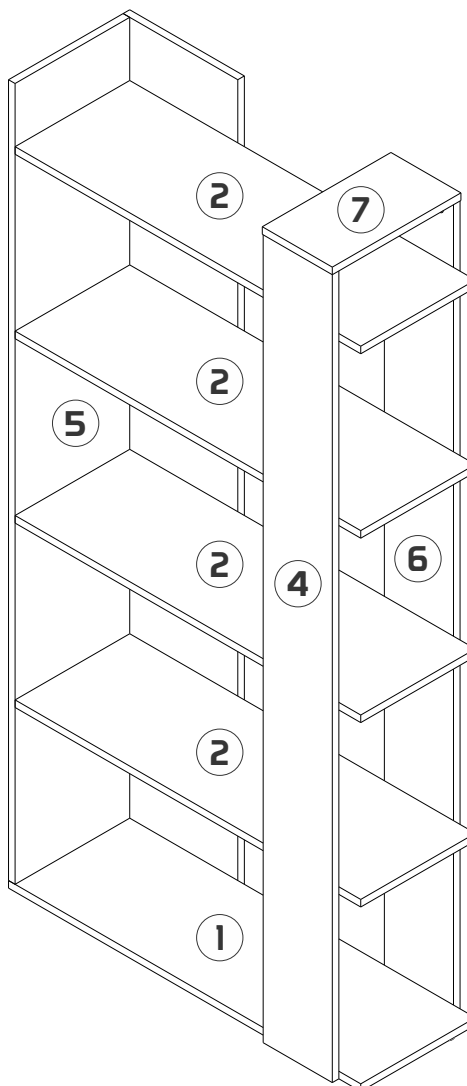
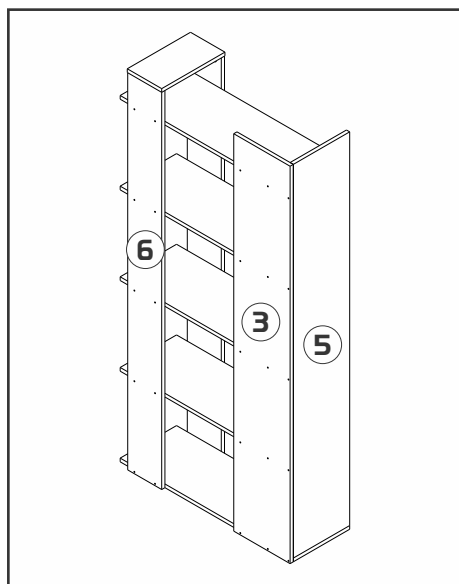

HERRAJES

A

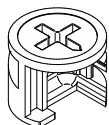

22 Und.
Tuerca minifix
0002715

B

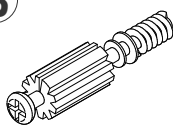

22 Und.
Perno minifix
0002715

C

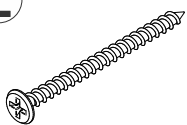

27 Und.
Tornillo 6x2 ave phi
autoperforante
0000152

D

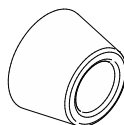

6 Und.
Pata para mueble
30x20
20080015

E

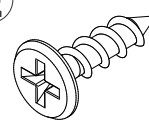

6 Und.
Tornillo 6x5/8 ave phi
zinc aglomerado
0004705

 **Practimac**
tu espacio, tu vida.

RECOMENDACIONES DE ENSAMBLE

Minifix

