

01.62.011

INSTRUCCIONES DE MONTAJE
NUMERACIÓN EN EL TOPE DE LA PIEZA

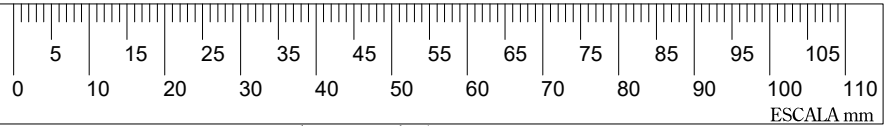
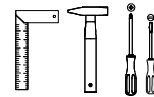
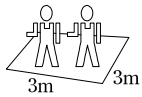

Regla para Medir Accesorios

ESCALA mm

		CANTIDAD
A	PEGAMENTO	1
B	6mm x 30mm	40
C	4mm x 45mm	24
D	4mm x 45mm	8
E	3,5mm x 30mm	4
F	3,5mm x 25mm	16
G	4mm x 20mm	4
H	3,5mm x 12mm	110
I	12 x 12	16
J	10 x 10	80
K		2
L		20
M		32
N		5
O		4
P	M4	4
Q	M4 X 20MM	4
R		16
S		16
T1	Izquierdo/Esquerdo	2
T2	Izquierdo/Esquerdo	2
U1	Derecho/Direito	2
U2	Derecho/Direito	2
V		8
W		2
X	Kit Seguridad Kit Segurança	1
Y		8
Z	977mm	1
A1	485mm	1

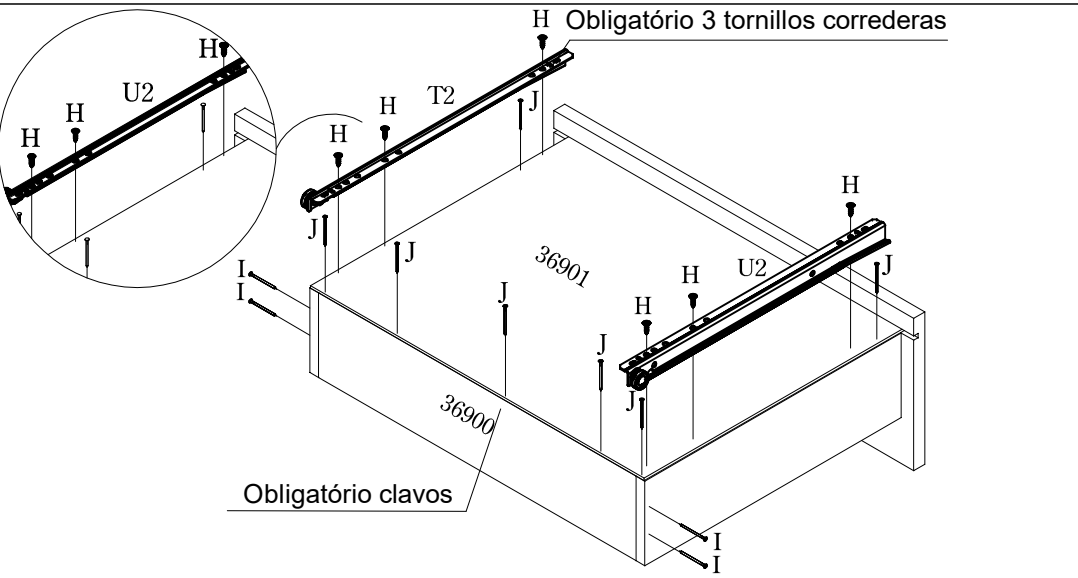
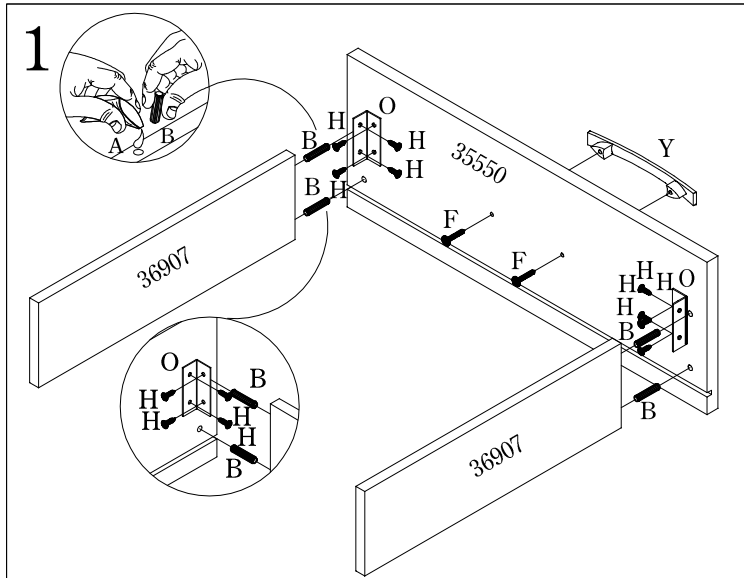
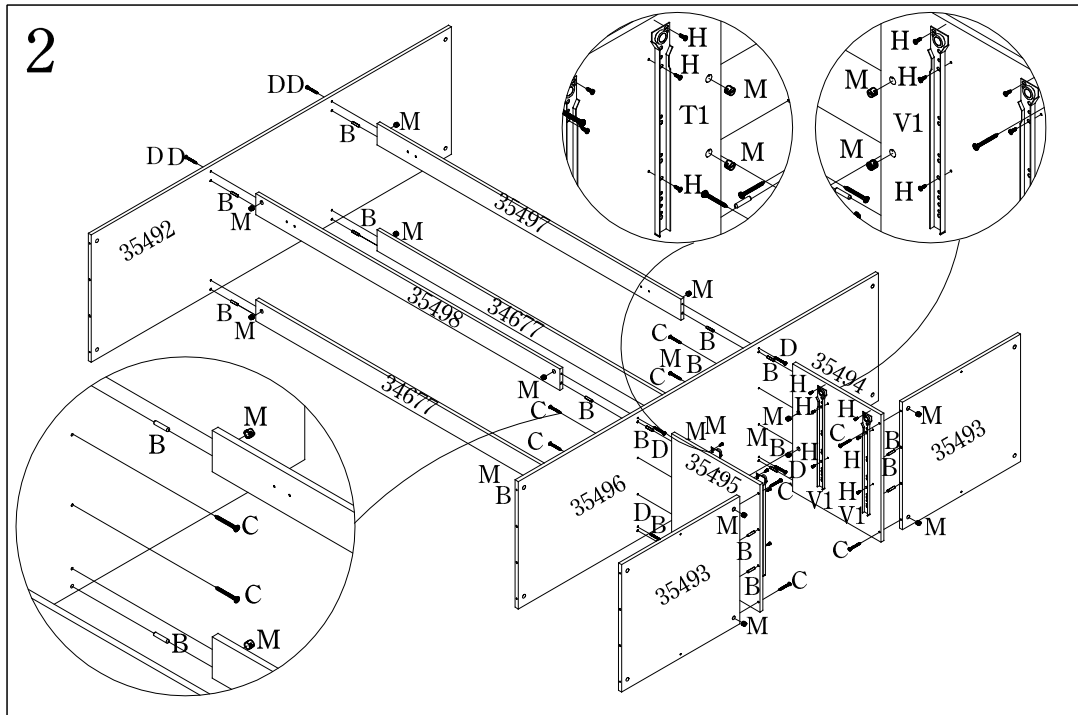
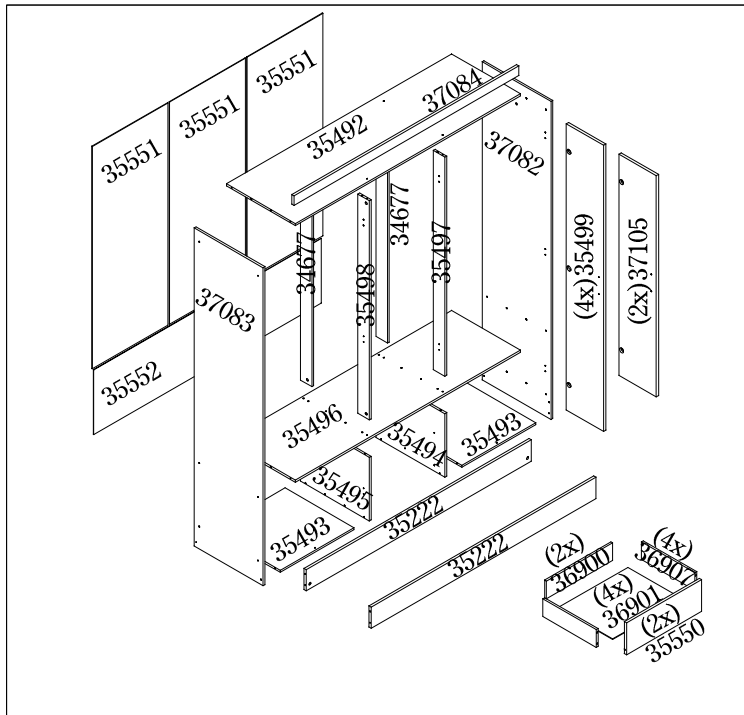

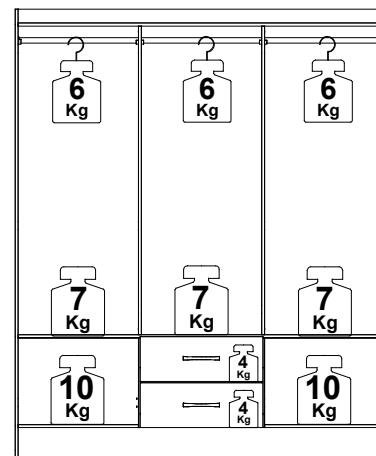
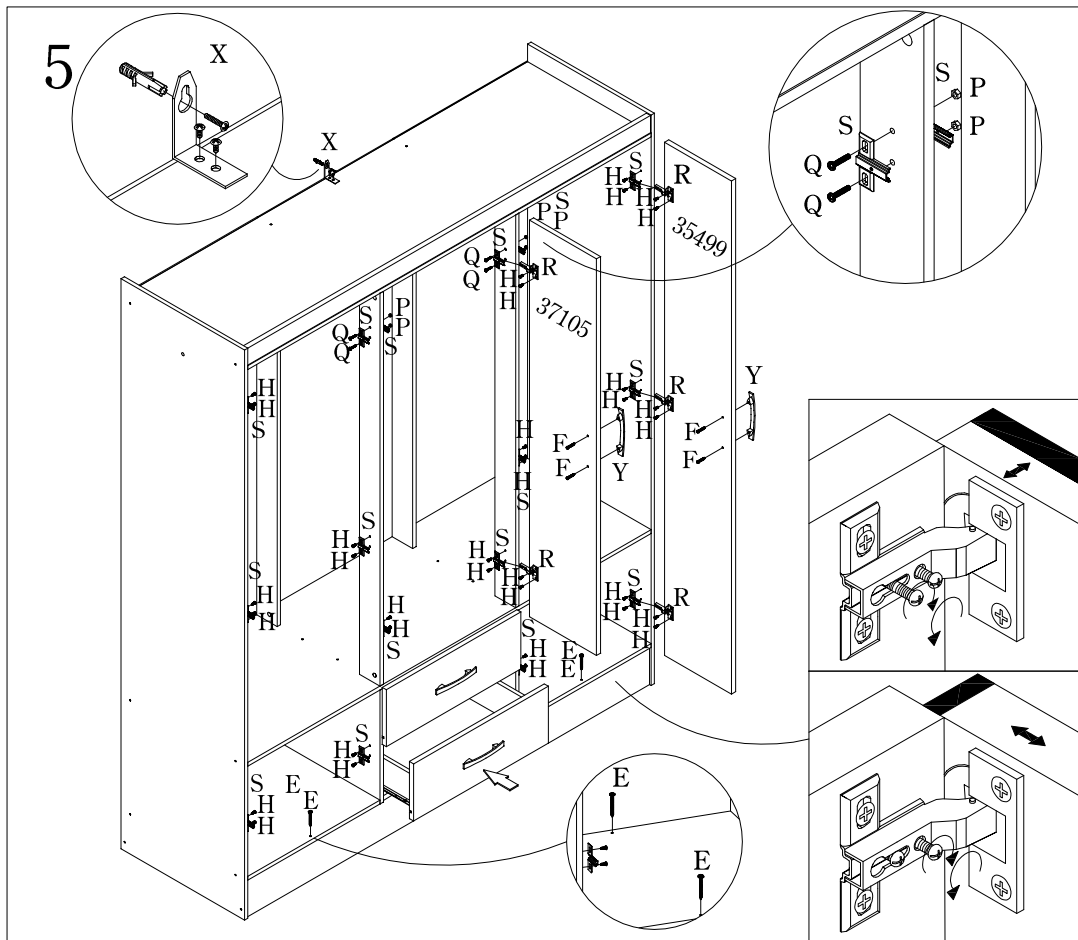
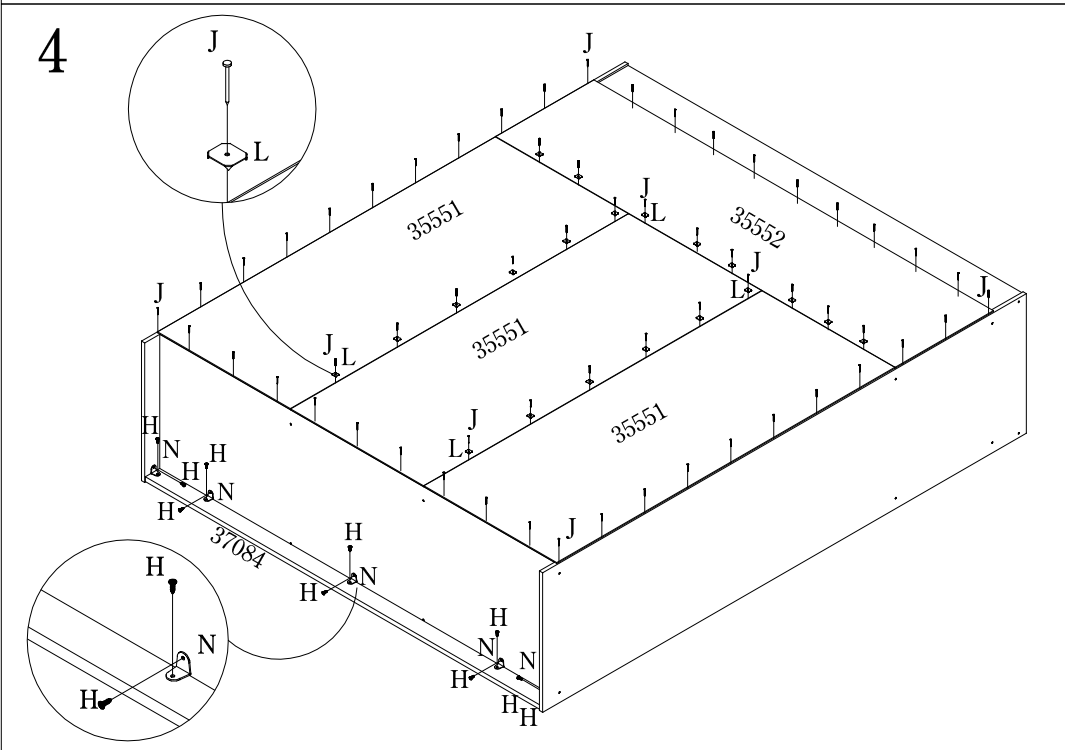
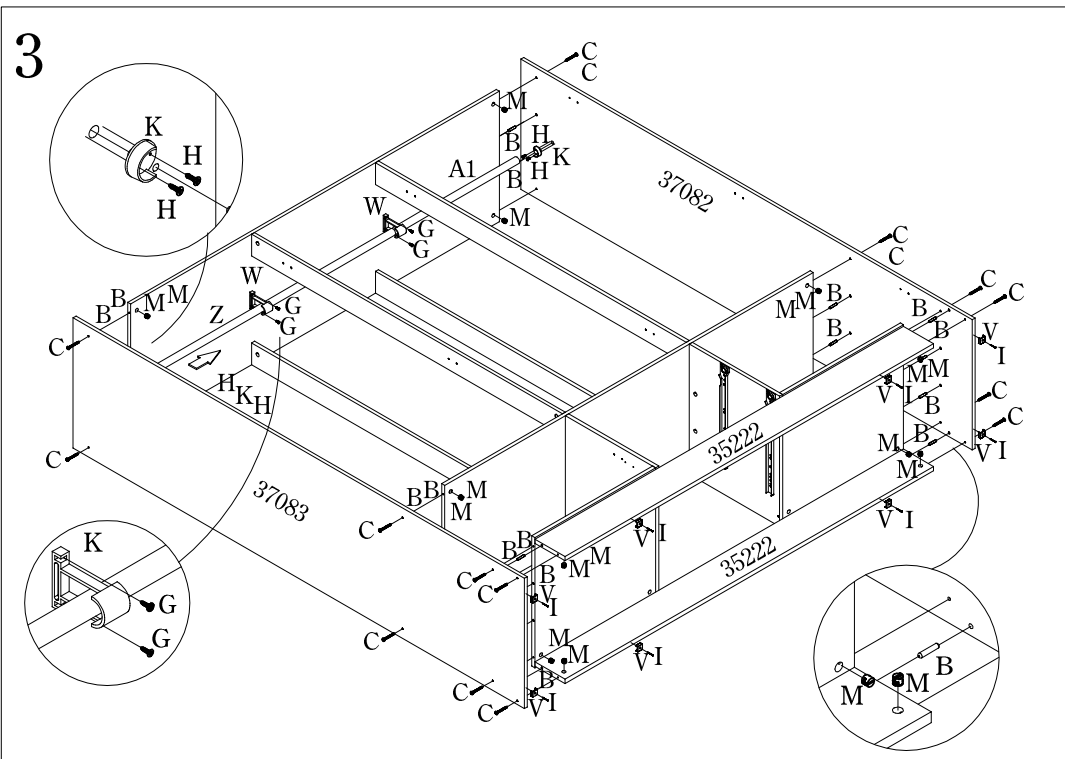

Peso por estante/repisa/barra de colgar/cajón

Por favor, atención a los pesos máximos admitidos por cada compartimiento del producto. Tenga cuidado de NO exceder estos pesos, con el fin de garantizar la calidad y durabilidad del producto. Es importante recordar que los pesos muestran en caso de ser distribuida en toda el área de la plataforma.