



THE COMPLETE
BINOCULAR
HANDBOOK

FINDING THE PERFECT BINOCULAR FOR YOUR NEEDS

The old adage “the better you understand something—the more you’ll appreciate it” is especially true with optics. Nikon’s goal in producing this guide is to not only help you understand optics, but also the difference a quality optic can make in your appreciation and intensity of every rare, special and daily viewing experience.



Exacting precision across a full spectrum of optical technologies.

Widely acknowledged as the global leader in precision optics, Nikon’s roots go back to the development of our first binoculars in 1917. Since then, Nikon has continued to build on the know-how of generations of optical and precision technology experts with an enduring passion for quality and innovation. Day in and day out, our products are tested in the world’s most demanding environments. Using Nikon cameras and NIKKOR lenses, photographers around the globe capture moments that no one could otherwise envision.

While Nikon engineers of semiconductor-manufacturing equipment employ our optics to create the world’s most precise instrumentation. For Nikon, delivering a peerless vision is second nature, strengthened over the decades through constant application. At Nikon Sport Optics, our mission is not just to meet your demands, but to exceed your expectations.

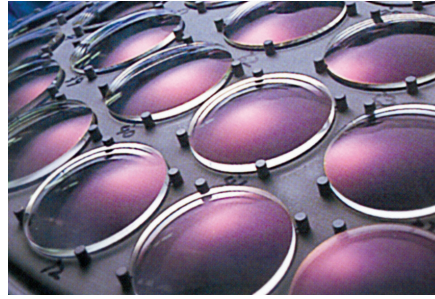

CONTENTS

4 BINOCULAR OPTICS 101

5 THE DESIGN

PORRO PRISM BINOCULARS
ROOF PRISM BINOCULARS

6-11 THE NUMBERS COUNT

EYE RELIEF/EYECUP USAGE
EXIT PUPIL
REAL FIELD OF VIEW
APPARENT FIELD OF VIEW
FIELD OF VIEW AT 1000 METERS
FIELD FLATTENING (SUPER-WIDE)
Nikon’s WX BINOCULAR
LIGHT DELIVERY
RESOLUTION
INTERPUPILLARY DISTANCE
DIOPTER ADJUSTMENT
FOCUSING MECHANISMS
INTERNAL ANTIREFLECTION

ZOOM BINOCULARS
WHAT “WATERPROOF” REALLY MEANS
THE RELATIONSHIP BETWEEN POWER,
EYE RELIEF, AND FIELD OF VIEW

12-14 WHERE QUALITY AND QUANTITY COUNT

LENS COATINGS
ABERRATIONS
ED GLASS AND SECONDARY SPECTRUMS

15-17 HOW TO CHOOSE

SELECTING A BINOCULAR BASED
UPON INTENDED APPLICATION

18-19 BINOCULAR OPTICS GLOSSARY

OPTICS FIRST SINCE 1917

The guiding principle behind every Nikon product has always been to engineer it from the inside out. By creating an optical system specific to the function of each product, Nikon can better match the product attributes specifically to the needs of the user. The result is what we call our “Optics First Design Principle,” and it applies to every optic Nikon makes.

As one of the few makers of optical glass in the world, Nikon has a unique advantage of having the knowledge and experience to specify and select the exact type of glass, lens geometry and multicoatings needed to optimize the performance of any given optic. This level of performance can be seen and appreciated when putting any Nikon optic to the test in real world conditions.



BINOCULAR OPTICS 101

What do the basic numbers mean?

Performance factors

Nikon offers an extensive lineup of binoculars, including several of the world's most popular series for a diverse range of applications. Each model features various technical specifications that can help you in making the right selection.

Magnification is usually considered most important, but field of view, brightness, ease of handling (weight, feel, ergonomics), suitability for eyeglass wearers and overall construction should also be taken into account.

Magnification

Magnification, represented by a numerical value, is the relationship between a subject's actual proportions and its magnified size. This is the first number printed on all Nikon binoculars. With 7x magnification, for example, a subject 700 yards distant appears as it would when viewed from 100 yards with the naked eye. As a rule, magnifications of 6x to 10x are recommended for handheld outdoor use. With magnification of 12x or greater, any shaking by hand movement is more likely to create an unstable image and uncomfortable viewing.



Objective lens diameter

The objective lens diameter (the second number after magnification), combined with the quality of lens and prism coatings, determines the amount of light gathered to form an image. If you are regularly observing in poor light conditions, such as early dawn or dusk, or in forested areas, you may need a larger objective lens. But large-diameter objective lenses make binoculars heavier, so 50mm is the general limit for handheld use.



Field of view

The real angle of view, is the third number printed on all Nikon binoculars. It represents the segment of a 360° circle that the binocular is designed to view. The higher this number, the more of the subject you see from side to side.

This number is also used to determine if the binocular can be rated as a wide-angle or wide field-of-view instrument.

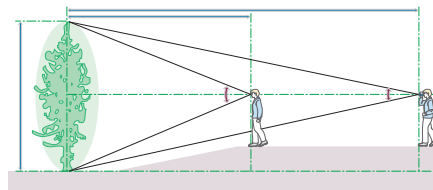

THE DESIGN:

What difference does it make?

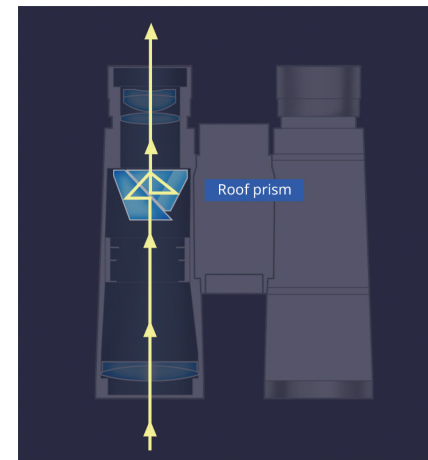
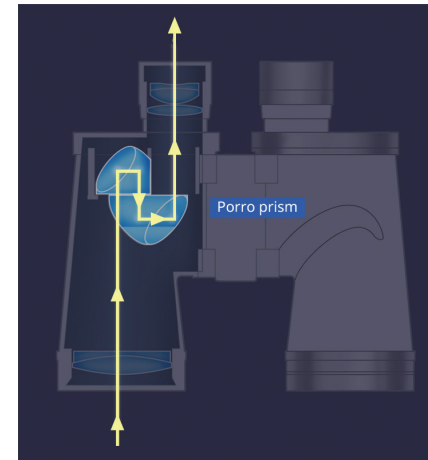

PRISMS

Binoculars come in two prism designs: "Roof prism" and "Porro prism." The purpose of prisms, located in each binocular barrel, is to correct the inverted and reversed images you would see in their absence.

Porro Prism Binoculars

Porro prism binoculars are named after their prism's inventor, an Italian named Ignazio Porro, and feature "dogleg" or "zigzag" barrels, with the objective lenses (front) offset from the ocular (rear) lenses.

Advantages:

- Porro prisms inherently provide a better depth of field/better stereoscopic 3D images because of the wider objective lens spacing.
- Porro prism binoculars are generally less expensive, all other factors considered, as they are less technical to manufacture to high performance levels.
- Porro prisms offer a bright view from total reflection.

Disadvantages:

- Because of the dogleg barrels, Porro prism binoculars are generally bulkier, and therefore less convenient to pack and carry.

Roof Prism Binoculars

The Roof Prism design has a straight barrel, but not a straight light path, from the Objective lens (front) to the Ocular lens (back).

The prisms inside each barrel resemble a tiny, peaked roof – hence the name.

Roof prism binoculars, chosen by those who prefer a slim-line design, are costly to produce because their very small prisms require special grinding and polishing to maintain image integrity.

Roof prisms also demand a relatively expensive coating process, much like lens coatings, to maximize their performance.

Phase-correction coating:

Phase shift of light is caused by phase differences arising from total light reflection on a roof (Dach) surface. Called phase-correction coating, it corrects most of the optical deficiencies inherent in roof prisms. Phase-correction coating is applied to the surface to minimize loss of resolution, ensuring high-contrast images.

Advantages:

- The biggest advantage of the Roof prism design is smaller size and portability. Because Roof prism binoculars have straight barrels, they can be more compact and thin.

Disadvantages:

- They are more costly than Porro prisms.

THE NUMBERS COUNT:

What do the Advanced Numbers and Specifications tell me?

Eye Relief/Eyecup Usage

Eye relief is the distance from the outer surface of the eyepiece lens to the position where the exit pupil is formed (eyepoint).

Looking through binoculars from the eyepoint, you can obtain the whole field of view without vignetting.

It is recommended for eyeglass wearers to use binoculars with a longer eye relief (high eyepoint).

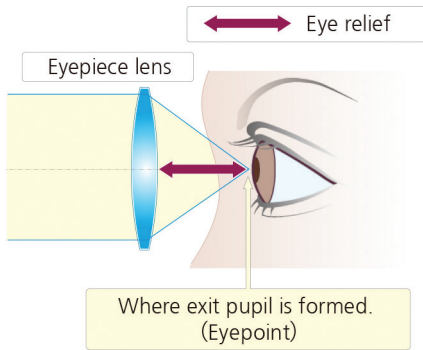

Exit Pupil

The exit pupil is the bright circle that can be seen in the center of each eyepiece when you hold the binoculars about 12 inches away from your eyes with the objective lenses pointed toward a bright light. The larger the diameter is, the brighter the viewfield is, which is an important consideration when using binoculars in dark situations and for astronomical observation.

Exit pupil = The effective diameter of the objective lens ÷ Magnification

- With 8x42 binoculars, the formula is $42 \div 8 = 5.3$. Therefore, the diameter of the exit pupil is 5.3mm. This figure (above right) indicates the brightness of the image in view.



The relationship between the dilation and contraction of your eyes (pupil size) and the size of the Exit Pupil determines light delivery potentials.

- Smaller exit pupils affect brightness enormously, because the pupil of the human eye controls the amount of light entering our eye, by shrinking when light is brighter, or growing when light dims.

The human eye pupil diameter ranges from about 2mm in bright light, to a maximum of about 7mm in total darkness.

- For our optics-aided eyeball to take advantage of available light, the exit pupil in a binocular should be at least the size of our own eye's pupil in any given situation. If smaller, your eye will be "light starved" (not enough light reaches your eye). This normally happens at dawn and dusk.

Of course, during daylight hours, or in a well-illuminated venue (stadium, arena or concert hall), your pupil can contract to be as small as 2mm or 3mm. In these usages, a 3mm exit pupil is sufficient and allows the use of a smaller, more portable binocular.

Real Field of View

Real field of view is the angle of the visible field, seen without moving the binoculars, measured from the central point of the objective lens. The larger the value is, the wider the viewfield available. For example, binoculars with a wider field of view are advantageous for locating fast-moving wild birds within the viewfield. This also applies for finding small nebulas or a cluster of stars in astronomical observations.

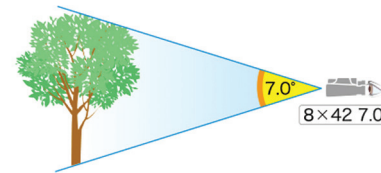
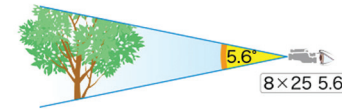

Apparent Field of View

Apparent field of view is the angle of the magnified field when you look through binoculars.

The larger the apparent field of view is, the wider the field of view you can see even at high magnifications.

With the conventional method used previously, the apparent field of view was calculated by multiplying the real field of view by the binocular magnification. (With this formula, apparent field of view wider than 65° is called wide field of view.)

After revision, Nikon's figures are now based on the ISO 14132-1:2002 standard.

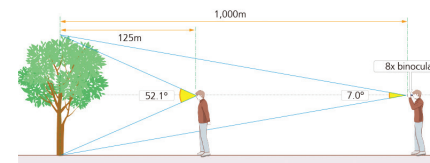

Field of View at 1000 Meters

Field of view at 1,000 meters is the width of the visible area at a distance of 1,000 meters, which can be seen without moving the binoculars.

For example, with 8x42 7.0° binoculars:

$$\text{Field of view at 1,000m} = 2 \times 1000\text{m} \tan(7.0 \div 2) = 122\text{m}$$

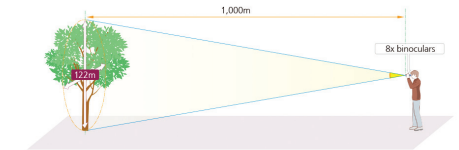

Field Flattening

Nikon's field-flattener lens system technology minimizes curvature of field — aberrations that occur when focusing on the center of the field of view causing the periphery to go out of focus and vice versa — and delivers sharper, clearer images all the way to the lens periphery.



Field Flattener Lens System

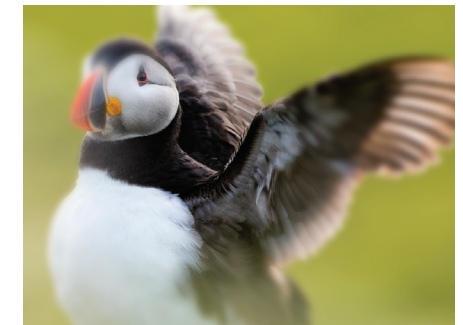

Without Field Flattener Lens System

Nikon's WX BINOCULAR

In 2017, Nikon "raised the critical eyes of optics aficionados to a level thought unachievable," through the introduction of a very special binocular, called the WX, available in both 7x and 10x versions.

- These binoculars represented a "technology statement" by Nikon about what can be achieved by pushing the boundaries of design and technology, as only Nikon could achieve.
- The WX binoculars featured an unheard of apparent field of view of 66.6° for the WX 7x50 IF, and 76.4° for the WX 10x50 IF!
- While releasing a super-wide field of view, it assures a sharp and clear image across the entire field of view.



Nikon's WX BINOCULAR

Light Delivery, including Relative Brightness (RB) and Twilight Factor (TWF)

The ability of a binocular to deliver light often dictates its usefulness.

Relative Brightness (RB), and Twilight Factor (TWF) are two important measurements of light delivery.

- They are a function of available light, combined with magnification/power ratings and objective lens sizes and the resultant exit pupil sizes.

Use the following formulas to calculate these factors:

- RB (relative brightness) = EP^2 (Exit Pupil size, in millimeters, multiplied by itself)

In our example: the EP is 42 divided by 8 = 5.25. $5.25 \times 5.25 = 27.56$ for RB.

- TWF (Twilight Factor) = the square root of the result obtained by multiplying the power rating by the size (in millimeters) of the objective lens.

In our example the square root of $8 \times 42 = 18.33$ for TWF.



Relative Brightness

The Relative Brightness index is useful to compare the actual brightness potential differences between different binocular models or powers, taking into account the surface area of the exit pupil, not just the diameter.

Twilight Factor, however, could be a more meaningful criterion in your selection process for low-light usage.

- Twilight Factor measures imaging capability under severely low-light and very low-contrast conditions, similar to those often experienced in observation at dawn and dusk.
- Based on a different relationship between objective lens size and magnification power, Twilight Factor offers a different perspective from the relative brightness index, which is used primarily for normal daylight conditions.
- Twilight Factor takes into account that a higher power will provide you with much greater detail image identification in low light situations (while of course maintaining the brightness enhancement of a 5mm exit pupil or more).

COMPARISON CHART OF RB'S AND TWF'S

	EXIT PUPIL	RELATIVE BRIGHTNESS	TWILIGHT FACTOR
			
8 x 25	3.1	9.6	14.1
7 x 35	5.0	25.0	15.7
10 x 42	4.2	17.6	20.5
10 x 50	5.0	25.0	22.4
7 x 50	7.1	50.4	18.7

The chart above provides a quick and easy reference for selecting the appropriate binocular based only on light delivery potential. These numbers will tell you which sample model is appropriate for specific uses and lighting conditions.

Remember, this is a quantitative—not qualitative—guide.

- Relative Brightness and Twilight Factor do not take into consideration glass or prism quality, lens coatings, optical designs, etc. There are many other features and characteristics that affect the transfer of light and image from the front of the binocular to the back of the binocular.

- Obviously, if these numbers were the final word, all brands of 7x35's or 8x40's and other binoculars would be equal, and this is certainly not true.
- Once you have determined the desired quantitative specs that meet your needs, the important qualitative issues of sharpness, light transmission and precision separate Nikon from other brands.

Resolution

The ability to separately perceive two objects (dots or lines) set close to each other is called resolution and usually it is measured by angular separation of the two objects.

The larger the objective diameter, the better the resolving power.

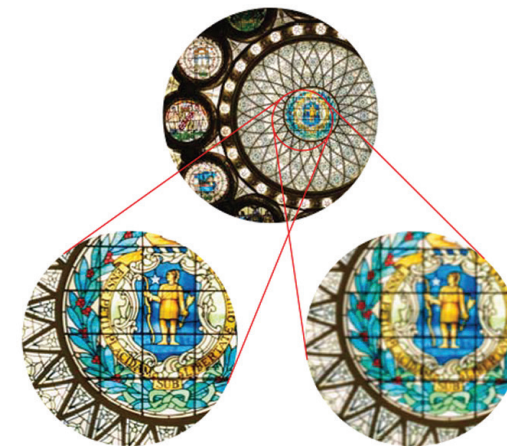

Larger Objective

vs.

Smaller Objective

Interpupillary Distance

Interpupillary Distance is the distance between the pupils of your eyes. Everyone's is different. All binoculars have a hinge to allow the binocular to be adjusted to match each user's needs.

The hinge point of the binocular should be "bent" until you see a single image when looking into both barrels of the binocular (the black edges disappear).

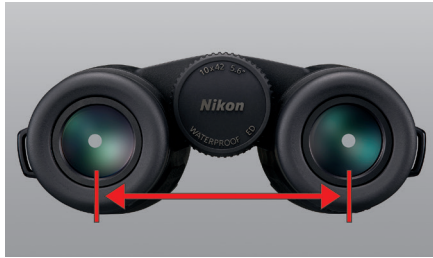

INTERPUPILLARY DISTANCE

Diopter Adjustment and Focusing Mechanisms

You are certainly aware that visual perception among individuals varies greatly. What you may not know is that virtually everyone has a strong eye and a weak eye. Sometimes this difference is negligible; sometimes quite significant. The diopter control, present in most binoculars, compensates for this dilemma.

- To set the binocular specifically for your eyes, first bend the barrels up and down until the two images merge into one (Interpupillary distance). Set the diopter at zero. Then, keeping both eyes open, cover the objective lens on the barrel with the diopter control, and adjust the central focusing knob until the image is sharp. You now know that the central focus knob (which moves lenses in both barrels simultaneously) produces a sharp focus for the uncovered eye at that particular distance.



DIOPTER CONTROL

- Now, still keeping both eyes open, move the cover on the objective lens to the barrel without the diopter (do not change your distance from the subject). If your eyes were visually equal, the subject should be sharp with this other eye since the diopter is set at zero. If not, turning the diopter control, which only moves the lenses in its tube, will change the lens positions until they match the sharp focus attained by the central focus knob for the other eye.
- Once done, as long as the diopter control is in this established position, and your eye prescription does not change, the central focus knob will always give you a quick, sharp, strain-free view. Note: this process should be done even with eyeglasses as one does not know if your corrective lenses are still effective.

Focusing Mechanisms

Central Focus

A Central Focus Design has one knob that focuses both barrels of the binocular at the same time. Most modern binoculars are of this design.

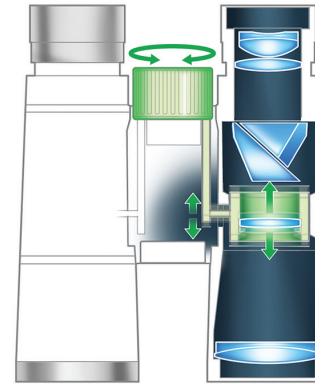

Individual Focus

Some specialty binoculars have individual focus rings for each barrel, instead of a single central focus knob. These rings/controls are generally on the eyepieces of each barrel, resulting in a slower process to change focus as the subject moves or changes.

Individual focus binoculars do not have diopter adjustments.

The individual focus design provides for easier waterproofing, however the unique design of a binocular with specific or advanced technologies may also dictate an individual focus design.

Internal Antireflection

Internal antireflection of a binocular is essential. Blackening of interior metal surfaces reduces reflections and enhances glare reduction. If light bounces around inside the lens barrel, reduced image quality and annoying glare will result.

Zoom Binoculars

Zoom binoculars appear to be a great value, but they are less bright than comparable fixed power binoculars.

What "Waterproof" Really Means

There is a vast difference between "fogproof," "waterproof," "rainproof" and "water resistant" designations.

- Waterproof means it has a structure that will not be affected if submerged in water to a maximum depth of 1m or 5m/16.4 or 3.3 ft during some period of time. (Under Nikon's testing conditions. Not designed for underwater usage.)
- Rainproof and water resistant usually means exposure to a brief sprinkling is tolerable.
- Fogproof means the instrument has been purged of virtually all moisture, air and gaseous water molecules while in a special chamber in an almost-perfect vacuum state. Then the instrument is filled with nitrogen gas and sealed securely with O-rings. It has effect of preventing fog and mold.

A common mistake is to assume that binoculars encased in rubber are waterproof.

- Rubber casing alone can never provide waterproof integrity and also is not required for waterproofing.

The Relationship Between Power, Eye Relief (ER), and Field of View (FOV)

To maintain resolution integrity, it is helpful to understand this optical axiom.

- Increase power, ER+FOV are both reduced.
- Increase ER, FOV decreases and vice versa.
- Increase ER+FOV, power is lower.
- Only the costly increase in density and number of eyepiece lenses would allow a wider latitude in these relationships, in order to maintain acceptable resolution.

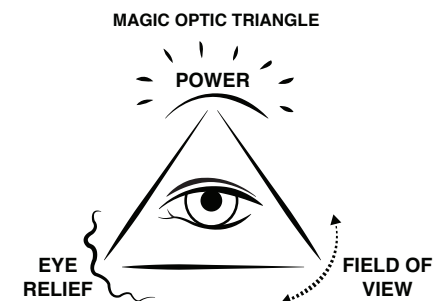

WHERE QUALITY AND QUANTITY COUNT

Not all Glass Coatings are created the same.

Lens Coatings

Part of the light that passes through the lens is reflected by the front (incident light) and rear (exiting light) surfaces. This reduces the amount of light passing through the lens, so the image appears to be dark. Also, the reflected light may cause ghosting and flare, affecting image contrast. To minimize reflection on the lens surfaces and ensure clear, sharp images, anti-reflective coating is applied.

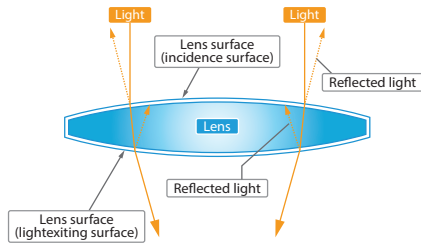

Coating is applied to both surfaces of the lens. There are two main types of coating: a single layer and multilayer (usually 3-5 layers). A multilayer coating effectively reduces reflected light that cannot be eliminated with a single-layer coating, and increases the transmittance of light.

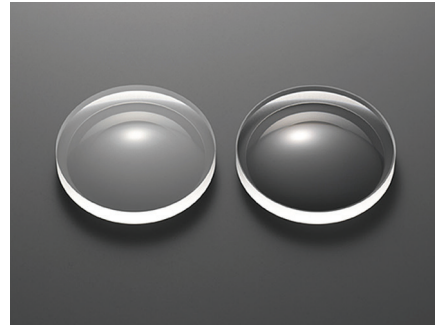

- Comparing binocular performance in very dim light conditions will separate the best from the rest. Nikon quality emerges spectacularly in this type of comparison.

	Per single lens surface	10 lens and prism surfaces
No coating	96%	$(0.96)^{10} = 0.66$ 66%
Single-layer coating	98.5%	$(0.985)^{10} = 0.86$ 86%
Multilayer coating	99.5%	$(0.995)^{10} = 0.95$ 95%

Transmittance by type of coating

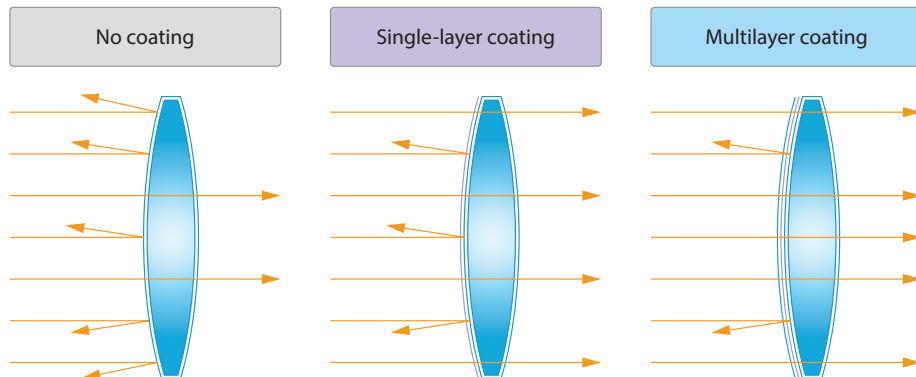

Aberrations

Nikon's binoculars have received high evaluation because of their excellent optical system. Nikon knows that a bright image and sharp details are the priority of binoculars, and makes utmost efforts to achieve this. Correcting lens aberration is vitally important.

Nikon's binoculars are designed to correct the aberration described below properly to realize the brightest and sharpest image.

- Spherical Aberration

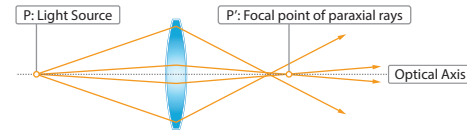

A bundle of light rays coming from one point on the optical axis is focused at a different place than the focused point depending on the distance from the optical axis when the light incidents. This deviation is caused by variations in angles of each incident light ray, and is called spherical aberration.



- Coma

Coma is caused by the difference in distance of the incident light from the optical axis. While spherical aberration is caused by a difference in focused point, coma is caused by a difference in magnification. Coma strongly influences image quality in the periphery of the field.

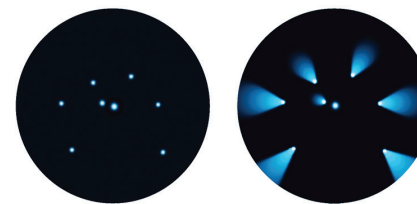

- Astigmatism

When a lattice-patterned object is viewed using a lens with an astigmatism, horizontal stripes appear in focus and vertical stripes appear out of focus. Conversely, when horizontal stripes appear out of focus, vertical stripes are in focus. Since astigmatism increases in proportion to the incident angle squared, astigmatism greatly influences image quality at the peripheral area of binoculars with a wide field of view.

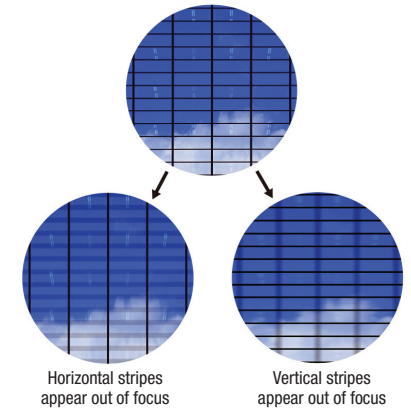

- Curvature of Field

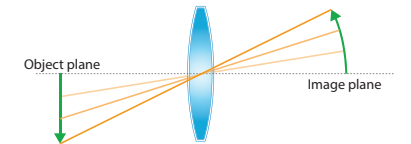

In the case of a lens fully compensated for coma aberration and astigmatism, the light rays coming from a point apart from the optical axis are focused at one point. But this point is not always included in the vertical plane to the optical axis. This is called Curvature of Field. With a lens having this aberration, even if you focus around the center of the field, the periphery of the field appears out of focus. It can cause very bad effects especially on wide-field-type binoculars.





Original Shape

Positive Distortion
(pincushion type)

Negative Distortion
(barrel type)

• Distortion

Distortion is caused by variations in the magnification of the image depending on the distance from the optical axis. There are two types of distortion: positive and negative. This image distortion, irrespective of image visibility, increases in proportion to the incident angle cubed.

• Chromatic Aberration



This is caused by a difference in light wavelength. The focal point or magnification of a lens varies according to the wavelength of each type of incident light. Therefore, if you look at an image

through a lens with chromatic aberration, color fringing may occur. Because a single lens cannot compensate for chromatic aberration, two lenses of different optical characteristics are combined to correct this aberration. Nikon's original ED (Extra-low-Dispersion) glass lenses effectively compensate for color fringing.

ED glass and secondary spectrum

Visible light is composed of lights of various wavelengths. Gathering up all of these lights to a point is ideal for objective lenses because light with other wavelengths such as green has different focal lengths, residual chromatic aberration results. This residual chromatic aberration is known as secondary spectrum. ED (Extra-low Dispersion) glass has a unique characteristic of dispersion and when combined with other glasses minimizes the effects of the secondary spectrum. Compared to achromatic lenses, ED glass reduces chromatic aberration to a remarkable degree.

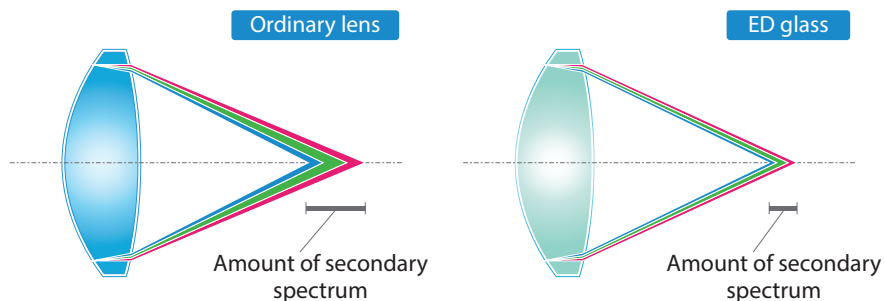

HOW TO CHOOSE BINOCULARS

Some useful hints when choosing binoculars for the first time.

Recommended magnification is up to 12x.

- Higher magnification does not necessarily mean better images. Magnifications between 6x to 10x are recommended for handheld outdoor use. With magnifications of 12x or higher, shaking caused by hand movement is more likely to occur and result in an unstable image and uncomfortable viewing. Generally, the higher the magnification, the narrower the real field of view.



8x

12x

Binoculars with a wide field of view are recommended for viewing a broad area.

- The wider the field of view, the easier it is to locate an object. If the magnifications are identical, the larger the value of real field of view, the wider the field of view.

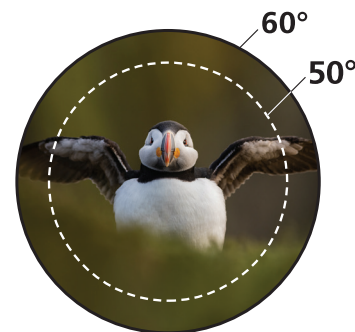

15mm or longer eye relief binoculars are recommended for eyeglass wearers.

- High-eyepoint binoculars with eye relief of 15mm or longer are recommended for eyeglass wearers. Choose binoculars with eye relief of at least 10mm.



Waterproofing structure for worry-free observation.

- Choosing binoculars featuring waterproofing is recommended so there is no need to worry about them if there is a sudden shower or spray of water.



SELECTING A BINOCULAR BASED UPON INTENDED APPLICATION

Bird Watching/Nature Watching

Right magnification for the location

- We recommend magnification of 8x to 10x for woods and forests, 8x to 12x for lakes, marshes and tidelands.

Large effective diameter of the objective lens

- The larger the effective diameter of the objective lens, the brighter the image and the higher the resolution are obtained. However, we recommend the use of a tripod for binoculars over 50mm to reduce unstable images and uncomfortable viewing due to hand movement.

Wide field of view

- Allows you to view a wider area all at once, making it easier to follow the movements of birds.

High lens performance

- For more pleasant viewing, choose binoculars that produce a sharp image and minimized distortion all the way to the lens periphery.

Binoculars that fit your hands

- Hold the binoculars in your hands, look through the lenses and choose the best fit.

Waterproof

- There is no need to worry about your binoculars when there is sudden rainfall or when you use them in morning dew.

Outdoor Recreation

- Large exit pupil, ruggedness, water proofing.
- Generally higher powers are preferred (10x) for detail reproduction and Twilight Factor.

Outdoors/Hiking/Backpacking/Camping

- Rugged outdoor activities demand portability and durability. Compacts, both Porro Prism and

Roof Prism, fit this usage.

- Models that also feature rubber armor coating and waterproofing are ideal when you're up against the elements. For early morning and evening use, binoculars with a large objective diameter and full Multicoating are recommended.

Travel, Including Cruise Ships

Right magnification for the situation

- If outdoor nature watching is what you're after, we recommend magnification of 8x to 10x.
- For viewing the scenery or distant buildings, we recommend magnification of 4x to 8x.
- Zoom binoculars come in handy if you want to see objects both near and far.

Compact, lightweight and easy-to-carry binoculars for traveling

- For easy portability, we recommend compact, lightweight binoculars that can be easily stuffed into bags or pockets when you are on the move and quickly pulled out when you want to use them.

Waterproof for outdoor use

- There is no need to worry about your binoculars when there is a spray of water or sudden rainfall.

Easy-to-use binoculars that fit your hands

- Binoculars with a rubber-coated grip won't slip so easily, helping you to use them more smoothly.
- Before making a purchase, be sure to try holding the binoculars in your hands and choose what is easiest for you to use.

Sporting Events

Right magnification for the situation

- For outdoor spectator sports, we recommend magnification of 8x to 12x. For indoor spectator sports, it's best to have magnification of 4x to 8x, or magnification of 8x to 10x for larger arenas.

Wide field of view for fast-moving action

- For spectator sports that involve rapid motion, we recommend wide field-of-view binoculars that allow you to view a wider area all at once.
- Binoculars with high optical performance allow you to see even facial expressions clearly.

Waterproof for outdoor use

- There is no need to worry about your binoculars when there is sudden rainfall.

Compact, lightweight and easy-to-carry binoculars

- It's handy to have compact, lightweight binoculars that can be easily stuffed into bags or pockets when you are on the move and quickly pulled out when you want to use them. With lightweight binoculars, you can minimize the strain on your arms when using them for extended periods.

Easy-to-use binoculars that fit your hands

- Before making a purchase, we recommend that you be sure to hold the binoculars in your hands and try them out. Choose what is easiest for you to use, the best binoculars are those that fit you and that you can use quickly and easily .

Concerts/Theater

Right magnification for the situation

- For outdoor concerts, we recommend magnification of 7x to 10x. For concert halls, we recommend magnification of 4x to 8x. If you want to enjoy everything from the entire stage to the artists' facial expressions, zoom binoculars are a great choice.

- For the theater, we recommend compact, lightweight binoculars with magnification of 4x to 8x.

Wide field of view for fast-moving action

- For concerts, we recommend wide field-of-view binoculars to see a wider area all at once.

Bright view for night concerts

- Night performances and concerts are fairly dark, so we recommend binoculars with a larger exit pupil that offer a bright view.
- Binoculars with high optical performance allow you to see even facial expressions clearly.

Compact, lightweight and easy-to-carry binoculars

- It's handy to have compact, lightweight binoculars that can be easily stored in bags or pockets.

With lightweight binoculars, you can minimize the strain on your arms when using them for extended periods.

Easy-to-use binoculars that fit your hands

- Before making a purchase, we recommend that you hold the binoculars in your hands and try them out. Choose what is easiest for you to use. The best binoculars are those that fit you and that you can use quickly and easily.

Museums

- For museums, choose compact lightweight models with a low magnification and a close focusing distance of less than 2 meters/6 feet.

Boating/Fishing and Navigation

- Waterproofing and durability are essential for these activities. Generally speaking, a large Exit Pupil is also a requirement, even during daylight operation. This is because the movement of the boat can change the alignment of the user's pupil to the image being formed by the binocular. Having a large image (Exit Pupil) allows for some movement with less shading/loss of brightness.

Astronomy/Star Gazing

- For astronomical observation, a bright optical system with a large objective diameter and exit pupil has generally been recommended. This is to gather and deliver more light to the eye.
- Nikon recommends a high magnification to some extent, if you see stars in an urban area where the sky is quite bright because of light pollution, you are looking at pinpoints of light, which will be naturally bright. Gathering too much light will cause the dark sky to appear grey, reducing the contrast between the subject and the background. However, in a dark sky, a larger exit pupil is recommended.
- Tripod mountable, for both high-power stabilization and extended viewing, is also important, as is ED Glass to control the color fringing around bright objects.

BINOCULAR OPTICS GLOSSARY

Anti-Reflective Coating

A coating applied to lenses to improve the brightness, color and contrast of the image. Quality, type and method of coating applied is of critical importance to brightness, clarity and contrast. Nikon coats all lens surfaces within the binocular/scope for maximum light transmission.

Apparent Field of View

Apparent field of view is the angle of the magnified field when you look through binoculars. The larger the apparent field of view is, the wider the field of view you can see even at high magnifications.

Apparent Angle of View

The segment of a 360° circle that appears to be in view, factoring in the magnification of the binocular or spotting scope. It is calculated by multiplying the magnification by the real angle of view. Binoculars with apparent angles of view greater than 60° are termed wide-angle instruments.

Aspherical Eyepiece Lens

A non-spherical shaped lens used to minimize aberration and maximize the flatness of field in certain binocular models.

Central Focus Control

A knob that simultaneously controls the focus in both barrels of the binocular.

Close Focus Distance

The closest distance to an object that the binocular will focus sharply.

Compact Binocular

Compact binoculars are small, lightweight and convenient, and they can be taken anywhere binoculars are needed.

Dach Prism

(See Roof Prism)

Dioptr Control

A separate diopter control allows you to compensate for the difference in eyesight between your right eye and left eye by offsetting the lenses in the two barrels so the image is sharp for each eye.

ED Glass

ED (Extra-low Dispersion) glass has this unique characteristic and when combined with other glasses minimizes the effects of the secondary spectrum. Compared to achromatic lenses, ED glass reduces chromatic aberration to a remarkable degree.

Exit Pupil

The exit pupil is the bright circle that can be seen in the center of each eyepiece when you hold the binoculars about 12 inches away from your eyes with the objective lenses pointed toward a bright light. The larger the diameter is, the brighter the viewfield is, which is an important consideration when using binoculars in dark situations and for astronomical observation.

Eyecup

The outer ring around the eyepiece that provides the proper eyepoint in relation to the exit pupil. Most Nikon binoculars have movable eyecups—either fold-back or turn-and-slide to allow the proper eye placement whether you're wearing glasses or not.

Eye Relief

Eye relief is the distance from the outer surface of the eyepiece lens to the position where the exit pupil is formed (eyepoint). Looking through binoculars from the eyepoint, you can obtain the whole field of view without vignetting.

Eyepiece Lens (Ocular)

This is the lens closest to the eye and magnifies the image formed by the objective lens. Various techniques have been integrated into the eyepiece to meet recently rising demand for binoculars with long eye relief and wide viewfield.

Field of View at 1,000 yards

The lateral measurement of the area that can be seen at 1000 yards. Calculated by multiplying the real angle of view by 52.4 feet, which is the linear measurement in feet that one degree represents at a thousand yards. (See also "Wide Field of View Binocular")

Flatness of Field

A measure of edge-to-edge sharpness. Lack of flatness of field results in image degradation, or the inability to focus sharply on both the center and edges of the image together.

Fogproof

The instrument has been purged of virtually all moisture, air and gaseous water molecules while in a special chamber in an almost-perfect vacuum state. Then the instrument is filled with nitrogen gas and sealed securely with O-rings. It prevents fogging and mold.

Full Multilayer Coating

Multilayer Coating is applied to transmission surfaces of all lenses and prisms to enhance light transmittance. Provides a brighter and sharper field of view.

Individual Focus Eyepiece

Individual Focus Eyepieces focus separately from one another. Primarily used for specialty binoculars or where extreme waterproofing is required. Removes the need to adjust focus for varying distances.

Interpupillary Distance Adjustment

Interpupillary distance varies among individuals, so adjust the distance of the eyepiece lenses according to your own interpupillary distance. Hold the binoculars with both hands. While looking at a distant object, carefully move the binocular tubes downward or upward until left and right fields are correctly aligned, forming a perfect circle. If the interpupillary distance has not been properly adjusted, the image might be uncomfortable to view.

Lens Distortion

Distortion is caused by variations in the magnification of the image depending on the distance from the optical axis. There are two types of distortion: positive and negative. This image distortion, irrespective of image visibility, increases in proportion to the incident angle cubed.

Light Transmission

All optical glass absorbs and reflects light. The degree of this light loss is the measure of the quality of the optics. Light transmission is an indicator of brightness. It varies depending on type of coating (no coating, single-layer coating or multilayer coating). See chart on page 12.

Long Eye Relief

High-eyepoint binoculars are those with eye relief of 15mm or longer. Eyeglass wearers can also obtain the field of view without vignetting. Specially designed eyepieces can provide a longer distance between the eyepiece glass and the actual exit pupil position. This is called long eye relief. Long eye relief constitutes 12-14mm in compacts and 15-20mm or more in full-size models.

Magnification/Power

The first number in a binocular's designation. It describes how many times larger the image appears than the human eye would see without the binocular.

Multicoatings

The application of multiple layers of coatings to the lenses to improve brightness, color and contrast of the image.

Nitrogen-Filled

Part of the process to render the binocular waterproof and fogproof. After the instrument has been purged of virtually all moisture, air and gaseous water molecules while in a special chamber in an almost perfect vacuum state, the instrument is filled with nitrogen gas and sealed securely with O-rings. It prevents fogging and mold.

Objective

The lens closest to the subject is the objective lens. Generally an objective lens combines convex and concave lenses to minimize color fringing, resulting in clearer images. It is the light/image gathering end of the binocular.

Objective Lens Diameter

Effective diameter of the objective lens. The effective diameter is the inside diameter of the objective lens frame. With binoculars designated with a numerical formula 8x42 7.0°, 42mm is the effective diameter of the objective lens. It is a major factor in determining how much light enters the binocular. It is the second number in a binocular's designation.

O-Ring Sealed

Part of the process to render the binocular waterproof and/or fogproof. The instrument is sealed securely with O-rings.

Phase-Coating/ Phase-Correction Coating

Phase shift of light is caused by phase differences arising from total light reflection on a roof (Dach) surface. Phase-correction coating is applied to the surface to minimize loss of resolution, ensuring high-contrast images.

Porro Prism

The Porro prism was invented by Ignazio Porro in mid-19th-century Italy. All of its reflective surfaces are completely reflective, so it loses no light and such binoculars are easy to produce. However, the optical path is bent like the letter Z. Accordingly, this prism system takes up considerable space, so binoculars with a Porro prism are larger than those with a roof (Dach) prism.

Prism

Prism binoculars employ prisms in the optical system to rectify an inverted image projected by the objective. The prism also shortens the optical path, resulting in a compact body. There are two types of prism binoculars: Roof (Dach) prism and Porro prism.

Real Field of View

Real field of view is the angle of the visible field, seen without moving the binoculars, measured from the central point of the objective lens. The larger the value is, the wider the viewfield available.

Relative Brightness

Relative brightness value is obtained by squaring the diameter of the exit pupil. The greater the relative brightness is, the brighter the image will be. With 8x42 binoculars, the brightness is $(42 \div 8)^2 = 28.1$. This means that if the magnification is the same, the larger the effective diameter of the objective lens, the brighter the image will be.

Resolution

The ability to separately perceive two objects (dots or lines) set close to each other is called resolution and usually it is measured by angular separation of the two objects. The larger the objective diameter, the better the resolving power.

Roof (Dach) Prism

"Dach" means roof in German. The optical path at the objective side and eyepiece side is virtually straight, making it possible for the binoculars to be compact and slim. They are more costly to produce because their very small prisms require special grinding and polishing to maintain image integrity.

Rubber Armor

Rubber coating on a binocular is for the benefit of grip and non-slippage. Rubber armor alone cannot provide waterproof integrity and is not required for waterproofing.

Twilight Factor

Twilight Factor equals the square root of the result obtained by multiplying power rating by the size (in mm) of the objective lens. It measures the imaging capability under severely low-light and low-contrast conditions, similar to those often experienced in wildlife observation at dawn and dusk. Twilight Factor takes into account that by multiplying the objective by the power of the binocular, a higher power will provide you with much greater detail and image identification.

Water Resistant/Rain Proof

Water resistant/rain proof binoculars mean that brief exposure to the elements, a light sprinkle, is tolerable. Unlike a waterproof instrument, there is no immersion capability.

Waterproof

Nikon's waterproof binoculars keep body tubes airtight by being sealed securely with O-rings. However, binoculars should not be used underwater. When waterproof binoculars get wet, wipe the water off thoroughly and dry them.

Wide Field of View Binocular

Wide Field of View Binoculars have fields of view of 60° or greater, based on the ISO 14132-1:2002 standard. With the conventional method used previously, the apparent field of view was calculated by multiplying the real field of view by the binocular magnification. (With this formula, apparent field of view wider than 65° is called wide field of view.)

Zoom Binocular

Zoom binoculars provide a range of magnifications. However, note that as the magnification becomes higher, the field of view will become narrower, and an unstable image caused by hand movement is likely to occur. Please be aware of these factors before using zoom binoculars.



All Nikon Trademarks are the property of Nikon Corporation.

Technical Information 1-800-NIKON US
Service & Repair 1-800-NIKON SV
Nikon Service & Repair Center

Features and specifications subject to change without notice.
NikonUSA.com © Copyright 2023 Nikon Corporation

SRO-BINOHANDBOOK-2023