

Nikon 1



SLR-111/V1-30-9/11







CONTENTS

INTRODUCTION	2
FEATURES	
Motion Snapshot	6
Fastest Autofocus	8
HD Movies & Photos	10
Smart Photo Selector	12
TECHNOLOGY	
Expeed 3™	14
Fast Continuous Shooting	16
Slow Motion Movie	18
Scene Recognition Mode	20
Simple Operability	22
Active D-Lighting	24
Picture Control	26
1 NIKKOR LENSES	
Interchangeable Lenses	30
SYSTEM ACCESSORIES	
Software Tools	32
GPS	34
Speedlight	36
Lenses	38
ACCESSORIES	
Nikon 1 J1 Accessories	40
Nikon 1 V1 Accessories	42
SYSTEM INFORMATION	
Additional Features	44
System Chart	46
Technical Specifications	48

A NIKON THE WORLD HAS NEVER SEEN...

Twenty years ago the first digital camera was introduced. Since then, photographs and videos have become dramatically more accessible. The world of photography and videography has evolved from one that offers creative freedom to shoot, to one that explores ways of enjoying and sharing these unique digital creations.

Photos and video help us communicate everything from the mundane to the triumphant. Their overwhelming dominance as a mode of communication, expression and influence is vast.

The camera that helps us capture this change is here.

...AND IT HAPPENS
TO BE VERY, VERY
SMALL.



NIKON'S REVOLUTIONARY NEW NIKON 1

To meet today's incredible insatiability for digital imagery, Nikon set out to design a new imaging system engineered from the ground up. A completely fresh look at digital imaging was made – and a goal to create one camera able to satisfy all needs was set.

Nikon combined the most advanced functions with superior operability to provide both simple and universally intuitive design. We balanced unprecedented portability with unparalleled image quality. We looked not only to bring freedom to produce both high-quality still and moving images, but to bring an entirely new feel to visual expression with the combination of music.

Introducing the new advanced interchangeable-lens digital camera system: Nikon 1. A high-performance, portable, versatile camera, Nikon 1 delivers stunning image results.

Nikon Revolutionizes Imaging with Nikon 1.
A Breakthrough in Technology and Design.



MOTION SNAPSHOT

Brings to life new photographic and live motion expression to capture your precious moments.

Nikon 1 has re-engineered imaging, creating a new way to preserve and share your memories, with something more than just a photo or movie.

In a single touch of the shutter button, start creating your own Motion Snapshot. The camera grabs a high-resolution still, plus a one-second movie vignette. When played back, your Motion Snapshot becomes a magical motion series showing the movie displayed in dramatic slow motion culminating with a still image. Music accompanies the playback.

Whether it's an infant's fleeting change of expressions, or landscape ambience of trees gently swaying in the wind, you can capture moments more vividly and emotionally through Motion Snapshot.



NIKON 1 J1

Create and Express as Never Before



Available in five colors with color-coordinated lenses.

NIKON 1 V1

Pursue and Express Life's Moments



Available in black with electronic viewfinder, optional lenses, flash and GPS.



A magical motion series showing... a dramatic combination of movie and stills along with music.

FASTEST AUTOFOCUS

Incredibly fast and seamless.
Capture the action you never
knew existed.

Fastest Autofocus with 73-point Focal Plane Phase-Detect. Nikon 1 offers advanced focusing technology to help capture special moments with ease.

First, we present incredibly responsive autofocus speed with focal plane phase-detect AF to track and capture fast-moving subjects in sharp, crystal-clear focus. Second is Nikon's incredible 73-point focal plane phase-detect AF that extensively and thoroughly monitors all action: the subject in the field of view is recognized and tracked to ensure elements on the focal plane are rendered sharply.

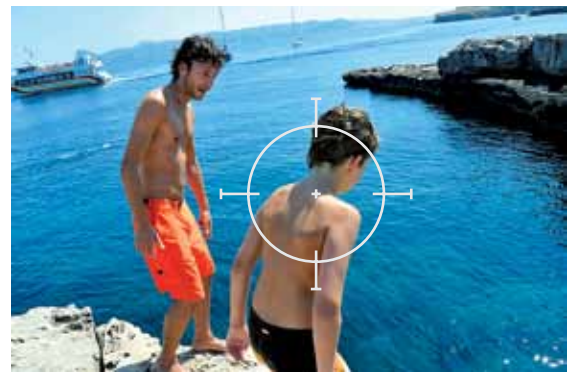

Finally, when working in poorly lit areas, the Advanced Hybrid AF System automatically selects contrast-detect AF mode then expands the area metered by autofocus to improve output.



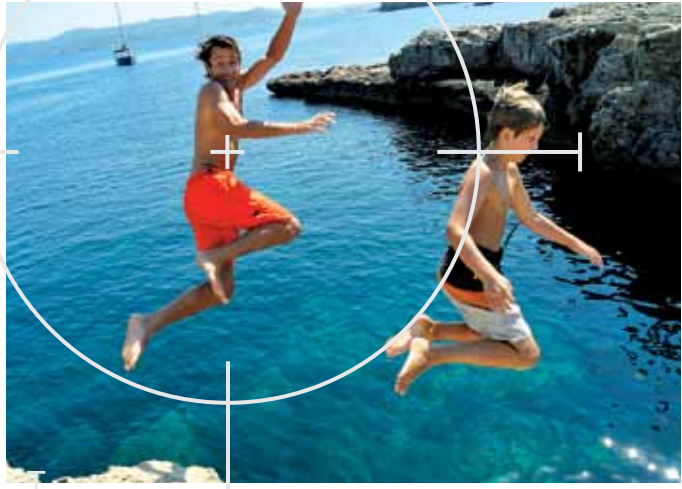
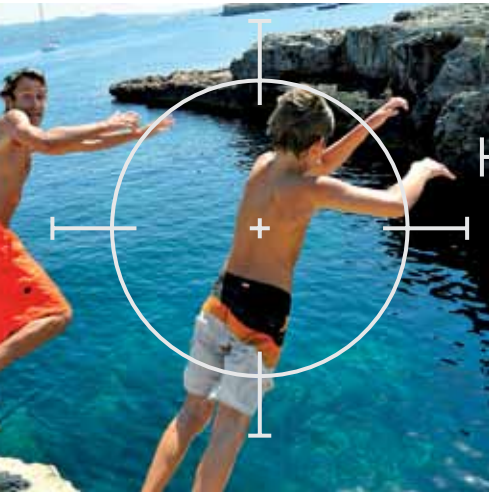

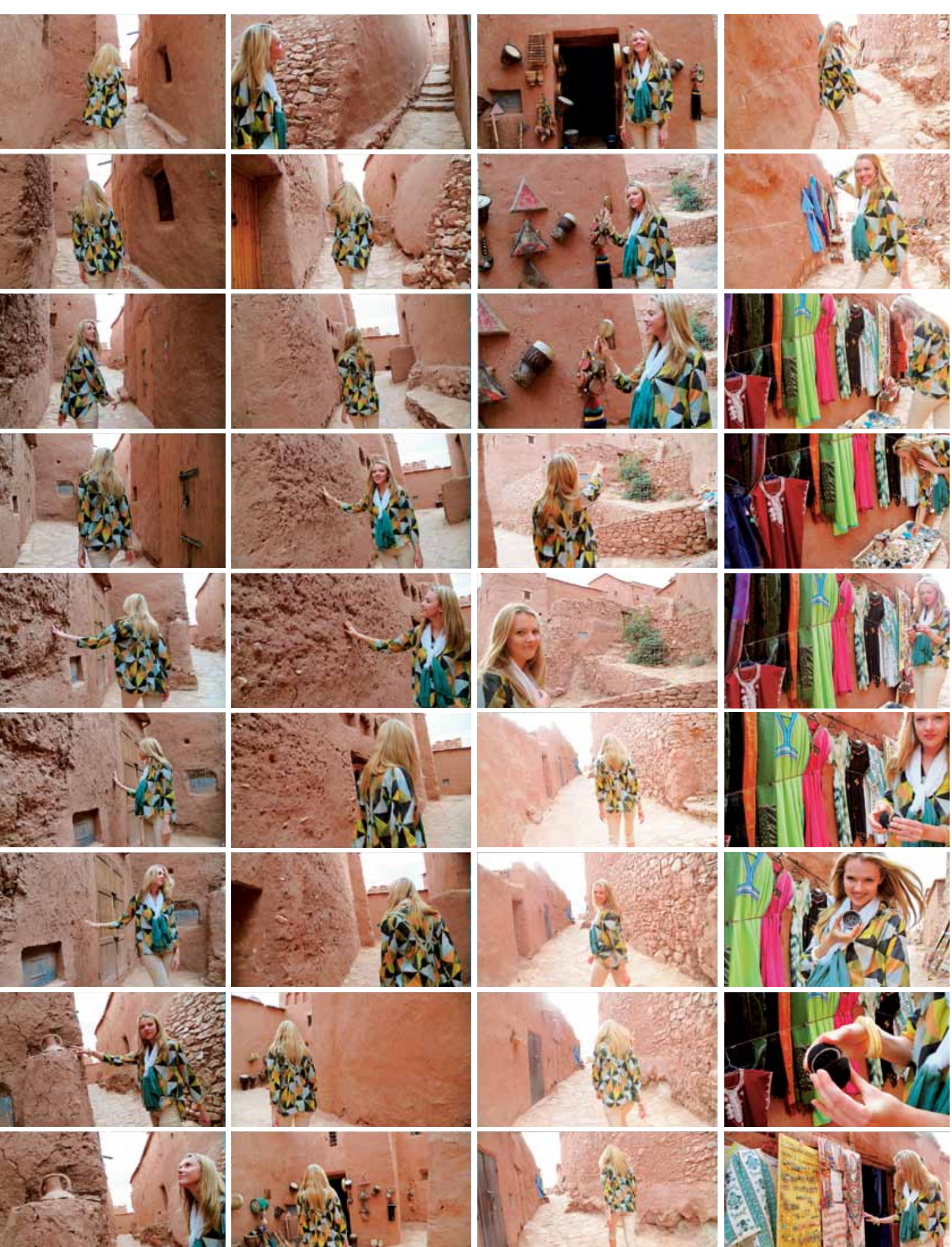

SIMULTANEOUS HD MOVIES & PHOTOS

The Nikon 1 can take photos while recording Full HD 1080p movies.

Until now you had to choose between recording movies or taking photographs. With Nikon 1, work in movie mode in Full HD and simultaneously capture high-resolution still images.

Use the Nikon 1 phase-detect AF to follow your subject and keep it in focus at all times. Even while shooting a movie, capture high-resolution stills without interruption and without changing the mode dial. Photos or movies – you no longer have to choose. Both can be yours with the Nikon 1.



Even while you are shooting a movie, you can capture high-resolution still images without interruption and without changing the mode dial.

SMART PHOTO SELECTOR

The difference between a perfect shot and a missed shot is merely a split second.

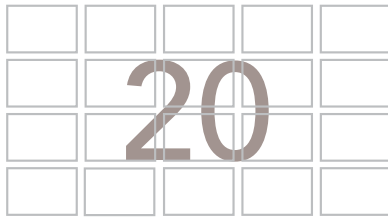

When shooting that special moment you may find it difficult to keep subjects within the frame. Or you may miss a photo opportunity due to the subject's unpredictable movements.

With Smart Photo Selector, never miss those picture-perfect moments. Simply compose, push the shutter button once and the camera does the work. It's that simple. The camera automatically takes 20 shots before and after the instant the

shutter button is pressed – capturing at an incredibly high speed of 30fps. The camera selects five good images from the series, then determines the most spectacular from among those five to give a final photo recommendation.

Whether it's a fun-filled party or a day at the beach, the Nikon 1 captures it all. Experience the ingenuity of Nikon's Smart Photo Selector and you'll never want to shoot anything without it.

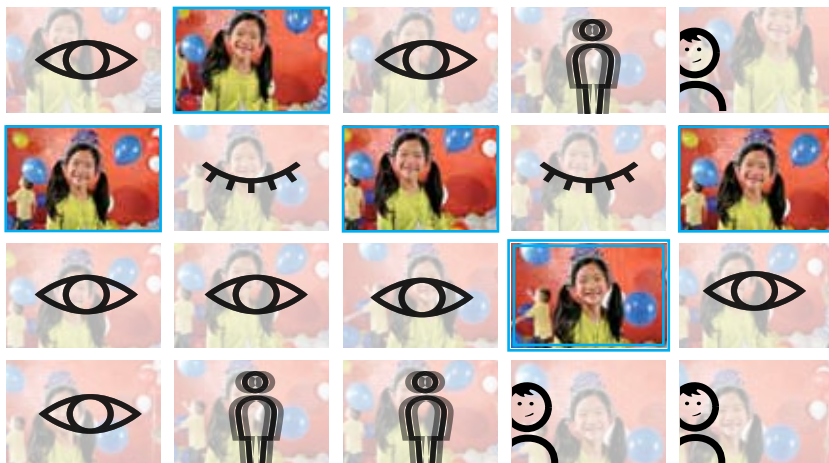

 Eyes open  Eyes closed  Out of frame  Blurred  Selected

With Smart Photo Selector the camera will automatically scan the 20 photos and recommend the best ones. It will not select a photo if the subject is out of frame, blurred or has their eyes closed.

EXPPEED 3™

New High-Speed AF CX-Format CMOS Sensor and New Image Processing Engine.

Experience a revolutionary new style of shooting with Nikon's state-of-the-art image sensor and processing engine. The dual autofocus CMOS sensor newly developed for the Nikon 1 is the world's first image sensor created for an interchangeable-lens digital camera with focal plane phase-detect autofocus. Also equipped with contrast-detect autofocus, the Nikon 1 is a versatile camera engineered to tackle a wide range of subjects and situations.

Precision-focus operation provides smooth and comfortable shooting during both still and movie record operations. The camera delivers beautiful picture quality and reduced noise levels, courtesy of the new high-speed AF CX-format CMOS Sensor developed using best-of-breed engineering from both Nikon FX- and DX-format image sensors.

EXPPEED 3™, the new high-speed processing engine designed specifically for the Nikon 1, streamlines capture of Full HD movies, and boasts simultaneous movie record plus high-resolution image capture.

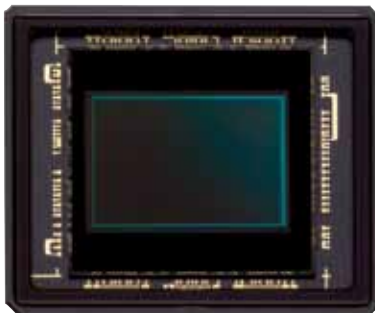

EXPPEED 3™

New High-Speed AF
CX-Format CMOS Sensor.



FAST CONTINUOUS SHOOTING

Fast Continuous Shooting at 10fps in Subject Tracking AF Mode. Maximum 60fps Shooting in Fixed-Focus Mode.

Experience super fast autofocus.

With high-speed continuous shooting set to AF mode, capture up to 10fps and keep photo elements sharply in focus. When shooting without AF, experience amazing speeds up to 60fps.

Don't miss any once-in-a-lifetime photo opportunity! Capture the spontaneous – exciting action at a sporting match, energetic children at play, or even a hummingbird buzzing over a flower. With Nikon's autofocus technology, spectacular moments can be captured with not just one, but a series of super sharp high-quality images.



SLOW MOTION MOVIE

Control the lapse of time to reveal subtle details in your movies.



Using Slow Motion Movie mode, reduce playback speed of your recordings to bring variety to movies and throw focus on specific details. Capture a dramatic moment at 400fps or 1,200fps speeds and watch what happens!



SCENE RECOGNITION MODE

Don't let camera settings and functions get in your way.

Focus on taking the shot! Set to Scene Recognition mode and let the camera determine what's best.

Taking a photograph of a person? The camera automatically selects "Portrait" mode. Shooting at dusk or night? The camera switches to "Night Portrait" mode. Photographing a cityscape or scenery? "Landscape" mode is selected. Capturing something nearby? "Close-up" mode becomes the default.

The camera can detect both subject and setting, then will automatically configure to an optimal setting. Simply find your subject, frame, then hit the shutter button.



The camera automatically selects "Landscape" mode.



Set to "Auto" mode and let the camera decide what's best.



The camera automatically selects "Portrait" mode.



The camera automatically selects "Night Portrait" mode.



The camera automatically selects "Close-up" mode.

SIMPLE OPERABILITY

The most important functions should be the simplest to use.

To streamline operation, a single dial has been placed on the back of the camera to divide functionality into four modes: Still Images, Moving Images, Motion Snapshot and Smart Photo Selector. The only buttons to be found on top the camera are Power, Shutter and Record.

Nikon 1, with its intuitive design free of complex configuration and challenging operation, permits you to capture exactly what you desire, when you like and with ease.



The Nikon 1 divides functionality into four modes.



Motion Snapshot



Smart Photo Selector



Still Images



Moving Images





Active D-Lighting restores the balance of shadow and highlight details that are often lost when photographing in strong lighting conditions.

ACTIVE D-LIGHTING

Create remarkable images – even in scenarios where high-contrast light-to-shadow prevails.

Active D-Lighting correction optimizes high-contrast images and restores the balance of shadow and highlight details that are often lost when photographing in strong lighting conditions; contrast between bright and dark areas within an image is corrected. For even more control, personally adjust exposure settings and produce results exactly to your liking.

By controlling overexposure and preserving subtle features of underexposed areas, Active-D Lighting can create well-balanced results. The details of a white shirt shimmering in the sunlight; the expression of your loved one smiling in the shadows are rendered more accurately. Capture these and other moments just as you remember them.



Without Active D-Lighting, a camera determines the photo's exposure based on one part of the image.



With Active D-Lighting, the image exposure can be corrected when you take the photo.



PICTURE CONTROL

Refine your special moments with Picture Control.



VIVID



NEUTRAL



MONOCHROME



STANDARD



PORTRAIT



LANDSCAPE

Go beyond just capturing a special moment. Transform the look and feel of your images using in-camera retouch effects. Picture Control is Nikon's unique feature that gives photographers the ability to stylize a photo's look to suit a preference. Choose from among six options: Standard, Neutral, Vivid, Monochrome, Portrait and Landscape.

Effortlessly transform your images to match your vision. Sharpen an image by emphasizing the silhouette, or create a more vivid look by adjusting saturation. Whether you are a professional or an amateur, use Nikon's Picture Control system for even greater creative freedom.

Picture Control offers different ways to enhance your image.

CAPTURE THE WORLD AS YOU SEE IT, AS YOU EXPERIENCE IT





1 NIKKOR LENS SYSTEM

The 1 NIKKOR® interchangeable-lens system was created especially for the Nikon 1 system.

Compatible with 1 Mount devices, 1 NIKKOR represents the first NIKKOR lens system developed since the F Mount's debut nearly half a century ago. A high-performance system that is extremely portable and compact, the 1 NIKKOR is engineered with cutting-edge optical technology – extending a heritage of precision symbolized by durability, superior image quality and optical excellence.



1 NIKKOR VR 10-30MM F/3.5-5.6

[35mm equivalent focal length: 27-81mm]

An incredible standard zoom lens that flawlessly captures the scene in vivid detail.

A wide range of scenes can be framed with remarkable accuracy, including snapshots from your everyday life, landscapes and portraits. Get as close as 7.8* inches to your subject and still maintain exceptional focus.

Covering the most useful standard and wide-angle focal lengths, the 10-30mm responds to your every desire. A retractable lens structure, controlled by a collapse button on the rim, makes this lens exceedingly portable.

*Distance measured from the focal plane mark on the camera body to the subject.



1 NIKKOR 10MM F/2.8

[35mm equivalent focal length: 27mm]

A slim-profile, wide-angle, fast-aperture lens.

A slim-profile, wide-angle lens, the 10mm f/2.8 is optimal for shooting quality photographs of nature, snapshots of daily life, even dark indoor settings. The only fixed focal length lens in the series, the 10mm renders everything from gorgeous blurring of backgrounds to crystal-clear resolution edge-to-edge. Extremely compact and stylish, this lens can be taken wherever you go.



1 NIKKOR VR 10-30MM F/3.5-5.6

0

10mm

20mm

30mm

40mm

50mm



1 NIKKOR VR 30-110MM F/3.8-5.6

[35mm equivalent focal length: 81-297mm]

Compact telephoto zoom brings your subjects closer and captures a wide range of scenes.

From sporting events shot from high up in the stands, to portraits, to sweeping landscapes. Superior zoom coverage, plus high-caliber image resolution, reveals the most subtle details. Produce beautiful portraits that accentuate the subject and set it apart from the background. A retractable structure offers a very compact and extremely portable telephoto lens.



1 NIKKOR VR 10-100MM F/4.5-5.6 PD-ZOOM

[35mm equivalent focal length: 27-270mm]

A compact, power-drive zoom lens optimal for shooting dynamic movies.

Express yourself dramatically with this 10x power zoom lens developed specifically for use when shooting movies. The 10-100mm delivers smooth flowing zoom coverage with silent power-drive operation. Variable zoom speed (three speeds) brings creative framing options.



1 NIKKOR VR 30-110MM F/3.8-5.6

1 NIKKOR VR 10-100MM F/4.5-5.6 PD-ZOOM

60mm

70mm

80mm

90mm

100mm

110mm



MY PICTURETOWN

Share and store your photos, movies, and Motion Snapshots with my Pictown.

Shooting photos and movies is more fun when you share them. Use Nikon's my Pictown as your personal online album to securely store and organize photographs and movies. Share your creations with friends and family.

A free membership provides up to 2GB secure storage space. Upload JPEG files, RAW (NEF, NRW), HD movie formats (MOV, AVI) and even Motion Snapshot vignettes. Use iPhone and iPad applications to seamlessly integrate your photographs and movies directly to your Facebook and Twitter accounts. For a nominal fee, purchase a membership and get up to 200GB of storage space.

VIEW NX2 SOFTWARE

Make images even more exquisite.

Looking for a better way to view, edit and share photographs and movies?

View NX2 software makes managing photos and movies fun and easy. Import, view, edit and share your work. Rotate and change file sizes, adjust brightness, crop, correct tilting, plot photos onto a map using GPS data, work with RAW images and more. Even create your own original movie in Full HD quality!

SOFTWARE TOOLS

The joy of creating.
The joy of sharing.

New software tools extend your enjoyment of the Nikon 1 system. View NX2 software streamlines file importing and browsing. The software handles commonly requested retouch adjustments such as resize, brightness control, crop and straighten. View NX2 manages RAW file processing.

Nikon's new Short Movie Creator software lets you edit your movies and create Motion Snapshot vignettes with ease.

My Picturetown is Nikon's smart photo sharing and storage service with free membership and 2GB of file storage.



SHORT MOVIE CREATOR

Create your own movies using drag and drop.

Short Movie Creator software lets you edit your movies in a snap. Simply install onto your PC or Mac. Select desired visual effects and music. Pick your favorite scenes and let the software create a short movie to suit your taste. Once done, easily upload and share on Facebook, YouTube and other video-sharing Web sites.

Want to watch movies on your camera? Transfer desired files onto a memory card, insert, then view. Use Short Movie Creator and ViewNX2 to create and enjoy all your special moments as photos, movies and Motion Snapshots.



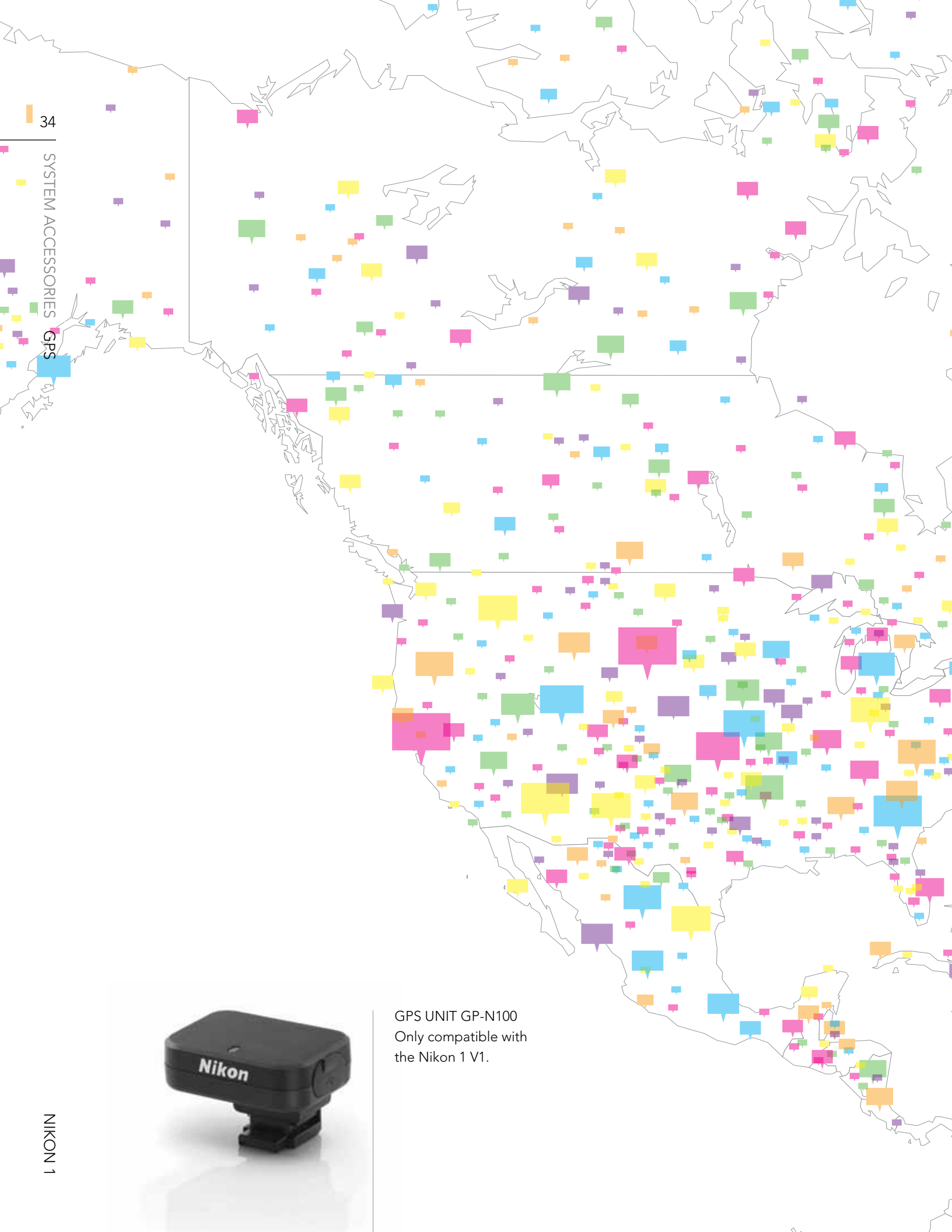

GPS UNIT GP-N100
Only compatible with
the Nikon 1 V1.



GPS

Every time you capture a moment, the world and your memories become one.

Tag your photos and movies with GPS data and pinpoint exactly where you have been.

Plug in the GPS unit accessory (GP-N100) to the Nikon 1 and automatically store location data to your photo and movie files. Embedded with A-GPS (assisted GPS), the device quickly calculates your location, then tags each file. Use in combination with ViewNX 2 software to plot image and movie files to an Internet mapping service, then retrace your routes!

SPEEDLIGHT SB-N5

Create with light.

The newly designed Nikon 1 Speedlight SB-N5 brings illumination to scenes that previously were too dark to shoot. In backlit scenarios, the Speedlight illuminates both subject and background so each may be captured in sharp detail. Rotate the flash head up, down, left or right. Bounce and reflect the flash off the ceiling or a wall to produce a soft, natural light.

If shooting with Smart Photo Selector or Motion Snapshot, an extended duration of light is required to illuminate subjects for longer than a flash cycle. Use the Speedlight to help keep constant illumination on your subjects for up to six seconds. This small portable Speedlight brings to life photographs and movies just as you imagined them.



SPEEDLIGHT SB-N5

Only compatible with the
Nikon 1 V1.



Without
SPEEDLIGHT SB-N5



With
SPEEDLIGHT SB-N5

WIDEN YOUR FIELD OF VISION WITH 1 NIKKOR® LENSES

The Speedlight and GPS unit will enhance your photo opportunities. These features combined with the Nikon 1 will enable you to capture an eclectic range of unprecedented images.



10mm Single-Focus Lens
1 NIKKOR 10mm f/2.8

10-30mm Standard Zoom Lens
1 NIKKOR VR 10-30mm f/3.5-5.6

30-110mm Telephoto Zoom Lens
1 NIKKOR VR 30-110 f/3.8-5.6



*1 NIKKOR lenses can be attached to all Nikon 1 models equipped with the Nikon 1 mount.

Designed for the Nikon 1 J1 System: sleek, stylish accessories

Have fun. Express your personality. Bring more creativity to your looks with a wide range of accessories, including cases and straps in matching colors.

1 NIKKOR LENSES

Neutral Color Filter
NC 40.5

(Diameter: 40.5mm; comes with filter case)

The multi-coated glass reduces the chance of sun and lens flare relics from appearing in your photos. The filter does not affect the color hues (visible light spectrum). Protective lens filter is perfect for daily use.



10-30mm Standard Zoom Lens Hood
for 1 NIKKOR VR 10-30mm f/3.5-5.6
HB-N101

Custom lens hood helps prevent ghosting and flare due to extraneous light when working with lens 10-30mm f/3.5-5.6.



10mm Standard Lens Hood
for 1 NIKKOR VR 10mm f/2.8
HN-N101

Custom lens hood helps prevent ghosting and flare due to extraneous light when working with lens 10mm f/2.8.



Hood Cap
HC-N101

Color-match hood cap protects
1 NIKKOR 10mm f/2.8.



CASES AND STRAPS



Body Case
CB-N2000

An easily removable protective leather body case specifically designed for the Nikon 1.



Body Case Set

CB-N2000SA (black), CB-N2000SB (white)
CB-N2000SC (brown), CB-N2000SD (pink)
CB-N2000SE (red)

Leather camera case designed to store the Nikon 1, as shown, with 10-30mm standard zoom lens.

PERIPHERAL DEVICES



Remote Control
ML-L3

Battery-powered remote control offers "immediate remote mode" and "two second delay mode."

Tripod Mounting Spacer
TA-N100

The tripod mounting adapter is used when larger lenses are placed on Nikon 1 cameras. It prevents the lenses from coming in contact with the tripod head when the camera is mounted on a tripod.

Grip
GR-N2000

A custom, Removable grip offers a reassuring hold for all your photography work.



BATTERY/CHARGERS



Rechargeable Li-ion Battery
EN-EL20



Battery Charger
MH-27

Works with the Li-ion rechargeable battery EN-EL20. Fully charges the EN-EL20 battery in approximately 2 hours.



Power Connector
EP-5C



AC Adapter
EH-5B*

Operate the Nikon 1 while it's charging with a 100V AC adapter.

*When connecting the EH-5B AC adapter to the camera, you will need the EP-5C power connector for the Nikon 1 J1.



Soft Lens Case
for 1 NIKKOR VR 10-30mm f/3.5-5.6,
1 NIKKOR VR 30-110mm f/3.8-5.6,
1 NIKKOR 10mm f/2.8
CL-N101

A custom soft case for the zoom and single-focus lenses.



Leather Neck Strap
AN-N2000

A thin and supple leather camera strap that attaches to leather camera case CB-N2000. Use as a neck strap or sling over your shoulder. Available in five matching colors (black, brown, red, pink and white) to go with your body case!



Leather Hand Strap
AH-N1000

For casual portability, attach matching leather hand strap AH-N1000 to leather camera case CB-N2000. Available in four matching colors (black, white, brown, and red) to go with your body case!

Designed for the Nikon 1 V1 System: sleek, stylish accessories

Have fun. Express your personality. Bring more creativity to your looks with a wide range of accessories, including cases and straps in matching colors.

1 NIKKOR LENSES

Neutral Color Filter
NC 40.5

(Diameter: 40.5mm; comes with filter case)

The multi-coated glass reduces the chance of sun and lens flare relics from appearing in your photos. The filter does not affect the color hues (visible light spectrum). Protective lens filter is perfect for daily use.



10-30mm Standard Zoom Lens Hood
for 1 NIKKOR VR 10-30mm f/3.5-5.6
HB-N101

Custom lens hood helps prevent ghosting and flare due to extraneous light when working with lens 10-30mm f/3.5-5.6.



10mm Standard Lens Hood
for 1 NIKKOR VR 10mm f/2.8
HN-N101

Custom lens hood helps prevent ghosting and flare due to extraneous light when working with lens 10mm f/2.8.



Hood Cap
HC-N101

Color-match hood cap protects
1 NIKKOR 10mm f/2.8.



CASES AND STRAPS

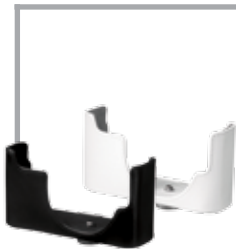

Body Case
CB-N1000

An easily removable protective leather body case specifically designed for the Nikon 1.



Body Case Set
CB-N1000SA (black), CB-N1000SB (white)

Leather camera case designed to store the Nikon 1, as shown, with 10-30mm standard zoom lens.



Soft Lens Case for
1 NIKKOR VR 10-100mm
f/4.5-5.6 PD-ZOOM
CL-N102

A custom soft case for the power-drive zoom lens.

PERIPHERAL DEVICES



Remote Control
ML-L3

Battery-powered remote control offers "immediate remote mode" and "two second delay mode."

Tripod Mounting Spacer
TA-N100

The tripod mounting adapter is used when larger lenses are placed on Nikon 1 cameras. It prevents the lenses from coming in contact with the tripod head when the camera is mounted on a tripod.



F-Mount Adapter
FT-1

For versatility to use DX and FX NIKKOR Lenses

Mounting Foot Cover
for GP-N100, SB-N5,
BS-N2000

Soft Case for SB-N5
SS-N5

Soft Case for GP-N100
CG-N100

Grip
GR-N1000

Removable grip offers a reassuring hold for all your photography work.



Stereo Microphone
ME-1

Stereo microphone records crystal-clear audio quality and significantly reduces wind noise. Requires the Multi-Accessory Port Adapter AS-N1000.

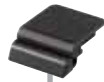

Multi-Accessory Port Cover
BS-N1000
(available in black or white)

Accessory shoe cover protects the interface when accessories are not in use on the camera.

BATTERY/CHARGERS



Rechargeable Li-ion Battery
EN-EL15



Battery Charger
MH-25

Works with the Li-ion rechargeable battery EN-EL15. Fully charges the EN-EL15 battery in approximately 2.5 hours.



Power Connector
EP-5B



AC Adapter
EH-5B*

Operate the Nikon 1 while it's charging with a 100V AC adapter.

*When connecting the EH-5B AC adapter to the camera, you will need the EP-5B power connector for the Nikon 1 V1.



Soft Lens Case
for 1 NIKKOR VR 10-30mm f/3.5-5.6,
1 NIKKOR VR 30-110mm f/3.8-5.6,
1 NIKKOR 10mm f/2.8
CL-N101

A custom soft case for the zoom and singl-focus lenses.



Leather Neck Strap
AN-N2000

A thin and supple leather camera strap that attaches to leather camera case CB-N1000. Use as a neck strap or sling over your shoulder. Available in five colors (black, brown, red, pink and white).



Leather Hand Strap
AH-N1000

For casual portability, attach matching leather hand strap AH-N1000 to leather camera case CB-N1000. Available in four colors (black, white, brown and red).

INCREDIBLE NIKON QUALITY WITH THESE AMAZING ADDITIONAL FEATURES



High-Resolution, High Contrast Electronic Viewfinder (V1 only)

The Nikon 1 V1 gives photographers the option to work with flexibility – using either the 1440K-dot (SVGA) electronic viewfinder (EVF) measuring 0.47 inches (12mm diagonally) or the large 3-inch LCD panel offering 100 percent view.



Built-In Flash (J1 only)

Nikon 1 J1 comes with an i-TTL built-in flash (Guide Number: approx. 5 [ISO 100*m]). With the slow-sync mode, you can capture both the beautifully lit nightscape and the subject at optimal exposure levels.



Effortless and Reliable Remote Operation

The ML-L3 Remote Control (optional) makes taking still images using the self-timer effortless. The Nikon 1 V1 can receive signals from the remote control from both the front and rear of the camera (Nikon 1 J1 can only receive signals from the front).



Silent Mode Operation

Shoot in theaters and other quiet settings without making a sound. The Nikon 1 allows you to change settings in order to turn off the electronic shutter sound, AF and self-timer.



Shoot High-Definition Movies With High-Quality Stereo Sound

Why not enjoy the powerful picture quality of full high-definition movies with superior sound? The camera can record stereo sound with microphones placed symmetrically and laterally along the camera's optical axis. Using the manual sensitivity settings, the camera will record the changes in the dynamic range faithfully.

Versatile Dual Shutter System (V1 only)

The Nikon 1 V1 features an electronically controlled vertical-travel focal plane shutter. An exceptional combination of electrical and mechanical shutters is able to capture fast moving subjects in razor-sharp detail.



High-Resolution LCD Monitor

The Nikon 1 V1 is equipped with a 3-inch LCD color display with an ultra high-resolution VGA screen (920k-dots) to show every detail to precision. An anti-glare coating renders easy viewing of photos and HD movies.

The Nikon 1 J1 is equipped with a 3-inch LCD color display and high-resolution VGA screen (460k-dots) to show every detail to precision. An anti-glare coating renders easy viewing of photos and HD movies.

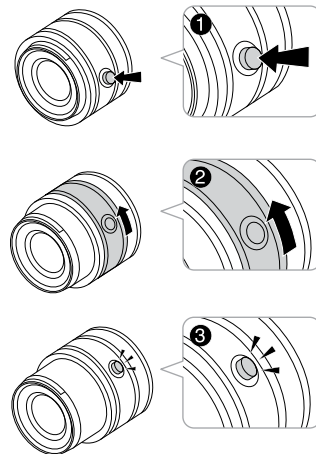

The Compact 1 NIKKOR® Zoom Lenses

The 1 NIKKOR zoom lenses employ a Retractable Lens Mechanism. Even when the power is turned off, the camera will automatically turn itself on when you manually extend the lens while pressing the zoom ring button so you will never miss another picture-perfect moment.

*The power drive zoom lens can extend and retract using an electronic motor (you can switch between auto/fixed settings).

*Single-focal length lenses are non-retractable.



Superior Engine, Expeed 3™, Realizes High-Speed Image Processing

Nikon's new generation image processing pipelines, EXPEED 3,** is embedded with 2 image processing engines that allow simultaneous scene/view display and image processing. It is also equipped with dual CPUs, which let you take advantage of phase-detection AF while performing various other tasks at the same time.

**EXPEED 3 has been developed exclusively for the Nikon 1.



View Photos and Movies on a Large Screen TV

Connect the camera to a high-definition television via the HDMI connection pin and HDMI cable. Enjoy your photographs and movies on monitor, television or large-screen display.

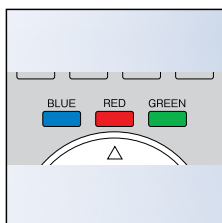
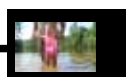

HDMI-CEC Compatible

The camera can be controlled using the blue, red, green and yellow buttons on any TV remote control using CEC-enabled HDMI with HDMI 1.3a specifications. Enjoy slide shows and more on your television set.

Phenomenally Accurate AE and Auto White Balance

Detects subjects' faces and realizes accurate AF/AE and an optimal white balance.

Extremely Robust, Highly Durable Shutter Unit (V1 only)

The Nikon 1 V1 features a newly developed compact shutter unit tested for 100,000 cycles.

Watch Your Creations Come Alive as a Slideshow

You can play back your digital creations by selecting different categories including all images, still images, movies, Motion Snapshots (only movies, excluding still images), dates, and various scenes from the Scene auto selector. You can also choose the music to accompany your slideshow from among 3 BGMs.

VR (Vibration Reduction): Correct Blur While Retaining a Stable Image

The standard zoom lens, telephoto zoom lens, and the power-drive zoom lens come with Vibration Reduction (VR) system to ensure steadier shots. The sensor within the lens identifies the direction and scale of shaking, and a compensatory optical system reduces the movement of the image in real time. VR technology allows handheld shooting at dusk and at night, or scenes from a sporting event.

Advanced Scene Recognition System

Featuring 384-segment exposure metering plus 244-segment metering for flash control, the camera accurately assesses the entire scene, then adjusts exposure, AF, white balance and other aspects with remarkable precision.

Newly Developed, Super High-Speed AF CMOS Sensor



Advanced hybrid AF system

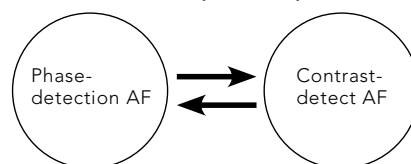

Switches automatically to suit the shooting conditions.

The newly developed CMOS image sensor, with an effective pixel count of 10.1 megapixels, is the world's first* image sensor created that implements phase-detection AF. The Nikon 1 boasts exceptionally fast auto-focusing, while promising high image quality for both still images and movies. The new image sensor has been engineered to deliver super-precise focusing that captures a wide range of subjects flawlessly.

*As of August 5, 2011, among digital cameras with interchangeable lenses.

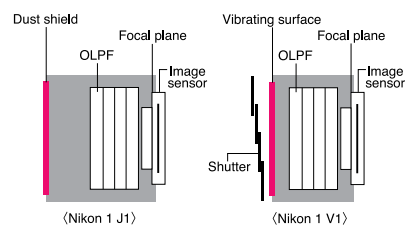

Image Sensor Cleaning With Dust Reduction

The Nikon 1 V1 employs ISC (Image Sensor Cleaning), a vibrating image sensor that removes dust by shaking it off.

The Nikon 1 J1 employs a glass dust shield to effectively prevent dust from being picked up by the image sensor.

Superb Sensitivity Delivers Remarkable Image Quality

In normal mode, the camera delivers ISO sensitivity of 100-3200. The camera also promises exceptional high sensitivity of ISO 6400 equivalent.



- 1 Movie-record button
- 2 Shutter-release button
- 3 Power switch
- 4 Power lamp
- 5 Speaker
- 6 Mounting mark
- 7 Built-in flash
- 8 \ominus Focal plane mark
- 9 Eyelet for camera strap
- 10 AF-assist illuminator
Self-timer lamp
Red-eye reduction lamp
- 11 Lens release button
- 12 Infrared receiver
- 13 Microphone
- 14 Lens mount
- 15 Dust shield
- 16 Flash pop-up control
- 17 Memory card access lamp
- 18 Feature button
- 19 Playback zoom/thumbnail control
- 20 Mode dial
- 21 Playback button
- 22 Multi selector
- 23 Delete button
- 24 Power connector cover for optional power connector
- 25 Monitor
- 26 Tripod socket
- 27 Display button
- 28 Battery chamber/
memory card slot cover
- 29 Menu button
- 30 Battery chamber/
memory card slot cover latch

Nikon 1 J1 System chart

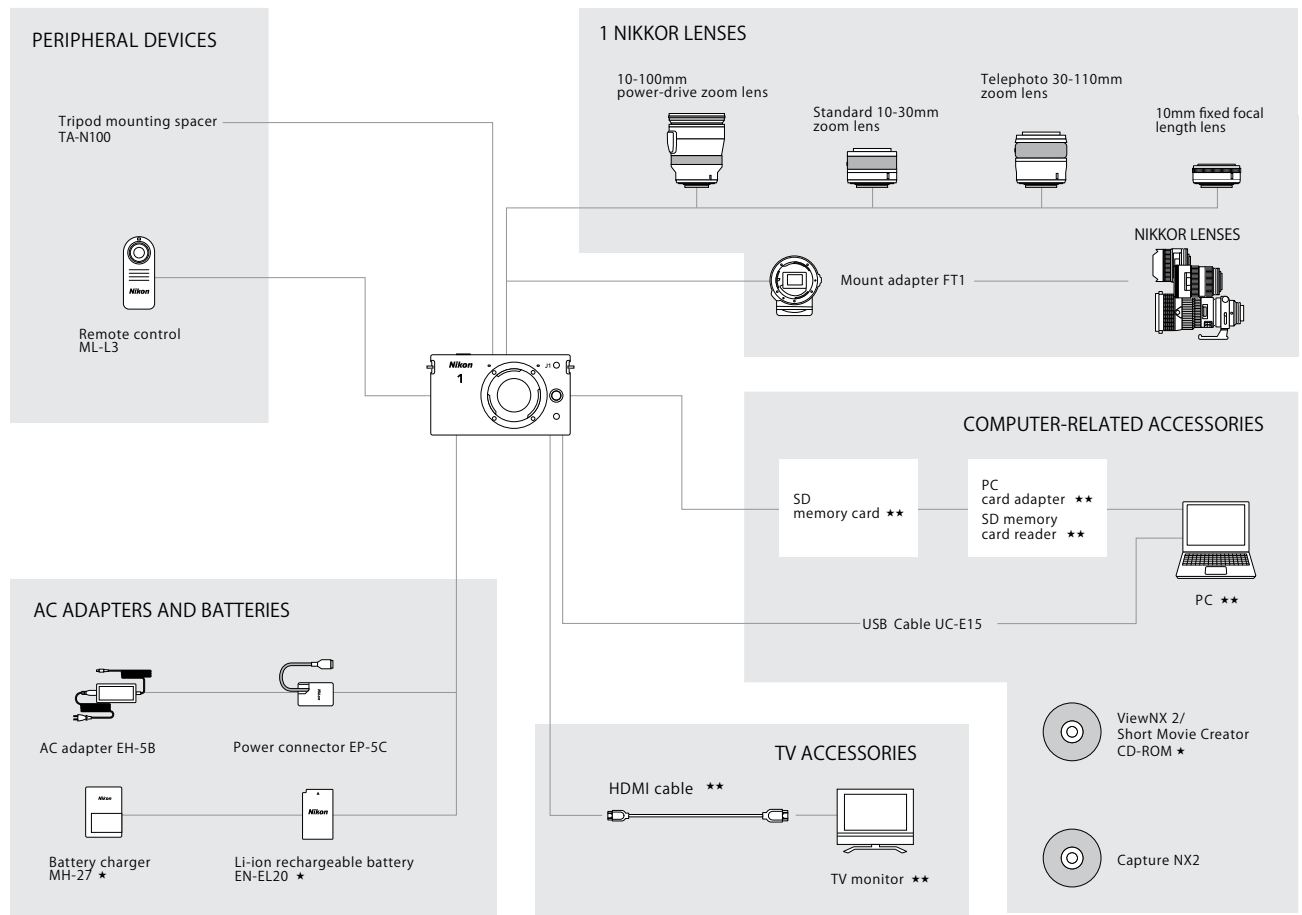

★Supplied accessories ★★Non-Nikon products



- 1 Movie-record button
- 2 Shutter-release button
- 3 Power switch
- 4 AF-assist illuminator
Self-timer lamp
Red-eye reduction lamp
- 5 Power lamp
- 6 Speaker
- 7 Microphone
- 8 Multi-accessory port
- 9 \odot Focal plane mark
- 10 Mounting mark
- 11 Infrared receiver (front)
- 12 Lens release button
- 13 Lens mount
- 14 Eye sensor
- 15 Electronic viewfinder
- 16 Diopter adjustment control
- 17 Feature button
- 18 Playback zoom/thumbnail control
- 19 Mode dial
- 20 Playback button
- 21 Multi selector
- 22 Delete button
- 23 Infrared receiver (rear)
- 24 Power connector cover for optional power connector
- 25 Monitor
- 26 Tripod socket
- 27 Battery chamber/
memory card slot cover
- 28 Display button
- 29 Menu button
- 30 Memory card access lamp
- 31 Battery chamber/
memory card slot cover latch

Nikon 1 V1 System chart

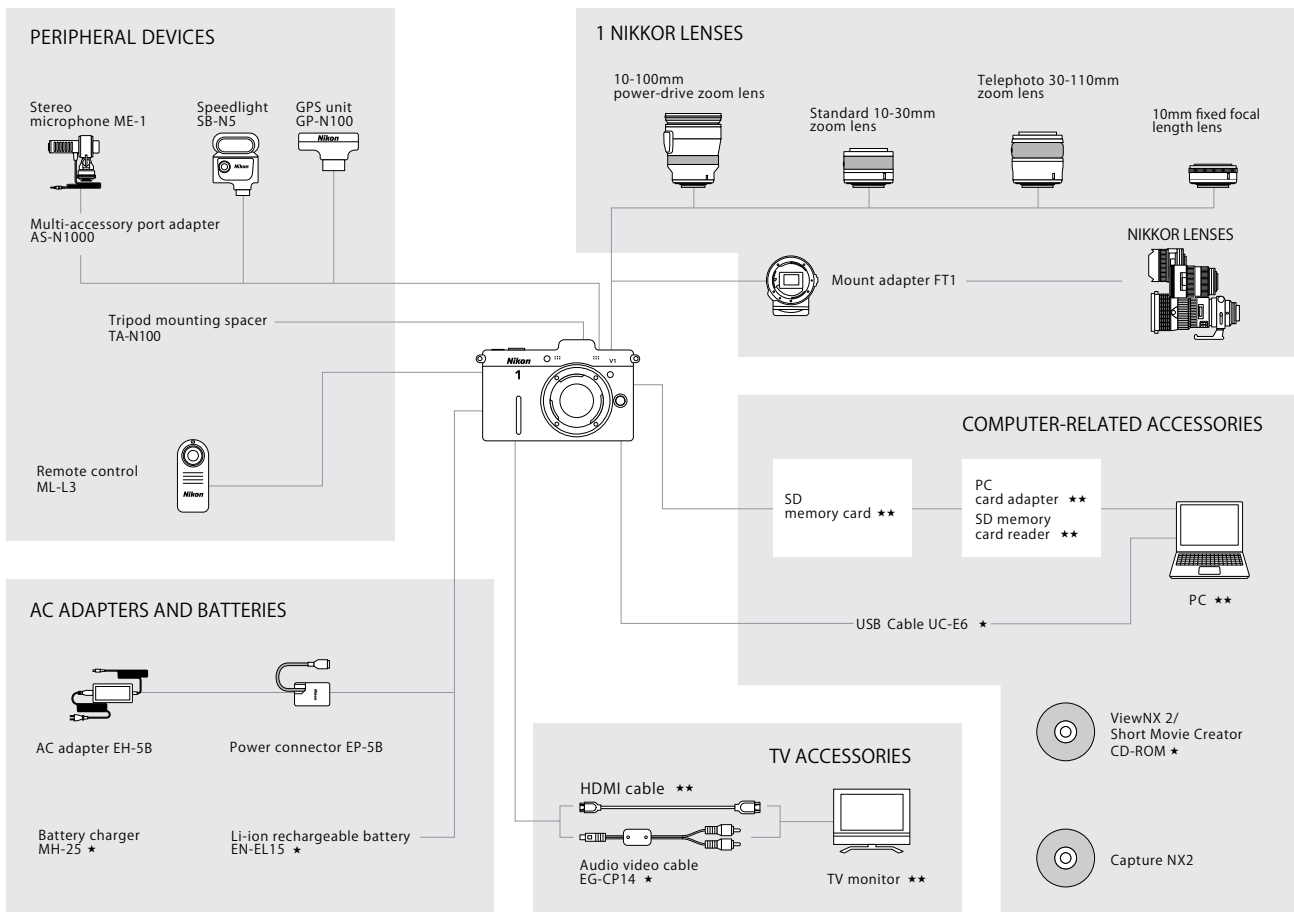

*Supplied accessories **Non-Nikon products



	Nikon 1 J1	Nikon 1 V1
Type	Advanced camera with interchangeable lenses	Advanced camera with interchangeable lenses
Lens Mount	Nikon 1 mount	Nikon 1 mount
Effective Angle View	Approx. 2.7x lens focal length (Nikon CX format)	Approx. 2.7x lens focal length (Nikon CX format)
Effective Pixels	10.1 Million	10.1 Million
Image Sensor	13.2 mm x 8.8 mm high speed AF CMOS sensor	13.2 mm x 8.8 mm high speed AF CMOS sensor
Image Size (pixels)	3872 x 2592	3872 x 2592
LCD Monitor	3-in./7.5 cm, approx. 460k-dot, TFT LCD with brightness adjustment	3-in./7.5 cm, approx. 920k-dot, TFT LCD with brightness adjustment
Electronic Viewfinder	Not Applicable	0.47-in., approx. 1440k-dot color TFT LCD viewfinder with diopter control and brightness adjustment
Full HD Movie	HD movies 1,920 x 1,080/60i 1,920 x 1,080/30p 1,280 x 720/60p. Slow-motion movies 640 x 240/400 fps (plays at 30p) 320 x 120/1,200 fps (plays at 30p) Movies recorded in still image mode 1,072 x 720/60p Motion Snapshot 1,920 x 1,080/60p (59.94 fps) (plays at 24p) Sensor output is about 60 fps	HD movies 1,920 x 1,080/60i 1,920 x 1,080/30p 1,280 x 720/60p Slow-motion movies 640 x 240/400 fps (plays at 30p) 320 x 120/1,200 fps (plays at 30p) Movies recorded in still image mode 1,072 x 720/60p Motion Snapshot 1,920 x 1,080/60p (59.94 fps) (plays at 24p) Sensor output is about 60 fps
File Format	NEF (RAW): 12-bit, compressed JPEG: JPEG-Baseline compliant with fine (approx. 1:4), normal (approx. 1:8), or basic (approx. 1:16) compression NEF (RAW) + JPEG: Single photograph recorded in both NEF (RAW) and JPEG formats	NEF (RAW): 12-bit, compressed JPEG: JPEG-Baseline compliant with fine (approx. 1:4), normal (approx. 1:8), or basic (approx. 1:16) compression NEF (RAW) + JPEG: Single photograph recorded in both NEF (RAW) and JPEG formats
ISO Sensitivity	ISO 100-3200 in steps of 1 EV. Can also be set to approx. 1 EV (ISO 6400 equivalent) above ISO 3200; auto ISO sensitivity control (ISO 100-3200, 100-800, 100-400) available	ISO 100-3200 in steps of 1 EV. Can also be set to approx. 1 EV (ISO 6400 equivalent) above ISO 3200; auto ISO sensitivity control (ISO 100-3200, 100-800, 100-400) available
Metering Method	Matrix Center-weighted: Meters 4.5 mm circle in center of frame Spot: Meters 2 mm circle centered on selected focus area	Matrix Center-weighted: Meters 4.5 mm circle in center of frame Spot: Meters 2 mm circle centered on selected focus area
Storage Media	SD (Secure Digital), SDHC, and SDXC memory cards	SD (Secure Digital), SDHC, and SDXC memory cards
Dimensions (W x H x D)	Approx. 4.2 x 2.4 x 1.2 in./106.0 x 61.0 x 29.8 mm, excluding projections	Approx. 4.4 x 3 x 1.7 in./113 x 76 x 43.5 mm, excluding projections; thickness of body (from mount to monitor) is 1.4 in./36 mm
Weight	Approx. 9.8 oz/277 g with battery and memory card but without body cap; approx. 8.3 oz/234 g (camera body only)	Approx. 13.5 oz/383 g with battery and memory card but without body cap; approx. 10.4 oz/294 g (camera body only)
Product Number	27528-White with 1 NIKKOR VR 10-30mm f/3.5-5.6 more colors and lens kits available	27504-Black with 1 NIKKOR VR 10-30mm f/3.5-5.6 more lens kits available